

# Opportunities in food processing

## *Setting up and running a small meat or fish processing enterprise*

Contributing authors

Barrie Axtell, Peter Fellows, Linus Gedi, Henry Lubin, Peggy Oti-Boateng  
and Rodah Zulu

Edited by  
Barrie Axtell and Peter Fellows  
Midway Technology Ltd.

Published by CTA  
2003

## *Technical Centre for Agricultural and Rural Cooperation (ACP-EU)*

---

The Technical Centre for Agricultural and Rural Cooperation (CTA) was established in 1983 under the Lomé Convention between the ACP (African, Caribbean and Pacific) Group of States and the European Union Member States. Since 2000, it has operated within the framework of the ACP-EC Cotonou Agreement.

CTA's tasks are to develop and provide services that improve access to information for agricultural and rural development, and to strengthen the capacity of ACP countries to produce, acquire, exchange and utilise information in this area. CTA's programmes are designed to: provide a wide range of information products and services and enhance awareness of relevant information sources; promote the integrated use of appropriate communication channels and intensify contacts and information exchange (particularly intra-ACP); and develop ACP capacity to generate and manage agricultural information and to formulate ICM strategies, including those relevant to science and technology. CTA's work incorporates new developments in methodologies and cross-cutting issues such as gender and social capital.

CTA, Postbus 380, 6700 AJ Wageningen, The Netherlands.

### **Citation:**

Axtell, B. and Fellows, P.J. (Eds).

*Setting up and running a small meat or fish processing enterprise.*

Opportunities in food processing series

Wageningen: ACP-EU Technical Centre for Agricultural and Rural Cooperation (CTA), 2003. 200 pages, ISBN 92-9081-275-3.

Copyright © 2004 by CTA, Wageningen, The Netherlands

All rights reserved. No part of this publication may be reproduced, stored in retrieval systems or transmitted in any form or by any means without prior permission of CTA. CTA encourages the non-commercial use of the material in this publication. Proper citation is requested.

ISBN 92-9081-275-3

Design and production : FAB S.A. Tel: 00 32 (0)2 340 14 20

# *Preface*

---

This handbook is the result of a collaborative effort by small business owners and advisers of small-scale food processors in ACP countries. The effort was supported by the ACP-EU Technical Centre for Agricultural and Rural Cooperation (CTA). The information contained in the handbook was gathered by researchers (see pp. 6-7), who surveyed local meat and fish processing enterprises and prepared reports that were then edited by Midway Consultants. The following specialists reviewed the draft publication and made valuable contributions to the text from the perspectives of their own countries:

- Mr D. Anang, Head of Animal Science, University of Science and Technology, Kumasi, Ghana
- Dr M. Dillon, Director, Grimsby Institute of Food and Fisheries, UK
- Mr D. Harcourt, Director FOODTEK, Council for Scientific and Industrial Research, Pretoria, South Africa
- Mr K. Matchell, Entrepreneur in Zimbabwe
- Dr. W. Ssali, Director, National Agricultural Research Association, Kampala, Uganda.

We hope this handbook will meet the needs of small-scale enterprises and the agencies that support them by providing technical and business information that was previously difficult to find, and by helping entrepreneurs to update and improve their businesses for the benefit of their consumers and, of course, their own profitability.

If you find this handbook useful, please take a few minutes to complete the feedback form at the end of the book. Your comments and suggestions will be used to improve the later books in this series.

The Editors

## *About the authors*

---

**Barrie Axtell** is a British food technologist and a director of Midway Technology. He has 30 years' experience working in Africa, Asia and Latin America. His particular interest centres on small-enterprise development, drying of fruits and vegetables and processing high value crops such as medicinal plants, spices and essential oils. He has co-authored 15 books on the role of appropriate technology in food processing.

**Dr Peter Fellows** is a consultant food technologist and a director of Midway Technology. He is Visiting Fellow in Food Technology at Oxford Brookes University in UK and has held the United Nations Educational, Scientific and Cultural Organization (UNESCO) Chair in Post-Harvest Technology at Makerere University, Uganda. He is an experienced author and has published 12 books and more than 30 articles on small-scale food processing. He has had practical experience in 20 countries of the food processing industry and the institutions that support it.

**Linus Gedi** has experience in agro-industry and particularly in post-harvest technology. Before becoming a consultant he was first a tutor and then head at Ilonga Agriculture Training Institute in Tanzania. For the past 17 years he has worked on various consultancy assignments, including planning primary crop production, handling, storage and marketing of food products, project appraisal and evaluations. His commodity expertise includes cotton, cashew, sisal, oilseeds, grains, fruits and vegetables, beverages, fish and meat products. Since 1996 he has worked at the United Nations Industrial Development Organization (UNIDO) as a National Expert in food technology, training women entrepreneurs, helping trainees set up enterprises and achieving quality production with a cleaner environment.

**Henry H. Lubin** has been Produce Chemist with the Ministry of Agriculture, Saint Lucia for 20 years, conducting investigations into the utilisation of agricultural produce. During this time he has assisted and advised agro-processors on product development, quality and food safety and he also conducts chemical analyses on foods and feeds. Mr. Lubin has served as the Director of the Saint Lucia Bureau of Standards for a number of years.

**Dr Peggy Oti-Boateng** of the Technology Consultancy Centre of Kwame Nkrumah University of Science and Technology (KNUST), Ghana, is a Senior Research Fellow and a member of the UNESCO Expert Group on Technology and Poverty Reduction. She has over 20 years' experience in research, development and transfer of food technologies for micro-, mini- and large-scale enterprises, with a particular interest in enterprise development for women. She has also developed nutritious and affordable weaning foods for children using locally available foods. She has written several books and journal articles on food processing and storage, nutrition and sustainable bio-energy for rural development.

**Dr Rodah Zulu** is a food technologist with several years' experience of food enterprise development in Zambia. In addition to research work at the Food Technology Research Unit, National Institute for Scientific and Industrial Research, Lusaka, she has undertaken consultancy work with the Food and Agriculture Organization of the United Nations (FAO) and the private sector. She has published a number of books and articles on the food resources of Zambia, and is currently working on the fortification of maize meal with large- and small-scale milling enterprises.

# *Acknowledgements*

---

This handbook is the result of a collaborative effort by the authors, researchers and small-scale industrialists. A large number of additional people gave freely of their time to assist in its preparation and publication. We would particularly like to record our thanks to Chantal Guiot and Alan Jackson at CTA for their support, encouragement and constructive ideas, to Matthew Whitton for the illustrations, to Green Ink, UK for copy-editing the text and to Ludovic Vangrootenbruel and Alexandre Verlinden (FAB S.A.) for the design and layout. Particular thanks must be given to the businessmen and women listed below, who so freely and openly gave their time and shared their experiences of operating meat and fish processing enterprises:

- Mrs Florence Adejoh, Flokan Products, PO Box CT 460, Cantonment, Accra, Ghana
- Mr Daniel Anang, Department of Animal Science, Meat Processing Unit, Kwame Nkrumah University of Science and Technology, Kumasi, Ghana
- Mrs Charlotte Ayayee, Joecarl Enterprise Ltd., PO Box BT 398, Tema, Ghana
- Mr Ben Kridge, Buccaneer Meat Processing, PO Box 35032, Lusaka, Zambia
- Mr Alfred Malijani, PO Box 32045, Lusaka, Zambia
- Mrs Janet Morio Mkonyi, Shesi Holdings, PO Box 5733, Ukonga, Dar es Salaam, Tanzania
- Mr Gregory Mongroo, Grew (1989) Ltd., PO Box 1050, Castries, Saint Lucia
- Mr Damascus Tiradery, Department of Animal Science, Meat Processing Unit, Kwame Nkrumah University of Science and Technology, Kumasi, Ghana
- Mrs Lydia Quarcoo, PO Box 0887, Osu, Accra, Ghana
- Ms Dora Hanna and Ms Veronica Quaye, Dora and Sister, Chorkor Fish Processing Village, Chorkor, Accra, Ghana
- Mr Markus Weltin, Mojuru Investments Ltd., PO Box 36518, Lusaka, Zambia

In addition we would like to thank the following for their advice:

- Ms Jane Duddle, Microbiology Department, Waitrose Foods, Bracknell, RG12 8YA, UK
- Mr Neil Hudson, The Meat and Livestock Commission, Milton Keynes, MK6 1AX, UK
- Mr Paul Robinson and Mr Chris Bultch of Country Fresh Meats, Daventry, NN11 5PG, UK

Barrie Axtell  
Peter Fellows





# *Contents*

---

	Page
<b>Preface</b>	<b>5</b>
<b>About the authors</b>	<b>6</b>
<b>Acknowledgements</b>	<b>8</b>
<b>How to use this book</b>	<b>15</b>
<b>1 Introduction</b>	<b>17</b>
Tips for success	17
<b>2 Markets and marketing</b>	<b>19</b>
Tips for success	19
2.1 Feasibility study and business plan	19
2.2 Selecting suitable products	21
2.3 Customer and consumer care	23
2.4 Developing a marketing and selling strategy	26
2.5 Developing new products	37
Summary of the chapter	44
Entrepreneur's checklist	45
Readers' notes	46
<b>3 Planning production</b>	<b>47</b>
Tips for success	47
3.1 Setting up a processing unit	48
3.2 Buying raw materials, ingredients and equipment	59
3.3 Keeping records	70
3.4 Recruiting and managing staff	71
Summary of the chapter	74
Entrepreneur's checklist	75
Readers' notes	76

<b>4 Meat processing</b>	<b>77</b>
Tips for success	77
4.1 Meat, the prime raw material	79
4.2 The processing plant	80
4.3 Producing fresh and cured sausages	83
4.4 Producing hamburgers	105
4.5 Producing pâtés and terrines	106
4.6 Producing bacon	109
4.7 Producing hams	113
4.8 Producing dried meat	116
4.9 Miscellaneous meat products	119
4.10 Packaging meat products	119
Summary of the chapter	121
Entrepreneur’s checklist	122
Readers’ notes	123
<b>5 Fish processing</b>	<b>125</b>
Tips for success	125
5.1 Fish, the prime raw material	125
5.2 The processing facility, services and equipment	128
5.3 Producing dried, cured and smoked fish	132
5.4 Producing minced fish products	141
5.5 Producing fish-based sauces	143
5.6 Packaging fish products	145
Summary of the chapter	146
Entrepreneur’s checklist	147
Readers’ notes	148

<b>6 Quality assurance and legislation</b>	<b>149</b>
Tips for success	149
6.1 Risk analysis from production to consumer	149
6.2 Quality of raw materials and packaging	152
6.3 Plant inspection and routine cleaning	155
6.4 Process control	158
6.5 Quality assurance methods and records	159
6.6 Summary of legislation	163
6.7 Labelling legislation	168
6.8 Environmental considerations	169
Summary of the chapter	171
Entrepreneur's checklist	172
Readers' notes	173
<b>7 Financial management</b>	<b>175</b>
Tips for success	175
7.1 Start-up costs	175
7.2 Production costs	176
7.3 Managing finances	177
Summary of the chapter	182
Entrepreneur's checklist	183
Readers' notes	184
<b>Appendix I Institutions offering support to small-scale enterprises</b>	<b>185</b>
<b>Appendix II Further reading and bibliography</b>	<b>189</b>
<b>Glossary and acronyms</b>	<b>193</b>
<b>Index</b>	<b>196</b>
<b>Readers' questionnaire</b>	<b>199</b>



# *How to use this book*

---

This book is intended to be a practical guide to help improve the operation of small-scale meat or fish processing enterprises – with each different aspect covered in separate chapters. It should be read alongside the first publication in this series: *Setting up and running a small food business*, which gives further information on wider aspects of food processing.

Whether you want to start a new business or simply want to achieve an improvement in your existing operations, we suggest that you read both books and make notes on what you need to do in the space provided at the end of each chapter in the **READERS' NOTES**.

However, operating a small business is a full-time job and you may not have the time at the moment to read the whole book. If an area of your operation is posing a particular problem, we recommend that you first read the relevant chapters in both books and act on the recommendations. There are a number of ways in which you can use this book to help you grasp the main points in each subject area:

First, you can look at the **TIPS FOR SUCCESS** at the start of each chapter. These provide ideas for improving a particular aspect of your business.

Next, important points and ideas are highlighted in the text using a bar  symbol. These points indicate where common mistakes are made, or where you may need to consider something that you had not thought about before.

There is a **SUMMARY** of the most important aspects at the end of each chapter.

Finally, at the end of each chapter there is an **ENTREPRENEUR'S CHECKLIST** that you can use to tick the main actions you need to take to improve that aspect of your business.



Meat and fish have been preserved by simple methods, principally drying, salting and smoking, in African, Caribbean and Pacific (ACP) countries for thousands of years. The main purpose of processing is to preserve these highly perishable foods, which quickly putrefy in hot climates. Dried and smoked products provide greater local food security and can be traded in other areas. Traditional fish processing centres are found by lakes, beaches and rivers.

Traditional meat and fish products vary from region to region and are influenced by the local climatic conditions. Dried meat, for example, is mainly found in the arid areas of Southern Africa where sun and wind are all that are needed for producing dried meat or '*biltong*'. In more humid areas, such as West Africa and the Caribbean, meat and fish have to be smoked and dried over a fire.

In recent years, new non-traditional meat and fish products have entered the markets of ACP countries, principally to meet the demands of expatriates, tourists and a growing affluent population who have been exposed to such foods through travel. It is interesting to note that all the non-traditional manufacturing enterprises surveyed during preparation of this book have been set up in fairly recent years.

## Tips for success

- ✓ Set up a reliable cold chain from purchase of raw materials, through production to consumption; this is vital to protect the consumer and will reduce losses and waste
- ✓ A meat processor without back-up power is doomed
- ✓ Maintaining product quality is vital for success
- ✓ Good quality products can only be made from good quality raw materials
- ✓ Workers who are well treated and respected are one of your key assets
- ✓ Acquire all the knowledge you can about business and your products
- ✓ Understand local legislation and be open with legal bodies (e.g. public health).

Some of these non-traditional products, such as bacon and low moisture air-dried sausages, have been made in Europe for centuries using simple methods. The transfer of production from cold northern countries to tropical ACP countries requires adaptation of production and storage methods, mainly through the use of refrigeration. The safe manufacture of other products, such as burgers, fresh sausages and lightly smoked fish, demands a reliable cold chain even in cold countries. In tropical countries this is doubly important and a reliable electricity supply throughout the whole food chain is vital if public health is not to be put at risk.

This book covers products that can be manufactured by small- and medium-scale enterprises. Products such as canned meat and fish and pre-prepared chilled or frozen meals are not included, as the technologies are expensive and demand production on a very large scale. Secondary products such as sausage rolls, meat and fish pies and pizzas are only briefly covered here, but are described in greater detail in *Setting up and running a small flour mill or bakery* – a companion book in this series.

This book also describes the aspects of marketing, quality assurance, product development, legislation and finance that are important in meat and fish processing. Wider aspects of these areas are covered in greater detail in Volume 1 of this series: *Setting up and running a small food business*. The case studies provide practical examples showing how others have built successful businesses in meat and fish processing.



## *2.1 Feasibility study and business plan*

---

Most small businesses start with an idea which, combined with an entrepreneurial spirit, can be turned into reality. Undertaking a feasibility study and preparing a business plan are the essential first steps for business success and are of vital importance to new enterprises and those considering expansion or diversification. Simply having a 'good idea' is not enough.

A feasibility study asks questions and provides the information needed to write a business plan. The aims of a feasibility study (see Chapter 3, section 3.1 in Volume 1) are to:

- focus the mind on the many details of bringing a business idea into reality
- identify potential problem areas and the need for training, external help or finance
- provide well thought out information to support requests for assistance from family, banks or shareholders.

## Tips for success

- ✓ Failing to plan is planning to fail
- ✓ Only supply to trusted customers who will store and control your products correctly
- ✓ Advise new customers on product storage and control
- ✓ Remember: it is the final consumer not the customer/shopkeeper who decides whether or not to buy your product
- ✓ Use promotional tools to help your customers sell your products
- ✓ Build good relationships and trust with your customers
- ✓ Only supply quantities that can be sold within their shelf life
- ✓ Keep up with changing customer preferences by introducing new flavours
- ✓ Don't compromise on quality
- ✓ Ask for, and record, feedback from customers and consumers
- ✓ Check the competition regularly and always keep ahead
- ✓ Use the best packaging and promotional materials you can afford
- ✓ When carefully planned, new product development can increase your profits
- ✓ Target different market sectors to satisfy different spending abilities
- ✓ **Finally:** Read Chapter 3, section 4.7 and Chapter 9 in Volume 1: *Setting up and running a small food business.*

### Case study 2.1 Getting started

Mr R. owns an enterprise in St. Lucia producing hams, sausages, hamburgers and smoked meat. 'The business was started in the 1980s by my brother, a qualified meat technologist, and a feasibility study was carried out with help from the Caribbean Development Bank,' he explains. Despite strong technical skills, the brother lacked marketing knowledge and the business got into problems and closed. But Mr R. was convinced that a market existed for high quality meat products, and in 1989 he bought the factory from the liquidator. 'I used my own resources and also obtained a loan from a commercial bank. I paid close attention to my business plan and within three months we had started production. I review my business and marketing plan every year and we have now run a profitable business for over ten years.'

The amount of detail required in the business plan will be related to the size and complexity of the planned business venture and the need for financial support from formal institutions such as banks. However, even a micro-enterprise, funded by family resources, will benefit greatly from writing a plan and highlighting areas that need investigation. The preparation of a business plan is discussed in some detail in Volume 1 (Appendix I). In summary the plan should include:

1. Background: name and contact details of owner and any relevant experience
2. Planned product range
3. Market analysis: prospective purchasers, estimated demands, competition, marketing strategies
4. Production unit: will it be constructed or rented? Plan of proposed layout and services available or required. Waste disposal. Any negative environmental impact?
5. Equipment required together with costs and availability. Vehicle requirements
6. Raw materials, ingredients and packaging, including cost and availability
7. Staffing costs and training needs
8. Local sources of advice and specialist services such as analysis
9. Production plan to satisfy identified demand

10. Distribution plan. How will this be achieved for products that require chilled transport? How will a safe cold chain be maintained to the point of sale?
11. Financial plan showing total capital investment, production, distribution and marketing costs and finance required. A cash flow projection will be required together with a break-even analysis and estimates of profitability
12. Analysis of unit costs for each product to identify those that are most profitable
13. Analysis of any legal requirements and how they will be met.

It is strongly recommended that the reader should refer to relevant literature listed in Appendix II of Volume 1.

*Failing to plan is planning to fail.*

And a word of warning: business people in Uganda advised entrepreneurs to choose their consultants with care, as there have been many instances when ideas set out in feasibility studies have been stolen.

## *2.2 Selecting suitable products*

---

While large traditional markets exist for some processed meat and fish products, for example dried fish and meat, the majority of the products described in this book are non-traditional. Over the last 20 years we have witnessed a globalisation of food and eating habits due to a number of factors:

- increasingly affordable travel resulting in higher levels of tourism and business
- access to information via television, advertising and, more recently, the internet
- a growing middle-class with the purchasing power to buy non-traditional products
- increasingly free markets for imports
- social changes: both men and women work and so require meals that are convenient and easy to prepare

- increasing urbanisation with workers requiring cheap, fast, street foods such as hamburgers or pizza
- a growing number of immigrant communities introducing new eating habits.

The market for non-traditional foods is constantly changing and can provide great opportunities for entrepreneurs. Twenty years ago, for example, hamburgers and hotdogs were not commonly available in many ACP countries. Now they provide quick street food in most towns, generating a huge market for ground meat and sausages. More recently, pizzas have appeared all over the world, generating markets for sliced ham, ground meat, grated cheese and salami.

Enterprises need to select their product range with great care and based on factors such as:

- existing demands and trends in consumer requirements
- having the necessary knowledge and skills to establish a processing unit with all the controls needed to ensure food safety
- access to a reliable cold chain. If not, what steps can the enterprise take to assure consumer safety?
- availability of good quality raw materials, ingredients, packaging and equipment.

The main types of meat and fish products produced by small- and medium-scale enterprises in ACP countries are shown in Table 2.1. Chapters 4 and 5 provide information on their production.

<b>Fish products</b>	<b>Meat products</b>
Dried fish	Fresh sausages
Smoked fish	Hamburgers
Dried fish and shrimp powder	Pâtés
Fermented fish sauces	Bacon
Other sauces containing fish and shrimp	Cooked hams
Minced fish products: cakes, fingers	Dried or smoked sausages e.g. salami
Fried fish	Dried meat
Fish pâtés	Baked meat products: pies, pizzas
	Kebabs

Table 2.1 Processed meat and fish products

## 2.3 Customer and consumer care

---

The surveys carried out in the preparation of this book stress that the crucial factors in retaining customers are:

- developing good relationships
- providing quality products on time and in appropriate quantities
- giving credit terms equal to those of the competition
- providing support in areas such as stock control, storage and display.

A high percentage of enterprises surveyed had systems in place to monitor the way products were stored and displayed in shops and supermarkets. This included cold chain awareness through checking the temperatures in freezers and chilled displays. A very simple system for retail stock control is the use of self-adhesive stickers, with red for Monday, blue for Tuesday etc. Any product with a seven-day shelf life and with a red label would therefore not be fit for sale by the following Monday.

The provision of credit is widely seen as a way to develop and improve relationships with customers. In general, extended credit terms are only given to established customers and initial sales are on a cash basis (Case study 2.2).

### **Case study 2.2 Cash or credit?**

'We know our customers well and generally supply on a cash basis. However, from our long-term relationships we know when they have a cash flow problem and we are also familiar with the local bureaucratic systems, so we can be flexible and give a few days or weeks of credit when necessary.'

All meat and fish products should be clearly labelled to inform the buyer how to use the food safely. The following features should be clearly stated:

- use-by date
- required storage conditions
- de-frosting times (for frozen food)
- cooking times, either from frozen or after de-frosting.

The greatest public health risk from meat and fish products occurs after sale to the final consumer. Risk analysis in the supply chain, from manufacture to

consumption, is discussed in greater detail in section 6.1. For example, buyers may purchase frozen or chilled foods and place them in a hot car for several hours or fail to keep them refrigerated at the correct temperature in the home. Manufacturers should make every effort to ensure that the final consumer understands how to manage the food after purchase. Failure on the part of the consumer to maintain correct storage conditions can result in complaints that will damage the name and reputation of the enterprise making the product.

*Each dissatisfied consumer may talk to a dozen or more people and cause great damage to the image of your business, even though the consumer was in fact at fault.*

### *Maintenance of a cold chain*

Many non-traditional meat and fish products were developed in cool climates. Micro-organisms multiply much faster in the high ambient temperatures of most ACP countries, and a reliable cold chain<sup>1</sup> is essential to maintain food safety. Food must be kept cool from production right through to the final consumer, but in many ACP countries this chain is far from reliable. Electricity cuts are common, ambient temperatures and humidity are high, and the final consumer has, in many cases, not been sufficiently informed regarding the safe storage and use of the food. Producers have considerable responsibility to work with their customers, such as shops and hotels, to ensure foods reach the final consumer in a fit condition.

It should be explained to customers that correct storage and handling of the food is essential if consumers are to be protected from the possibility of food poisoning. Typical advice includes:

- check and maintain the correct temperatures of refrigerators and freezers
- never place raw meat or vegetables in the same display unit as processed meats
- use disposable plastic gloves or squares of plastic to handle meat and fish products
- check stock daily against their sell-by dates

---

<sup>1</sup> *A cold chain describes a system of transporting, storing and selling foods under agreed cool conditions, for example chilled or frozen.*

- make sure that the doors of refrigerators and freezers close automatically and that they are kept closed
- never allow staff with septic cuts, colds or other illnesses to handle the foods.

It is also very important to inform the final consumer how to store and use the food. An example of a label giving advice to consumers is shown in Fig. 2.1.

**Top grade beef burgers**

**IMPORTANT**

This product must be kept frozen and should never be re-frozen after thawing. Allow to thaw for a minimum of four hours in a refrigerator before cooking. Make sure the burgers are fully cooked and piping hot before eating.

Fig. 2.1 Example of a consumer advice label

### *Contracts and agreements with customers*

Having a formal contract with customers can be very useful to both parties. Such a contract might contain the following elements:

- an agreement on the quantity and frequency of orders
- an agreement on quality, price and any discounts available or terms of payment
- an agreement relating to dealing with complaints or returns.

Formal agreements benefit both the producer and the customer. They make for better production planning and provide greater security regarding monthly sales. The shop or hotel will know that goods will always be in stock at the required level. The agreement should be clear and simple and should avoid legal language, which may appear threatening. A specimen agreement is shown in Fig. 2.2.

**Supply Agreement between:**

Happy Pork Products, PO Box 233, St Lucia  
and  
Sunset Hotel, PO Box 266, St Lucia

**Happy Pork Ltd** agrees to supply  
25 kg of 60% pork sausages @ \$2/kg  
10 kg of hot dog sausages @ \$1.75/kg  
10 kg sliced smoked bacon @ \$3/kg

on the first Monday of each month.

The goods will be delivered in a refrigerated van. The product will be clearly coded with a batch number and use-by date.

**Happy Pork Ltd** will also:

1. Check the temperatures in the hotel refrigerator on each visit.
2. Visit the hotel in the event of any complaints and, if the complaint is justified, replace the goods.

**Sunset Hotel** agrees to purchase the goods listed above until this agreement is withdrawn, having provided one month's notice. We agree to deliver payment within 15 days.

Signed & dated

Signed & dated

Happy Pork Ltd

Sunset Hotel

Fig. 2.2 Example of a supply contract

## *2.4 Developing a marketing and selling strategy*

---

Prior to establishing an enterprise it is very important to undertake a survey of the potential market for the product. Advice on designing such a survey is provided in detail in Chapter 3 of Volume 1. In summary the survey needs to consider:

- consumer preference, for example preferred flavour, price, pack size and presentation
- requirements of shops, hotels or institutions and preferences related to areas such as order times, trading terms, margins and advice and support available from the manufacturer
- existing and potential competition, both from local processors and from imported goods.

In the modern, rapidly changing world a market study should not be considered as static. New businesses may appear that will compete for market



share. New food flavours may become popular, for example, 'spicy Asian' or 'smoky Mexican'. The successful entrepreneur will need to be constantly aware of such market changes, will be prepared to undertake frequent studies, and will aim to satisfy the market by developing new products (see section 2.5). Some of the most successful enterprises surveyed in the preparation of this book continue to supply traditional products to traditional markets, while at the same time adapting to new market trends and improved technologies (e.g. Case study 2.3).

Five main markets or segments exist for processed meat and fish:

- traditional local markets, where dried, salted and smoked meat and fish are sold through market stalls and small shops to lower income consumers. Also, bulk sales to middlemen who then sell in other towns or export the foods to nearby countries (Case study 2.3)
- institutional markets, for example the army, police, schools and large companies can offer opportunities for bulk sales on a contract basis (Case study 2.4)
- low- to medium-cost products such as fried fish, hot dog sausages, kebabs, pizzas and hamburgers are sold in fast-food outlets and on the street
- non-traditional markets include higher income consumers, hotels, expatriates, tourists and companies. These customers demand high value, high quality non-traditional foods such as sausages, bacon, pâtés, hams and high quality smoked fish
- export markets, both regional and international. Large export markets exist for frozen fish in some ACP countries, but tend to be met by larger companies. East Africa, for example, now exports 100,000 tonnes of fish per annum and it is reported that the product range will soon be expanded to include fish sausages and fish burgers. However, smaller enterprises can access regional and international markets for processed fish (Case studies 2.3 and 2.4). Opportunities for exporting processed meat are more limited due to concerns over the transfer of animal diseases. Many countries apply strict control over the importation of both raw and processed meat.

### **Case study 2.3 Satisfying traditional and new markets**

Two Ghanaian sisters, whose grandmother and mother produced dried smoked fish, are continuing the family tradition. Their father is a fisherman, and in 1987 he gave them his catch, which was worth about US\$50. The sisters borrowed their mother's smoker and some firewood and set to work. They managed to sell their smoked fish for \$100. They now own five smokers and continue to sell their fish in local markets and to middlemen from nearby countries. But they have also taken advantage of new market opportunities, selling to newly established producers of spicy fish-based sauces. These companies provide a reliable market but require large quantities of smoked fish. When catches are larger, the sisters join with other fish smokers to sell to these buyers. The company does not advertise but, along with other fish processors, the sisters have started to use improved fish smoking methods and have received publicity from the Government of Ghana and the Food and Agriculture Organization of the United Nations (FAO).

### **Case study 2.4 Exporting traditional fish products**

In the 1980s Mrs J. invested US\$40 in a business making a traditional Ghanaian fish-and-shrimp-based pepper sauce, '*shito*', in her home. Her husband, the captain of a merchant ship, always took *shito* with him on his voyages and, when in the Netherlands, he invited some expatriate Ghanaians on board for lunch. They were so taken with the sauce that they asked if they could buy some. More orders followed and in 1990 Mrs J. decided to scale up her production. Over a six-year period the business has grown from an output of 25 kg to 2 tonnes per week. She sells her sauce to a range of buyers all over Ghana, including institutional markets like the army and police, and exports to Belgium, Germany, Italy and the Netherlands. She regularly carries out market surveys and has found that her sauce is finding its way to nearby countries such as Togo and Nigeria. She regularly buys bottles of sauce made by competitors and makes sure that her brand is always the best. Through identifying market opportunities, she has been able to diversify into other products, including dry shrimp and fish powder.

Market research showed that her shrimp and fish powder was preferred by consumers as it contained more shrimp and less salt than other brands. This, and some of her other products, are now being bought by Lever Brothers, a large international company. They recently had very good news as Lever decided to base all its packaging equipment in her factory. They will then contract package for Lever which, in turn, will market the products in Ghana and overseas.

The five broad market segments can be sub-divided into smaller segments, each comprising identifiable consumers with different demands and different levels of spending (Table 2.2). It is important for business owners to recognise different market segments and to make sure their products meet the needs of both the customer and the consumer.

A useful tool for understanding how to target a particular customer is known as the 'marketing mix'. This involves considering four aspects of the market: Product, Price, Place, and Promotion (the four Ps), as shown in Fig. 2.3. Businesses should prepare a marketing mix diagram for each product to help them consider all aspects of production and understand the strengths and weaknesses of the product and the marketing strategy.

<b>Product</b>	<b>Price</b>
High quality assured	Reflects buying power of poorer customers
Well, but not over packaged	Compares well with competition
Does not require refrigeration	Discounts to larger buyers
Label gives weight and contact point	
Always in stock	
Range of pack sizes produced	
<b>Place</b>	<b>Promotion</b>
Local markets and small shops used by poorer people	Leaflets posted in market stalls
Opening hours fit with customers' habits	Cooked samples demonstrated at fairs
Special display space agreed with stalls	Any sub-standard stock replaced
Bulk sales delivered to large institutional buyers	

Fig. 2.3 Four Ps marketing mix for dried smoked fish

<b>Market type</b>	<b>Segments</b>	<b>Typical consumer</b>
Domestic	Town and village markets Small local shops Supermarkets Street vendors Delicatessens	Poorer people Poor and middle-class Middle-class and rich Poor and middle-class Rich, tourists, expatriates
Commercial	Low cost restaurants Expensive restaurants Fast-food establishments Small hotels International hotels Clubs Kiosks Airports	Middle-class Rich, tourists, expatriates Middle-class, young Middle-class Rich, tourists Rich Poor and middle-class Rich, tourists
Institutional	Large companies Armed forces Hospitals Prisons Schools	All classes of workers requiring nutritious low cost basic foods
Regional and international	Traders Import agencies Large companies Institutions	Business people

Table 2.2 Main market segments and consumers for fish and meat products

The enterprises surveyed in the preparation of this book have responded to different market segment opportunities (see Case studies 2.5 and 2.6 and Table 2.3). It is interesting to note the importance of the institutional sector (police, armed forces and schools) to these small- and medium-scale enterprises. It should be noted, however, that some institutions (particularly government) may be poor payers, and their slow response may adversely affect cash flow.

### Case study 2.5 Satisfying customers' needs

A young woman entrepreneur started a small business selling fried fish at a busy bus station in Accra, Ghana. People began to ask her for *kenkey* (traditional maize dough) to eat with the fish, so she decided to diversify to meet this clear market demand. Over time she obtained important contracts with institutions such as the army, police and schools to supply fried fish and *kenkey* and she now employs 11 staff. She gives free samples at fairs and events to promote the products and was featured on local TV, resulting in four major orders. Her tips to those entering business include:

- get feedback from customers
- set your sights high, but always maintain the best quality
- target different market segments to meet the consumers' needs and so spread your own risks.

### Case study 2.6 Capitalising on an opportunity

Mrs O. is a qualified and experienced caterer who worked for many years at a Ghanaian university. She had always wanted to set up her own business and in 1998, when a long established Chinese restaurant came on the market, she and her husband were able to raise the money to buy it. She carried out a market survey in the local town, which revealed a demand for fast-foods that was not being met. She thus set about developing pizzas, hamburgers, kebabs and other snack foods. The business became so profitable that she was able to build her own brick pizzeria with 'summer huts' in which customers could eat. She now has 41 staff including five professional chefs. In addition to her restaurant 'Chopsticks', which attracts many middle-class families, she provides the food for outside functions and social events. Her business has created a market for producers of good quality ground meat, kebab meat, shrimps and fish. Mrs O. demonstrates how new markets can be created which, in turn, can provide opportunities for local meat and fish producers and processors. Her advice is: 'Start small, get experience and expand. Do not think of profit first but always aspire to give good service and quality food'.

Company	Products	Shops	Supermarkets	Catering industry	Hotels	Institutions	Street markets	Export
Tanzania	Beef sausages	+	+					
St Lucia	Ham, bacon, sausages, smoked chicken		+		+			
Ghana	Fried fish, <i>kenkey</i>	+	+	+	+	+	+	+
Ghana	Powdered fish and shrimp, fish and shrimp pepper sauce	+	+	+	+	+		+
Ghana	Fish pepper sauce	+	+	+	+	+		+
Ghana	Dried smoked fish				+	+		
Ghana	Wide range of meat products	+	+	+	+	+		
Zambia	Sausages, bacon, ham and <i>biltong</i>	+	+	+				
Zambia	Sausages, <i>biltong</i> and hams		+					

Table 2.3 Market segments served by enterprises surveyed

All enterprises surveyed were keenly aware of the need to expand the penetration of their product range, often against competition from large importers and supermarkets that produced, for example, ground meat products in-house. Developing the market should lead to:

- increased sales through a wider range of outlets
- increased profits
- increased awareness among the buying public of the company and its brand so that it is instantly recognised against the competition.

Market development can be achieved in various ways by different pricing policies, presentations, advertising, promotional activities and sales techniques. The use of improved packaging can make a major impact on a buyer's perception of the food and the company. As packaging materials become more readily available, producers should make sure they have contacts with packaging importers and are aware of new materials.

## Promoting products

All products need promotion to make customers and consumers aware of their presence and to stress the benefits of buying one brand over another.

Such promotion can be through:

- radio (reaches a wide audience)
- television (expensive, but reaches up-market consumers)
- posters and leaflets
- newspapers and trade journals
- giving away samples in shops and at local fairs and exhibitions
- personal approaches to possible buyers
- word of mouth customer recommendations.

All the above were used in one way or another by the enterprises surveyed but personal contacts and providing samples at fairs were particularly popular (Case study 2.7). It is very important that advertisements and other promotional materials are of high quality, appear professional, catch the eye and rapidly convey a message. In most cases an advertisement will need to inform a potential buyer in one or two seconds, for example from a passing bus or car. The design must be simple, uncluttered, direct and related to the way it will be used. For example, the print size in a poster must be large enough to be read at a distance.

Many meat and fish products have a limited niche market and their promotion should be targeted at more affluent consumers. Widespread advertising with low-cost posters, for example, is unlikely to have great impact.

The promotion needs to focus on these consumers, for example:

- maintain a presence where they will be most likely to see promotional material: in clubs, hotels, bars, restaurants, at events and shows and in magazines and newspapers
- make sure the message and image will attract them, emphasising good quality, safety, attractive presentation etc.

### Case study 2.7 Product promotion

'We do not advertise because it is too expensive – but we do participate in trade fairs and exhibitions, we give away free samples and we sometimes give TV interviews.'

'We use both TV and radio to advertise our products. We also supply T-shirts and make charitable donations, giving free smoked fish to homes for the elderly, for example.'

'As a university production unit we get free publicity from FAO, the local papers and the Ghana Broadcasting Corporation. We also promote our products at trade fairs and exhibitions.'

'I informally promote my business of fried fish and *kenkey* by giving free samples to church organisations, hospitals and children's homes. I was lucky to get free promotion on the radio through the Ghana National Board for Small-scale Industry. This had a very positive impact on my sales.'

'I advertise my fish-based pepper sauce at trade fairs and in my hotel through leaflets and flyers.'

'We promote our dried fish and shrimp powder through brochures, newspapers, TV and trade fairs. We also get indirect advertising through the large international company Lever Brothers who use their brand name to promote our products.'

Labels also provide producers with the opportunity to recommend new ways of using the product, which in turn can result in increased sales. Examples of recipes could be attached to the product (see Fig. 2.4). Such recipes can change a basic product from something that is quickly fried in a pan to a meal that could be used for entertaining. Such simple recipes can give consumers new ideas and promote sales. Another idea is to ask a newspaper to feature the recipe, together with an advertisement and perhaps a token entitling the reader to a discount in a specified supermarket.



### A tasty recipe for our herb sausages

Thoroughly de-frost the sausages and fry in a little oil until brown.

Remove the sausages and add chopped onion, garlic and a little chilli to the oil, cook until soft.

Add one spoon of flour, some water, or for a richer sauce add a little red wine or dark beer and simmer for five minutes.

Pour sauce over sausages and cook in the oven for 30 minutes.

Serve with vegetables.

Fig. 2.4 Promotional recipe

The way that the product is packaged influences the buyers' image of both the product and the producer. Some products are simply bundled together in a plastic bag with a small black and white label. This gives an image of low quality, but can also attract poorer consumers (see Case study 2.8). The same product laid in line on a fibre tray, over-wrapped with film and with an attractive coloured label stating, for example, 'butchers choice' or 'prime cut' presents a totally different image. An example is shown in Fig. 2.5.



Fig. 2.5 Two ways of presenting the same product  
(Photo: B. Axtell)

As described earlier, the market for processed meat and fish can be divided into five general sectors catering to people of widely different socio-economic groups. Different marketing strategies are needed to promote and sell products to different types of buyer. Case study 2.8 illustrates how a business targeted at the poorest market differentiated its products from the competition, while Case study 2.9 shows how a different business promotes its high value products to a more affluent market segment. Choosing to sell to a small, well defined market (e.g. safari lodges) is known as 'niche' marketing. Such an approach is logical if the enterprise has a comparatively small number of large customers such as hotels. It is not the final consumer that needs to be targeted by promotion; they are, after all, captive consumers of the hotel. The quality, reliability of supply and relationship between the hotel and the producer is the key in such situations.

### **Case study 2.8 Differentiating the product**

A business in West Africa produces dried fish for sale in open town and village markets and small shops. The buyers are poorer people whose main concern is price and value for money. Quality is generally only a secondary concern, but they would be likely to take this into account if the price differential was small. Dried fish are normally sold loose from baskets and are often covered with flies and unprotected from dust and pollution. The producers decided to package their fish in low cost plastic bags with a label stating the brand name, the weight and the producer's address. At the same time they printed some cheap posters for display in and around the markets. Packaging the fish had several benefits:

- buyers could see that the product was of better quality and more hygienic
- customers knew that they would buy the expected weight and not be cheated by a market trader
- the trader saved time in weighing out the fish
- the business began to develop an instantly recognisable image in the market.

### Case study 2.9 Promoting to a niche market

A meat processing business in Zambia does not use advertising because its high quality sausages, bacon and ham have a limited niche market. It promotes its products by giving free samples to potential customers and consumers. 'A relationship of trust is vital,' says the proprietor. 'We develop niche markets with good relationships that cannot easily be broken and all our customers are treated alike whether big or small. We concentrate on sales to catering industries because the packaging costs are less. Our main customers are hotels, safari lodges and takeaways.

I emphasise to my customers that they should pay for the quality of the food that is eaten, not the packaging that is thrown in the bin.' Customers are offered factory tours, help with stock control and products are monitored at the point of sale. The owner also suggests that frequent small orders, rather than fewer large ones, can help to maintain quality and avoid complaints.

## *2.5 Developing new products*

---

As described in section 2.2, the range of foods on sale in ACP countries has changed considerably during the past 20 years. Rapid changes in distribution systems, including air-freight and in particular the growth of cold chains, has permitted the transport of foods that would previously have been impossible. Refrigeration is now available in most middle-class homes in ACP countries and this has allowed new food preparation and eating habits to develop. New tourist and business consumers provide processors with the opportunity to introduce different and niche products with high margins, which have the potential to increase turnover and profit.

Small- and medium-scale meat and fish processors need to be aware of market opportunities that exist through the development of new products. Consumers need to be made aware of new products entering the market, through suitable methods of promotion (section 2.4). Once they have been tempted to try it, they need to remember the brand name and image. The competition may soon copy the food but the business that enters the market first will retain a significant advantage.

Producers of non-traditional meat and fish products have far greater scope to introduce new products than do producers of traditionally cured meat and fish. However, opportunities exist for both groups. For example:

- a traditional producer of *biltong* sold for cooking purposes might, through the use of spices and simple packaging, be able to diversify and sell the product to kiosks and bars as a snack food
- producers of dried smoked fish might be able to capture customers prepared to pay a little more for a well presented product packed in polythene bags rather than sold loose from baskets (Case study 2.8).

Developing new products costs time and money and many new products do not succeed. Case study 2.10 demonstrates how entrepreneurs may have different attitudes to the risks associated with new products.

### **Case study 2.10 The risk of new product development**

An enterprise producing a wide range of fresh and processed meat products in Ghana has a series of standard recipes that were supplied by a visiting expert ten years ago. Product development is related to consumer demands and the recipes are now varied every six months. Following consumer surveys to assess preferences, they have developed new formulations for sausages and frankfurters. Some people, for example, like more beef than pork while others prefer more pork. Spicy seasonings and cures are also used as required.

The owner of a plant producing a range of processed meat products in the Caribbean has a totally different approach. 'We have standard recipes obtained from our suppliers of meat and spices. They are fully tested and documented and we rarely change them.'

A meat processing company in Zambia has a similar cautious attitude: 'We got our recipes from the original German owner and we don't change them.'

Inexperienced entrepreneurs are advised not to develop their own new products as the public health risks are, in many cases, too high. Mistakes, for example in using too little salt in a brine, too short a cooking time or incorrect levels of preservatives, can result in severe, or even fatal, food

poisoning, and the enterprise could be closed down. As a general rule, it is recommended that new products should be based on the many hundreds of formulations and recipes to be found in specialist books on the subject. Readers are referred to references in the bibliography. Most of these recipes have been developed and adapted over time and tried and tested in the marketplace. However, it should always be kept in mind that many formulations have been developed in climates very different from the tropical conditions found in many ACP countries.

Enterprise owners should plan the development of a new product idea in a formal way and consider the steps involved in detail. Areas that need to be considered include the availability and cost of special ingredients and packaging, the need for new equipment and any specialist inputs that may have to be bought in. The stages that require planning are:

1. Identifying the product idea. In many cases this will arise through seeing a new product in the market or finding a formulation in a book
2. If copying a product, have the original analysed to determine its approximate composition (e.g. salt, moisture, meat and fat content). Identify sources of any special ingredients, packaging or equipment that will be needed together with their costs
3. Carry out a simple product costing to check that you will be able to produce the product at an acceptable price (similar to your competitors)
4. Obtain all ingredients and prepare small trial batches. Check that products meet consumer preferences and, if not, adapt and repeat the process

*This process will probably have to be repeated several times. Keep exact records of the quantity of all ingredients used.*

5. As necessary, have the product tested for microbiological safety and carry out shelf life studies
6. Carry out both customer and consumer preference and acceptability trials
7. Decide whether or not to launch the product.

*A common error when adding flavourings and seasonings to a new product is to 'add just a little more pepper and a pinch more salt' until the correct flavour is obtained. Adding ingredients in this way means that you will find it impossible to repeat the recipe. Keep all seasonings in labelled bottles. Recording the weight of each container, on the label, before and after the batch is prepared will help to determine the actual quantities used and you will then be able to repeat the recipe exactly.*

Case studies 2.11 and 2.12 illustrate the approaches taken in different situations to develop new products.

### **Case study 2.11 Pizza in Uganda**

In the mid-1990s a British consultancy, Midway Technology, ran a training course for owners of small- and medium-scale bakeries in Uganda. At that time Uganda was emerging from a very difficult period and interest in small- and medium-scale enterprise was high. The trainer surveyed fast-food outlets in Kampala and quickly saw that there was a rapid growth in outlets selling fried chicken, hotdogs and burgers. No pizzas were on sale.

He suggested to the bakers that there was a very strong possibility of developing a market for pizza, as had occurred in other nearby countries. At first this was greeted with a degree of scepticism, but during the course a number of pizza formulations were developed, based on local preferences, and the bakers test marketed them in Kampala. The public reaction was very positive. Six months later a major bakery established a factory with 12 workers totally dedicated to pizza production. Pizzas are now a commonly accepted fast-food.

The results of the introduction of this new product benefited many sectors:

- the bakers producing pizzas
- suppliers of ground meat and sliced sausage
- suppliers of cheese and other ingredients.

### Case study 2.12 Match your products to your customers

Mrs Q. is very aware of the need to continually modify her fish-pepper sauce range. She regularly buys samples from competitors and tastes them to see if they have qualities that hers do not. If they do, she modifies her recipe.

Based on customer feedback she has developed new products. She now produces pepper-free *shito* sauce for expatriates who like the flavour of *shito* but not the hot chilli pepper. She also makes an 'extra hot' sauce and a medium to mild sauce in order to satisfy all tastes. In addition to new recipes, Mrs Q. has introduced new packaging and presentation including new, attractive labels, leak-proof jars and a range of different pack sizes.

### Calculating safe shelf life and use-by date

This is an area of vital concern to enterprises manufacturing short shelf life foods with a high public health risk. It is essential that both the customer (shop, hotel or institution) and the final consumer are given clear advice regarding sell-by and use-by dates. The calculation of use-by dates, as applied by large companies, is based on a combination of microbiological tests and past experience of similar products.

Very few small- or medium-scale enterprises have their own microbiological testing facilities and will need to have their analyses carried out by a local standards institution, university or other competent authority.

**■** *It is strongly recommended that producers work closely with specialists in this area when designing a use-by date testing programme.*

All new products or changed recipes should be checked using the following method:

1. Prepare several small batches of the product
2. Place samples under the recommended storage conditions (i.e. in a refrigerator at 4°C or in a deep freeze at -18°C). Check temperatures daily
3. Remove samples at agreed intervals: normally daily for short life products and weekly for products under deep freeze. Take samples for analysis. It is very important to keep them cold or frozen during transport
4. The testing laboratory will normally carry out tests for the Total Viable Count, *E. coli* and salmonella and other indicator organisms <sup>2</sup>
5. Over a period of time the microbiological quality of the product will decline to a level that, based on specialist advice from a standards institute, is unacceptable for sale and consumption. The time taken to reach this stage is the maximum life
6. It is normal to suggest an actual shelf life that is considerably less than the maximum in order to have a built-in safety factor. For example, if the maximum life for a cooked, sliced ham is found to be seven days, the recommended use-by date could be four days from the date of manufacture.

The above testing system assumes that the product will be stored exactly as recommended. This will rarely, if ever, be the case. For this reason abuse tests are run in parallel with the above test. Abuse testing might involve:

- moving the product to a refrigerator running at 8°C to simulate typical conditions in a home
- placing the food in a warm place for a few hours, to simulate conditions in a car, and then placing it in a fridge running at 8°C.

Abuse tests give a more accurate estimate of the likely use-by date as they take into account the conditions and hazards that the product will face during distribution. Some of these are depicted in Fig. 2.6.

---

<sup>2</sup> Tests for these indicator organisms are commonly used to define microbiological quality. Such standards are usually a legal requirement and will be quoted in local food legislation.



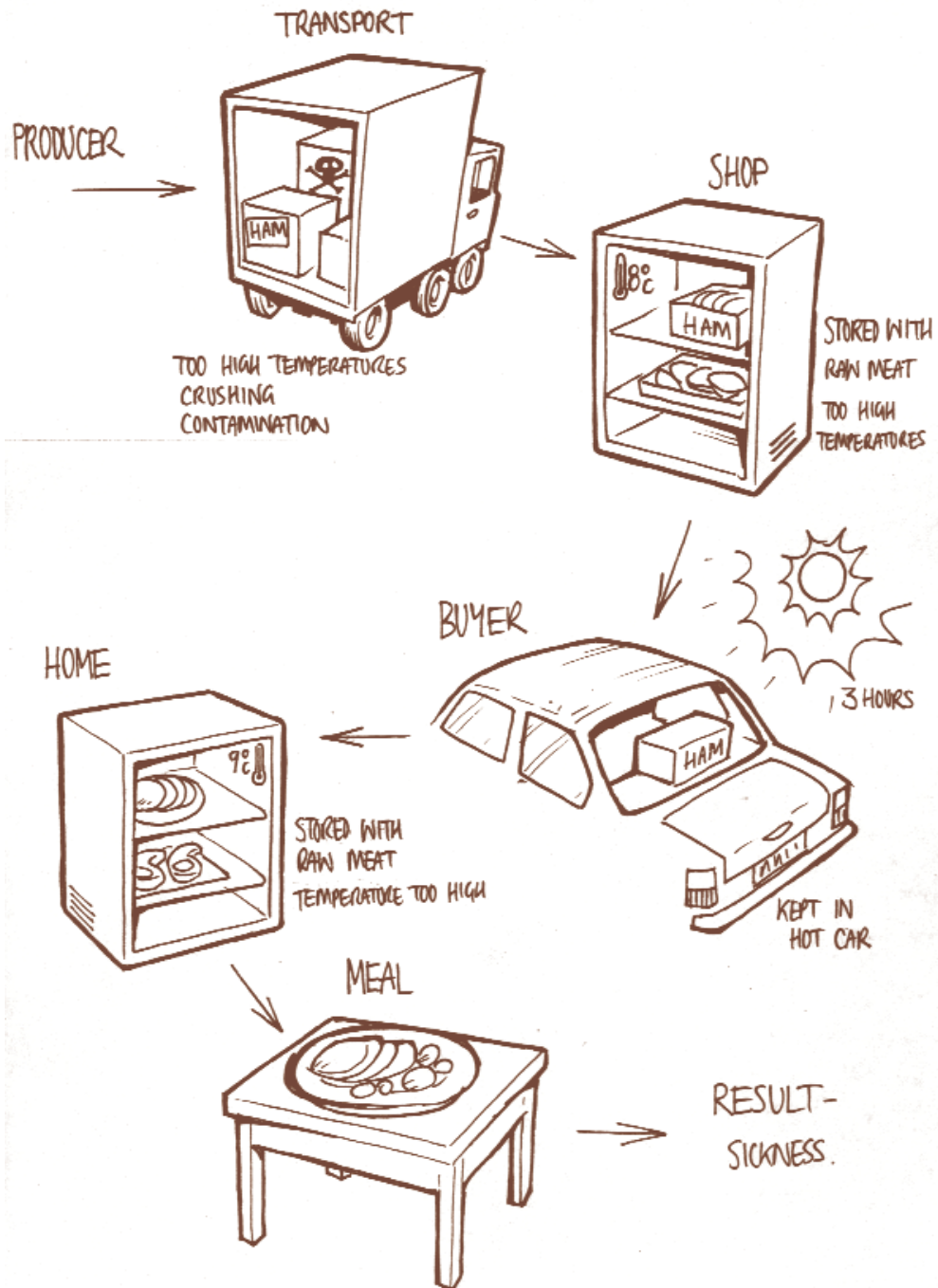

Fig. 2.6 Products can be given much abuse during distribution

## Summary of the chapter

- ✓ Preparing a feasibility study is essential for a successful business
- ✓ Develop close relationships with customers and maintain regular contact.  
Good customer care is a key to success
- ✓ Meat and fish products sell to many market segments: domestic poor, domestic rich, commercial, institutional, regional, international etc.
- ✓ Identify your market sector and develop a strategy that takes account of any competition
- ✓ All products require promotion that is targeted to the particular market segment
- ✓ Labels with recipes provide opportunities to expand sales
- ✓ Formal contracts with customers can benefit both parties
- ✓ Products that need refrigeration require a reliable cold chain
- ✓ New products can develop new markets, increase turnover and profits.  
It is vital to keep up with new market trends
- ✓ When developing new products seek specialist advice about storage conditions and shelf life.





The feasibility study, market analysis and business plan, described in Chapter 2, will have provided a framework on which to plan production. They will have identified:

- the range of products to be produced
- the likely market and its demands
- the size of the production unit required to meet the market demand
- the equipment that will be required
- services needed and their availability
- the likely number of staff needed and any training needs
- availability of raw materials, ingredients and packaging.

This chapter examines the steps taken when moving from the business plan to establishing production. It describes in some detail aspects related to the purchase of high quality raw materials, ingredients and packaging, principles of plant design and layout, services required and staff management. Where appropriate, advice is given on obtaining ingredients and equipment. Individual equipment required for the production of particular meat and fish products is described in Chapters 4 and 5. Legal aspects related to business formation and start-up are described in Chapter 6.

## Tips for success

- ✓ Seek advice when planning a production unit (e.g. local public health authority)
- ✓ Spend time planning and designing the production unit. Mistakes will be costly to correct
- ✓ Clean, attractive production buildings and surroundings attract customers, motivate staff and give confidence
- ✓ Only purchase fish and meat from reputable suppliers
- ✓ Ensure availability of quality raw material supply
- ✓ Supply ice to fishermen if necessary
- ✓ Good staff are one of your major assets
- ✓ Design systems for the prevention of cross-contamination into the processing room
- ✓ Include water treatment when designing a processing unit
- ✓ Consider the need for a large water storage tank if local supplies are unreliable
- ✓ If the production process involves chilling or freezing, include a cost allowance for a back-up generator
- ✓ Include waste disposal in your plans and remember you can make money from waste
- ✓ **Finally:** Read Chapter 5 and sections 4.1 and 10.3 in Volume 1: *Setting up and running a small food business*.

### *3.1 Setting up a processing unit*

---

The first step in planning production is to identify all the requirements necessary for a processing unit that will:

- conform with all local legislation
- produce foods under hygienic conditions
- produce foods that are safe
- be of the correct size and in a convenient site
- establish good practice systems for all staff and workers
- allow the production of consistent products
- be convenient to the market (Case study 3.1).

#### **Case study 3.1 The right location**

Mrs. O. owns a very successful fast-food establishment in Ghana, producing a range of ground meat products, fried fish and pizzas. 'We chose our restaurant as it is on a main road and runs to the part of town where the richer people and government officials live,' she says. She constructed a modern pizzeria that would appeal to richer people, students and families. She is now looking for new sites in strategic areas of town.

### *Designing the building*

Many small-scale food processing enterprises start in the home, moving to a dedicated unit as they grow. This section examines general issues related to small enterprises processing meat and fish. It is recommended that the relevant chapters of the first book in this series are read, where good plant design and layout is covered in more detail.

As meat and fish products carry a high public health risk, it is strongly recommended that entrepreneurs should seek advice from local universities, institutions and, above all, public health authorities. In almost all countries, meat and some fish processing enterprises will have to obtain licences from

public health bodies, so advice sought at the planning stage will avoid problems and costs in the future. In many cases, meat processors will require certificates of veterinary inspection.

Certain basic rules apply even when producing in the home and can be implemented at little cost. It is very important that a suitable room or out-building is set aside and used only for production.

*The household kitchen should never be used due to the risk of cross-contamination and also because it is designed for preparing foods for rapid consumption in the home rather than for sale.*

When designing a processing plant in a rented or specially constructed building, certain broad fundamental areas need to be considered. It is suggested that a decision-action grid is prepared as a tool to help think through these basic points and to identify actions that are required. An example is shown in Table 3.1. Safety of workers must also be taken into account in the design of the building.

As meat and fish are able to support the growth of potentially dangerous food poisoning micro-organisms, it is essential that all areas of the plant and equipment can be easily and thoroughly cleaned. Any places that may harbour germs must be eliminated. A small piece of rotting fish or meat can quickly cause major contamination. This section examines processing plant design features that need to be considered by all entrepreneurs planning to process meat and fish. Examples of good design practice are shown in Fig. 3.1.

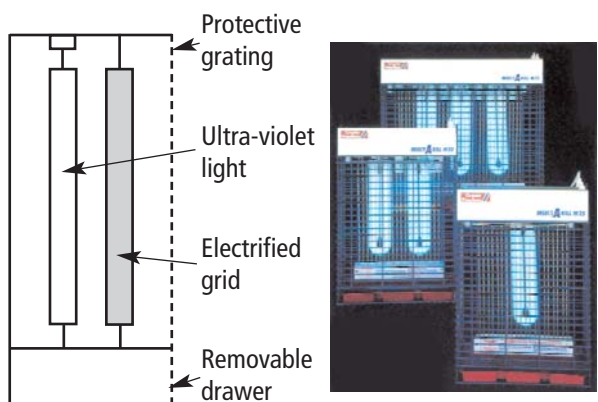

Fig. 3.1 Insect electrocutor  
(Photo: Courtesy of Electrolux Foodservice Ltd.)

Area to consider	Yes ✓ No X Could be ?	Entrepreneur's notes, things to do
Is the building big enough?	✓	
Is the site in a clean area suitable for food processing?	✓	
Can vehicles get to the site even in bad weather?	?	Talk to local people about conditions in rains
Can workers get to the site?	✓	Check bus timetables
Is reliable electricity available?	X	Cost in a generator
Is there good drainage?	?	Ask Ministry or local council about drains
Telephone connection nearby?	X	What will be cost of a line
Is the water supply of good quality?	?	Visit water authority, have water analysed
What waste disposal systems exist? Are there, or are there likely to be, local regulations?	?	Visit council and enquire
Is the site convenient for obtaining raw materials and marketing the products?	✓	
Does the building look attractive and professional?	X	Get building painted, put up a good sign
Does/can the site meet local planning and public health requirements?	?	Ask for site meeting with planning and health
Can the building be adapted at reasonable cost?	?	Obtain quotes from contractors

Table 3.1 Example of a decision grid

## *Walls*

Walls should ideally be clad with plastic laminate (formica) boards. Such cladding, which is easy to clean, is a legal requirement if goods are to be exported. A number of enterprises in African countries have adopted such cladding to meet export standards. Alternatively, the walls can be tiled with white tiles. The plaster grout between the tiles is a danger area in which food can lodge, and it is important that this is smooth with a flush finish and can be cleaned with a brush. Right angle corners should be avoided; instead making a curved finish of tile grout, which is easier to clean. If tiling is not possible or is too expensive, the walls should be smooth and painted with washable white gloss paint.



### *Floor*

The floor should ideally be of terrazzo with a smooth finish to assist cleaning. If terrazzo is not available, concrete can be painted with non-slip washable floor paint. The joint between the floor and walls is a potential area for food to collect and requires special attention. This should be filled with cement in a smooth curve to allow easy cleaning.

Meat and fish processing involves the use of considerable amounts of water, much of which will spill onto the floor. Whenever possible the floor should be self-draining by sloping it towards the drains. Areas that do not drain should be eliminated.

### *Drains*

Drains present a considerable hazard as food can lodge in them and decay. They can also, if not properly protected, provide an entry point for rodents and pests such as cockroaches. The drains should preferably be totally enclosed in pipes with a 'U' bend so that back-contamination is not possible. If open drains are used they should be covered with removable plates so that they can be thoroughly cleaned at the end of each day. It is important that the drains are sloped so that liquid waste flows from the low risk areas (where the finished products are made) back through the high risk areas (where raw material is prepared). This avoids possible contamination of finished products by dirty water. Many countries require this design for drainage by law. The exit should be fitted with a removable mesh to prevent the entry of pests. The mesh must be cleaned daily.

The effluent from a meat or fish processing plant contains flesh, blood and fat and so is a potential environmental hazard. Local regulations may require special treatment of effluents. The producer should consult with the local authorities and plan effluent disposal into the overall production unit plan.

### *Toilets*

Toilets are a potential source of contamination and should not be neglected. They must be well designed and cleaned and sanitised daily as part of routine cleaning. The door to the toilet should be kept closed at all times and any windows should be covered with fly-proof mesh.

### *Windows and doors*

These must prevent the entry of insects, and flies in particular. All windows should be covered with fine mesh mounted in a frame that can be quickly removed. The use of wing-nuts to hold the frame in place will allow its rapid removal so that the mesh can be cleaned. The door should be self-closing, preferably outward opening and protected by an inner hanging plastic screen. These are now available in most major cities and consist of hanging strips of plastic that allow workers to walk through them without using the hands. Transparent plastic is preferable as it can be seen through and reduces accidents. Horizontal surfaces such as window ledges should be avoided as food and soil (dust, food residues and other contaminants) can accumulate. All surfaces should be sloped, if possible, so that they can be washed down and drain naturally.

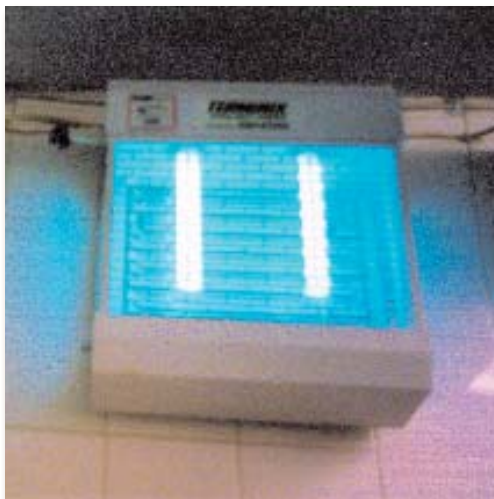

Fig. 3.2 Small ultra-violet insect trap or 'insectocutor' (Photo: B. Axtell)

Flies and cockroaches are particularly problematic in the spread of disease, and other insects can infest products such as dried meat and fish. The use of ultra-violet insectocutors to attract and kill any flying insects that might gain entry to the unit is strongly recommended. Small units are now available at reasonable cost and an example is shown in Fig. 3.2. Ants are also a serious problem in tropical countries and need to be controlled.

It is common practice to keep a strip of land around the building that is free of grass and weeds and sprayed with insecticide to prevent crawling insects crossing it. This is called a 'cordon sanitaire'.

### *Ceilings and lights*

While a flat enclosed ceiling appears most hygienic it does provide a space in which pests can live and dust and soil can accumulate. Enclosed ceilings are often mandatory in public health regulations. Easy access to the roof space should be provided, together with lighting and a power point, to allow for inspection and cleaning.

Good lighting is essential in the processing plant and if rotating machinery such as grinders or choppers are used, normal incandescent light bulbs must be fitted because fluorescent lights can make a rotating machine appear stationary at certain speeds. This is clearly a hazard to workers.

### *Power supplies*

The production of many meat and fish products involves chilling or freezing and a reliable electric power supply is essential if product loss is to be avoided and public health ensured. Unfortunately, power supplies in many ACP countries are unreliable and power cuts of several hours are not uncommon. The use of a back-up generator is strongly recommended. The most suitable types start automatically when the mains supply fails, thus avoiding problems occurring at night or weekends. A competent local electrician should be consulted and asked to calculate the electricity demand for all the cooling equipment in the processing plant. A generator with at least 50% above this demand should be installed, to allow for any growth in production. Practically all the meat processors surveyed in the preparation of this book had back-up power and one made the very good point that 'a meat processing plant without its own generator is doomed and will die'. Proper insulation of production areas and cold stores will reduce power consumption and costs.

As meat and fish processing uses a lot of water for washing down, all sockets should ideally be splash proof. Equipment should be 'hard wired'<sup>3</sup> using waterproof flexible conduit. This allows pieces of equipment to be moved quickly for cleaning. Always have electrical work carried out by a competent

---

<sup>3</sup> *Hard wiring means permanently wired rather than through a removable plug.*

electrician. All electrical plugs should be fitted with fuses of the correct rating depending on the power demand of the piece of equipment. All too often oversized fuses are used, which can result in electric motors being damaged. For safety reasons, the mains supply should be fitted with a modern earth trip-switch that cuts the supply in the event of any electrical leakage to earth.

The growth of micro-organisms is temperature dependent and reaches a peak between 35 and 40°C. Lowering the temperature in critical parts of the processing plant, for example the preparation areas, will have a considerable impact on the rate of growth of micro-organisms. The installation of air conditioning in such areas is strongly recommended. Some organisms, called psychrophiles, have lower temperatures for optimum growth (typically 5-20°C). Of particular concern is the food poisoning *Campylobacter*, which will even grow at refrigeration temperatures.

### *Water*

The availability of good quality, potable water is of critical importance when processing meat and fish. In some ACP countries, mains water quality can vary, particularly after heavy rain. It is suggested that the entrepreneur should consult the local water authority regarding the quality, reliability and variability of the supply. If there is any doubt regarding the quality of the water, it will have to be treated.

Of particular importance is process water that is added to the product, for example ice added to sausage mixes or water used to prepare marinades for fish or meat. This must be potable and have a maximum chlorine content of 0.5 parts per million (ppm). Levels above 0.5 ppm can be tasted in the food. All water used to wash down equipment, floors and walls should be chlorinated to give a chlorine level of 200 ppm by adding either sodium hypochlorite powder or household bleach. Table 3.2 shows the dilutions of bleach required to make solutions of different strength.

**■** *Both solid and liquid bleach are corrosive and can damage the skin and eyes; they should be handled with care.*

Volume of bleach (ml)	Volume of water (litres)	Chlorine level (ppm)
1000	250	200
500	250	100
25	250	5
2.5	250	0.5

Table 3.2 Dilutions of liquid bleach to make chlorine solutions

Some of the enterprises surveyed obtained water from a private borehole or well. In such situations consideration should be given to automatically dosing the water with a strong, standard strength chlorine solution. These systems are commercially available and consist of a high pressure, adjustable dosing pump, activated whenever the main pump is in use. A typical installation is shown in Fig. 3.3.

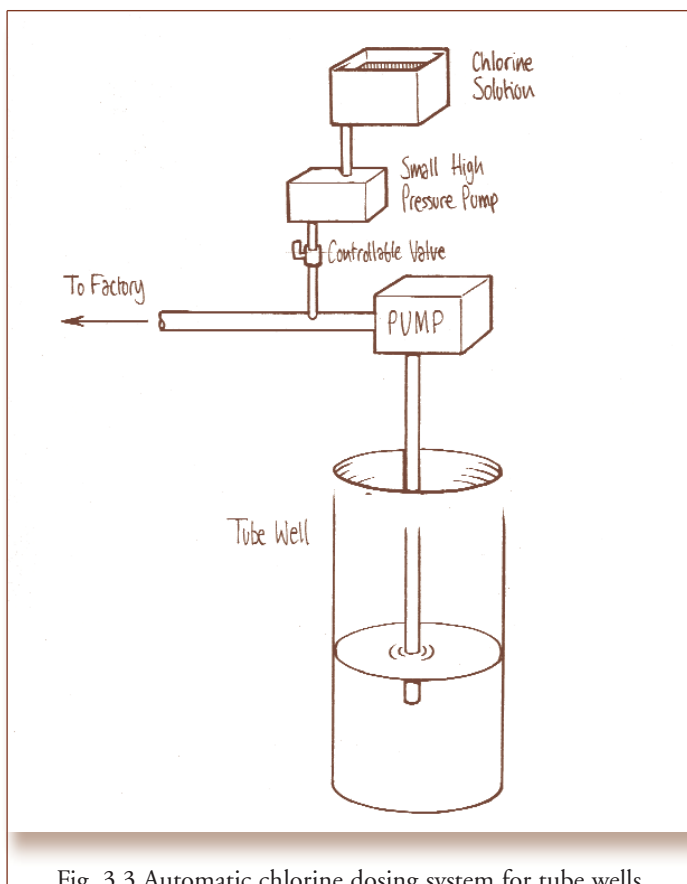

Fig. 3.3 Automatic chlorine dosing system for tube wells

A high level tank to hold water for washing and cleaning is a worthwhile investment as it allows the use of hoses under pressure. The use of self-closing pistol grip guns with adjustable sprays on hoses will soon cover the cost from savings in water usage. As a general principle, at the end of each working day it should be possible to detect a slight 'chlorine' smell in the processing rooms indicating that they have been properly cleaned.

Methods of testing water for chlorine content are included in Chapter 6. Further details of methods of treating water, such as boiling, chlorination, filtering and sedimentation are to be found in section 5.2 of Volume 1.

Ice is of extreme importance to maintain the cold chain, particularly when fish is processed. Most countries with active fisheries now have ice-making facilities. The quality of the ice may vary and checks should be made to ensure it is made from properly treated water. Ice made from dirty water will contaminate the fish.

### *Steam boilers*

These may be used by larger enterprises to cook hams or heat dryers. Boilers are fired by wood, coal, kerosene, gas or electricity. Boilers are potentially very dangerous items of equipment and must be properly maintained and given a safety certificate at regular intervals by a certified boiler inspector. All steam pipes should be lagged with insulation to prevent accidental burns. In many countries there are regulations related to steam pipes, for example they should all be painted red.

### *Waste disposal*

Disposal of waste must be considered as part of the production unit planning process. Meat and fish processing plants will produce two types of waste: liquid and solid. In many countries regulations will require that bones, flesh, fat and blood are correctly disposed of, not simply left in a bin for collection. Once again the local authorities should be consulted, not only regarding existing regulations for solid and liquid waste, but also for any expected changes in the law.

Meat and fish waste in tropical countries presents a real hazard as it attracts flies and vermin that may enter the processing plant and contaminate the products. The disposal of solid waste should be part of a management

control process with clear rules and responsibilities in good waste disposal:

- all solid waste must be placed in marked bins and the lids securely closed
- at the end of each working day all waste must be removed from the site
- all bins must be thoroughly cleaned and sanitised with a detergent/bleach solution at the end of the day.

Waste from meat or fish processing plants may have value and can be sold, for example, to animal feed producers (Case study 3.2).

### **Case study 3.2 Waste disposal**

Mr B.'s company makes money from its waste. Bones and heads are sold as pet food. Skins are also sold as hides to leather workers.

Another enterprise uses the majority of the carcass and therefore produces very little waste. The intestines are used to make sausage casings and the bones and skins are sold. Waste water is channelled into three stages of settling ponds where enzymes<sup>4</sup> are added to break down the fat. The water is then discharged into a stream or used for irrigation. Paper waste is burnt and helps to fuel the wood-fired boiler.

### *Ventilation*

This should also be considered and will be essential in production areas that involve cooking or smoking. Electric extraction fans will need to be fitted at strategic points in the processing area.

### *Plant layout*

The detailed layout of a meat or fish processing plant will depend on the shape and size of the building and the range of products being produced. However, certain fundamental and common principles apply (and are considered in more detail in Chapters 4 and 5):

- cross-contamination must be avoided. Materials should follow an unbroken path, that never crosses, through the plant from receipt of raw material, chilling or holding, primary processing, secondary processing and dispatch (Fig. 3.4)

<sup>4</sup> Enzymes are proteins that are able to break down food materials such as fats, proteins and carbohydrates. Commercial preparations are available for specific uses including breaking down food waste.

- incoming meat and fish should be stored frozen or in a cold room below 4°C. The cold room should not be used to store finished goods or any other materials
- there should be a physical separation between the area used for basic preparation, such as filleting, boning and trimming, and the final production area
- where possible, there should be a physical separation between areas producing, for example, minced meat or fish products and areas in which meat is cured and fish is brined
- finished goods, such as sausages and hamburgers, should be held in a dispatch room either frozen or below 4°C. Dried products such as smoked or dried fish or *biltong* should be stored on pallets off the floor in a well ventilated area and protected from moisture and insects
- cooking, drying and smoking should be carried out in separate well ventilated rooms to control steam, heat and smoke in the plant
- if the enterprise has its own abattoir, this should be located away from the processing plant to minimise cross-contamination by faeces and other materials
- ideally the plant should be divided into sections with different levels of temperature control. Divisions also minimise the risk of cross-contamination – by water spray when cleaning, for example
- a dry storeroom should be provided for minor ingredients and packaging. Cleaning materials should have their own store. In addition a small area or room should be set aside for quality control testing and shelf sample storage
- a changing room, if possible with showers, should be provided. There must be at least two doors between toilets and the processing plant. Separate rooms will be required for male and female staff and soap or detergent together with hand drying facilities should be provided.



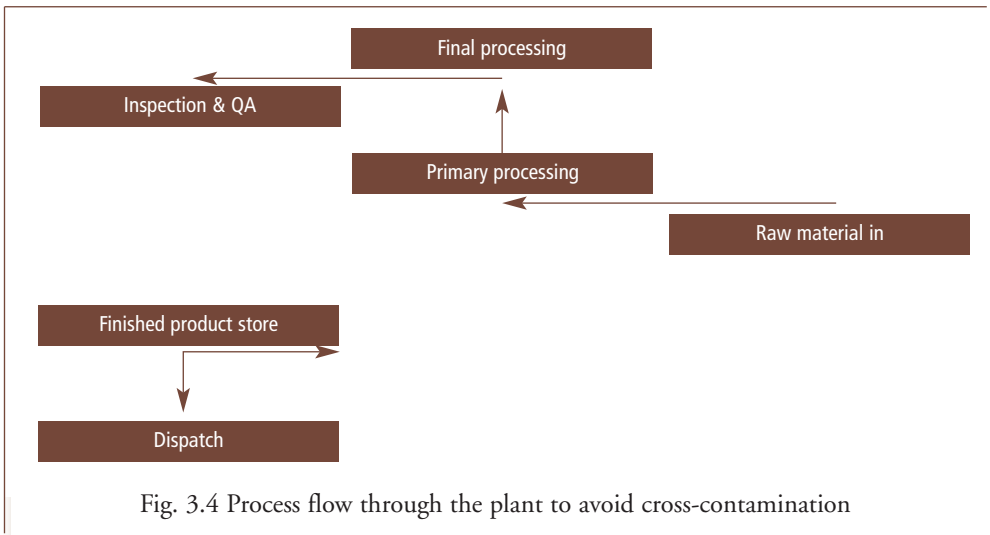

### 3.2 Buying raw materials, ingredients and equipment

#### Raw materials

In almost all ACP countries the basic raw materials – fish and meat – are bought locally. Only one enterprise interviewed for our survey imported frozen pork from the Netherlands for reasons of quality and economy. Other ingredients may be available in the local market, obtained regionally or, in some cases, imported from outside the region.

#### *Meat*

As meat products carry a high public health risk it is vital that processors pay great attention to the quality of raw meat purchased. In many countries, the conditions under which animals are slaughtered are basic and the control and inspection systems operated by public health officials are poor. The high ambient temperatures in tropical countries make risks even higher. Poor slaughter conditions not only pose a hazard to health; they can also stress the animals, which adversely affects the quality of the meat.

Contamination in the meat can arise from two sources: infections in the living animal, and through contamination of the meat after slaughter. Risks from

living animals include anthrax (mainly from hides and hair), brucellosis, salmonella and parasitic worms. The latter (known as trichinae) are particularly common in pigs that have been fed on uncooked rubbish. These parasites pose a serious public health hazard and can be fatal to humans. They can be destroyed by heat or cold and typical regulations require that all parts of a pork product should be heated to at least 58°C. When cooking or smoking pork products it is very important that such temperature checks are made in the interior of the largest pieces of pork being processed. Checks in a smoker should be carried out at several points, paying particular attention to the cooler areas of the smoking chamber.

Trichinae may also be destroyed by freezing. The treatment depends upon the size of the cuts of pork and the temperature. For example, at -15°C a 5 cm slice requires 20 days while a thicker slice needs 30 days or more. Specialist advice should be sought.

External contamination of meat starts in the abattoir. Contact with hides, soil and faeces, puncturing of the intestinal tract, poor quality water, dirty equipment and unhygienic staff can all contribute to microbiological contamination. Some characteristics of common food poisoning resulting from meat are shown in Table 3.3.

<b>Organism</b>	<b>Time to develop symptoms</b>	<b>Symptoms</b>	<b>Source of organisms</b>
<i>Salmonella</i>	8 to 12 hours	Diarrhoea, stomach pains	Animal guts
<i>Staphylococcus</i>	1 to 6 hours	As above with high temperature and vomiting	Skin and nose in man and animals
<i>Enterococcus</i> and <i>Streptococcus</i>	2 to 18 hours	Cramps and diarrhoea	Animal intestines

Table 3.3 Common microbiological contaminants of meat (Lawrie, 1985)

Given the serious public health risks described above, meat processors clearly have a great responsibility to their customers. It is recommended that they should:

- read books and literature in order to increase their knowledge and awareness of problem areas
- identify institutions that can provide advice, support and training

- only purchase meat from reputable suppliers
- visit abattoirs to check the conditions under which meat is handled
- only purchase pork from established pig farmers – never buy pork from pigs that have lived ‘on the street’
- take advice from public health officials regarding the best abattoirs and the inspection systems in place
- ensure a reliable cold chain from the point of purchase of meat and fish to the production unit.

The way that animals are reared and fed has a major influence on meat quality in terms of tenderness, fat content and flavour and producers should identify farmers who maintain good standards. The conditions under which an animal is kept immediately prior to slaughter also have a major influence on meat quality. If the animal is stressed, biochemicals are produced that have a negative impact on the tenderness of the meat. Stress also results in lowering of the acidity (or an increase in pH) which encourages the growth of food poisoning and spoilage organisms. Rested animals also have lower levels of micro-organisms in the body tissue. It is thus very important that stock should be rested under calm conditions before entering the abattoir (Case study 3.3).

### **Case study 3.3 Check the source of your raw materials**

A university in Ghana has a meat and livestock department, which includes a commercial meat processing unit and abattoir. Cattle and pigs are bought from identified farmers using strict selection criteria. Most farmers feed low grade, cheap feed for economic reasons. This does not enhance meat quality. Animals bought in are thus put under observation, the cattle on good pasture and the pigs in lairage (a sty in which they can rest). Quality feed is provided until the animals are of the correct weight and have the required fat content and meat quality. Animals are kept under calm, stress-free conditions before entering the abattoir.

One year, due to large Christmas orders, the unit was forced to buy meat from another abattoir. The meat was delivered by van, still warm, and immediately put into the cold store. The next day it had developed off-odours and slime. The abattoir was visited and several undesirable practices were found:

- there were a lot of 'non-staff' present as owners followed their carcasses through the plant. All were dirty and not properly clothed
- workers had old clothes and no aprons or rubber boots
- just before stunning animals were wet around the belly and thighs due to the manner they were dragged to slaughter
- no care was taken during evisceration and skinning, guts were punctured and gut contents were seen on the carcasses. This resulted in a lot of washing, which spread any contamination all over the carcass. After quartering, no attempt was made to chill the meat despite the fact that chillers were available.

The overall conclusion was that the workers did not know what they were doing and the university arranged to carry out training. The manager of the university processing unit concluded: 'only buy from abattoirs that you have visited and inspected, as with all foods high quality products can only be made from good quality raw materials. Freshly slaughtered beef or pork must be cooled as rapidly as possible before being taken into cold storage. Failure to do so will result in huge losses through spoilage.'

Many small-scale meat processors do not have their own abattoir, buying meat from local markets and suppliers. As a general rule, it is far better not to buy in local markets as the meat may well have been contaminated by soil and flies during transport, held at high temperatures for some time and slaughtered under poor conditions. It is far safer to buy from source.

Case studies 3.4 and 3.5 clearly show that small-scale meat processors can have a considerable degree of control over the quality of raw meat purchased and do not simply have to rely on the local street market or middlemen. These cases demonstrate the value of establishing specifications or agreements.

### **Case study 3.4 Guidelines for setting up a small abattoir**

In Zambia, all the meat industries visited carried out their own slaughter and the following recommendations were made:

- the site should have enough space for lairage where animals should be held before slaughter to facilitate resting
- an electric sting or prodder should be used to slaughter cattle
- a sting should be used to slaughter pigs
- the slaughter pen should be fitted with a hoist for lifting the animal. The animal should be lifted by its back legs after slaughter to allow bleeding
- the following facilities should be provided: bleeding, skinning, evisceration, inspection of the carcass and organs, separation of clean and dirty offal
- a detention and cooling facility will allow the meat pH to fall and the meat to tenderise
- a facility is required for the disposal of any rejected carcasses
- adequate lighting, ventilation, fly screening and rodent proofing are needed
- a good water supply is needed for cleaning and washing.

### **Case study 3.5 Buy meat carefully**

Mrs S. in Tanzania has a small company producing beef sausages and burgers. She makes sure that all her meat is purchased under close supervision. Despite this she still has problems ensuring that her supplies are carefully selected and that the cuts meet her quality standards. She is now planning to enter into a contract with a local ranch. This will not only reduce costs but will ensure a more consistent quality.

A Zambian enterprise buys only from one supplier and the price paid is agreed against a set specification. 'We pay less for fatty meat because the company makes money from meat, not fat,' he explains.

An enterprise in St Lucia buys imported frozen pork and beef of guaranteed quality standards. Local chicken is bought, but only if it has a valid certificate of health from the Veterinary Division of the Ministry of Agriculture.

## *Fish*

The way that fishermen and agents handle fish prior to processing has a major influence on the quality of the final product. Problems may arise from not keeping the fish cool, bad gutting techniques that contaminate the body cavity or from flies laying eggs. Poor handling at landing sites, where the fish may be placed in dirty baskets or simply thrown on the ground, cause further contamination. While these are beyond the scope of this book it is recommended that processors make every effort to identify fishermen and agents in whom they have confidence and impress upon them the need to supply the best quality raw material. If necessary, premium prices should be offered for high quality fish. Suppliers should be required to keep fish covered (to prevent blowflies laying eggs) and to add ice to keep the fish cool. Using ice greatly assists in maintaining quality and should be seen as part of the cold chain from purchase to processing. Trials in Uganda have assessed the benefits of providing ice to fishermen; a practice that resulted in a significant increase in fish quality<sup>5</sup>. Remember: a high quality final product can only be made from high quality raw materials.

## *Salt*

Salt is commonly used when processing meat and fish. It is important that the processor selects the correct type of salt (sea salt, crude rock salt or refined salt) as considerable variations exist that can affect the quality of the final product. Rock and sea salt are often contaminated with dust and sand and may contain calcium and magnesium salts that can impart a bitter flavour. Simple quality control tests for salt are described in Chapter 6. Coarse large salt grains dissolve slowly in water, so reducing the rate of penetration into the flesh. In general, fine-grained refined salt is recommended for preparing brines; it dissolves quickly and is low in calcium and magnesium. Coarse-grained salt is preferred for dry salting as it dissolves more slowly. If fine salt is used, 'salt burn' may occur in which moisture removal from the surface is too rapid and the surface of the fish becomes hard, preventing further moisture removal and salt penetration.

---

<sup>5</sup> *Personal communication, Dr M. Dillon.*

### *Sausage skins or casings*

These may be natural – made from the cleaned and treated intestines of pigs, sheep and cows – or they can be synthetic. The choice of casing will depend upon the type of sausage being produced, local availability and, in some countries, cultural issues. The use of pork casings for beef sausages would not, for example, be acceptable to Muslim consumers. While natural casings made from intestines can be produced locally, their microbiological standard should be regarded as suspect unless they are checked by a competent laboratory. Synthetic casings will need to be imported in most ACP countries (see Case study 3.6). The supplier should provide a specification and guidance on use and storage conditions. Specific types of casings, and their use, are described in detail in Chapter 4.

#### **Case study 3.6 Sausage casings**

A sausage-making business in Ghana obtains all its casings from Germany. 'After conducting market research, we found that imported types met our requirements better than those obtainable locally,' says the proprietor. 'The imported casings represent about 1.5% of production costs and can withstand physical damage during use, transport and storage better than those available locally.'

### *Fillers*

Fillers, such as breadcrumbs or other starchy cereals, are often added to sausages, burgers and other ground meat products. Their use is particularly common when low cost products are required. Fillers are often referred to as 'rusk'. In many countries, rusk is specially prepared for the meat trade by raising and baking wheat bread. The ground material is sieved and supplied with a standard particle size. Rusk is able to absorb some three or four times its weight of water and is used to soak up any free water that remains after the meat and fat has been ground. If commercially produced rusk is not available local bakers will often provide loaves that are unsold at the end of the day. The crust should be removed and then slices of bread gently dried in an oven. The slices can then be milled, sieved and stored in an air-tight container to avoid moisture absorption.

### *Binding aids*

These are substances that gel on heating. They are used to bind fat and reduce fat losses on cooking, forming a more cohesive end-product. Common binding aids include:

- de-fatted soya flour
- milk powder
- whey powder
- starches.

### *Herbs and spices*

These give a particular brand of meat or fish product its particular customer appeal. They can either be purchased as a prepared seasoning mix or made in-house by the producer (Case study 3.7).

#### **Case study 3.7 Using spices**

A sausage producer in Zambia makes his own spice mixtures, explaining: 'This allows us to produce sausages with an individual flavour that sets our products apart from the competition.'

A producer in St Lucia imports all spice blends from the UK. 'We work with the supplier to develop the blend. It is then made to that specification to ensure a consistent product.'

In recent years there has been a massive growth in the sale of ethnic foods, and Indian and Chinese restaurants can be found in most major cities. To meet this interest, spice manufacturers have developed seasoning mixes such as Indian spice, spicy Mexican and smoky barbecue flavour. There are advantages and disadvantages in buying prepared mixes over producing them in-house:

- bought mixes will be the same every time, maintaining a standard flavour
- herbs and spices may contain high levels of micro-organisms that could contaminate the product
- preparing the mix in-house allows the producer to experiment and develop unique mixes of flavours that stand out from competing brands.



Herbs and spices are expensive ingredients and many quickly lose flavour and colour when exposed to light and air. They should therefore be purchased in small quantities and stored in airtight, light-proof containers in a cool dry room.

### *Sodium nitrate (E251) and sodium nitrite (E249)*

These are widely used as preservatives in processed meats. They also play a role in the formation and retention of the typical pink colour of ham and bacon. Sodium nitrate slowly breaks down in the meat curing process, through the action of micro-organisms such as lactobacilli, to form sodium nitrite. Nitrites are known to be toxic at high levels, the lethal dose for an adult is about 1 g. In most countries nitrite may only be used as a pre-mix diluted with salt. The use of a pre-mix reduces the risk of workers being exposed to sodium nitrite and increases the efficiency of mixing the nitrite into the product so minimising 'hot spots'.

Various mixes are commercially available , such as:

- Prague Salt No.1 (0.6% sodium nitrite in salt)
- Pokesalz (Germany) (0.6% sodium nitrite in salt)
- Sel Nitrite (France) (0.6% sodium nitrite in salt)
- Nitrited Salt (UK) (typically 50% sodium nitrite and 50% salt)
- Prague Salt No.2 contains 50% sodium nitrite and 50% sodium nitrate.

Prague Salt No.2 has a 'delayed action' cure as the nitrate is slowly converted to nitrite. It is principally used in uncooked products such as salami, chorizo sausage and cured bacon, which need long drying and smoking times.

*It is important that producers understand the difference between the action of nitrite, which acts as a preservative, and nitrate. Nitrate slowly converts to nitrite during curing through the action of acid forming bacteria. It can thus be regarded as a 'delayed source' of the preservative nitrite. In most countries there are legal limits on the residual levels of nitrate and nitrite in food. Details can be found in section 6.6.*

## *Additives*

A number of minor additives are occasionally used in processed meat products and are listed in Table 3.4.

<b>Additive</b>	<b>Action</b>	<b>Use</b>
Polyphosphates	In the presence of salt these increase the action of salt on lean meat proteins, reduce cooking loss and increase meat and fat binding. They also bind water and reduce shrinkage.	Mostly used in lightly cooked products such as hams. Polyphosphates at levels above 0.3% impart a bitter flavour.
Ascorbic acid	Used to speed up the development of a cured colour. Its use will reduce residual levels of nitrite.	In cooked cured products.
Sweeteners: sugar, dextrose	Sweeten, promote browning and feed micro-organisms active in the curing process. Improve flavour.	In sausage formulation, marinades and cures. Dextrose acts faster than sugar.

Table 3.4 Minor additives used in processed meats

## *Buying equipment*

Some equipment required by fish and meat processors is likely to be available, or can be made, locally. Examples include traditional and simple smokers, drying cabinets and cookers. In many ACP countries, facilities are not available to fabricate in stainless steel, the preferred material for food processing equipment. Good quality specialised equipment such as food mincers, sausage stuffers and thermostatically controlled smokers will, in most cases, have to be imported.

Identifying external suppliers of suitable equipment can often be a problem for small-scale manufacturers. Universities with a food science department and local manufacturers' associations can often assist, and may have a library of catalogues. Most embassies have a trade secretary who also should be able to assist with contacts. Some of the international development agencies listed in Appendix I will be able to provide contacts with suitable suppliers. Much of

the equipment used by small and medium-scale processors is also used in large hotel kitchens and many hotels will have catalogues.

In Europe, most food processing is carried out on a very large scale and the equipment used is totally inappropriate for small enterprises. Countries in southern Europe, such as Spain, Greece and Italy, however, as well as the USA still maintain a tradition of smaller-scale production. A wide range of appropriately sized and priced items are still available in these countries.

*It is very important when buying equipment to ensure that the capacities, or throughputs, match. This avoids over-capacity in one area of the plant and bottlenecks in another. Such situations may mean that some staff stand idle and food may be left standing and deteriorating.*

### Packaging

With the exception of casings (which are a form of packaging) the packaging required for meat and fish products is simple and of moderate cost. The most commonly used packaging consists of:

- polythene bags  
(available in most ACP countries)
- plastic sealing tape to close plastic bags  
(usually available in the local markets)
- plastic or fibreboard trays (usually imported)
- food grade plastic shrink film, which is commonly used to wrap foods or over-wrap trays of product
- self-adhesive labels. It is important that these are resistant to moisture and water (in most countries the special paper will need to be imported for local printing).



Fig. 3.5 Sealing tape dispenser

### *3.3 Keeping records*

---

Records are kept to assist in the legal, efficient and profitable running of an enterprise. Financial and production records are discussed further in Chapter 7 and in greater detail in Volume 1. Two broad types of records exist:

- mandatory records that must be kept to comply with local legislation. These may include audited accounts, value added tax (VAT) returns, worker health screening reports and pay as you earn (PAYE) tax returns for staff
- internal records including material purchase, sales, quality assurance, cleaning schedules and maintenance records. These are used to manage the business.

The value of record-keeping is demonstrated in Case study 3.8.

#### **Case study 3.8 The value of record-keeping**

The owner of a medium-scale enterprise in Ghana produces a fish-based pepper sauce. She keeps records of production, staff, quality and sales. She costs all utilities, ingredients, labour etc. She regularly analyses these to compute the selling price of the products and to check if she is making a profit or not. She regularly calculates the break-even point of the enterprise. Her records also help her to track and identify annual trends in raw material and packaging costs. Records are kept daily in a notebook and transferred to the computer each week. She has recently seen from her analysis that the profit margins over the last three years have fallen from 30% to 10% and she is now able to react to this situation.

The design of a basic record-keeping system should be part of the production planning process and should cover the following:

- what records must be kept for legal reasons?
- what records will be useful to the enterprise and how will they be used?
- who will keep records? Will an external accountant be required?

Constructing a decision tree, similar to that shown in Table 3.1, is a useful exercise that helps the entrepreneur to decide what is required, who is responsible and what actions need to be taken to put the system in place.

### *3.4 Recruiting and managing staff*

---

When establishing a new enterprise it is very important to consider staff requirements. Will qualified or experienced staff be needed? What will be the cost? Will workers need training and, if so, how will this be done and what will be the cost? The process of recruitment is covered in greater depth in Chapter 10 of Volume 1.

Recruiting, training and retaining motivated staff with a genuine commitment to the company is a key factor to business success. De-motivated workers, on the other hand, can cause great damage by, for example:

- not carrying out their work with care
- actually causing deliberate sabotage
- spreading negative rumours about the enterprise and its products
- leaving, perhaps with your trade secrets, and joining a competitor.

Good staff management is less about telling staff what to do and more about building their feeling of belonging, worth and responsibility. Many small enterprises tend to offer work to family and friends rather than recruit on the open market. Employing friends and relations often means that the best quality of staff are not recruited and it can be difficult to discipline or dismiss people.

When hiring staff the owner of the enterprise should spend time considering the role of the worker and aspects such as:

- level of education and skills required
- additional training needed, either in-house or external
- preparing a job description so that both parties understand their responsibilities
- the general health of the prospective employee. In many countries, public health regulations require screening for diseases such as tuberculosis and salmonella.

When developing training programmes it is very important to make sure that workers understand why they should behave in a certain way and why certain jobs must be carried out at a particular time. Training using an order system does not work. People need to understand the result of their actions (see Case study 3.9).

### **Case study 3.9 Managing staff**

#### *1. Using orders*

I am sure you know that dirty hands contaminate food and that you must follow the rules. In this factory it is important that you always wash your hands before entering the processing room and, in particular, after visiting the toilet. Hats must be worn at all times to prevent hair falling into the food.

#### *2. Using understanding*

I am sure you know that dirty hands contaminate food and that you must follow the rules. In this factory it is important that you always wash your hands before entering the processing room and, in particular, after visiting the toilet. Hats must be worn at all times to prevent hair falling into the food.

Now, these little dishes contain a gel that allows the growth of micro-organisms. I would like you, John, to put your fingers onto the gel. Now, Mary, would you go and wash your hands and then do the same. Peter, I would like you to wash thoroughly twice and make your impression. Finally, John, could you take a hair from your head and put it onto the dish. Thanks. I am now sending these to the lab to see if any bugs grow.

In the final stage the staff are shown the results and learn the importance of good hygiene.

Good and fair employment benefits also help to motivate staff and these can include:

- paid holidays
- sick pay
- free or subsidised lunches
- laundered uniforms
- regular staff meetings
- subsidised purchase of products
- transport allowances
- assistance with medical costs.

### **Case study 3.10 Successful businesses treat their staff well**

A small company in Tanzania has three paid employees who were taken on because they were young, educated, family members in good health. All received on-the-job training. Regular discussions are held on business and social issues in order to develop a team spirit. Salaries are paid promptly at the end of each month, and benefits include uniforms, meals, transport allowance and medical treatment.

‘We provide on-the-job training and, during the initial period especially, we stress the need for good sanitation and personal hygiene. We teach the production process and explain why each step is being done, stressing the importance of temperature management.’

Another small-scale producer in Zambia provides on-the-job training because there is no institute to provide adequate meat processing training. ‘We take advantage of our friends in Germany,’ says the owner. ‘They are experienced in this area and help us with our training. They keep us up-to-date with information.’ The company provides several benefits i.e. transport to work, subsidised meals, paid holiday and maternity leave, hospital care for accidents and special situations (but not for common sickness like malaria) and hot showers.

In St Lucia an entrepreneur explained: ‘In this plant we have 14 workers, five of whom are women and we produce about 650 kg of products per day. We are very up-front with the workers, let them know what is required of them, provide them with training and keep tabs on their performance.’

## Summary of the chapter

- ✓ When planning a production unit, prepare a decision tree and action plan
- ✓ Time spent considering the internal and external finish of the processing facility is well spent. Making changes later can be very expensive
- ✓ Plan adequate waste disposal systems
- ✓ Make sure systems are in place to control pests
- ✓ A back-up generator should be considered an essential item of equipment if refrigeration is required
- ✓ If you cannot totally rely on the local water quality put in a treatment system
- ✓ Involve local authorities early in the design process
- ✓ Materials must flow through the processing plant to avoid any possibility of cross-contamination
- ✓ If possible, divide the plant into operational zones
- ✓ Keep a strict, documented schedule of maintenance for equipment and buildings
- ✓ Only buy fish and meat from trusted suppliers, never buy simply on price
- ✓ The throughput of equipment should match to avoid bottlenecks
- ✓ Decide what records to keep when planning production
- ✓ Invest in staff; they are either a key resource or can become a potential liability.



## Entrepreneur's checklist

- Have you considered all the requirements of the planned production unit?
- Are you aware of local regulations and do you have copies of those that apply?
- Have you an approved system of waste disposal?
- Is the facility protected against pests?
- Do you know how to treat water to make it safe for use in foods?
- How will you make sure that all workers feel part of the team?



This chapter outlines typical production systems for meat products as made by small- and medium-scale enterprises. The products include sausages, hamburgers, pâtés, bacon, ham and dried meat. Products such as canned meats are not described as the capital equipment costs are prohibitive for small-scale enterprises, which could not possibly compete on price with large-scale factories. Baked products, such as pizzas, pies and sausage rolls, are only briefly mentioned in regard to the market opportunities they provide to meat processors. Their production is covered more fully in *Setting up and running a small flour mill or bakery* in this series.

## Tips for success

- ✓ Learn about cuts of meat and how to butcher an animal efficiently in order to maximise profits
- ✓ The individual flavour of carefully mixed seasonings can make your product special
- ✓ Fresh herbs have more flavour than dried
- ✓ Cleanliness and hygienic production are vital
- ✓ Use chopping boards, clean them every time they are used and sanitise them at the end of the day
- ✓ Books on charcuterie <sup>6</sup> will provide many different product ideas
- ✓ Understand the difference between sodium nitrate and nitrate-nitrite cures.
- ✓ Never smoke a product that has not been cured
- ✓ Take time to fully understand the action of cures
- ✓ Experiment with small batches when developing cures and formulations
- ✓ Always check internal product temperatures when cooking or smoking meat
- ✓ Do the things you can do best and contract out work you are less skilled in, such as accounts
- ✓ **Finally:** Read sections 2.2, 6.5 and 10.2 in Volume 1: *Setting up and running a small food business*.

<sup>6</sup> A French word describing the preparation of sausages and other traditional preserved meat products, most commonly pork.

The products described in this chapter can be divided into three groups:

1. Products prepared without sodium nitrate and sodium nitrite preservatives. These are uncured and have a short shelf life if not frozen. Fresh sausages, often referred to as 'breakfast' or 'summer' sausages, pâté and hamburgers are common examples. The high moisture content of these products means that they are extremely susceptible to the growth of microbes, particularly if they are not kept under refrigeration at all times.
2. Cured meat products such as ham, bacon and low moisture dried and smoked sausages. These products have a long shelf life, which ranges from a week to several months depending on the cure used, the final moisture content and the storage conditions. The preservation of these foods depends upon the presence of nitrate and nitrite (normally as the sodium salt) together with salt and without these it would be impossible to make bacon or ham. The most important role of nitrite as a preservative is to suppress the growth of food poisoning organisms and in particular *Clostridium botulinum* – the organism responsible for the potentially fatal illness botulism. In addition it imparts special flavours, retains colour and controls the development of rancidity. Nitrite suppresses the growth of botulinum and favours the growth of other harmless micro-organisms, such as lactobacilli. These in turn increase the acidity (reduce the pH) of the food so creating an environment less favourable to botulinum.

*Under no circumstances should recommended levels be exceeded as nitrate / nitrite is toxic to humans, one gram being a lethal dose.*

3. Those that are dried to a moisture content sufficiently low to prevent the growth of micro-organisms. Dried meat or *biltong* is a well known example.

*Botulism is a frequently fatal form of food poisoning resulting from the growth of the micro-organism C. botulinum which produces a toxin. Botulinum forms spores that are commonly found in meat, vegetables and in the soil. In the spore form they are harmless and inactive. Under the conditions of high moisture, low oxygen, low acidity and temperatures between 4 and 60°C the spores will rapidly begin to grow and produce toxin. When meat is processed by cool smoking, the meat is moist, the*

smoke starves the air of oxygen and the temperatures are ideal for the growth of botulinum. For this reason a product that has not been cured with nitrate and nitrite should never be smoked.

## 4.1 Meat, the prime raw material

The relationship between the health, condition and slaughter of animals and the final meat quality has been considered in Chapter 3. In many countries meat is still regarded as 'just meat' and different cuts are not sold at different prices. The situation is starting to change, however, and prime cuts such as steak and pork chops can demand higher prices. Efficient butchery, involving dividing the carcass into individual cuts, is a skilled craft that is outside the scope of this publication, but it is very important that processors know how to separate the different cuts and are aware of their principal uses. Selecting the right cuts allows the production of higher value products, so increasing income and profitability. Figs 4.1, 4.2 and 4.3 illustrate the basic cuts of pork, beef and lamb with indications of their principal use.

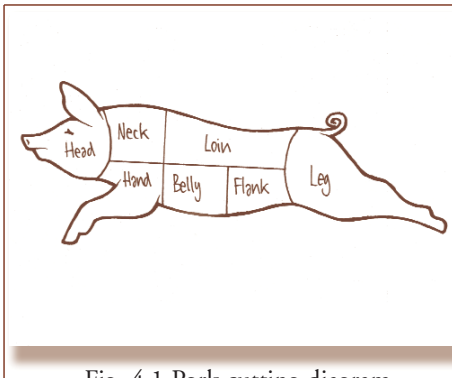

Fig. 4.1 Pork cutting diagram

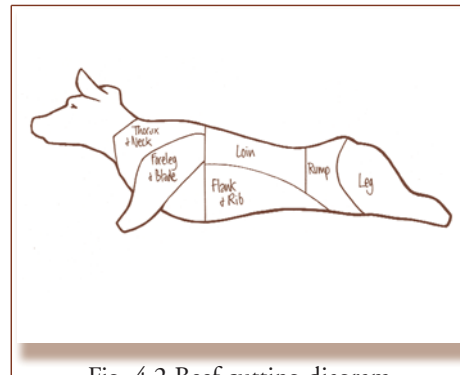

Fig. 4.2 Beef cutting diagram

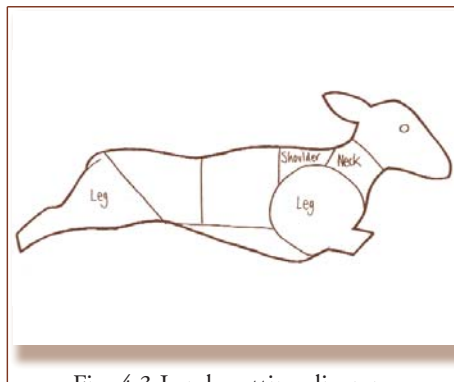

Fig. 4.3 Lamb cutting diagram

## 4.2 The processing plant

Broad guidelines on the requirements of a meat processing plant, in terms of location, construction, finish and services, have been provided in Chapter 3.

The layout and complexity of the plant will depend upon the range of products being made. A typical layout for a small unit producing only fresh sausages and burgers is shown in Fig. 4.4 while that for a more complex plant that also makes bacon, ham and dried and smoked sausages is shown in Fig. 4.5.

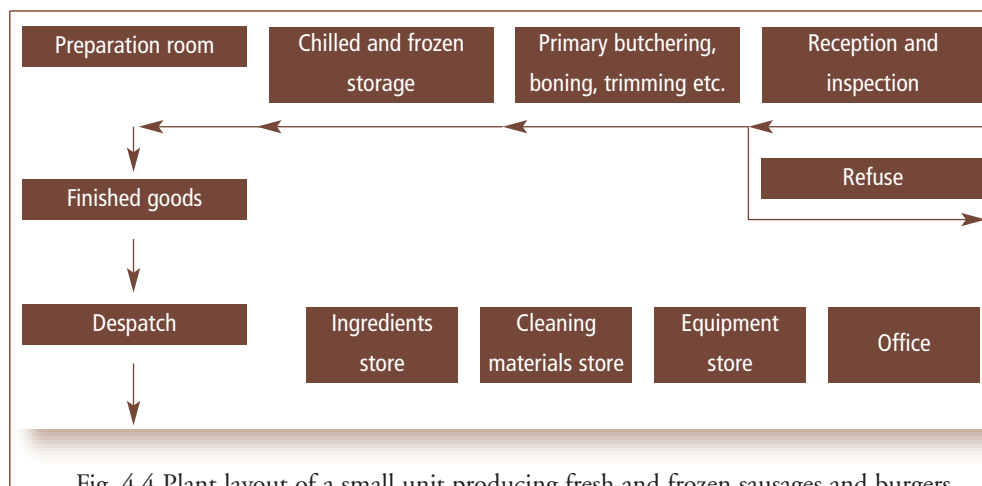

Fig. 4.4 Plant layout of a small unit producing fresh and frozen sausages and burgers

Our survey of meat processing enterprises in Africa and the Caribbean showed that a wide range of meat products was being produced. Table 4.1 summarises the products made and equipment used and Case study 4.1 gives some examples.

The following sections of this chapter examine the manufacturing of specific meat products by small- and medium-scale enterprises. The equipment needed to produce sausages is described in detail in section 4.3. Many of these items of equipment are used in meat processing in general. Additional, specialist items are mentioned in the relevant following sections.

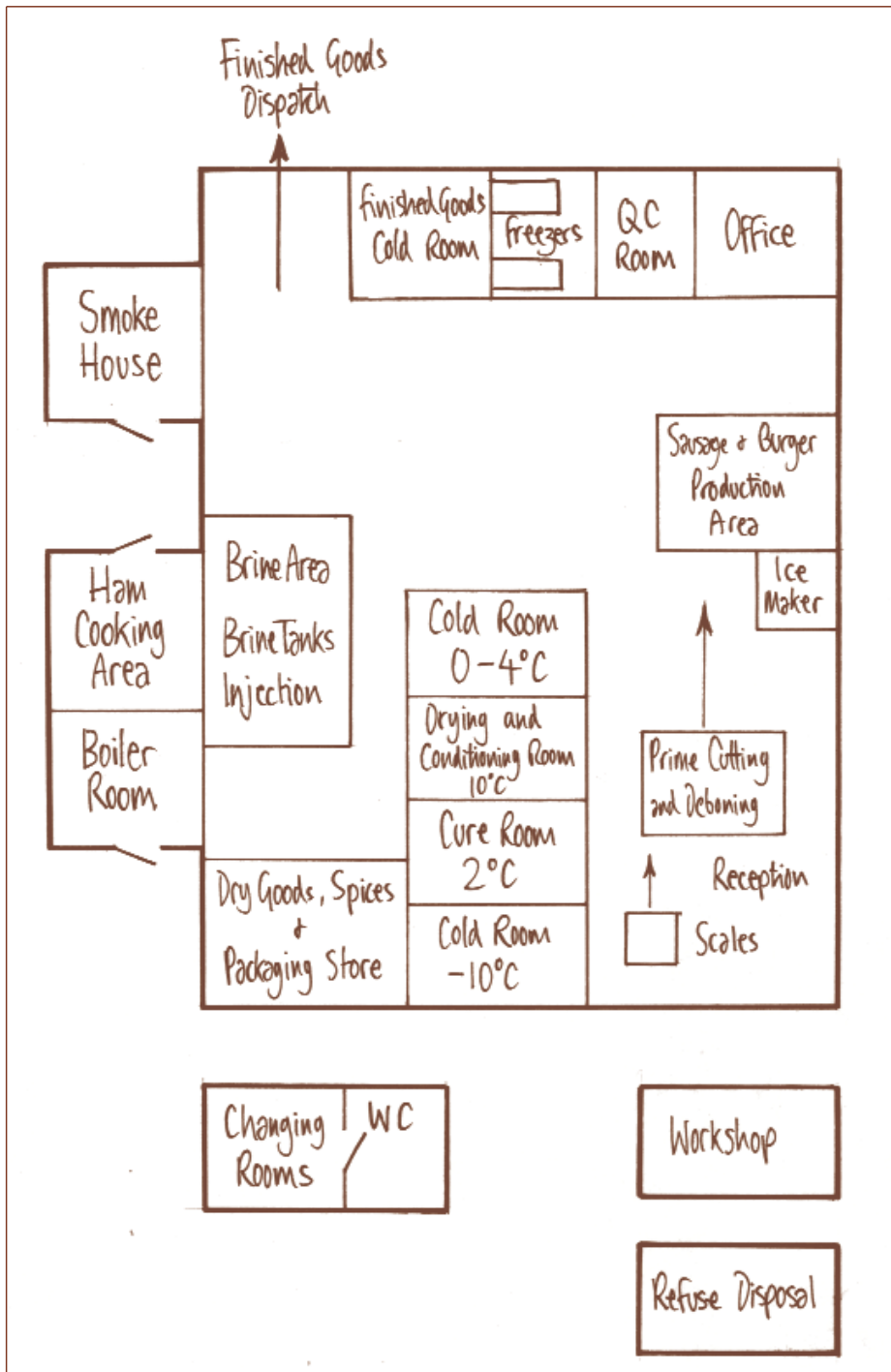

Fig. 4.5 Typical plant layout of a company producing a wide range of meat products

<b>Company</b>	<b>Tanzania</b>	<b>Ghana</b>	<b>St Lucia</b>	<b>Zambia</b>	<b>Zambia</b>
Size	Small	Large	Medium	Large	Large
<b>Product:</b>					
Fresh sausage	+	+	+	+	+
Burgers	+				
Pepperoni		+	+		
Frankfurters		+			
Ham		+	+	+	+
Bacon		+	+	+	
Meat loaf			+		
Smoked chicken				+	+
Polonies				+	+
<i>Biltong</i>				+	+
Salami		+			
Pizzas		+			
Smoked sausage					
<b>Equipment used</b>					
Abattoir	+	+	+	+	+
Mincers	+	+	+	+	
Mixers	+	+	+	+	+
Stuffer	+	+	+	+	+
Scales	+	+			
Heat sealer	+		+		+
Deep freeze	+	+			
Spice mill			+	+	+
Cold room		+			
Band saw		+			+
Bowl cutter		+	+	+	
Slicer		+		+	+
Smoker		+	+		
Tumbler		+			
Cooking ovens		+	+	+	+
Vacuum packing		+		+	
Generator		+			+
De-skinning machine		+			
Brining tanks					

Table 4.1 Products and equipment used by meat processing enterprises in Africa and the Caribbean



### **Case study 4.1 Examples of products made and equipment used**

A university in Ghana has its own commercial meat processing facility, which is used for both teaching and production. 'We have a range of facilities including an abattoir, office, cold room and an analytical and microbiological laboratory. We normally slaughter two bulls and eight pigs a week and make 100 kg of sausage and 150 kg of meat loaf a day. We have a wide range of equipment including a bowl cutter, band saw, slicer, sausage stuffers, ham tumbler and smoking chamber. The manual sausage filler was designed and built locally while many other items were imported from Germany. All equipment is made of stainless steel. Most equipment is very efficient but we do have a problem with the sausage filler. Ours can only fill one diameter of sausage but some customers prefer smaller diameter sausages, so we are currently buying a machine with small to medium dies.'

A meat processing plant in Saint Lucia was already set up with the necessary equipment when the current owner purchased it. 'Most of it was imported from Germany and we have a mincer, two smoke houses, a blender, a sausage filler, a vacuum packaging machine, two cold stores and a back-up generator. Machines have guards to prevent hands or clothing getting caught. Good lighting is important and all electrical equipment is earthed and fitted with safety switches. All processing areas are cooled and temperatures are strictly managed, so much so that we regard the stand-by generator as a standard item of equipment.'

### ***4.3 Producing fresh and cured sausages***

---

Hundreds of different types of sausage are made, principally from ground or chopped pork or beef packed in a skin or casing. Other meats (e.g. venison) are used in high value gourmet varieties.

Sausages were originally developed as a way of preserving meat, particularly when animals had to be killed due to a lack of fodder during the long, cold European winter. It was discovered that organs such as the intestines, stomach and bladder made convenient bags for the ground meat. These traditional sausages were dried, smoked and treated with salt over a period of weeks or months and

the flavours developed as a result of enzyme action and microbiological 'ripening'. Producers also discovered that the mineral saltpetre (sodium nitrate) prolonged preservation.

Many people consider that only scraps are used to make sausages. In most cases this is not true and high quality sausages can only be made from good cuts of meat. The ratio of fat to lean meat is a critical factor in sausage production as the two components form an emulsion that must remain stable during storage and cooking. For this reason it is strongly recommended that entrepreneurs starting production for the first time should closely follow established recipes. The books listed in the bibliography provide an invaluable source of recipes and tips.

### *Different types of sausage*

While sausages can be made from any cut of meat, the cheaper cuts such as trimmings, offal, head and cheek meat are used in low cost sausages. Other cuts are used to prepare more expensive, high quality products. A starch-based filler, or rusk, is often added to absorb moisture, add bulk and reduce costs (see section 3.2). Sausages can be divided into four basic groups:

- fresh sausages, which are sold either chilled or frozen. When chilled they have a shelf life of up to five days when stored at 3°C
- cooked, finely ground meat sausages that have to be re-cooked before consumption. Frankfurters or hotdogs are well known. The shelf life under refrigeration is up to five days
- semi-dry cured sausages, often of a larger diameter, that may or may not have been smoked. These have a shelf life of longer than five days under refrigeration and the shelf life can be extended to several weeks if they are vacuum packed and kept under refrigeration
- fully dried sausages, such as salami and chorizo, which have a long shelf life providing they do not absorb moisture. In many cases they are smoked. In cool, dry climates these types of sausage have a shelf life measured in weeks or even months without refrigeration. In tropical climates they should be stored under cool conditions. Many sausages in this group are cured with sodium nitrate and nitrite (see section 3.2).

The production of semi-dried and fully dried sausages involves a considerable degree of craft knowledge. Recipes are often a closely guarded secret and producers in ACP countries often have family roots or contacts in countries such as Germany, Spain or Italy (Case study 4.2).

## Case study 4.2 Acquiring the knowledge

A producer in Zambia bought an established meat processing enterprise. 'This plant was set up on a farm, out of town but on a good road, by the first owner who was an engineer. He was from Germany and we have not changed his recipes. The main equipment (a bowl cutter, mincer, sausage filler, cold rooms and a smoker) was imported. We employ 24 workers and make about 1500 kg of salami, poloni, smoked and cooked sausages, ham and *biltong* every month.'

An entrepreneur in Tanzania learned how to make sausages by attending a training course run by the Small Industries Development Organisation. 'After mobilising investment funds I had this plant built. It is 6 x 4 metres and is in the outskirts of the capital. All the main equipment was imported and I can process about 200 kg of meat a day with three workers. I only produce one line (beef sausages) at present, but when I have perfected more recipes I plan to expand.'

### Ingredients

Two ingredients used in all sausages are the casings (often called skins) that contain the meat and the herb and spice mixes that provide the characteristic flavour. In some types of sausage, particularly those originating in southern Europe, food colour is another important ingredient.

#### *Sausage casings*

Natural casings are made from intestines that are cleaned and scraped immediately after slaughter. The diameter of the casing depends on the type of animal and the particular part of the intestine used. They are sold in bundles or 'hanks', usually about 24 metres long and packed in purified salt or strong brine. As a guide, a hank of 29-32 mm casing is sufficient for 40 kg of sausage while a larger 38-42 mm hog casing will make about 65 kg of sausage.

The shelf life of natural casings under refrigeration is extremely long, but if not refrigerated they quickly develop off-odours. Casings must be washed in clean water before use. Typical specifications for common natural casings are shown in Table 4.2.

Type	Diameter (mm)	Common uses
Narrow hog	29-32	Fresh pork, beef, cumberland and frankfurters
Medium hog	32-38	Fresh pork, beef, cumberland and frankfurters
Wide hog	38-42	Fresh pork, beef, cumberland and frankfurters
Hog bungs or fat ends	50	Liver sausages
Narrow beef	35-48	Liver sausage, black pudding
Middle beef	45-55	Salami, knackwurst
Large beef bungs	75-150	Large bologna types
Narrow sheep	16-18	Chipolatas, frankfurters
Middle sheep	18-20	Wieners and hotdogs

Table 4.2 Common natural casings

The International Natural Sausage Casing Association (INSCA) has over 200 members in 27 countries and is able to provide useful information on the availability and use of natural casings. Their contact details can be found in Appendix I.

Synthetic casings are made from cellulose, collagen (a protein substance extracted from beef hide) and plastic and are available in a wide range of diameters. Both cellulose and collagen casings are edible. Collagen casings are available in two basic grades – one of which is so thin as to be almost invisible on the outside of a sausage. This is ideal for fresh breakfast sausages. If the product is to be cooked or smoked, a thicker grade of collagen casing with greater strength must be used to ensure the sausages withstand handling without the skin rupturing. Coloured skins are also available and provide an inviting ‘smoked’ appearance. Storage below 10°C is recommended for collagen casings, which should be soaked in lightly salted lukewarm water before use.

Many dried, cured and smoked large diameter sausages that are sliced before consumption (e.g. salami) are packed in plastic casings which have to be removed before consumption. These are available in a wide range of sizes

and colours and can be printed. A well designed printed casing can provide customer appeal and increase sales (see Fig. 4.6).

Coloured casings make a particular type of sausage instantly recognisable, for example black (for black or blood pudding) or pink (for liver sausage).



Fig. 4.6 Attractive printed sausage casing (Photo: B. Axtell)

The handling and filling or 'stuffing' of casings requires skill and practice. The basic steps, illustrated in Fig. 4.7, involve:

1. Wash and prepare the casing and leave it immersed in water in a container with a 'tail' over the edge so that it can be picked up easily
2. Feed the skin onto the sausage stuffer nozzle
3. Tie off the end
4. Fill the skin under pressure allowing the sausage to form a large coil on the table
5. Remove from stuffing machine
6. Twist the sausages into appropriate lengths. This is called linking and involves great skill if the sausages are to be sold in packs of eight with a net weight of exactly 500 g.

Large manufacturers use automatic linking machines to produce packs of a standard net weight. These machines are very expensive and small enterprises tend not to produce standard weight packs. Instead, they check weigh each pack and apply a label stating the exact weight. This means that each pack has to be individually weighed and priced. Special computer-controlled scales linked to a label printer are available at moderate cost that automatically produce a priced label for each pack (Fig. 4.8).



Fig. 4.7 Basic steps in filling sausage casings  
(Photo: B. Axtell)



Fig. 4.8 Automatic net weight label printer (Photo: B. Axtell)

### *Seasonings*

Seasonings are very important, as they give different types and brands of sausage their particular appeal and individuality. Fresh herbs are recommended, when possible, as drying always results in a certain loss of flavour. This is particularly true of parsley, mint and garlic. Herbs and spices that are widely used in processed meats are shown in Table 4.3.

Common name	Botanical name	Characteristics	Use
Allspice	<i>Pimenta officinalis</i>	Round, slightly peppery	Pepperoni, blood sausages
Aniseed	<i>Pimpinella anisum</i>	Slightly sweet, pungent	Wide range of sausages
Bay leaves	<i>Laurus nobilis</i>	Subtle mellow	Widely used in marinades and pâtés
Caraway	<i>Carum carvi</i>	Resembles liquorice	General seasoning
Celery seeds	<i>Apium graveolens</i>	Celery-like	Many types of sausage
Chilli pepper	<i>Capsicum</i> spp	Hot, pungent	Hot spicy sausages such as chorizo
Cloves	<i>Caryophyllus aromaticus</i>	Very strong	Widely used, often to decorate surface of pâtés and hams
Coriander seeds	<i>Coriandrum sativum</i>	Sweet, pungent	Especially in Indian type sausages
Curry powder	Ground product of many spices	Blends from mild to very hot	Indian and spicy sausages
Garlic	<i>Allium sativum</i>	Strong, almost onion-like	Very wide use
Ginger	<i>Zingiber officinale</i>	Aromatic	Some types of salami and bratwurst
Mace	<i>Myristica fragrans</i>	Rich, smooth, expensive	Many wurst sausages

Table 4.3 Herbs and spices commonly used in processed meats

Herbs, spices and colours should never be added individually to the sausage mix. The quantities are so small that it is impossible to mix them evenly into the batch. For this reason commercial blends are made up with a filler, such as salt, to provide bulk and allow even mixing. Typically, around 30-40 g of seasoning is added to each kg of sausage meat. Some common seasoning mixes are shown in Table 4.4.

Composition	Mix 1	Mix 2	Mix 3
Salt	66 g	80 g	70 g
Ground white pepper	30 g	15 g	16 g
Ground mace	1.75 g		2 g
Ground nutmeg	1.75 g		2 g
Ground cayenne powder	0.5 g	1 g	
Ground sage		2 g	3 g
Ground ginger		2 g	4 g
Ground cloves			3 g

Table 4.4 Examples of fresh sausage seasoning mixes

## *Colourings*

Red colouring is commonly added to sausages such as dry salami and Spanish chorizo. Only food grade colours can be used and should be declared on the label. These special colours will need to be imported. Suppliers should be asked to supply information on the use and storage of colours. As only small quantities are used, the colouring should be blended into the seasoning mix to ensure thorough distribution in the sausage meat. Colours may be natural, nature-identical (synthetic but chemically identical) or artificial. Commonly used colours are shown in Table 4.5. Red G2 is the most widely used colour as it is stable to sulphur dioxide, a preservative used by some larger manufacturers, and it does not discolour when exposed to light.

<b>Colour</b>	<b>E number</b>	<b>Type</b>
Curcumin	E 100	Natural
Carmine or cochineal	E 120	Natural
Ponceau 4R	E 124	Artificial
Red G2	E 128	Artificial
Allura red	E 129	Natural and artificial
Caramel	E 150	Nature-identical
Carotene	E 160a	Natural
Paprika extract	E 160c	Natural
Beetroot red	E 162	Natural

Table 4.5 Permitted colours (UK Food Regulations, 1995)

## *Equipment*

The production of fresh sausages is a simple process and requires the following basic items of equipment:

- knives and cutting boards
- band saw
- meat mincer
- bowl chopper
- sausage stuffing or filling machine
- vacuum packing machines
- food smoker



- food mixer
- freezers
- electronic thermometer
- scales
- hog clip pliers
- covered containers and buckets
- cooker
- spray gun.

### *Good quality knives and cutting boards*

In many countries wooden cutting surfaces have been replaced by food grade plastic cutting boards. This may be enforced by law to avoid the possibility of splinters of wood getting into the product. Boards should be thoroughly washed every time they are used and sanitised with a detergent to remove fat and chlorinated water at the end of each shift. Allow them to air-dry instead of drying with a cloth to reduce contamination. Only stainless steel knives should be used.

### *Band saw*

Band saws are widely used in larger meat processing plants to butcher the carcass. The continuous ribbon blade of the band saw will rapidly cut through bone (Fig. 4.9).

*Band saws are very dangerous machines and must be correctly situated, maintained and guarded. Workers must be trained to use them correctly.*



Fig. 4.9 A small band saw (Photo: R. Zulu)

## *Meat mincer*

Meat mincers can be manual or electric and have a range of perforated cutting plates that allow coarse or fine mincing. Meat is fed into the hopper and fed forward by a revolving screw to the rotating cutting blade. It is then pushed through the perforated plate (Fig. 4.10).

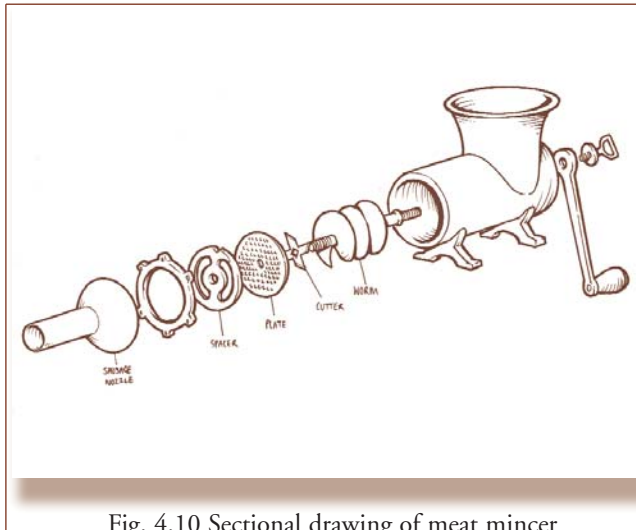

Fig. 4.10 Sectional drawing of meat mincer

Small hand operated mincing machines can grind around 2 kg of meat per minute. The use of the correct perforated plate is vital if the required texture is to be achieved.

Commonly used sizes are 2, 3, 5, 8 and 13 mm. Stainless steel mincers, while more expensive, are preferable as they do

not corrode. If cheaper mild steel machines are used it is very important that all parts are thoroughly dried and oiled with vegetable oil after cleaning to prevent rust.

For small-scale production the meat mincer can also be used to stuff or fill sausage casings by attaching a sausage stuffing nozzle. Spacer plates will be required to allow the ground meat and spice mix to flow into the casing. The perforated plate should be removed and replaced with the spacer. Powered machines will be required for higher outputs. An example of an electric model with a capacity of 70 kg/hour is shown in Fig 4.11. Note the clean tiled walls, the operator is wearing an apron and her head is covered, and the meat is being fed into the mincer with a pusher rather than the hands.

*Meat grinders can be dangerous. Always make sure the power is off before changing cutters and plates. Always use the tool provided to push meat into the machine. Never use your fingers.*

### *Bowl chopper*

While not essential, a bowl chopper is an extremely useful item for larger-scale production as it can chop and grind meat in a few minutes. A bowl chopper consists of a shallow rotating stainless steel bowl that feeds the meat under sharp rotating knives. It can act as both a chopper and a mixer. It is very important that the cutting blades are kept sharp. The mechanical action generates considerable heat and the addition of ice, or iced water, is normally required to keep the meat temperature down. A small bowl chopper is illustrated in Fig. 4.12.

*Bowl choppers can be extremely dangerous if not used according to the manufacturer's instructions. Staff must be trained and checked to ensure they are following instructions.*



Fig. 4.11 Electric meat mincer (Photo: L. Gedi)

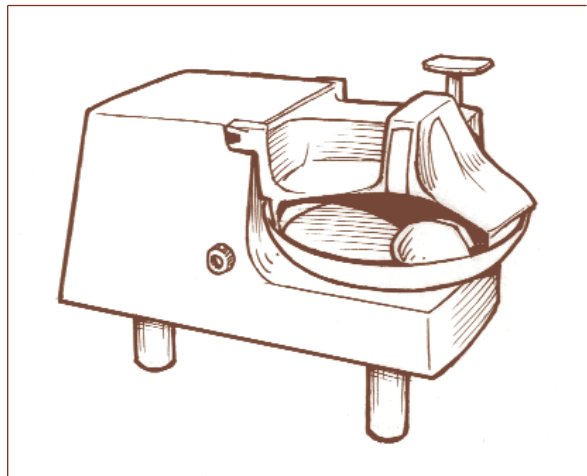

Fig. 4.12 Small bowl chopper

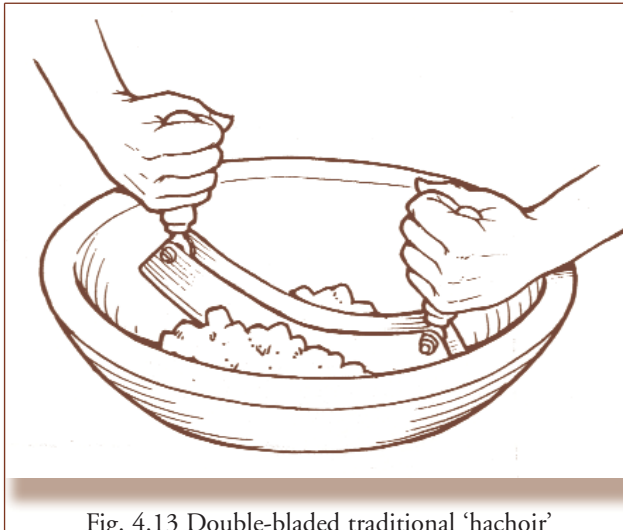

Fig. 4.13 Double-bladed traditional 'hachoir'

Small-scale meat producers can also finely chop meat by hand using a double-bladed curved knife known as a 'hachoir' (Fig. 4.13). Prior to the introduction of powered choppers, this traditional knife was widely used by French meat processors in conjunction with a shallow, bowl-shaped wooden board.

### *Sausage stuffing or filling machine*

This consists of a piston inside a cylinder that pushes the sausage mix through a nozzle into the casing. Powered models are preferable as both hands are left free to manipulate the casing as it fills. The use of a stuffer rather than a mincer to make sausages is recommended as less heat is generated by friction and the mix remains cooler.

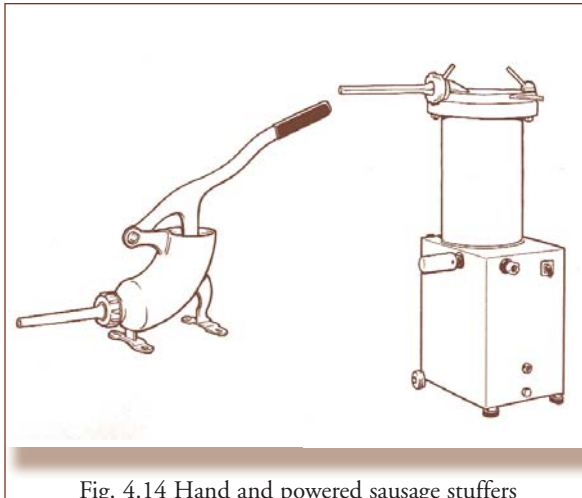

Fig. 4.14 Hand and powered sausage stuffers

It is important when buying a stuffer to make sure it is supplied with a selection of different diameter filling nozzles to allow the production of different diameter sausages, from small chipolatas up to large diameter salamis. Examples of hand and powered stuffers are given in Fig. 4.14.

### *Vacuum packing machines*

These have found increasing use in the meat industry and it is estimated that in the United States up to 80% of beef leaves the packing plant in vacuum packs. Vacuum packing uses special, heavy gauge plastic film through which air cannot pass. The food is placed in a plastic pouch, the air is extracted and a heat seal is formed. Vacuum packing suppresses the growth of many spoilage organisms, so extending the shelf life of the food by a factor of three to five times the normal refrigerated life.



Fig. 4.15 Tabletop vacuum packing machine  
(Photo: B. Axtell)

After the moist air is removed and the pouch is sealed, oxygen levels fall while carbon dioxide levels rise, conditions that inhibit the growth of many spoilage organisms. Vacuum packed meats must still be kept under chilled conditions (ideally 0°C).

In cured meat products vacuum packing provides the following advantages:

- microbial growth is reduced due to the lack of oxygen
- the lack of oxygen retains colours
- moisture loss or uptake is eliminated
- packs are convenient for display and allow hygienic handling during distribution.

A typical tabletop vacuum packaging machine is shown in Fig. 4.15.

*It should be noted that the conditions of vacuum packing (lack of oxygen and high moisture) are ideal for the growth of the dangerous food poisoning organism Clostridium botulinum. As previously mentioned, the growth of this organism is controlled by the use of nitrates and nitrites in meat cures. Given the unreliability of the cold chain in many ACP*

*countries, it is strongly recommended that meat that has been cured with nitrate and nitrite should only be vacuum packed if a cold chain at 0 to 3°C can be guaranteed. It is suggested that entrepreneurs considering vacuum packing should consult local specialists.*

### *Food smoker*

A food smoker is a key item of equipment that allows producers to extend the range of products beyond those containing only fresh meat. Smoke is generated by the smouldering of selected fuel, most commonly hardwood sawdust.

*Resinous woods, such as pine, should not be used as they give rise to unpleasant flavours.*

Two basic designs are used:

- convection or natural draught smokers
- forced draught smokers.

Convection or natural draught smokers depend on the tendency of warm air to rise. Such smokers may have an external smoke generator as shown in Fig. 4.16. Alternatively, the smoke may be generated in the base of the smoking chamber as shown in Fig. 4.17, which shows a smoker that has been made from an old refrigerator. Old refrigerators can be readily made into smokers

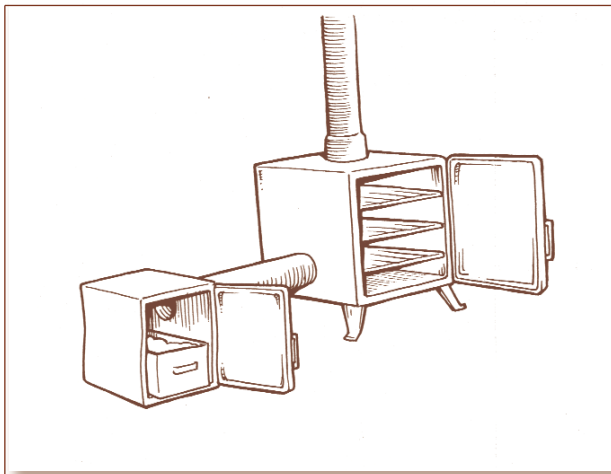

Fig. 4.16 Natural draught smoker with external firebox

by removing the compressor, cutting a vent in the top and fitting an adjustable air entry vent in the base. It is recommended that the door lock of a converted refrigerator should be removed as there is always a danger that small children at play might become trapped inside.

Temperature and smoke density can be controlled by adjusting the supply of air to the smouldering fuel. The smoker should have a small opening through which the probe of an electronic thermometer can be passed to allow monitoring of the product temperature. Convection smokers are simple, cheap and can be constructed locally in most ACP countries.

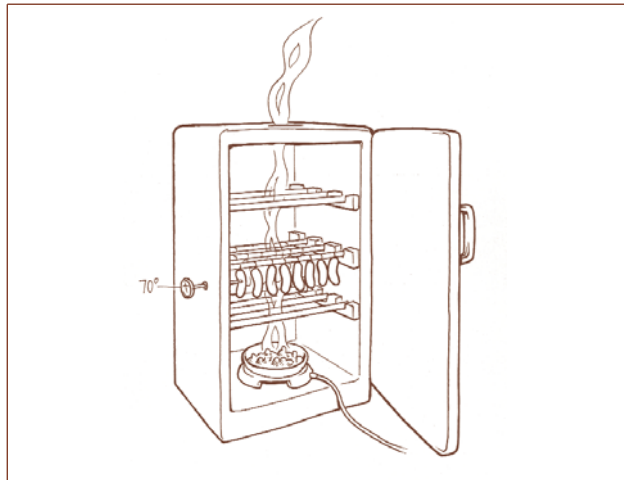

Fig. 4.17 Internal smoke production in a smoker made from an old refrigerator

Forced draught smokers have a fan mounted either between the fire-box and the smoking chamber or in the chamber chimney. Forced draught smokers allow a far greater degree of control over the four key factors required for efficient smoking: time, temperature, airflow and product moisture content. They are commonly fitted with thermostats that control the chamber temperature and smoke density. Smoke generator kits are available, with all controls, which can be linked to a locally constructed smoking kiln.

Two methods of smoking are used in meat processing: cold and hot smoking. When cold smoking is used, the product is not cooked and its temperature will be in the range of 18-32°C. Cold smoking does not greatly contribute to preservation but adds colour, flavour and aroma. Hot smoking cooks the meat and adds flavour, colour and aroma. Typical hot smoking temperatures are in the range of 70-80°C. During hot smoking the product loses moisture and preservation is enhanced. All smokers should be fitted with a small port that allows the probe of an electronic thermometer to be inserted into the product to monitor temperatures, so avoiding opening the door of the chamber.



Many manufacturers use liquid smoke to reduce costs. Liquid smoke is produced by condensing smoke from selected hardwoods. It is highly concentrated – only around 5 ml is required to treat 2 kg of meat. The liquid smoke is diluted in water or brine and the meat product is allowed to marinade. This product is available from specialist firms that supply the meat trade and will probably have to be imported into ACP countries.

### *Other equipment*

A large electric food mixer is useful for preparing flavouring, preservative and colour pre-mixes and for blending these into the sausage mix.

A means of ensuring efficient chilled storage at 3°C or below is essential. Deep freezers are needed for storing meat, finished goods and ice. Make sure that raw meat is not stored with finished goods or ice.

An electronic thermometer is useful for measuring temperatures during processing and fridge and freezer thermometers are needed to monitor chill storage conditions.

At least two sets of scales are required. One is needed for weighing large quantities of meat and another, accurate to at least 5 g, for weighing out minor ingredients. Scales should be easy to clean, check and adjust.

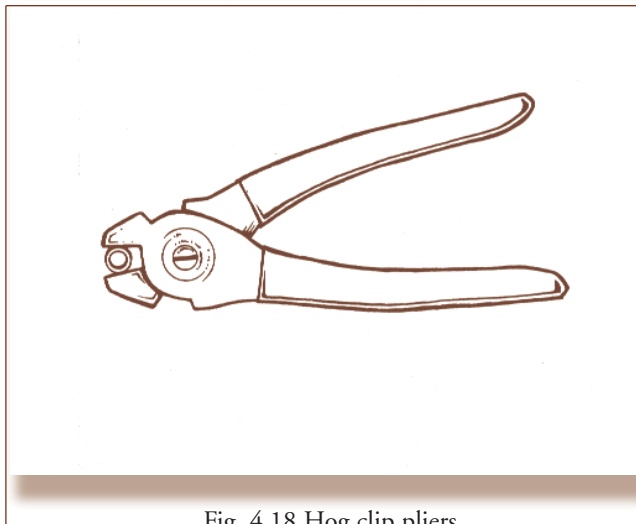

Fig. 4.18 Hog clip pliers

If large diameter salami types of sausage are to be made, a small hand machine (Fig. 4.18) will be needed to crimp the metal hog clips and close the end of the sausage.

Covered containers and buckets will be required to hold meat, ingredients and casings. Ideally these should be



made of stainless steel but food grade plastic containers are a cheaper option. If large quantities of meat are to be handled, containers mounted on a frame with wheels will assist production. All containers should be clearly marked, for example 'MEAT', 'SEASONINGS', 'CASINGS' etc. and must not be used for any other purpose.

A cooker will be required if cooked sausages, such as frankfurters, are to be produced. Shallow pans are preferred and they should have a plate that can be weighed down to ensure all the sausages are submerged while cooking.

A spray gun that can provide a gentle fine spray of cold water is very useful for rapid cooling of products that have been boiled or smoked.

### *Making sausages*

All meat must be fresh and either chilled to 3°C or frozen. Freezing often allows meat to be purchased at a good price in bulk and has been shown to have no effect on the quality of the sausages made. Meat should be thawed in a refrigerator at 3-5°C, as thawing at room temperature produces a large amount of blood and represents a loss of yield.

All equipment must be thoroughly clean and preferably chilled, for example by passing ice (made from potable water) through the mincers and choppers. The key to making good sausages is maintaining low temperatures.

The meat is ground through a coarse mincer plate (usually 9 mm aperture). Fatty meat should, as far as possible, be minced after separation from lean meat. The friction of the mincing process generates heat and it is important that the mix is kept cold. This can be achieved by the occasional addition of a little ice or iced water.

The minced meat is then placed in the bowl mixer together with the seasoning mix and other ingredients such as rusk. If a powered bowl mixer is not available the mix can be blended by hand in a large bowl. Again, ice or cold water should be added to keep the mix cool. At this stage it is recommended that the mix is placed in a refrigerator to chill.

The next stage is to fill the sausage casings using the sausage stuffer. Care should be taken to avoid air pockets. If these do occur they can be punctured with a pin. Finally, the sausages are 'linked' by twisting them and they are



Fig. 4.19 Over-wrapping sausages with shrink film  
(Photo: B. Axtell)

divided into the chosen pack size. After over-wrapping (Fig. 4.19) they must be refrigerated or frozen immediately.

Large diameter sausages (up to 90 mm in diameter) include many types of dried sausage such as salami and high moisture liver sausage and black pudding. The production process uses the same equipment as

for fresh sausages. In many cases the meat is not ground in a mincer but finely chopped in a bowl cutter or by hand with a hachoir to produce a coarse texture. The casings are tied with string or metal hog clips.

Salami types of sausage are soaked in strong brine for one or two days and then air dried for up to 12 days. They may then be smoked. Many low moisture sausages are over-wrapped in muslin or mesh. Typical examples are shown in Fig. 4.20.



Fig. 4.20 Low moisture slicing sausages (Photo: B. Axtell)

## Sausage recipes

Sausage making, while apparently simple, offers many alternatives. The product can be sold fresh or frozen, it can be poached or boiled and then partly dried, or cured in brines or with sodium nitrate and then dried. Sausages may be smoked and perhaps further air-dried and cured to make a product with a very long shelf life. It is this range of alternatives that provides so many opportunities in a comparatively new food area in ACP countries. It is very important that entrepreneurs who wish to succeed read, learn and experiment with new recipes and techniques. Some of the books listed in Appendix I are, despite their high cost, valuable sources of ideas and recipes that will promote the development of new products.

Many of the recipes originated many years ago in the United Kingdom and the United States when imperial, not metric, weight and volume measures were used. Also at this time it was common to measure minor ingredients in spoons and cups. It will thus be necessary to convert the recipes to the metric system and guidance conversions are shown in Table 4.6.

<b>Imperial measure</b>	<b>Exact conversion</b>	<b>Approximate conversion</b>
1 oz	28.3 g	30 g
16 oz = 1 lb	453.6 g	450 g
1 fluid ounce	29 ml	30 ml
1 pint = 16 fluid ounces	473 ml	470 ml
1/4 teaspoon	1.2 ml	1 ml
1 teaspoon	4.7 ml	5 ml
1 tablespoon	14.2 ml	15 ml
1/4 cup = 4 tablespoons	56.8 ml	50 ml
1 cup	227.3 ml	225 ml

Table 4.6 Imperial to metric conversion factors

The flow diagram in Fig. 4.21 demonstrates the range of processing alternatives in sausage production.

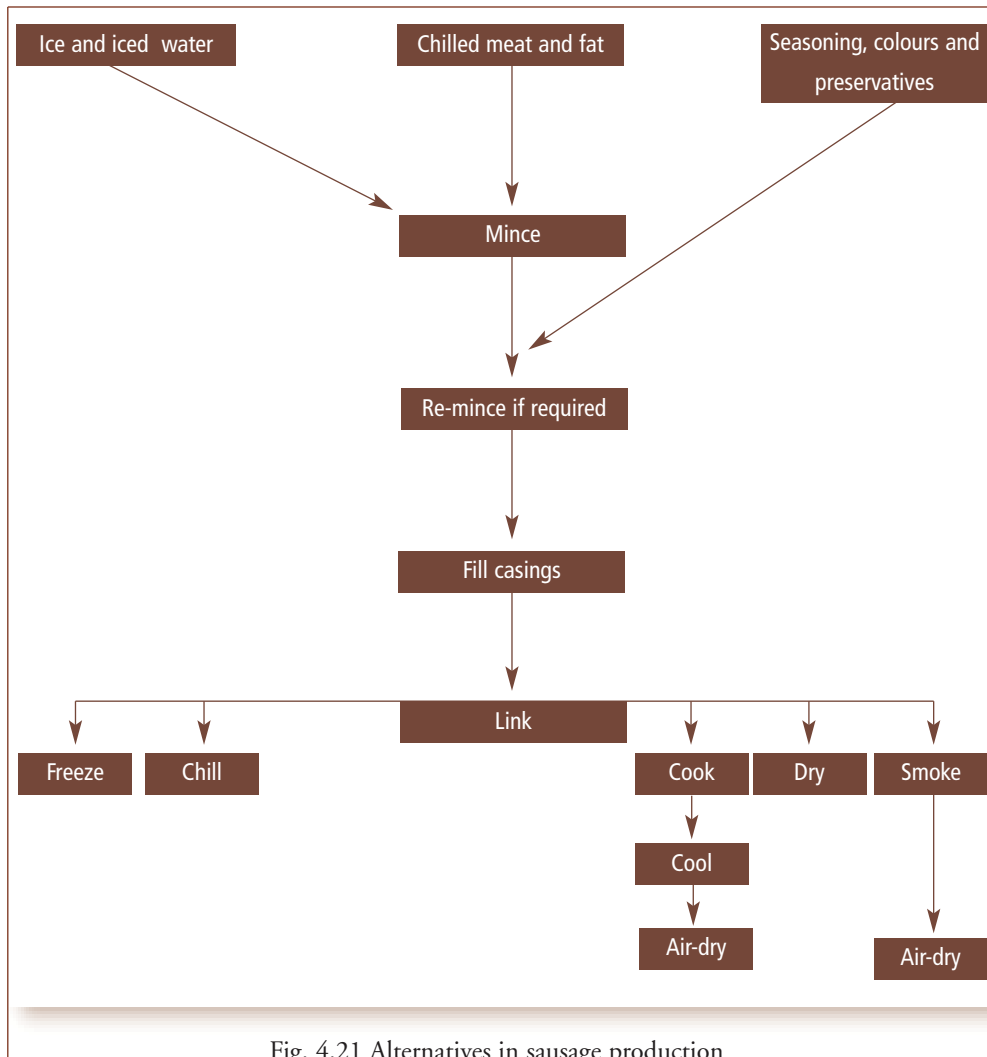

Fig. 4.21 Alternatives in sausage production

A very wide range of recipes will be found in books listed under further reading, particularly those related to charcuterie. This section ends with some typical examples of production methods for common types of sausages: fresh, cooked, dry-cured and smoked. These are shown in Figs 4.22 to 4.26.

### English beef sausages

Yield 4.5 kg

Ground beef, 20% fat	4.5 kg
Iced water	475 ml
Salt	15 g
Fresh sage	6 g
Fresh thyme	2 g
Ground cloves	0.5 g
Ground nutmeg	1 g
Dry onion powder	1 g
Dry parsley	1 g
Hog casings	32-35 mm

#### Method:

1. Put water into a container together with seasoning ingredients. Mix. Add this to the meat, mix well and chill for one hour
2. Grind mix through a 0.31 cm plate and chill again
3. Stuff into prepared casings and tie into 8 cm links
4. Refrigerate or freeze

Fig. 4.22 Recipe for traditional breakfast sausages

### Frankfurters

Lean pork	3.8 kg
Pork back fat	675 g
Dry diced onion	450 g
Minced garlic	57 g
Salt	85 g
Ground coriander	57 g
Ground mace	43 g
Ground white pepper	43 g
Caraway seeds	28 g
Dextrose or sugar	57 g
Rusk (dry white breadcrumbs)	284 g
Reconstituted dried milk powder	700 ml
Hog casings	32-38 mm

#### Method:

1. Blend seasonings, rusk and milk in a food processor until smooth. Chill
2. Grind pork and fat through a 0.9 cm plate and then through 0.6 cm plate
3. Add seasoning mix and mix well
4. Blend the mix in a food processor. Cover and chill
5. Stuff into prepared casings and tie into 10-20 cm links
6. Poach in simmering water keeping all links submerged for about 18 minutes and until the internal temperature reaches 75°C
7. Cool with cold water spray, pack and refrigerate at below 4°C

Fig. 4.23 Recipe for frankfurters

### Liver sausage

#### Method:

Pork liver	4.5 kg	1. Grind liver through a 0.95 cm plate
Salt	28 g	2. Add salt and seasonings and mix well
Ground white pepper	14 g	3. Re-grind through a 0.15 cm plate while slowly adding
Cayenne pepper	3.5 g	the iced water
Ground ginger powder	14 g	4. Stuff casings and tie into 10 cm links
Iced water	475 ml	5. Poach, fully submerged, to an internal temperature of
		75°C
Sheep or synthetic casings	32-35 mm	6. Hang to dry and wrap
		7. Refrigerate

Fig. 4.24 Recipe for a typical liver sausage

### German smoked sausage

A cured smoked variety

#### Method:

Mix of pork and veal trimmings	4.5 kg	1. Grind meat through a 0.9 cm plate
Salt	28 g	2. Add seasoning and mix well
Ground black pepper	14 g	3. Dissolve Prague powder in the iced water and set aside
Ground mace	7 g	4. Grind mix through a 0.3 cm plate
Ground ginger	2 g	5. Add the iced water and mix well
Ground nutmeg	7 g	6. Stuff casings and form into 13 cm links
Sage	7 g	7. Place sausages in smoker pre-heated to 57°C and
Prague powder No.1 (sodium nitrate in salt)	10 g	slowly raise the temperature over a 3-hour period to
Iced water	475 ml	74°C
Casings	32-35 mm	8. When internal sausage temperature reaches 68-70°C
		remove and cool with a spray to a temperature
		below 38°C
		9. Refrigerate

Fig. 4.25 Recipe for German smoked sausage

### Mexican chorizos

A spicy dry-cured smoked sausage. The preservation depends on the presence of the nitrate-nitrite delayed action cure. The recipe calls for several changes in temperature during smoking.

		<b>Method:</b>
Lean pork	3.4 kg	1. Mix salt, sugar, Prague powder, seasonings and red wine. Allow meat to marinate for 4 hours
Pork back fat	1.1 kg	2. Coarsely grind meat and fat. Mix well with the marinade
Coarse salt	12 g	3. Stuff casings and link in 13-15 cm lengths. Hang links on smoke stick
Sugar	13 g	4. Pre-heat smoker to 21°C. Add sausages and heat until internal temperature rises to 24°C. Hold for 72 hours in smoker
Prague powder No.2	28 g (measure accurately)	5. Increase smoker temperature to 43°C and hold for 12 hours
(salt plus sodium nitrate and sodium nitrite)		6. Increase smoker temperature to 46°C for one hour. The internal sausage temperature must be above 43°C
Ground cumin	4 g	7. Remove, cool and wrap. Vacuum packing is best
Turmeric	5 g	8. Refrigerate
Basil	2 g	
Cayenne pepper	5 g	
Minced garlic	5 g	
Cheap red wine	600 ml	
Finely chopped hot red peppers	5 g	
Finely chopped sweet red peppers	5 g	
Hog casings	38 mm	

Fig. 4.26 Recipe for spicy Mexican sausages

## 4.4 Producing hamburgers

Hamburgers are normally made from minced beef, although pork and chicken can also be used. Lean meat is minced in a power mincer and seasoning added according to local preferences. As with sausages, careful selection of herbs and spices will give a particular brand of hamburger a unique flavour and appeal, distinguishing it from others in the market. In some cases, up to 20% rusk filler is added to reduce costs and help bind the meat. In many countries the total and lean meat contents are subject to legal regulations; these are outlined in Chapter 6.

In small- and medium-scale plants, hamburgers are formed using either a simple hand-held mould or a hamburger patty machine, as shown in Fig. 4.27. The patty machine allows the burgers to be efficiently packaged in a cellophane over-wrap. Pressure on the lever of the machine compresses the meat and as the lever returns the press opens automatically and removes the formed burger. Electric moulders are available if high outputs are required.

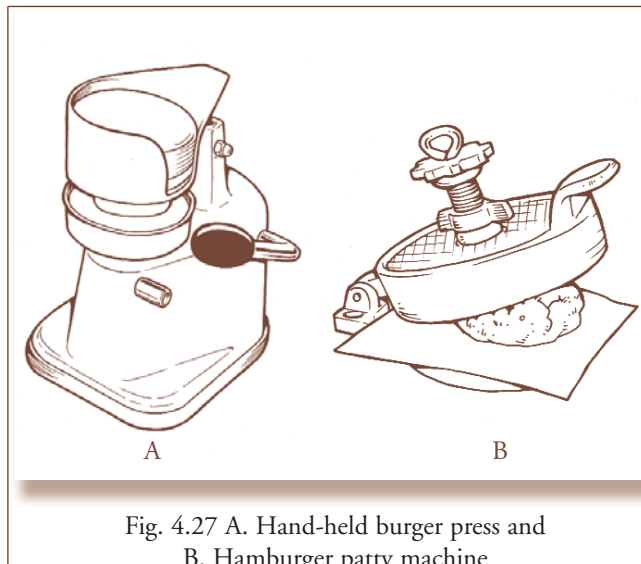

Fig. 4.27 A. Hand-held burger press and B. Hamburger patty machine

If not using a patty machine, the formed hamburgers are then placed onto squares of thin plastic film. They are generally sold in plastic bags containing 6 or 12 hamburgers. The bags should be closed with tape using a bag sealer. The bags should be clearly labelled with all legally required information and, very importantly,

the brand name and use-by date. The brand name is essential so that, if consumers like the quality, they can easily buy your brand again. The product should be refrigerated or deep-frozen.

## *4.5 Producing pâtés and terrines*

---

Pâtés are made from ground meat with a high fat content and they commonly contain liver. The high fat content is important both to bind the mix and to protect the product from air. Some recipes use fillers such as bread to reduce costs but this does result in a loss of flavour. The fat in pâté comes from the cut of meat used or from added pork, usually belly of pork. Many recipes also use butter, which adds a distinct aroma and flavour. Bacon is often added in thin strips to decorate the surface and provide flavour. When bacon is used the pâté retains a good pink colour due to the presence of nitrate used in the bacon curing process.



When selecting meat for pâté, it is important to choose good quality cuts with no gristle and sinews because these will not soften, even during the slow cooking process involved. As for making sausages, it is vital that the meat is kept cool (about 4-6°C) while the mix is being prepared. Mincers should be cooled with ice before use. Many pâtés consist of a mix of finely ground meat, produced using fine mincing blades, and coarse ground or chopped meat, produced by coarser blades. Adding a spice and herb seasoning adds a distinctive flavour. Many recipes call for the meat to be marinated in wine, rum or cognac before mincing.

The best way to cook pâté is in a 'bain-marie', a water bath that provides even heating and avoids burning. The containers of pâté are placed in the bain-marie and cooked in an oven at 160°C. The top surface should be covered with either aluminium foil or grease-proof paper as shown in Fig. 4.28. It is very important that the water does not touch the product. The most common containers used for cooking pâtés are metal loaf tins or glazed ceramic containers. It is important to check that the glaze used is lead free as lead is toxic.

Pâté is normally cooked for 40 to 60 minutes depending on the size, after which it should be rapidly cooled in a shallow bath of cold water. Very often the surface of the pâté is sealed with gelatine after cooking, principally to protect it from the air but also to enhance the appearance. This type of sealing prevents oxidation and darkening and also provides protection from

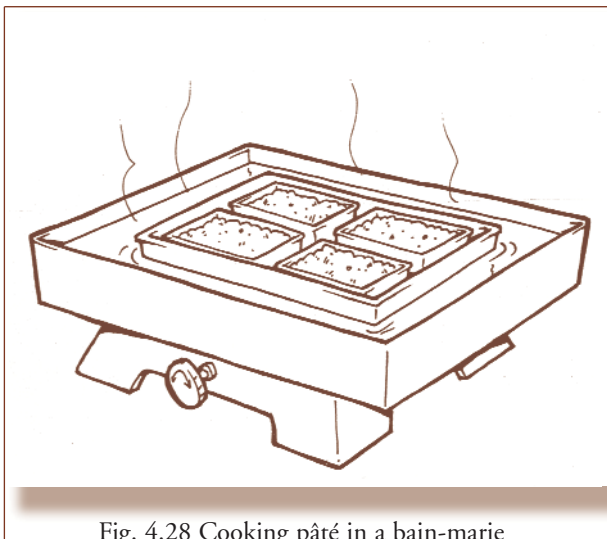

Fig. 4.28 Cooking pâté in a bain-marie

air-borne organisms. Thin slices of orange or lemon together with decorative bay leaves may be placed in the gelatine glaze. This type of decoration

enhances the visual appeal and adds further protection. The orange or lemon increases the acidity of the glaze and inhibits the growth of micro-organisms.

Pâtés are high value, gourmet products and good presentation is very important. Frequently a small amount of brandy or red wine will be added and this should be marked prominently on the label to aid marketing. Pâtés may be presented in pottery dishes, which suggest they are 'traditional' or 'home-made' when displayed in the delicatessen section of a store. They may be cut to the requirement of the individual consumer or packed in portions.



Fig. 4.29 Pâtés, showing high quality packaging and presentation

Pâtés can also be made from fish (see Chapter 5). Specialist vegetarian pâtés, normally based on mushrooms and butter, are also produced to meet the needs of this market sector. Examples of typical pâtés are shown in Fig 4.29.

Pâtés are short shelf life products that must be kept in chilled storage. An uncut, high fat pâté will have a shelf life of

up to two weeks under refrigeration. As soon as it is cut, and the surface is exposed to air, the shelf life is reduced to two or three days. Pâtés are eaten without cooking and thus carry a very high public health risk. Producers should make sure that pâtés are never displayed together with raw products in order to control cross-contamination. Two typical pâté recipes are shown in Fig. 4.30.

**Basic pork pâté**

Minced pork 5 kg	Preheat oven to 160°C. Mix meats together, add other ingredients and mix well. Transfer mix to loaf tins (500 g or 1 kg). Place, covered, in a bain-marie in oven and bake for 1-1 1/4 hours (500 g) or 1 1/2- 1 3/4 hours (1 kg). Refrigerate when cool.
Minced veal 5 kg	
Streaky bacon, finely minced 2.5 kg	
Dry white wine 1.5 litres	
Chopped cloves of garlic 10	
Dried thyme 50 g	
Dried rosemary 50 g	
Finely chopped fresh parsley 150 g	
Dried breadcrumbs 300 g	
Salt and pepper to taste	

**Chicken liver pâté**

Chicken livers 2.5 kg	Melt butter and gently cook onion and garlic until soft. Add chicken livers and cook for 5 minutes. Cool slightly and then liquidise. Add other ingredients. Pour into containers and refrigerate.
Butter 500 g	
Finely chopped onion 500 g	
Cloves of garlic, finely chopped 10	
Sherry or brandy 150 ml	
Salt and pepper to taste	

Fig. 4.30 Typical pâté recipes

## *4.6 Producing bacon*

Bacon is made from cuts of pork that are cured in brine or by dry salting. Bacon is sold either smoked or unsmoked (green). The traditional method of curing bacon, known as the Wiltshire cure, involved dry curing of the de-boned sides followed by heavy smoking, normally carried out by hanging the cured side of meat inside the chimney of the house. While such traditionally produced bacon had a shelf life of several months, for economic and consumer acceptance reasons little is now produced in this way as the taste is very salty.

Pigs used for bacon production should not be excessively fat. The animal should be butchered as shown in Fig. 4.31, which shows the parts of a pig used to make different types of bacon. After butchering the meat should be refrigerated.

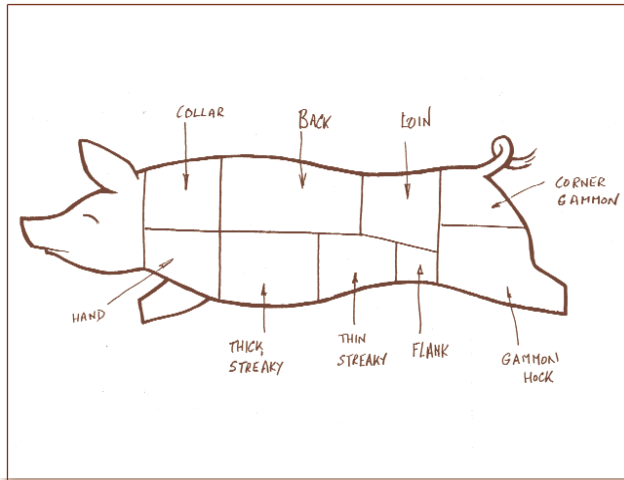

Fig. 4.31 Cuts used to produce bacon

The first step in producing dry cured bacon is to prepare the cure, which must be thoroughly mixed in a power mixer before use. To accelerate the curing process, bacon is usually injected with curing brine using an injection pump. The use of such pumps allows the cure to be directly injected into the interior of the

meat rather than relying on slow penetration from the surface. Two examples of injection pumps, one a simple hand model and the other electric, are shown in Fig. 4.32. Pumps are also available that have five to ten injection needles. The sides of meat should be injected in about 20 places, deep into the interior of the meat. Efficient injection should result in an 8 to 10% increase in the weight of the piece of meat.

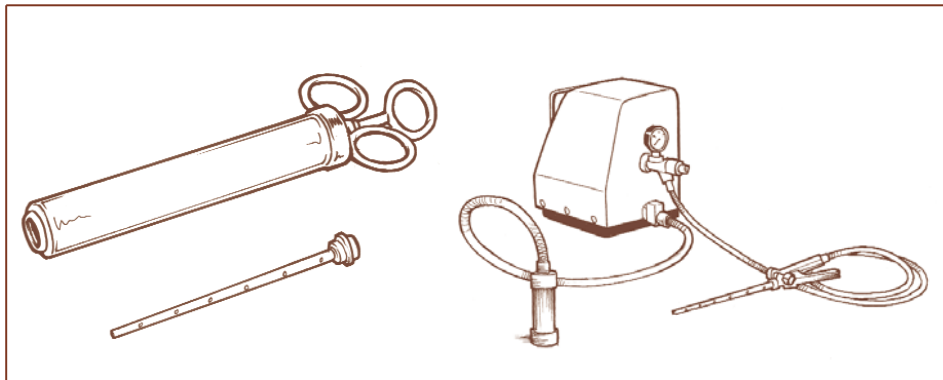

Fig. 4.32 Small cure injection pumps

Two curing brines are normally used: one for injection and one for covering the bacon while it cures. The typical composition of injection and cover brines is shown in Table 4.7.

Injection brine		Cover brine	
Salt	30 kg	Salt	25 kg
Sodium nitrate	3 kg	Sodium nitrate	3 kg
Sodium nitrite	50 g	Sodium nitrite	50 g
Potable water	100 litres	Potable water	100 litres

Table 4.7 Composition of bacon injection and cover brines (ILO, 1985)

*It is strongly recommended that brines should never be re-used. This could result in microbial contamination and loss of the end-product.*

After injection, the bacon sides should be placed in a tank and covered with the cover brine, making sure that all the meat is submerged. The sides should be turned periodically. Bacon is typically allowed to cure for five days. Longer curing results in a product that has a longer shelf life but may be considered too salty by many consumers. Curing should only be carried out in stainless steel, plastic or ceramic tanks. The bacon sides and the brine should be chilled, and kept below 5°C throughout the curing process.

During curing the brine strength will fall due to water passing out of the meat and into the brine. The brine strength should be checked using a low cost instrument called a salometer. Readings should be noted on a daily basis for quality control purposes and further curing salts added as required<sup>7</sup>. The use of a salometer to check brine strength is described in Chapter 6.

A wide range of cures are used, some containing spice mixes and others, known as sweet cures, containing sugar.

The following make-up is typical of a spiced sweet cure brine:

4.8 litres water

550 g sea or rock salt

550 g sugar

30 g potassium nitrate

<sup>7</sup> A salometer is calibrated with a scale from 0° (pure water) to 100° (fully saturated brine).

Spice mix: 2 teaspoons juniper berries, 1/2 teaspoon ground nutmeg, 1 teaspoon cloves, 1 teaspoon peppercorns, sprig of rosemary and bay leaves. Put all spices in a muslin bag and place in the brine. Bring to a slow boil for 3 minutes. Remove spices and cool brine to below 5°C.

One small enterprise stated that they vacuum packed the bacon sides and brine cure and reported that this resulted in more rapid curing in an environment that minimises any cross-contamination.

*Most small producers purchase cure mixes from commercial suppliers. In general, this is more economic, produces a more standard product and makes it easier to comply with local legislation. It is recommended that small producers use commercial cures whenever possible.*

After curing, bacon sides are generally allowed to mature and dry under refrigeration for about a week. They may be cold smoked at 20°C for up to



Fig. 4.33 Self-sharpening, adjustable meat slicer

eight hours using the type of smokers described earlier in this chapter. Smoking imparts pleasant flavours. In addition, the reduction in moisture content and the antimicrobial properties of the smoke chemicals will extend the shelf life.

Retail packs are prepared by slicing the sides to the required

thickness with an electric slicer. Many commercial slicers (e.g. Fig. 4.33) include a system to automatically retain the sharpness of the blade and allow for adjustment of the thickness of slices. Finally the slices are over-wrapped in plastic film, which gives them a shelf life of up to five days. Vacuum packing will extend the shelf life still further.

## 4.7 Producing hams

---

Ham is made from the rear leg or front quarter of pork. It is cured, moulded and fully cooked and is sold either sliced or whole. Most hams are wet cured, although dry cured ham, which must be cured for a minimum of 45 days, is often described as the 'king of hams'. For cost reasons very little dry cured ham is now made.

When wet curing, the use of a brine pump is essential. Particular attention must be paid to areas close to the bone where the meat is most likely to spoil. Refrigerated injection brine should be injected uniformly with a resulting weight increase of around 10%. Hams are often injected several times during curing. Polyphosphates are frequently added to ham cures in order to retain water and weight. Typical compositions of injection and covering brines for hams are shown in Table 4.8.

<b>Ingredient</b>	<b>Quantity</b>
<b>Injection brine</b>	
Salt	6 kg
Sodium nitrate	60 g
Sodium nitrite	30 g
Sugar	60 g
Potable water	20 litres
<b>Cover brine</b>	
Salt	12 kg
Sodium nitrate	120 g
Sodium nitrite	72 g
Sugar	120 g
Potable water	40 litres

Table 4.8 Example of ham injection and cover brines (ILO, 1985)

The next stage is to place the hams in a tank of curing brine, where they must be completely submerged. The cure must be kept cold, ideally at 5°C or below. As recommended for bacon production, the brine should not be re-used. A general rule is to cure hams for one to one and a half days for each kg of weight. A 5 kg ham will thus require between five and eight days in the cure tank. As described in the section on producing bacon, the brine strength will fall and must be checked and adjusted on a daily basis.

Penetration of the cure into the meat can be speeded by mechanical action using a machine called a tumbler. Many years ago butter churns were used as tumblers but now special machines are available. Typically the meat will be tumbled for some 5-10 minutes every 8-24 hours. Massaging and tumbling machines are particularly useful when pre-formed ham products are made. A

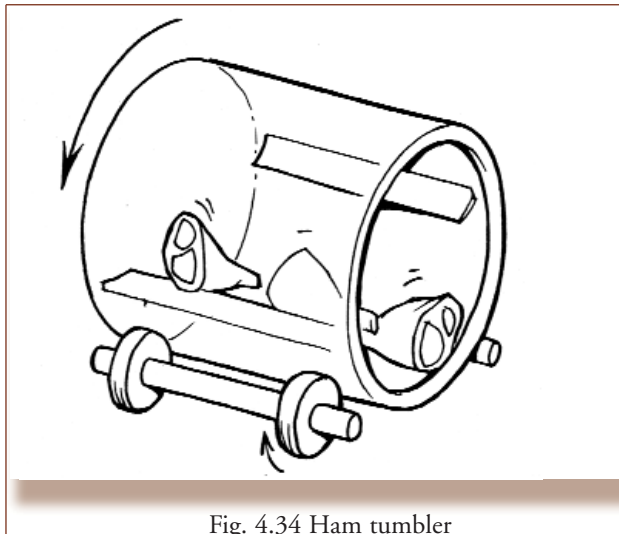

Fig. 4.34 Ham tumbler

diagrammatic representation of a tumbler is shown in Fig. 4.34. Tumblers are either turned manually or with an electric motor.

After curing, hams are allowed to mature and dry under refrigeration for about ten days. After removing any surface salt, the ham is de-boned if required.

The next step is to cook the hams and it is extremely important that each ham is individually weighed and cooked for the correct time to achieve an internal temperature of at least 70°C. The use of an electronic probe thermometer is strongly recommended. A number of cooking systems have



been recommended. A typical method involves packing the weighed hams in sealable plastic 'cook pouches'. These are then simmered for up to ten hours depending on the weight. Shoulder hams require longer cooking to maintain tenderness. Suggested cooking times can be found in Table 4.9.

Leg		Shoulder	
Weight (kg)	Cooking time	Weight (kg)	Cooking time
2	2 hours	2	1.5 hours
4	3.5 hours	3	3 hours
6	5.5 hours	4	4 hours

Table 4.9 Recommended ham cooking times (ILO, 1985)

After cooking, the hams should be cooled as quickly as possible and refrigerated. If they are cooked in a net bag, running cold potable water can be used to speed the cooling process. Hams are commonly formed into a 'block' in a ham press. A ham press has strong springs and a ratchet system to apply pressure and produces a product of a standard size that is easy to slice. Hams may also be cold smoked at 20-25°C or hot smoked (using one of the smokers described earlier in this chapter).

Whether pressed or not, it is common to thinly slice the ham and pack it in trays over-wrapped with cling film. It may also be vacuum packed. As ham is eaten without any further cooking, it is vital that any handling at this stage should involve very strict hygiene. Cross-contamination must be avoided and workers should wear disposable plastic gloves to avoid directly touching the product.

Many different types of ham are found in the market, made with various herbs, spices, sugar and honey and with modifications to the curing process. Books listed in the bibliography provide many recipes. A typical recipe and production system for a specialist wet cured ham is shown in Fig. 4.35.

<b>Irish ham</b>	
Pork leg with skin 4.5 kg Pickling salt 170 g Prague powder No.1 170 g (sodium nitrate in salt) Iced water 13.3 litres Ground cloves 28 g Ground bay leaves 3 g Brown sugar 85 g Ground white pepper 85 g Powdered gelatine 57 g	<b>Method:</b> 1. Remove major bones from the leg 2. Prepare brine from Prague powder, salt, sugar and spices in the iced water 3. Place hams in brine, making sure they are totally submerged. Turn every day for 10 days 4. Remove and allow to drain and dry for 2 hours. Sprinkle gelatine into the cavity where bones have been removed. Place in a net bag 5. Pre-heat smoker to 54°C. Place ham in smoker with light smoke until internal temperature reaches 54°C 6. Remove and store under refrigeration

Fig. 4.35 Specialist ham recipe

## 4.8 Producing dried meat

Dried beef, lamb, goat and game meat are traditionally produced in ACP countries where a suitable climate (low humidity and high temperatures) exists. The best known example is *biltong*, which is widely produced in southern African countries. In other parts of the world this product is called 'jerky'. Two basic types of dried meat are produced (FAO, 1985):

- lightly salted meat dried to a moisture content of 64-70%. The salt content is around 5-6%. This product has a shelf life of three to four days under ambient conditions
- heavily salted dried meat with a moisture content of 45% and a salt content of 12-15%.

Dried meat products are used for cooking, often by low income groups, or seasoned with spices (according to local preferences) and sold as snack foods. The production process for 100 kg of prepared meat is shown below:

1. Cut meat into thin strips (max 2 cm) along the muscle fibres
2. Prepare either a salt/seasoning mix if dry salting is to be used or a brine mix as described below
3. Wash prepared meat and drain
4. Either rub the salt mix into the meat or immerse the meat in the brine

5. Leave to stand for up to 12 hours depending on the salt content required in the final product
6. Place in a dryer until weight is reduced to 25% of the original weight
7. Package in polythene bags or, for a longer shelf life, in vacuum packs.

The meat used for *biltong* production should be low in fat (fat does not dry well) and taken mostly from the lean hindquarters of the animal. Any fatty tissue or connective tissues should be removed. The meat should be well chilled or lightly frozen before preparation.

Spiced *biltong* has become popular as a snack food and a typical seasoned salt mix for dry salting 100 kg of meat is shown in Fig. 4.36. After thorough mixing, the seasoning is rubbed onto the surface of the meat slices. Workers should use disposable plastic gloves to protect their hands and minimise contamination of the meat.

<b>Ingredients</b>			
Salt	3.74 kg	Dried onion powder	30 g
Sugar	1.87 kg	Garlic powder	30 g
Potassium nitrate	20 g	Ginger powder	30 g
Mixed spice	210 g	Mustard powder	30 g
Black pepper	100 g		

Fig. 4.36 Spiced *biltong* seasoning

When brining, it is essential that the brine strength is controlled and maintained at the correct level. The brine should always be near 100° as measured by a salometer and never less than 95°. The quantity of salt and water required to prepare a suitable brine is shown in Table 4.10.

<b>Salometer reading (°)</b>	<b>% salt by weight</b>	<b>Salt (kg)</b>	<b>Water (litres)</b>
100	26.4	0.358	1.000
95	25.0	0.355	1.000

Table 4.10 Brine table at 15°C

After curing, either by dry salting or brining, the meat is dried. Drying was traditionally carried out by laying the meat on racks or large stones in the sun. Such traditional methods expose the product to contamination by dust and the possibility of flies laying eggs in the meat and infesting the product with maggots.

Many producers now hang the strips of meat in a tent-like chamber protected by muslin or fine mesh that allows the free passage of air but protects the meat from contamination and insects. Solar dryers, which concentrate the sun's energy and provide high temperatures, are described in books in the bibliography and are becoming increasingly popular. While experienced operators can recognise when the meat is dried, by looking at its texture and appearance, it is recommended that several sample strips should be weighed prior to drying and check weighed during the drying process. As a guide, the final weight should be 25-30% of the original weight.

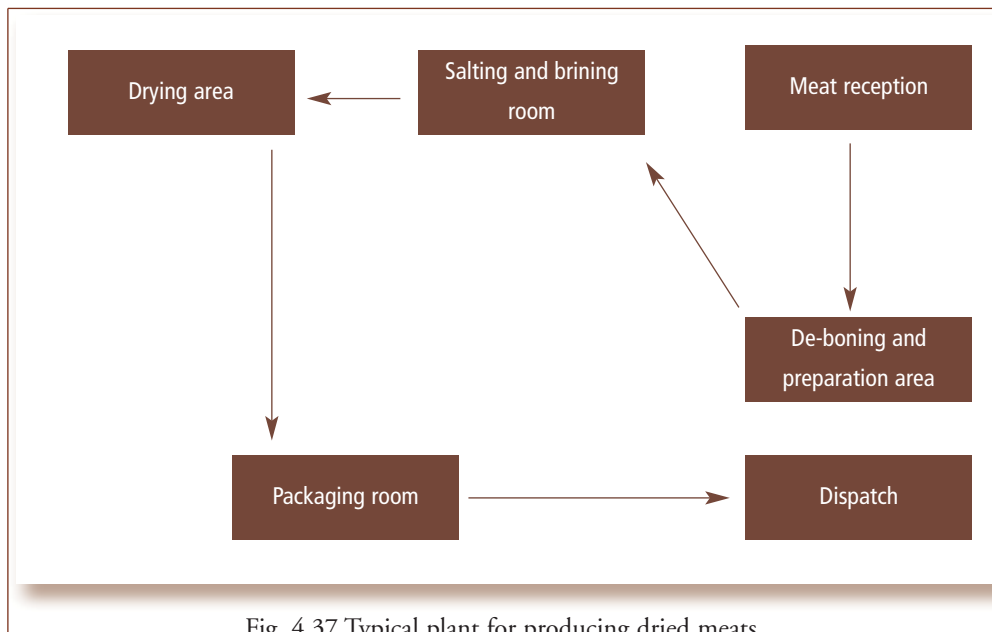

Fig. 4.37 Typical plant for producing dried meats

This information should be recorded as part of the quality assurance system. Samples should also be periodically sent for analysis of moisture content and microbiological quality.

After drying, the meat should be packaged in polythene bags or, for a longer shelf life, vacuum packed. The preservation of *biltong* depends on its low moisture content, the presence of salt and, in some cases, sodium nitrate and packaging that will protect it from moisture pickup. Good plant and worker hygiene is vital as, in most cases, the meat will not be cooked before consumption but eaten as a snack.

The production of dried meat requires basic equipment and a typical plant layout is shown in Fig 4.37.

#### *4.9 Miscellaneous meat products*

A number of meat products such as pies, pizzas, samosas and kebabs, which fall into the areas of baking and catering, provide opportunities for processors either through the supply of ingredients or by direct manufacture. The production of baked meat foods is described in *Setting up and running a small flour mill or bakery* in this series. Pizzas in particular offer opportunities to expand the sale of ground meat, smoked salami sausages and diced ham. Pizzas that are to be sold through retail outlets require good packaging (see section 4.10) to minimise physical damage.

#### *4.10 Packaging meat products*

The packaging used by meat processors is usually quite simple and consists of shrink wrapping of moulded board or plastic trays, vacuum packing or simply sealing the product in a polythene bag. The role of packaging, in most ACP countries, is simply to protect and contain the meat product. Outer cardboard packaging, which has a strong marketing role, is rarely used by small-scale manufacturers for cost reasons.

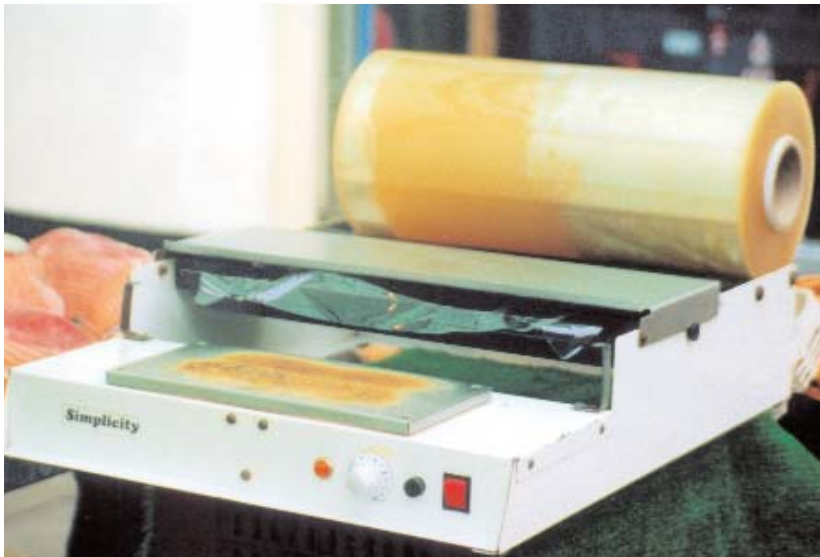

Fig. 4.38 An over-wrap film dispenser

Many meat products are placed on a plastic or fibreboard tray that is then over-wrapped with fine plastic shrink film. The use of a film dispenser allows both hands to be used and allows control of the wrap. Other slightly more expensive machines include a cutting wire and a thermostatically controlled hot plate to shrink the film tightly around the product (Fig. 4.38).

The fragile nature of pizzas means that they require special packaging if they are to survive without damage as they pass through the retail chain. The pizza is first placed on a round disc of expanded polystyrene or cardboard after which it is tightly over-wrapped in clear shrink film so that all the ingredients are kept in place (Fig. 4.39). Additional protection is often provided by an outer cardboard box.



Fig. 4.39 Packaging for pizza

## Summary of the chapter

- ✓ Most meat products were developed in countries with a cool climate. Reliable refrigeration is essential for their safe production in tropical countries
- ✓ The principal meat products made by small enterprises are sausages, hamburgers, pâtés, bacon, ham and dried meat
- ✓ It is important to understand the action of curing salts in suppressing the growth of food poisoning organisms; in particular those responsible for botulism
- ✓ Take time when planning plant layout and make sure the plans are approved by the appropriate authorities before work starts
- ✓ Many products require a high level of craft skills. Read books on the subject and experiment with recipes
- ✓ Herbs and spices can make your product unique
- ✓ Seasonings and colours are expensive. Make sure they are stored according to the supplier's recommendations
- ✓ All products should bear a clear use-by date
- ✓ Good presentation is important when selling products to high income consumers
- ✓ Evaluate your product before putting it on the market and continue to monitor customer and consumer responses.









Fish is a valuable source of high quality protein and, in the case of oily fish, fats of considerable nutritional importance. Fish has traditionally been preserved by a combination of drying, salting, smoking and fermentation for many thousands of years and provides an affordable source of protein for millions of poor people. Simple traditional methods of preservation continue to be practised in many ACP countries (Fig. 5.1).

## *5.1 Fish, the prime raw material*

---

In many countries, large-scale commercial fish processing (mainly freezing for export and canning) takes place in parallel with traditional processing. The methods used by smaller enterprises remain based on traditional techniques of drying, salting, smoking and fermentation.

The main market segments in most ACP countries for processed fish are:

### Tips for success

- ✓ Only buy good quality fresh fish
- ✓ Cool fish quickly by packing it in ice as it will quickly spoil in hot climates
- ✓ Make sure your suppliers have ice in which to pack your fish
- ✓ An insulated cool box lined with stainless steel can keep fish cool for days
- ✓ Small, low cost changes can improve quality and increase income
- ✓ In a reasonably dry climate low cost evaporative coolers can slow down the deterioration of fish
- ✓ Make every effort to minimise losses due to insect attack
- ✓ Look and behave in a professional way however small the business
- ✓ Thorough cleaning and disinfecting will help prevent the growth of spoilage organisms
- ✓ Improved packaging and presentation can greatly improve marketability
- ✓ **Finally:** Read sections 2.2, 2.3, 5.2 and 6.5 in Volume 1: *Setting up and running a small food business*



Fig. 5.1 Improved fish smoker being used on a beach in Ghana (Photo: P. Oti-Boateng)

- massive markets for dried, salted and smoked fish, sold mainly to poorer people
- more limited markets for more up-market products (e.g. lightly smoked fish sold to hotels and frozen convenience foods, such as minced and re-formed fish, sold to middle-class urban consumers)
- large markets for dried smoked fish used in the preparation of fish sauces for local use and export
- large markets for dried fish for the poultry feed market
- large markets for canned fish.

The type and extent of processing (such as salting or smoking) influences the shelf life of the food and is related to the market and its location. For example, fish must be heavily salted or hard smoked if it is to be shipped to a distant inland market.

With the development of refrigeration, new fish products have appeared in the market. In addition to frozen fish, these include minced fish products such as fish cakes and reformed fish products in which flaked fish flesh is reformed in the shape of fillets or fingers.

The importance of identifying supplies of high quality fish has been discussed in Chapter 3. The typical characteristics of good quality fresh fish and spoiled fish are summarised in Table 5.1.

Fig. 5.2 outlines the processing systems used by small- and medium-scale enterprises. Expensive high technology fish processing methods, such as canning and blast freezing, are not considered in this book.

Characteristic	Fresh	Spoiled
Appearance	Shiny, metallic, wet sheen	Dull, dry and wrinkled
Texture	Elastic, firm	Slack, inelastic, bloated
Smell	Fresh sea odour	Sour, off-odours
Eyes	Clear, bright, projecting	Opaque, sunk into head
Gills	Bright pink/red with fresh smell	Brownish, off-odours
Mucus on skin	Free flowing, slippery	Coagulated

Table 5.1 Characteristics of fresh and spoiled fish (Madisson and Matchell, 1988)

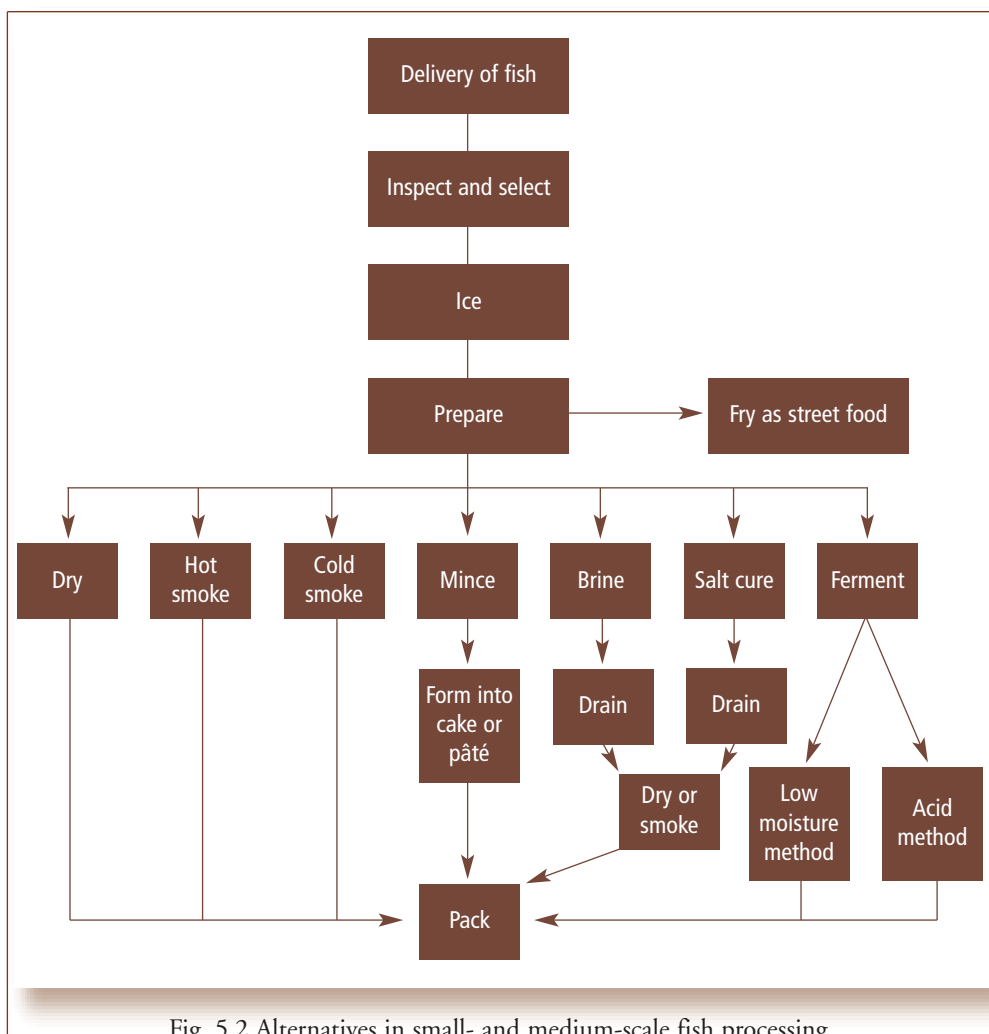

## 5.2 The processing facility, services and equipment

### Traditional processing

Most traditional fish processing is carried out under basic conditions on beaches and riverbanks. Little attention is paid to hygiene or good handling practices, resulting in great variations in quality and high losses, particularly due to infestation after the fish has been dried or smoked. International agencies and national governments are making great efforts to improve the quality and safety of traditional processed fish and, in some cases, they have had considerable success.

A typical small-scale enterprise processing fish on a beach will have basic facilities and equipment and little control over the environment in which processing takes place. A typical example in Ghana is shown in Fig. 5.3. All work is carried out in the open and a small building made from locally available materials may be available to store utensils, ingredients and finished products. Water, often of questionable quality, is taken from a local standpipe or from the sea.

Traditional processors wishing to improve their incomes and move from an essentially subsistence activity can, however, make simple changes at little



Fig. 5.3 Typical conditions at a beach fish smoking site  
(Photo: P. Oti-Boateng)

cost that will allow them to improve quality and develop their market.

Simple changes include:

- make sure the hands are washed with soap before handling food. This is particularly important after using the toilet
- water taken from a standpipe should be treated with bleach using the methods described in Chapter 3

- wash all fish thoroughly in clean water before it is dried or smoked
- keep fish in the shade
- if ice is available, use it. If not, cover the fish with wet sacks. As the water evaporates the sacks will cool the fish. Consider constructing an evaporative cooler as shown in Fig. 5.4
- supply fishermen with ice
- standardise the process so that a product of uniform quality is made. Scales for weighing fish and salt may be too expensive, but there are alternatives. Plastic boxes, for example, could be used to measure a standard quantity of fish and salt
- always use the same type of wood for smoking and move trays to make sure all the fish is evenly smoked and properly dried. Check that all the fish are fully dry
- use plastic boards or a formica topped table for preparing fish. Wooden tables should be avoided as they are difficult to clean and can be a source of splinters and contamination
- use stainless steel knives, they will not corrode and over time will pay back the additional cost
- clean all equipment with chlorinated water at the end of work
- pack the product in plastic bags and attach a simple label with the brand name, producer's address and weight. This will allow satisfied consumers to identify your product in the market
- wear white aprons and hats. This will reassure buyers that you are responsible about health, quality and safety.

*The profits made belong to the business. Use them to make improvements. This is the way to progress.*

The equipment required by small-scale fish processors is basic, simple and low cost and is listed in Table 5.2.

1. Large plastic containers for washing and salting fish
2. Sharp stainless steel knives
3. A preparation table - ideally faced with formica
4. Drying racks
5. Fish smoker
6. Plastic bags and simple self-adhesive labels
7. Measures or scales
8. Scale to check net weight of packs
9. Supply of salt, firewood and ice

Table 5.2 Typical equipment required for small-scale drying, salting and smoking of fish

Evaporative coolers can be constructed from locally available materials and, depending on the climate, can lower the internal temperature by 5-10°C.

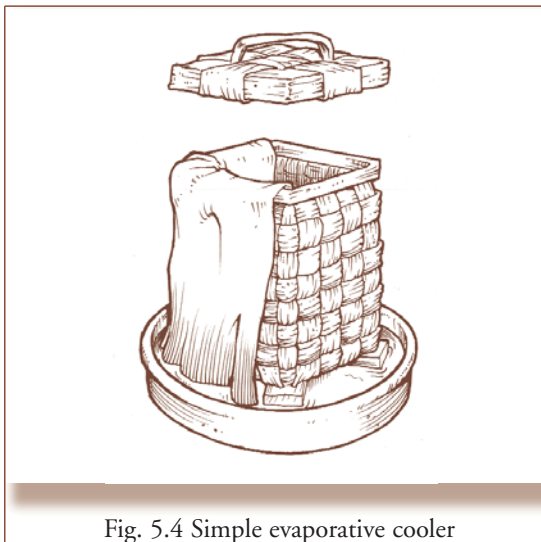

Fig. 5.4 Simple evaporative cooler

Evaporative coolers rely on the cooling effect of water evaporating from a porous surface.

A temperature reduction of 5-10°C will considerably slow down the deterioration of the fish before processing. The performance depends on local climatic conditions and efficiencies are lower in areas of high relative humidity. Evaporative coolers are also more efficient in windy areas.

An example of an evaporative cooler is shown in Fig. 5.4. Details on the construction and performance of evaporative coolers can be found in the article 'Cooling without power' listed in the bibliography.



## Medium-scale processing units

The requirements of a medium-scale formal fish processing plant in terms of site, construction, internal finish and services are in many ways similar to those for a meat processing plant. Both meat and fish are highly perishable and carry similarly high public health risks. Both involve wet processing in the initial stages and the general construction guidelines given in Chapters 3 and 4 apply equally to fish and meat. In summary:

- the plant must be constructed so that it is easy to clean. Flies and insects must be excluded. It must be possible to move all equipment to allow thorough cleaning
- waste disposal must be hygienic
- facilities must be provided for good worker hygiene i.e. hand-washing, showers, toilets, changing rooms and clean uniforms and headwear
- a plentiful supply of potable process and cleaning water is essential together with efficient drains. Filleting and gutting is usually carried under constantly running water to remove soils efficiently. A supply of hot water will also be required for washing and cleaning
- the system of preparation should rapidly sort unwanted material (heads, bones etc.) from usable fish
- refrigerators and freezers will be required. A reliable electricity supply is vital and back-up generators should be seriously considered if the mains supply is unreliable
- the use of air conditioning should also be considered in critical areas of the processing plant such as the preparation room
- in most situations a plentiful supply of chipped ice will be required. This can either be produced in-house or purchased from a local supplier. Small quantities of ice can be made by allowing containers of water to freeze overnight in a deep freeze. This can then be chipped in simple ice-flaking machines. Ice, whether bought in or produced in-house, must be made from treated water to avoid contamination.

Fish entering the plant should all be inspected and any of low quality must be rejected and removed from the building. The fish should then be put in plastic boxes with ice and kept for the shortest possible time before preparation and processing.

*As with meat, the key to producing high quality fish products is careful control of time, temperature and moisture.*

The preparation of fish (gutting, filleting etc.) should ideally be carried out on stainless steel tables using plastic chopping boards. The use of chopping boards is important as knives will quickly become blunt if they are used directly on a steel table. If stainless steel is too expensive, formica clad tables should be used. Wood preparation tables should be avoided as they are almost impossible to clean and wood splinters can get into the food. Only stainless steel knives should be used for preparing fish. Clean running water should be available together with containers for waste material.

As described in Chapter 4 the fish should follow an uninterrupted path through the plant in order to avoid any chance of cross-contamination. Operations involving heat, for example drying and smoking, should be undertaken in areas isolated from the cool, wet processing area.

### *5.3 Producing dried, cured and smoked fish*

---

#### *The principles of preserving fish*

All micro-organisms require water in order to grow and the main objective in preserving fish is to reduce the moisture content to a level that prevents the growth of spoilage organisms. The composition of fresh fish is around 80% water. When the water content is reduced to 25%, bacterial growth and spoilage cease. Lowering the water content to 15% will, in addition, stop the growth of moulds. However, preventing the growth of micro-organisms cannot be achieved simply by lowering the moisture content.

*The factor that controls microbial growth is not the total moisture level but the amount of water that is available to the micro-organisms.*

This is defined by a property: water activity or  $a_w$ , which takes account of the quantity of water that is chemically bound to salts, sugars and other food components. This bound water is not available to micro-organisms, so they can only utilise the free, unbound water. While a detailed explanation of water activity is beyond the scope of this book, the essential points to be understood by processors are:

- only free water is available for the growth of micro-organisms
- water can be 'bound' and made unavailable for microbial growth by adding strong water-binding substances such as salt and sugar
- most universities and research institutes will have specialised equipment to measure the  $a_w$  of a product and the staff can advise on the likely stability of a product to microbial growth.

In the case of fish, the addition of salt as a water-binding agent is a key factor in preservation. Moisture binding with salt combined with moisture removal by drying is a widely used method of fish processing.

Drying involves the transfer of moisture from the fish to the surrounding air and the rate of drying depends on five principal factors:

1. The quantity of air passed over the food
2. The humidity of the air: as shown in Table 5.3 the ability of air to absorb moisture is greatly influenced by its humidity
3. The size of the fish, or pieces of fish, being dried. Large fish dry very slowly, as moisture has to move from the interior of the fish to the surface where it evaporates. For this reason larger fish are usually opened out flat to increase the surface area available for drying and to reduce the distance that water has to travel to the surface where it evaporates
4. The presence or absence of skin. The skin of a fish acts as a barrier to moisture removal. When possible large fish should be skinned before drying. However, the presence of skin may help to reduce damage during transport and may be preferred by customers as it allows them to identify the type of fish
5. The chemical composition of the fish: oily fish dry considerably more slowly than white fish as the oils slow the movement of moisture to the surface. It should also be noted that rancidity may develop more rapidly in oily fish than in white fish.

Temperature	Relative humidity	Amount of moisture that can be absorbed by 1 kg of air
Ambient air at 20°C	80%	3 g
Heat to 25°C	Falls to 58%	8 g
Heat to 30°C	Falls to 25%	16 g

Table 5.3 Relationship between air humidity and moisture removal capacity (Axtell, 1991)

Micro-organisms will continue to multiply during the drying process, particularly in the early phase when the fish is wet and warm. Is it therefore important to dry the fish as quickly as possible. However, fish are very susceptible to 'case hardening' when the surface hardens and slows down or stops the transfer of moisture to the surrounding air. If case hardening occurs the surface of the fish will appear dry while the interior remains moist and the inside will spoil rapidly. Unfortunately, case hardening can only be controlled by slowing the rate of drying. To avoid excessive losses due to spoilage, processors are advised to dry small fish whole but to split open larger ones and flatten them to expose the maximum surface area. In some cases the fillets are removed and dried.

### *Curing with salt*

The role of salt is two-fold: firstly, it rapidly removes moisture from the flesh to a point at which microbial growth is retarded or stopped. Secondly, many spoilage organisms cannot grow in salt concentrations above 6% salt. Some organisms however, known as halophiles, are very salt tolerant and will continue to grow until the fish is very dry. Secondly, by removing moisture, salt retards the action of enzymes<sup>8</sup>, most importantly those that cause rancidity in oily fish.

Curing, or moisture removal by salt, depends on the physical phenomenon known as osmosis in which water moves from the fish to the salt or brine, while the salt moves from the brine into the fish. This natural transfer continues until the concentration of salt and water in the brine is the same as that in the flesh of the fish. At this point more salt must be added to the brine in order to continue the process. The rate of salt penetration into the fish (and moisture removal from the fish) depends on:

- strength of the brine
- brining time
- temperature
- size of the fish or pieces of fish being treated
- type of fish and in particular its oil content.

---

<sup>8</sup> *Enzymes are natural proteins that act as catalysts for colour, flavour and physical changes in foods. The rate of enzymatic reactions slows as the moisture content and temperature of the food is reduced.*

Four salting or curing methods are used:

- brining
- pickling
- dry salting
- 'light' or 'Gaspé' method.

Brining is used when the aim is simply to add flavour to the fish rather than to preserve with salt. Preservation will depend on later processing methods such as smoking or drying. Brining involves immersing the fish in weak brines (generally 25 to 40%) for a short time. A secondary effect of brining is the formation of an attractive white gloss on the surface that is due to reactions between salt and fish proteins. Brining also makes the fish less attractive to flies and other insects, thereby minimising spoilage during subsequent drying and storage.

Pickling involves immersing the fish in strong brine (80% saturated or 80° salometer reading) for long periods. Brine of this strength can be made by adding 21 kg of salt to 100 litres of water. The fish must be fully submerged. It is very important that the brine strength is checked at regular intervals, as the strength will decrease as moisture is drawn out of the fish. More salt should be added when necessary. The use of a salometer (described in Chapter 4) is strongly recommended.

Dry curing or 'kenching' involves splitting and opening out the fish and then packing them in layers interspersed with salt. The fish should be layered flesh to flesh and skin to skin with the fish in the top layer being skin side upwards. Water removed from the fish is allowed to drain away through holes in the base of the kenching tank. Only white, non-oily fish are kenched and the final dried product has a long shelf life.

The Gaspé process is similar to kenching but is conducted in tubs and the liquid is not allowed to drain away. Consequently, after about three days the fish will be floating in a salty liquid. The fish must be kept completely submerged (using weights) at all times. After draining the fish are dried in the sun or in a kiln.

The importance of using the correct type of salt has been discussed in Chapter 3. While very pure salt is technically the best, it tends to produce a slightly yellow colour that may, or may not, be acceptable to the local market. Many consumers associate high quality salted fish with a very white product. White dried fish can be produced if the salt contains small amounts of calcium and magnesium but these increase the rate of moisture pickup from the atmosphere and in hot, humid areas this reduces the shelf life. Producers should be aware of local colour preferences.

## Drying

Many different methods and items of equipment can be used to dry fish, ranging from simple mats in the sun to artificial cabinet dryers using fuel to heat the air and fans to blow it over the fish. Some options are shown in Fig. 5.5 and further information can be found in the literature listed in the bibliography.

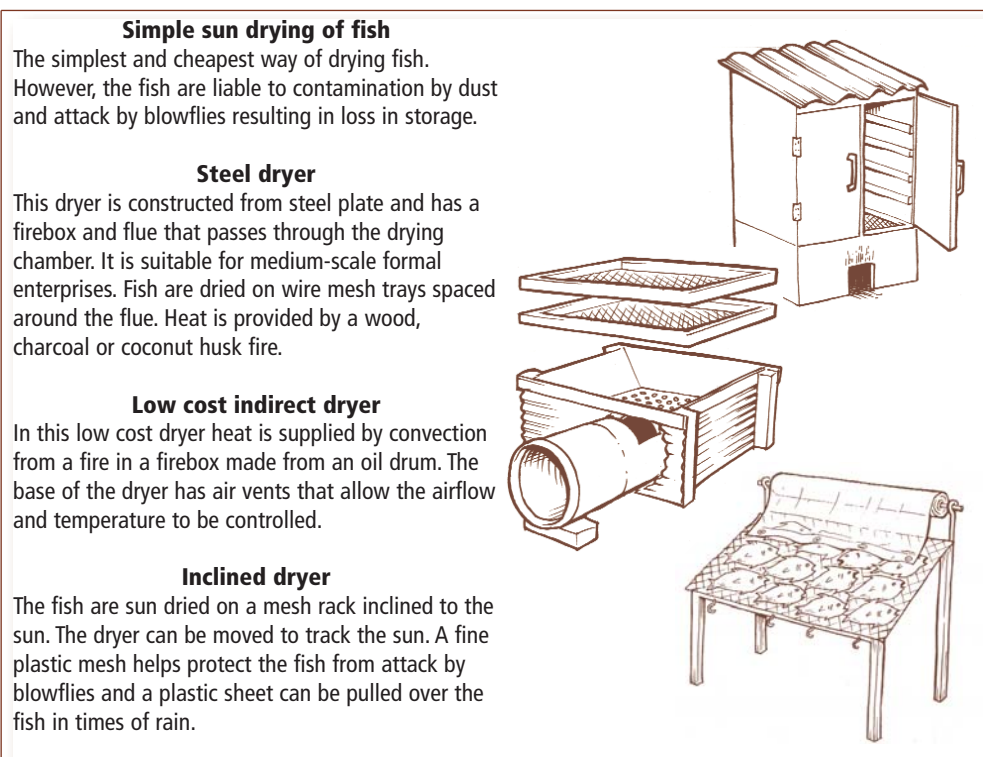

Fig. 5.5 Examples of low cost fish dryer designs

Dried fish meal is widely produced from small fish (by-catch) that are netted with larger species and from fish scraps left over after processing. The fish can be dried and milled to a flour and used to fortify poultry feed. Proper disposal of waste to a feed manufacturer adds to profits and overcomes waste disposal problems.

### Smoking

Smoke contains tar-based phenolic compounds that inhibit microbial growth but these play a relatively minor role in preserving the fish. More importantly, the heat from the fire dries the fish, reducing the moisture content to a level that will prevent the growth of micro-organisms. The smoke phenolics also have antioxidant properties that delay the development of rancidity in oily fish. All of these factors increase the shelf life of the final product.

Cold smoking involves using a fire that is some distance from the fish. The temperature of the flesh does not exceed 35°C and no cooking occurs. Such lightly smoked products have a shelf life measured in days under refrigeration.

Hot smoking involves temperatures that are high enough to cook the fish. Hot smoked fish can have a long shelf life, the length of which largely depends on the amount of drying that has taken place and the degree of protection against moisture pickup. Hot smoking of oily fish, such as Nile perch, can cause the kiln to catch fire. Oily fish are therefore best treated in a smoker with an external firebox.

In many parts of the world, smoke is generated from wood rather than sawdust. Wood burns hotter than sawdust and the product is often burnt, rather than smoked. Wood that has been treated in any way should not be used. It is recommended that the fire should be lit with wood shavings and then fed with dry sawdust rather than with wood. When smoking fish it is advisable to keep the temperature low (at about 30°C) in the early stages of the process. This avoids rapid surface drying and case hardening.

Very small enterprises tend to use improved traditional smokers, which are normally to be found on beaches close to fish landing points. Traditionally,

fish were smoked by placing them on sticks or racks over an open smoky fire. A number of improved smokers, based upon traditional methods, have been developed and widely promoted. Some of the more successful types are shown in Table 5.4. One of these is the '*chorkor*' (see Case study 5.1 and Fig. 5.6).

	<b>Mud <i>chorkor</i></b>	<b>Brick <i>chorkor</i></b>	<b>Altona</b>	<b>Ivory coast smoker</b>
Fuel consumption kg wood/kg fish	Good 0.21	Good 0.35	Good 0.28	Good 0.46
Cost	Low	Moderate	Very high	High
Ease of use	Good	Good	Poor	Moderate
Smoke control	By arranging trays	By arranging trays	By arranging trays	By arranging trays
Useful life	Short unless protected from rain	Long	Long	Moderate
Product quality	Good	Good	Poor	Good
Temperature control	Variable, depends on wind	Variable depends on wind	Horizontal heat distribution, variable control	Horizontal heat distribution, variable control
Capacity	226 kg	230 kg	182 kg	130 kg

Table 5.4 Features of some improved smokers (Stround, 1986)

### Case study 5.1 Experiences with the *chorkor* smoker

Two Ghanaian sisters have a family tradition of fish smoking. Twenty years ago, their mother was trained in the construction and use of an improved smoker called a *chorkor*, which was developed by the Ghana Food Research Institute. 'We now have five *chorkors* and they are very efficient if used properly,' they report. 'We can process over a tonne of fish every two days.' Ten trays, each holding 10-15 kg of fish, are stacked over the mud firebox. To ensure even smoking, the trays are carefully rotated, so that by the end of the process the bottom tray is at the top of the stack and the top tray is at the bottom. The knack of moving the trays takes a lot of practice, as does setting the fire, especially in windy weather. They have received help from the fire service in showing them how to work safely. They buy most of their fish from their father or other relatives to make sure they get the best quality. They prefer



herrings as these have a good market and can keep for up to a year if properly stored. Fresh fish arrives in plastic crates, bowls and baskets and on hot sunny days they place blocks of ice on the raw fish to keep it fresh.

Small- and medium-scale producers operating a fish processing plant will use a custom-built smoker and various examples have been described in Chapter 4. At the simplest this can consist of a room constructed from blocks or brick and fitted with poles from which fish can be hung. It is very important that the fish do not touch each other in the smoker. Smoke can be generated either inside the smoker from smouldering hardwood sawdust or externally (Fig. 5.7).



Fig. 5.6 The chorkor in use (Photo: P. Oti-Boateng)

Greater control of temperature and smoke distribution is possible if a smoker is fitted with a fan to blow the smoke into the chamber. Control of smoke and temperature can also be provided by an adjustable air entry vent to the smoke box and an adjustable vent in the smoker chimney.



Fig. 5.7 Brick-built smoker with external firebox (Photo: P. Oti-Boateng)

It is very important that all fish in the smoker are evenly processed. This requires:

- moving the fish from one part of the kiln to another as smoke density will be greater near the kiln bottom
- checking and maintaining a steady kiln temperature by controlling the fire
- monitoring the internal temperature of the fish with an electronic thermometer.

The production of consistent quality smoked fish depends greatly on the skill of the operator and their control over the position of the fish, ventilation, smoke density and temperature. This work should not be left to unskilled workers.

Mention should be made of commercially available liquid smoke (which would have to be imported into most ACP countries). This is produced by condensing the volatile tars from wood smoke and for cost reasons finds wide use in the commercial production of lightly smoked fish. Liquid smoke is highly concentrated and typically 20 ml diluted in water is sufficient to treat 10 kg of fish.

### *Insects and infestation*

All processors of cured fish products should be aware of the dangers presented by infestation. This is particularly true of beach-based producers who have minimal control over their working environment. Product loss can be very high and FAO studies have shown typical losses of 25-30% in such situations. Clearly such losses will have a negative impact on the profitability of the enterprise. Two broad types of insect attack exist:

- infestation by blowflies, which lay eggs in the fish as it is being dried. The eggs then hatch and the larvae feed on the final product
- infestation of the cured final product by beetles, principally from a family known as *Dermestides* or 'woolly bears'. These attack the dried, salted or smoked product when it is in store.

Blowfly and beetle attack can be considerably reduced by simple measures such as:

- remove all rubbish, such as guts and scraps, from the processing site and keep in covered bins. Flies are attracted to smelly scraps and will be attracted to the fish in the dryer
- locate the processing facilities away from local toilets and open drains

- keep processing operations away from bushes and trees. Flies tend to rest in vegetation during the heat of the day and will then be attracted to the fish as temperatures fall
- cover the dryer with fine fly-proof mesh
- pack all cured fish quickly in sealed bags and store them on wooden pallets off the ground
- spray the ground around the pallets of cured fish to deter crawling beetles. Deterrents such as pepper and hot chilli extract have been reported to provide 'a line that insects will not cross'.

The use of insecticides to control infestation of fish is widely reported and many of the chemicals used are totally unsuitable and unsafe. One insecticide that has broad recognition is pirimiphos-methyl.

*But remember: responsible producers do not use insecticides without first seeking expert advice.*

All measures taken to minimise insect attack involve additional costs that many small-scale producers are unable or unwilling to cover. The processor needs to consider and balance the additional cost of protection against the direct losses that may occur and the damage to the company image that may result if consumers buy fish that is full of insects. A producer selling dried fish with little or no infestation may, even if the price is higher, have a distinct advantage over their competitors, especially if a high proportion of the fish in the local market are infested.

## *5.4 Producing minced fish products*

---

Provided a local market has been identified, secondary minced fish products can be manufactured from the parts of the fish that remain after primary processing. After the prime cuts (e.g. fillets) are removed, a considerable amount of high quality flesh remains. This can be removed, either by hand or by using a mechanical de-boning machine, and can be made into products such as fish cakes or pâtés. It is essential that the fish flakes are totally free from bones. Fish cakes are generally sold frozen, rather like hamburgers. A typical recipe is shown in Fig. 5.8. Minced fish may also be formed into 'fillet shapes' resembling real fish or into fish fingers. Specially shaped moulds, similar to hamburger moulds, can be made locally.

### **Fish cakes**

Cooked and mashed potato 250 g  
(other starch-based roots could be substituted)  
Flaked fish, totally free of bones 250 g  
Egg 1  
Salt and pepper to taste  
Finely diced onion to taste  
Finely chopped parsley  
A few drops of lemon juice

Mix the ingredients thoroughly, form into balls of equal weight and press into flattened discs. Fish cakes can be made to a uniform size with the same type of moulders as used to make hamburgers (described in Chapter 4). Coat with breadcrumbs. Freeze for distribution.

Fig. 5.8 Typical fish cake recipe

Fish pâtés are very high value gourmet products. Unlike meat pâtés, in many cases they are not cooked so they have a very short shelf life. Two examples of fish pâté recipes are shown in Fig. 5.9.

### **Smoked roe pâté**

Smoked fish roe 250 g  
Cheese blended with crushed garlic and finely chopped parsley 150 g  
Softened butter 50 g  
Lemon juice to taste  
Salt and pepper  
Blend all the ingredients into a smooth paste. Pot and chill thoroughly.

### **Black-peppered mackerel pâté**

Filletts of smoked mackerel, skin removed 2  
Soft cheese 250 g  
Cream 150 ml  
Mustard powder to taste  
Black pepper coarsely ground  
Blend all ingredients, being careful to retain some texture of the fish. Pot and chill.

Fig. 5.9 Fish pâté recipes

## 5.5 Producing fish-based sauces

In many parts of the world, particularly in Asia, fish is preserved by fermentation. The resulting sauces and condiments are used widely in local cooking. The increasing popularity of Asian food around the world means that such products could offer new niche market opportunities. Two basic groups of fermented fish and shrimp condiments are produced: the first contain very high levels of salt, usually 15-25% (Fig. 5.10), while the second are the result of the fermentation of a fish, shrimp and rice mixture (Fig. 5.11).

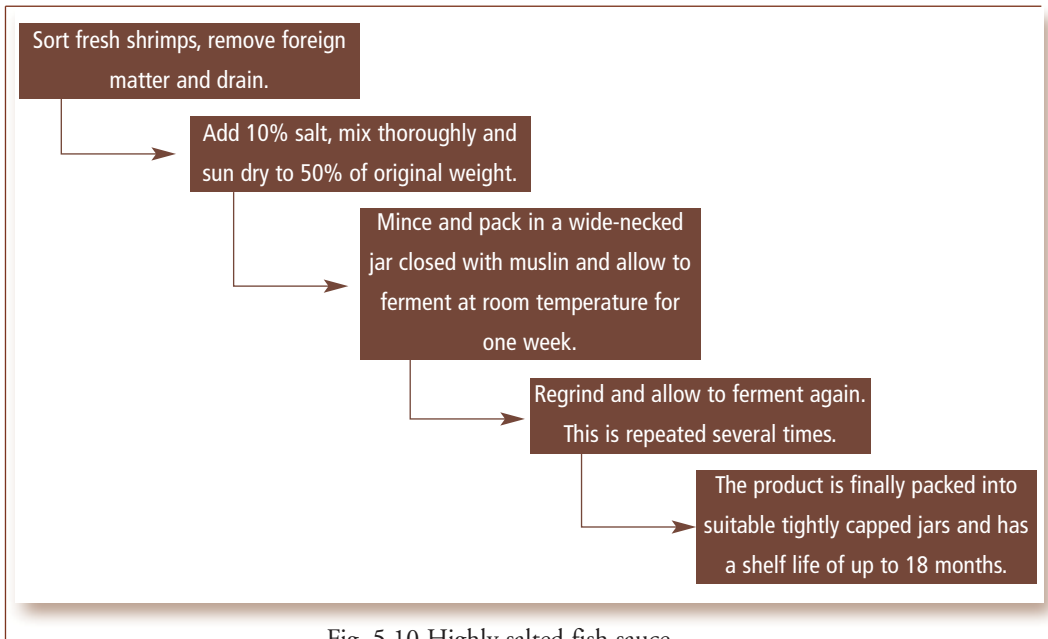

Fig. 5.10 Highly salted fish sauce

The preservation of the first type of condiment depends on its very high salt content and its low moisture. The number of micro-organisms reduces considerably during processing and the fermentation is largely due to the action of natural enzymes present in the shrimps.

The second group of condiments (in which fish is fermented with rice) relies on the fermentation of sugars and carbohydrates by lactic acid bacteria. This results in an increase in acidity which suppresses the growth of organisms that have a public health risk. The pH of the sauce is typically 4.1 to 4.5 and the salt content 10%.

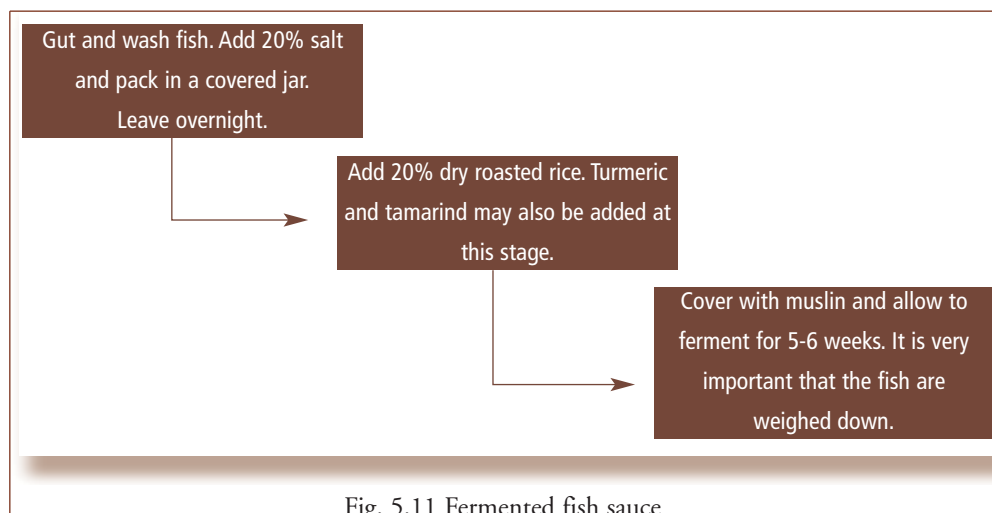

Fig. 5.11 Fermented fish sauce

In Ghana and other West African countries, a fish-and-shrimp-based hot pepper sauce is very popular (see Case studies 2.4, 2.12 and 5.2). *Shito* has now found markets as far afield as Europe. Individual recipes are a closely-guarded secret but a typical production method is as follows:

1. Fry slices of onion and ginger until soft
2. Add ground hot red peppers
3. Add dry shrimp and fish powder with some salt and simmer the mixture until oil starts to collect on the surface
4. Pack into tightly closed clean jars.

### Case study 5.2 Producing *shito*

Mrs A. started production at home and then, as the business grew, built a processing plant on an empty plot of land adjoining her house. The building layout was designed with the help of a friend who is a draughtsman and the Food Research Institute also gave advice.

The factory is well laid out and netted to keep out flies and insects. All external doors are protected. Raw materials, packaging and finished products are stored in individual stores. The sauce is cooked in large stainless steel pots and mixed with wooden stirrers. She also has work tables, insect proof cupboards, scales and locally built gas cookers. She states that 90% of her equipment was made in Ghana. She has ready

access to a maintenance engineer who advises her on equipment. She can produce 500 kg of *shito* each day.

She buys dried and smoked fish and shrimp direct from selected suppliers and is satisfied with the quality. Raw materials are expensive and account for 50% of production costs and the prices of fish and shrimp increase between July and September when catches are low. She thus stores dried fish and shrimp but never for more than three months.

The product is packed in glass jars (which they have to import since the local glass company closed down) but the prices are erratic as they are pegged to exchange rates. The company bought its own truck after financial analysis showed this to be more cost effective than hire.

## *5.6 Packaging fish products*

---

Traditional fish processors usually pack the final product into baskets lined with brown paper for distribution to markets. Some use baskets made from trees with insect repellent properties (Case study 5.3).

### **Case study 5.3 Using natural insect repellent packaging**

Producers in Ghana use large baskets made of neem tree twigs to pack their smoked fish. 'The baskets are not only strong but the neem has insect repellent properties that prevent the fish being attacked by weevils. If the market is nearby we do not cover the fish. If it is more distant, say 10 km or more, we cover the fish with cheese cloth, brown paper or palm leaves. Baskets are expensive, perhaps 10% of production costs, but over time we have built up a stock of baskets and if we look after them they will last for years.'

The use of pre-formed trays over-wrapped with shrink film (as described in Chapter 4) is increasingly expected when selling into non-traditional markets and supermarkets. Such packaging makes the product more hygienic and attractive. As described in Chapter 4 the addition of cooking instructions and recipes adds to customer appeal.

## Summary of the chapter

- ✓ High quality fish is essential if good quality products are to be produced
- ✓ Chilling fish is important. If ice is available, use it and if not, consider evaporative cooling
- ✓ A supply of clean potable water is required – if in doubt treat water with bleach
- ✓ Small-scale producers can maximise quality and reduce losses by implementing simple, low cost improvements
- ✓ Medium-scale producers will need a properly designed, well-laid out plant with reliable services
- ✓ Salt 'binds' water making it unavailable for microbial growth
- ✓ Artificial dryers allow greater control and allow the enterprise to be independent of weather conditions
- ✓ When used properly improved smokers can produce products of consistent quality
- ✓ Dried fish is susceptible to attack from insects, which may result in significant financial losses
- ✓ After filleting, the remaining fish flesh can be used to make secondary products such as fish cakes, which add to profits
- ✓ New fish products such as fillets, strips, steaks, kebabs and marinated fish may have export potential
- ✓ Fish- and shrimp-based sauces may have a good market potential
- ✓ Improved packaging can enhance sales







# Quality assurance and legislation

# 6

## 6.1 Risk analysis from production to consumer

---

All food manufacturers have a responsibility to ensure that quality assurance systems are in place to provide the final consumer with a product that is wholesome and safe to eat.

The manufacturer's responsibility does not end when the product leaves the production unit. Poor control in the transport and retail chain can result in quality problems that may cause consumer complaints. In law, the food manufacturer may be able to claim that illness due to eating a product is the result of the retailer failing to keep the food at the correct temperature or the consumer using the product after its use-by date. However, any complaint will damage the name and image of the producer and may place the future of the enterprise at risk.

Invariably products face the highest level of risk to hazards after purchase by the consumer (see Fig. 2.6, page 43), for example:

### Tips for success

- ✓ All complaints damage your business
- ✓ Unhappy consumers will talk to many people
- ✓ Carry out a hazard risk analysis for all products from production to consumption
- ✓ Products face the greatest risk after purchase, so provide all possible advice clearly on the label
- ✓ Pay maximum attention to high-risk products
- ✓ Make products that taste good and are consistent in flavour, texture and appearance
- ✓ Obtain copies of local food legislation and if it is not clear seek help
- ✓ Identify local institutions that can provide specialist assistance
- ✓ When possible buy all raw materials and packaging against an agreed specification
- ✓ Never use contaminated herbs and spices
- ✓ Be aware of your environmental responsibilities
- ✓ Keep in communication with suppliers; they can provide a lot of useful information
- ✓ **Finally:** Read Chapter 6 in Volume 1: *Setting up and running a small food business.*

- being left in a hot vehicle for some hours during which time the food thaws and warms. Microbial growth rapidly occurs
- re-freezing a frozen food that has thawed
- storage in a home refrigerator which is not operating at the correct temperature
- cross-contamination in the kitchen, for example ham being cut on a poorly washed board that has been used to cut fresh meat
- flies and other pests
- being improperly prepared or consumed after the use-by date.

The level of control of risk required in the chain from producer to consumer is greatly influenced by the public health risk associated with the particular product. Some foods carry a very low risk of causing harm to consumers. A wine, for example, may turn into vinegar and taste sour or a generally harmless mould may grow on a jam. Such spoilage is readily detected and there is little risk to the consumer if the food is eaten.

*However, the animal products described in this book must all be considered as high risk foods.*

Individual meat and fish products carry different public health risks and can be divided into medium, high and very high risk foods.

Medium risk meat and fish products include:

- traditional dried and/or smoked meat and fish that will be cooked before consumption. These carry a medium risk provided they are kept dry
- well-cured meats such as bacon that is normally cooked
- strongly cured dried smoked sausages carry medium risk provided they are stored under the correct conditions and do not absorb moisture
- fermented fish sauces carry medium risk provided the correct level of acidity has been reached.

High risk meat and fish products include:

- dried meat or *biltong*, now common as a bar snack and eaten without further cooking

- ground meat products, such as fresh sausages and hamburgers, while cooked prior to consumption are high risk if consumed after the use-by date, if insufficiently cooked or if not kept frozen or refrigerated.

Very high risk meat and fish products include:

- lightly cured cooked hams, cold smoked fish and pâtés. In general, these are eaten without further cooking and the control of cross-contamination, for example from raw meat in a display unit or in the home, is vital.

It is strongly recommended that a manufacturer should carry out a risk analysis for each of their products (see Fig. 6.1). Customers who own shops, restaurants and hotels should, whenever possible, be involved in the risk analysis, in order to inform them of their important role in the 'safe food chain'.

Where risk occurs	Hazard sources	Possible actions
In the production unit	Provided good hygiene systems are in place and the meat is properly dried, the greatest risk is cross-contamination from raw meat either by direct contact or by worker contact. Other risks include poor 'first in, first out' stock control and poor heat sealing of plastic packaging.	Implement systems that ensure cross-contamination cannot occur. Check that all products are fully dried. Check heat seals.
In the transport chain	Poor handling can result in packaging being perforated and allowing moisture pickup. Products transported with another hazardous material can become contaminated.	Pack bags in strong, sealed cartons. Explain how you want the products transported. Use a reliable transport company even if a little more expensive.
At the point of consumption where the <i>biltong</i> is placed in bowls on the bar as a snack	Contamination due to flies or to people not washing their hands after using the toilet. The possibility that any <i>biltong</i> left over at the end of the day will be put out again the next day.	Control solutions become difficult at this distance from production. Provide advice by visits and on labels. For example, only put small amounts in bowls to minimise customer contamination and emphasise that any left over <i>biltong</i> should be put back into the bag and re-sealed.

Fig. 6.1 Risk analysis for a dried meat bar snack

Risk or hazard analysis, known as the hazard analysis and critical control point (HACCP) system, is described in detail in Volume 1. As the example above shows, the objective is to identify:

- where the hazards occur
- the nature of the hazards
- potential solutions to minimise risks that might damage the consumer or cause complaints.

Given the higher risks associated with products of animal origin, it is recommended that entrepreneurs should seek advice from institutions specialising in HACCP. These are now to be found in most ACP countries. See Appendix I (useful contacts).

## *6.2 Quality of raw materials and packaging*

---

### *Raw materials*

#### *Meat and fish*

Aspects related to the purchase of high quality raw meat and fish have been described in Chapters 4 and 5. These are the prime raw materials and must be of the highest quality.

#### *Herbs and spices*

These find wide use in the meat industry and are a common source of microbial contamination. They are frequently contaminated with a wide range of organisms including moulds and pathogens. The presence of pathogens is very common if animal manure is used to fertilise the crops. Unless purchased from a reputable supplier against an acceptable microbiological specification they should always be regarded as suspect. It is recommended that samples of herbs and spices not bought against a specification are sent for microbiological testing (to assess the total count, *E. coli* and salmonella).

#### *Natural sausage casings*

These animal intestines are by their very nature liable to introduce microbial contamination if not properly prepared. Natural casings should be inspected for cleanliness and if any doubt exists, they should be rejected. The diameter

of all casings should also be measured. It is unlikely that quality problems will be found if natural or synthetic casings are bought from established suppliers against a specification.

### *Salt*

Fine-grained commercially produced salt does not present any quality problems. Crude coarse-grained sea or rock salt, however, can be contaminated with sand and dust. The cleanliness of salt should be checked by dissolving about 50 g of salt in water and passing it through a filter paper in a funnel. If filter paper is not available, a sheet of kitchen paper towel can be used. The paper should be inspected for the presence of impurities.

### *Minor ingredients*

Minor ingredients used in fish and meat processing, such as sodium nitrate, sodium nitrite, food colours, sugar and skim milk powder, will have been produced commercially and are unlikely to present any quality problems.

### *Packaging*

In general the packaging required for processed meat and fish is simple and of reasonably low cost, comprising plastic bags, fibre or plastic trays, shrink film, vacuum packing film, sausage casings and metal sausage clips and labels.

While suitable plastic bags will be available in nearly all ACP countries, the remainder of the packaging will need to be imported unless local agents exist. In many cases plastic film suitable for vacuum packing will have to be imported. Even if a small- or medium-scale enterprise can identify an overseas supplier prepared to export, the minimum orders required are generally very large and often enough for many months of production.

Imported packaging is made by large companies that invariably have strict quality control procedures. This means that the buyer is unlikely to encounter problems with poor quality. When purchasing packaging, however, it is important to request a quality specification in case of any problems or disputes. In addition, advice should be obtained about storage conditions and use.

Particular attention will need to be paid to the quality of paper used for self-adhesive labelling of meat and fish products that are to be chilled or frozen. Such labels are exposed to very damp and often wet conditions and the paper must not soften or the adhesive dissolve, as the label will then fall off. Special paper suitable for use in refrigerators and freezers may be difficult to find in many ACP countries.

All packaging should be inspected on receipt and it is recommended that a sample from each delivery should be kept for reference purposes. If printed packaging or labels are used they should be carefully inspected for any errors in wording.

Case study 6.1 illustrates how successful meat and fish processing enterprises obtain good quality raw materials and packaging.

### **Case Study 6.1 Raw materials and packaging**

An entrepreneur in Tanzania obtains his sausage casings and packaging materials from South Africa. 'The quality is consistent and as packaging represents only 10% of costs, it is not expensive. Buying in bulk and paying the local importer in cash keeps the cost down. The quality of spices in the local market is not consistent but my company identifies specific suppliers who can fulfil our needs.'

A business in the Caribbean imports their pork from the Netherlands. 'The pork arrives frozen and we store it in our freezers. We also buy imported beef, obtaining it from local importers as we need it. We buy local chickens from a farmer who provides valid health inspection certificates. Other ingredients, such as spices and smoke flavours, are imported on a 'cash with order' basis from England. The vacuum packing film comes from Canada and the bacon boards come from Barbados. We are happy with the quality of materials and packaging and have never had any problems. Packaging is expensive and represents 50% of costs.'

A Ghanaian entrepreneur preparing shrimp-and-fish-based pepper sauce buys all her ingredients locally. 'The quality of the dried shrimp is consistent providing I buy from suppliers in the Volta region. The same is



true of the dried smoked herrings, which must be really dry and crispy. I am happy with the quality of all ingredients. Glass packaging, however, is a problem since the local factory closed. Imported jars are expensive and the price fluctuates depending on the exchange rate. Packaging represents about 20% of costs. But we feel it's worth the price as our packaging and labels give us a strong brand image.'

A similar business, also in Ghana, buys a range of ingredients to produce fish and shrimp sauce and dry fish and shrimp powder. 'The quality is usually consistent but only if we buy from regular suppliers. This requires a lot of organisation and follow-up calls. Recently food prices have become so expensive that we have set up our own farm. Packaging is very expensive and represents 20-30% of costs. For example, the packaging of dry shrimp powder requires a special paper/aluminium laminate. Other packaging includes bottles, plastic films, laminates, plastic containers and cardboard boxes, and these are supplied on a contract basis by packaging suppliers and through links we have established with an international company, Lever Brothers. We have occasionally had problems with plastic film thickness and had to return it. We have a food technologist to advise us on packaging when a new product is developed.'

A Zambian meat processor reports: 'We have two local importers of packaging and we obtain all packaging and casings, both natural and artificial, from them'.

### ***6.3 Plant inspection and routine cleaning***

---

All too often, small- and medium-scale food processing enterprises leave their cleaning jobs until the end of the day. When production stops, the workers are expected to clean thoroughly before they go home. In this situation, it is not surprising that they tend to rush the cleaning routine in order to leave work on time.

Cleaning and inspection should be a planned management activity that carries a cost for the time and materials used. All businesses should design a cleaning schedule indicating:

- which item of equipment or part of the plant is to be cleaned
- who is responsible for the task
- how frequently the work is to be done
- a realistic time for the task.

The residue or 'soil' produced in a meat and fish processing enterprise is high in protein and fat and makes cleaning difficult. Cleaning should involve the following stages:

- dismantle all machines and remove all gross soil from machines by hand and with brushes and dispose of this in covered bins
- wash down with chlorinated water using pressure hoses
- wash all equipment with hot water and detergent
- sanitise with chlorinated water
- where possible, allow equipment and surfaces to air-dry. Wiping with cloths can lead to re-contamination.

If cloths are to be used, use green or blue ones. Cloths lose threads and coloured material can be seen more easily than white. If available, brushes with coloured bristles are preferred for the same reason.

Large companies and large hotels often use special cleaning compounds designed to deal with the type of soil (containing fat and protein) resulting from meat and fish processing. If these specialised cleaning compounds are locally available their use should be investigated.

An example of a simple cleaning and inspection schedule for a small enterprise producing smoked fish is shown in Fig. 6.2. The schedule for a more complex plant producing a wide range of products will clearly be more extensive and require careful design. It should contain elements requiring hourly, daily, weekly, monthly and annual maintenance and cleaning.

 *All maintenance schedules should be documented*

Cleaning routines operated by successful meat and fish processing enterprises are illustrated in Case study 6.2.

Task	Responsible	When	How
Clean cutting boards	Peter	As soon as all fish has been prepared	Wash with detergent, followed by bleach wash. Allow to air-dry
Wash fish boxes	Peter	When all are empty	Wash with clean water and bleach, invert and allow to dry
Re-sharpen all knives	Jane	Every two days	Wash, sharpen and dry
Wash all knives	Jane	Daily, as soon as all fish has been prepared	In clean water with detergent, air-dry
Clean all smoker trays	Peter	After removing from the smoker and emptying	Strong brush and detergent wash, allow to air-dry. Check for any damage and report
Check smoker for damage	Peter	Weekly	Report and repair as needed

Fig. 6.2 Example of a cleaning and maintenance schedule for a small fish smoking enterprise

Workers require training in order to carry out efficient cleaning. They will need to be shown, for example, how to dismantle a meat mincer or a sausage stuffer and how to clean all the different parts. Most importantly, they should understand the importance of cleaning and the responsibility they have to produce products that do not endanger public health.

### Case study 6.2 Cleaning and maintenance

A Ghanaian university has its own meat processing department, where they operate a planned cleaning system. 'Routine cleaning is done at the end of every day. At the end of each week we carry out more thorough cleaning of the plant. In January each year the plant is closed for a month to allow cleaning and de-contamination by a specialist company. At the same time, complete maintenance of all equipment, facilities and the local environment takes place. The university has a schedule to maintain and repair the equipment and there have been very few occasions when a breakdown has stopped production.'

'We have an organised cleaning schedule. The plant is cleaned twice each day – before production starts and at the end of the day. We also have a

maintenance schedule but it is not documented\*. Maintenance is done in-house and we pay particular attention to the stand-by generator.'

'We conduct preventative maintenance and have two technical experts in the workforce. One is a mechanical engineer and the other a refrigeration engineer. We also carry out regular rodent and insect control as well as cleaning and sanitising the plant and equipment. We have two policies: 'clean as you work' and 'mid-shift cleaning', which takes place, for example, before tea breaks, lunch and at the end of the day.'

'In our company we have an electrician and an engineer who maintain all the equipment and especially the cold rooms. Cold room temperatures are checked every day. We also have a two-weekly rodent and pest control programme. The plant is cleaned at the end of each day and fully disinfected weekly.'

\*All maintenance schedules should be documented.

## *6.4 Process control*

---

An important production aim is to manufacture products of a consistent quality. To achieve this, processors must use a standard recipe and a standard processing procedure. Standardising the processing procedure involves controlling the whole process, from receipt of raw materials to dispatch of finished goods. Critical points, known as process control points, need to be identified where checks and measurements can be made. A process control schedule should be prepared for each product made. Critical process control checks are simple, for example, checking times, temperatures and weights. Table 6.1 illustrates the use of process control points for ham production.

Step in process	Activity	Control points
Raw materials	Check quality of meat, salt used in brine, sugar and cure	Meat quality inspection Test salt quality Confirm correct cure mix is being used
Meat preparation	Remove bones and excess fat, cut into joints	Inspect joints and check that they are of suitable weight
Preparation of cure	Dissolve cure ingredients in water to set recipe	Record all weights and amount of water used
Cure	Cure for 3 days at below 7°C	Log time in cure and check temperature twice daily
Cook hams	Boil in water in plastic bags according to weight	Weigh all hams and refer to weight/boiling time data
Cool	Cool in cold chlorinated water to below 15°C	Use probe thermometer in largest ham
Label	Label according to weight	Check weigh each ham and verify label
Refrigerate	Hold below 4°C	Check internal temperatures

Table 6.1 Example of use of critical control points in ham production

## *6.5 Quality assurance methods and records*

The differences between quality assurance (QA) and quality control (QC) and their importance are described in Volume 1 of this series. While several of the QA and QC methods required for meat and fish products are, for cost reasons, beyond the capacity of small- and medium-scale enterprises, a number of low cost QA measures can be routinely carried out in-house.

*It is vital that all QA and QC results are recorded.*

### *Microbiological quality*

This is of prime importance when processing meat or fish, particularly the high risk products described in section 6.1. These products (lightly cured hams, cold smoked fish and pâtés) carry a very high risk and require greater attention to microbial standards. It is unlikely that any small- or medium-scale enterprises will have the resources or expertise to carry out microbiological analysis. The one exception in the surveys was the Ghanaian university (see Case study 4.1). However, it is very important that microbiological tests are

carried out and this is best done by contracting the services of a local institution. The following general areas will require consideration:

- testing of raw materials, in particular the fish and meat and any herbs and spices used. This is especially important if new suppliers are being used or new products are being developed
- testing the sanitation of equipment after cleaning. Here, a technique known as swabbing is used to determine the cleanliness of surfaces<sup>9</sup>
- health checks on staff. Staff suffering from septic cuts or stomach disorders may be harbouring potentially dangerous organisms such as salmonella and staphylococcus. All workers should have regular checks to show that they are fit to handle food
- checks on the final product. These include periodic checks on the product as it leaves the plant and checks on shelf life samples that have reached their use-by date.

*Workers may view health checks as threatening as they may be afraid of losing their job if they are found to be positive. Such checks should be carried out in a sensitive way, with workers assured that they will be employed on other duties until the problem is resolved.*

### *Sodium nitrate and nitrite*

These preservatives find wide use in cured meat products and the residual levels are controlled by law (see Table 6.4 on page 168). The chemical tests used to determine nitrate and nitrite will be beyond the capacity of most small enterprises and will need to be contracted out. Provided a standard recipe and process are used, checks will only be required when new products are made or curing salts are bought from new suppliers.

### *Brine strengths*

As described in Chapters 4 and 5, it is very important that the brines used for curing meat and fish products are correctly prepared and maintained by

---

<sup>9</sup> *Swabbing involves wiping the surface with a sterile swab of cloth. The cloth is incubated in a laboratory and the type and number of any growing organisms are determined. It provides clear information on the cleanliness of the item being checked.*

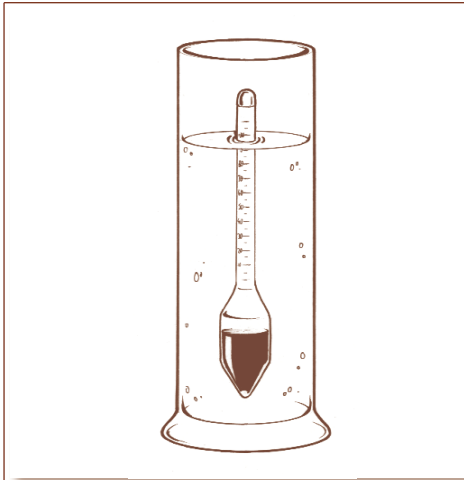

Fig. 6.3 Salometer used to test brine strength

adding strong brine to adjust for the water released from the food being cured. The simplest way to measure the salt concentration in brines is to use a salometer. A salometer is a carefully calibrated glass bulb that measures the density (salt content) of the brine. A sample of brine is placed in the testing cylinder and the salometer is allowed to float unhindered by the walls of the cylinder. The reading in degrees is taken as shown in Fig. 6.3. The relationship between salometer readings and salt concentration is shown in Table 6.2.

Salometer reading (°)	% salt (wt of salt/wt of water)	Salt (g/litre of water)
9.5	2.5	26
18.9	5.0	53
28.3	7.5	81
37.7	10.0	112
47.1	12.5	143
56.6	15.0	174
66.0	17.5	211
75.5	20.0	249
84.9	22.5	292
94.5	25.0	340
100.0	26.5	360

Table 6.2 Relationship between salometer readings and salt content

## Net weight

The declaration of net weight is a legal requirement and is simple to check. A set of scales will be required as shown in Fig. 6.4. The simplest way to check net weight is to place the packaging material on the pan of the scales and adjust the scales to zero. Packs can then be quickly checked for the net weight (weight without packaging). As described in Chapter 4 special scales are available that automatically print a label with the net weight and price.

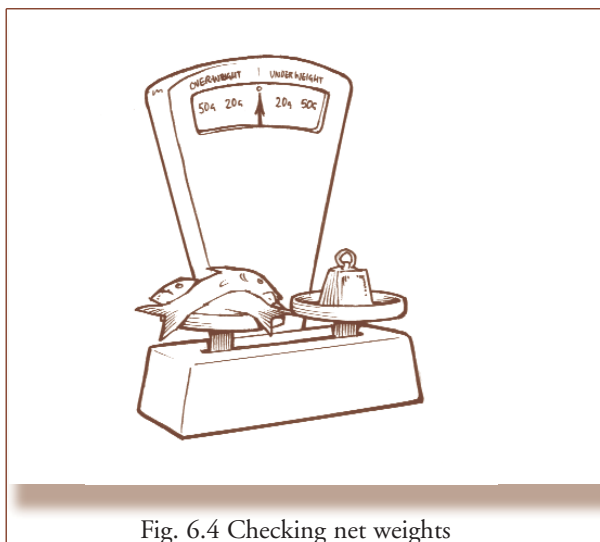

Fig. 6.4 Checking net weights

## Chlorine content of water

As described in Chapter 3, the use of chlorinated water for production and cleaning is very important to ensure the hygienic operation of a meat or fish processing plant. The determination of chlorine levels can be quickly carried out using a colorimetric test in which a chemical dye reacts with the chlorine to produce a colour that is proportional to the amount of chlorine present.

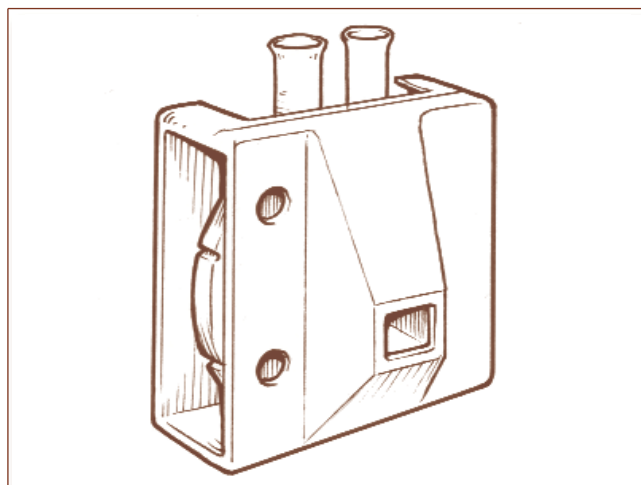

Fig. 6.5 A comparator for checking chlorine levels in water

The test requires the use of a 'Lovibond comparator', as shown in Fig. 6.5.



This comparator is supplied with discs of coloured glass that indicate different levels of chlorine. A few drops of dye are added to a test tube containing a sample of the water. The resulting colour is compared to that of the standard disks supplied in the kit. This equipment is very similar to that used to check the chlorine content of swimming pool water and local suppliers may be able to assist.

### *Moisture content*

The determination of moisture content requires the use of an expensive, very sensitive balance and samples will require external testing if concerns about moisture content arise.

## *6.6 Summary of legislation*

All enterprises will have to comply with local legislation, the demands, complexity and enforcement of which vary from country to country. These are discussed in more detail in Volume 1 (Chapter 6).

Legislation governing food processing enterprises is particularly demanding as all foods carry a public health risk. In most countries, the legal demands on food production and processing are related to the potential level of risk to consumers. A greater degree of control will exist for high risk foods, which include meat, fish and milk, than for lower risk products such as bread, jams and pickles. Special regulations may govern the manufacture and sale of particularly high risk meat and fish products, such as hams and pâtés, which are eaten cold without cooking. Five broad areas of legislation will need to be considered:

1. Legislation related to the status of the business
2. Labour laws: working conditions, hours of work etc.
3. Veterinary requirements associated with meat processing
4. Laws governing the location, design and safety of the plant including, for example, waste discharge
5. Specific legislation related to the range of products made and their labelling.

Interviews with enterprises producing meat and fish products revealed that all owners were very aware of their legal responsibilities (Case study 6.3).

### **Case study 6.3 Complying with local legal requirements**

‘Although my business is very small, I observe strict hygiene measures and follow all regulations governing food processing. For example, all my workers have health checks every three months and I insist that they wear recommended uniforms and protective gear.’

‘The meat plant is registered for processing by both the university and the Kumasi Metropolitan Assembly. All workers have to meet health requirements for working with food. This is monitored by the university Health and Safety Unit.’

‘Yes, this business is fully registered for food production. We have made sure our labels meet legal requirements and all our workers have health certificates to say they can work with foods. We pay all required taxes, for example company tax, income tax and import duties. We have received some incentives from Government in this area.’

‘This company went through the normal legal requirements for establishing a business and is registered as a company owned by its shareholders. We meet local safety measures, for example, we have fire extinguishers, and we comply with safety regulations as laid down by the Local Authority. Workers undergo a medical examination, as required by law, and the premises are inspected by the Local Authority before they issue our manufacturing licence. All our labels comply with the law including a ‘best before’ date. We have relationships with the Veterinary Department and inspectors from the Ministry of Health for meat inspection as well as the Ministry of Local Government and Housing for licensing. To be frank, the company does not really understand the roles of all these bodies. We would like to see their roles more clearly defined. Despite this, we are happy that our relationships with the Veterinary Department and Ministry of Health have been formalised. Without inspections, we could not process any meat!’

### Regulations related to the business

The formal registration of a meat or fish processing business will involve some or all of the following, depending on the country and the structure of the company (e.g. sole trader, limited company):

- registration of the enterprise with the Ministry of Commerce or Trade and Industry
- if a limited company is to be formed, certificates of share capital will be needed. In the case of a corporate company a certificate of incorporation will be required
- an occupational certificate will also be required from the local or planning authorities. This allows the enterprise to occupy, but not use, the plant
- the company will also be required to register with the tax authorities for direct taxation and, where appropriate, for VAT.

### Regulations related to the processing plant and production

These regulations govern all aspects related to the operation of the processing facility and may include:

- obtaining a health permit from the Ministry of Health or Local Authority licensing the premises to be used for food production
- obtaining a manufacturing licence from the Local Authority or Ministry of Health
- obtaining veterinary certificates stating that meat is fit for human consumption
- obtaining medical certificates from the Health Authority to certify that workers are fit to handle food
- if a steam boiler is to be installed, a boiler inspection certificate may be required
- special certificates may be required related to the use of hazardous materials and waste discharges.

### Food regulations and standards

Two main types of food regulations exist: general regulations that apply to all foods and those that are specific to a particular type of food. In addition

there are other regulations related, for example, to the use of plastic packaging materials or food additives. The general regulations governing labelling, advertising, weights and measures and hygienic practice when handling foods are described in Volume 1 (Chapter 6). In most countries the introduction of food laws is the responsibility of the relevant Ministry and the application of the regulations is the responsibility of the standards institution and bodies such as public health and trading standards.

The last few decades have seen a trend towards international standardisation of food legislation in order to promote international trade. The three key bodies involved are:

- Food and Agriculture Organization (FAO)
- World Health Organization (WHO)
- World Trade Organization (WTO).

A central component of the development of international regulations is the Codex Alimentarius (a joint body of FAO and WHO). The Codex Alimentarius Commission (CAC) is based within FAO in Rome. Codex standards include processing conditions, labelling, advertising, weights and measures and food and raw material quality standards.

Membership confers no obligations but allows countries to contribute and have their opinions heard. With time, however, the introduction of standard norms is expected. Most ACP countries are Codex members. All member countries have a focal point, usually within the Ministry of Trade and Industry, Health or Agriculture, or a standards institution where information on Codex standards can be obtained. The role of the WTO is focused on technical barriers to international trade, for example international sanitary or phytosanitary measures.

Meat and fish processors should contact the responsible Ministry and request copies of National and Codex regulations related to their range of products. As the regulations tend to be written in language that is not easy to understand, the entrepreneur may wish to seek advice from a university or standards institution.

## Meat content

Many countries will have regulations related to both the total and the lean meat content of products such as sausages and burgers. Regulations commonly in force in Europe are summarised in Table 6.3.

Product	Minimum meat content	Minimum lean meat content	Special conditions
Burger, except economy burger or hamburger	80%	65% of total meat	
Economy burger	60%	65% of total meat	
Hamburger	80%	65% of total meat	Meat must be beef or pork or mixture of the two
Pork link sausage, chipolata, sausage meat	65%	50%	80% of the meat must be pork
Beef link sausage, chipolata, sausage meat	50%	50%	50% of the meat used must be beef
Pâté	70%	50%	Fish pâté must contain at least 70% fish

### **Definitions**

Meat content is the sum of the total weight of meat (calculated as raw meat) used in the preparation of the product and indicated in the product name, expressed as a percentage of the total weight of the product sold. Lean meat is the total weight of lean meat free, when raw, of any sign of visible fat.

Table 6.3 Example of meat content regulations

## Food additives

Food additives regulations define the legal limits for preservatives and colours. These regulations are of greater importance to meat than to fish processors. The principal additives of interest are the preservatives sodium nitrate, sodium nitrite, sulphur dioxide, polyphosphates and ascorbic acid which are widely used in the production of fresh and cured meats. Typical accepted legal limits for nitrate and nitrite are shown in Table 6.4. It is strongly recommended that manufacturers of meat and fish products consult

with their local standards agency, or other responsible body, regarding current local legislation and any changes that may result from membership of Codex.

<b>Product</b>	<b>Sodium nitrate plus nitrite (expressed as nitrite ppm)</b>	<b>Max. nitrite (ppm)</b>
Acidified or fermented meats	400	50
Bacon and ham	500	200
Other cured meats	250	150

Table 6.4 Permitted levels of nitrate and nitrite in meat products  
(UK Preservatives in Food Regulations)

## ***6.7 Labelling legislation***

All ACP countries have legal requirements regarding the labelling of food products. The legislation, and the degree to which it is enforced, will vary from country to country. As a minimum requirement the product should have a label that clearly states:

- name and address of the producer with sufficient information for a customer to contact the manufacturer
- net weight. It should be noted that products such as smoked fish fillets or hams that vary in weight from pack to pack must be individually weighed and the specific weight declared
- list of ingredients in decreasing order of content. In many cases minor ingredients, such as sodium nitrate or colours, may be identified by their appropriate E number
- in many countries a public health registration number may have to be declared
- use-by date.

Additional information, some of which is of great importance if the consumer is to be protected, may also be required or expected including:

- storage recommendations
- nutritional information
- specific warnings such as 'this product contains nuts' to warn those with allergies
- cooking and preparation suggestions.

## *6.8 Environmental considerations*

---

Consideration of negative environmental impact is increasingly becoming an area of concern. In many ACP countries, environmental laws are in place to control pollution and damage by industrial activities. In many cases large food processing companies have to include an environmental analysis in their business plan.

Small- and medium-scale enterprises produce lower volumes of effluent and pollution than large companies. However, the volume per unit of output is generally higher as the production and effluent treatment systems tend to be less efficient than those in large companies. Owners have a responsibility to ensure that minimal damage is done to the environment. It is advised that contact should be made with the local responsible agency to find out what requirements are in place and if any changes are expected.

The main potentially damaging wastes produced by small- and medium-scale meat and fish processors are:

- solid waste of animal origin such as skin, bones and trimmings
- liquid animal waste, in particular blood, small meat particles and fat that drain from the plant
- brines containing small amounts of animal waste and fat
- smoke from smoking operations
- miscellaneous materials such as packaging.

Brines can be very damaging if discharged into streams or rivers. They will kill life below the point of discharge and may also get into the soil, increasing its salinity and lowering its fertility. It is recommended that brines should either be discharged into the municipal drains or, if this is not possible, be stored in plastic drums that can be taken to a municipal drainage site. The same applies to liquid animal waste. Good practice in the disposal of animal waste has been described in Chapter 3. Wherever possible smokers should be situated away from and downwind of houses to minimise any nuisance. Packaging, and in particular plastic, should be bagged and disposed of by the local municipality.

Case study 6.4 describes a business that has taken account of environmental factors in its design and location.

#### **Case study 6.4 Planning for good hygiene**

A producer in Zambia operates from a plant that was set up outside town for a supply of clean water and fresh air. 'As you see the site is on a slope which is important as this type of business uses a lot of water and good drainage is important. The plant was designed by the two main shareholders, one a butcher the other a mechanical engineer. We also had inputs from an architect and a civil engineer. Most of the equipment is imported but we designed and built the cold rooms ourselves from imported materials. It is important that the equipment layout is linear to avoid cross-contamination. We have 45 workers and average about 1000 kg of products per day working from 07.30 to 17.00 hours. The first half-hour of the day is for workers to wash and shower and the last half-hour is devoted to cleaning. We produce smoked and cooked sausages, hams, salami and bacon.'



## Summary of the chapter

- ✓ It is important to analyse the public health risks associated with your products and to put systems in place to maximise consumer protection
- ✓ Involve customers in shops and hotels in your risk analysis programme
- ✓ Spices can be a major source of microbiological contamination so have them tested
- ✓ Identify reliable sources of raw materials and agree on quality specifications
- ✓ Buy packaging against a specification
- ✓ It is important to establish formal cleaning schedules. Poor cleaning can result in contamination
- ✓ A planned preventative maintenance programme will avoid costly shutdowns. Hold stocks of vital spares
- ✓ Strict control of all stages of a process will allow a uniform product to be made
- ✓ Carry out simple quality control checks and contract out other testing as needed. Cost quality testing into the price of the product
- ✓ Obtain copies of legislation related to your product range and make sure you understand it
- ✓ An awareness of responsibilities related to environmental pollution is becoming increasingly important.







This chapter examines the aspects of financial management that are specifically relevant to businesses involved in meat and fish processing and highlights specific opportunities and problems that may arise.

## 7.1 Start-up costs

One of the first problems facing a small-scale enterprise is raising the capital to start the business. The capital outlay is greater when processing meat due to the need to purchase specialised equipment such as mincers, fillers and smokers. Very small enterprises processing fish using improved traditional methods can, on the other hand, start with minimal finance. All businesses, however, incur other start-up costs including:

- conducting a feasibility study and preparing a business plan
- obtaining licences and health certificates
- recruiting and training staff
- buying ingredients and packaging before receiving income from sales.

The financing of a meat or fish processing business should therefore be based on a detailed feasibility study (as described in Volume 1) that takes all costs into account. It is likely that funds will be required in stages (see Table 7.1) and this should be planned for when arranging a loan or discussing the business proposal with potential investors. It is important to keep records and

### Tips for success

- ✓ All profits belong to the business and not to the owner
- ✓ Make sure that all products are profitable
- ✓ Keep records of all expenditure to reduce your tax bill
- ✓ Book-keeping should be carried out every day
- ✓ Motivated workers will contribute to profits
- ✓ All activities, including quality assurance and cleaning, are a cost
- ✓ Get advice from an accountant who is familiar with local tax legislation
- ✓ **Finally:** Read Chapters 7 and 8 in Volume 1: *Setting up and running a small food business*.

evidence of start-up costs as these may be considered as allowable costs that can be offset against tax in the first year of operation. Potential sources of funding are described in Volume 1.

Stage	Finance required
Initial idea	Travel to get information for feasibility study and to meet potential investors
Planning	Travel to meet equipment suppliers, builders etc.
Establishing the factory	Constructing or modifying a building, installing services, buying equipment, advertising, recruiting and training staff, travel to meet raw material suppliers and retailers
Commissioning	Testing equipment, buying raw materials, ingredients and packaging, establishing production routines, training staff
Starting production	Production costs
After start-up	Bulk supplies of raw materials or packaging, additional finance to keep a positive cash flow

Table 7.1 Phases and funding for a new business

## *7.2 Production costs*

Fixed costs (or overheads) include office costs, interest on loans, depreciation etc. and are similar for all types of business, but there are differences in variable costs between small enterprises producing dried, salted or smoked fish and those involved in meat processing. Fixed and variable costs are described further in Chapter 7 of Volume 1. Data from surveys conducted in the preparation of this book indicate that worker skill levels required by companies producing a range of meat products or fish-based sauces are higher than those required by companies making traditional fish products. Higher salary costs for skilled workers will thus impact on production costs. Most of the enterprises producing non-traditional meat and fish products placed considerable emphasis on the need for good staff training. Training costs therefore add to production costs, although in some ACP countries they may be regarded as tax deductible, particularly if external trainers are hired.

Businesses producing non-traditional meat and fish products will have additional costs that should be counted in the cost of production.

These include:

- use of expensive ingredients (preservatives, seasonings, colours etc.)
- need to buy in specialist services (microbiological testing, boiler inspection and insurance, product analysis)
- losses and costs related to the very short shelf life of the products (e.g. unsold stock, returned goods, time spent on customer care)
- time and materials used to maintain cleaning schedules which might, for example, require all workers to spend one hour each day on cleaning tasks.

### *7.3 Managing finances*

---

When a meat or fish processing enterprise starts production the owner should have one central aim: to cover all costs and to make a profit. In too many cases businesses fail because the owners consider the profits to be theirs – and use the money to pay for a holiday or a new car, perhaps!

*It should always be remembered that the owner should take a set salary and that any profits belong to the business.*

Profits should primarily be used to develop the business by, for example, funding advertising or promotion, developing new products or improving the skills of workers. While it is perfectly reasonable for the owners to increase their salaries if the business is doing well, this should be a carefully considered decision. The three essentials to managing profitability involve:

1. Maintaining, or preferably increasing, income from sales
2. Controlling, or preferably reducing, costs
3. Maintaining a positive cash flow so that the business can always meet its costs and obligations.

To achieve this it is necessary to have all other aspects of the business, such as marketing and sales, quality assurance, cleaning and maintenance, customer care and stock control operating successfully. All of these activities should be planned and provided with a budget. Correct financial management involves:

- setting the correct prices for products
- controlling costs
- managing cash flow
- book-keeping.

## Pricing products

Details of different methods for costing a product to determine its price are described in Volume 1. Product costing for a small enterprise with a single product, such as smoked fish or hamburgers, is relatively straightforward because:

- there are a limited number of raw materials
- only one production method and few items of equipment are used, therefore equipment depreciation costs are easy to calculate
- there is little variation in market prices for products.

Calculating costs becomes more complex in an enterprise producing a wide range of products such as hams, bacon, sausages and pâtés. Very careful and detailed analysis is required, not only to cost individual products but also to decide which are the most profitable. Labour costs need to be timed and divided between different products. One worker may, for example, spend two hours on sausage making, three hours on bacon production, one hour on smoking and one hour on general cleaning in any given day. These times will need to be measured and fed into a calculation of person time per unit of production. Cleaning, for example, would generally be spread equally as a form of 'indirect overhead' on each product.

Calculating depreciation in a multi-product facility can be complex as one item of equipment may be used to make several products while another finds specific use for making one product only. An example of the type of analysis required to apportion depreciation costs (in hours per week) in a complex production unit is shown in Table 7.2.

Equipment	Cost US\$	Fresh sausage	Smoked sausage	Smoked bacon	Pâté
Bowl chopper	800	4 hours	2 hours		2 hours
Sausage stuffer	300	4 hours	2 hours		
Smoker	500		8 hours	7 hours	
Brine tanks	300			15 hours	
Cooker	200				6 hours

Table 7.2 Apportioning time usage to equipment in order to calculate depreciation



Accurate product costing should not be regarded as an academic, paper exercise. It should be used to determine:

- which products are most profitable
- if the product can match the prices of the competition
- where, and how, savings can be made in order to reduce costs.

Meat and fish processors supplying traditional lower income markets will have little price flexibility as their customers will be greatly influenced by value for money. Enterprises selling non-traditional foods to middle- and upper-class consumers have a greater pricing flexibility as sales will be influenced by factors other than price (e.g. presentation and packaging).

### *Controlling costs*

The main costs for meat and fish processors are the raw materials, labour, power charges and, in the case of enterprises making non-traditional products, overheads. Given the highly perishable nature of meat and fish, the prime raw materials, bulk buying for later processing is not an option unless large deep freezers are available. The use of direct contract purchasing from fishermen and farmers can, however, provide a way to reduce costs and, equally importantly, assure quality. Contracts also provide the opportunity to stabilise prices, which is very important given that costing products is extremely difficult when the cost of the prime raw material is highly variable.

The quality of raw materials can have a major influence on profitability. For example, beef with a low carcass weight will have a higher ratio of bone to meat than heavier, well fattened animals. Similarly, large fish will provide more weight of fillets than small ones. The relationship between kg of raw material and kg of final product is a key financial factor.

The profitability of an enterprise also depends on the productivity of the workers and equipment. Motivated workers with a loyalty to the business have the potential to greatly increase productivity. While the terms and conditions of employment and benefits given are important, developing a feeling of 'self-worth and belonging' is vital to encourage high productivity.

One piece of equipment that has broken down can stop the entire production chain. Until it is repaired, income will fall or at worst cease while fixed costs continue to be paid. Proper production planning that includes preventative maintenance will reduce machine downtime and keep production costs down. It may appear expensive to have machine spare parts unused in store but keeping spares should be regarded as an insurance against breakdown and will allow repairs to be done rapidly. This is particularly true of imported equipment where new parts may take weeks or even months to arrive.

Some ingredients used in meat and fish processing, such as seasonings, are very expensive and have a limited life in tropical conditions if not correctly stored. Good stock control that maintains minimum stocks but ensures continual production is vitally important to cash flow. It is also important to keep records on yields, for example when boning meat, to make sure workers maintain a consistent efficiency of meat recovery. Losses in yield will reflect on profitability.

Finally, many meat and fish processing enterprises will use a lot of energy for refrigeration and air conditioning. This energy must be used efficiently to minimise costs. Routine checking of temperatures, reminding staff to close doors and a general awareness regarding electricity use can help control costs.

### *Managing cash flow*

Understanding how cash flows in and out of the business during a specific period (e.g. a month or a quarter) enables the owner of an enterprise to ensure that there is always sufficient money to keep the business operational (i.e. maintain a positive cash flow). Cash flow records are similar to income and expenditure statements, but also indicate whether the business is generating profits or making losses. Details of how to calculate cash flow and the break-even point of a business are given in Volume 1.

Cash flow can also be managed by keeping control over the number of debtors and the amount of money that they owe the business, and by arranging with suppliers to have a larger credit limit or a longer period before payment is due.

## Book-keeping

The types of financial records that should be kept by small-scale food businesses are described in detail in Volume 1. Keeping up-to-date, accurate records is necessary to successfully price products, keep control over production costs and cash flow and meet the requirements of local tax authorities. Book-keeping should be regarded as an integral part of each working day and not as an 'extra chore'. All enterprises should set up a series of journals covering income/sales, expenditure, wages etc. that allow easy analysis either by the owner or a hired accountant. Remember: the better the records, the easier the accountant's job and the lower the bill. For accountancy purposes a record of business assets in the business (e.g. cash, machinery, stocks of materials etc.), plus any liabilities (loans, creditors, taxes owed etc.) will be required. The value of keeping good records is illustrated by Case studies 3.8 and 7.1.

### **Case study 7.1 The importance of financial records**

Mrs B. produces a range of products including fried fish. After many years in business she has recently started to keep records. She has received training from a non-government organisation and, as she is illiterate, her daughter now helps her with record-keeping. By local standards she is a very good businesswoman and makes good profits. She advises: 'A good business person needs to be smart and record how much profit she makes every day.'

Mrs Q. learnt the importance of good record-keeping the hard way. She was very busy establishing the business and a new hotel and failed to keep production records. Only later did she discover that her sauce business had been making a loss. She says records must be kept for each batch to determine whether the cost of production allows a reasonable profit to be made.

## Summary of the chapter

- ✓ It is important that realistic start-up costs are estimated and that all finance is in place before starting the business and incurring major expenditure
- ✓ Records of start-up costs should be kept as it may be possible to offset them against tax
- ✓ Be sure you have sufficient funds of your own to cover initial costs
- ✓ Make sure the enterprise maintains a positive cash flow and is in profit
- ✓ The division of costs in a multi-product enterprise can be complex. Seek advice so that you know which products are most profitable
- ✓ Train, retain and respect good workers.

## Entrepreneur's checklist

Can you detail all the start-up costs for the new business or an expansion of an existing enterprise?

Is all finance in place?

Do you know the profitability of the different products that you produce?

Do you use the financial data you record to check on profitability?

Have the business projections of expected income and expenditure over the longer term (quarterly and annually) been achieved?

Do you have adequate insurance for your building, stocks, third party liability and industrial accidents?



# Appendix I

## *Institutions offering support to small-scale enterprises*

---

The following institutions in ACP countries are able to provide advice and assistance to meat and fish processing enterprises:

**Animal Science Department, Food Research Institute**, University of Cape Coast, Cape Coast, Ghana.  
Tel: 233 42 32480/83, 32440/4.  
Email: ucclib@ucc.gn.apc.org

**Animal Science Department**, Kwame Nkrumah University of Science and Technology, Kumasi, Ghana.  
Tel: 233 51 60325.  
Email: agricfac@africaonline.com.gh

**Animal Science Department**, University of Ghana, Legon, Ghana.  
E-mail: agriclib@ug.edu.gh

**Antigua and Barbuda Bureau of Standards (ABBS)**, PO Box 110, St. John's, Antigua.  
Tel: 1 (268) 462 1542/2424.  
Fax: 1 (268) 462 1625. E-mail: abbs@candw.ag

**Barbados National Bureau of Standards (BNSI)**. Flodden, Calloden Road, St. Michael, Barbados.  
Tel: 1 (246) 426 3870.  
Fax: 1 (246) 436 1495. E-mail: dbr@bnsi.com.bb

**Botswana Technology Centre**, PO Box 0082, Gabarone, Botswana. Mkebakile@hotmail.com.

**Caribbean Export Development Agency**, PO Box 34B, Brittons Hill, St. Michael, Barbados.  
Tel: 1 (246) 436 0578. Fax: 1 (246) 436 9999.  
E-mail: lseon@carib-export.com

**Caribbean Industrial Research Institute (CARIRI)**, Tunapuna Post Office, Trinidad.  
Tel: 1 (868) 662 7161/7163.  
Fax: 1 (868) 662 7177. E-mail: cariri@tsstt.net.tt

**Central Board of Health**, Ndeke House, PO Box 32588, Lusaka, Zambia. Tel: 00 260 125 3179-84

**Chemistry and Food Technology Division**, Ministry of Agriculture, Fisheries and Lands, Dunbars, Antigua. Tel: 1 (268) 462 4502/1213.  
Fax: 1 (268) 462 6281/6104.  
E-mail: moa@candw.ag

**Chemistry, Food and Drugs Division**, 92 Frederick Street, Port of Spain, Trinidad.  
Tel: 1 (868) 623 5242. Fax: 1 (868) 623 2477.  
E-mail: cfdd@carib-link.net

**Confederation of Tanzania Industries**, 10th Floor, NIC Investment House, Samora Avenue, PO Box 71783, Dar es Salaam, Tanzania.  
Tel: 255 222 114954/123802.  
Fax: 255 222 115414. E-mail: cti@cats-net.com

**Council for Scientific and Industrial Research**, PO Box M20, Accra, Ghana.  
Tel: 233 21 777330/ 761209/ 777647.  
E-mail: fri@ghana.com

**Department of Fisheries**, Ministry of Natural Resources and Tourism, PO Box 2462, Dar es Salaam, Tanzania. Tel: 255 222 116159/62.

**Department of Food Science & Technology,**  
Sokoine University of Agriculture, PO Box  
3006, Morogoro, Tanzania. Tel: 255 23 4402.  
Fax: 255 23 4562/3259.

**Department of Food Science and Technology,**  
Makerere University, PO Box 7062, Kampala,  
Uganda. E-mail: foodtech@infocom.co.ug

**Dominica Bureau of Standards,** 28 Kennedy  
Drive, 1st Floor, Roseau, Dominica.  
Tel: 1 (767) 448 1685. Fax: 1 (767) 449 9217.  
E-mail: standards@cwdom.du

**FATECO Ltd.,** PO Box 9899, Accra, Ghana.

**Food Science and Technology Department,**  
University of Zambia, PO Box 32379, Lusaka,  
Zambia. Tel: 260 1 293727

**Food Technology Institute,** Scientific Research  
Council, Hope Gardens, PO Box 350, Kingston  
6, Jamaica. Tel: 1 (876) 977 9316.  
Fax: 1 (876) 977 2194.  
E-mail: ftihead@cwjamaica.com

**Ghana Export Promotion Council,** PO Box  
M146, Accra, Ghana.  
Tel: 233 21 228813/228830.  
E-mail: gepc@ghana.com

**Ghana Standards Board,** PO Box MB245, Accra,  
Ghana. Tel: 233 21 500065/500066.  
E-mail: gsbdir@ghana.com

**Government Chemist Laboratory,**  
PO Box 164, Dar es Salaam, Tanzania.  
Tel: 255 222 113383/4. Fax: 255 222 113320.

**Grenada Bureau of Standards (GDBS),** Lagoon  
Road, St Georges, Grenada.  
Tel: 1 (473) 440 5886/6783.  
Fax: 1 (473) 440 5554.  
E-mail: gpbs@caribsurf.com

**Guyana National Bureau of Standards (GNBS),**  
Flat 15, Sophia Exhibition Complex, Sophia,  
Greater Georgetown, Guyana.  
Tel: 592 2 59041. Fax: 592 2 57455.  
E-mail: gnbs@sdnp.org.gy

**Jamaica Bureau of Standards (JBS),** 86  
Winchester Road, PO Box 113, Kingston 10,  
Jamaica. Tel: 1 (876) 926 3140-6.  
Fax: 1 (876) 929 4736.  
E-mail: othomas@jbs.org.jm

**Kunduchi Fisheries Institute,** PO Box 2462,  
Dar es Salaam, Tanzania.  
Tel: 255 222 650011/650244.

**Mbegani Fisheries Development Institute,**  
PO Box 83, Bagamoyo, Tanzania.  
Tel: 255 232 440038.

**Ministry of Agriculture and Food Security,**  
Kilimo House, PO Box 9192, Dar es Salaam,  
Tanzania. Tel: 255 22 286 2064/286 2480.  
E-mail: psk@kilimo.go/tz

**Ministry of Industry and Trade,**  
PO Box 9503, Dar es Salaam, Tanzania.  
Tel: 255 222 180075.

**Ministry of Water and Livestock Development,**  
PO Box 9153, Dar es Salaam, Tanzania.  
Tel: 255 22 2117153/9.

**National Agricultural Research Organisation**  
(NARO), PO Box 7852, Plot M217, Nakawa  
Industrial Area, Kampala, Uganda.  
E-mail: fosri@imul.com

**National Food Control Commission,** Ministry of  
Health, PO Box 7601, Dar es Salaam, Tanzania.  
Tel: 255 222 114039/114060.

**OECS/EDADU,** PO Box 961, Roseau, Dominica.  
Tel: 1 (767) 448 2240.  
Fax: 1 (767) 448 5554.  
E-mail: csthilaire\_edadu@yahoo.com

**Research Association for Fisheries and**  
**Oceanography,** PMB 77, Limbe, Cameroon.  
Tel/Fax: 00 237 391516.

**Saint Lucia Bureau of Standards (SLBS),**  
Heraldine Rock Building, Block B, 4th Floor,  
Waterfront, Castries, St Lucia.  
Tel: 1 (758) 453 0049/456 0546.  
Fax: 1 (758) 452 3561. E-mail: slbs@candw.lc



**School of Veterinary Science**, University of Zambia, PO Box 32379, Lusaka, Zambia.  
Tel: 00 260 1 293727.

**St. Kitts-Nevis Multipurpose Laboratory**, PO Box 39, Department of Agriculture, St. Kitts.  
Tel: 1 (869) 465 5279. Fax: 1 (869) 465 3852.  
E-mail: mplbos@caribsurf.com

**St. Vincent and the Grenadines Bureau of Standards (SVGBS)**, Ministry of Trade and Industry, Kingstown, St Vincent.  
Tel: 1 (784) 457 8092/ 456 1223.  
Fax: 1 (784) 457 8175.  
E-mail: svgsb@caribsurf.com

**Tanzania Bureau of Standards**, PO Box 9524, Dar es Salaam, Tanzania.  
Tel: 255 222 450298. Fax: 255 222 450959.  
E-mail: standards@twiga.com

**Technological Services**, Caribbean Development Bank, PO Box 408, Wildey, St. Michael, Barbados. Tel: 1 (246) 431 1690.  
Fax: 1 (246) 426 7269.  
E-mail: harvey@caribank.org

**Technology Consultancy Centre**, Kwame Nkrumah University of Science and Technology, Kumasi, Ghana. Tel: 233 51 60296/60297.

**Trinidad and Tobago Bureau of Standards (TTBS)**, Century Drive, Trinicity Industrial Estate, PO Box 467, Port of Spain, Trinidad.  
Tel: 1 (868) 662 4482/8827  
Fax: 1 (868) 663 4335.  
E-mail: ttbs@carib-link.net

The following non-ACP institutions may also be able to assist with information:

**Agromisa**, PO Box 41, 6700 AA Wageningen, The Netherlands.  
Tel/Fax: 31 317 412217/419178,  
E-mail: agromisa@agromisa.org,  
Web: www.agromisa.org

**Intermediate Technology Development Group**, Bourton Hall, Bourton-on-Dunsmore, Rugby, CV23 9QZ, UK. Tel: 44 1926 634400,  
Fax: 44 1926 63440, E-mail: itdg@itdg.org.uk,  
Web: www.itdg.org

**International Natural Sausage Casing Association (INSCA)**, 710 North Rush Street, Chicago, IL 60611, USA. Tel 312 670 0200.

**Koch Processing Equipment**, 1411 West 29th Street, Kansas City, MO 64108, USA.  
Tel 800 777 5624. www.kochsupplies.com

**The Sausage Maker Inc.**, 1500 Clinton Street, Buildingg 123, Buffalo, NY 14207, USA.  
Tel 716 824 6510. www.sausagemaker.com



# Appendix II

## *Further reading and bibliography*

---

### *References used in the text*

Axtell, B., 1991. *Try Drying-IT*. Intermediate Technology Publications, London, UK.

FAO, 1985. *Dried salted meats: charque and carne-del-sol*, Norman, G.A. and O.O. Corte. FAO Animal Production and Health Paper No. 51, Food and Agriculture Organization of the United Nations (FAO), Rome, Italy.

ILO, 1985. *Small-scale processing of pork*. Technical Memorandum No. 9. International Labour Organisation (ILO), Geneva, Switzerland. ISBN 92 2 1900542 9.

Lawrie, R.A., 1985. *Meat Science*. Pergamon Press, Oxford, UK.

Madisson, A. and K. Matchell, 1988. *Fish Processing, Food Cycle Technology source Book*. United Nations Development Fund for Women/Intermediate Technology Development Group (UNIFEM/ITDG), New York, USA.

Stround, D.G., 1986. *A technical and economic appraisal of smoking ovens in Ghana*. TCP/GHA/4506. Food and Agriculture Organization (Fisheries Department), Rome, Italy.

UK Food Regulations, 1995. Her Majesty's Stationery Office, London, UK.

### *Bibliography*

Useful further reading on food science and technology, processing, quality assurance, marketing and management is provided in the bibliography in Volume 1: *Setting up and running a small food business*. The following publications are specifically related to the production of processed meat and fish products.

*A Review of Insect Infestation of Traditionally Cured Fish in the Tropics*, Johnson, C. and J. Esser, 2000. M. Dillon Associates, Grimsby, UK. ISBN 1 900134 13 6.

*Applications of Biotechnology to Traditional Fermented Foods*, 1992. National Academic Press, Washington DC, USA. ISBN 0 309 04685 8.

*Book of Sausages*, Hippisley Coxe, A.A., 1998. Mackays, Chatham, UK. ISBN 0 575 06633 4.

*British Charcuterie*, Reekie, J., 1988. Ward & Locke, London, UK. ISBN 0 7063 6680 8.

*Cooling without power*, Roy, S.K. and R.L. Pal, 1994. Food Chain, Vol.12, Intermediate Technology Development Group (ITDG), Bourton-on-Dunsmore, Rugby, UK.

*Dried salted meats: charque and carne-del-sol*, Norman, G.A. and O.O. Corte, 1985. FAO Animal Production and Health Paper No. 51, Food and Agriculture Organization of the United Nations (FAO), Rome, Italy.

*Fish Fermentation Technology*, Lee, C., K.H. Steinkraus and P.J.A. Reilly, 1993. United Nations University Press. ISBN 89-7053-003-7.

*Fish and Fishery Products: Composition, Nutritive Properties and Stability*, Ruiter, A., 1995. CAB International. ISBN 0 85198 927 6.

*Fish and Shellfish Quality Assessment: A guide for retailers and restaurateurs*, Doré, I., 1991. An Osprey Book, Van Nostrand Reinhold, USA. ISBN 0 442 00206 8.

*Fish Processing Technology*, G.M. Hall, 1997. Blackie Academic and Professional, London, UK. ISBN 0 7514 02737.

*Fish Products*, Krenzar, R., 1974. Food and Agriculture Organization of the United Nations (FAO), Rome, Italy.

*Great Sausage Recipes and Meat Curing*, Kutas, R., 1999. The Sausage Maker Inc., Buffalo, New York, USA.

*Guidelines on Small Slaughterhouses and Meat Hygiene for Developing Countries*, Mann, I., 1984. World Health Organization, Geneva, Switzerland.

*Handbook of Spices, Seasoning and Flavourings*, Uhl, S.R., 2000. Technomic Publishing. ISBN 1 56676 931 0.

*Meat Product Technology*, Ranken, M.D., 2000. Blackwell Science Ltd, London, UK. ISBN 0-632-05377-1.

*Meat and Meat Products: Technology, Chemistry and Microbiology (Food Products Series, Vol 3)*. Varnam, A. H and Sutherland, J. P., 1995. Aspen Publishers, Inc. ISBN 0412495600.

*Meat Processing for Small and Medium Scale Operations*, Ibarra, P.I., 1983. University of Philippines, Los Banos, Philippines. ISBN 971 110 007 X.

*Meat Science*, Lawrie, R.A., 1985 (Fourth Edition). Pergamon Press, Oxford, UK. ISBN 0 08 030789.

*Pies, Pâtés and Terrines*, Christian, G., 1988. J Sainsbury's Press, UK.

*Post-harvest Fisheries Development: A Guide to Handling, Preservation, Processing and Quality*, Clucas, I.J. and A.R. Ward, 1996. Natural Resources Institute, Chatham, UK. ISBN 0 85954 441 0.

*Practical food smoking*, Walker, K., 1995. Neil Wilson Publishing Ltd., Glasgow, UK.

*Professional Charcuterie*, Kinsella, J. and D.T. Harvey, 1996. John Wiley & Sons, Inc., USA. ISBN 0 471 12237 8.

*Sanitation in Food Processing*, Troller, J.A., 1983. Academic Press. ISBN 0 12 700660 5.

*Sausage and Processed Meat Formulations*, Ockerman, H.W., 1989. An AVI Book, Van Nostrand Reinhold, USA. ISBN 0 442 43436 8.

*Sausage and Small Goods Production*, Gerrard, F., 1976. Northwood Publishing Ltd., London, UK. ISBN 7198 25873 (old, but contains useful information).

*Sausage Maker: equipment and ingredients.*  
[www.sausagemaker.com](http://www.sausagemaker.com)

*Small-scale Manufacturing of Beef Biltong in Botswana*, Sandel, A. and P. Minett, Botswana Technology Centre, Gabarone, Botswana.

*Small-scale Processing of Beef*, ILO, 1985. Technical Memorandum No. 10, International Labour Office (ILO), Geneva, Switzerland. ISBN 92 2 105050 5.

*Small-scale Processing of Ground Meat and Sausages*, Caribbean Development Bank, 1987. Caribbean Development Bank, St Michael, Barbados.

*Small-scale Processing of Pork*, ILO, 1985. Technical Memorandum No. 9, International Labour Office (ILO), Geneva, Switzerland. ISBN 92 2 1900542 9.

*The Meat We Eat*, Jones, K.W., W.C. Costello, C.W. Carlson and P.T. Ziegler, 1984 (Eleventh Edition). ISBN 0 8134 244 5.

*Technology of Meat and Meat Products*, Girard, J.P., 1992. Food Science and Technology series, Ellis Horwood. ISBN 0 13 904285 7.

*The microbiological safety and quality of food, Volume I & II*, Lund, B.M., T.C. Baird-Parker and G.. Gould, 2000. Aspen Publishers Inc., Gaithersburg, Maryland, USA. ISBN 0 8342 1323 0.

*The Production and Storage of Dried Fish*, FAO, 1982. Workshop proceedings, FAO Fisheries Report No. 279, Food and Agriculture Organization of the United Nations (FAO), Rome, Italy.

### *Other useful publications*

*A Code of Practice for the Manufacture of Vacuum or Modified Atmosphere Packaged Chilled Foods*, Betts, G. 1996. Guideline No. 11, Campden and Chorleywood Food Research Association, Chipping Campden, UK.

*A Practical Approach to Quality Control*, Caplan, R.H., 1982. Hutchinson Publishing Group, London, UK.

*Appropriate Food Packaging*, Fellows, P. and B. Axtell, 2002. Intermediate Technology Publications, London, UK.

*Export Quality: World Directory of Standardisation and Quality Assurance Related Institutions*, Anon, 1992. International Trade Centre/United Nations Conference on Trade and Development/General Agreement on Tariffs and Trade (ITC/UNCTAD/GATT) Geneva, Switzerland.

*Food Cycle Technology Sourcebook: Packaging*, Oti-Boateng, P. and B. Axtell, 1996. Intermediate Technology Publications, London, UK.

*Food Hygiene Handbook*, Sprenger, R.A., 2002. Highfield Publications, Doncaster, UK. ISBN 1 871912 42 3.

*Food Poisoning and Food Hygiene*, Hobbs, B.C. and D. Roberts, 1987. Edward Arnold, London, UK.

*Fundamentals of Quality Control for the Food Industry*, Kramer, A. and B.A. Twigg, 1962. AVI Publishing Co., Westport, Conn. USA.

*Hazard Analysis Critical Control Point Evaluations*. Bryan, F.I., 1992. World Health Organisation, Geneva, Switzerland.

*How to Clean*, Dillon, M. and C. Griffith, 1999. M.D. Associates, Grimsby, UK. ISBN 1 900134 11X.

*Making Safe Food* (Book and Posters), Fellows, P., and V. Hidellage, 1992. IT Publications, London, UK.

*Quality Assurance for Small-scale Rural Food Industries*, Fellows, P. and B. Axtell, 1995. FAO Agricultural Services Bulletin, Food and Agriculture Organization of the United Nations (FAO), Rome, Italy.

*Safe Processing of Foods*, Shapton, D.A. and N.F. Shapton, 1993. Butterworth-Heinemann, Oxford, UK.

*Shelf life of foods*, IFST, 1993. Institute of Food Science and Technology, London, UK. ISBN 0905367 11 1.



# Glossary and acronyms

## Glossary

---

<b>Abuse testing</b>	A system of testing the hazards a product might face in the distribution chain to the consumer
<b>Bain-marie</b>	A double-pan water-jacket method of cooking that avoids any burning
<b>Bratwurst</b>	A German sausage
<b>Break-even point</b>	The level of turnover at which all costs are covered
<b>Brining</b>	Submerging meat and fish in a weak brine for a short time
<b><i>Campylobacter</i></b>	An organism associated with meat products that is widely associated with food poisoning
<b>Collagen</b>	A protein derived from animal hides used to make sausage casings
<b>Case hardening</b>	Development of a surface layer that obstructs the passage of water and slows drying rates
<b>Casings</b>	Natural and synthetic materials used to enclose sausages
<b>Charcuterie</b>	A French word describing the art of curing meats
<b>Chorizo</b>	A spicy, red low moisture sausage of Spanish origin
<b>Codex Alimentarius</b>	An internationally agreed protocol of food standards
<b>Cold chain</b>	A system that maintains a food at the correct temperature from production to consumption
<b>Cold smoking</b>	A method of light smoking at temperatures of 30°C or below in which the meat is not cooked
<b>Dermestides</b>	A group of beetles that commonly infest dried meat and fish
<b><i>E. coli</i></b>	An organism that indicates that faecal contamination has taken place
<b>Emulsion</b>	Oil and water that have been bound into one phase that does not separate
<b>E number</b>	E numbers are an internationally recognised system of listing food additives
<b>Enzymes</b>	Natural proteins that cause changes in food colours and flavour
<b>Fillers</b>	Cereal-based substances that are used in meat products to reduce costs and bind water
<b>Fixed costs</b>	Costs of production that do not depend on the

	quantity of goods produced
<b>Formica</b>	Rigid plastic sheeting applied to walls and tables
<b>Gaspe process</b>	A method of salting fish
<b>Hard wired</b>	Permanent wiring of electrical equipment
<b>Hot smoking</b>	Smoking foods at temperatures of approximately 70°C in which cooking of the flesh takes place
<b>Insectocutor</b>	Equipment which attracts flying insects to an ultra-violet light and then kills them by electrical discharge
<b>Kenching</b>	A method of dry curing fish with salt
<b><i>Lactobacillus</i></b>	A harmless organism that produces lactic acid from carbohydrates
<b>Liquid smoke</b>	Smoke condensate used as an alternative to natural smoking
<b>Market segments</b>	A group of similar consumers
<b>Marketing mix</b>	The combination of where a product is sold, its price, its characteristics and its promotion
<b>Neem</b>	A tree <i>Azadirachta indica</i> traditionally used to control insect pests
<b>Niche market</b>	A small specialised section of the market
<b>Nitrate</b>	A salt, usually used as the sodium salt, that breaks down to nitrite, which has a preservative action in cured meat products
<b>Nitrite</b>	Used as a preservative in cured meat to control the growth of potentially harmful food poisoning organisms
<b>Pathogens</b>	Micro-organisms that can cause sickness if consumed in foods
<b>pH</b>	A scale from 1-14 that is used to measure acidity (below 6), neutrality (7) and alkalinity (8-14)
<b>Pirimiphos-methyl</b>	An insecticide recommended for controlling infestation in dried meat and fish
<b>Phenolic</b>	Chemical compounds found in wood smoke that have anti-microbial properties
<b>Phytosanitary</b>	Systems of treating natural products to prevent the spread of pests and infections
<b>Polonies</b>	A spicy dry sausage of East European origin
<b>Prague salts</b>	Commercial salts of sodium nitrate and nitrite used to cure meats
<b>Process control point</b>	A point in a process where lack of control can affect the quality and safety of a product
<b>Rancidity</b>	Development of 'off-flavours' due to the oxidation of fats
<b>Risk analysis</b>	A system which examines the risks faced by a food as it moves through the chain from producer to



	consumer
<b>Rusk</b>	A cereal filler often added to ground meat and fish products
<b><i>Salmonella</i></b>	A dangerous food poisoning organism
<b>Salami</b>	A coarse dry Italian sausage
<b>Salometer</b>	An instrument used to measure the strength of brines
<b>Soil</b>	A term used to describe all types of contamination of equipment
<b><i>Staphylococcus</i></b>	A food poisoning organism commonly found in the throat or nose
<b>Swabbing</b>	A system of testing microbiological contamination of surfaces and equipment
<b>Total viable count</b>	A measure of the total number of micro-organisms present
<b>Tumbler</b>	A machine that 'tumbles' meat products to increase the rate of brine cure penetration
<b>Vacuum packing</b>	Packing foods in plastic packs under vacuum
<b>Variable costs</b>	Production costs that depend on the amount of goods produced
<b>Water activity (<math>a_w</math>)</b>	A measure of the free water that is available to support microbial growth
<b>Wiltshire cure</b>	A historic traditional dry bacon cure

## *Acronyms*

---

<b>ACP</b>	African, Caribbean and Pacific
<b>CAC</b>	Codex Alimentarius Commission
<b>CTA</b>	ACP-EU Technical Centre for Agricultural and Rural Cooperation
<b>EU</b>	European Union
<b>FAO</b>	Food and Agriculture Organization of the United Nations
<b>HACCP</b>	Hazard Analysis Critical Control Point (system of quality assurance)
<b>INSCA</b>	International Natural Sausage Casing Association
<b>KNUST</b>	Kwame Nkrumah University of Science and Technology
<b>PAYE</b>	Pay As You Earn (system of income taxation)
<b>QA</b>	Quality Assurance
<b>QC</b>	Quality Control
<b>UNESCO</b>	United Nations Educational, Scientific and Cultural Organization
<b>UNIDO</b>	United Nations Industrial Development Organization

## *Index*

---

### **A**

Abattoir 61  
Abuse testing 42  
Additive 68,167  
Advertising 33

### **B**

Bacon 109  
Bain-marie 107  
Band saw 91  
Biding aid 66  
*Biltong* 116, 150  
Boiler 56  
Book-keeping 181  
Botulism 78, 95  
Bowl chopper 93  
Brine

bacon 111  
*biltong* 117  
fish 134  
ham 113  
strength 111, 160

### Building

cleaning 155  
construction 48,131  
inspection 155  
layout 57,80,118,127  
regulations 165

### Butchery 79

### Business

plan 20,47,176  
regulations 165

### **C**

Cash-flow 180  
Casing 65,85,152  
Chlorine, see Water  
Chorizo 83,105  
*Chorkor* 138  
Cleaning 155  
Cold chain 24  
Colouring 90  
Contamination 49,57,59,64,150,152  
Contract 25,179  
Cooler (evaporative) 130  
Cost

control 179  
production 176  
start up 175

Curing 110,113,134

Customer care 23

### **D**

Decision-action grid 49

Drains 51

### Drying

fish 133,136  
meat 118

### **E**

Electricity 53

Environmental impact 169

### Equipment

buying 68  
cleaning 157  
fish processing 130,132,136  
maintenance 157,180  
meat processing 82,90,98,106,128,136

### **F**

Feasibility study 19,47,176

Filler 65

Finance (management) 177

### Fish

cured 135  
dried 132,136  
handling 64  
minced 141  
packaging 69,145  
pâté 141  
pickled 135  
processing (traditional) 129  
sauce 143  
smoked 137  
spoiled 127

### **G**

Gaspe process 135

### **H**

Ham 113

Hamburger 105

Hank 85

Herbs 66,88,152

### **I**

Ice 56,64,99,131

Infestation 140

- Injection pump 110
- Insect 52,64,140
- K**
- Kenching 135
- Knife 91,94
- L**
- Labelling 23,34,154,168
- Legislation, see Regulations
- Linking 87
- M**
- Management
  - finance 177
  - staff 71
- Market
  - development 32
  - export 27,126
  - niche 27,33,37,143
  - research 29
  - survey 26
  - segments 27,126
- Marketing
  - mix 29
  - strategy 26
- Meat
  - contamination 49,59
  - content 167
  - cuts 79,110
  - packaging 69,95,119
  - pâté 106
  - quality 61
- Mincer 92
- N**
- Niche, see Market
- P**
- Packaging 35,69,95,106,119,145,153
- Pâtés
  - meat 106
  - fish 141
- Patty machine 106
- Pests, see Contamination
- Pickling 135
- Planning 20,47,176
- Plant layout 57,80,118,127
- Preservative, see Sodium nitrite
- Process (control) 158
- Product
  - development 37
  - pricing 178
  - selection 21
- Production
  - cost 176
  - planning 48,176
- Promotion 33
- Q**
- Quality 59,61,152,159
- R**
- Recipe
  - fish cake 142
  - fish pâté 142
  - fish sauce 143,144
  - ham 116
  - meat pâté 109
  - sausage 101-105
- Record keeping 70,181
- Regulations 165
- Risk analysis 149
- Rusk, see Filler
- S**
- Salami 83,100
- Salometer 111,161
- Salt 64,134,152,161
- Sausage
  - casing 65,85,152
  - colouring 90
  - cooked 83
  - cured 83
  - dried 83,100,105
  - fresh 83
  - liver 104
  - making 99,102
  - recipes 101,103-105
  - smoked 96,104
  - seasonings 88
  - stuffing 87,94
- Seasonings 88
- Sell-by date 41
- Shito* 144
- Sodium nitrate & nitrite 67,78,160,167
- Smoker 96,138
- Smoking 97,137
- Spices 66,89,152
- Staff 71,179
- Stuffing 87,94,100

**T**

Terrine 106  
Tumbler (ham) 114

**V**

Vacuum packing 95,153

**W**

Waste disposal 56,137,169  
Water  
    activity 132  
    supply 54  
    treatment 54,128  
    chlorine content 55,162

## *Readers' questionnaire*

---

Please help us to improve future books by completing this questionnaire and sending it by post to CTA, Postbus 380, 6700 AJ, Wageningen, The Netherlands (Fax + 31 317 460067).

Name ..... Position/Profession .....  
Address .....

### **Are you?**

An individual entrepreneur , in an academic institution , government organisation , a local NGO/CBO , an international NGO , a commercial company , another organisation (please specify)  .....

### **How did you hear about this book?**

Word of mouth , an advertisement , a publications list , another way (please specify)  .....

### **Why did you buy this book?**

To learn about food processing , to improve my existing business , to help in training programmes , another reason  (please give details)  
.....

### **Has the book given you the information you needed?**

Yes , No , some of it

### **Which information was most useful to you?**

.....  
.....

### **What information was missing that you feel should be included?**

.....  
.....

### **Do you like the layout and style of presentation? Yes , No , Other**

comments: .....

### **What would you like to see included in future books that is missing from this one?**

.....

Please continue overleaf with any other comments you would like to make.