

Backyard rabbit keeping in the tropics

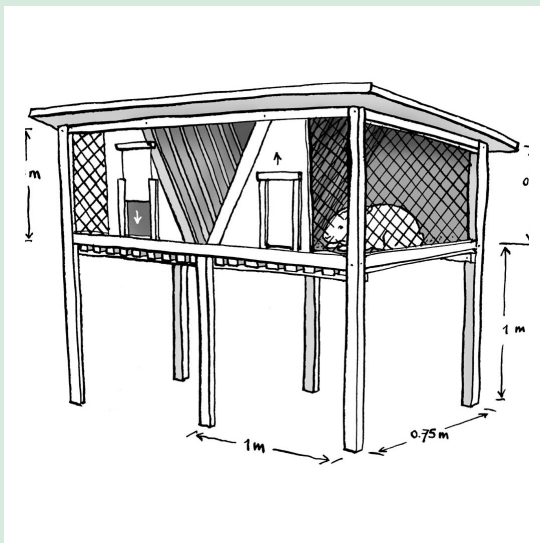
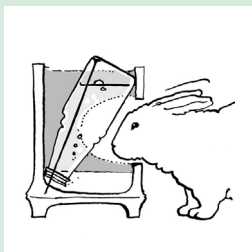
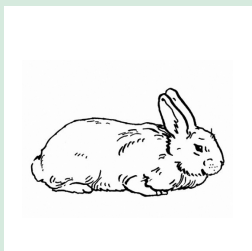

Agrodok 20

**Back-yard rabbit keeping
in the tropics**

J.B. Schiere
C.J. Corstiaensen

This publication is sponsored by: ICCO

© Agromisa Foundation and CTA, Wageningen, 2008.

All rights reserved. No part of this book may be reproduced in any form, by print, photocopy, microfilm or any other means, without written permission from the publisher.

First English edition: 1983

Third (revised) edition: 1999

Fourth edition: 2004

Fifth (revised) edition: 2008

Authors: J.B. Schiere, C.J. Corstiaensen

Editors: C.J. Corstiaensen, S. Huizinga

Illustrator: Olivier Rijcken

Design: Eva Kok

Translation: Catharina de Kat-Reynen

Printed by: Digigrafi, Wageningen, the Netherlands

ISBN Agromisa: 978-90-8573-111-5

ISBN CTA: 978-92-9081-404-7

Foreword

While living in Indonesia many years ago, my wife and I wanted to become involved in some kind of animal husbandry, but our back-yard was too small to house large animals like goats or sheep, let alone cows. For this reason, we chose to raise rabbits. One of the results of that choice was the publication in 1983 of an Agrodok on the practical aspects of back-yard rabbit raising. Now, 25 years later, I am pleased to write the foreword to the 5th, revised, edition of this frequently ordered Agrodok.

Thousands of copies have already been distributed of the original publication in English, Spanish, French, Nepalese, Sinhala and Tamil. So I do hope this booklet has helped bring some added benefit to families around the world (whether in the form of income, food or fun). This new edition will be co-published and distributed by CTA. Hopefully the practical information provided in it will reach the target group everywhere in the world where keeping rabbits is possible.

The content of this Agrodok has remained basically unchanged, but its readability, illustrations and layout have been greatly improved. The information in the annexes Further reading and Useful addresses have of course been updated, since websites did not yet exist in 1983!

I thank Kees Corstiaensen, who revised the text for this version and included his practical experiences with rabbits in many parts of the world, and Olivier Rijcken, who improved the illustrations.

Hans Schiere (www.laventana.nl)
September 2008; Manila, the Philippines

Contents

1	Introduction	6
1.1	Some reasons for keeping rabbits	6
1.2	General husbandry and handling	8
1.3	Structure of this Agrodok	10
2	Types of animals: breeds	11
2.1	Fancy and fur breeds	11
2.2	Meat breeds	11
3	Selecting your animals: breeding stock	15
3.1	Health	15
3.2	Sex	15
3.3	Risks	16
4	Reproduction	17
4.1	The male	17
4.2	The female	17
4.3	Mating of buck and doe	18
4.4	Pregnancy control	20
4.5	Kindling and mother care	22
4.6	When to mate the doe again	24
5	Housing: the hutches	26
5.1	Microclimate	27
5.2	Predators	27
5.3	Doors, hinges and feeding troughs	29
5.4	Construction and building materials	30
5.5	The maternity hutch and the nest box	32
5.6	Conclusions	33
6	Housing: the stable	34
6.1	General advice before you start building	34
6.2	Important features	35

6.3	Cages	38
6.4	Nest boxes	40
6.5	Conclusions	41
7	Nutrition	42
7.1	Water requirements	42
7.2	Feed	43
7.3	Some practical remarks	45
7.4	Growth rates of rabbits	47
8	Health care	48
8.1	Prevention of diseases	49
8.2	Intestinal problems	50
8.3	Problems of the respiratory tract	53
8.4	External parasites	53
8.5	Other diseases and health problems	56
9	Administration	57
9.1	Identification methods	57
9.2	Record keeping	58
9.3	The calendar	58
10	Processing	59
10.1	Killing and slaughtering	59
10.2	The process of tanning	61
	Appendix 1: Common diseases of rabbits	64
	Appendix 2 Administration	69
	Further reading	70
	Useful addresses	71
	Glossary	73

1 Introduction

People keep rabbits for many different reasons. The main aim of this booklet is to give some reasons for small farmers, low-income families or children to do so, and to discuss management, housing, breeding, nutrition, veterinary issues, and other potential problems for this type of back-yard farming.

1.1 Some reasons for keeping rabbits

- The meat is tasty, of good quality, low in fat content and similar to chicken meat. This is known in many rural, tropical communities.
- There are few religious or other taboos regarding rabbit meat. Islam does not prohibit eating rabbit meat, for example.
- Initial capital outlay is minimal. With some scrap wood or bamboo, a hutch can be constructed.
- To start a rabbit ‘business’ one does not need a large initial investment. A few does (females) with a buck or ram (male) is enough to start. Once the kindling begins, the herd rapidly increases in size (if managed well and with no bad luck) so that very soon one can slaughter the young males.
- If one starts a rabbit ‘business’ with borrowed animals, within half a year the initial ‘credit’ can be returned as live animals.
- Animals all over the tropical world are often used as a type of savings account. When a small amount of money is needed, it is easier to sell a small animal than for example the hind leg of a goat.
- The quantity of meat provided by a rabbit is enough for a small party or a family dish (the amount of meat per rabbit is comparable to that of a chicken). On the other hand, a rabbit is small enough that a family can eat all the meat at once without the need for refrigeration or other conservation.
- Because the does produce offspring regularly, they provide a regular source of income instead of a large amount all at once.
- Feeding rabbits can be very cheap. Even though supplementation with concentrate or grain is sometimes necessary and definitely will

increase growth rates, roadside grass, kitchen waste (if it does not contain animal products), garden leaves, etc., can provide the main feed at almost no cost.

- Rabbits can be tended by women, children or men; and unlike with bigger animals, force is not needed to restrain them.
- The manure can be used for vegetable growing.
- The manure does not have a very strong smell, and rabbits do not make much noise, so neighbours will not likely complain.
- The skin is valuable if there is a market for it, possibly for local handicrafts (see Chapter 10 for tanning).
- Children learn to tend for and appreciate animals.
- A rabbit is a nice present for a child on a birthday, for a neighbour planning to marry or for a servant who plans to go home to his village.

No doubt this long list could be extended to include many more reasons for keeping rabbits.

Some difficulties in keeping rabbits

- Most importantly, people who have never kept rabbits before are often reluctant to start because it is difficult to accept something new. Whereas in Europe and the United States there is a well-established market for rabbit meat, in the tropics the market is more focused on chickens. There are few countries with an existing market for rabbit meat. This reduces potential monetary income, but it should be no problem if the intention is to raise rabbits as a family enterprise, mainly to provide meat for the family where the diet may be lacking in protein.
- Diseases are common and, unlike for chickens, specific rabbit medicines are not easily available. Moreover, veterinarians (even in Europe and the USA) do not usually have much experience in the diagnosis and treatment of rabbit diseases. On the other hand, with good hygiene and common sense, in addition to the information found in this booklet, one should not have too many worries about diseases. Most animals get sick once in a while, and a dead rabbit is less of a worry than a dead goat or cow.

- Keeping rabbits will certainly take up some of your time for feeding, cleaning, managing and keeping records. It is difficult to say how much time is needed. This will depend on the number of animals you keep, the housing system you choose and the way you are able to obtain feed. As a general rule, keeping 5 to 10 rabbits will occupy you about 1 to 2 hours a day for cleaning, managing and feeding.

1.2 General husbandry and handling

Like all animals, rabbits require proper care if they are to (re)produce well. Before going to sleep at night one should check them, and during the day one should keep a close eye on them. It is not enough to see whether the animal is sick, one should learn to recognise whether the animal is likely to become sick. Likewise, it is not enough to see that the doe has made a nest and kindled, one should know beforehand that she will soon make a nest and kindle.

Give your young rabbits the best food and drinking water possible (Chapter 7). Remove dung and clean the hutches weekly with water. If you are careful, it will not be necessary to take the animals out. Always handle the rabbits in the proper way. Lift them as shown in Figure 1.

Those animals you want to use for further breeding should be given identification (Chapter 9). Keep a close watch on their performance; do not kill the fast growers but use those for further upgrading your stock. Separate the males and females that you want to keep early on, before they become sexually active (females at four months, males two months later).

If you want to sell the rabbits as reproduction animals, separate the males from the females before they become sexually active. This is not necessary for broiler rabbits, since they will be slaughtered before becoming mature. It is better not to put several litters together in one hutch, in order to prevent fighting. After mating the first time, you

should give the young doe an individual hutch before kindling. The whole cycle then starts again.



Figure 1: Handling rabbits. A. Holding a young rabbit. B. Holding by loose skin of shoulder while supporting hind part. C. Carrying a rabbit with its head covered by your arm, and with one hand free. D. Checking rabbit's belly with right hand free.

1.3 Structure of this Agrodok

There are many aspects to general rabbit husbandry. In this booklet we describe the most important things you need to know to start keeping rabbits: the different breeds, how to select breeding stock, mating and kindling, rearing the young, housing, feeding, illnesses, good administration practices, slaughtering and tanning the skin.

In the appendices you will find additional information, including a glossary of technical terms used, more detailed information on feed and diseases as well as a list of useful books.

2 Types of animals: breeds

Just as there are many different types of cattle, it is not surprising that there are many types of rabbits. As with cattle, there are some rabbit crossbreeds (offspring of two different races) as well as many local varieties, often called ‘local rabbits’ or ‘native breeds’. For the purposes of this Agrodok, breeds will be grouped into two basic categories, without trying to make scientifically correct distinctions.

2.1 Fancy and fur breeds

Fancy and fur breeds differ from meat breeds in that the fancy types are not necessarily good meat producers, do not have large litters, nor are they resistant/tolerant to diseases. They have nice coats, nice colours, funny ears and so on.

One of these types which deserves attention is the angora. The hair can become very long and provides a very valuable fibre for spinning and weaving. The value of the angora should not be overlooked for small home industries even though not much information is available about it. The hair seems to grow better in colder climates, which might reduce the value of the angora in the tropical lowlands.

2.2 Meat breeds

Utility breeds are producers of meat, either because of their fast growth rate (which requires good feeding) or because of their large and frequent litters. It is necessary to make a further distinction here with respect to weight (see Figure 2):

- Dwarf breeds (e.g. ‘Polish’) weigh up to 1.5 kg (photo 1)
- Light breeds (e.g. ‘Dutch’) weigh 2-3 kg (photo 2)
- Medium breeds (e.g. ‘New Zealand White’) weigh 3-5 kg (photo 3)
- Heavy breeds (e.g. ‘Flemish Giant’) weigh more than 5 kg (photo 4)

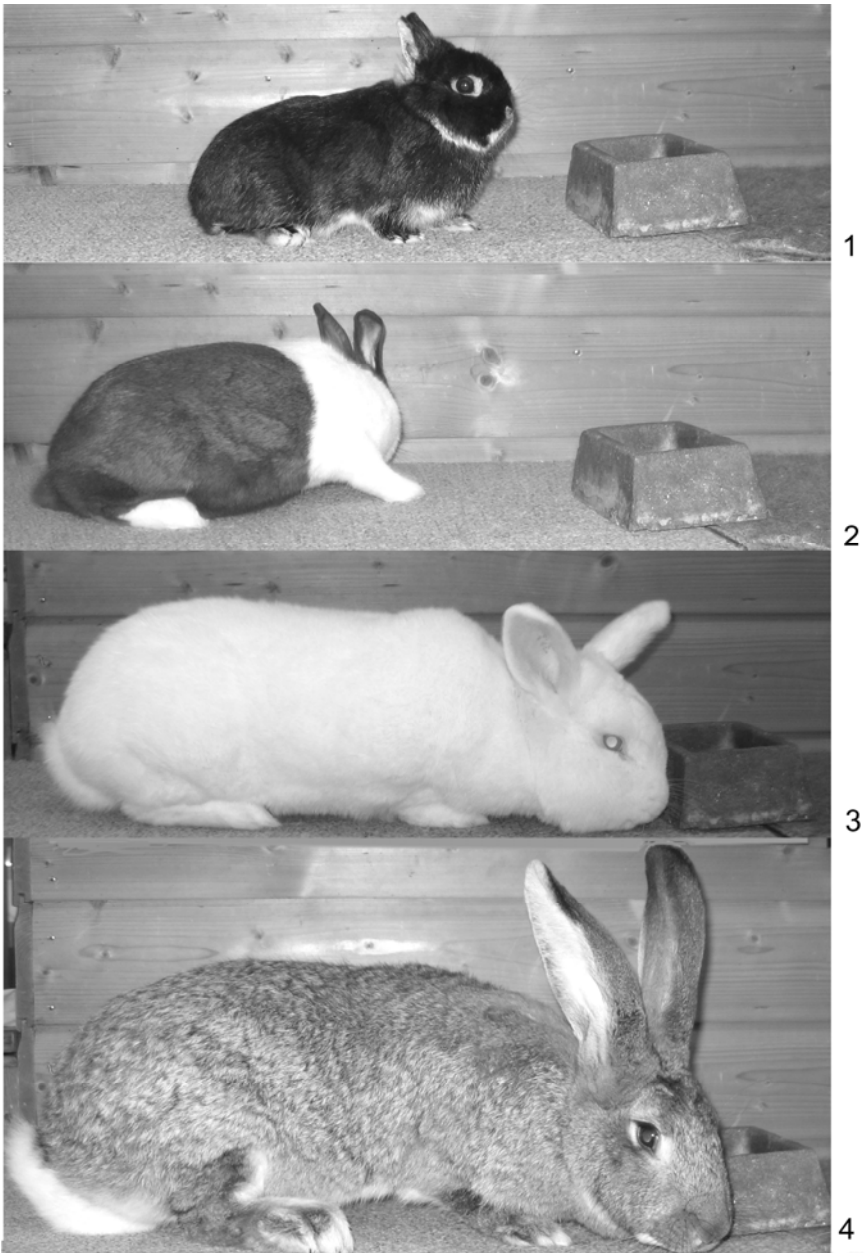

Figure 2: Different breeds

There are a few things to keep in mind when choosing a breed:

- Very often local crosses seem to be of the lighter breeds. They may have the genetic potential to grow large, but due to poor feeding, disease, premature mating and often suboptimal care, they do not get the chance to do so.
- Take the effort and search in your own region for acceptable breeding stock. Before considering nice-looking, large imported animals, it might be better to try keeping the local breeds, which may thrive if given proper feeding and care. All too often imported breeds lead to loss of face, prestige, money and effort because the animals do not grow well under local circumstances, are susceptible to diseases, are too expensive or cannot handle the stress of transport and fall ill or die. They are not adapted to local conditions, and therefore may cause disappointment.
- Even though large animals look nice and impressive, it is not always advantageous to have large animals. They mature later so they will start to produce offspring at about nine months, whereas the lighter breeds do so at six months. It may be better, for example, to keep three does weighing 3 kg each that produce three litters after six months, than to keep one doe weighing 9 kg that produces one litter at nine months. Moreover, what family can eat 4 kg of meat at once (resulting from a 9 kg animal)?
- A special word of caution is needed about the Flemish giant. It is a very good show animal and does well for public relations (a size of around 9 kg is not uncommon). But the animal's fertility is not very good, litter size is not high, it has quite a few disease problems (such as sore hocks) and it has a high ratio of bone and intestine compared with medium breeds like the New Zealand (white) and the Californian (see Figure 3). These breeds are often selected for their high fertility and fast growth.
- Do not forget that you have to choose a breed which is suitable for your local conditions. It is impossible to give generalised advice on which breed is best. If two candidates for meat production in backyards had to be mentioned, I would recommend the New Zealand (white) and the Californian. But let your choice depend on local

availability and your preferences; you will give the best care to what you like the best.



Figure 3: New Zealand White (left) and Californian

The important thing is to become rabbit-wise and take on as little risk as possible. That usually means avoiding the use of expensive, fancy, large animals.

3 Selecting your animals: breeding stock

It is advisable to buy breeding stock directly from a breeder. If you cannot buy animals from a reliable source and you have to buy from an unknown person or market, there are a number of things to keep in mind.

3.1 Health

The animals have to be healthy. The main signs are a smooth coat, standing ears, clear eyes, quiet breathing, no mange (scabies) forming crusts around the nose, eyes, at the edges of the ears or inside the ears as a dirty mass. Put the animals on the ground or a table with a rough surface and lift the front part of the animal to watch for irregular legs, inspect the anus to see whether it is dirty from diarrhoea (it should not be!), which is often the case in young rabbits. Check the stomach (abdomen) of the animal. It should feel soft but smooth; a spongy feeling may indicate some intestinal troubles (see Chapter 8 on sick animals). Watch for sneezing. Dirty front legs and/or a dirty nose may indicate a coughing disease (pasteurellosis), because the animal ‘rubs’ its nose with its front legs.

3.2 Sex

The sexing of very young animals is not so easy. The older males have two big testes. If only one testis is visible do not use him for breeding, even though he is fertile, because this is a hereditary defect. If you are still not sure of the animal’s sex, which is often the case with young rabbits, hold the rabbit on its back, put one finger on either side of the genital apparatus. Press down gently and stretch the organ; if it is a doe a long slit will appear, if it is a buck a small prepuce will show (Figure 4). In an older buck the penis can be pushed out. Do not confuse two small glands about the size of a pinhead on either side of the sexual organ with the testes.

Buying, sexing and judging the quality of rabbits can only be learned by making mistakes first and thereby gathering experience. However, it is by no means an impossible or difficult task.

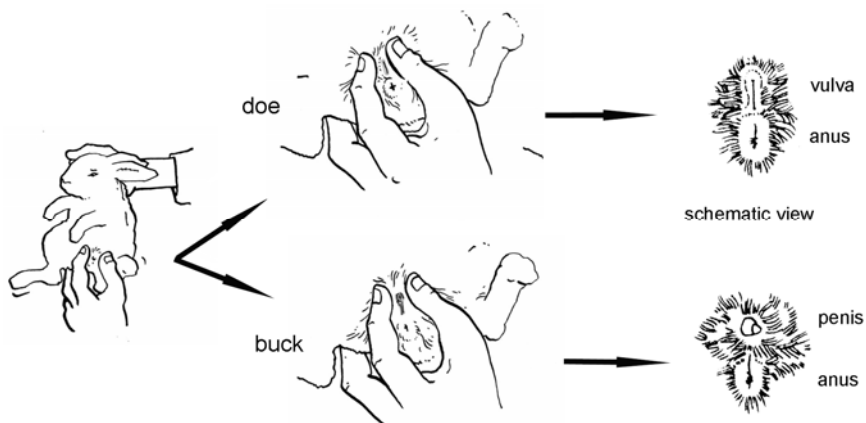

Figure 4: Sexual organs of the young doe and buck

3.3 Risks

Buying at a market implies risks and no guarantee can be given. A market is a gathering place for diseases and in general farmers are unlikely to take their best animals to the market to sell there. The salesman often does not keep rabbits himself so he is also a poor adviser, moreover he will not know anything of the history of the rabbit, or he will only pretend to know. For example if you buy a reasonable-looking rabbit, who can tell you whether she is pregnant (if you cannot feel it yourself), whether she is infertile or should be bred, or whether she is actually still too young to be mated?

Advice: Buy your breeding stock at the breeder's farm.

4 Reproduction

4.1 The male

The males' story is easiest to tell. The proper age for the first mating depends on the breed and individual development. Medium breeds like New Zealand White and Californian mature at the age of six months. Small breeds mature earlier, large breeds later. One male can easily handle up to ten or more does, but this depends on mating intensity, heat, stress, age of the male, nutrition and so on.

It is not a bad practice to have two males around because it is easier to prevent inbreeding and to be sure the doe becomes pregnant by either one. Another reason is that by breeding in turns you will more easily be able to detect if the results of one buck are better than of the other. You will not so easily blame infertility on the does if you can detect the effect of each male.

Sometimes the male is given a round cage so that the doe cannot sit with her hind end in a corner, which makes mating a little bit difficult.

Sometimes the male can spread urine all around the cage, which makes the area dirty and smelly. Keep the bucks in the same barn or stable as the does so that the does can smell them. This may improve the willingness of the does.

4.2 The female

The females' story is not difficult or complicated, but they do require more care and attention. Like the males the proper age of first mating depends on the breed and individual development. Mate females when they reach 75-80% of mature body weight (at four months of age) for the medium breeds. Does mature earlier than bucks.

Rabbits have no clear reproductive cycle. Nevertheless, they do exhibit periods of greater willingness and the does do refuse the buck

sometimes! Signs of greater willingness are restlessness, noisiness (she will scratch the hutch), rubbing her chin on the feeding tray or drinking dish. The genital area will have a redder colour than usual and be swollen. When the vulva is red and swollen bring her to the buck's cage.



Figure 5: Vulva of a willing doe

Ovulation is induced by the mating, so egg cells are set free after the mating. When there are no signs of willingness and the vulva is pale and flat, she will refuse the buck and even bite him. Does that are maintained in good physical condition should produce litters until they are 2 1/2 to 3 years old.

4.3 Mating of buck and doe

Mating should be carried out during the cooler times of the day – early morning or late afternoon.

Always bring the doe to the buck and not the other way round. If you put the buck in the hutch of the doe she is liable to defend her territory and fighting can start. Conversely, he will not defend his territory. When she is in willing condition, bring her to him. She will smell the buck, may do some initial running around but will eventually accept him.

If she accepts him she will sit down in his hutch and raise her rear end. Mating has taken place when the male falls aside or backwards after mounting the doe.



Figure 6: Mating

Often he utters a characteristic cry of pain. He may mount again immediately and mate again as before or he will run around, stamp his feet, and do it again after some time. If the doe is willing to be mated, effective mating takes place twice within the first 5-15 minutes.

After a successful first mating a second is not necessary. The second mating can even be used for another doe if there is another to be served. If the buck is not too busy there is of course nothing against a second time. If the mating was successful, put the doe back in her hutch.

Don't forget to register when a mating has taken place.

If the female starts to run or fight it is better to try it again after a few hours, the next morning or evening. Do not leave the doe with the buck overnight or for a few days. You will not know whether or not a mating took place, fighting might injure either the doe or the buck and stress will be the result. Instead keep watching the animals without disturbing them.

If a buck shows no interest within the first few minutes, it is virtually no use leaving them together. In this case also try again later.

What do you do if the doe will not accept the buck? Check the vulva to see whether she is really in a willing period. Alternatively, she might be pregnant (see pregnancy control). She will almost certainly refuse the buck then, and every time she is bothered it will reduce the chances of a good litter. Another possibility is antipathy between the buck and the doe. In this case try another buck.

Sometimes it may help to hold the doe while she is in the buck's hutch. With one hand, hold her head and body to keep her from running away; with your other hand under her body raise her hind a little bit, thus initiating a posture which she should naturally or automatically take. Mating can be successful this way, but probably not as good as spontaneous mating.

If none of these suggestions work, you may want to use her for meat.

4.4 Pregnancy control

The fastest way to check whether the mating was successful is through palpation, but this requires practice. Palpation is possible from ten days after mating.

Place the doe facing you on a table, a bench or the floor. Put both hands on her sides and a little under the belly, gently pressing them

towards each other and upwards. Of course you can feel a lot in the belly. Among other organs, right behind the left ribs you can feel the liver; all the way up in the abdomen on both sides and just under the spine, halfway back you will feel the kidneys. You may also feel the small hard faecal pellets and the guts. If she is pregnant after two weeks you will start to feel soft things like slippery marbles, also in the upper side of the abdomen. These become progressively larger until you might even be able to feel the form of an embryo. Do not worry if you cannot feel all these things at first. After some practice you will be able to identify the embryos with little effort.



Figure 7: Pregnancy control

If this sounds too difficult it is also possible to check for pregnancy by putting the doe with the buck again 12 days after mating. If she refuses, the first mating has almost certainly been successful. If she is willing again, the buck can repeat his work. This method has the very small risk that an already pregnant doe gets mated again with the possibility of starting another pregnancy halfway through the first. This ‘super-pregnancy’ occurs occasionally.

Normally, at about 30-32 days after mating and a few days before giving birth, she will start pulling out her hair to prepare for a nest. This is soon followed by producing a litter.

Sometimes, you will notice a week or two after mating that the doe has become quieter, seems to eat less, and sits with her abdomen resting on the floor. Then she fails to produce a litter after making a nest. If this happens two weeks after mating it is called pseudo-pregnancy. This is a perfect time to breed her; she is willing and fertile right at the time of pseudo-pregnancy.

4.5 Kindling and mother care

When the doe is almost ready for kindling (about four weeks after mating) you can put a nest box in the maternity cage (for designs see Sections 5.5 and 6.4). Give her some nesting material (like straw). She will start pulling out hair from her forelegs and belly to furnish her nest. Kindling can then take place in this nest box. Kindling occurs at any time of the day but morning seems to be the most common time. All she needs now is rest and feed. A scared doe may eat her young. Cannibalism may occur for other reasons too, such as lack of drinking water or minerals, and sometimes for no apparent reason. However, unrest is likely to be a main cause. If a doe, especially after the second litter, keeps eating or biting her young it is better to kill her and eliminate this bad characteristic. Most does, however, have no problems and distinguish easily between the newly born young and the after-birth: they lick the first and eat the second, although smell and taste cannot be so different.

Do not handle the kindles more than is absolutely necessary, but check the newborn trying not to disturb them too much. Wash your hands first, as the smell of dogs, cats or rodents may upset the mother. Check the kindles for full bellies and check for dead ones. The smell of the nest will soon tell you if it is dirty. Diarrhoea causes a distinct unpleasant smell.

‘The doe does not take care of her kindles’ is a common complaint from beginners. In fact the doe only allows her kindles to suckle one or two times a day, and even then only for a short period. So the doe will rarely be seen with the kindles. Do not worry too much!

The hutch/cage should be large enough for the nest box and still leave space for the doe. If it is too small she might accidentally hurt the kindles by sitting on them. If disturbed, the doe may jump into the nest box to defend her young, but this might hurt them.



Figure 8: Young rabbit stages of development: left two days old, right 10 days old

The kindles will start to come out of the box after about two weeks, depending on the size of the box, the amount of milk the mother has and other factors such as temperature. After about three weeks the nest box can easily be removed. If the floor of the maternity cage is made of wire or has big holes which make it difficult for the kindles to put their feet down, give them a piece of plywood or something similar in a corner so they can sit easily. At this time they will also suckle (or seem to) more often in a day. The kindles slowly get used to the feed given to the doe.

Weaning usually takes place after about five weeks but should not be later than six weeks. Milk production seems to stop at that time, so there is no need for the young to be with the mother any longer.

4.6 When to mate the doe again

Like rats, the rabbit can be mated the very day of kindling and she is likely to become pregnant. However, results might be disappointing. The litters will be smaller and lighter and the kindles will have a higher rate of mortality. It also places extra stress on the mother to be pregnant and lactating at the same time. This intensive system is only recommended in commercial farms with pure concentrated feed.

When feeding and other conditions are optimal it is common to have the doe mate again ten days after kindling: this is considered to be a semi-intensive system of breeding. In back-yard farming, conditions can be assumed to be less than optimal. Therefore give the doe more time between matings: a 70-day cycle (including 30 days of pregnancy plus 35 days suckling (5 days rest) will probably be better and result in larger and healthier litters. This is called an extensive breeding system (see Figure 9). To avoid problems keep accurate records, such as a doe calendar (see Chapter 9).

Sometimes the doe will not accept the buck right after weaning. It may take quite a few days (or weeks) before she is willing. What can you do?

After weaning reduce the amount of feed (concentrate). Or place her near to the buck's cage so that she can see and smell the buck. The doe is most willing the day of kindling, 10 days after kindling and 3-5 days after weaning.

There are advantages to mating two does at the same time. If one of them refuses to suckle the kindles or dies, you always have a foster mother at hand.

Semi - intensive system: mating takes place 10 days after kindling.

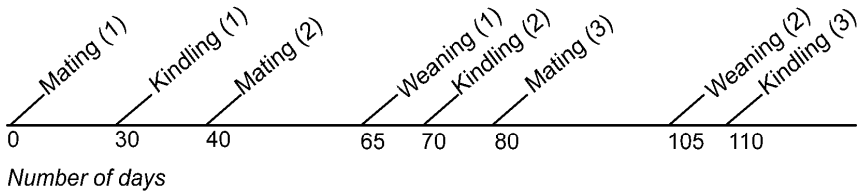

Extensive system: mating takes place 5 days after weaning.

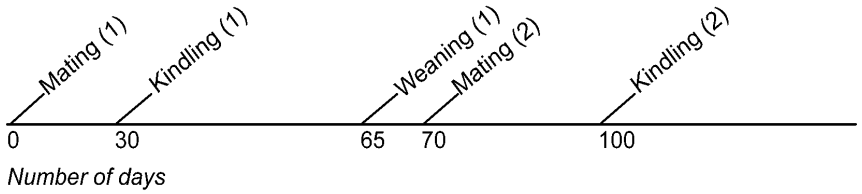

Figure 9: Timeline of intensive and extensive mating cycles

5 Housing: the hutches

The easiest way to keep rabbits is to let them run around, have them find their own feed, allow them to mate as they want, and when you are hungry you just try to catch one. Catching a loose (tame) rabbit might not be so difficult, but keeping the animals in this way will make it far more difficult to catch a good number of good and healthy animals. You will not know which buck is the father of which kindle, you will not know which does have become infertile, rats might get the best part of your rabbit crop, diseases can go unobserved or in any case untreated. To prevent diseases, inbreeding, premature mating or to be able to slaughter the right animal at the right time etc., we recommend making hutches and stables. In this way the rabbits can be managed and will be more profitable.



Figure 10: Individual hutch placed outside under a roof

We will discuss the following types of housing:

- 1 Individual hutches. Rabbits should be housed individually; group housing is not a good idea, because of the above-mentioned reasons. The hutches can be placed under a roof, in a stable or outside.

- 2 A stable. A main building in which you place the individual housing units (in this case also called cages) and where you can store feed and equipment.

Individual hutches can be placed outside in the open air, under a roof (Figure 10) or even inside some kind of building. Many designs are possible, but you should take the following factors into account:

- Microclimate (Section 5.1)
- Protection from predators (Section 5.2)
- Doors, hinges and feeding troughs (Section 5.3)
- Size of hutches (Section 5.4)
- Construction and building materials (Section 5.5)
- Maternity hutch and the nest box (Section 5.6)

5.1 Microclimate

Much can be said about rain, temperature, wind and sunshine when discussing the stable. The most important things to remember are that fresh air is necessary; draught is harmful; direct sunlight is unnecessary; a more or less stable temperature is best. For a hutch there are many different building materials which can be used. You can work with plastic, bamboo mats, corrugated iron, cardboard, wood, etc. Even though some materials will not last long, they require little investment for the small farmer.

5.2 Predators

Predators are probably the most important matter. Too often rats, cats or dogs scare the rabbits by walking over the hutch. They will also eat young rabbits if they manage to enter the hutch. Even if they do not enter the hutch, the does may be so scared that they even eat their own young.

Although it is very difficult to make a hutch rat-proof, it is especially useful for maternity cages. A rat will not easily attack a litter of four-week old rabbits. You can use either wire, bamboo, wood, or (galva-

nised) iron sheets according to availability and price (iron material has the definite disadvantage that rusty pieces can fall off and hurt the animals either through cuts and wounds or if they accidentally eat it). Bamboo is not readily chewed upon by rats or rabbits (especially the hard side) but it is possible for them to get through.

For the sake of hygiene, it is best to place the hard outside of the bamboo towards the inside of the cage so that it is easier to clean (see Figure 13). This means, however, that the soft side is left on the outside where rats can eat it. Regular inspection is necessary, since rats can get through small holes.

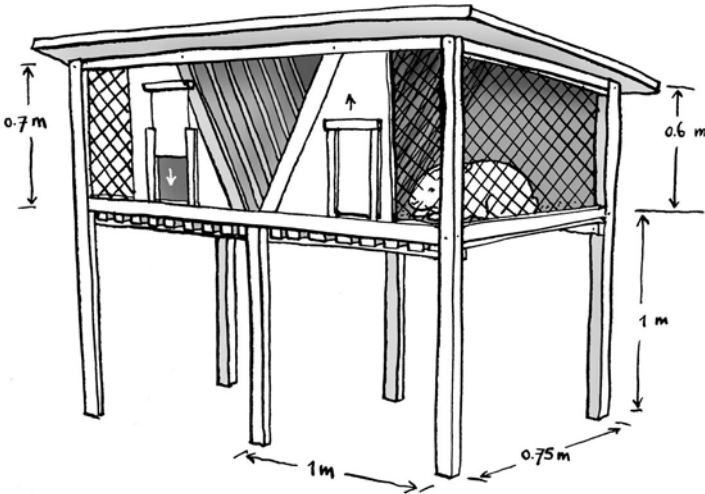

Figure 11: A two-compartment hutch. The hay trough is between the compartments. For these hutches a main building is not necessary.

If you place the bamboo slats close together no rat will get in, but neither will light and fresh air, so sometimes wire may be better. Preferably use welded wire instead of chicken wire. Chicken wire rusts easily, starting in the wet corner of the rabbit cage. Chicken wire is also not strong enough.

Another predator to watch out for is ants, which can reportedly attack a newborn litter. The only way to prevent this is by putting the legs of the hutch in cans filled with oil or kerosene.

5.3 Doors, hinges and feeding troughs

Construct the hutch in such a way that handling and cleaning can be easily carried out and you have a clear view over animals, feed and water.

Doors

The whole front side or part of it can function as a door. Besides swing hinges one can use a variety of other door designs.

Feeding troughs

The best way to fix the feeder, fodder trough or rake is to attach it to the outer part of the hutch in such a way that it can be filled and cleaned from the outside and the rabbit can eat from the inside. The side where the rabbit eats should be constructed in the form of vertical bars.

Keep the following points in mind when using a feeder for concentrate and other mixed feeds.

- 1 Do not put the feeder loose inside the hutch because it will be knocked over, carried away, etc.
- 2 Make a construction that lifts off easily (Figure 12).
- 3 Make it easy to clean.
- 4 Avoid the possibility of spillage.

Some examples:

- Fixing it to the wall is best done with hooks (Figure 12). Attach it preferably in a corner.
- Nail a plate or low edged can on to a piece of wood.
- Use a clay, cement or concrete block with a hole cut out in the center.

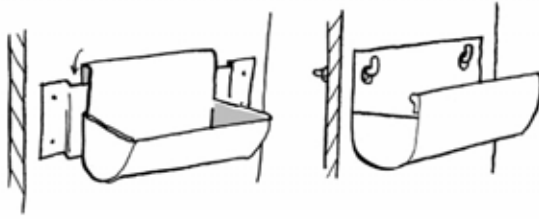

Figure 12: Hooks for fixing feeding equipment to the wall.

5.4 Construction and building materials

Let us now consider hygienic aspects of the various materials you can use to construct the hutch. Most attention should be paid to the construction of the floor.

It is possible to construct hutches with solid floors; be aware that these require regular cleaning and that litter material, like straw or wood shavings, should be used.

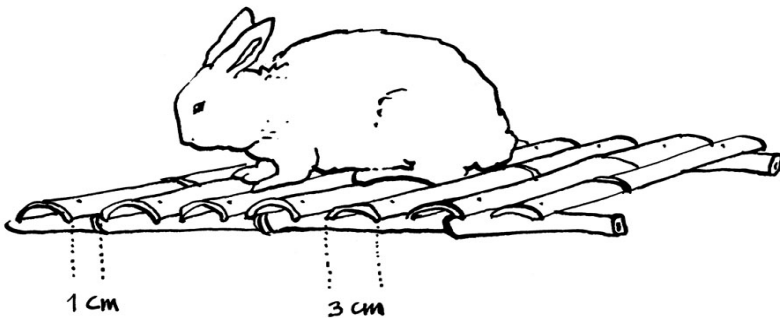

Figure 13: Use of bamboo to construct a slatted floor

Instead of having a solid floor a hutch could be constructed with a slatted floor. In this case you can use wood or bamboo, but preferably not wire for floors of outside hutches. The bamboo or wooden slats

should be close enough together to allow rabbits to walk on them, but wide enough to let the droppings fall through easily (Figure 14). Clean the cage thoroughly every week.

Try to make a construction that has no ‘dead ends’ where droppings can accumulate and extra cleaning will be required. Let the wooden slats or bamboo pieces run from the rear to the front, as this is easier to clean than from side to side.

One way of preventing floors from becoming increasingly dirty is to give every hutch a loose floor which can be taken out once in a while, cleaned, disinfected (by the sun) and put back in. Another way as shown in Figure 15 is to construct the back wall closer in, thereby keeping the dead ends outside the cage.

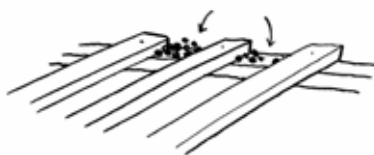

Figure 14: Dead ends in a cage constructed with wood

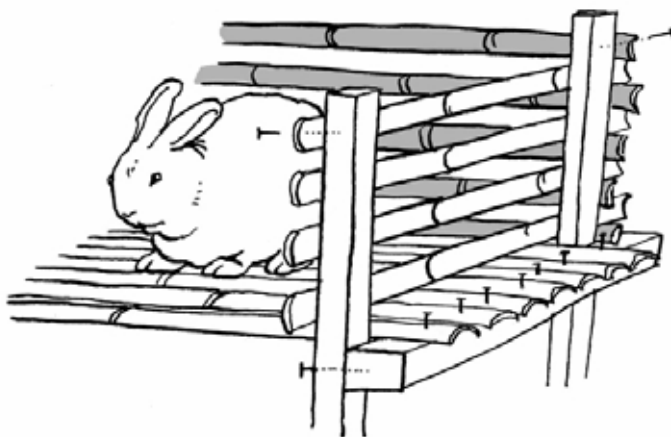

Figure 15: A construction method that avoids accumulation of droppings in the cage

5.5 The maternity hutch and the nest box

The maternity hutch is just an ordinary hutch as described above. You could make it a bit bigger so that you can place a nest box in it. The nest box can be placed in the back of the maternity hutch.

Its main function is to provide the doe with a specific place to make a nest and to prevent the kindles from roaming in the cage. The doe will not recognise the young kindles if they are not in the nest, and will therefore not nurse them.

There are many designs available for nest boxes: there are open types half-open types and closed types.

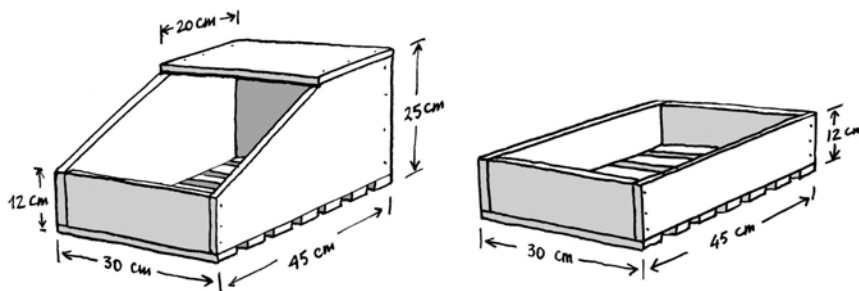

Figure 16: Half open type (left) and open type of nest box. Sizes vary with the size of the breed. (For closed type of nest box see Figure 21 in Section 6.4)

The advantages of open types are that they allow easy checking of the litter and they are easy and cheap to construct. The main disadvantage is the fact that the kindles are so exposed.

The advantages of half-open types are that the kindles are not so exposed and in a small hutch the doe has room to sit on top of the nest box.

Nest boxes can be made out of all kinds of materials. Remember, however, that hygiene is of utmost importance. Use smooth or easy to

clean materials (bamboo can certainly be used), watch out for nails and sharp edges and perforate the bottom with holes so that urine can escape. Plywood is a good material to use with wooden ribs (corners).

5.6 Conclusions

It is perfectly possible to construct the whole hutch including posts, supporting layers, etc., from bamboo. However, the whole construction will be somewhat easier, neater, straighter, stronger and longer lasting if you use wood for the frame and use bamboo for the 'closing up'.

Choose materials that are readily available to you. Maybe you have no bamboo, scrap iron, or wire but a lot of wood; maybe you have mud only and some thick sugar cane stalks, or you can obtain teakwood from a neighbouring teakwood sawmill.

Do not make a large outlay right away. Try one, two or three models first, and after a month you will know a lot more about what is suitable. You will probably not buy a 100 rabbits to start with anyway. There is no perfect model, every type has advantages and disadvantages. Always keep economy and hygiene in mind (e.g. slatted floors, no straw if not necessary).

6 Housing: the stable

6.1 General advice before you start building

Before going into the actual construction let us consider some general rules:

- Although initial expenses for constructing stables seem high, they are really relatively low. A good building lasts for several generations, so the costs per generation are low. The really high costs are for feed, labour, dead or stolen animals, care for sick animals and so on. If you start with a bad stable design it will force you day after day to duck if the door is too low, to do unnecessary walking, awkward cleaning, catch extra rats. In other words, the initial cost may be low, but the recurring costs are high.
- Do not start too big, but do not waste time on clumsy designs either. Do not try to spare a small amount of money on factors that could save you time later. Watch and ask your neighbours; study local buildings; ask why they use grass roofs and not galvanised iron; ask why they use bamboo instead of bricks; ask why they put the roof at a 60° instead of a 40° angle and so on. Do not forget that local people distinguish between bamboo for roofs, bamboo for bridges and bamboo for mats. Why do they tie the constructions with wire and not use nails? A multitude of these and other questions can be asked. Do people consistently build the roof in one direction? Is there a difference in soil types that influences the use of wooden posts? Sandy soil absorbs moisture and does not always need cement, whereas clay becomes dirty very soon and it is therefore better to put the cages on cement, or wooden racks, etc. What do people do to prevent termites or other insects from invading the hutches? Do they have specific ways to keep out rats?
- Buildings should be constructed in such a way that working is not too difficult. Do not try to save money by using a cheap design that will end up being a constant bother. Keep the does separate; keep the growers together; keep everything clean and dry. Try to construct the cages or hutches in such a way that you can easily divide them into two or even three compartments. If you want to keep a

large number of rabbits put the storage space for equipment, feed, medicine and administration all together in the middle of the main building. Keep the reproduction animals at one side and the growers and fatteners at the other side of the storage room.

6.2 Important features

Let us now discuss some features of your stable, assuming that you need such a building. All of the following points should be considered. They are all inter-related, so read through them thoroughly first and then decide how, what and where to build.



Figure 17: Small unit, stable for ten does

Rain, wind and sunshine

To prevent rain from coming in, give the roof an overhang (eave). Designs depend among other things on the wind direction. If the wind always comes from one direction it is easy, but if the wind (and thus also rain) comes from different directions you might have to construct walls. A large overhang also prevents direct sunlight from coming in. But do not make the overhang so low that you have to stoop every time you enter.

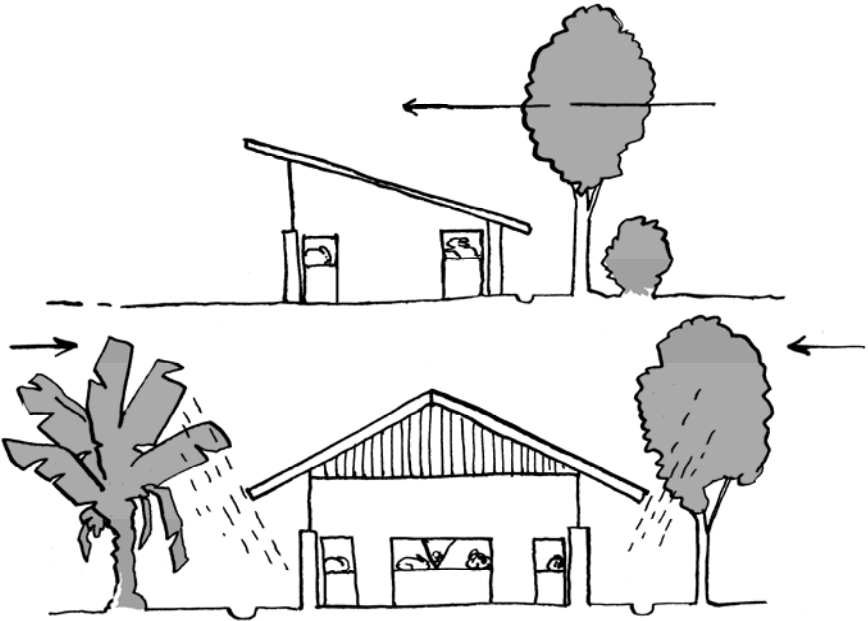

Figure 18: Roof and trees as protection against rain, wind and sunlight

The height of a building is a compromise between fresh air, keeping out rain and, last but not least, the building costs.

Walls may be closed or open. Besides climatic conditions (rain, draught, cold wind, fresh air), theft and expense play an important role in this decision. It is a good idea to erect a solid (brick or wood) wall up to the height of the top of the cages and wire netting from wall to roof. This prevents draughts of air from reaching the animals and it keeps out predators and thieves.

A note on straw, grass or leaf roofs: they need a steeper slope (implying a larger roofing area, thus greater expense) than tiles, and have to be much larger than the minimum necessary for galvanised iron sheets. If the slope is too small, water will not run off but will leak through the roof.

Temperatures

Various measures can be taken to mitigate extreme temperatures. Trees around the building create shade and thereby decrease the amount of heat that enters during the day. They also somewhat decrease the amount of heat that escapes during the night through radiation, and lessen the impact of wind and rain (Figure 18). Some fast-growing legume trees are *Leucaena*, *Gliricidia*, *Sesbania*, *Erythrina*, which might even provide some feed for the animals. Besides trees, the roofing material greatly influences the temperature inside. Use your own judgment: corrugated iron is hotter than straw, grass or tile (especially if the roof starts to become rusty).

Humidity and fresh air

A stable on sandy soil with good drainage and good ventilation will be better than a poorly ventilated stable on moist soil. Animals also produce moist air! Open walls create good ventilation (you can use materials such as wire or bamboo mats to keep out thieves if necessary). Also, a high building is better than a low building; and a tile roof (with many air holes) allows for more ventilation than a corrugated iron roof or a grass roof.

If you do not have much wind blowing through the stable, warm air ventilation holes might be necessary. Avoid the compilation of manure and urine in the stable. That will cause ammonia to fill the air and affect the animals.

You are the best judge of the microclimate in the stables. If you are bothered by heat, humidity or the smell of ammonia, you can be pretty confident that the animals feel the same way!

Protection

Protection from predators and theft was discussed before related to the design of individual hutches. Let common sense be your guide: rats will come in no matter what you do, cats and dogs can be kept out quite easily. Thieves are another problem that you will have to deal with according to your best judgement.



Figure 19: Roof construction in relation to ventilation

6.3 Cages

Cages can be made out of various construction materials, such as wire, wood or bamboo. The dimensions of the cages are often 50 cm wide x 60 cm deep x 30 cm high (with nest box hanging outside the cage).

You might want to make the cages higher, especially the maternity cages because the doe likes to rest on the nest box. Where space is limited, it is possible to keep two layers of cages. But be careful, the hotter and the more humid it gets, the more space you will need to maintain a good microclimate.

Wire for the floor is probably the cleanest option, provided the maze is large enough to let the droppings fall through. However watch the quality; do not use wire which easily rusts; it may break and could wound the animal.

Do not use chicken wire, it is too sharp, but rather so-called welded wire with a diameter of 2 mm. Use openings large enough to let the droppings go through, but small enough to make it possible for three-week-old kindles to walk on. Recommended openings are rectangular 1.3 x 7.5 cm or square 1.9 x 1.9 cm. Wire floors may lead to sore hocks, a disorder to which larger breeds are especially susceptible.

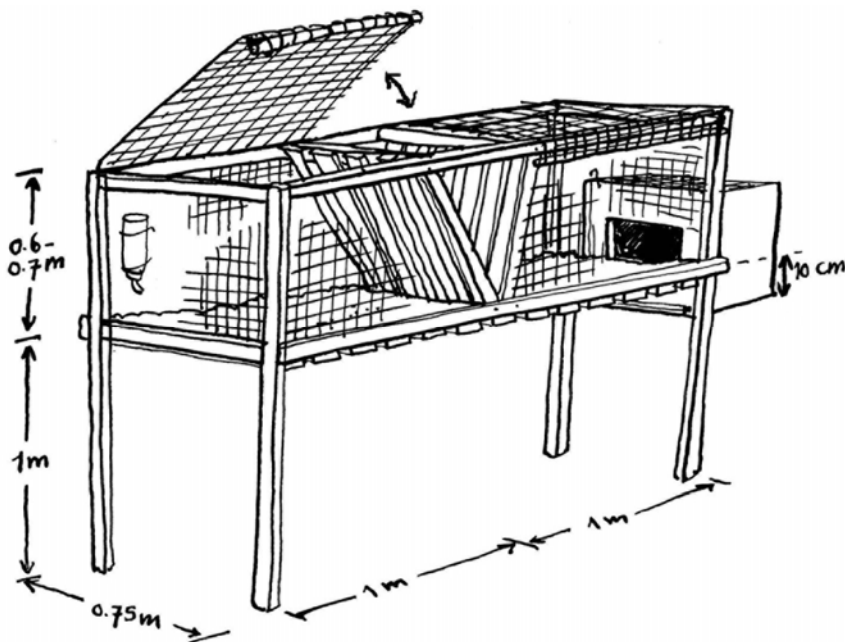

Figure 20: Side view of cage with a closed type of nest box

You may decide to use less-strong wire for the sides of the cage where the animals do not step and where corrosion by urine will be slower, etc. You can also just as well use wood or bamboo for the floor. The bamboo or wooden slats should be close enough together to allow the rabbits to walk on them, but wide enough to let the droppings fall through easily. Clean the cages thoroughly every week.

As with outside hutches, try to make a construction that has no ‘dead ends’ to clean, give every cage a loose floor or construct the back wall such that the dead ends are outside the cage.

6.4 Nest boxes

If the cages are large, the nest boxes explained in Chapter 5 (open and half-open types) will do.

If the cages are small you may need a closed type of nest box. Normally these hanging nest boxes are attached on the outside of the maternity cage. This saves space as the maternity cages may then be the same size as all the other cages. It also makes it easier to control the litter. It does, however, require a somewhat more complicated design (see Figures 20 and 21).

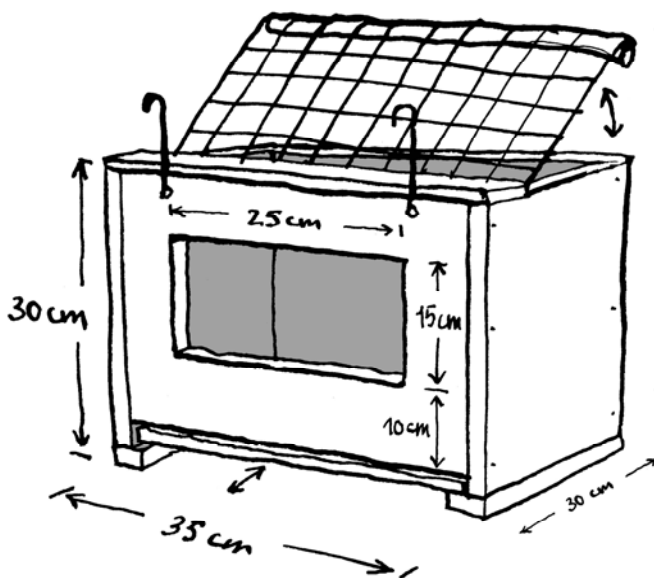

Figure 21: Closed type of nest box

When the nestbox is used hanging outside the cage, cage dimensions could be as follows: front 35 cm, depth, 30 cm, height 30 cm. The floor can be made of perforated wooden board (plywood), which can be taken out.

6.5 Conclusions

You will have to decide for yourself how, where and what to build. The decision will always be a result of weighing various factors that are of importance, like choosing between the material for the roof. For example, a grass/leaf roof is cool, well known, cheap and easy to produce locally but it will need regular maintenance; a corrugated iron roof is hotter, more expensive, badly ventilated but it is longer lasting and definitely cleaner (does not attract rats or birds).

For small-scale rabbit husbandry a main stable probably will not be necessary, because a hutch can be placed under an overhanging roof, in the kitchen or under a tree with some plastic to prevent rain coming in (depending on climate). Rabbits do not like direct sunlight; shade will keep heat away and generally also prevent rain from coming in.

7 Nutrition

It is beyond the scope of this booklet to explain the basics of animal nutrition. There are enough other practical booklets on this subject to help the interested reader (see the literature list at the back). Here we will just outline some main principles. However, if you know the rabbits' requirements, but not the nutritional value of the feed available, you will not be able to use this information. Laboratories are not always available and, moreover, a laboratory analysis does not say much if you do not know the digestibility of the feed, which is difficult to measure. For real advice about your specific feed situation, it is better to contact local specialists at universities or experimental stations. Do not forget to take into account prices, seasonal availabilities, possibilities of storage, etc. Also do not forget to look at the health and performance of the animals. These aspects are the best measurements of whether they are being fed correctly. Too fat is not good, but too thin is not good either. Experience will help you find the right balance!

7.1 Water requirements

Before we deal with feeding requirements, let us first have a look at the need for water. Water is not considered a nutrient. But this does not mean that the rabbit does not need it. Many people claim that a rabbit does not need drinking water because food like grass, cassava leaves or sweet potato tubers contain moisture already. Indeed, these roughages provide the rabbit with some water; for just maintenance of the body it might even be enough. But a general advice is to give them access to clean water. The animal itself feels that it needs some drinking water. Moreover, how can a lactating doe produce enough milk without drinking water? The expense of providing water is nil; but of course it does require some more work and sometimes the water gets dirty and starts to smell. With proper care and equipment, the provision of clean water can and should become a routine.

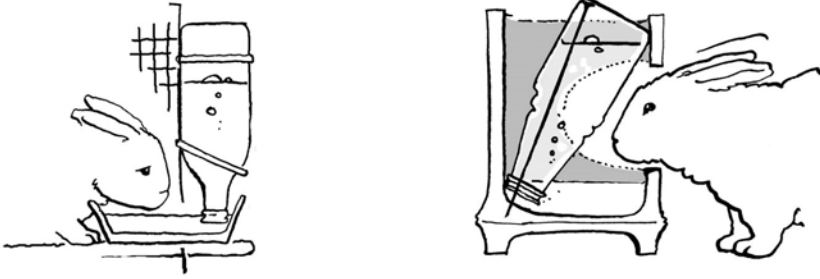

Figure 22: Some drinking equipment designs

7.2 Feed

Proper feeding will influence the rabbit's growth, fertility and health. Some foodstuffs contain a lot of protein (especially fresh greens), and some are sources of energy (like rice bran, tubers, etc). Both protein and energy are important nutrients, but minerals, vitamins and common salt are also required.

Roughages or fodders

To start with, a rabbit will benefit most from greens such as grass, leaves, vegetables, etc. However, allow such feeds, also called the roughages, to wilt for half a day before feeding them. This will prevent the animals from bloating or from developing other 'stomach' problems. Watch out for possible poisoning from cassava leaves or other plants. Usually the local population is aware of which plants are poisonous. But not all leaves or grass are the same. Young (four-week-old) grass is easier to digest and contains almost twice as much protein as eight-week-old grass. Leaves are much more nutritious than stems, so try to find grass with a lot of leaves. However succulent the stem may seem, its feeding value is generally low; but it does have a positive effect on intestinal activity.

You are lucky if you live close to a market where cabbage leaves, carrots or bananas may be thrown away (watch out for herbicide/pesticide residues). It is also possible to feed rabbits left overs

from your kitchen or the local restaurant. Watch out for glass and other impurities! If you have a lot of that kind of feed, you might also consider buying a small pig.

Roughages or fodder crops are usually fed in voluntary quantities. Note: when the kindles leave the nest box, they start eating their mother's feed, so make sure they are getting clean fodders.

Just like humans, rabbits need variety in their diet, and grass or green leaves may not be enough for lactating and growing animals. Neither humans nor rabbits can work and/or reproduce well if they only eat vegetables without grains or other starchy foods like tubers. It is best to add something starchy (that contains a lot of energy) to the feed of rabbits. Good candidates for this are rice bran, (cassava) tubers, waste carrots, corn (expensive!) and rice left over from the kitchen.

Concentrate or commercial mixed feed

The amount of feed to give a rabbit depends very much on the state of production. A lactating mother needs a lot of concentrated feed (grain, tubers) in addition to greens, to maintain her bodyweight and produce milk for her young. Young rabbits also need some concentrated feed for growing. In general we could say: some concentrate supplement in addition to fodders will improve performance, like growth, survival of the young rabbits, condition, etc.

It may also pay to give rabbits some commercial rabbit feed in addition to fodders, preferably in pelleted form. If this is not available sow feed or ruminant feed will do; and if that is also not available give them broiler or chicken feed. When you feed meal it is better to moisten it a little bit, otherwise the rabbit cannot eat it; with its rodent teeth the rabbit can hardly eat meal or dusty feed.

Apart from energy and protein, minerals are also an important ingredient in the diet. Greens and concentrates contain a lot of minerals. Nevertheless it is advisable to add some minerals in the form of salt to the food. For example, when feeding rice bran, one spoonful of salt

mixed with 1 kg of bran will be sufficient. Pieces of a smashed ruminant lick block may also serve for rabbits. If there is a local specialist or experienced breeder nearby, ask for advice about the supply of minerals.

In general we can say that a concentrate for rabbits, if used as the only feed, should contain:

± 17% crude protein and

± 15% crude fibre.

Recommended maximum quantities in the concentrate are as follows:

20% bran of cereals (maize, wheat, rice, sorghum)

20% middlings from cereals

15% cakes or meals from oil by-products (soya, sunflower, groundnut, palm kernel, cottonseed low gossypol)

5% molasses

25 to 50% grass or alfalfa meal, or well-dried and very good green

2.5% premix containing vitamins and minerals

0.3% salt

Experience is, however, the best guide. Feeding of 100% rice bran is possible (if good quality) and growth may be slower, but that should not be a problem if that rice bran or any other feed is cheap, clean and palatable.

7.3 Some practical remarks

- Do not change feed suddenly.
- Do not get desperate if your animals seem to not like good feed at first glance. Try it for a few days; if necessary starve them a little. The rabbit is notorious for its likes and dislikes, which are difficult to predict.
- Greens should not be too wet, because it will upset the stomach and cause bloating in the caecum or diarrhoea and death.
- Do not feed rabbits more than they will eat; remove old (mouldy, dusty) feed. Rice bran and oil seed cakes in particular have the ten-

dency to become rancid, so do not feed that too much. Give the leftovers to other animals.

- Cooking the feed will generally not justify the effort.
- A good feeding method is to give concentrate (rice bran, corn, roots) during the day and greens overnight. This is also done to avoid attracting rats during the night.
- Did you know that the rabbit practices coprophagy or pseudo-rumination? That is the consumption of faeces originating from the caecum; and thus the rabbit recirculates part of the feed through the body. During the night the rabbit produces a cluster of soft small faecal balls. These are not like the well-known small dry individual larger balls (see Figure 23). The rabbit eats these again but will not touch the dryer pellets. Coprophagy (in the rabbit: caecotrophy) occurs also with other animals to a lesser or a greater extent (e.g. monkeys).

If you find the caecotrophs in the hutch or under the cage, it means that the rabbit is either sick or was disturbed when eating its caecotrophs.

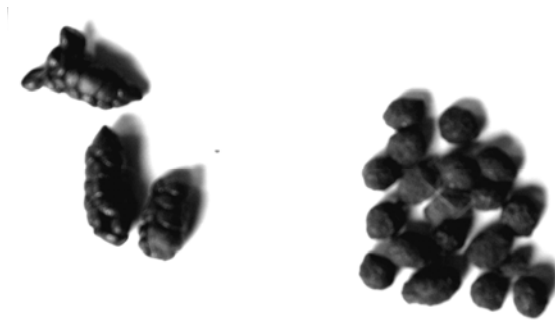

Figure 23: Picture of the two types of droppings. Right: the normal hard droppings from the colon. Animals with droppings such as on the left (the caecotrophs) should be watched to be sure they are not developing intestinal problems.

7.4 Growth rates of rabbits

It is a good idea to weigh your animals regularly (for example every week). By measuring growth you will have a much better idea of the well being of your animals than by visual observation only. Growth rates of around 15-20 grams per day are common in the tropics even though it is possible to obtain 30-40 grams per day on very good food. Don't forget that the animal reaches highest growth rates in the first months. After becoming mature the body weight will remain constant. So if your animals start growing less, but are not diseased or receiving bad feed, age might be the factor!



Figure 24: Weighing rabbits

Do not feed for the fastest growth, but feed in such a way that you can achieve a balance between growth and general health, and between the cost and benefit of feeds. Rabbits may be able to subsist on greens alone, but young, growing animals and does need supplements with preferably some grain (corn, rice bran) to stay healthy, grow and reproduce.

8 Health care

The main cause of mortality in rabbits is probably intestinal problems. Second is diseases of the respiratory organs. These are sometimes an indirect consequence of intestinal problems, which reduce the animals' resistance. The third most common cause is a whole group of diseases, of which myxomatosis is probably the most well known but least frequent. Problems of skin parasites are bothersome but hardly ever fatal and are easily cured.

In the Further reading section at the end of this booklet, you will find some references to excellent literature dealing specifically with rabbit diseases. A list of most-common diseases, their causes, diagnoses and cures is provided in Appendix 1.

Table 1: Signs of a healthy and of a sick rabbit.

Characteristics of a healthy rabbit:	Signs of a sick rabbit:
Active, lively, curious	Listless, apathetic
Shiny fur, balanced length over the whole body	Untidy fur, uneven patches, scabies
Proper weight according to breed and age	Too skinny
Dry nose that moves up and down, dry forefeet	Wet nose, wet forefeet (caused by rubbing the nose)
Clean eyes and ears	Wet eyes, discharge, crusts in the ears caused by mites
Clean anus, dry round droppings	Diarrhoea, dirty hind parts
Good appetite, eager to eat	Lack of appetite
Nails are the same length as the fur	Nails too long
Mucous membranes pink in colour	Mucous membranes have an abnormal appearance
Turgor < 1 sec = a fold of the skin must disappear in one second	Turgor >3 second = skin too dry
Upper and lower teeth straight opposite each other	Elephant teeth, too long and curved
Body temperature 38.5-39.5° C	Abnormal temperature, respiration, or heartbeat.
32-60 respirations per minute	
120-300 heartbeats per minute	
Good condition	

The emphasis of this chapter will be on the prevention of disease. Prevention is the easiest, cheapest, and most logical way to keep rabbits healthy. Only if 'bad luck' strikes is treatment necessary. Success is then far from guaranteed and medicine is often expensive or not easily available.

8.1 Prevention of diseases

Some steps to prevent disease problems in your herd are discussed below.

- 1 Try to avoid buying your animals at the marketplace where many unknown germs come together. Try to buy from respected breeders, or farmers with clean housing and healthy-looking animals. Inspect the animals in any case, and after bringing them home keep them separated from your other animals (in quarantine) for at least two weeks.
- 2 Routinely check the health of your animals as follows:
 - Check nose, eyelids, ear edges for mange (little crusts), and inside the ear for ear mite.
 - Check the manure. Is it dry or somewhat pasty?
 - Feel the stomach, to check that it is not spongy. This requires some practice.
 - Check nose and front legs. Certain coughs produce a kind of coryza, which makes the front legs dirty.
 - Check for smell in the hutch. Diarrhoea/enteritis often causes an unpleasant smell. When the doe is lactating she is under stress and more liable to suffer an attack from intestinal germs (which are always present), such as coccidiosis. Sometimes the nest box will therefore need cleaning.
- 3 Make a hutch design and use materials which permit easy cleaning. Although bedding (straw, etc.) is often used in Europe and the USA, in the warm tropics it has in this respect more disadvantages than advantages and is therefore discouraged.

- 4 Clean the hutches every day and keep them dry.
If you suspect disease, disinfect! There are many possible kinds of local disinfectants like carbol, creoline, lye solutions (lime, sodium), Teepol, formaline or formol (very strong so use with caution). If necessary you can use kerosene if nothing else is available. Do not forget that some soap or bleaching agents contain chlorine. Not all, but most of these disinfectants have a strong smell which hurts the respiratory tract of man and animal alike. Keep the animal away if you are cleaning with the stronger agents and do not put it in a cage which still smells. A good and harmless disinfectant that is always cheap but not always available is sunshine. Fire (a small gas flame) is okay but has obvious disadvantages. It is often used in wire-netted cages to remove the hair accumulated on the cages.
- 5 Keep animals away from their manure. Slatted floors and no (or only shallow) litter are preferred.
- 6 Separate animals you suspect are ill so they do not infect healthy animals.
- 7 If you want to be really careful, do not let visitors get close to the cages and place a shoe bath with disinfectant at the doorstep to the stable. Additional measures of your own design can also be implemented to ensure 100% infection prevention.
- 8 Clean, fresh air in the stable is essential. A strong manure smell is not good. If you cannot stand the smell, the rabbits probably cannot either.

8.2 Intestinal problems

Rather than focusing individually on the specific causes and symptoms of intestinal problems (coccidiosis, bloat, enteritis, diarrhoea, etc.), for the purposes of this book it is sufficient to speak of the general 'enteritis complex'.

➤ *Prevention*

This is almost the same for all of the causes. Keep the animals away from their manure. Clean the stables every day. Do not give excessively wet feed. (Note, however, that it is probably not the feed alone causing the ‘enteritis complex’. Rather, the intestine gets so disturbed by excessively wet feed that disease agents have more opportunity to attack.) Give the animals good-quality feed.

➤ *Causes*

There are a variety of intestinal parasites besides bacteria. Specific feed factors can also cause a lot of gas to develop (bloating) or reduce the rabbit’s resistance.

➤ *Symptoms*

Diarrhoea, no appetite (anorexia), listlessness, wet or dirty rear, bloated and/or spongy-feeling abdomen, rough fur or loss of weight (if you can feel the two bones at the end of the back beside the spine, then the rabbit is becoming too skinny).

Not necessarily all of these symptoms show up clearly or at the same time! A fatal liver coccidiosis for example hardly ever gives diarrhoea. After slaughtering some animals you’ll soon get an idea of what is a normal intestinal mass and what is abnormal. A large liver with white spots is caused by liver coccidiosis. Laboratory equipment, such as a microscope, is required to determine other causes of intestinal problems, which is beyond the scope of this booklet.

➤ *Treatment*

The first step is to stop feeding the rabbit concentrate and supply only dry roughage which is very fibrous, like straw. Then give good-quality, drier feed to help restore the microflora in the intestines. Celery leaves are also known as a healing agent in intestines.

Treatments with sulfa medicine can be very helpful, especially as a preventive measure. Animals that are severely dehydrated (skinny) as a result of diarrhoea should be forced to drink by ‘injecting’ water or

milk, etc. into the mouth. The water should preferably contain some salt and sugar (9 g salt + 9 g sugar/litre water). Give a quantity of liquid that is 10-20% of the animal's body weight. A variety of sulfa medicines are available, the doses for which can be found in Appendix 1 of this booklet. Experts usually suggest mixing these sulfas or other medicines with drinking water or concentrate. However, this does not help a sick animal that has already stopped eating and drinking. Use an injection needle to drench the animal (see Figure 25).

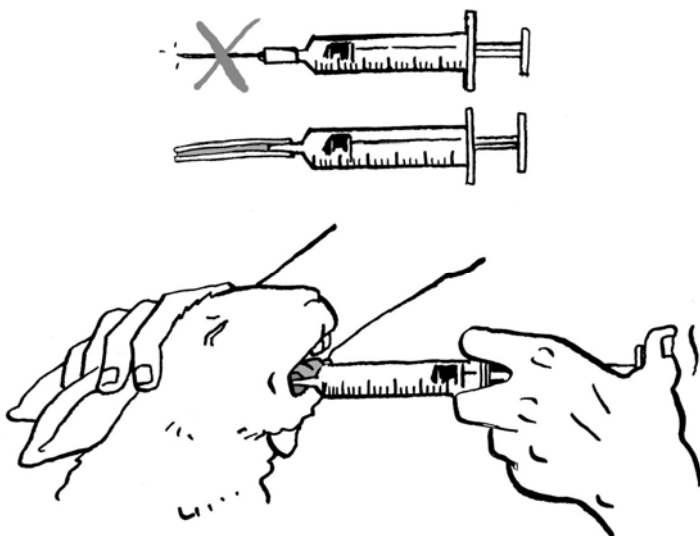

Figure 25: Drenching an animal with a syringe or an injection needle covered by a small tube

Lactating does are especially likely to develop 'enteritis complex' (mainly coccidiosis), thereby infecting their young at the difficult start of their existence. Therefore many young will have severe troubles at 4-7 weeks with 'enteritis complex'.

Advice: After kindles leave the nest box, give doe and kindles a preventive cure with sulfa. This will significantly impede the occurrence of coccidiosis as well as other intestinal problems!

8.3 Problems of the respiratory tract

Various causes of coughing, sneezing, coryza and pneumonia can lead to sudden death and are difficult to distinguish for a non-expert. They are not always caused by bacteria like pasteurellosis, and medicinal cures are rarely successful.

➤ *Prevention*

Ensure the animals have fresh air and dust-free, clean surroundings. To prevent a disease from spreading, separate sneezing animals, and slaughter them or sell them to a butcher. Replace the culled ones with new young replacement stock.

➤ *Symptoms*

The symptoms of respiratory problems are sneezing, coughing, dirty front legs (because they are used as a handkerchief), and noisy respiration. Not all affected animals die; some may live and kindle as normal, but sometimes death occurs quite unexpectedly. On opening the dead animal you'll see that 'healthy' and 'sick' animals look alike. Very few have 100% clean lungs. Nevertheless there are cases in which the lungs are so bad that one wonders why the animal did not die earlier.

➤ *Treatment*

Besides some antibiotic treatments, not much can be done that has not been described in the section on prevention. Be very careful with giving antibiotics to rabbits; they can easily upset the microflora of the intestines. Rabbits are very sensitive to antibiotics!

8.4 External parasites

As discussed above, coccidia is an internal parasite that is part of the enteritis complex. Tapeworm and roundworm are also internal parasites which occur in rabbits, but they are rarely considered important causes of mortality. Two very harmful kinds of external parasites are skin mange (scabies) and ear mite.

➤ *Prevention*

Do not bring in dirty animals from other places; clean the stables regularly and thoroughly; keep careful watch for infection on each animal's nose, ears (inside and edge), eye lids and sexual organs. Give monthly injections with ivermectine to prevent the occurrence of mites and lice.

➤ *Symptoms*

These parasites rarely cause death, but they are a bother. Sometimes the infection may heal spontaneously. The scabies/skin mange gives a flaky appearance (usually white) starting at the nose, and then spreading onto eye lids, ear edges, sexual organs, under the forelegs and other hidden places. The ear mite forms more blood-coloured, pasty, dirty-brown crusts inside the ear, which may sometimes cause other ear infections.

➤ *Treatment*

Treatment with medicine can be completely effective if the instructions provided with the medicine are followed carefully. When using good insecticides like NEGUVON or ASUNTOL (or other tick medicines intended for cattle, dogs or cats), bathe the animal completely to eradicate the parasites. You should keep the nose and mouth above the surface. Make sure to use the right concentrations, and do not use cold water in a cold place. The animal will dry off by itself (sunshine or another source of heat will help).

If you do not bathe the animal completely, the parasites will keep coming back from their hiding place. Use the bathing water to clean the stable walls and floor to kill the parasites there. Other local medicines can also be effective (like sulphur solutions). Although effective, oil has the disadvantage of being very messy. Moreover, just like kerosene it gives a burning sensation. You can test this yourself by putting some gasoline or kerosene on your upper lip! For ear mange mix oil (e.g. cooking oil) with a bit of iodine and rub this into the ear hole. The oil kills the mites and the iodine heals the wounds.



Figure 26: Treatment of mange at the feet



Figure 27: Treatment of ear mite by spraying insecticide in the ears

8.5 Other diseases and health problems

The most common problems not mentioned so far are sore hocks (appears to be hereditary), lame animals (variety of causes), injuries, sore breasts, mastitis. Use your common sense in these cases: do not waste too much time waiting to see whether the problem will go away. Slaughter and eat the animal so you can use your time and energy for more relevant matters. Besides being practical, you will save the animal a lot of suffering. In the long run you are selecting the best and healthiest animals for your further breeding.

Sore hocks mostly occur in reproduction animals, due to sharp wired floors and the likelihood of wet hocks. Give them a soft plastic wire netting on top of the cage floor or give them a piece of board to sit on. Broiler rabbits do not suffer from sore hocks, because they live only a short period and are therefore lighter.

9 Administration

Many things need to be taken into account with rabbit keeping: expenses for stable building, feed prices, purchase price of animals, etc. Although bookkeeping is important, it is not the focus of this section. The most important administrative task from the management point of view is the registration of your animals: recording dates of birth, mating and kindling, parentage, signs of disease, growth rate, and so on. In order to keep track of all this information, you will need a proper administration system.

9.1 Identification methods

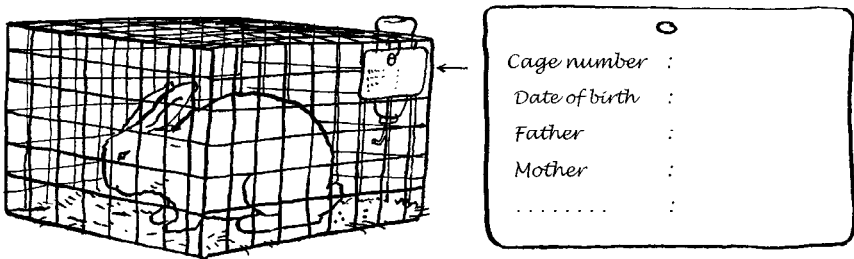

Figure 28: Cage tag with details of the rabbit

First it is important to give your individual animals some form of identification. This can be a tag made of plywood, cardboard or a flattened tin can hung on the cage of each animal. If you apply black-board paint to a piece of plywood and use regular chalk, which can be wiped off, the tag can be used again. Every time you move a rabbit to another hutch, the identification tag accompanies it.

A good piece of advice: Always keep breeding animals (bucks and does) in separate cages. The cage number is then also the identification number of the animal in it.

9.2 Record keeping

It is a good idea to keep a book with information on each of the rabbits. Even better is a set of cards or a book with loose pages so you can rearrange the pages if necessary.

It is important that you know what happens to which animal at what time, for example to prevent inbreeding. Weaners from one litter are kept together for fattening. The litter as a whole gets a broiler record card. Animals for breeding are selected from the litter of weaners. Each young doe or buck selected for breeding should be given a new card or board on its cage when they start breeding. At that time you give them a page in your book or a card in the box.

Another important thing you might want to consider noting is the individual weight of each rabbit at for example first breeding age. For examples of record cards see Appendix 1.

9.3 The calendar

By watching the animals closely you can check daily if some are ready to be mated, kindle, or be weaned, etc. However, you may also keep a calendar that will help you record and anticipate the daily happenings (Figure 29).

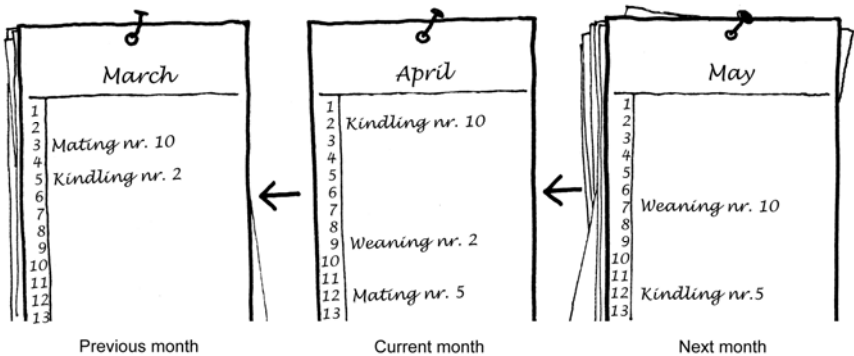

Figure 29: A calendar with important data

10 Processing

10.1 Killing and slaughtering

Normally broiler rabbits (New Zealand White or Californian breeds) are slaughtered at a weight of about 2.5 kg. For animals that were forage-fed this will be at around six months of age; for those that were fed concentrates this will be at around three months of age. At that weight the daily gain has slowed down.



Figure 30: Skinning a rabbit

Before starting you will need:

- A clean working area
- A way to hang the rabbit when slaughtering
- A container to receive intestines, blood, etc.
- A sharp knife
- Salt to temporarily preserve the pelt
- A container to keep the carcass in
- Rope or strings to hang the carcass
- A pair of scissors.

Unlike when slaughtering chickens, no water is used on the carcass when slaughtering rabbits.

Step by step instructions on how to slaughter a rabbit:

1. **Stunning.** With a stick hit the rabbit between the eyes and the ears. The animal is stunned when it trembles all over its body. The animal is now unconscious.
2. **Killing.** Hold the animal by the hind legs. With a sharp knife cut the veins in the throat. Allow the rabbit to bleed, but prevent the blood from staining its pelt.
3. Remove the head by cutting it off to allow further bleeding. Sometimes the head is left on the carcass to show that the carcass is really from a rabbit.
4. Press the urine bladder empty, so that the urine later on, when hanging, does not spoil the meat.
5. Fix a string just below each hock and hang the animal from a firm bar.
6. Cut off the tail and the forefeet with a pair of scissors.
7. **Skinning.** Cut the skin around the hocks. Then cut the skin open from one hock to the other, passing the tail and anus area.
8. Work the skin downwards gently without using a knife. Cut the skin around the neck if the head is left on the carcass. If there is blood stuck onto the skin, it is better to wash it off; otherwise it may stain and remain as a black spot when curing the pelt.
9. Cut the abdomen open starting at the navel, moving upwards and then downwards. Be careful, the walls of the stomach and intestines have very few muscles so they can easily be punctured. Their contents could then spoil the meat.
10. **Evisceration.** All intestines can now be pulled out, including stomach, bladder, lungs, etc.
11. Remove the kidneys, heart and the liver (edible parts) and keep them separately.
12. The clean carcass is left over.

The dressed rabbit (which means carcass plus kidneys, heart and liver) weighs about 50% of the animal's live weight.

10.2 The process of tanning

The commercial demand for pelts from homestead livestock is very low in many countries. But these pelts are not useless. Anyone who is interested can do an acceptable job of tanning these skins for use in a variety of craft projects. Tanning is a way to preserve the skin in order to use and further process it for handicrafts.

If you want to store the pelts and process them later, they have to be salted. The pelts can be salted in a bucket under water with an excess of salt, or layered with salt sprinkled on the fleshy side.

Before tanning rinse the salt out of the skin and remove the fat and fleshy parts from the inner side of the skin. Fat and flesh on the skin may prevent the chemicals from entering the skin, which will result in a rough rather than smooth pelt.

There are various methods of tanning:

- 1- The alum method
- 2- The sulphuric acid method
- 3- The crom method
- 4- The oil method
- 5- The tannic method
- 6- The egg yolk method

In this booklet we will explain the first two methods:

Alum method of tanning a rabbit skin

Through this method the skin becomes soft and flexible. It is especially effective when applied to the skin of recently slaughtered animals.

Ingredients for ten pelts:

- 1.5 kg white alum (K-Al-SO₄)
- 0.625 kg salt (NaCl)
- 25 l water
- A bit of water-soluble oil
- Cereal flour

Instructions:

Thoroughly mix the alum, salt and oil in the water and heat it a bit to obtain a correct solution. Cool down the solution and insert the pelts; stir in alternating directions for better contact. Be sure they are well submerged by using a (non-metallic) weight of some sort. Leave the pelts in this bath for 48 hours.

After this period wash, squeeze and dry the pelts (with the fur on the outside), but not in direct sunlight. Once they are almost dry, put them in a tumbler with wood shavings and some cereal flour. Through this process the skin becomes dry, it breaks and the flour takes away the oil in the fur. The last step is to gently pull and stretch the skin around or over a round surface.

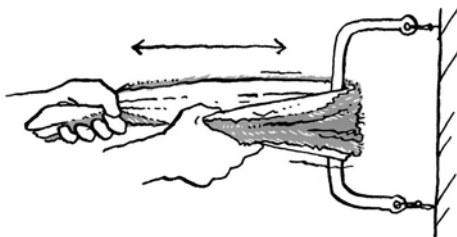

Figure 31: Breaking of the skin

Sulphuric acid method

The tanning agent in this method is sulphuric acid. You can use battery acid, which is available from any garage or auto supply store. Battery acid is diluted sulphuric acid. Be careful with acid, because it is very dangerous. If you get it on your skin, you will be badly burned. Diluted with water it is less dangerous. Never pour the water into the acid, but always pour the acid into the water carefully.

Ingredients:

- 60 g of sulphuric acid or 240 g of battery acid.
- 1 kg of salt (any cheap kind).
- a 10-20 litre crock or similar non-metallic container, or a plastic bucket
- 7 l water
- A (non-metallic) weight to hold down the skin in the solution

Instructions:

Add the salt to the water. Then tip your container and let the acid dribble down the side into the water. Never add water to acid and be careful not to let it splash, because it is a very dangerous liquid. Stir the solution with a wooden stick. At this point the acid is diluted enough to be quite safe, even if it touches your skin. Keep the temperature as close as possible to 21°C. Higher temperatures can damage the pelts and lower temperatures slow down the tanning process.

Now you are ready to tan, as described above. The aim of the sulphuric acid process is to open the pores of the skin so the alum or chrom can enter the skin.

The tanned pelts can be used to sew dolls, stuffed animals, purses and small bags. The tails and forefeet, if preserved for at least one week in formaline, can be used to make key chains.

Appendix 1: Common diseases of rabbits

Diseases and symptoms	Cause	Treatment and control
Caked mammary glands: Glands become firm and congested, later hard nodules form at sides of nipples. Nodules may break open, showing dried milk.	Milk is not drawn from glands as fast as it is formed, because there are too few young or the young are not nursing sufficiently. Usually a management problem with high milk-producing does.	Do not wean young abruptly. If litter is lost rebreed doe and protect doe from disturbance so young can nurse properly. Correct faulty nest boxes that injure breasts.
Coccidiosis: 8 types in intestine and 1 type in liver. Symptoms: diarrhoea and no weight gain. The animal has a poor condition and is listless. Severe cases have pot belly, diarrhoea with mucus and pneumonia as secondary symptoms.	Parasitic infection of the intestinal tract caused by several coccidiosis Eimeria: Eimeria perforans, E. magna, E. media, E. irrisidua.	Keep floor clean and dry, remove droppings frequently. Prevent faecal contamination of feed and water. Add feed-grade sulfaquinoxaline so that level will be 0.025% of the daily food; feed for 3-4 weeks. Or, preferably, add water soluble sulfaquinoxaline at 0.025% to the drinking water and give 2-3 weeks. Either of these treatments combined with sanitation will greatly reduce numbers of parasites and animals infected. Disinfect the cages with cresol solution to kill the Eimeria.
Conjunctivitis or weepy eye: Inflammation of the eyelids. Discharge may be thin and watery or thick and purulent. Fur around the eye may become wet and matted.	Bacterial infection of the eyelids. Also may be due to irritation from smoke, dust, sprays or fumes.	Early cases may be cleared up with eye ointment, argyrols, yellow oxide of mercury or antibiotics. Apply eye drops made up of 0.5 g of streptomycin to each 2 ml of distilled water. Protect animals from airborne irritants.
Ear mange or ear infection: Shaking of head, scratching of ears, brown scaly crusts at base of both inner ears.	Ear mites: Psoroptes cuniculi (rabbit and goat ear mite) Notoedress cati (cat ear mite).	Use Ivermectin, see prescription for use. Alternative: Pour in each ear some drops of a 5% lime sulphur solution (prepared by diluting commercial 30% lime sulphur concentrate: 1 part to 5 parts of water).

Diseases and symptoms	Cause	Treatment and control
<p>Enteritis, bloat or scours Enterocolitis: Loss of appetite, little activity, eyes dull and squinted, fur rough and animals may appear bloated. Diarrhoea or mucus droppings, animals may grind teeth. Stomach content fluid, gaseous or filled with mucus.</p>	<p>Unknown, E coli and Clostridium infection. Has been shown to be infectious or transmitted to other animals.</p>	<p>Add 150 gram zinc bacitracin to each ton of feed to give final concentration of 150 ppm. Feed intermittently or continuously. Water soluble chlor-tetracycline at a level of 1 gram/litre of water may be used for treating individual cases, but this is too costly for herd control.</p>
<p>Favus or ringworm (fungal infections): Circular patches of scaly skin with red elevated crusts. Usually starts on head and at inside of front legs Fur may break off or fall out.</p>	<p>Fungus: Trichophyton and Microsporum. The infection is contracted from the mother doe through the skin at the mammary gland, which infects the nose and front legs of the young sucklings.</p>	<p>Give Griseofulvin orally at the rate of 20 mg/kg body weight for 14 days. Combine this treatment with dusting nest boxes with industrial fungicidal sulphur. Can also be treated with a brand of hexetidine. Apply to infected area for 7-14 days. Clean the stable with smoke candle Clinafarm (Janssen pharmaceuticals) or with formaline (only when no rabbits are in the cages).</p>
<p>Fur block: Animals reduce feed intake or stop eating completely, fur becomes rough and weight is lost. Stomach filled with undigested fur blocking passage to intestinal tract. Pneumonia may become secondary symptom.</p>	<p>Lack of sufficient fibre, bulk or roughage in the diet. Junior does or developing does are most susceptible.</p>	<p>Increase fibre or roughage in the ration. Feed dry alfalfa or timothy (grass) hay. Give pineapple or pineapple juice to the rabbits to increase the motility of the stomach and intestines.</p>
<p>Heat stress: Rapid respiration, prostration, blood-tinged fluid from nose and mouth. Does that are due to kindle are most susceptible.</p>	<p>Extreme outside temperature. Degree varies with location and humidity.</p>	<p>Reduce temperature with water sprays, foggers (only in dry climate). Place wet burlap in hutch or wet the animal to help reduce body temperature. Place ice or water in the inside of the ear to reduce body temperature of the rabbits.</p>
<p>Malocclusion Weight loss, reduced number of droppings, sticky bottoms, difficulty chewing, salivation, lingual and buccal ulceration.</p>	<p>Lack of chewing material, suboptimal skull shape, vitamin D-deficiency because of a lack of daylight or deficient feeding.</p>	<p>Prevent by feeding hay; do not breed with animals with a suboptimal skull shape; rabbits should be exposed to daylight (but not permanently in full sunlight!).</p>

Diseases and symptoms	Cause	Treatment and control
<p>Mastitis or blue mammary glands: Breasts become feverish and pink, nipples red and dark. Temperature above normal, appetite poor, breasts turn black and purplish.</p>	<p>Bacterial infection of the breasts: Staphylococcus aureus or Pasteurella multocida infection.</p>	<p>Inject oxytetracycline or draxxin intramuscular once a day for 3-5 days. Do NOT use penicilline or lincospectin or amoxycilline, which are very toxic for rabbits. Disinfect hutch and reduce feed concentrates. If the case is severe, destroy the animal. NEVER transfer young from infected doe to another doe.</p>
<p>Metritis or white discharge: White sticky discharge from female organs, often confused with sediment in urine. Enlarged uterus detected on palpitation, or both uteri filled with white purulent material.</p>	<p>Infection of the uterus by a variety of bacteria, mostly Staphylococcus or Pasteurella.</p>	<p>Dispose of infected animals and disinfect hutches. Infected area difficult to medicate. When both uteri are infected animal is sterile.</p>
<p>Myxomatosis Nasal and ocular discharge, oedematous swellings around the eyes, base of the ears and genitals, purulent blepharo-conjunctivitis which progresses to blindness, acute haemorrhagic pneumonia, often secondary pasteurellosis, usually fatal</p>	<p>Myxoma Pox virus, transmitted by fleas and mosquitoes or by direct contact between rabbits or by the veterinarian during vaccination.</p>	<p>Reduce mosquito population, dispose of infected animals, vaccinate with Iyomyxovax or dervaximyxo SG33.</p>
<p>Paralysed hindquarters: Mainly found in mature does because of weight during pregnancy. Hind legs drag, cannot support weight of pelvis or stand. Urinary bladder fills but doesn't empty.</p>	<p>The bones of rabbits are very thin so injury can result in a broken back, displaced discs, damage to spinal cord or nerves. Can be Encephalotizoon cuniculi infection.</p>	<p>Protect animals from disturbing factors, predators, night prowlers and visitors or noises that startle animals, especially pregnant does. Give Panacur 2,5 % in the mouth for several weeks to kill the Encephalotizoon. Clean the stable and cages to get rid of the spores.</p>
<p>Pasteurellosis: May be an acute or chronic infection. Nasal discharge, watery eyes, weight loss or mortality without symptoms. Inflammation of lungs, inflammation of bronchi and nasal sinuses.</p>	<p>Bacterial infection: Pasteurella multocida.</p>	<p>Individual animals may be treated with an injection of oxytetracycline or enrofloxacin or streptomycin. Give intramuscularly 1 ml for fryer size, 2 ml for mature. Repeat on third day. For herd control, add feed-grade sulfaquinoxaline at level of 0.025% to food; feed for 3-4 weeks. Save replacement stock from clean animals and cull out chronically infected animals. Use good sanitary measures to reduce transmission to new animals.</p>

Diseases and symptoms	Cause	Treatment and control
Pinworms: No specific symptoms in live animals. White thread-like worms found in cecum and large intestine cause slight local irritation.	Pinworms: <i>Passalurus ambiguus</i> .	Give panacur (fenbendazole) orally. Infection not considered one of economic importance but can cause severe condition loss and secondary infection.
Pneumonia: Laboured breathing with nose held high, bluish colour to eyes and ears. Lungs show congestion, red, mottled, moist, may be filled with pus. Often secondary symptom of enteritis.	Bacterial infection of the lungs. Organisms involved may be: <i>Pasteurella multocida</i> , <i>Bordetella bronchiseptica</i> , <i>Staphylococcus aureus</i> .	For control in herds add feed-grade sulfaquinoxaline so that level will be 0.025% of the daily food; feed for 3-4 weeks. Water soluble sulfaquinoxaline can be added at a level of 0.025% to the drinking water and given for 2-3 weeks. If the treatment is started early, it is effective.
Pseudo-tuberculosis Chronic infection, dull coat, diarrhoea, anorexia, small abscesses with caseous necrosis found in liver, kidneys, spleen, lungs and intestines	Bacterial infection with <i>Yersinia pseudo-tuberculosis</i> , transmitted with rabbit faeces.	Dispose of very sick animals and disinfect hutches.
Skin mange: Reddened scaly skin, intense itching and scratching, some loss of fur.	Mites: <i>Cheyletiella parasitivorax</i> (rabbit fur mite) and <i>Sarcoptes scabiei</i> (scabies or itch mite)	Use Ivermectin, see prescription. Alternative: Dip entire animal in a 1.75% lime sulphur bath (prepared by diluting commercial 30% lime sulphur concentrate, laundry detergent: 1 tablespoonful per 3 litre tepid water). Repeat in 2 weeks if necessary. Rubber gloves advisable.
Sniffles or cold: Sneezing, rubbing nose; nasal discharge may be thick or thin. Matted fur on inside of front feet. May develop into pneumonia. Usually chronic type of infection.	Bacterial infection of nasal sinuses: <i>Pasteurella multocida</i> or <i>Bordetella bronchiseptica</i> .	Individual animals may be treated with a 0.5 g streptomycin to each 2 ml. Inject intramuscularly 1 ml for fryer size, 2 ml for mature. Repeat on third day.
Sore hocks: Bruised, infected or abscessed areas on hocks. May be found on front feet in severe cases. Animal shifts weight to front feet to relieve hocks.	Bruised or chafed areas become infected. Caused by wet floors, irritation from wire or nervous 'stompers'.	Small lesions may be helped by placing animal on lath platform or on ground. Animals with advanced infections are best killed. Medication is temporarily effective.

Diseases and symptoms	Cause	Treatment and control
Spirochetosis or vent disease: Similar lesions as produced by urine or hutch burn. Raw lesions or scabs appear on sex organs, transmitted by mating.	Spirochete: Treponema cuniculi.	Do not breed until lesions heal. If only a few animals are infected, it is easier to kill those animals than to treat the disease. Do not lend out bucks.
Tapeworm larvae: White streaks in liver or small white cysts attached to membrane on stomach or intestines. Usually cannot be detected in live animals.	Larval stage of dog tapeworm: Taenia pisiformis, or of cat tapeworm: T.aenia eformis	Keep dogs and cats away from feed, water and nest box material. Eggs of tapeworm occur in droppings of dogs and cats. Treat with praziquantel orally or by injection (drontal).
Urine or hutch burn: Inflammation of external sex organs and anus. Area may form crusts and bleed and, if severely infected, pus will be produced.	Bacterial infection of the membranes.	Keep hutch floors clean and dry. Pay particular attention to corners where animals urinate. Daily applications of lanolin may be beneficial.
Viral Hemorrhagic Disease (VHD / RHD) Rabbit is over six weeks of age, anorexia, lethargy dyspnoea 2-3 days post-infection, convulsions, bleeding from the nose, sometimes vocalization.	Calicivirus is present in saliva and nasal secretions of infected animals and can be spread by direct and indirect contact. The virus can survive up to 3 months in the environment; transmission takes place via birds, aerosols, rodents	Vaccination, clean cages with 50% potassium peroxomonosulphate, 5% sulphamic acid and 15% sodium alkyl benzene sulphonate (effective against calicivirus). Insects, rodents, birds and other animals should be kept away from the rabbits' environment.
Warbles or Myiasis lesions and raised area of skin. Rabbits are restless. Skin becomes moist. Sometimes visible larvae. Flies lay their eggs at the base of the spine between the dorsum and tail.	Fly larvae.	Remove all maggots from the wounds under the tail. Insert solution of insecticide (Phoxim) or even soap with syringe without needle in the boreholes of the larvae. After the larvae are removed clean with antiseptic like Iodine. Keep animals and hutches clean and dry. Try to keep flies away from the hutches for example with mosquito netting or UV-electrocution grids.
Wry neck: Head twisted to one side. Animals roll over, cannot maintain equilibrium.	Infection of the organs of balance in the inner ear. May be parasitic or bacterial. Caused by Encephalotizoon cuniculi.	Eliminate infected animal from herd. Some cases result from nest box injuries. Give panacur orally.

Appendix 2 Administration

Doe record card									
Breed: <i>New Zealand White</i>					Cage number: 6				
Date of birth: <i>02-06-....</i>					Father: 144				
Ear number: 7					Mother: 126				
Date of service	Buck	Palpation	Date of birth	Born		Weaned			Remarks
				Alive	Dead	Number	Date	Av. Weight	
<i>28-Oct</i>	8	<i>11-Nov</i>	<i>28-Nov</i>	7	2	7	<i>3-Jan</i>	900	
<i>9-Dec</i>	9	<i>27-Dec</i>	<i>8-Jan</i>	9		9	<i>13-Feb</i>	844	
<i>2-Feb</i>	9								
<i>20-Feb</i>	27	<i>5-Mar</i>	<i>22-Mar</i>	11		9	<i>26-Apr</i>	756	
<i>1-May</i>	27		<i>3-Jun</i>	4	3	4	<i>11-Jul</i>	500	
<i>6-Jul</i>	4		<i>7-Aug</i>	7	1	6	<i>18-Sep</i>	1321	

Buck record card							
Breed: <i>New Zealand White</i>				Cage number: 4			
Date of birth: <i>18-6-....</i>				Father: 6035			
Ear number: 27				Mother: 186			
Service number	Doe number	Date of service	Born		Litters born (cumulative)	Kindles born (cumulative)	Remarks
			Alive	Dead			
<i>1</i>	11	<i>5-Feb</i>	7	1	1	8	
<i>2</i>	2	<i>13-Feb</i>	0	0	1	8	
<i>3</i>	21	<i>20-Feb</i>	3	1	2	12	
<i>4</i>	7	<i>20-Feb</i>	11	0	3	23	
<i>5</i>	13	<i>29-Feb</i>	6	0	4	29	
<i>6</i>	15	<i>29-Feb</i>	5	1	5	35	
<i>7</i>	19	<i>4-Mar</i>	2	5	6	42	
<i>8</i>	41	<i>4-Mar</i>	7	0	7	49	

Figure 32: Example of record card of does and bucks

Further reading

Adjare, S.O., **Try the rabbit: a practical guide**. CTA, pp.54. ISBN: 92-9081-1080

Allen, T., **Housing, husbandry and welfare of rabbits**, January 1979-January 1994. Quik bibliography series, 1994, pp. 45, National Agricultural Library (NAL), Beltsville: USA. ISBN: 1052-5378-94-16.

Blas, C.de ; Wiseman, J., **The nutrition of the rabbit**. 1998, pp. 344, CAB International, Wallingford. ISBN: 085199279X.

FAO. **Raising Rabbits**.1990. Better Farming series.

Part I: **Learning about rabbits, building the pens, choosing rabbits**

Part II: **Feeding, raising baby rabbits, further improvement**.

Fenner, F.J. ; Fanitini, B. **Biological control of vertebrate pests: the history of myxomatosis, an experiment in evolution**. 1999, pp. 339, CABI publishers, New York, USA. ISBN: 851993230.

Fielding, D.; Matheron, G., **Rabbits**. 1991, pp. 106, CTA, Wageningen, The Netherlands. ISBN: 0-333-52311-3.

Fielding, D. **Rabbits**. 1991. MacMillan/CTA. London. Series: "The Tropical Agriculturalist".

Rommers, J.M., **Strategies for rearing of rabbit does**. 2003, Department of Animal Sciences, WUR, Wageningen, The Netherlands. ISBN: 90-5808-934-7.

Sandford, J.C., **The domestic rabbit**. 1996, pp. 278, Black-well Science, Oxford, UK. ISBN: 0-632-03894-2.

Useful addresses

ILEIA

ILEIA, the Centre for Information on Low External Input and Sustainable Agriculture promotes exchange of information for small scale farmers in the South through identifying promising technologies involving no or only marginal external inputs, but building on local knowledge and traditional technologies and the involvement of the farmers themselves in development. Information about these technologies is exchanged mainly through the LEISA Magazine. All articles accessible on-line.

Contact: ILEIA, Zuidsingel 16, 3811 HA Amersfoort, The Netherlands
T: +31(0)33-4673870, F: +31(0)33-4632410

E: ileia@ileia.nl, W: www.leisa.info

International Livestock and Research Institute (ILRI)

The International Livestock Research Institute (ILRI) works at the crossroads of livestock and poverty, bringing high-quality science and capacity-building to bear on poverty reduction and sustainable development for poor livestock keepers and their communities. ILRI works in the tropical developing regions of Africa, Asia and Latin America and the Caribbean. Addresses can be found at: www.ilri.cgiar.org

PTC⁺

PTC⁺ is an international training institute that focuses on all the links in the production chain, plant and animal commodities, (agricultural) technology, (food) technology and natural areas. Training programmes are practice-oriented and mix theory with practical classes. PTC⁺ offers open entry programmes, tailor-made programmes and consultancy. Programmes are offered in the Netherlands and/or on location. It is the policy of PTC⁺ to search for partnerships and co-operation programmes with national and international institutions abroad.

Contact: PTC⁺, Postbus 64, 3770 AB Barneveld, the Netherlands
T: +31(0)342 - 40 65 00, F: +31(0)342 - 40 69 69

W: www.ptcplus.com, E: info@ptcplus.com

Animal Science Group of WUR

Zodiac; is the Animal science of the Wageningen University and Research centre. The core-business of the group is scientific education and research in the area of animal sciences. The group aims to contribute to sustainable animal husbandry, aquaculture and fisheries.

Marijkeweg 40, 6700 PG, Wageningen,

Telephone: +31 317 483952; Fax: +31 317 483962

E: info@animalsciences.nl ; W: <http://www.zod.wau.nl>

CABI, Commonwealth Agricultural Bureaux

P.O.Box 633, Icraft complex, Nairobi, Kenya

E-mail: cabi-arc@cabi.org; web-site: www.cabi.org

DIO Diergeneeskunde in Ontwikkelingssamenwerking

(DIO, Veterinary Medicine in Development Co-operation)

DIO Foundation is a non-profit organisation whose objectives include giving support and advice in the field of animal health and production to individuals and organisations in developing countries: healthy animals, healthy people. A participant in the Vétérinaires sans Frontières-Europa-network, DIO specialises in answering questions in the field of veterinary medicine, through the Veterinary Information Service.

Yalelaan 17, 3584 CL, De Uithof, The Netherlands

E: dio@dio.nl ; W: www.dio.nl

Practical Action (former Intermediate Technology Development Group-ITDG)

Practical Action helps people to use technology in the fight against poverty. Keywords are: 'practical answers to poverty, sustainable solutions and people focused'. Addresses of offices can be found at the website: www.practicalaction.org

World Rabbit Science Association (WRSA)

For information about the WRSA and its activities, please contact the WRSA General Secretary Dr. François LEBAS, 87A Chemin de Lasserre, 31450 CORRON SAC – France, E: lebas@cuniculture.info

W: <http://world-rabbit-science.com/>

Glossary

Abdomen:	Belly
Bloat:	Intestinal gas that cannot escape causing the animal to 'blow up'
Buck:	Male rabbit (also: male goat)
Cages:	Individual housing units that are situated inside a house or stable
Coccidiosis:	Intestinal parasites which occur quite frequently but cannot be seen without a microscope
Concentrates:	High-quality feed, like grains, tubers or mixed meals
Caecotrophy:	Eating the droppings originating from the caecum
Coprophagy:	Eating droppings in general
Doe:	Female rabbit
Drenching:	Giving medicine to the animal by pouring it down its throat
Fodder:	Green roughages used as feed
Gestation:	Pregnancy
Hocks:	'Heels' of the rabbit's hind legs. 'Sore hocks' is a disease that may also affect the paws.
Hutch:	An individual house/housing unit that can be placed on its own at any proper location inside or outside
Inbreeding:	The mating of close relatives (e.g. father and daughter, mother and son, etc). Inbreeding may result in abnormalities such as reduced litter sizes, weak young, deformed animals
Kindle:	Young rabbit
Kindling:	Giving birth to young
Lactation:	Period of time in which the doe produces milk for her young
Litter:	All the young animals produced in one gestation
Palpation:	Examination of doe to check for pregnancy

Pelt:	Skin of the rabbit
Pseudo-pregnancy:	If the buck has mated with the doe but the doe has not become pregnant, she will sometimes make a nest after 14-18 days after mating, without really having a litter
Reproduction:	The ability of a male and female animal to produce young
Roughage:	Grass, leaves, other greens, also hay and straw
Scabies:	Mange, a small mite causing the skin to become flaky and crusty
Stable:	Building containing many cages
Stress:	A condition in which the animal is under pressure from many negative factors. In this situation diseases can easily attack the animal.
Sulfa:	A name used for a whole group of medicines containing sulphur in one way or another, similar to antibiotics
Tanning:	Processing the skin, including or excluding the fur, to make leather from it
Trough:	Feeder for roughages
Weaning:	The act of separating the young from their mother permanently; stopping them from drinking their mother's milk