

# INTERMEDIATE REPORT

## Vietnam case

### **EXPLORING THE RELEVANCE AND FEASIBILITY OF PES APPROACHES FOR PRODUCING ENVIRONMENTAL SERVICES THROUGH CHANGES IN AGRICULTURAL PRACTICES: A CASE STUDY IN THE MEKONG REGION**

*Contract C-056-07, CPWF theme 2 (Challenge Program for Water and Food)*



Orange D., Nguyen Duy Phuong, Loiseau J.B., Bui Tan Yen,  
Henry des Tureaux T., Bardouin L., Rodriguez C., Bertrand J., Grandidier  
E., Jouquet P. and Tran Duc Toan

*Hanoi, July 2008*

# INTRODUCTION

In Vietnam, the soil erosion linked to the agricultural practices is a problem especially serious because of many factors as steep topography, fragile soils, climate change and human pressure due to both strong demographic increase and huge economic development. In the mountainous area in Northern Vietnam, agricultural productivity has already been decreasing due to erosion of fertile soil. Today, in order to confront the problem of soil fertility loss and the need of rural development, the farmers under the pressure of the agricultural policy choose to diversify their activities and notably to develop cattle husbandry.

In this context of severe agricultural intensification, soil erosion has become a major economic and environmental problem. It has affected the livelihoods of smallholders, has increased soil degradation and has hindered the long-term development of these mountainous areas. Many different organisations have responded to this by working on the development and promotion of better soil management practices, aiming at higher yields and reduction of rural poverty without concrete farmers' involvement leading to a limited technical adoption. Indeed, research studies (i.e. MSEC program) have shown that the promotion of a new practice, as a major factor towards change, needs to be complemented by other factors, such as access to external markets or better wellbeing, which would contribute to achieving higher incomes (**Orange et al., 2008**). In addition, policies and regulations have proved to have a further positive impact on the adoption of a given technique.

In this term, the concept of environmental services (ES) and their role in providing significant public goods is increasingly gaining recognition in Vietnam. **The final objective of the present study is: to assess whether environmental sustainability is socially acceptable and valued by communities in order to elicit payment for these services.** The objective is to explore the potential use of the PES concept (Payment for Environmental Services), in its broadest sense, as an **environmental management tool** to lead upland landholders to reduce the occurrence and impact of agricultural practices within sloping lands on soil erosion processes, soil fertility decrease and water pollution through in-site and off-site effects.

This intermediate report presents the one-year on-going research activities conducted in Vietnam by the MSEC team. As planned (cf. annex 1), the research activities have been divided on two workgroups:

- WG1: Hydrological modeling for PES concept
- WG2: Farmers' demand and PES modalities

The present report describes the main results from these two workgroups. Some extensive versions of scientific results are presented in annex. At last, two papers have been published concerning this PES study:

- Orange D., Tran Duc Toan, Nguyen Duy Phuong, Nguyen Van Thiet, Salgado, Clement F., Le Hoa Binh (2008). Different interests, common concerns and shared benefits. *LEISA Journal*, 24(2): 12-13.
- Orange D., Bardouin L., Nguyen Duy Phuong, Loiseau J-B., Clement F., Jouquet P. (2007). Le concept de PES pour une gestion durable des eaux et des sols : application au développement de l'élevage et au contrôle environnemental dans le Nord Vietnam. In Orange D., Roose E., Vermande P., Gastellu J.-P., Pham Quang Ha (Eds) : Gestion intégrée des eaux et des sols : ressources, aménagements et risques en milieux ruraux et urbains, *Proceedings Ed. AUF and Ed. IRD*, Paris, *Actes des Premières Journées Scientifiques Inter-Réseaux de l'AUF*, Hanoi, 6-9 novembre 2007, cd-rom : 8p. (Communication orale).

# BACKGROUND ON NORTHERN VIETNAM AND PES

## *INSTITUTIONAL CONTEXT*

This work was part of an international research programme called MSEC (*Management of Soil Erosion Consortium*) for his part occurring in Northern Vietnam. Its objectives were to promote sustainable land management systems, evaluate the biophysical, environmental and socio-economic effects of soil erosion, and to generate reliable information for the improvement of local policies and regulations, in the uplands of Northern Vietnam. After a four year assessment, working with around 50 small scale farmers in the commune of Tien Xuan (approximately 50 km west of the capital Hanoi), this study highlighted that local factors can be far more important than national policies in determining change. These results provided the basis for an integrated crop-livestock project carried out by the Vietnamese Soils and Fertilizers Research Institute (SFRI) in Vietnam and Laos, in collaboration with the National Institute of Animal Husbandry (NIAH) in Vietnam and the National Agriculture and Forestry Research Institute (NAFRI) in Laos. In addition, two international research centres were involved, IRD (French Institute of Research for Development) and CIRAD (French Agricultural Research Centre for International Development). The aim was **to support farmers in their efforts to reduce poverty and enhance environmental sustainability in mountainous areas by promoting new technologies that build on existing knowledge and farming practices.**

The research focused on the integration of animal husbandry into the traditional agricultural farming systems in the region, which are based on cassava production and forestry in the uplands, and rice cultivation in the lowlands. A discussion process between farmers, local decision-makers and scientists helped define the activities, to ensure all their goals would be met. In Vietnam, improved management of soil fertility in rice- and cassava-based systems, and simultaneously cultivating fodder grass on steep slopes matched both the farmers' and scientists' interests. The plan was to produce sufficient animal feed during the cold winter season and the warm rainy season, while at the same time decreasing soil erosion. The project's activities, from 2005 to 2008, included:

- testing fodder species for sloping lands on experimental plots and demonstration sites, considering temperate grasses and legumes (such as *Avena strigosa* or *Medicago sativa*) and also tropical species (*Panicum maximum*, *Brachiaria* sp., *Paspalum atratum* or *Stylosanthes* sp.). The main purpose was to secure the production of cattle feed, (especially in winter), and also to select the best species for soil conservation during the rainy season;
- setting up demonstration sites, focused on soil and nutrient management when growing cassava (on upland plots) and paddy rice (in the lowland areas). The aim was to show how well balanced fertility management can improve crop yields without increasing the use of external inputs.

## *WHY PES CONCEPT IN NORTHERN VIETNAM?*

Soil erosion in highly incised watersheds of North Vietnam has negative impacts on both upstream and downstream communities. Increased sediment discharged from these catchments reflects a loss of fertile topsoil that farmers depend upon for the production of crops and fodder. In addition, increased sediment loads in streams and rivers have a direct negative impact on water quality and the longevity of water storage structures, both of which have significant economic implications (Orange et al., 2007a).

Soil erosion comes about because of both human activity, such as erosive farming practices, and biophysical factors, including intense rainfalls on sloping land. In Vietnam, increasing population densities has encouraged agricultural production to shift from the rich-soil lowlands to the degradation-prone marginal uplands. In this context of severe agricultural intensification, soil erosion has become a major economic and environmental problem. It has affected the livelihoods of smallholders and has hindered the long-term development of these areas **(Orange et al., 2008)**.

It is well recognized that non-appropriated utilization of land resources in upper catchments results in enhanced erosion processes on sloping lands leading to increase nutrient loss and a decrease in soil fertility, especially in the mountainous area of Northern Vietnam since soils are acidic and sensitive to erosion due to poor cover. For more than 20 years, the observed effect is more unsustainable agricultural system within the sloping lands leading to larger sediment discharge and elevated nutrient loads being discharged into the water bodies and the paddy fields in the down part (picture 1). The huge off-site risk is to reduce water quality to downstream users that can have significant health implications, the storage capacity of reservoirs and to unfertilized the paddy fields **(Tran Duc Toan et al., 2003)**.



**Picture 1:** Land-use through to the top of the hills and erosion contribution to the paddy fields and the water bodies. (Northern Vietnam, June 2008, D. Orange)

The main conclusions generated from the *Management of Soil Erosion Consortium* (MSEC, research program from IWMI-IRD) over the last five years from 27 catchments in five countries (Indonesia, Laos, Philippines, Thailand and Vietnam) were **(Valentin et al., 2008)**:

- (i) soil erosion is predominantly influenced by land use rather than environmental characteristics not only at the plot scale but also at the catchment scale;
- (ii) slash and burn shifting cultivation with sufficiently long rotations (one year of cultivation, eight years of fallow) is too often unjustly blamed for degradation;
- (iii) in its place, continuous cropping of maize and cassava promotes high rates of soil erosion at the catchment scale;
- (iv) conservation technologies are efficient in reducing runoff and total sediment yield at the catchment scale;
- (v) the adoption of improved soil management technologies by upland farmers is not a function of the degree of intensification of their farming system and/or of their incomes;
- (vi) a failure to adopt appropriate land use management strategies will result in further rapid resource degradation with negative impacts to downstream communities.

A key outcome from previous research activities has been a need to focus on water quality issues at a larger scale and the importance of empowering communities in taking effective action. The current failure between state and market mechanisms to promote sustainable and equitable natural resource management in developing countries is mainly due to attaining a balance between the rights of society and the rights of the individual. Key factors that influence the development of individual and community based initiatives that address some of these imbalances are (**Noble et al., 2006**): (1) leadership, (2) quick and tangible outcomes, (3) supportive policy, (4) social capital, (5) a participatory approach with respect to the implementation of the project, and (6) innovation and appropriate technology.

Our previous collaborative research undertaken within IWMI *Asialand Sloping Land Management (ASL)*, the *Management of Soil Erosion Consortium (MSEC)* and the *DURAS-CropLivestock* projects have focused on elucidating the processes associated with soil erosion and land and water management in highly incised catchments within Southeast Asia. A key outcome from these research activities was a need to focus on water quality issues at a larger scale and the importance of empowerment of communities in taking effective action (**Clement et al., 2007**).

Getting farmers to adopt new technologies to address soil erosion and fertility problems is not easy. In Vietnam, a multidisciplinary research project to improve soil management in traditional mountainous agricultural farming systems managed to attract farmers' interest and stop soil erosion. This success stems from encouraging farmers, extensionists and researchers to jointly define and implement the project. Their different aims could be followed simultaneously: scientific results for researchers, better agricultural practice for extension workers, and economic success and free choice for farmers (**Orange et al., 2008**).

Recent studies on governance, poverty and environmental sustainability in Northern Vietnam have emphasized a "rights-based" approach, in which equitable development is strongly associated with individual and communal rights (Castella *et al.*, 2002; **Clement et al., 2007**). The current failure between state and market mechanisms to promote sustainable and equitable natural resource management in developing countries is mainly due to the balance between the rights of society and the rights of the individual (Li, 2002; **Clement et al., 2008**).

Sustainable land use practices are now relatively well known and include forest plantation, agro-forestry systems, tree-based land use alternatives and agro-ecologically sound practices such as conservation agriculture (Baier and Dumanski, 1991; **Valentin et al., 1991**; Geay and Dao The Tuan, 2000; Cramb, 2005; **Orange et al., 2007a**). Although these systems would provide long term benefits to potential adopters, they often do not provide sufficient immediate economic returns to

resource-constraint farmers, i.e. quick and tangible returns on investments (Affholder *et al.*, in press). Often the benefits associated with the adoption of new and improved approaches to land management are not evident for 3-5 years. Further, the environmental services of these land use options provide, i.e. erosion control, watershed services, biodiversity conservation and carbon storage are usually not rewarded and only indirectly connected to economic activities. As a result, adoption of improved land and water management systems has to date been low (**Orange et al., 2008**).

***Payments for Environmental Services (PES) or other incentive mechanisms present a new approach that focuses directly on creating a conditional benefit transfer between providers of the environmental services and the beneficiaries of these services.*** PES schemes are based on the principles that those who benefit from environmental services should pay for them, and that those who contribute to generating these services should be compensated for providing them. Hence, the approach seeks to create mechanisms that internalize what would otherwise be an externality (Pagiola and Platais, 2002; Tomich *et al.*, 2004). Such schemes can take advantage of upland-lowland interactions in generating environmental benefits while improving the livelihoods of upper-catchment agricultural households. As such, PES is also increasingly seen as an opportunity for poverty reduction and the enhancement of sustainable development within integrated natural resource management approaches (Asquith *et al.*, 2002; Pagiola *et al.*, 2005; Minang *et al.*, 2007).

The past few years have witnessed a surge in interest in the development of PES schemes in Asia. In Vietnam, while some projects using the conceptual framework of PES are being initiated in the Central and Southern part of the country (e.g. WWF, 2007) and are associated with the protection of native forests or the establishment of production forests, no PES schemes are currently being implemented in the upper catchment areas of Northern Vietnam that specifically address sustainable agronomic production systems. However, the Vietnamese Government expressed recently its interest in starting such a scheme to protect fragile upper-catchments from degradation and to enhance the livelihoods of communities (Dang Kim Son, 2008; Vu Tan Phuong, 2008).

**A key factor shown to directly influence farmer decisions in adopting more sustainable approaches in soil and water management was quick and tangible outcomes upon adoption.**

**Conclusion 1:**

**In Northern Vietnam, soil and water resources tend to be used unsustainably, partly due to the lack of good soil in lowlands and moreover due to the lack of knowledge on the environmental sustainability. In the Vietnamese context, there is considerable evidence to suggest that more effective land management practices can be promoted in the uplands. In this relative favorable context, payment for environmental services (PES) is seen as an efficient way to potentially: (i) cover the cost of these practices; (ii) promote a dialog between upland farmers, lowland farmers and the local stakeholders in order to target environment services that are economically realistic as well as environmentally, socially and culturally acceptable.**

# CASE STUDY IN NORTHERN VIETNAM

## *PRINCIPLES*

Because the current upland management practices should be detrimental to water use for agricultural and domestic purpose downstream and possibly confer other off-site impacts. Because upland agricultural practices on sloping lands should be not sustainable and economic for the uplanders. Because agricultural and other uses of water downstream should be adversely affected by the negative externalities generated from upland uses that have apparently evolved to tackle the livelihood needs of upland farmers. **The assumption of our study is that the uplanders should be compensated for making changes in land management by those who stand to benefit downstream.** Compensation mechanisms suited to local contexts may encourage better upland management and this will generate a net overall benefit to the communities participating (both upland and lowland) in a mutual respect.

**The working hypotheses of the intended research area are stated as follows:**

- 1. Soil conservation practices are seldom adopted because they are not supported or paid for at their real cost;**
- 2. Willingness to pay for soil conservation practices is low because neither the cost of soil erosion, nor the benefits of conservation practices are quantified on the basis of reliable facts, and the benefits of adopting soil conservation practices are not seen in the short term and may initially reduce agricultural output;**
- 3. Water and soil erosion models can be used to quantify the positive effects of conservation scenarios and evaluate the trade-offs so that policy makers can make informed decisions.**

**An exploratory case study is clearly justified, given the lack of information in this area and the need for community awareness.**

A stage by stage implementation is proposed where limited number of sites are initially assessed with respect to recognized PES criteria (e.g. well defined service, value to beneficiaries, cause-effect understanding of the management change and the impact on the environmental service, effective institutional processes, the poor benefit etc.). Initial assessments consider PES options, land users' perceptions regarding benefits/costs associated with different land use options, existing local mechanisms (cash-based or based on other forms of exchanges) for encouraging the production of environmental services and presence or absence of enabling conditions etc. This initial scoping phase has been completed. Activities are now focused on pilot testing of suitable PES mechanisms, qualitative evaluation of benefits and costs from proposed changes in land uses, identifying cause-effect relationships, empirical field observation of local processes, and developing enabling conditions for successful implementation of PES schemes that may be developed.

Logical path is to identify site then services and then the appropriate scale of analysis. That said, the preference is to start with examples that are reasonably local (small scale) as this is more tractable initially in terms of social complexity and the likelihood of achieving robust cause-effect analysis. Smaller scales will help to understand local reciprocal arrangements better due to clearer 'cause-effect' relationship and the better possibilities for entering into incentive mechanism as the effects considered are localized. Depending on the extent of off-site impacts, the scale could be expanded later.

## *RESEARCH ASSUMPTIONS*

**The main goal** of the Vietnam case study is to undertake a preliminary survey of the actual development of PES concept in an experimental site well biophysical studied from more than 5 years, and well introduced within the uplanders' strategies. The study will address negative externalities where the PES concept may provide a framework devoted to reduce them.

**So the specific objectives** should be as follows:

- 1. Identify a range of possible ES facing the development of economic and sustainable agro-ecological intensification systems that will allow sustainable and environmental utilization of uplands by smallholder farmers;**
- 2. Define cost-effective alternative upland use practices able to provide such ES;**
- 3. Define the value of the ES benefits to the lowland stakeholders;**
- 4. Identify a range of possible ES that lowland stakeholders might be willing to trade from upland landholders;**
- 5. Identify a range of indicators from various scenarios forced by climate change, land use change, based on modelling platform;**
- 6. Assess the possibility of the selected ES to be implemented in the future (what the upland farmers should be compensated for and how).**

## *EXPERIMENTAL SITE IN NORTHERN VIETNAM: TIEN XUAN COMMUNE*

The activities of MSEC in Vietnam are focused in Tien Xuan Commune located in Luong Son District, Hoa Binh Province, at 60 km westward of Hanoi. Seventeen villages constitute the Tien Xuan Commune, the principal of which are Dong Dau, Que Vai and Dong Cao, where research fieldwork has been conducted from 2000 (*see figure 1*).

They have traditionally cultivated irrigated rice in the lowlands and maize or cassava in the uplands with slopes between 40% to over 100%. From the 90's, because the decreasing of soil fertility within the uplands, they shift their upland crops to the forestation associated less and less with cassava. They have relied also on small animal husbandry as pigs and chickens as a means of living. Non-farm based employment has also increased over the last few years, especially construction work (*see Clement et al., 2007*).

The reasons for upland land use change are complex. Some farmers had the opportunity to sell their land whilst others under a policy directive planted trees or have practiced improved fallows. There has been a dramatic change in the extent of cassava production in the catchment with the total area declining from 40% of the watershed area in 2001 to less than 0.5% in 2004. With this decline in area under crops, the opportunity has arisen to introduce a livestock component into the catchment. Over the past 4 years, the impact of the fodder species (*Bracharia ruziziensis*) established under a no till regime has been evaluated with respect to its ability to reduce erosion from these slopes. After 5 years of continuous erosion monitoring (from 2001 to 2005), the erosion rates measured in Dong Cao experimental watershed have confirmed that land clearing generates the highest soil loss amount, and that forest and fodder cover effectively eliminated erosion one year after establishment. The evaluation of fodder crops as an alternative to annual crops such as cassava has stimulated an interest in improved livestock production based on the introduction of adapted pasture species by farmers from the surrounding villages. They view this approach as having a quicker and larger return on investment than the establishment of plantation forests.



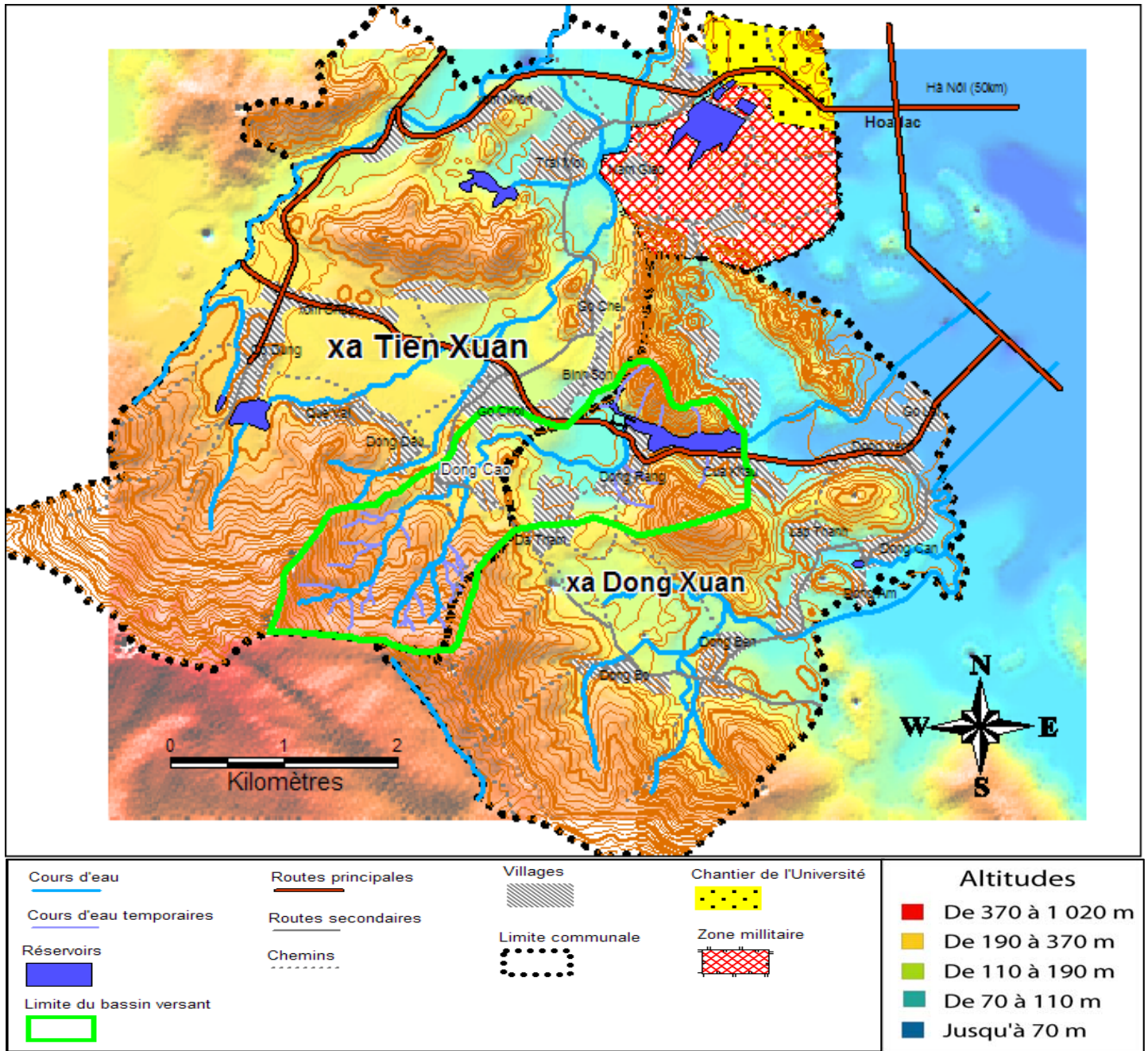
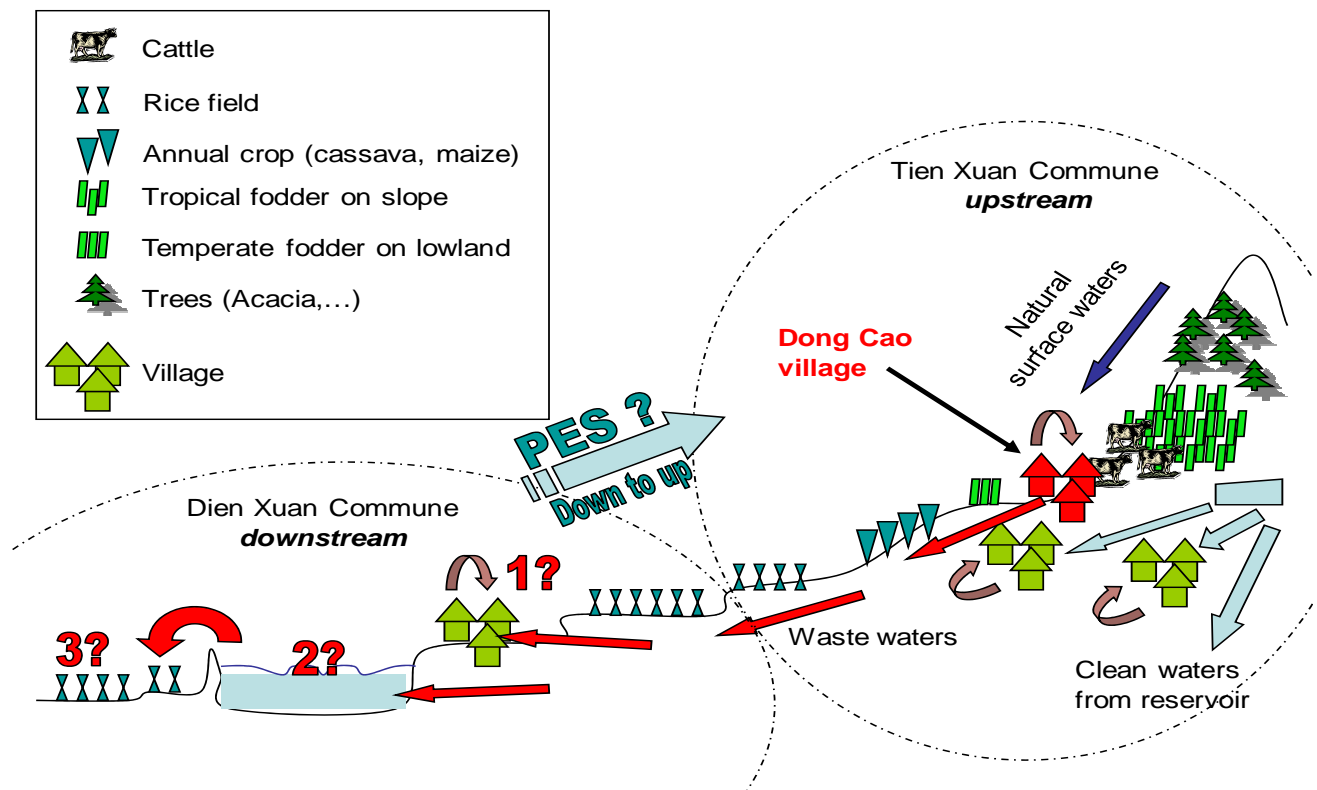

**Figure 1** : Topographic map of Tien Xuan and Dong Xuan Communes (with the hydrological limits of the experimental PES watershed in green line)

But the counterpart of the rising of number of cows is the increase of gully erosion and the water pollution by nitrogen, which could impact directly the downward water bodies of the other villages (see figure 2).

So the technical-scientific challenge could be effectively closing to the erosion process control in the uplands and the nutrient cycle loop in a manner that enhances production, incomes and environment, by ecological engineering addressing to 4 targets:

- target 1: enhance the crop yield on the uplands;
- target 2: control the water pollution and sedimentation into the lowlands;
- target 3: enhance the well-being by impact on the human health;
- target 4: enhance the well-being by economical development.



**Figure 2 :** Which economic and sustainable agro-ecological intensification systems that will allow sustainable and environmental utilization of soils and waters in the uplands and lowlands by smallholders?

**Conclusion 2:**

The purpose of the project in Vietnam is to evaluate whether PES could be an efficient alternative to the existing regulations, with respect to protecting downstream water quality (issue 1 on the Figure 2) and from siltation (issue 2 on Figure 2), assuring sufficient water quantity for irrigation downstream (issue 3 on Figure 2) and promoting the enhancement of cattle husbandry using cowsheds and associated fodder crops for sustainable agricultural practices.

## *METHODOLOGY*

In order to tackle the 6 specific objectives underlined as driven-force for a PES framework, the research activities have been divided in 4 tasks distributed in two working groups:

- WG1: Hydrological modeling for PES concept
- WG2: Farmers' demand and PES modalities

The four tasks are detailed in the following part:

- **Task 1: Identification of the ES**, this task tackles the specific objective 1 to define a range of possible ES facing the development of economic and sustainable agro-ecological intensification systems that will allow sustainable and environmental utilization of uplands by smallholder farmers;
- **Task 2: Effective cost for uplanders**, this task tackles the specific objective 2 to calculate the cost-effective of the alternative upland use practices able to provide such ES;
- **Task 3: Erosion and runoff modeling within uplands**, this task participates to the specific objective 5 by modelling the erosion processes on sloping lands (development of PLER model);
- **Task 4: Modeling and ES scenarios**, this task tackles a part of the specific objective 5 to identify a range of indicators from various scenarios forced by climate change, land use change, based on modelling platform;

## TASK 1: IDENTIFICATION OF THE ES

The MSEC project in Vietnam has demonstrated that sustainable agricultural practices require a judicious combination of incentives and the promotion of technologies that have a significant impact on smallholder incomes and on environmental sustainability.

Insights from our local study has proved the rapid micro-economic impact of new appropriate agricultural practices. In Tien Xuan Commune (the MSEC experimental site), the smallholders' incomes have doubled in 3 years by the cattle husbandry rising (figure 3).

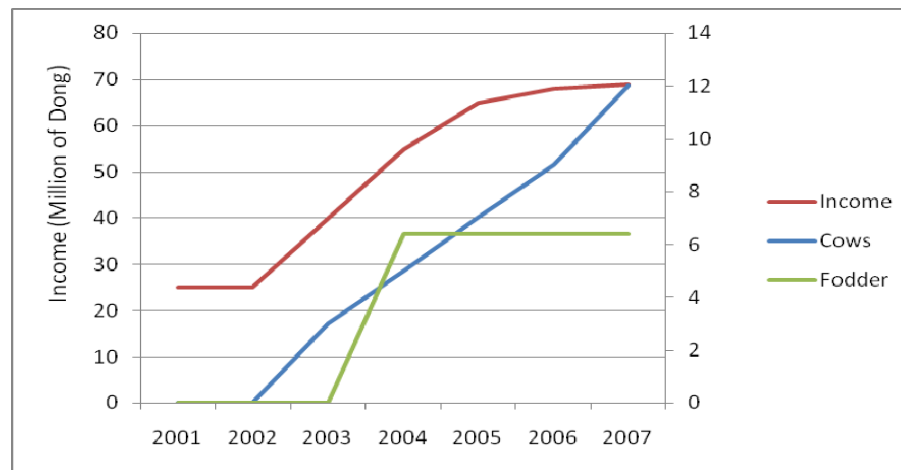

Figure 3: Increase of the smallholders' incomes in Tien Xuan Commune thank to the cattle husbandry rising (from **Orange, 2008**)

It has been also shown that although farmers are concerned about the environment and resource management, this in itself may not motivate them enough to adopt sustainable land and water management practices. By increasing farmers' incomes through intensive livestock production, the MSEC results have shown that indirect methods can help control erosion (**Orange et al., 2008**).

### **Conclusion 3:**

**An assessment of farmer based knowledge on rapid incentive mechanism able to mobilize the farmers' interest in Tien Xuan Commune has promoted biogas generation technique. This idea has been put in action within *on-going concrete action through two studied farms.***

In addressing the issues of sustainable utilization of upland systems within an agronomic context, a fundamental constraint to adoption of appropriate farming practices is the lack of quick and tangible benefits to the adopter. To address this impasse, an incentive based approach to the sustainable production of crops on sloping lands has been initiated at two farms in Dong Cao Village where the use of biogas generation from human and animal waste resulted on sustainable crop production on sloping lands. The two pilots have been established with a contract between households to produce livestock feed on sloping lands in a sustainable manner and to utilize the solid waste generated from store-fed animals to produce compost that is applied to upland fields. In return the farmer has received a biogas digester. Preliminary assessment of these farmers have indicated acceptance of this scheme, increased productivity of the farming unit and greater well being of individuals. Based on current on-going pilot farms, this study is dealing with a number of concrete actions addressing

households' livelihoods and the management of uplands, as shown in the project framework (Figure 3). The key question is formulated as follows: *Is it possible to use the interests of farmers in biogas production to promote sustainable agricultural practices on sloping lands?*

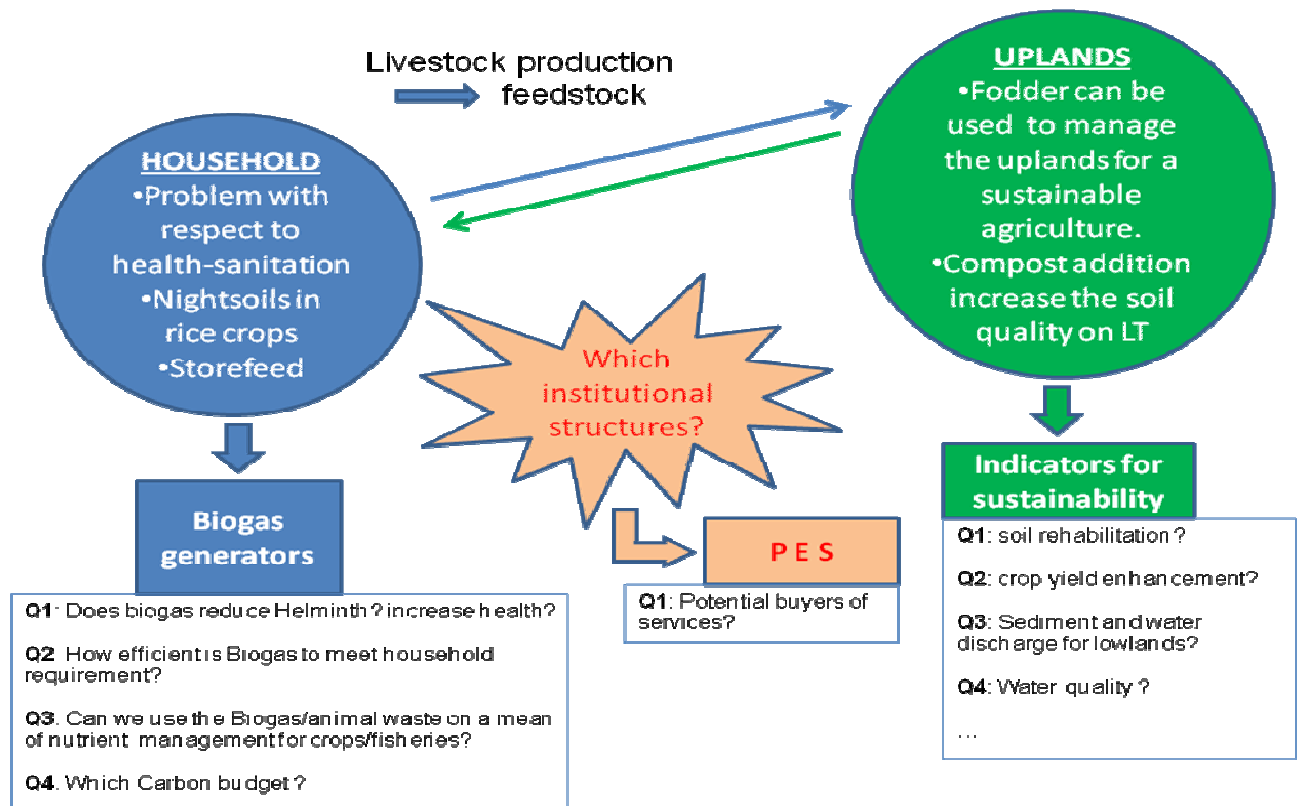

**Figure 3:** PES framework and environmental services to be tackled.

Although the implementation of interventions that result in an enhancement in sustainable utilization of natural resources and equity with long-term benefits to potential adopters, they often do not provide sufficient immediate economic returns to resource-constraint farmers. Payments for Environmental Services (PES) schemes present a new approach that focuses directly on creating a conditional benefit transfer between upland providers of environmental services and the downstream beneficiaries of these services.

**Conclusion 4:**

***The use of biogas technology purchasing by the farmers should create a favorable framework for PES scheme implementation.*** The final aim is to drive farmers to the access new agro-ecological technologies for agricultural production on sloping lands by involving them in markets through a PES mechanism to guarantee the environmental services (ES) benefits. **The concept is to profit from the farmers' interests in biogas production in order to promote the purchase of a biodigester, since the biodigester introduction into the farming operation farm will force them to change their farming system in order to respect the environmental services (decrease erosion on the sloping lands, increase the water quality, promote the sustainable agricultural use of the sloping lands based on the farmers' strategies, enhance the human health and the well being) by increasing smallholders' income.**

**The benefits** due to the introduction of biogas generation at the household level based on human and animal waste products are:

- enhance the sustainable use of uplands;
- increase smallholder's incomes;
- and significant health benefits.

**The research assumptions** to be tested or documented in this project are related to:

- **The PES concept** is an appropriate mechanism to mobilize this strategy;
- **The focal point is biogas generation** to create a benefit loop for the sustainable development of a new vision for agricultural and rural development (ARD);
- **The sustainability** is confirmed through positive impacts that include *environmental, economic and well-being*.

At last, the present study of pilot farms will assess the efficacy of household biogas production based on human and animal waste, in delivering positive environmental, economic and health benefits. A key outcome of this study will be quantification of these benefits and the development of an incentive framework that would promote the adoption and out-scaling of this approach in the uplands of Vietnam. The main output will be scientific knowledge on:

- (1) the environmental services** generated through the adoption of a biogas system that is based on sustainable crop production on sloping lands;
- (2) a socio-economic and health assessment** of households utilizing biogas generation at two pilot sites; and
- (3) a PES framework feasibility** based on incentives as a means to achieving sustainable land and water management in upland agronomic production systems in Northern Vietnam.

The purpose is to assess the development of effective policies and incentives that are based on quantifiable scientifically based monitoring indicators that will promote the sustainable utilization of upland cropping systems. This approach will enhance the productivity and income generation opportunities for disadvantaged rural farmers in upper catchments in Northern Vietnam that result in equitable distribution of benefits to upstream and downstream communities and the adoption of sustainable land and water practices. **This will be achieved through an assessment of the environmental service, economic and health benefits associated with a current study that promotes biogas production from animal and human wastes, animal waste composting, and sustainable crop production on sloping lands (Orange et al., 2007b).**

## TASK 2: EFFECTIVE COST FOR UPLANDERS

The objective is to evaluate the effective costs of biogas production linked to the composting process for soil fertilisation in the uplands, in order to determine the capacity of these new farming practices to be a sustainable environmental service. The evaluation is based on the study of one farm in Dong Cao village, the M. Thào's farm.

The first step was to establish a diagram representing all the interactions linked with the biogas production and composting process: it would help to understand which parameters are at stake (Figure 4).

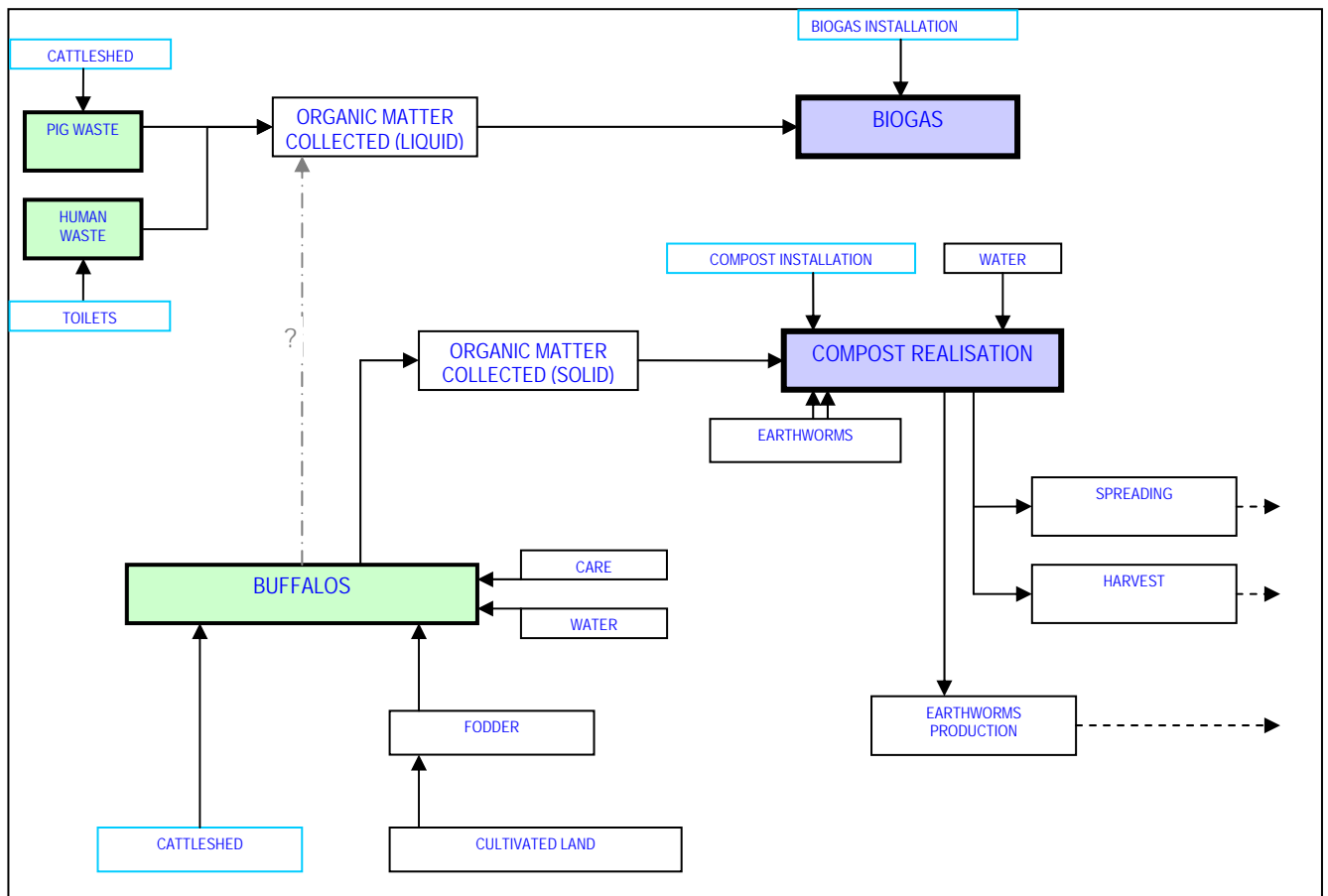

**Figure 4:** Diagram on biogas production and composting process to underline the cost-effective parameters.

The second step was to fill out a table set up (Table 1) based on the previous diagram with 5 criteria (investment, time of work, space, expenses and income / yield / gain).

**Table 1:** Costs of biogas production associated to upland soil fertilization through organic matter composted process.

		INVESTMENT	TIME OF WORK	SPACE	EXPENSES	INCOME / YIELD / GAIN
CULTIVATED LAND	Rice farming	For free, but limited area (600 m <sup>2</sup> / person).	- 2 harvests / year, - Work: to plant, to take care of, to harvest.	Downlands: 1800 m <sup>2</sup> for rice farming.	Fertilisers: <b>7,2 millions dong</b> / year.	- Family consumption (700 kg rice / harvest) during 8 months, - Rice purchase for the last 4 months.
	Fodder farming					
	Grazing practice	For free (at disposal by the Committee People).	-	Uplands (one side of the mountain) at disposal, without any limit.	-	Food for free for cattle.
FODDER		No fodder production for M. Thảo.				
CATTLESLED		One cattleshed = <b>5 millions dong</b> .	1 week.	30 m <sup>2</sup> designed for 6 buffalos, of which 12 m <sup>2</sup> for waste collection.	Any reparation since 2003.	-
BUFFALOS		One buffalo = 2 millions dong in 2002 ⇒ 3 buffalos = <b>6 millions dong</b> .	- 2 hours each morning: to go to grazing lands, - 1 hour in the evening: to bath, to come back to cattleshed and to treat parasites.	Cf. cattleshed.	- Veterinarian: <b>270 000 dong</b> / year, - Chemicals against parasites: <b>480 000 dong</b> / year, - Straw of rice, maize and cassava from Thảo's own production.	- Work on the fields (30 days / year, rice farming), - For sale: <b>7 millions dong</b> / buffalo, - Important social representation.
SOLID ORGANIC MATTER (OM) COLLECTED		Cf. buffalos.	One buffalo = 5 kg / day of solid waste ⇒ 5 minutes / day.	12 m <sup>3</sup> in the cattleshed.	Cf. earthworms.	- OM used mixed with fertilisers (rice), - For a "traditional" compost (anaerobia): <b>300 000 dong</b> / tonne.
EARTHWORMS		Cf. institut de l'élevage (NIAH), 04 83 87 23 8.		Cf. compost box.	/	1 kg dried earthworms = <b>700 000 dong</b> .
COMPOST REALISATION	Compost box	3 compost boxes (0,5 m <sup>3</sup> for each one) = <b>1 million dong</b> .	10 days.	3 m <sup>2</sup> for the 3 boxes.	/	-
	Maturing phase		30 minutes / week: to check, to return eventually.	Cf. compost box.	/	- Better carbon assimilation in soil, - Less fertiliser added.
SPREADING		Unavailable data (not yet realised).				
HARVEST						

↻ Several points important to keep in mind:



- The first point is that even if compost is spread with the good rate, fertilisers should be added to obtain efficient yield for farming. That means that fertilisers will continue to be used, but will be added in a smaller quantity,
- Concerning earthworm production: it appears that once earthworms are included in compost box, there is no need to put again other earthworms to ensure efficient results. Earthworms' reproduction is fast enough to take up all the compost box volume. On the other hand, because they are inclined to stay at the bottom of the compost box, the most part of them are in place for the following input of organic matter. That's why the arrow between "compost realisation" and "earthworms' production" exists only in one way,
- Whenever "water" appears, any expense is engaged for the moment, because water is free; and despite any water management, the quantity is enough in the watershed, according to M. Thào.

Some calculations have been done concerning the amount of compost needed:

- In one compost box of **0,5 m<sup>3</sup>**, we put usually 60 % of solid waste (2/3), that means that if we take 1 for the density of buffalos waste (assumption), we need **300 kg** of waste to fill it,
  - After 3 months of maturing phase, there is a reduction of 30 to 40 % of volume of compost, that is to say around **200 kg** of compost obtained,
  - To be efficient, one tonne of compost should be spread per hectare, which means that with one compost box, we can fertilise **200 m<sup>2</sup>** of lands.
  - M. Thào has 1800 m<sup>2</sup> at his disposal to cultivate rice, and about 1500 m<sup>2</sup> behind his house to cultivate cassava and maize, that is to say 3200 m<sup>2</sup> in totality. Thus he will need **3200 kg** of compost per year to use it on his lands.
  - 3200 kg equals to 16 compost boxes, and also equals to **4800 kg** of buffalos waste per year,
  - One buffalo produces 5 kg of waste per day; with 3 buffalos, we obtain **5 500 kg** of waste per year.
- ⇒ **According to this calculation, M. Thào will have enough buffalos waste to produce compost in order to use it on all his fields**
- Nevertheless, there is the question of space: how many compost boxes we need to produce compost with all the buffalo's waste quantity?  
One box = 300 kg of waste. This quantity is obtained after 20 days with 3 buffalos. With the 3 months maturing period, that means that compost is ready after (20 + 3 x 30) 110 days. That also means that **6** boxes are required to produce compost continuously (after 120 days, 6 boxes are filled and the first one is ready to be used).
  - The best solution would be to produce compost with the technique of [*tas en andain*]. The system consists of the addition, day after day, of buffalos waste in a pile in triangular form. By this way, all the buffalos waste production could be used, the required place is less important than compost boxes, and there is no need to wait for 300 kg of waste to begin a new compost box.

Concerning the biogas, here are several costs relative to the method:

- Toilets: **1 million dongs** for building (investment),
- Human waste: one person produced between 180 and 340 g of solid waste / day ⇒ for M. Thào's family (4 adults and 2 children), that represents around 1,5 kg / day,

- Cattleshed for pigs: **5** millions dongs for building (investment), 1 week of work, 40 m<sup>2</sup> of which 2 m<sup>3</sup> for waste collection,
- Pigs: One pig of 10 kg cost 300 000 dongs (in 2005) ⇔ for 3 adult pigs, **900 000** dongs (investment),
- Food and care for pigs: except maize and cassava produced by M. Thào's farming, extra-food is bought at the rate of **1,8** million dongs / year (expenses). For care, this is the same principle than for buffalos, that is to say **270 000** dongs / year for adults, and **30 000** dongs / young pig / year (expenses),
- Pigs for sale: one pig of 10 kg is sold **500 000** dongs (income),
- Pig waste: one pig produced around 2 kg of solid waste / day,
- Biogas installation: **14** millions dongs for building (investment), 2 weeks of work, the biggest container is around 12 m<sup>3</sup> (under the ground).

This study is always on-going and we cannot conclude on the effective cost right now.

### TASK 3: EROSION AND RUNOFF MODELING WITHIN UPLANDS

#### *EXPERIMENTAL DONG CAO WATERSHED USED TO CALIBRATE PLER*

The Dong Cao watershed used for the PLER calibration is completely based on sloping lands with surface area of around 50 ha (Figure 5).



**Figure 5** : Picture of the experimental Dong Cao watershed used to calibrate PLER

**Figure 6** : Automatic weather station *Cimel*



## Meteorological data and flow discharge measurements

Thanks to an automatic weather station *Cimel* (figure 6), rainfall amount and intensity was recorded every six minutes. This automatic station also records temperature, humidity, wind speed and solar radiation intensity. Moreover, the watershed is equipped with five manual rain gauges taken down every morning.

The watershed is equipped with 5 runoff measurement stations named *weir* (figures 7 and 8). Each weir is set with an automatic water level recorder (*asThalimedes-OTT*). The water level (WL) is recorded each 3 mn when the WL is moving up or down. The relation water level/ flow have been determinate by gauging thanks to a micro-propeller; flow speed is measured in several section points of *Parshall* weir downstream. Then the *Biber* software is used to calculate an average speed and the flow.

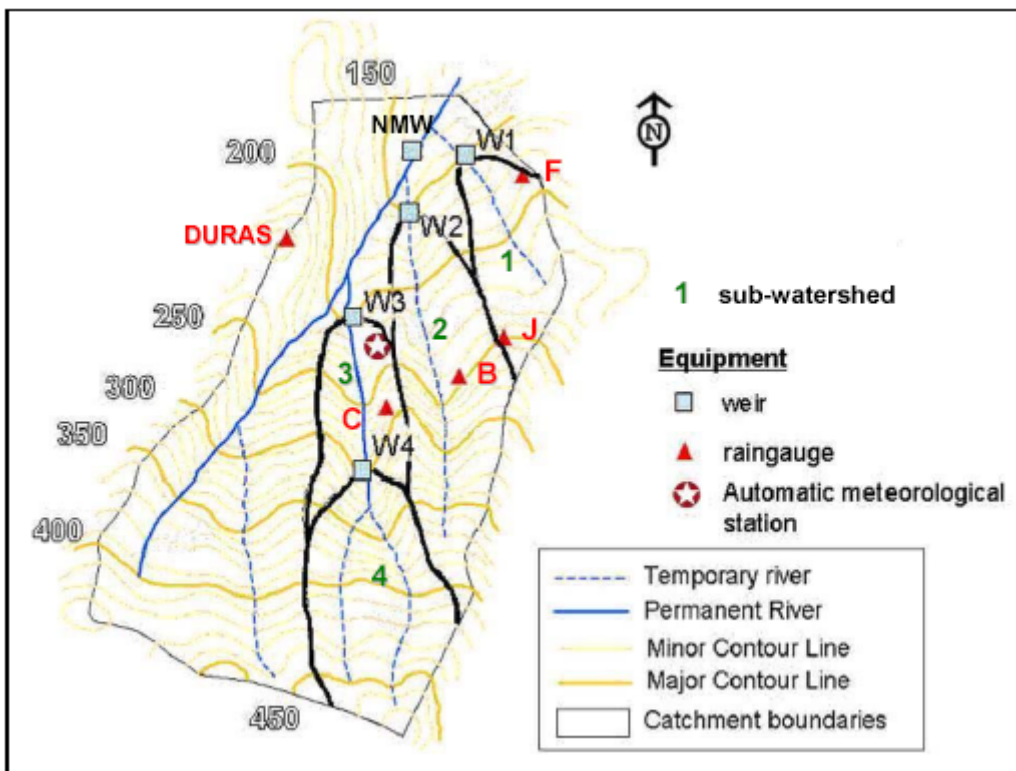

**Figure 7:** Topographic map of Dong Cao watershed and hydrological equipments on the field (NMW: New Main Weir, Wi: Weir i)

**Figure 8:** Weir 3 (W3)



*PLER ALGORITHM UNTIL 2007 (PLER V1) (FROM DO DUY PHAI ET AL., 2006)*

**Inputs and outputs**

*Inputs (figure 9) were:*

- digital elevation model in raster format (in Vietnam : 2 m grid size);
- map with location of the measurement devices ("weirs");
- maps with soils and land-use units in the same raster format. Each unit is linked with 10 parameters (in green on figure 9)
- time series with real or predicted rainfall and PET;
- 2 calibration values taking into account the anteriority of rainfalls (initial infiltration capacity ratio and initial water content of the soil), and 1 calibration value taking into account the water paths (ratio between effective velocity and the computed velocity, depends on mean hydraulic radius of the water pathways and can be set according to the response time of the watershed).

*Outputs (figure 9) were:*

- maps with cumulated runoff, sediments detachment, flux and storage (generated every time step / every hour / every day... according to the user's needs);
- time series with values of runoff, sediments detachment, flux and storage for the cells where the measurement devices are located (for calibration / validation).

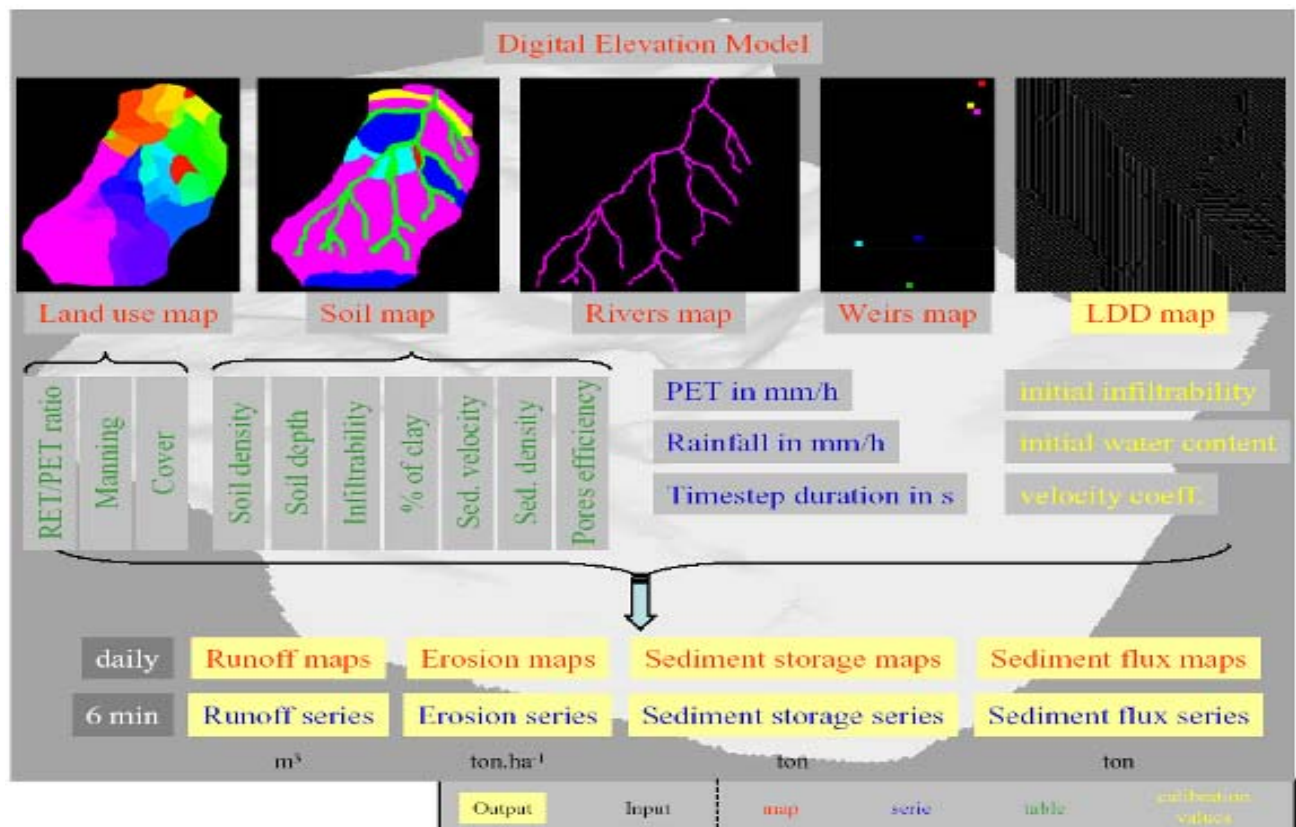

**Figure 9:** Input and output maps, tables, time series and calibration parameters in PLER model

Land-use and soil maps were overlapped on the digital elevation model. Each cell of the watershed had a specific value for:

- **static values:** topographic parameters (slope, slope length, downstream direction), land-use parameters (RET/PET ratio (%), Manning roughness coefficient, cover (%)), soil parameters (soil density ( $\text{kg}/\text{m}^3$ ), soil depth (m), minimum and maximum infiltration capacity (mm/h), % of clay (%), mean sediments velocity of deposition in stable water (m/s), mean sediment density ( $\text{kg}/\text{m}^3$ ) and pores efficiency ratio (efficient pores / total pores,%);
- **dynamic values:** pores available for water storage (mm), infiltration capacity (mm/h, fluctuating between a minimum and a maximum), water volume stored in the cell ( $\text{m}^3$ , conceptual reservoir), mean efficient velocity of surface and subsurface water runoff (m/s), time needed for this runoff to reach the outlet of the watershed (s), runoff ( $\text{m}^3/\text{s}$ ), sediments detachment (t/ha), transport capacity of the flow ( $\text{kg}/\text{m}^3$ ), sediments flux and cumulated flux ( $\text{kg}/\text{s}$  and ton), sediments storage (ton).

## Modelling concept used in PLER

### *a/ From rainfall to runoff*

PLER model is a 2 dimensions' model. The surface of the watershed is divided in square cells (5m x 5m). According to the figure 10, the depth of each cell is defined as the height of soil which depends on the kind of soil identified.

A water stock (conceptual reservoir) is attributed to each cell of the grid. At each time step, the water stock:

- increases by **net rainfall** (= rainfall - evapotranspiration), measured from available climatic datasets;
- decreases by **deep drainage** and **downstream runoff**. Deep drainage is the amount of water lost for the watershed at each time step. Downstream runoff is the part of the runoff that will reach the outlet during the considered time step.

Therefore there is **no upstream runoff** to take into account, as each cell is assumed to stock this water in its proper conceptual reservoir. The downstream runoff increases with water stock  $^{2/3}$ , so cells far from the outlet will need several time steps with rainfalls in order to reach a sufficient water stock to contribute in the overall runoff, whereas cells near from the outlet will contribute to this runoff much earlier.

The runoff modulus has been developed taking into account some results of runoff measurements carried on the field scale by MSEC partners, with some assumptions. For slopes over 20%, infiltration capacity is assumed to be **proportional to slope** and, for covers over 30%, also **proportional to vegetation cover**. Infiltration computation at each time step is distributed according to land-use map and slope map and **saturation** has a **feedback** on the values of **infiltration capacity** and **evapotranspiration (water loss)**.

Water balance

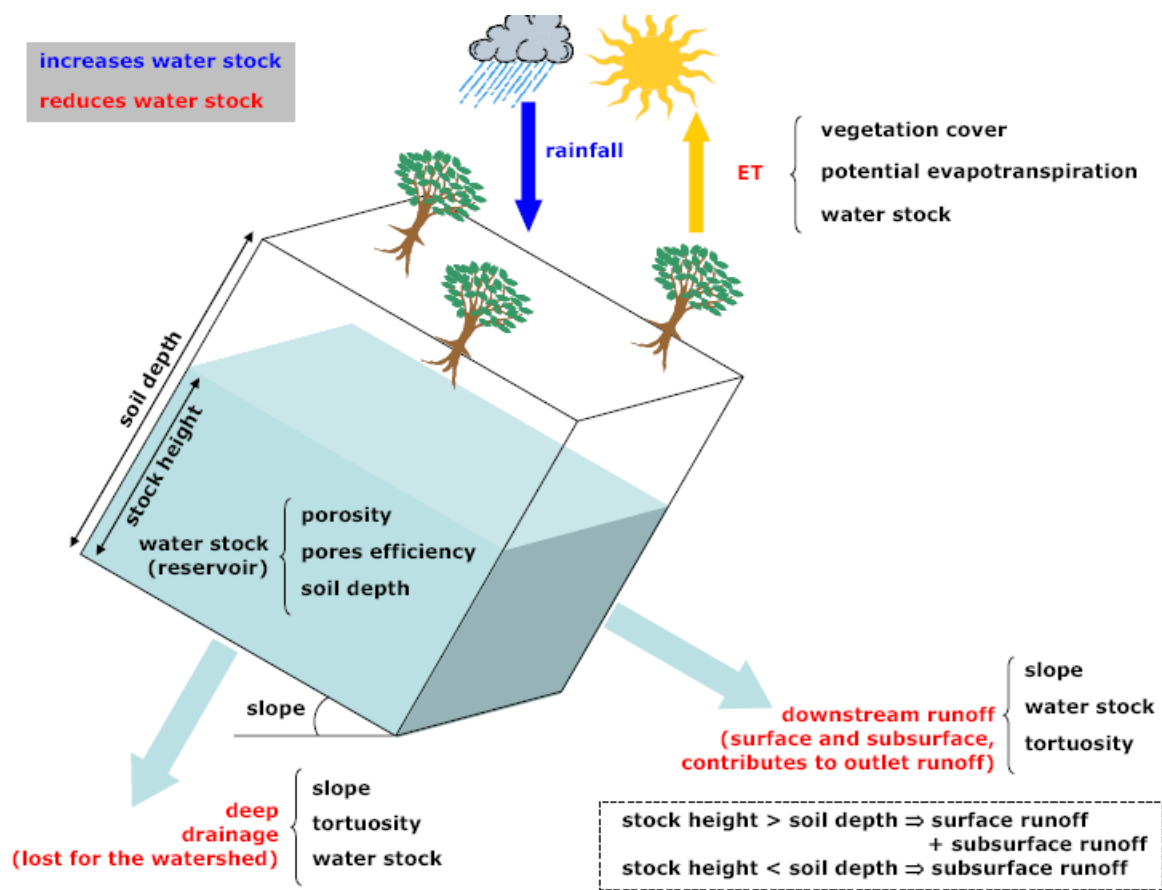

**Figure 3:** Runoff generation for each cell of the grid at each time step

Equivalent soil column

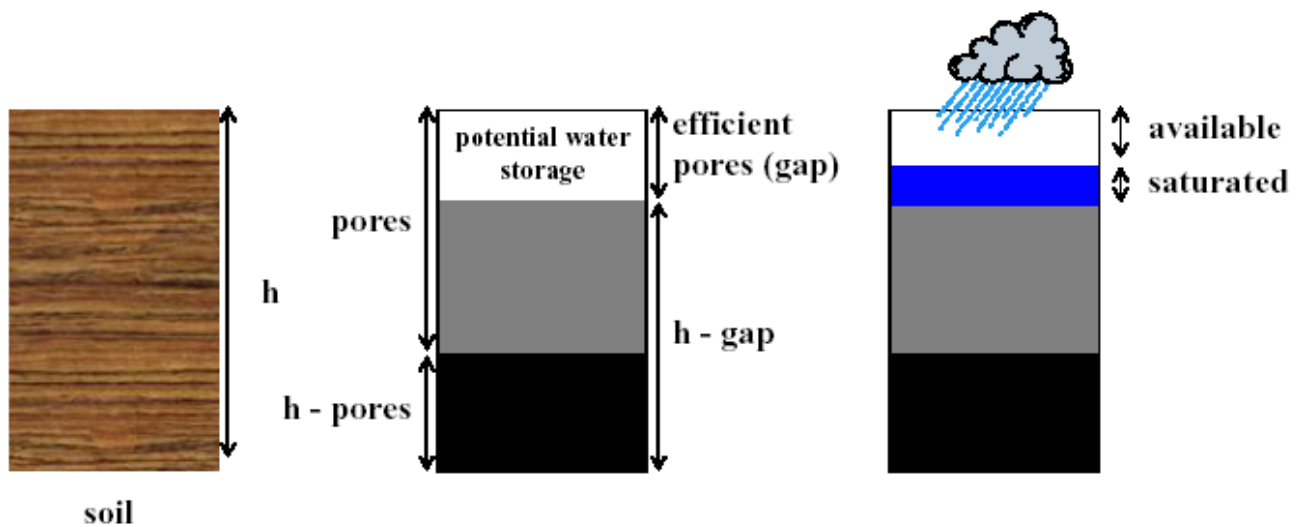

**Figure 4:** Equivalent soil column and available water storage in the soil

At the level of each cell, the soil is divided into two parts: a part with efficient pores (potential water storage = "gap") and a part with sediments and structural pores (figure 11):

$$\text{gap} = \left( 1 - \frac{\text{soil density}}{\text{sediment density}} \right) \times h \times \text{pore efficiency}$$

At each time step, according to the amount of water already stocked in the cell, one part of efficient pores are available for further water storage and the other part is saturated:

$$\text{Available (t+1)} = \text{available (t)} - \text{net rainfall (t)} + \text{downstream runoff (t)} + \text{deep drainage (t)}$$

At each time step, the soil's saturation is taken into account and two kinds of "runoffs" can be produced:

- If the soil is saturated, the "subsurface runoff" and the surface runoff are considered;
- Else, the only "subsurface runoff" occurs.

The **ratio available / potential water storage** determines the efficiency of deep drainage and evapotranspiration:

$$\text{deep drainage} = \text{infilmax} \times \frac{\text{available}}{\text{gap}}$$

$$\text{evapotranspiration} = \text{potential evapotranspiration} \times \text{crop effect} \times \frac{\text{available}}{\text{gap}}$$

This ratio can fluctuate between a minimum and a maximum according to soil characteristics (figure 12).

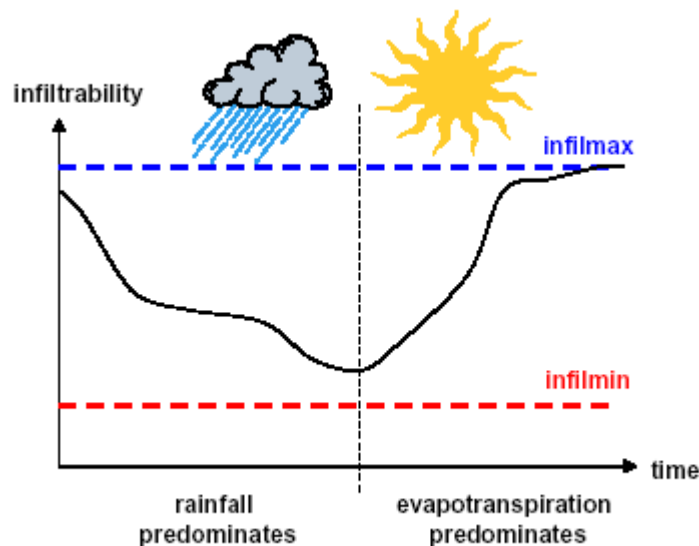

**Figure 5:** Variation of infiltration capacity between minimum and maximum under rainfall and sunshine



The **water stock** is calculated at each time step by the formula:

$$\text{Water stock (t+1)} = \text{water stock (t)} + \text{net rainfall (t)} - \text{downstream runoff to outlet (t)} - \text{deep drainage (t)}$$

The **height of the water conceptual layer** is defined as:

$$H_m = \text{height of the runoff flowing over the cell} + \text{height of the water stock}$$

According to Manning-Strickler equation, the **velocity** of a flow is:

$$V_{MS} = \frac{\text{hydraulic radius}^{2/3} \times \sqrt{\text{slope}}}{\text{manning roughness coefficient}}$$

Hydraulic radius is defined as flow section divided by wet perimeter. The velocity of subsurface and surface flows contributing to the runoff at the scale of a watershed cannot be physically computed with this original equation, because we have no possibility of measuring or even assessing the hydraulic radius of a flow divided between surface rills and soil pores (the path of the water in soil pores and stratifications involves too many parameters and most of them are impossible to measure at the catchment scale). Therefore **we assume to use a simplified empirically calibrated equation based on Manning-Strickler's. We also assume to use the manning roughness coefficient for subsurface flows, even if its value is linked to surface roughness of the soil.**

The average velocity of waters flows in subsurface and surface paths is:

$$V = \frac{\sqrt{\text{slope}} \times \text{high of conceptual water layer}^{2/3}}{\text{manning coefficient}} \times \text{calibration coefficient}$$

The average of this velocity from the studied cell to the outlet ( $V_m$ ) determines **the part of the water stock  $Q_p$**  flowing into the drainage network at each time step:

$$Q_p = \frac{V_m \times \Delta t}{L_s}$$

with:

- $V_m$  : average of the velocity from the studied cell to the outlet;
- $\Delta t$  : time step duration;
- $L_s$  : Slope length to the outlet.

In streams, the manning coefficient is lower and the height of the water conceptual layer is higher (accumulation from upstream cells), resulting in a higher velocity.

***b/ From runoff calculation to sediment detachment and transport: Guess equation***

This modulus uses Guess model equation distinguishing two processes: (1) soil destructureuration by water drops impact and surface and subsurface sheet runoff (**interrills**); (2) detachment and transport by concentrated runoff (**rills**).

Guess equation first calculates the transport capacity of each cell:

$$\text{transport capacity} = \text{runoff}^{0.4} \times \frac{\text{sediments density}}{\text{sediments velocity of deposition}} \times \frac{\text{slope} \times \text{slopelength}^{-0.4}}{\left(\frac{\text{sediments density}}{\text{water density}} - 1\right)} \times \left(\frac{\sqrt{\text{slope}}}{\text{manning}}\right)^{0.6} \times e^{-\text{manning} \times \text{vegetation cover}} \quad (10)$$

From the height of the flow and the transport capacity, soil destructureuration and quantity the mass of sediments able to flow is:

$$\text{destructureuration} = \text{transp. capacity}^{\text{cohesion}} \times \text{water height}^{0.4 \times \text{cohesion}} \times \text{runoff} \times e^{-\text{manning} \times \text{vegetation cover}}$$

Destructureurated sediments can migrate downstream according to the drainage network and the transport capacity of each cell. Runoff and slope are the more variable parameters in this equation.

The results can be displayed under ArcGis (figures 13 and 14).

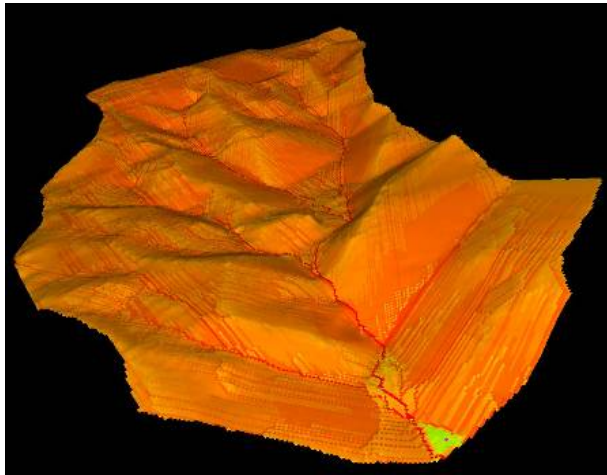

**Figure 6:** Example of output runoff 3D map displayed with ArcGis. *The higher runoff pathways are displayed with red color. The streams clearly appear as higher runoff pathways.*

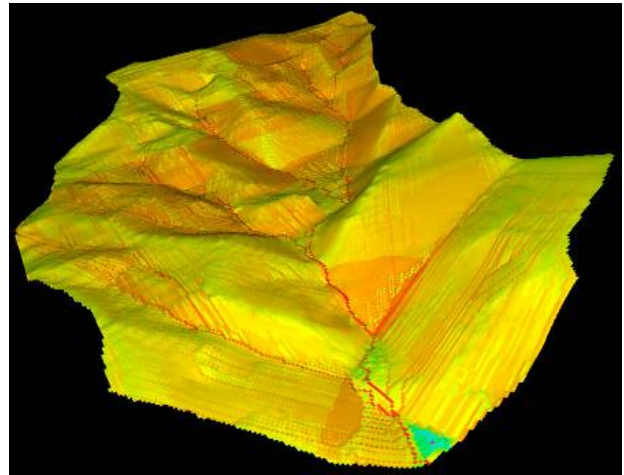

**Figure 7:** Example of output erosion 3D map displayed with ArcGis. *The higher erosion pathways are displayed with red color. The streams clearly appear as higher runoff pathways.*

2007: PLERV3, NEW INVOLVEMENTS (BY BUI TAN YEN)

The involvements applied in PLER resulted in a new version of the model: PLER v3.

**More input parameters variable with time**

According to figure 15, in order to give more precision in the computing of runoff and erosion at each time step, the following parameters are now changing with time:

- **Land use changes and vegetal growth** are considered:
  - o Land use changes are in correspondence to the cuts of forests which give birth to young fallow;
  - o For each kind of vegetal species, the specific vegetal growth is taken into account according to the vegetal growth cycle;
- The **Manning roughness coefficient** is estimated (*see paragraph III.b.ii*) according to the land use and its changes, and taking into account the vegetal growth;
- The **vegetation cover rate** is intrinsically linked to the land use and the vegetal growth. It is defined according to them (*see paragraph III.b.ii*);
- **PET** (Potential EvapoTranspiration) and **RET** (Real EvapoTranspiration) are also changing with the vegetal growth and the climatic conditions.

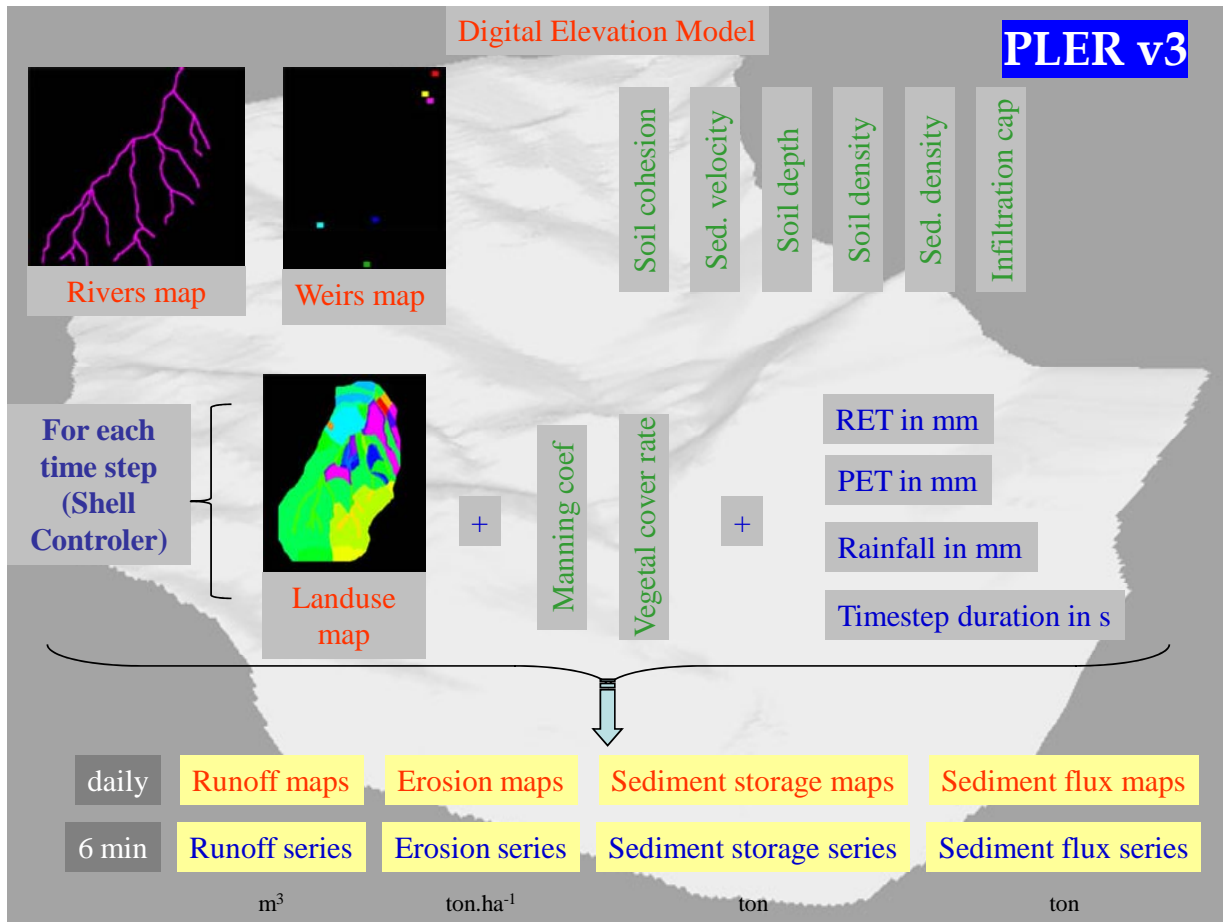
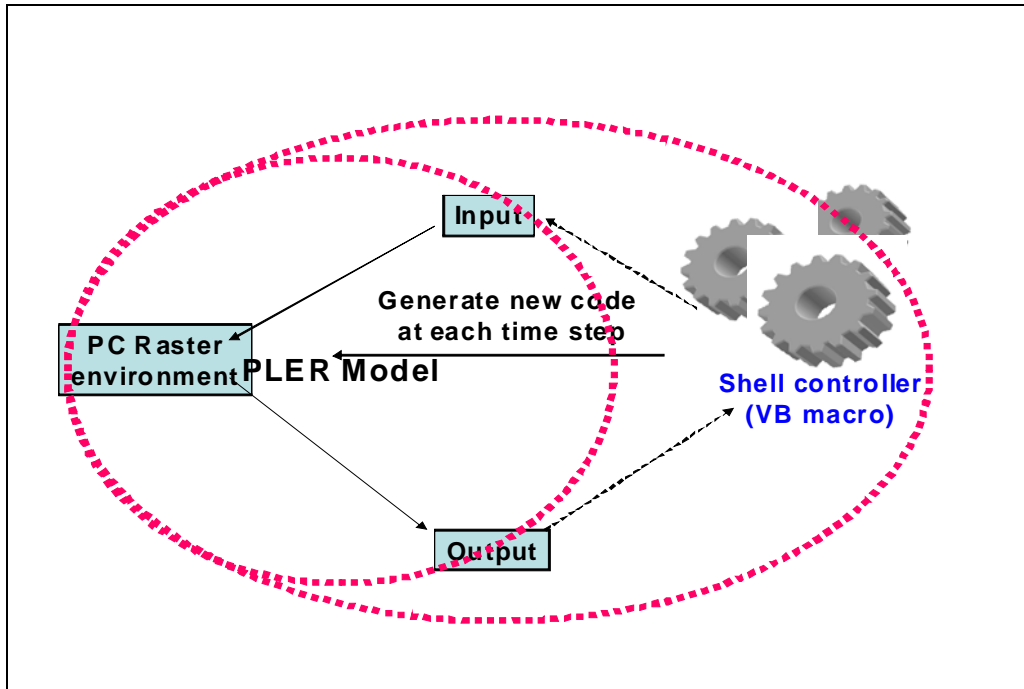

Figure 8: Inputs and Outputs of the PLERV3 model

**Changes in the model structure to take into account the new input parameters changes with time.**

The PCRaster language used to code the algorithm of PLER v3 does not permit changes in the input parameters entered as maps. **The changes of input parameters with time involved the use of a shell controller represented by a VISUAL BASIC macro** (figure 16).

At each time step, PLER v3 is running in its PCRaster environment. The shell controller gets the outputs and generates new inputs which are used at the next time step for the model running.



**Figure 9:** Scheme of the link between the PCRaster environment and the Shell controller (Visual Basic macro)

*2008: PLERV4 FOR FINAL CALIBRATION STAGE (BY J. BERTRAND)*

**Resume on the initial state (from B.T. Yen, dec. 2007)**

- Model calibrated on a 1-year timescale (timestep 1 day).
- Kc (crop coefficient for evapotranspiration) and Mn (manning runoff coefficient) are now dynamic and their value change according to the crop development stage over the year.
- Optimal calibration parameters :
  - DeepInfil = scalar(0.005) ; # Ratio deep infiltration capacity / infiltrability (%)
  - EffGap = scalar(0.1) ; # % of gaps efficient for water transit
  - WpVel = scalar(0.002) ; # Ratio real/computed velocity of the flow
  - RivMann = scalar(0.01) ; # Manning coefficient for streams

*Problems to be resolved :*

- The model doesn't reproduce the flood peaks (duration 3-4 hours), which are flattened at the 1 day timestep (figure 17). Yet it's precisely during these events that the erosion process is the most active.
- The streams map doesn't match the topography of the DEM : streams are thus assigned a wrong manning coefficient.
- The model only computes the discharge at the main weir (MW).

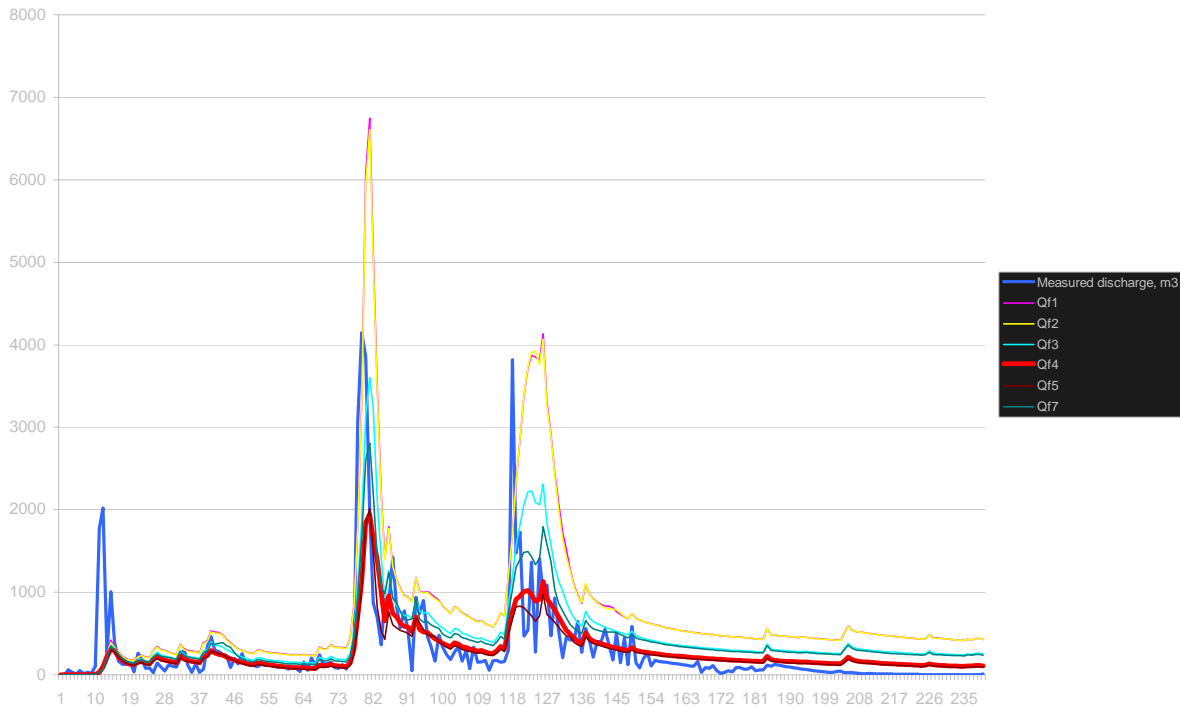

**Figure 17:** Observed runoff (blue curve) and computed runoff (red curve) with PLERv3

### Improvements brought to the model since april 2008

- The model is now more flexible: the paths of the input files are now relative (portability of the model).
- More outputs available (speed maps, water stock in each cell, discharges).
- Computation of the discharge at each weir in a single output file.
- Timestep is now 6 minutes in order to take into account the intense events.
- The stream map is now computed automatically on the basis of the DEM (one input map removed).

#### Tools development

- Tutorial to modify pcraster maps under arcgis 9.2.
- Script to convert the pcraster .map format to .ascii arcgis format.

### Current status of the calibration procedure

Calibration achieved for the 3 intense rain events of 2004: at the beginning of the rainy season in May (figure 18), in the middle of the rainy season in July (figure 19) and at the highest peakflow in August.

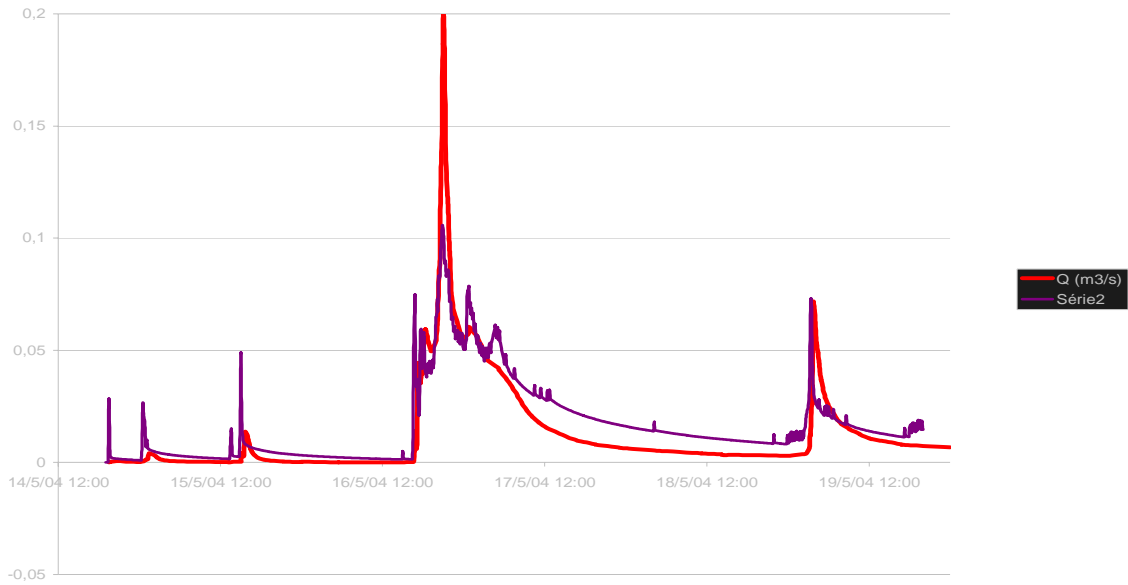

**Figure 18:** Observed runoff (blue curve) and computed runoff (red curve) with PLERv4 in May

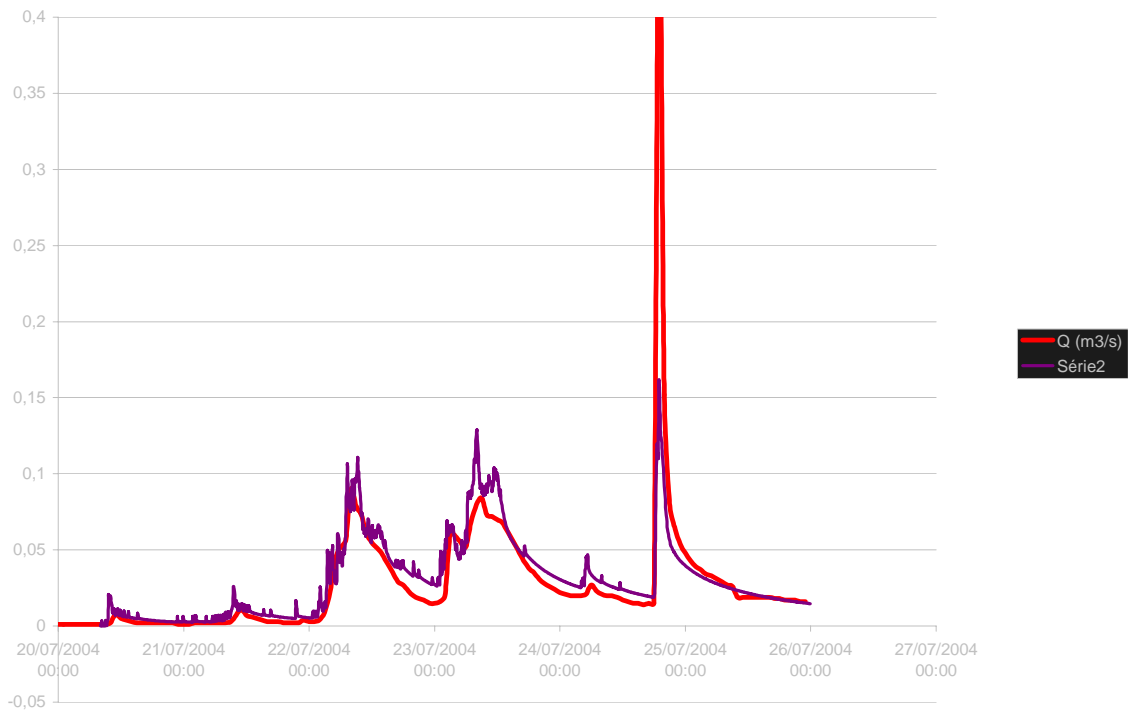

**Figure 19:** Observed runoff (blue curve) and computed runoff (red curve) with PLERv4 in July

The soil is assumed to be dry at the beginning of each computation. Land use remains the same during the year (2004).

*Problems to be solved :*

- Increase the model reactivity during intense events (the strongest peaks couldn't be reproduced properly so far):
  - Define and compute a criteria allowing to distinguish these short rainy events and process them differently with a specific infiltration law;
- Gullies implementation (short-circuits): census to be carried out with Romain (july 16<sup>th</sup>);
- Lower the model sensibility in order to flatten the noise of the computed curve;
- Validity of the DEM: the real drainage area for the MW is greater than the one defined by the watershed limits used until then (north-eastern part of the watershed) and must be redefined.

*Continuation of the calibration*

- Compare the experimental and computed discharge curves at the intermediate weirs (W2, 3, 4);
- Check the influence of the landuse on results by choosing a sub-watershed prone to high landuse variations from one year to another.

## TASK 4: MODELING AND ES SCENARIOS

### *NEW MODEL BUILDING AT THE SCALE OF THE ENTIRE WATERSHED: A LINK BETWEEN THE SLOPING SUB-CATCHMENTS AND THE DOWNSTREAM RESERVOIR*

Because the PES concept involves two different communities between the uplands and the lowlands, two Communes are considered: Tien Xuan Commune and Dong Xuan Commune (see figures 1 and 2). So to model some scenarios on climate change and land use change, we have to consider a large watershed where the outlet is a reservoir used for drinkable water by downstream villages and for irrigation (figure 20). This large watershed includes the experimental Dong Cao watershed used for the PLER calibration and 4 other cultivated sloping lands and a plain used for rice growing.

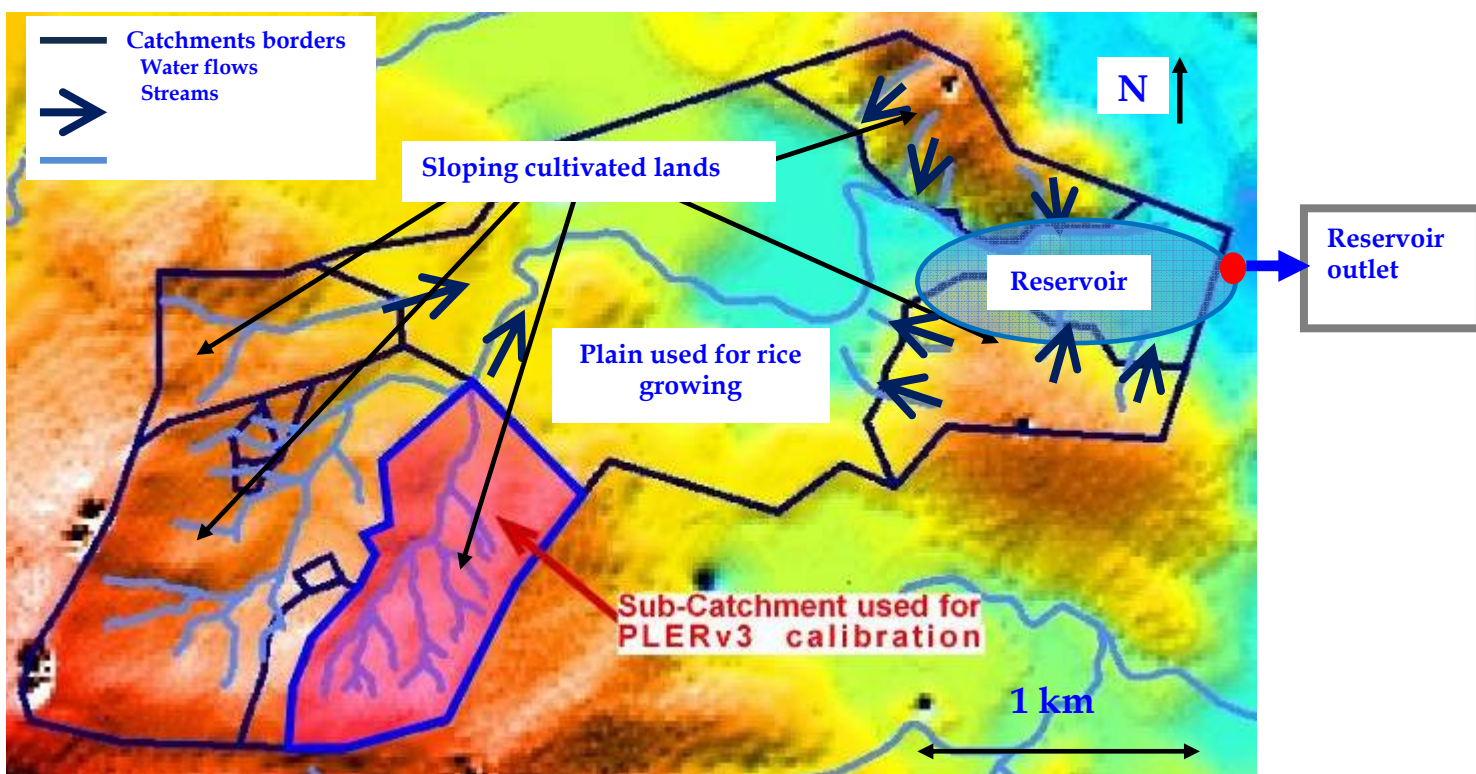

Figure 20: MapInfo map of the large watershed used for PES scenario modeling

### *MODELLING CONCEPT WITHIN THE ENTIRE WATERSHED*

In order to answer to the PES concept at the entire watershed scale, the purpose is to apply the PLER model within the 5 sloping sub-catchments. Then the new platform has to model the link between the five PLERv3 output flows ( $Q_i$ ) and the flow reaching the reservoir ( $Q_R$ ) (figure 21).

**This new platform has to enable the computation of the water flows and the sediments flows reaching the downstream reservoir.**



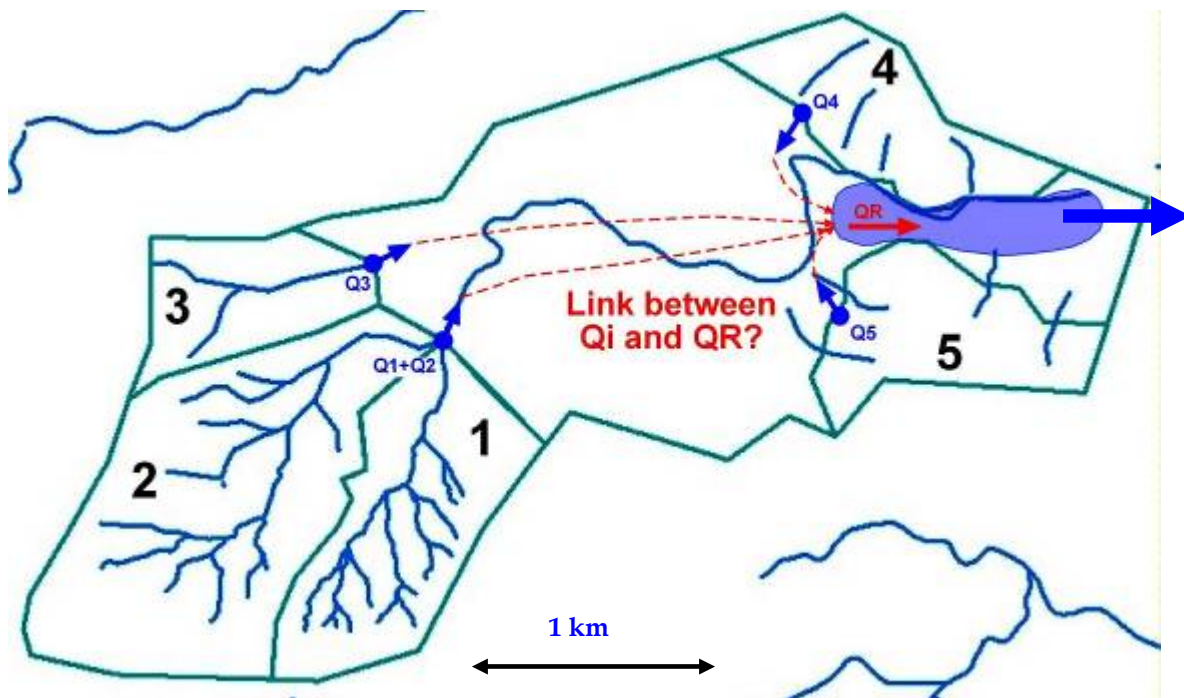

**Figure 210:** Modelling concept at the entire catchment scale

### *PLER RUNNING ON THE 5 SUB-CATCHMENTS*

#### Foreword

*Accounting for the long running time of the model PLERv3 and the difficulties to calibrate it, the calibration of the model has not been done yet. In the following paragraph, only the platform's building and the perspectives of its calibration are presented.*

### **The Digital Elevation Model (DEM)'s building**

The first step to run PLER is to build a Digital Elevation Model (DEM) on the sloping lands, corresponding to the five 5 sub-catchments (figure 22). ***Nota:*** PLER can be applied only on the sloping lands.

The DEM has been built using Arcview and MapInfo. *Whereas the DEM of the sub-catchment used for PLER calibration is made of 2m x 2m cells, the entire catchment's DEM cells are at a minimum 5 m because of the running time of the model. To get more precision, particularly to localize streams, a lower size should be used but the running time of PLER would be really long.*



**Figure 22:** DEM's building with Arcview

**Inputs parameters to run PLERv3 within the five sub-catchments**  
*Sub-catchment 1 (figure 21)*

Within the sub-catchment 1, the work on the field to collect data has begun in 2000 (Do Duy Phai et al., 2007). The collected data are used to build the input maps and tables needed to run PLER. The following figures 23 and 24 are examples of input maps.

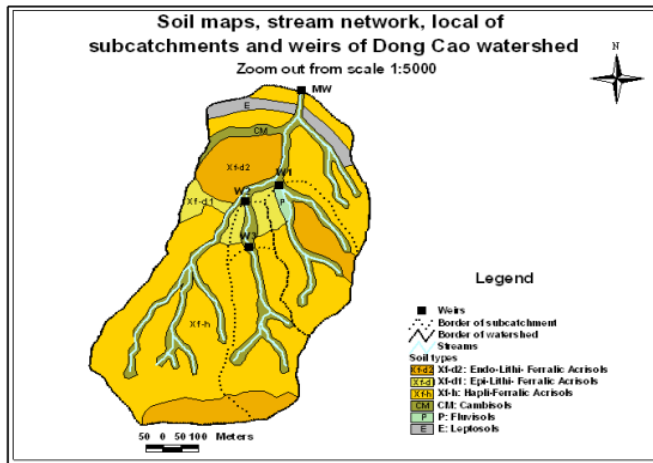

Source: MSc thesis of Do Duy Phai

Figure 11: Soil map, streams and limits of the sub-catchment 1

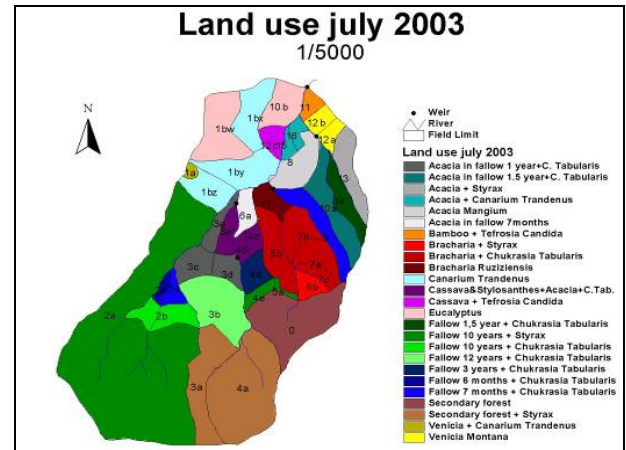

Figure 12: Land use map of sub-catchment 1 in July 2003

Sub-catchments 2, 3, 4 and 5 (figure 21)

Land use

The positions of unpaved roads, streams and of the reservoir have been identified thanks to maps and work on the field. The land use units (figure 25) have been estimated by taking and analysing pictures of the different sub-catchments. The land use estimated is the June 2007's one. WE assume that: a *planted forest* is a more two years old forest, a *degraded secondary forest* is more than 10 years old. As well, an *old fallow* is more than 2 years old.

Land use
cassava (annual crop)
bracharia (pluri-annual crop)
planted forest
young planted forest
old fallow
young fallow
degraded secondary forest

Figure 13: Land use units identifiable within the studied watershed

Sub-catchment 2

In the sub-catchment 2, except the cassava fields identified in the pictures (figure 26), the other land use in place has been considered as **young planted forest**.

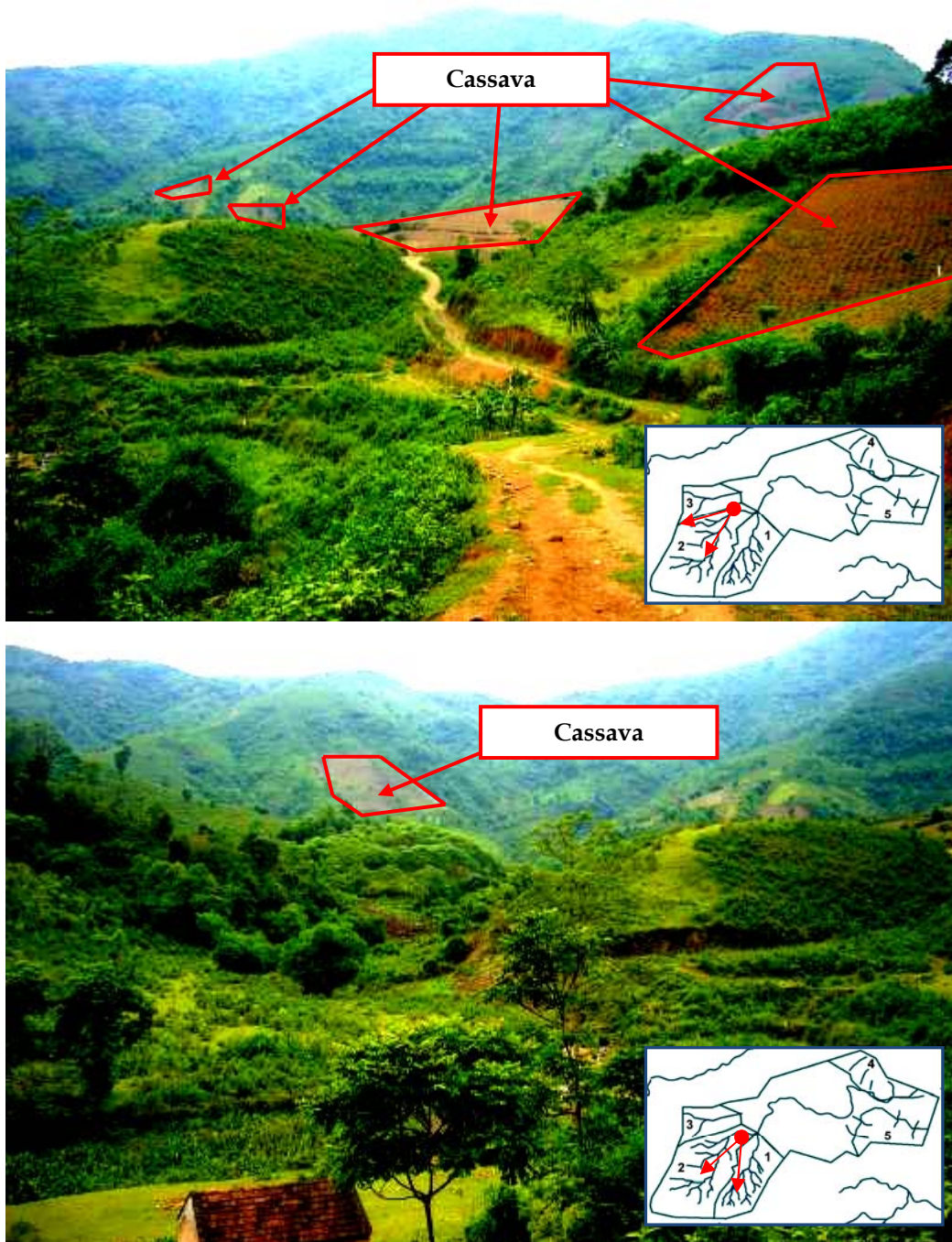

**Figure 14:** Pictures of the sub-catchment 2 and localization of cassava fields

Sub-catchment 3

In the sub-catchment 3, all the land use has been considered as **young planted forest** (figure 27).



**Figure 15:** Pictures of the sub-catchment 3 with young planted forest

Sub-catchment 4

In the sub-catchment 4, all the land use is a **planted forest** (figure 28).

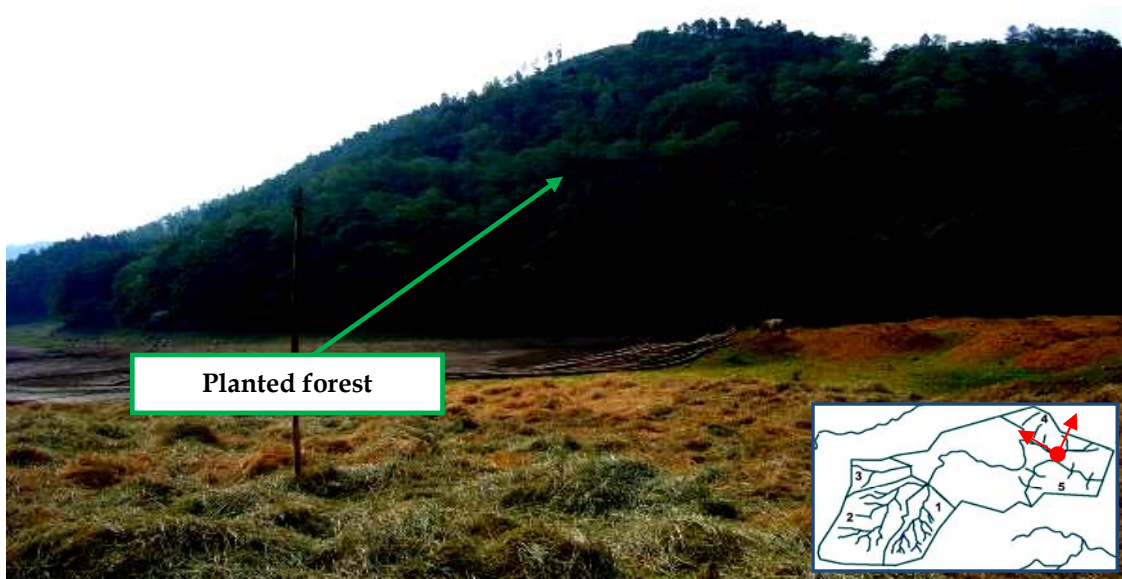

**Figure 16:** Pictures of the sub-catchment 4 with planted forest

Sub-catchment 5

In the sub-catchment 5, the land use has been considered as **young planted forest** (figure 29).



**Figure 17:** Pictures of the sub-catchment 5 with young planted forest

Conclusion : Estimate of the June 2007 's land use

The estimated land use map within the entire catchment is displayed on the figure 30.

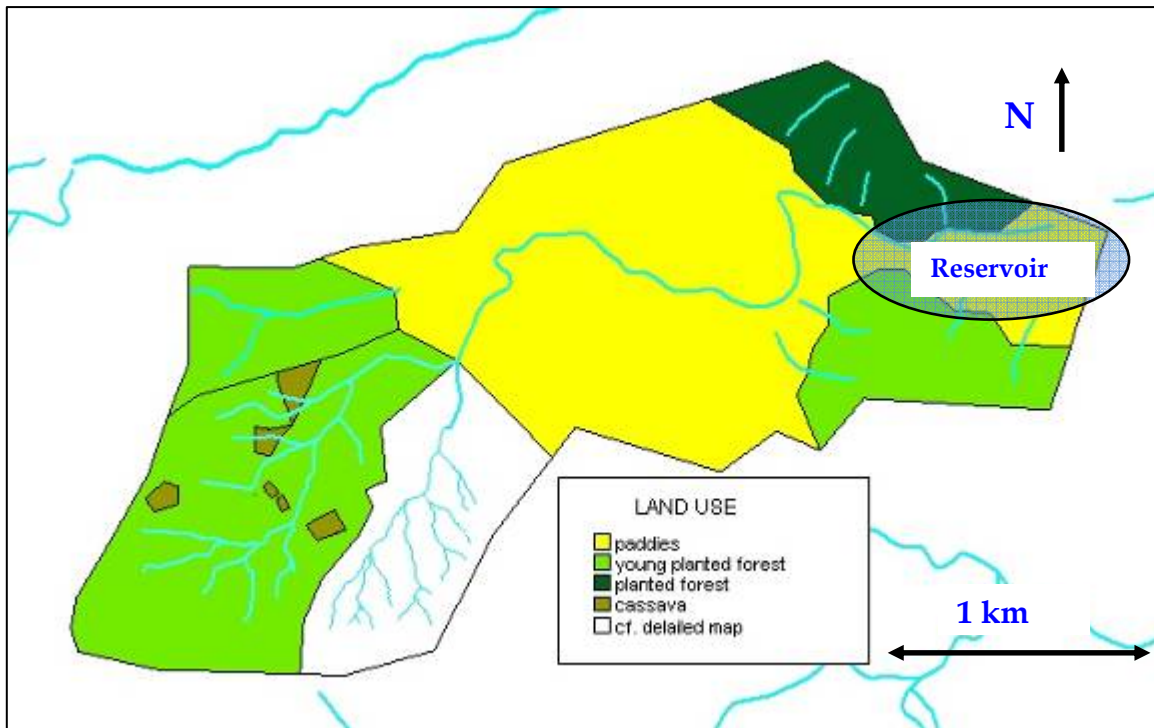

**Figure 30:** Estimated land use map of the current watershed (June 2007)

### Manning roughness coefficient

The values of the manning coefficient have been fixed according to the bibliography (Table 2).

**Table 2:** Estimate of the Manning roughness coefficient according to the vegetal growth

Land use	Manning roughness coefficient [-]									
	Cat	April	May	June	July	August	September	October	November	December
unpaved road	0	0.010	0.010	0.010	0.015	0.020	0.015	0.010	0.010	0.010
cassava	1	0.010	0.015	0.030	0.035	0.035	0.050	0.050	0.020	0.020
bracharia	2	0.025	0.035	0.040	0.060	0.060	0.060	0.040	0.040	0.040
planted forest	3	0.035	0.035	0.050	0.070	0.080	0.080	0.070	0.060	0.050
young planted forest	4	0.020	0.030	0.040	0.050	0.050	0.050	0.040	0.030	0.030
old fallow	5	0.070	0.070	0.100	0.120	0.160	0.160	0.120	0.100	0.100
young fallow	6	0.035	0.035	0.050	0.070	0.070	0.070	0.060	0.050	0.050
degraded secondary forest	7	0.070	0.070	0.100	0.120	0.160	0.160	0.120	0.100	0.100
lake	8	None	None	None	None	None	None	None	None	None
streams	9	0.030	0.030	0.040	0.050	0.050	0.050	0.040	0.030	0.030

### Soil parameters and Vegetation cover rate

Without any soil data available outside of the sub-catchment 1, **the soil parameters in the sub-catchments 2, 3, 4, 5 have been fixed at the average value** among the six types of soils identified within the sub-catchment 1 (table 3) and the same value for the vegetation cover rate (table 4).

**Table 3:** Soil parameters of the six soil types encountered in the sub-catchment 1

Soil type	Soil Cohesion	Deposition rate (m/s)	Sediment density (kg/m <sup>3</sup> )	Soil Density (kg/m <sup>3</sup> )	Soil Depth (m)	Infiltration Min (mm/h)	Infiltration Max (mm/h)
<i>Acrisol peu profond</i>	0.45	0.63	1300	950	0.5	15	67
<i>Acrisol en place</i>	0.45	0.63	1300	950	1.5	15	67
<i>Acrisol s/coll</i>	0.45	0.63	1300	950	1.5	15	67
<i>Cambisol</i>	0.37	1.12	1300	950	0.8	7.5	30
<i>Fluvisol</i>	0.37	1.12	1300	1300	0.3	2.5	18
<i>Leptosol</i>	0.37	1.12	1300	950	0.2	3.7	56
<b>average</b>	<b>0.41</b>	<b>0.875</b>	<b>1300</b>	<b>1008.3</b>	<b>0.8</b>	<b>9.8</b>	<b>50.8</b>

**Table 4:** Estimate of the vegetation cover rate (%) according to the vegetal growth

Land USE	Vegetation cover rate (%)									
	Cat	April	May	June	July	August	September	October	November	December
cassava	1	5	15	60	70	70	70	70	5	5
bracharia	2	30	70	95	95	95	90	70	40	30
planted forest	3	70	85	85	85	85	85	70	70	70
young planted forest	4	30	50	65	65	70	70	70	65	50
old fallow	5	70	85	85	95	95	95	90	85	70
young fallow	6	30	40	70	70	90	90	80	50	50
degraded secondary forest	7	70	95	95	95	95	95	95	70	70
lake	8	0	0	0	0	0	0	0	0	0

streams	9	0	0	0	0	0	0	0	0	0	0	0	0	0	0
---------	---	---	---	---	---	---	---	---	---	---	---	---	---	---	---

**Evapotranspiration (ET; [mm/h])**

The ET is computed with the Penman-Monteith formula thanks to the climatic data collected with the meteorological automatic CIMEL station. According to the computation time step used in PLERv3, it has been estimated every 6 minutes. The real evapotranspiration on sloping lands reached 650 mm/yr to 850 mm/yr (table 5). And the potential evapotranspiration ETP concerning directly the evaporation on free water surface, such as a water reservoir, reached 850 mm/yr to 1150 mm/yr.

**Table 5:** Potential evapotranspiration (ETP), real evapotranspiration (ETR) and total rainfall (RR) in mm recorded by meteorological station in Dong Cao

			Jan	Feb	Mar	Apr	May	Jun	Jul	Aug	Sep	Oct	Nov	Dec	Year	RR
2006	ETP	mm	42	25	39	69	92	109	95	87	97	83	65	41	845	125 2
2006	ET R	mm	2	25	28	32	92	109	95	87	94	49	65	1	679	
2005	ETP	mm	34	32	39	66	121	115	111	90	100	86	51	45	890	183 9
2005	ET R	mm	25	29	39	44	93	115	111	90	100	44	51	34	773	
2004	ETP	mm	30	42	48	57	97	131	106	110	105	106	71	66	969	135 1
2004	ET R	mm	26	33	48	57	97	107	106	110	99	11	60	20	771	
2003	ETP	mm	60	54	72	88	135	145	136	108	95	98	75	54	111 9	158 4
2003	ET R	mm	46	27	10	88	135	145	136	108	95	31	21	7	845	
2002	ETP	mm	52	38	52	90	109	114	129	114	121	92	51	38	999	124 4
2002	ET R	mm	27	16	22	40	109	114	117	101	108	92	51	38	833	

**FROM THE SUB-BASINS OUTLETS TO THE DOWNSTREAM RESERVOIR**

This part of the modelling consists on building a link between the PLER output water flows from the 5 sub-catchments and the water level in the downstream reservoir.

**Assumptions**

**Concerning water flows**

- **A1-** No soil permeability under paddies;
- **A2-** No infiltration in the stream bed during water transport by the main river;
- **A3-** No infiltration inside the downstream reservoir.



**Concerning transport of sediments**

- **A4**- No deposition of sediments in the stream bed during the transport by the main river and by the streams;

- **A5**- During the irrigation's periods: same sediments load (**M1 in mg/L**) in the water used for irrigation from the streams than in water flowing to the reservoir. The irrigation process from streams does not concentrate the water of the streams with sediments (figure 31);

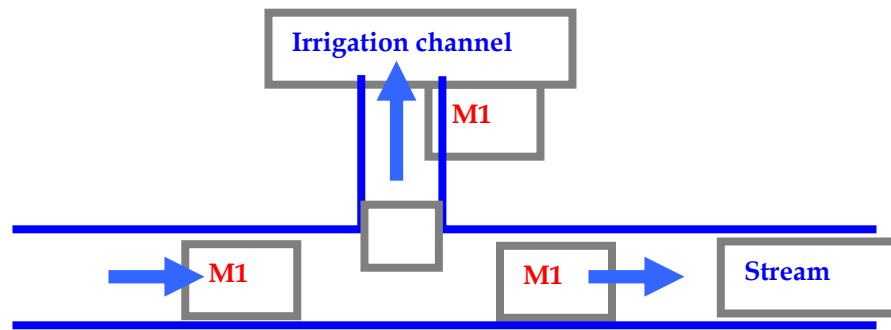

**Figure 31:** Irrigation process from streams and conservation of the sediments load

→ **Consequence:** conserved proportionality between water flow and sediments flow.

- **A6**- All the sediments in the water used for irrigation are depositing in the paddies.

The rice is sown **three times per year** (table 6).

The first seedbed occurs in March. Until June the rice growth is **assured both by rainfall and by an active irrigation process thanks to irrigation channels connected to streams**. The second seedbed occurs in July. Until October the rice growth is **only assured by rainfall**. There's **no active irrigation** during this second growth of the year. The third seedbed occurs in September. Like the first growth, until February the third one is **assured both by rainfall and by an active irrigation process thanks to irrigation channels connected to streams**.

**Table 6:** Active and passive irrigation during the year

Irrigation process	Growth from March to June	Growth from July to October	Growth from November to February
Only rainfall		<b>X</b>	
Rainfall + active irrigation from streams	<b>X</b>		<b>X</b>

The rice paddies represent streams' water storages during the active irrigation periods. The entire catchment's modelling platform takes into account these different periods with a precision of one day.

The new platform has to be used to measure the impacts of up-stream agricultural strategies on the downstream reservoir water balance. The downstream water consumption is based on the paddies cultural seasons. The new platform has to be run during the three cultural seasons underlined in table 6.

### ***Computing of the flows reaching the reservoir***

#### ***Water flow***

The **QA**, **QB**, **QC** and **QD** are the water flows from the sloping sub-basins 1, 2, 3, 4 and 5 and are computed by PLER (figure 32). The **xA**, **xB**, **xC** and **xD** terms correspond to the water flows used to irrigate paddies. The **QrA**, **QrB**, **QrC** and **QrD** are the water flows remaining after the irrigation of the catchment paddies. The **xE** term is the flow used by villages in downstream part (outside of the studied watersheds) for irrigation and human water consumption.

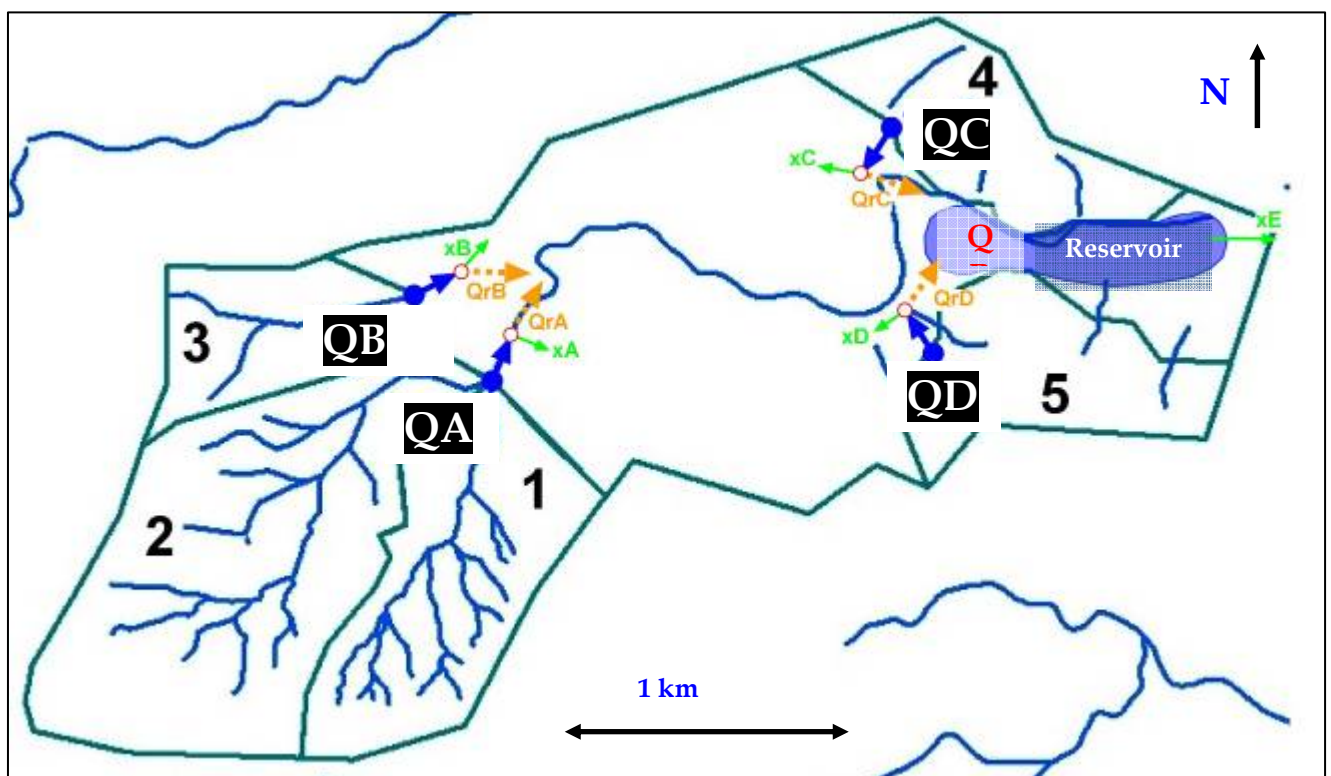

**Figure 18:** Modelling concept of water flows to the downstream reservoir

**NB:** QA is the sum of the water flows from the two sub-basins 1 and 2.

According to the **assumptions A1, A2 and A3**, the net water flow reaching the downstream reservoir can be computed with the following equation (figure 32):

$$QR = \sum_{j=A}^D Qj - \sum_{j=A}^E xj$$

➡ **If there's NO active irrigation,**  
**xj=0 except xE≠0** (drinkable water for downstream villages);

$$QR = \sum_{j=A}^D Qj - xE$$

➡ **If there's an active irrigation,**  
**xj≠0**  $j = A, \dots, E$

$$QR = \sum_{j=A}^D Qj - \sum_{j=A}^E xj$$

### **Sediment flow**

For the sediment flow, we follow the same method than for the runoff.

The **QmA, QmB, QmC and QmD** are the sediments flows from the sloping sub-basins 1, 2, 3, 4 and 5 and are computed by PLER. The **xmA, xmB, xmC and xmD** terms correspond to the sediments flows going to the catchment paddies. The **xmE** term is the sediment flow going to downstream villages (water used for irrigation and drinkable water). The **QmrA, QmrB, QmrC and QmrD** are the sediments flows remaining after irrigation of the catchment's paddies.

**NB:** QmA is the sum of the sediments flows from the two sub-catchments 1 and 2.

## STRUCTURE OF THE NEW PLATFORM UNDER MICROSOFT EXCEL

### Water flows platform

Time step (day)	Runoff (m3/day) (from PLERv3)				Rainfall on paddies (m3/day) (depends on the paddy field surface)				Evapotranspiration + evaporation in paddies (m3/day)				Evaporation at the reservoir surface (m3/day)	Water capacity evolution of paddies (m3)				Irrigation (0: irrigated paddy, 1: no irrigation)			
	Site number				Site number				Site number					A	B	C	D	A	B	C	D
	A	B	C	D	A	B	C	D	A	B	C	D		1000	1000	1000	1000	A	B	C	D
1	200	200	100	100	3	4	5	4	0.5	0.5	0.5	0.5	0.5	937.5	936.5	935.5	936.5	1	0	1	1
2	200	200	100	100	30	60	7	8	0.5	0.5	0.5	0.5	0.5	368	337	383	383	1	1	1	1
3	100	100	50	50	45	67	34	44	0.5	0.5	0.5	0.5	0.5	923.5	870.5	955.5	945.5	1	1	1	1
4	100	100	50	50	0	0	0	0	0.5	0.5	0.5	0.5	0.5	324	871	956	946	1	1	1	1
5	100	100	50	50	0	0	0	0	0.5	0.5	0.5	0.5	0.5	324.5	871	956	946	1	1	1	1
6	100	100	50	50	0	0	0	0	0.5	0.5	0.5	0.5	0.5	325	875	957	947	1	1	1	1
7	100	100	50	50	0	0	0	0	0.5	0.5	0.5	0.5	0.5	325.5	872	957	947	1	1	1	1
8	100	100	50	50	0	0	0	0	0.5	0.5	0.5	0.5	0.5	316	853	947	947	1	1	1	1
9	100	100	50	50	0	0	0	0	0.5	0.5	0.5	0.5	0.5	316.5	853	947	947	1	1	1	1
10	100	100	50	50	0	0	0	0	0.5	0.5	0.5	0.5	0.5	307	833	947	947	1	1	1	1
11	100	100	50	50	0	0	0	0	0.5	0.5	0.5	0.5	0.5	307.5	834	947	947	1	1	1	1
12	100	100	50	50	0	0	0	0	0.5	0.5	0.5	0.5	0.5	308	833	947	947	1	1	1	1
13	100	100	50	50	0	0	0	0	0.5	0.5	0.5	0.5	0.5	308.5	835	947	947	1	1	1	1
14	100	100	50	50	0	0	0	0	0.5	0.5	0.5	0.5	0.5	309	834	947	947	1	1	1	1
15	100	100	50	50	0	0	0	0	0.5	0.5	0.5	0.5	0.5	309.5	834	947	947	1	1	1	1
16	100	100	50	50	0	0	0	0	0.5	0.5	0.5	0.5	0.5	890	823	947	947	1	1	1	1
17	100	100	50	50	0	0	0	0	0.5	0.5	0.5	0.5	0.5	890.5	825	947	947	1	1	1	1
18	100	100	50	50	0	0	0	0	0.5	0.5	0.5	0.5	0.5	891	824	947	947	1	1	1	1
19	100	100	50	50	10	6	7	8	0.5	0.5	0.5	0.5	0.5	891.5	824	947	947	1	1	1	1
20	100	100	50	50	10	6	7	8	0.5	0.5	0.5	0.5	0.5	890	823	947	947	1	1	1	1
21	100	100	50	50	0	0	0	0	0.5	0.5	0.5	0.5	0.5	890.5	825	947	947	1	1	1	1
22	100	100	50	50	0	0	0	0	0.5	0.5	0.5	0.5	0.5	891	824	947	947	1	1	1	1
23	100	100	50	50	10	6	7	8	0.5	0.5	0.5	0.5	0.5	881.5	820	947	947	1	1	1	1
24	100	100	50	50	10	6	7	8	0.5	0.5	0.5	0.5	0.5	872	815	947	947	1	1	1	1
25	100	100	50	50	10	6	7	8	0.5	0.5	0.5	0.5	0.5	862.5	809.5	946.5	938.5	1	1	1	1
26	100	100	50	50	0	0	0	0	0.5	0.5	0.5	0.5	0.5	863	810	947	939	1	1	1	1
27	100	100	50	50	0	0	0	0	0.5	0.5	0.5	0.5	0.5	863	810	947	939	1	1	1	1
28	100	100	50	50	10	6	7	8	0.5	0.5	0.5	0.5	0.5	863	810	947	939	1	1	1	1
29	100	100	50	50	10	6	7	8	0.5	0.5	0.5	0.5	0.5	844	783	946.5	938.5	1	1	1	1
30	100	100	50	50	10	6	7	8	0.5	0.5	0.5	0.5	0.5	844	783	946.5	938.5	1	1	1	1
31	100	100	50	50	10	6	7	8	0.5	0.5	0.5	0.5	0.5	825	783	946.5	938.5	1	1	1	1
32	100	100	50	50	0	0	0	0	0.5	0.5	0.5	0.5	0.5	825	783	946.5	938.5	1	1	1	1
33	100	100	50	50	0	0	0	0	0.5	0.5	0.5	0.5	0.5	825	783	946.5	938.5	1	1	1	1
34	100	100	50	50	10	6	7	8	0.5	0.5	0.5	0.5	0.5	826	783	946.5	938.5	1	1	1	1
35	100	100	50	50	10	6	7	8	0.5	0.5	0.5	0.5	0.5	826.5	783.5	946.5	938.5	1	1	1	1
36	100	100	50	50	10	6	7	8	0.5	0.5	0.5	0.5	0.5	817	784	946.5	938.5	1	1	1	1
37	100	100	50	50	50	6	7	8	0.5	0.5	0.5	0.5	0.5	767.5	778.5	946.5	938.5	1	1	1	1

Outputs of PLERv3 run within the 5 sub-catchments;  
 A: sum of runoffs from the sub-catchments 1 and 2;  
 B, C, D: runoffs respectively from the sub-catchments 3, 4 and 5.

Estimations with Penman-Monteith formula

$$O6 = O5 - F6 + J6$$

To determine the values of the 4 irrigated paddies surfaces, it will be necessary to identify exactly the position of the irrigation channels.  
 After having drawn these 4 paddies groups, each paddies group water capacity will be computed by assuming that paddies water capacity = paddies surface x 20 cm (maximum water height in paddies)

The water capacity of paddies at the end of the time step t+1 is computed from the water capacity at the end of the time step t, the rainfall during the time step t+1, the couple evapotranspiration and evaporation during the time step t+1 and the runoff during the time step t+1.

AF30		fx =SUM(AB30:AE30)													
	W	X	Y	Z	AA	AB	AC	AD	AE	AF	AG				
1	Water flows used for paddies irrigation (m3/d)				Water flow (m3/d) from the reservoir to the downstream villages	Qr water flow going directly to streams (m3/day)				QB Water flow reaching the reservoir (m3/day)	QR (m3/day)				
2	(supposed to be 25 % of the runoff during irrigation periods)														
3															
4	xA	xB	xC	xD	xE	A	B	C	D					Net flow filling the reservoir	
5	50	200	25	25	100	150	0	75	75	300				199.5	
6	50	50	25	25	100	150	150	75	75	450				349.5	
7	25	25	12.5	12.5	100	75	75	37.5	37.5	225				124.5	
8	25	25	12.5	12.5	100	75	75	37.5	37.5	225				124.5	
9	25	25	12.5	12.5	100	75	75	37.5	37.5	225				124.5	
10	25	25	12.5	12.5	100	75	75	37.5	37.5	225				124.5	
11	25	25	12.5	12.5	100	75	75	37.5	37.5	225		AF5 = SUM(AB5:AE5)		124.5	
12	25	25	12.5	12.5	100	75	75	37.5	37.5	225				124.5	
13	25	25	12.5	12.5	100	75	75	37.5	37.5	225				124.5	
14	25	25	12.5	12.5	100	75	75	37.5	37.5	225				124.5	
15	25	25	12.5	12.5	100	75	75	37.5	37.5	225				124.5	
16	25	25	12.5	12.5	100	75	75	37.5	37.5	225				124.5	
17	25	25	12.5	12.5	100	75	75	37.5	37.5	225				124.5	
18	25	25	12.5	12.5	100	75	75	37.5	37.5	225				124.5	
19	25	25	12.5	12.5	100	75	75	37.5	37.5	225				124.5	
20	25	25	12.5	12.5	100	75	75	37.5	37.5	225				124.5	
21	25	25	12.5	12.5	100	75	75	37.5	37.5	225				124.5	
22	25	25	12.5	12.5	100	75	75	37.5	37.5	225				124.5	
23	25	25	12.5	12.5	100	75	75	37.5	37.5	225				124.5	
24	25	25	12.5	12.5	100	75	75	37.5	37.5	225				124.5	
25	25	25	12.5	12.5	100	75	75	37.5	37.5	225				124.5	
26	25	25	12.5	12.5	100	75	75	37.5	37.5	225				124.5	
27	25	25	12.5	12.5	100	75	75	37.5	37.5	225				124.5	
28	25	25	12.5	12.5	100	75	75	37.5	37.5	225				124.5	
29	25	25	12.5	12.5	100	75	75	37.5	37.5	225				124.5	
30	25	25	12.5	12.5	100	75	75	37.5	37.5	225				124.5	
31	25	25	12.5	12.5	100	75	75	37.5	37.5	225				124.5	
32	25	25	12.5	12.5	100	75	75	37.5	37.5	225				124.5	
33	25	25	12.5	12.5	100	75	75	37.5	37.5	225				124.5	
34	25	25	12.5	12.5	100	75	75	37.5	37.5	225				124.5	
35	25	25	12.5	12.5	100	100	100	50	50	300				199.5	
36	SUM (m3)										7350			4234.5	
37															

If S5=1 (irrigated paddies in the paddies group A),  
 $WS = 0.25 \times BS$

If T5=0 (no irrigation in the paddies group B),  
 $X5 = C5$

This value of 25 % should be replaced by more precise data got from farmers

The water flow going directly to streams is QA - xA;

The net flow filling the reservoir is QB - xE;  
 $AG5 = AF5 - AA5$

$AF5 = SUM(AB5:AE5)$

## Sediments flows platform

B6      Jx 200

Time step (day)	Sediments flows (2g/day) (from PLERv3)				Rainfall on paddies (m3/day) (depends on the paddy field surface)				Evapotranspiration + evaporation in paddies (m3/day)				Water capacity evolution of paddies (m3)				Irrigation (0: irrigated paddy, 1: no irrigation)			
	Site number				Site number				Site number				A	B	C	D	A	B	C	D
	A	B	C	D	A	B	C	D	A	B	C	D	1000	1000	1000	1000	A	B	C	D
1	200	200	100	100	3	4	5	4	0.5	0.5	0.5	0.5	997.5	996.5	995.5	996.5	1	0	1	1
2	200	200	100	100	30	60	7	8	0.5	0.5	0.5	0.5	968	937	989	989	1	1	1	1
3	100	100	50	50	45	67	34	44	0.5	0.5	0.5	0.5	923.5	870.5	955.5	945.5	1	1	1	1
4	100	100	50	50	0	0	0	0	0.5	0.5	0.5	0.5	924	871	956	946	1	1	1	1
5	100	100	50	50	0	0	0	0	0.5	0.5	0.5	0.5	924.5	871.5	956.5	946.5	1	1	1	1
6	100	100	50	50	0	0	0	0	0.5	0.5	0.5	0.5	925	872	957	947	1	1	1	1
7	100	100	50	50	0	0	0	0	0.5	0.5	0.5	0.5	925.5	872.5	957.5	947.5	1	1	1	1
8	100	100	50	50	10	20	0	0	0.5	0.5	0.5	0.5	916	876	958	948	1	1	1	1
9	100	100	50	50	0	0	0	0	0.5	0.5	0.5	0.5	916.5	876.5	958.5	948.5	1	1	1	1
10	100	100	50	50	10	20	7	8	0.5	0.5	0.5	0.5	907	876	933	933	1	1	1	1
11	100	100	50	50	0	0	0	0	0.5	0.5	0.5	0.5	907.5	876.5	933.5	933.5	1	1	1	1
12	100	100	50	50	0	0	0	0	0.5	0.5	0.5	0.5	908	876.5	933.5	933.5	1	1	1	1
13	100	100	50	50	0	0	0	0	0.5	0.5	0.5	0.5	908.5	876.5	933.5	933.5	1	1	1	1
14	100	100	50	50	0	0	0	0	0.5	0.5	0.5	0.5	909	876.5	933.5	933.5	1	1	1	1
15	100	100	50	50	10	6	7	8	0.5	0.5	0.5	0.5	899.5	876.5	933.5	933.5	1	1	1	1
16	100	100	50	50	10	6	7	8	0.5	0.5	0.5	0.5	890	876.5	933.5	933.5	1	1	1	1
17	100	100	50	50	0	0	0	0	0.5	0.5	0.5	0.5	890.5	876.5	933.5	933.5	1	1	1	1
18	100	100	50	50	0	0	0	0	0.5	0.5	0.5	0.5	891	876.5	933.5	933.5	1	1	1	1
19	100	100	50	50	10	6	7	8	0.5	0.5	0.5	0.5	881.5	876.5	933.5	933.5	1	1	1	1
20	100	100	50	50	10	6	7	8	0.5	0.5	0.5	0.5	881.5	876.5	933.5	933.5	1	1	1	1
21	100	100	50	50	10	6	7	8	0.5	0.5	0.5	0.5	872	876.5	933.5	933.5	1	1	1	1
22	100	100	50	50	10	6	7	8	0.5	0.5	0.5	0.5	862.5	876.5	933.5	933.5	1	1	1	1
23	100	100	50	50	0	0	0	0	0.5	0.5	0.5	0.5	862	876.5	933.5	933.5	1	1	1	1
24	100	100	50	50	0	0	0	0	0.5	0.5	0.5	0.5	862	876.5	933.5	933.5	1	1	1	1
25	100	100	50	50	10	6	7	8	0.5	0.5	0.5	0.5	854	876.5	933.5	933.5	1	1	1	1
26	100	100	50	50	10	6	7	8	0.5	0.5	0.5	0.5	844.5	876.5	933.5	933.5	1	1	1	1
27	100	100	50	50	10	6	7	8	0.5	0.5	0.5	0.5	83	876.5	933.5	933.5	1	1	1	1
28	100	100	50	50	10	6	7	8	0.5	0.5	0.5	0.5	825	876.5	933.5	933.5	1	1	1	1
29	100	100	50	50	0	0	0	0	0.5	0.5	0.5	0.5	82	876.5	933.5	933.5	1	1	1	1
30	100	100	50	50	0	0	0	0	0.5	0.5	0.5	0.5	826	876.5	933.5	933.5	1	1	1	1
31	100	100	50	50	10	6	7	8	0.5	0.5	0.5	0.5	81	876.5	933.5	933.5	1	1	1	1
32	100	100	50	50	10	6	7	8	0.5	0.5	0.5	0.5	81	876.5	933.5	933.5	1	1	1	1
33	100	100	50	50	50	6	7	8	0.5	0.5	0.5	0.5	767.5	778.5	809.5	855.5	1	1	1	1

**Outputs of PLERv3 run within the 5 sub-catchments:**  
A: sum of sediments flows from the sub-catchments 1 and 2;  
B, C, D: sediments flows respectively from the sub-catchments 3, 4, 5.

**Estimations with Penman-Monteith formula**

**Rainfall measured on the field thanks to the cimel station**

**To determine the values of the 4 irrigated paddies surfaces, it will be necessary to identify exactly the position of the irrigation channels.**  
After having drawn these 4 paddies groups, each paddies group water capacity will be computed by assuming that paddies water capacity = paddies surface x 20 cm (maximum water height in paddies)

**The water capacity of paddies at the end of the time step t+1 is computed from the water capacity at the end of the time step t, the rainfall during the time step t+1, the couple evapotranspiration and evaporation during the time step t+1 and the runoff during the time step t+1.**

**06=05-F6+J6**

	V	W	X	Y	Z	AA	AB	AC	AD	AE	AF	
1	Sediments flows to paddies (kg/day) (supposed to be 25 % of the sediments flow in streams)				Sediments flow (kg/day) from the reservoir to the downstream villages	Qm Sediments flow going directly to streams (kg/day)				QB Sediments flow reaching the reservoir (kg/day)	QmR (kg/day)	
2	zmA	zmB	zmC	zmD	zmE	A	B	C	D		Net sediments flow filling the reservoir	
5	50	50	25	25	10	150	150	75	75	450	440	
6	50	50	25	25	10	150	150	75	75	450	440	
7	25	25	12.5	12.5	10	75	75	37.5	37.5	225	215	
8	25	25	12.5	12.5	10	75	75	37.5	37.5	225	215	
9	25	25	12.5	12.5	10	75	75	37.5	37.5	225	215	
10	25	25	12.5	12.5	10	75	75	37.5	37.5	225	215	
11	25	25	12.5	12.5	10	75	75	37.5	37.5	225	215	
12	25	25	12.5	12.5	10	75	75	37.5	37.5	225	215	
13	25	25	12.5	12.5	10	75	75	37.5	37.5	225	215	
14	25	25	12.5	12.5	10	75	75	37.5	37.5	225	215	
15	25	25	12.5	12.5	10	75	75	37.5	37.5	225	215	
16	25	25	12.5	12.5	10	75	75	37.5	37.5	225	215	
17	25	25	12.5	12.5	10	75	75	37.5	37.5	225	215	
18	25	25	12.5	12.5	10	75	75	37.5	37.5	225	215	
19	25	25	12.5	12.5	10	75	75	37.5	37.5	225	215	
20	25	25	12.5	12.5	10	75	75	37.5	37.5	225	215	
21	25	25	12.5	12.5	10	75	75	37.5	37.5	225	215	
22	25	25	12.5	12.5	10	75	75	37.5	37.5	225	215	
23	25	25	12.5	12.5	10	75	75	37.5	37.5	225	215	
24	25	25	12.5	12.5	10	75	75	37.5	37.5	225	215	
25	25	25	12.5	12.5	10	75	75	37.5	37.5	225	215	
26	25	25	12.5	12.5	10	75	75	37.5	37.5	225	215	
27	25	25	12.5	12.5	10	75	75	37.5	37.5	225	215	
28	25	25	12.5	12.5	10	75	75	37.5	37.5	225	215	
29	25	25	12.5	12.5	10	75	75	37.5	37.5	225	215	
30	25	25	12.5	12.5	10	75	75	37.5	37.5	225	215	
31	25	25	12.5	12.5	10	75	75	37.5	37.5	225	215	
32	25	25	12.5	12.5	10	75	75	37.5	37.5	225	215	
33	25	25	12.5	12.5	10	75	75	37.5	37.5	225	215	
34	25	25	12.5	12.5	10	75	75	37.5	37.5	225	215	
35	25	25	12.5	12.5	10	100	100	50	50	300	290	
36	<b>SUM (m3)</b>										7500	7190

If R5=1 (irrigated paddies in the paddies group A,

If S5=0 (no irrigation in the paddies group B), X5=C5

This value of 25 % should be replaced by more precise data got from farmers

The sediments flow going directly to streams is  $QmA - xmA;$   
 $AB5 = B5 - W5$

$AF5 = SUM(AB5:AE5)$

The net sediment flow filling the reservoir is  $QmB - xmE;$   
 $AG5 = AF5 - AA5$

## *CONCLUSION ON THE NEW MODELING PLATFORM*

A fieldwork is yet necessary **to determine the limits of 4 paddies groups irrigated by runoff from the different sub-catchments**. That means to identify with precision the position of the irrigation channels and their connections.

Then, the second problem is also to determine the flows used for irrigation (**xj with j=A,...,E**). It will be necessary to speak with farmers and to measure these flows to give precision to the computed value of the sediments flow reaching the reservoir.

**This modelling approach has been begun and will be enhanced and tested in the next few months. This modelling platform, which computes flows every day, will be used also to model the nitrogen concentrations in the water filling the reservoir.**



## CONCLUSION

The hydrological PLER model has been built by the MSEC team since 2000 in order to predict the erosion and the runoff at the outlet of sloping catchments with a surface area smaller than 1 km<sup>2</sup>. The modelling way uses the **formula of Manning-Strickler** (computing of the runoff) and the **Guess equation** (computing of the erosion). This modelling way is original because many other models use formulas derived from the Darcy formula to compute the flows of soil sub-surface. The PLERv4 model calibration is going-on and the validation is planned in the next few months.

In order to determine the possibility to apply a PES concept in the area, a second modelling approach has been explored in this project. A **modelling platform** under excel has been developed to predict the water flow and the sediments flow reaching the downstream reservoir of Tien Xuan Commune **using the outputs of PLER model** (runoff and sediments flow) **at the outlets of the five sloping sub-catchments and creates the link to the reservoir through the paddy fields**. Moreover, the active irrigation process is not simple. To predict with precision the flows reaching the downstream reservoir, **more information concerning the irrigation channels network are needed**. A second aim of this platform would be also **to model the daily nitrogen concentrations in water reaching the reservoir** which will increase because of cattle development up-stream. In order to calibrate and validate this first entire catchment scale modelling platform, **PLERv4 has to be calibrated** and applied within the five sub-catchments (*in progress, planed in the few next months*). The **Nitrogen flow is planed to be modelled by adding a function in PLERv4**.

By the other hand, a positive success of a PES framework in Northern Vietnam is assumed thank to the shift to a market economy that has resulted in greater financing needs for farmers and all categories of households use loans (Le Roy and Robert, 1999). Although the region in Vietnam with the highest contribution to national poverty is currently still the Northern mountains, especially in the West side (from 23% in 1993 to 22% in 2002 of the total Vietnamese population) (Rama, 2004), the MSEC research on cattle husbandry rising has proved the great potential dissemination of technologies driven by the economic interest of individual private enterprises.

So the project will specifically assess the efficacy of household biogas production based on human and animal waste, in delivering positive environmental, economic and health benefits for the upland communities. **A key outcome of the on-going study will be quantification of these benefits and the development of an incentive framework that would promote the adoption and out-scaling of this PES orientated approach in the mountainous regions of Vietnam.**

The purpose of this project is to build **a new replicable agro-ecological technology**. The scaling-up potential will be to promote biogas and vermicompost production. The proposed idea offers a novel approach in that it introduces a holistic approach to addressing human health issues and closing the nutrient cycle loop, with socio-economic, sustainable land and water management implications. The technical-scientific challenge in the project is effectively closing the nutrient cycle loop in a manner that enhances production, incomes and the environment. The originality of this approach is the addressing of human health issues through the sustainable utilization of human and animal waste streams with consequent economic benefits to resource poor farmers.

In conclusion, it appears that the concept of payment for environmental services (PES) could be achieved through the production of biogas and compost using simple cost effective household digester systems and will promote a new vision for agricultural and rural development.

## LITERATURE LIST

- Affholder F., Jourdain D., Morize M., Dang Dinh Quang, Ricome A., in press.** Eco-intensification sur les versants montagneux au Vietnam. Contraintes et opportunités d'adoption des SCV par les agriculteurs. *Cahiers d'Agriculture*.
- Asquith N.M., Vargas M.T.R., Smith J., 2002.** Can forest-protection carbon projects improve rural livelihoods? Analysis of the Noel Kempff Mercado Climate Action Project, Bolivia. *Mitigation and Adaptation Strategies for Global Change*, 7: 323–337.
- Baier W., Dumanski J., 1991.** Agroclimatic guidelines and criteria for evaluation of sustainable land management. Proceedings of Int. Workshop: *Evaluation for sustainable land management*, 15-21 September 1991, Chiang Rai, Thailand: 47-83.
- Dang Kim Son, eds, 2008.** *Rural development strategy : outline and workplan*. Ad-Hoc Group, IPSARD (MARD), experts meeting on 16 April 2008, IPSARD, Hanoi, 4 p.
- Castella J.C., Dang Dinh Quang, eds, 2002.** *Doi Moi in the Mountains. Land use changes and farmers' livelihood strategies in Bac an Province, Vietnam*. The Agricultural Publishing House, Hanoi, 283 p.
- Clement F., Amezaga J.M., Orange D., Tran Duc Toan, 2007.** The impact of government policies on land use in Northern Vietnam: an institutional approach for understanding farmer decisions. *IWMI Research Report*, 112, Sri Lanka, International Water Management Inst., 21 p.
- Clement F., Amezaga J.M., Orange D., Calder I., Large A.R.G., Tran Duc Toan, 2008.** Linking reforestation with forest policies: a multi-scale and interdisciplinary methodology applied to Vietnam. *12<sup>th</sup> Biennial Conference of the IASC*, Chetnam, UK, 14-18 July 2008, 28 p.
- Cramb R.A., 2005.** Farmers' strategies for managing acid upland soils in Southeast Asia: an evolutionary perspective. *Agriculture, Ecosystems and Environment*, 106: 69-87.
- IWMI, 2008.** Planning for a watertight future: IWMI at the Davos discussions. *Water Figures (Turning research into development)*, IWMI Ed., Colombo (Sri Lanka), 2008(1): 3.
- Geay F., Dao The Tuan, eds, 2000.** *Appui à l'organisation de la production agricole dans le Nord du Vietnam*. Actes du séminaire de lancement du projet FAC « Programme Fleuve Rouge », Hanoi, 11-13 octobre 1999, VASI-GRET, Maison d'Édition de l'Agriculture, 387 p.
- Le Roy P., Robert Mathias, 1999.** The micro-economic impact of rural credit in northern Vietnam. Collection Etudes et Travaux, Ed. GRET, Paris, 79 p.
- Li T.M., 2002.** Engaging simplifications: community-based resource management, market processes and state agendas in uplands Southeast Asia. *World Development*, 30 (2): 265-283.
- Minang P.A., McCall M.K., Bressers H.T.A., 2007.** Community capacity for implementing clean development: mechanism projects within community forests in Cameroon. *Environ Management*, 39:615–630.
- Noble A., Bossio D.A., Penning de Vries F.W.T., Pretty J., Thiyagarajan T.M., 2006.** Intensifying agricultural sustainability: an analysis of impacts and drivers in the development of “bright spots”. Comprehensive Assessment of Water management in agriculture, Research Report 13, IWMI, 42 p.
- Orange D., Podwojewski P., Tran Duc Toan, Pham Van Rin, Do Duy Phai, Nguyen Duy Phuong, 2007a.** Impact of land-use on bed load transported by rivers in the Dong Cao watershed, north Vietnam. *Water Figures Asia*, issue 1-2007, IWMI, Colombo : 4-5.
- Orange D., Bardouin L., Nguyen Duy Phuong, Loiseau J-B., Clement F., Jouquet P., 2007b.** Le concept de PES pour une gestion durable des eaux et des sols : application au développement de l'élevage et au contrôle environnemental dans le Nord Vietnam. In Orange D., Roose E., Vermande P., Gastellu J.-P., Pham Quang Ha (Eds): *Gestion intégrée des eaux et des sols : ressources, aménagements et risques en milieux ruraux et urbains*, Editions AUF et IRD, Hanoi, *Actes des Premières Journées Scientifiques Inter-Réseaux de l'AUF*, Hanoi, 6-9 novembre 2007, cd-rom : 8p.
- Orange D., Tran Duc Toan, Salgado P., Nguyen Duy Phuong, Nguyen Van Thiet, Clement F., Le Hoa Binh, 2008.** Different interests, common concerns and shared benefits. *LEISA Journal*, Netherlands.
- Orange D., 2008.** Appropriation par les agriculteurs du Nord-Vietnam d'une meilleure gestion de la fertilité des pentes via des collaborations Nord-Sud et CIRA. MSEC project from IWMI-IRD joint-venture, Contribution pour la *Commission de la Recherche Agricole Internationale*, Février 2008, 5 p.

- Pagiola S., Platais G., 2002.** Payments for environmental services. *Environment Strategy Notes*, volume 3.
- Pagiola S., Arcenas A., Platais G., 2005.** Can payments for environmental services help reduce poverty? An exploration of the issues and the evidence to date. *World Development*, 33(2): 237-253.
- Rama M. (Ed.), 2004.** Poverty, Vietnam development report 2004. ADB-AusAID-DFID-GTZ-JICA-SaveChildren-UNDP-WB, Vietnam Development Information Center, Hanoi, 144 p.
- Tomich T.P., Thomas D.E., van Noordwijk M., 2004.** Environmental services and land use change in Southeast Asia: from recognition to regulation or reward? *Agric Ecosystems Envir*, 104: 229–244.
- Tran Duc Toan, Orange D., Podwojewski P., Do Duy Phai, Thai Phien, Maugin J., Pham Van Rinh, 2003.** Soil Erosion and Land Use in the Dong Cao Catchment in Northern Vietnam. In Maglinao A.R., Valentin C., Penning de Vries F. (eds.): *From soil research to land and water management: Harmonizing people and nature*, Proceedings of the IWMI-ADB Project Annual Meeting and 7<sup>th</sup> Management of Soil Erosion Consortium (MSEC) Assembly, held at Vientiane, 2-7 December 2002: IWMI-Southeast Asia Regional Office, Bangkok: 165-180.
- Valentin C., Agus F., Alamban R., Boosaner A., Bricquet J.P., Chaplot V., de Guzman T., de Rouw A., Janeau J.L., Orange D., Phai Do Duy, Podwojewski P., Ribolzi O., Silvera N., Subagyono K., Thiébaux J.P., Toan Tran Duc, 2008.** Runoff and sediment losses from 27 upland catchments in Southeast Asia: Impact of rapid land use changes and conservation practices. *Agriculture, Ecosystems and Environment*, in press.
- Valentin C., Hoogmoed W., Andriesse W., 1991.** Maintenance and enhancement of low-fertility soils. Proceedings of Int. Workshop: *Evaluation for sustainable land management*, 15-21 September 1991, Chiang Rai, Thailand: 157-187.
- Vu Tan Phuong, 2008.** Small scale AR CDM in Viet Nam: A case project in Cao Phong district, Hoa Binh Province of Viet Nam. Presentation at the Second Regional Roundtable “Sustainable Financing: Current Status and Emerging Opportunities” of the Asia Regional Biodiversity Conservation Program, 23-25 January 2008, Vientiane.
- WWF, 2007.** Paying for ecological services: the use of economic tools to deliver conservation goals in Vietnam - A portfolio of projects. Hanoi, WWF.

## Annex 1

### *List of internship reports*

**Loiseau J.B., (2007).** Establishment of a model predicting erosion and runoff at the outlet of a rural catchment in the North Vietnam hills. *National High School for Geology*, IWMI-IRD, SFRI, Hanoi.

**Bardouin L., (2007).** Socio-economic impact of biogas and compost units on the farmers' livelihood of Northern Vietnam (Hoa Binh Province). *ISTOM school*, IWMI-IRD, SFRI, Hanoi.

**Rodriguez C., (2008, on-going).** Ecological impact of animal husbandry within mountainous area of Northern Vietnam: a study case. *University of Clermont-Ferrand, Ecology and GIS*, IWMI-IRD, SFRI, Hanoi.

**Grandidier E., (2008, on-going).** Calibration and validation of an environmental model for PES use within a small agricultural watersheds in Southeast Asia: the environmental point of view. *ENSIL-Limoges*, IWMI-IRD, SFRI, Hanoi.

**Bertrand J., (2008, on-going).** Calibration and validation of an environmental model for PES use within a small agricultural watersheds in Southeast Asia: the hydrological point of view. *ENSEEIHT-Toulouse*, IWMI-IRD, SFRI, Hanoi.

## Annex 2

### WORKPLAN 2007-2008 / PES-MSEC Vietnam (revised Dec 2007)

---

The activities are divided on two workgroups: the WG1 to apply the hydrological modeling, the WG2 to define the modalities for PES actions. Three indicators have been chosen to measure the impact of each scenario: the surface water level, the underground water level and the nitrogen load in the surface waters.

➤ **WG1: Hydrological modeling for PES concept**

- *Task 1.1:* Control of DEM
- *Task 1.2:* Introduction of land-use change each 2 weeks (action on parameters such as vegetation cover, ET, manning coefficient and nutrient losses)
- *Task 1.3:* Validation of PLER and LISEM, applying MIKE SHE
- *Task 1.4:* Addition of gullies to the hydrological pathway
- *Task 1.5:* Running of three scenarios

➤ **WG2: Farmers' demand and PES modalities**

- *Task 2.1:* Inquiries about farmers' demand from upstream and downstream
- *Task 2.2:* Environmental assessment of cattle raising (nitrogen outputs and water balance, water quality assessment within the downstream reservoir)
- *Task 2.3:* Socio-economic and environmental survey of two new biotechnologies to control the nitrogen output (biogas system for waste waters and earthworms compost for solid wastes), socio-economic and environmental modeling
- *Task 2.4:* Cost evaluation within the three studied scenarios
- *Task 2.5:* Conclusion on PES action in Luong Son District

**Team List in 2007:**

DO: Didier Orange (IRD-IWMI, Vietnam), Hydrology, Geochemistry, Modelling, Team management  
NP: Nguyen Duy Phuong (junior researcher, ISF, Vietnam), Socio-economy and Environment, Field management

BY: Bui Tan Yen (junior researcher, ISF, Vietnam), Modelling

PR: Pham Dinh Rinh (agricultural qualified technician, ISF, Vietnam), Hydrology and Socio-economy

THDT: Thierry Henry des Tureaux (qualified technician ,IRD-IWMI, Vietnam), Hydrology. Geochemistry

**JBa: Jean-Baptiste Loiseau (French student, Vietnam), Modelling**

**LB: Lucie Bardouin (French student, Vietnam), Agronomist**

**NM: Ngo Duc Minh (Vietnamese student, Vietnam), Agronomist**

OP: Olivier Planchon (IRD-IWMI, Thailand), Modelling support

AO: Amelia O'Brien (IRD-IWMI, Thailand), Support for socio-economy

**Team List in 2008:**

DO: Didier Orange (IRD-IWMI, Vietnam), Hydrology, Geochemistry, Modelling, Team management

NP: Nguyen Duy Phuong (junior researcher, ISF, Vietnam), Socio-economy and Environment, Field management

BY: Bui Tan Yen (junior researcher, ISF, Vietnam), Modelling

PR: Pham Dinh Rinh (agricultural qualified technician, ISF, Vietnam), Hydrology and Socio-economy

THDT: Thierry Henry des Tureaux (qualified technician ,IRD-IWMI, Vietnam), Hydrology. Geochemistry

**CR: Celia Rodriguez (French student, Vietnam), Environmental assessment**

**EG: Estelle Grandidier (French student, Vietnam), Socio-economic and Environmental Modelling**

**JB: Jeremy Bertrand (French student, Vietnam), Hydrological Modelling**

## Annex 3

### *Current code of the PLER model (jul. 08)*

```
# |=====|
# PLER : Predict and Locate soil Erosion and Runoff at catchment-scale
# |=====|

#! --laddin --matrixtable

binding

DataDir = ".\Inputs\Data";
#=====INPUT=====
#DEFINE SET OF INPUT DATA
TblAspect = ".\Inputs\Data\degrees.tbl";
TblSoilPr = ".\Inputs\Data\SoilProperties.tbl";

#Data table describes field code, type and current development duration of LU in each field
#TblFields = ".\Inputs\Data\Fields.tbl";
TblField = ".\Inputs\Data\Field_LU_CurD.tbl ";
#Data table describes characteristics of each landuse type
TblLandUse = ".\Inputs\Data\LandUse.tbl ";
#Rainfall and ETo at each time step
TssRain = ".\Inputs\Data\Rain_ET.tss";

#DEFINE SET OF INPUT MAP
MapBound = ".\Inputs\Maps\Bound.map"; #Boundary map
MapFields = ".\Inputs\Maps\Fields.map"; #Field map
MapSoil = ".\Inputs\Maps\SOIL.MAP"; #Soil map
MapDEM = ".\Inputs\Maps\DEM.MAP"; #DEM map
#MapStreams = ".\Inputs\Maps\STREAMS.MAP"; #Stream map
MapOutlet = ".\Inputs\Maps\Outlet.map"; #Outlet map
MapClone = ".\Inputs\Maps\Clone.map"; #Clone map

#=====OutPUT=====
#DEFINE SET OF OUTPUT MAP
Map_LUT = ".\outputs\Maps\LandUse.map";#Land use map
MapManning = ".\outputs\LU_manning.map"; #Manning map
MapCover = ".\outputs\LU_cover.map"; #Vegetation cover rate map
#Map_Qmmt = ".\Outputs\Qmmt.map"; #Remaining surface water map
Map_Qf = ".\Outputs\Qf.map"; #Discharge map
Map_e = ".\Outputs\e.map"; #Erosion map
Map_eft = ".\Outputs\eft.map"; #Erosion flux map
Map_Rivdist = ".\Outputs\Rivdist.map"; #Distance to streams map
laddmap = ".\Outputs\Laddmap.map"; #Local drain direction map
Cellsize = ".\Outputs\Cellsize.map"; #Effective cellsize
S_map = ".\Outputs\Slope.map"; #Slope map
subwsheds = ".\Outputs\Subcatchments.map";#Subcatchments maps (1 for each weir)

#DEFINE SET OF OUTPUT data
Tss_eStore = ".\Outputs\eStore.tss"; #Cumulated erosion
Out_tssQt = ".\Outputs\OutQt.tss"; #Cumulated water flow
Out_tssQf = ".\Outputs\OutQf.tss"; #Cumulated discharge
Active_Area = ".\Outputs\Activearea.tss"; #Active area (sum of cell Size)
Manning = ".\Outputs\Manning.tss";
```

```

#accN_loss = 0 ;
#accP_loss = 0 ;
#accK_loss = 0 ;

areamap
MapClone;
timer
1 1211 1;
d10 = 0+10..endtime ; #set the delay between output maps report (every 10 time steps)
d5 = 0+5..endtime ; #set the delay between output maps report (every 5 time steps)
d100 = 0+100..endtime;

# =====
#           Static section
# =====

initial
Mask = MapClone;

d = 360. ; #timestep duration in seconds
D = d / 86400. ; # !!, current timestep duration (days),
#TUnit = 1;

#Define initial values for dynamic variables=====

Qmmt = 0; # Remaining surface water on the watershed (mm)
Qt = 0;
Qf = 0; #Discharge at initial of model (m3/timestep)
e = 0;
eft = 0;
eStore = 0;

#=====Calibration parameters=====

CrustInt = scalar(5) ; # Minimum rainfall intensity (CrustInt, mm/timestep) # !! 50 mm/h
CrustSlope = scalar(0.3) ; # maximum slope (%) enabling crust formation

DeepInfil = scalar(0.15) ; # Ratio deep infiltration capacity / infiltrability (%) (!!0,005)
EffGap = scalar(0.08) ; # % of gaps efficient for water transit (!!0.1)
WpVel = scalar(0.005) ; # Ratio real/computed velocity of the flow / taking into account the water paths
 (!!0,002)
RivMann = scalar(0.02) ; # Manning coefficient for streams (0,01)

#=====

Wat = scalar(1000) ; # Water Density (kg/m3)

#Reads data from table and generate maps=====
# Sediment velocity
sedvelmap = lookupscalar(TblSoilPr,1, MapSoil) ;
# Sediment density (kg/m3)
seddenmap = lookupscalar(TblSoilPr,2, MapSoil) ;
# Soil depth (m)
depthmap = lookupscalar(TblSoilPr,3, MapSoil) ;
# Soil density (kg/m3)
soildenmap = lookupscalar(TblSoilPr,4, MapSoil) ;
# erodibility factor by Rose (cohesive) from 0-1
cohesivemap = lookupscalar(TblSoilPr,5, MapSoil) ;

```

```

#Creates a local drainage direction map
Iddmap = Iddcreate(MapDEM,1e31,1e31,1e31,1e31) ;
Iddmap = Iddrepair(Iddmap) ;

# A boolean map with 1 for stream body and 0 for other cells in the map
tolerance = 10000; #sets the minimum Qbatch value of cells to be included in the streams map
batch = 10; #amount of sample rainfall (mm) to build streams map
Qbatch = accuflux (Iddmap, batch);
StreamMap = boolean(if(Qbatch > tolerance,1,0));
  #report Check_map = Qbatch ; # Check_map allows adjustment of tolerance
StreamMap = boolean(if(MapDEM > 0,cover(StreamMap,0))) ;
#report .\Outputs\StreamMap.map = StreamMap;

# A map with 1 for weir's position and 0 for other cells in the map
# OutletMap = boolean(if(MapDEM > 0,cover(MapOutlet,0))) ;
OutletMap = boolean(MapOutlet) ;
MapOut_ord = ordinal(MapOutlet) ;

#A map showing the catchment area corresponding to each weir
subwsheds = subcatchment(Iddmap,MapOut_ord);
#report .\Outputs\subwsheds.map = subwsheds;

# soil water storage availability (mm)
gapmax = depthmap * 1000 * (1 - soildenmap / seddenmap) * EffGap ;

# Calculate distance from each cell to the streams (m)
Rivdist = if(MapDEM > 0 , cover(Idddists(Iddmap,StreamMap,1) , 1)) ;

#Generate Kc, Manning and vegetation cover rate maps=====
Map_LUT          =lookupscalar(TblField,1,MapFields); #Land use type (or crop type)
Dev1              =lookupscalar(TblLandUse,1,Map_LUT); #Lenght of Dev1 (day) :Initial
Dev2              =lookupscalar(TblLandUse,2,Map_LUT); #Lenght of Dev2 (day) :Development
Dev3              =lookupscalar(TblLandUse,3,Map_LUT); #Lenght of Dev3 (day) :Middle
Dev4              =lookupscalar(TblLandUse,4,Map_LUT); #Lenght of Dev4 (day) :Late
CropDur           =lookupscalar(TblLandUse,5,Map_LUT); #Growth duration = n days when start model
CurDu            =lookupscalar(TblField,2,MapFields); #Current duration of crop (day) on the field

#Crop coefficient at each Development stage (Kc2 = from Kc1 to Kc3)
Kc1 = lookupscalar(TblLandUse,6,Map_LUT);
Kc3 = lookupscalar(TblLandUse,8,Map_LUT);
Kc4 = lookupscalar(TblLandUse,9,Map_LUT);

#Vegetation cover rate at each Development stage (Cov2 = from Cov1 to Cov3)
Cov1 = lookupscalar(TblLandUse,10,Map_LUT);
Cov3 = lookupscalar(TblLandUse,12,Map_LUT);
Cov4 = lookupscalar(TblLandUse,13,Map_LUT);

#Maning coefficient at each Development stage (Mn2 = from Mn1 to Mn3)
Mn1 = lookupscalar(TblLandUse,14,Map_LUT);
Mn3 = lookupscalar(TblLandUse,16,Map_LUT);
Mn4 = lookupscalar(TblLandUse,17,Map_LUT);

# Slope and Slope-length =====
# Slope of plot in %
S = slope(MapDEM) ;
# Aspect of slope  1 = crossed; 0 = Straight
Aspect = aspect(MapDEM) ;
# Angle, defines way of computing size of cells

```



```

Angle = lookupboolean(TblAspect, Aspect) ;
# Computes celllength (m)
Length = celllength() ;
# Size of sloping plane (m2)
Size = sqr(Length)*(sqrt(1+sqr(S))) ;
# cell slope-length (m)
L = if(Angle, sqrt(2*sqr(Length)*(1+sqr(S))), Size / Length) ;
# Slope length from each cell to the outlet (m)
SL = if(MapDEM > 0 , cover(loddist(lddmap, OutletMap, L/2) , 1)) ;
# Active ground-Area of the watershed (m2)
A = maptotal(Size);

# Deep infiltration capacity map (mm/h)
# assuming it's proportional to slope > 20% and
# deepinfil % x infiltrability
InfilMin = lookupscalar(TblSoilPr,6, MapSoil) * DeepInfil ;
InfilMax = lookupscalar(TblSoilPr,7, MapSoil) * DeepInfil ;
InfilMin = if(S < 0.2 , 0.2 * InfilMin , S * InfilMin) ;
InfilMax = if(S < 0.2 , 0.2 * InfilMax , S * InfilMax) ;

#calculates the upstream drainage area for each cell
drainarea = catchmenttotal(sqr(Length),lddmap);
gulllike = ln(drainarea / S) ;
#report .\Outputs\gulllike.map = gulllike ;

# =====
#           Dynamic section
# =====

#T= (time()-1)*D/TUnit;#Increment of crop duration by time step

#Change LU map if running model for long time period
#Map_LUT           =if(T=xxx, lookupscalar(TblField,1,MapFields),Map_LUT);

#CurDu           =CurDu + T; #Current duration of crop (day) on the field
#Current development stage (If current Dev. stage is longer than Dev4 then considered as Dev4)
#CurDu = if(CurDu > (Dev1+Dev2+Dev3+Dev4),(Dev1+Dev2+Dev3+Dev4),CurDu);

#CurDev           = if(CurDu <= Dev1,1)* MapBound;
#CurDev           = if(CurDu >Dev1 and CurDu <= (Dev1+Dev2),2,CurDev)* MapBound;
#CurDev           = if(CurDu >(Dev1+Dev2) and CurDu <= (Dev1+Dev2+Dev3),3,CurDev);
#CurDev           = if(CurDu > (Dev1+Dev2+Dev3),4,CurDev);           #Crop development stage
(Dev1=Ini; Dev2=Dev.; Dev3= Mid; Dev4=Late)

#Calculate Kc, Cov, Mn based on current development satage (CurDev)
#Kc = lookupscalar(TblLandUse,CurDev+5,Map_LUT);
Kc = lookupscalar(TblLandUse,8,Map_LUT);
#Kc = if(CurDev eq 2,(Kc3-Kc1)/Dev2*(CurDu-Dev1)+Kc1,Kc);
#Kc = if(CurDev eq 4,(Kc4-Kc3)/(Dev4)*(CurDu-Dev1-Dev2-Dev3)+Kc3,Kc);
MapKc = Kc;

#~Cov = lookupscalar(TblLandUse,CurDev+9,Map_LUT);
#~Cov = if(CurDev eq 2,(Cov3-Cov1)/Dev2*(CurDu-Dev1)+Cov1,Cov);
#~Cov = if(CurDev eq 4,(Cov4-Kc3)/(Dev4)*(CurDu-Dev1-Dev2-Dev3)+Cov3,Cov);
#~MapCover = Cov;

```

```

#Mn = lookupscalar(TblLandUse,CurDev+13,Map_LUT);
Mn = lookupscalar(TblLandUse,16,Map_LUT);
#Mn = if(CurDev eq 2,(Mn3-Mn1)/Dev2*(CurDu-Dev1)+Mn1,Mn);
#Mn = if(CurDev eq 4,(Mn4-Mn3)/(Dev4)*(CurDu-Dev1-Dev2-Dev3)+Mn3,Mn);
MapManning = Mn;

```

dynamic #to be moved on top when mn & kc become dynamic

```

# Rainfall (mm/h) per time step
# !!!! R = timeinputscalar(TssRain,1)* D/ TUnit ;
R = timeinputscalar(TssRain,1);
# Actual Evapotranspiration (ETc = ETo*Kc) (mm/h) per time step
# !!! ETc = timeinputscalar(TssRain,2) * Kc* D/ TUnit;
ETc = timeinputscalar(TssRain,2) * Kc ;

```

```

# =====
#           Discharge computation section
# =====

```

```

# Water content in each cell after rainfall (mm)
Qmmt = Qmmt + R ; # Water reservoir on/in each cell after rainfall (mm)

```

```

# Infiltration map mm), assuming it's sqrt (water stock)
# !!! infilmap = if(Qmmt > gapmax, InfilMax *D/TUnit,InfilMax * sqrt(Qmmt/gapmax) * D/TUnit) ;
infilmap = if(Qmmt > gapmax, InfilMax / 3600 * d,InfilMax / 3600 * d * sqrt(Qmmt/gapmax)) ;
# Assuming when rainfall intensity > crustint mm/h and slope < crustslope %
#crust is formed
infilmap = if(R > CrustInt and S < CrustSlope , 0 , infilmap);
# !!! infilmap = if(R/D*TUnit > CrustInt and S < CrustSlope , 0 , infilmap);

```

```

# Evapotranspiration, assuming it's proportional to sq (water stock) (mm)
ETc = if(Qmmt > gapmax, ETc , ETc * sqrt(Qmmt/gapmax)) ;

```

```

# Water remaining in each cell after infiltration and ETc (mm)
Qmmt = if(Qmmt - infilmap - ETc < 0 , 0 , Qmmt - infilmap - ETc) ;

```

```

# Height of the water on each cell (mm)
# !!! Hmm = Qf / Size * D * 1000 + Qmmt ;
Hmm = Qf /Size * 1000 + Qmmt ;

```

```

# Saturation of cells (% remaining storage capacity)
#Sat = 100 * Hmm / (depthmap * 1000) ;

```

```

# Velocity of the flow in one cell (m/s) assuming manning coefficient of stream is rivmann
# and minimum velocity = one day to cross one cell
#V = if(Rivdist < 1 , sqrt(S) / RivMann * sqr(Hmm/gapmax) * (Hmm/1000)**(2/3) * WpVel ,sqrt(S) /
MapManning * sqr(Hmm/gapmax) * (Hmm/1000)**(2/3) * WpVel) ;

```

```

V = if(Rivdist < 1 , sqrt(S) / RivMann * (Hm/1000)**(2/3) * WpVel , sqrt(S) / MapManning *
sqr(Hm/gapmax) * (Hm/1000)**(2/3) * WpVel) ;
#V = if(V > L/24/TUnit , V , L/24/TUnit) ;
V = if(V > L/86400 , V , L/86400) ;

# Time taken by the flow to cross one cell (second)
Tcross = L / V ;

# Time to reach the weir (second)
Tm = ldddist(lddmap, OutletMap, Tcross / Length) ;

# Part of the flow reaching the weir (%) in one timestep
# !!! P = if(MapDEM > 0 , cover(if(D / Tm > 1 , 1 , D / Tm) , 1)) ;
P = if(MapDEM > 0 , cover(if(d / Tm > 1 , 1 , d / Tm) , 1)) ;

#Discharge (cumulated run-off) (m3/timestep) !!!(m3/s)
# !!! Qf = accuflux (lddmap, Qmmt * P) / 1000 * Size / D ;
Qf = accuflux (lddmap, Qmmt * P) / 1000 * Size ;

# Total runoff (m3)
# !! Qt = Qt + Qf * D ;
#Qt = Qt + Qf ;

# Remaining water in cell for next pitch (mm)
Qmmt = Qmmt * (1 - P) ;

# =====
#           Erosion computation section
# =====

# factor k, formed by substituting formula for transport
#~k = ((seddenmap*S*(L**-0.4))/(((seddenmap/Wat)-1)*sedvelmap))
#~ *(((S**0.5)/MapManning)**0.6) ;
#~ex = 0.001*((k**cohesivemap)*(R**(0.4*cohesivemap))*Qf*exp(-1/MapManning*MapCover)) * 10000 /
Size ;
#~e = e + ex ;
#~report Map_e = e ;
#~ec = k*(Qf**0.4)*exp(-1/MapManning*MapCover) ;
#~Cap = 0.001 * k*(Qf**0.4)*exp(-1/MapManning*MapCover) * Qf * D ;
#~eflux = accucapacityflux(lddmap,ex,Cap) ;

#~report Map_eft = eft + eflux ;
#~report Map_eStore = eStore + accucapacitystate(lddmap,ex,Cap) ;

#report MapEstore = log10(log10(eStore+1)+1) ;

# =====
#           Reporting section
# =====

report Out_tssQf = timeoutput(MapOut_ord,Qf) ;
#report gapmax = gapmax ;
#report drainarea = drainarea ;
#report (d10) Map_Qfi = Qf ;
#report manning = MapManning ;

```

```
#report Out_tssQt = timeoutput(MapOut_ord,Qt) ;  
#report Active_area = A ;  
#report (d10) Map_Vi = V ;  
#report (d10) hmngap = sqr(Hmm/gapmax)  
#report Map_Pi = P ;  
#report Map_Qmmt = Qmmt ;  
#report Map_sat = Sat ;  
#report Hmm_map = Hmm ;  
#report S_map = S ;  
#report lddmap = lddmap ;  
#report Cellsize = Size ;
```

## Annex 4

*Orange et al. (2007). Actes des Premières Journées Scientifiques Inter-Réseaux de l'AUF, Hanoi, 6-9 novembre 2007, Editions AUF et IRD, cd-rom : 6p.*

### **Le concept de PES pour une gestion durable des eaux et des sols : application au développement de l'élevage et au contrôle environnemental dans le Nord Vietnam**

**Didier ORANGE<sup>1,2,\*</sup>, L. BARDOUIN<sup>1,2</sup>, NGUYEN Duy Phuong<sup>2</sup>,  
J.-B. LOISEAU<sup>1,2</sup>, F. CLEMENT<sup>1,2,3</sup>, P. JOUQUET<sup>2,4</sup>**

<sup>1</sup> UR176 SOLUTIONS, IRD, seconded IWMI-SEA, 32 Avenue H. Varagnat, 93143 Bondy Cedex, France

<sup>2</sup> Soils and Fertilizers Institute (SFI), Dong Ngac, Tu Liem, Hanoi, Vietnam

<sup>3</sup> CLUWRR, Newcastle University, England

<sup>4</sup> Lab. Ecologie des Sols Tropicaux, IRD, UMR 137 Biosol, Bondy, France

E-mail : [orange@ird.fr](mailto:orange@ird.fr)

#### **Abstract**

#### ***PES concept for a sustainable water and soil management: applying to cattle husbandry rising and environmental control in Northern Vietnam***

In Northern Vietnam, the urgent environmental problems are soil erosion under annual crop on sloping lands leading to a drastic soil fertility decrease, inducing the risk to unfertilize the flatlands and to fill up the water reservoirs in the downstream part by sediment accumulation. Then a lack of disposable income for the purchase of inorganic fertilizers has resulted in farmers in Northern Vietnam resorting to the utilization of raw animal and human waste in order to fertilize their cropping systems. This project is dealing at the District level in the Northward of Hoa Binh Province with the PES use (agro-ecological concept of *Payment for Environmental Services*) based on a new market opportunity for the farmers of Northern Vietnam to mobilise the integrated cattle husbandry enhancement and water management between uplands and lowlands. The purpose is to create a sustainable loop between fodder cropping on sloping lands, the cattle development under stables, the animal and human waste management, leading to human health and water quality protections, to the erosion sediment control for both a sustainable upland and lowland use. The proposed project offers a novel approach in that a holistic approach is introduced to achieve income generation from livestock manure management in mountainous environment of Southeast Asia in establishing a process of comprehensive assessment, of mutual learning between farmers from upper part and down part of the watershed through a hydrological modelling platform, and by the development of new agricultural technologies as biogas digester and vermicompost unit.

**Mots clés :** Gestion durable, Erosion, Pollution, Elevage, PES, Biogas, Vermicompost, Vietnam

#### **Introduction**

Dans le Nord Vietnam, l'usage des collines et petites montagnes aux pentes souvent fortes (majoritairement supérieures à 40%) pour des cultures annuelles (selon la séquence riz, maïs, manioc en fonction de la perte de fertilité du sol) a provoqué une érosion forte entraînant une dégradation des sols interdisant à terme toutes cultures annuelles rentables (Maglinao *et al.*, 2003 ; 2003 ; Toan *et al.*, 2004 ; Castella *et al.*, 2005). Or comme dans la plupart des régions montagneuses du Sud-Est asiatique, les aménagements pour la gestion de l'eau sont très répandus, la multiplicité des réservoirs d'eau (de tailles différentes selon leur localisation entre l'amont et l'aval du bassin versant) permet une utilisation optimale de l'eau pour l'irrigation des terres cultivées en aval (riziculture essentiellement) mais aussi l'alimentation en eau des habitations. L'érosion des pentes représente un risque majeur pour ces aménagements : comblement des réservoirs par accumulation de sédiments, pollution des eaux. De plus, une pratique courante est

l'utilisation des déjections animales et humaines pour la fertilisation des sols, induisant de graves problèmes de santé publique relevés dans tout le Nord du Vietnam et dans le Sud de la Chine (Phuc *et al.*, 2006) mais aussi de forts risques de pollution des eaux des barrages (Smit et Nasr, 1992). L'utilisation de ce type de fumure est due à trois raisons qui restent liées entre elles : manque d'engrais organiques de type fumier, manque de revenus et absence d'installations sanitaires (latrines). Dans ce contexte, développer des pratiques agricoles pour de petits exploitants permettant d'une part, la durabilité des systèmes de cultures sur pente et d'autre part, prenant en compte l'amélioration de la qualité particulaire et dissoute des eaux d'écoulement pour son utilisation en aval est un défi actuel majeur.

Le projet MSEC a prouvé l'intérêt de la culture fourragère sur les terres de pente pour contrôler les phénomènes d'érosion et de perte de fertilité des sols (Orange *et al.*, 2007). Sur la base de ces résultats de recherche et en fonction de la politique agricole appliquée dans la région, l'étude présentée ici s'interroge sur l'intérêt de l'utilisation du concept de *Payment for Environmental Services* (Gutman, 2003 ; Wunder, 2005 ; Swallow, 2006) pour le développement de la culture sur pente des produits fourragers et de l'élevage en étable afin d'une part, de protéger les sols contre l'érosion et d'autre part, de gérer les excréments animaux et éviter ainsi les pollutions des eaux d'écoulement et des eaux de barrage. Le projet inclue alors l'expérimentation de mécanismes qui permettront aux exploitants situés en aval (ou autres acteurs affectés par les pratiques agricoles des exploitants situés en amont) de participer contractuellement aux efforts des exploitants amont à une meilleure gestion de leurs systèmes agraires pour une protection environnementale des eaux de barrage aval. Plus concrètement, la question est de savoir comment mobiliser les petits exploitants de l'aval à payer des services environnementaux (écosystémiques) afin de motiver les exploitants de l'amont à gérer durablement sols et eaux.

### **Contexte géographique et socio-économique**

La zone expérimentale de 8 km<sup>2</sup> centrée sur le village de Dong Cao (fig. 1) se situe dans le district de Luong Son de la province de Hoa Binh, à 60 km à l'Ouest de la ville d'Hanoi, dans la commune de Tien Xuan qui compte une quinzaine de villages. C'est une région de petites montagnes et collines fortement exploitées depuis une trentaine d'années. Les bas-fonds sont annuellement utilisés par deux cycles de culture irriguée de riz et un cycle de légumineuses alors que les pentes sont traditionnellement utilisées pour le maïs et le manioc. La pluviométrie, entre 1200 et 2000 mm par an, connaît de fortes variations interannuelles, en particulier au niveau de la distribution saisonnière des averses. Les sols des versants (en majorité des acrisols) sont engagés aujourd'hui dans un cycle de dégradation rapide, engendré par les phénomènes d'érosion liés aux pratiques intensives de cultures annuelles (Toan *et al.*, 2004). Depuis les années 2000, les collines se reforestent (Clément *et al.*, 2006) et l'élevage bovin se développent conduisant à une augmentation importante du cheptel et des changements d'usage rapides des pentes. Ces initiatives sont en partie dues à des programmes incitatifs du gouvernement (programme de reforestation, programme de promotion de l'élevage), mais aussi par la perte de rendements du manioc sur ces terres dégradées et la disparition d'une gestion collective des terres (Clément *et al.*, 2007). L'absence de politique de partage des eaux et de règles collectives de mise en pâture des terrains laisse présager des conflits d'usage dans un futur proche. Le bassin étudié culmine à 450 m, les eaux d'écoulement sont utilisées dans les zones basses pour l'irrigation du riz par les habitants de l'amont (notamment les agriculteurs du village de Dong Cao) puis les eaux sont ensuite collectées dans un réservoir à 3 km de là pour l'irrigation d'hiver des zones situées à l'aval du barrage par les agriculteurs du village aval (fig. 1).

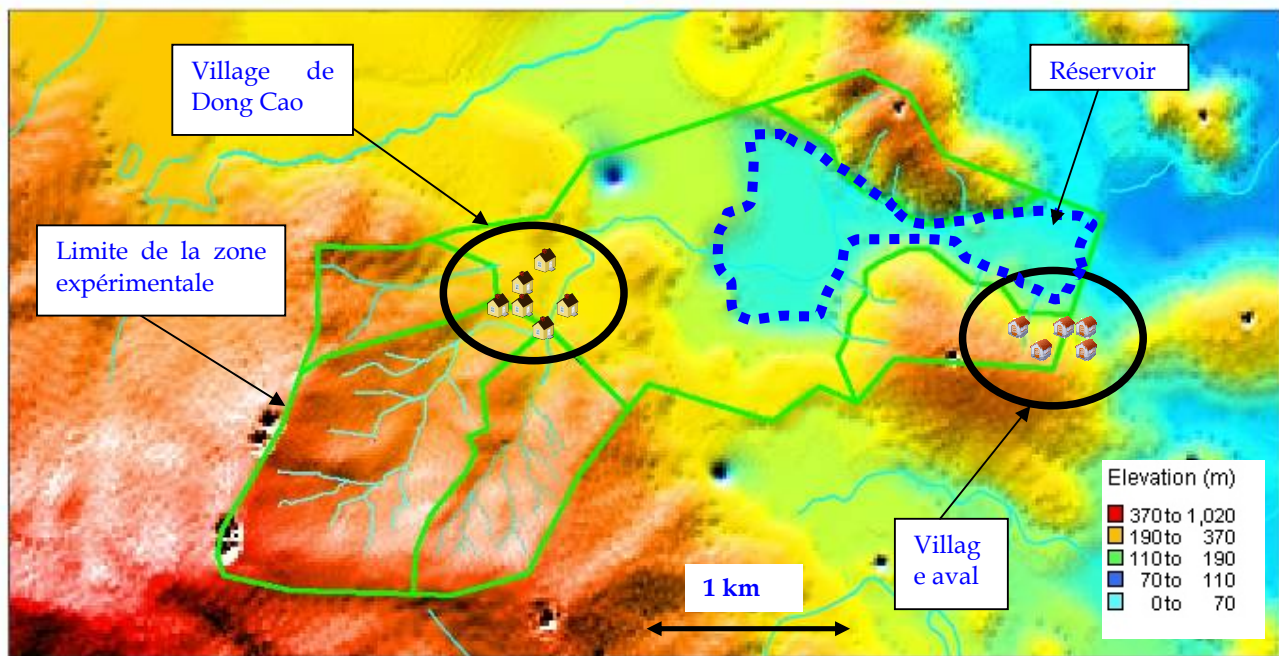

Figure 1 : Carte de situation de la zone expérimentale (bassin versant de 8 km<sup>2</sup> délimité en trait vert).

### Agronomie, Agro-écologie et PES

Le concept des PES (Balmford et Whitten, 2003 ; Wunder, 2005) est basé sur le principe suivant : « les utilisateurs de ressources et les collectivités qui sont en mesure de fournir des services écologiques doivent recevoir une compensation, et ceux qui bénéficient de ces services doivent les payer » (Wunder, 2005). Il n'existe pas de définition généralement convenue des systèmes de PES, mais plutôt une série de classifications reposant sur le type de services environnementaux, la portée géographique, la structure des marchés ou le type de paiement utilisé. Cette absence de définition ou de classification commune témoigne de la grande diversité des modèles existants. Elle crée également une certaine confusion et un manque de précision dans la littérature en ce qui concerne les systèmes devant être considérés *sensus stricto* comme des paiements de services environnementaux. Les marchés pour les services de protection des bassins hydrographiques, qui ne font pas intervenir l'échange de « produits » tels que la quantité ou la qualité d'eau, mais plutôt le financement des « utilisations » des terres qui génèrent des avantages hydrographiques (Kerr, 2002 ; Pagiola *et al.*, 2005) en sont un parfait exemple. En résumé, la bibliographie s'entend pour dire que les systèmes de PES sont parfaitement efficaces lorsque les services sont visibles, que les bénéficiaires sont bien organisés, et que les collectivités utilisant les terres sont bien structurées, possèdent des droits de propriété clairs et protégés, utilisent un cadre juridique solide et sont relativement riches ou ont accès aux ressources (Wunder, 2005).

### Actions sur le terrain et discussion

#### 1. Hypothèses de départ

Les différentes enquêtes menées auprès des villageois de la commune de Tien Xuan ont montré que ni la baisse de fertilité des sols de pente ni leurs risques d'érosion n'influaient en priorité sur les stratégies paysannes qui sont avant tout opportunistes, très liées aux lois du marché et basées sur une perception locale de l'environnement (Clément, 2006). Il en résulte un pragmatisme qui permet des changements d'usage rapides et spectaculaires (Clément *et al.*, 2005 ; Noble *et al.*, 2006). Aussi au lieu de construire notre intervention sur une distinction entre connaissances locales et connaissances scientifiques, qui est en fait une construction abstraite souvent diffusée par la communauté scientifique (Forsyth, 1996), notre hypothèse de travail fut que les différents intervenants (de l'amont et de l'aval, et les décideurs) prouvent -- aient pour volonté -- la durabilité des fonctions écosystémiques de leur région, se traduisant concrètement en terme de

rentabilité des terres et des eaux (« gagner plus ? »), d'accès à la modernité (électricité, chauffage,...) et à la santé (« vivre mieux »).

Le schéma d'action suivant a ainsi été conçu (fig. 2). Dans le village de Dong Cao et les villages alentours de la commune de Tien Xuan, les collines sont laissées en pâture libre aux bovins de plus en plus nombreux, provoquant conflits entre agriculteurs voisins et mobilisant une érosion linéaire nouvelle. Les risques hors-sites immédiats sont alors une aggravation du comblement de la retenue d'eau en aval et une pollution accrue des eaux d'écoulement par les déjections animales. Aussi l'application du concept de PES veut créer un lien contractuel entre les usagers de la retenue à l'aval et les usagers des collines à l'amont afin que ces derniers vendent aux premiers la protection environnementale des eaux d'écoulement de l'amont. Cependant, il reste à trouver la bonne « formulation » pour motiver les différents dépositaires.

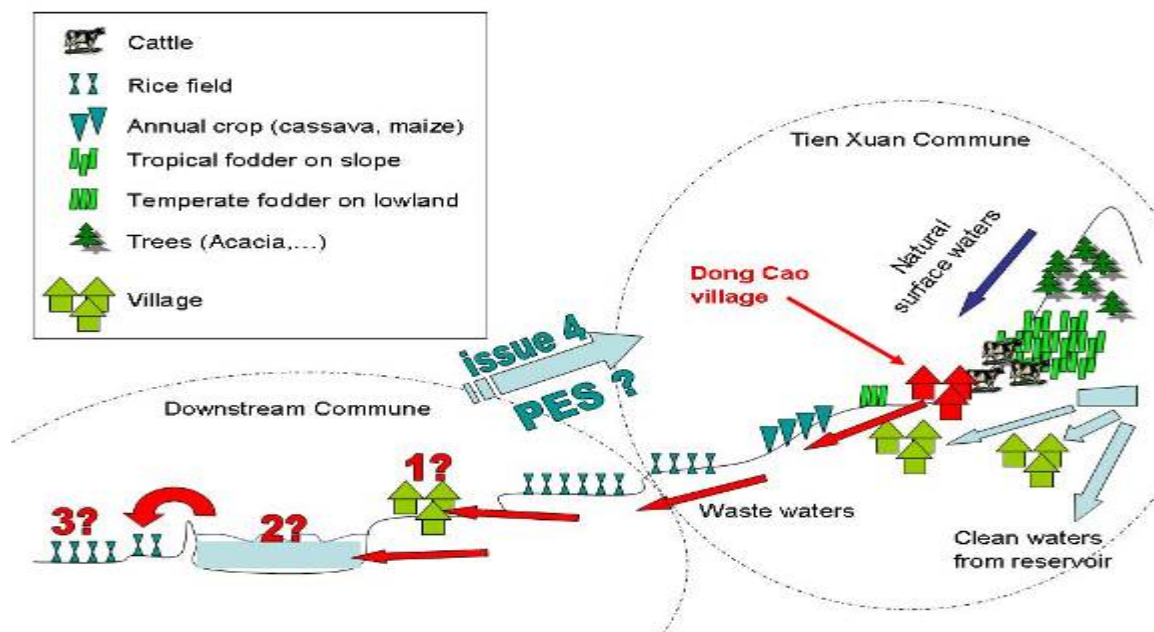

Figure 2 : Schéma d'action du concept de PES montrant les liens entre utilisateurs amont et utilisateurs aval des services écosystémiques. 1: impact sur la santé; 2: impact sur la qualité de l'eau et sédimentation; 3: impact sur les rendements agricoles; 4: comment appliquer le concept de PES pour créer une boucle de rétroaction afin de garantir un développement durable des systèmes agraires amont et aval.

## 2. Recherche-action : Biogas et vermicompost

Fort du pragmatisme local, l'application des PES est testée par le biais de la diffusion de deux nouvelles technologies de gestion des déjections animales permettant d'apporter aux agriculteurs des revenus nouveaux et d'améliorer leur qualité de vie : les unités de biogaz (Hobson et Fielden, 1982 ; Sommer et Husted, 1995) et de vermicompost (Arancon *et al.*, 2005 ; Padmavathiamma *et al.*, 2007). La transaction contractuelle possible serait la participation aux frais des bénéficiaires amont par les utilisateurs aval, pour la construction de ces installations chez les exploitants concernés. Ces deux technologies peuvent également contrer l'effet de déboisement lié à la recherche de bois de chauffage et donc d'énergie. La production de biogaz assure ce dernier point en fournissant du gaz pour la cuisine mais aussi de l'électricité. Le résultat du vermicompost, outre outre la production de vers pour l'alimentation du petit élevage (porcs, volailles), donne un engrais riche en nutriments qui peut facilement remplacer ou compenser l'utilisation d'engrais chimiques. Enfin, ces techniques nécessitent un élevage en étable, ce qui permet de ne plus laisser les animaux en divagation sur les pentes, ce qui était source de conflits de voisinage et d'érosion. Ces deux procédés permettent ainsi la concentration des déchets d'élevage au même endroit, limitant et évitant la diffusion de leurs pouvoirs polluants en particulier dans la rivière, source principale d'eau potable de la population et alimentant le réservoir et les rizières de bas fond. Ils permettent la production d'engrais organiques et azotés qui peuvent constituer la base de la



fertilisation d'une exploitation (pour le riz, manioc et jardin familial) ou tout du moins la compléter, ce qui diminuera considérablement les coûts en achat d'engrais chimiques.

### *3. Modélisation hydrologique et plateforme de concertation*

Enfin, le dernier terme de cette étude est l'utilisation de la modélisation hydrologique acquise dans le projet MSEC (Do Duy Phai *et al.*, 2006) pour explorer l'utilisation potentielle de ce concept de PES par la construction d'une plateforme de simulations répondant à la fois aux forçages climatiques, biophysiques et d'usage des sols. Cette plateforme permet donc la construction de scénarios d'usage répondant aux attentes et interrogations des usagers et décideurs régionaux. En ce sens, elle est une plateforme de concertation et peut être considérée comme un outil d'aide à la gestion environnementale pour assister à la fois les décideurs régionaux et les décideurs locaux que sont les agriculteurs (Poncet *et al.*, 2001 ; Orange, 2002). Elle répond aux exigences mises en exergue par Clément et Amezaga (2007) pour la réussite d'un développement agricole durable dans le Nord Vietnam, à savoir permettre le choix des stratégies agricoles aux petits exploitants locaux en connexion avec les instances régionales de vulgarisation des politiques agricoles gouvernementales. Outre de quantifier les pertes en sol, les disponibilités en eau de surface et les flux d'azote, cette plateforme aura également pour composantes : (1) d'évaluer les coûts à court terme des stratégies agricoles, (2) de comparer les coûts environnementaux et économiques à moyen terme entre agriculteurs amont et agriculteurs aval, et (3) de simuler l'impact des stratégies de PES sur les revenus agricoles et sur les fonctions écosystémiques.

### **Conclusion**

L'objectif global de ce projet de recherche est d'évaluer la possibilité d'un développement agricole durable et socialement acceptable, qui soit porté par les communautés locales et basé sur l'acceptation d'une participation locale aux coûts des services environnementaux. Il est évident que cette démarche ne peut être atteinte que de manière indirecte. Ainsi la méthode promue consiste à proposer de nouvelles techniques agro-écologiques (biogaz et vermicompost) en étant persuadé que le potentiel de diffusion sera fortement lié aux intérêts économiques des individus engagés dans le processus. En résumé, on ne parle pas de « lutte contre l'érosion » ni de « lutte contre la pollution des eaux », mais de production de biens agricoles, de rentabilité économique de l'usage du sol et de l'eau et de facilité d'accès au bien-être (cuisine, santé). La méthode originale est de coupler la démarche de recherche fondamentale sur les processus biophysiques et écologiques de ces nouvelles techniques avec une mise en évidence des avantages économiques et écologiques auprès des individus cibles via un modèle de simulations servant de plateforme de concertation. Cette plateforme réalise des simulations de scénarios d'usage traduisant en termes de gains et pertes les impacts respectifs des stratégies d'usage de la ressource eau et sol des usagers de l'amont et de l'aval. L'idée est de mettre en exergue la meilleure option individuelle pour une gestion durable commune des sols et des eaux.

Enfin par cet exemple, il apparaît que le concept de PES participe à redéfinir un nouvel équilibre économique d'une agriculture productive et respectueuse de la nature par la rétribution des services environnementaux dans la cadre d'une politique contractuelle largement basée sur un consensus entre acteurs locaux. On peut espérer que cette première étape de l'agro-écologie nous conduise vers une acceptation des coûts écologiques par la société rurale vietnamienne du Nord, tels que la fourniture et la régulation de l'eau, l'épuration de l'eau, la formation des sols et les services récréatifs, pour ne citer que ceux directement concernés par les sociétés paysannes des zones montagneuses d'Asie du Sud-Est. Par ailleurs, il est à noter que les PES offrent l'opportunité d'intégrer l'élevage dans un concept de développement durable en terme agro-écologique en créant de nouveaux liens entre utilisateurs amont et aval du bassin versant. La pertinence de cette approche se trouve dans la création d'un marché novateur pour les petits agriculteurs du Nord Vietnam.

### **Remerciements**

Cette action de recherche est réalisée dans le cadre du programme MSEC de l'IWMI coordonnée par l'unité de recherche IRD-UR176 (SOLUTIONS) de Christian Valentin, avec un soutien financier spécifique PES du CPWF thème 2 (Challenge Program for Water and Food) dans le cadre de l'action "Exploring the relevance and feasibility of PES approaches for producing environmental services through changes in agricultural practices: a case study in the Mekong Region" (contrat C-056-07). Nous remercions aussi le soutien financier de l'entreprise TOTAL au Vietnam dans le cadre du programme "Project on Innovative Practices for Environment and Human Health: A Pilot Phase in Northern Vietnam".

## Bibliographie

- Arancon N.Q., Edwards C.A., Bierman P., Metzger J.D., Lucht C. (2005). Effects of vermicomposts produced from cattle manure, food waste and paper waste on the growth and yield of peppers in the field. *Pedobiologia*, 49(4) : 297-306.
- Balmford A., Whitten T. (2003). Who should pay for tropical conservation, and how could the costs be met? *Oryx*, 37(2): 14.
- Castella J.C., Boissau S., Trung T.N., Quang D.D. (2005). Agrarian transition and lowland-upland interactions in mountain areas in northern Vietnam: application of a multi-agent simulation model. *Agricultural Systems*, 86 (3), 312-332.
- Clément F. (2006). How do farmers make decisions in a land degradation context ? Sustainable watershed management in cultivated sloping lands of SEA. *Proceedings of the 2nd International Conference on Sustainable Sloping Lands and Watershed Management*, LuangPhrabang, Laos. 12-15 December 2006 : 64-65.
- Clément F., Amezaga J. M. (2007). Linking reforestation policies with land use change in Northern Vietnam: Why do local factors matter. *J. Geoforum*, doi:10.1016, Elsevier.
- Clément F., Amezaga J.M., Orange D., Tran Duc Toan (2007). The impact of government policies on land use in Northern Vietnam: an institutional approach for understanding farmer decisions. *IWMI Research Report*, 112, Colombo, Sri Lanka, International Water Management Institute (IWMI), 27 p.
- Clément F., Amezaga J.M., Orange D., Tran Duc Toan, Large A.R.G., Calder I.R. (2006). Reforestation Policies and Upland Allocation in Northern Vietnam: An institutional approach for understanding farmer strategies and land use change. *Proceeding of International Symposium "Towards sustainable livelihoods and ecosystems in mountainous regions"*, 7-9 March 2006, Chiang Mai, Thailand, 17 p.
- Clément F., Nguyen Duy Phuong, Orange D., Calder I.R., Amezaga J.M., Large A.R.G. (2005). Scientific narratives and policy: the need for a pragmatic approach regarding land management in Vietnam. *IV MMSEA Conference on "Sustainable use of natural resources & poverty dialogue in mainland Montane, South East Asia"*, SaPa, Vietnam, 16-19 May 2005: 13 p.
- Costanza R., d'Arge R., de Groot R., Farber S., Grasso M., Hannon B., Limburg K., Naeem S., O'Neill R.V., Paruelo J., Raskin R.G., Sutton P., van den Belt M. (1997). Value of the world's ecosystem services and natural capital. *Nature*, 387 : 253-260.
- Do Duy Phai, Orange D., Migraine J.B., Tran Duc Toan, Nguyen Cong Vinh (2006). Applying GIS-assisted modelling to predict soil erosion on a small agricultural watershed within sloping lands in Northern Vietnam. Sustainable watershed management in cultivated sloping lands of SEA. *Special Review about the 2nd International Conference on Sustainable Sloping Lands and Watershed Management*, LuangPhrabang, Laos. 12-15 December 2006: 19 p.
- Forsyth T. (1996). Science, Myth and Knowledge: Testing Himalayan environmental degradation in Thailand. *J. Geoforum*, 27, 3 375-392.
- Gutman P., ed. (2003). *From goodwill to payments for environmental services*. Washington DC: WWF, Macroeconomics for Sustainable Development Program Office.
- Hobson P. N., Feilden N. E. H. (1982). Production and use of biogas in agriculture. *Progress in Energy and Combustion Science*, 8(2) : 135-158.
- Kerr J. (2002). Watershed development, environmental services, and poverty alleviation in India. *World Development*, 30(8): 1387-1400.
- Maglinao A.R., Valentin C., Penning de Vries F., ed. (2003). From soil research to land and water management: harmonizing people and nature. *Proceedings of IWMI-ADB project annual meeting and 7e MSEC assembly*, Vientiane, Laos, 2-7 December 2002, IWMI, Colombo (Sri Lanka) : 250 p.
- Noble A.D., Bossio D.A., Penning de Vries F.W.T., Pretty J., Thiyagarajan T.M. (2006). Intensifying agricultural sustainability: an analysis of impacts and drivers in the development of "bright spots". *Comprehensive Assessment Research Report 13*, Colombo, Sri Lanka, International Water Management Institute (IWMI), 42 p.
- Orange D. (2002). Projet Gihrex : ambitions et acquis d'un projet de recherche pour le développement durable du delta intérieur du Niger. In Orange D., Arfi R., Kuper M., Morand P., Poncet Y. (éd.) : Gestion intégrée des ressources naturelles en zones inondables tropicales, Actes du colloque Girmzit, Bamako, 20-23 juin 2000, coll. *Colloques et séminaires*, IRD, Paris : 953-967.

- Orange D., Podwojewski P., Tran Duc Toan, Pham Van Rinh, Do Duy Phai, Nguyen Duy Phuong (2007). Impact of land use on bed load transported by rivers in the Dong Cao watershed, north Vietnam. *Water Figures Asia*, IWMI, Colombo (Sri Lanka), issue 1: 4-5.
- Padmavathiamma P.K., Li Loretta Y., Kumari U.R. (2007). An experimental study of vermi-biowaste composting for agricultural soil improvement. *Bioresource Technology*.
- Pagiola S., Arcenas A., Platais G. (2005). Can payments for environmental services help reduce poverty? An exploration of the issues and the evidence to date. *World Development*, 33(2): 237-253.
- Phuc P.D., Konradsen F., Phuong P.T., Cam P.D., Dalsgaard A. (2006). Practice of using human excreta as fertilizer and implication for health in Nghean Province, Vietnam. *Southeast Asian J Trop Med Public Health*, 37: 222-229.
- Poncet Y., Kuper M., Mullon C., Morand P., Orange D. (2001). Représenter l'espace pour structurer le temps : la modélisation intégrée du delta intérieur du Niger au Mali. In Lardon S., Maurel P., Piveteau V. (Eds): « Représentations spatiales et développement territorial », Hermes, Paris, chapitre 7 : 143-162.
- Smit J., Nasr J. (1992). Urban agriculture for sustainable cities: using waste and idle land and water bodies as resources. *Environment and Urbanization*, 4(2).
- Sommer S.G., Husted S. (1995). Chemical composition of the buffer system in livestock and biogas plant digested slurry. *J. Agric. Sci.*, 124 :45-53.
- Swallow B. (2006). Compensation and Rewards for Ecosystem Services in the tropics: Interface between conservation, poverty reduction and social justice. Presentation to International Symposium on Defying Nature's End: the African Context, Antananarivo, Madagascar, 22 June 2006.
- Toan T.D., Podwojewski P., Orange D., Phuong N.D., Phai D.D., Bayer A., Thiet N.V., Rinh P.V., Renaud J., Koikas J. (2004). "Effect of land use and land management on water budget and soil erosion in a small catchment in northern part of Vietnam". In *International conference on innovative practices for sustainable sloping lands and watershed management*, 5-9 September 2004, Chiang Mai, Thailand.
- Wunder S. (2005). Payments for environmental services: Some nuts and bolts. *CIFOR Occasional Paper*, 42, Jakarta, Indonesia, 31 p.

