



**ILCA
MONOGRAPH**

4

LOW-LEVEL AERIAL SURVEY TECHNIQUES

INTERNATIONAL LIVESTOCK CENTRE FOR AFRICA
KENYA MINISTRY OF ENVIRONMENT AND NATURAL RESOURCES
UNITED NATIONS ENVIRONMENT PROGRAMME

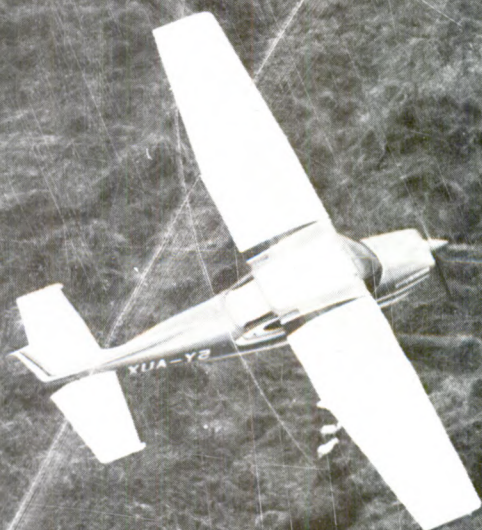

A WORKSHOP WITHIN THE
GLOBAL ENVIRONMENTAL MONITORING SYSTEM

PUBLISHED BY
INTERNATIONAL LIVESTOCK CENTRE FOR AFRICA

ILCA PUBLICATIONS

The **International Livestock Centre for Africa (ILCA)** is an autonomous research and information centre, whose activities and publications are funded by the Consultative Group on International Agricultural Research (CGIAR). The CGIAR members which have funded ILCA to date are the International Development Research Centre, the United Nations Development Programme, the World Bank and the governments of Australia, Belgium, the Federal Republic of Germany, France, Iran, the Netherlands, Nigeria, Norway, Saudi Arabia, Sweden, Switzerland, the United Kingdom and the United States of America. Responsibility for ILCA publications, however, rests solely with the centre and such other parties as may be cited as joint authors.

ILCA Monographs and *Systems Studies* are currently ILCA's two series of scientific publications. Both present information concerned with livestock production systems of tropical Africa, though *Systems Studies* deal with systems as a whole, while *Monographs* deal with aspects of systems and range widely in subject matter.

LOW-LEVEL AERIAL SURVEY TECHNIQUES

**REPORT OF AN INTERNATIONAL WORKSHOP
HELD 6-11 NOVEMBER 1979
NAIROBI, KENYA**

**INTERNATIONAL LIVESTOCK CENTRE FOR AFRICA
KENYA MINISTRY OF ENVIRONMENT AND NATURAL RESOURCES
UNITED NATIONS ENVIRONMENT PROGRAMME**

**PUBLISHED BY
INTERNATIONAL LIVESTOCK CENTRE FOR AFRICA
P.O. BOX 5689 ADDIS ABABA ETHIOPIA**

This One



Digitized by Google **JS2T-SC7-FRQK**

This document presents workshop papers and discussion summaries on the development of low-level aerial survey techniques and present applications to livestock, wildlife and land-use surveys. It reviews survey designs and sampling procedures as well as problems of bias, information transfer and coordination with information collected at other levels, from ground survey to satellite imagery. Recommendations for further research and cooperation are included.

KEY WORDS /MEETING REPORT/ /EAST AFRICA/ /AERIAL SURVEY/
 /CENSUS/ /RESOURCE INVENTORY/ /MONITORING/
 /LIVESTOCK/ /WILDLIFE/ /RANGELAND/ /SAMPLING/
 /BIAS/

Ce document présente les comptes-rendus et les résumés des discussions de l'atelier sur le développement des techniques de reconnaissances aériennes à basse altitude, et leurs applications aux enquêtes sur l'élevage, la faune et l'utilisation des terres. Il examine l'organisation des enquêtes et les procédures d'échantillonnage ainsi que les problèmes liés aux biais d'échantillonnage, au transfert de l'information et à la comparaison de cette information avec celle récoltée à d'autres niveaux par reconnaissance au sol ou par satellite. Ce document comprend aussi des recommandations pour une coopération et des recherches supplémentaires.

MOTS CLES /RAPPORT DE REUNION/ /AFRIQUE DE L' EST/
 /RECONNAISSANCE AERIENNE/ /RECENSEMENT/
 /INVENTAIRE DES RESSOURCES/ /SURVEILLANCE/
 /BETAIL/ /ESPECE NATURELLE/ /ECHANTILLONAGE/
 /BIAIS/

PREFACE

An International Workshop on Low-Level Aerial Survey Techniques was held in Nairobi, Kenya, from 6 to 11 November 1979, cosponsored by the International Livestock Centre for Africa (ILCA), the United Nations Environment Programme (UNEP) and the Wildlife Conservation and Management Department of the Kenya Ministry of Environment and Natural Resources. The workshop also formed an activity within the renewable natural resources programme of the Global Environmental Monitoring System (GEMS), which is coordinated by the GEMS Programme Activity Centre of UNEP.

This workshop was a sequel to a Workshop on the Use of Light Aircraft in Wildlife Management in East Africa, held in Kenya's Tsavo National Park 11 years earlier, in December 1968. The proceedings of the first workshop were published in 1969 as a special issue of the *East African Agricultural and Forestry Journal*.

The 1968 workshop was concerned primarily with wildlife, with the focus on low-level aerial census of animal populations. It was subsequently recognized that the methods developed for low-level survey from light aircraft have a much wider application, for example in range development as a rapid means to obtain reliable information on many human, livestock and environmental parameters.

The purposes of the second workshop were threefold: to review progress in the methods and application of low-level aerial survey, to determine areas where further methodological improvements seem feasible and to examine critically certain controversial issues.

The workshop was held at the University of Nairobi, and was attended by 98 participants from Botswana, Canada, Kenya, Mali, the Netherlands, Tanzania, Uganda, the United Kingdom and the United States. The programme, which is appended to this report, included the presentation of formal papers, seminars on special topics and a 2-day field exercise held at the Game Ranching Ltd ranch near Nairobi.

This report is based on the papers presented at the workshop and on syntheses of the various discussions. For reasons of space, some papers have been shortened, while others have been merged into the accounts of the discussions. The report was edited by J J R Grimsdell and S B Westley of ILCA, with assistance from M D Gwynne of UNEP, G M Jolly of the Agricultural Research Council Unit of Statistics at the University of Edinburgh and S W Taiti of the Kenya Wildlife Conservation and Management Department. It was typed by G Maloba.

In addition to the three sponsoring organizations, particular acknowledgment must be given to those who helped plan the workshop and ensured that it ran smoothly. The Research Division of the Kenya Wildlife Conservation and Management Department was responsible for organization and liaison, with the help of an organizing committee composed of S W Taiti (chairman), J O Ayieko, J J R Grimsdell, M D Gwynne, J King, M Norton-Griffiths, M Stanley-Price, J G Stelfox and R M Watson. During the workshop, valuable assistance was provided by J O Ayieko, P N Chege, A A Kaka, S Luther, W Obara, J G Rakwar, J Sembele and T Thiongo. S B Westley acted as workshop secretary. The field exercise was organized by R M Watson with the cooperation of D Hopcraft of Game Ranching Ltd and his staff. The Kenya Ministry of Environment and Natural Resources hosted a reception in honour of the participants.

CONTENTS

Preface	iii
1. Introduction	1
2. Resource inventory, mapping and monitoring	5
Light aircraft and resource monitoring (M D Gwynne and H Croze)	7
Aerial survey methods: The experience in Kenya from 1968 to 1978 (S W Taiti)	27
Examples of low-level aerial surveys conducted in Africa from 1969 to 1979: One firm's experience (R M Watson and C I Tippett)	33
The Kenya Rangeland Ecological Monitoring Unit (KREMU) (D K Andere)	59
The aerial survey programme of the Kenya Rangeland Ecological Monitoring Unit: 1976-79 (J G Stelfox and D G Peden)	69
An approach to evaluating techniques for surveying vegetation on arid rangelands (D C P Thalen)	85
3. Animal census	99
Alternative methods of aerial livestock census (J J R Grimsdell, J C Bille and K Milligan)	103
Elephant carcasses and skeletons as indicators of population trends (I Douglas-Hamilton and A K K Hillman)	113
Notes on vertical photography of elephants for age determination (I Douglas-Hamilton, A K K Hillman and C J Moss)	131
4. Survey design and sampling procedures	143
A review of the sampling methods used in aerial survey (G M Jolly)	149
Some thoughts on sampling design (G E J Smith)	159
Unstratified systematic sampling: Rationale and method (M Norton-Griffiths)	167
5. Bias	175

Methods of bias correction	181
(G M Jolly)	
Measuring bias in aerial surveys due to dispersion of animals	185
(A E Newsome, M L Dudzinski and W A Low)	
The static model sampling strip for investigating observer bias in aerial surveys	195
(R M Watson, C I Tippett and G M Jolly)	
6. Field equipment	205
7. Data processing and information transfer	211
8. Training and motivation	217
9. Workshop summary and recommendations	221
References	229
Appendix: The workshop programme	241

1. INTRODUCTION

Low-level aerial survey is a tool for gathering certain types of information to serve specific objectives. The more clearly these objectives are defined in each case, the more likely that the most useful and appropriate survey will be carried out. Techniques of low-level aerial survey have been, and still are to some extent, in their formative stages, so that many of the surveys conducted in the past could be considered experimental in nature. Furthermore, most of these surveys were initial or baseline surveys of areas for which either few or no previous survey data were available. They were basic resource and inventory surveys of the type which would form a useful prelude to management planning.

I S C Parker, in considering wildlife research in eastern Africa, raised the question - Why aerial survey? - since, in his view, so few of the results from past aerial surveys have been of direct use in wildlife management. Of 432 papers or short communications published in the *African Journal of Ecology* (formerly the *East African Wildlife Journal*) between 1963 and 1979, 40, or 9.3%, concerned aerial survey, either directly or as a major component of the research work described. Yet, Mr Parker contended that aerial survey results have in very few cases led directly to policy formulation or implementation. This is a complex issue, however, since, as already mentioned, low-level aerial surveys were initially to some extent experimental and subsequently have been chiefly concerned with collecting baseline data. Furthermore, wildlife management authorities have generally been slow to develop plans or implement management strategies in any

case, while research results, based partly on the use of low-level aerial survey, have sometimes indicated - as in Tanzania's Serengeti National Park - that little active management is necessary or desirable (Sinclair, 1979).

Experience with low-level aerial survey and wildlife management in eastern Africa highlights a much more general dilemma of research and management in many situations around the world: managers complain that research results are not useful, but at the same time they fail to define their information requirements in sufficiently precise terms to make it possible for useful research to be planned or carried out. Clearly, much closer communication is required between research workers and managers than has usually been the case in the past, to decide what information is needed and then devise the most suitable approach to collect it. Researchers would also have a clearer idea of the information needs of managers if they were more closely involved in management decisions and responsibilities themselves.

This general problem has immediate relevance for low-level aerial survey work. In addition to precise guidelines on what type of information is needed, more feedback is necessary from managers regarding the minimum levels of accuracy and precision required. Aerial survey data are usually much better than rough estimates, but are far from being highly accurate. Scientists may spend considerable time and effort attempting to refine survey techniques to achieve greater accuracy and precision, yet may have no clear understanding of the minimum levels required by managers.

Project managers may obtain aerial survey information in three ways. First the staff of the project may carry out a survey themselves, assuming that a suitable pilot and light aircraft are available. Second, a specialized national unit, such as those established in Kenya and Senegal, may carry out the survey. Third, a consultant firm may be hired which specializes in aerial survey work. Combinations of these three approaches may also be possible: a consultant firm could organize a survey, but involve local project staff as observers. Project staff benefit from the overview of a project area provided by aerial observation, and some

level of local involvement is required by many governments. International organizations can play a useful role, by providing technical advice and financial assistance and by organizing training programmes. They can also help in the development and testing of new techniques and in making the results of experimental work more widely available.

Whether carried out by project staff, a national unit or a consultant firm, low-level aerial survey is usually the most practical and cost-effective method available for obtaining quantitative resource data, such as estimates of animal numbers, over large areas of rangeland, provided there is adequate provision for obtaining essential ground truth. Costs per unit area surveyed are generally lower than most forms of equivalent ground survey, assuming that the latter is feasible. Total costs depend on many factors - such as salaries of pilots and observers, aircraft operating costs, proportion of area sampled, time spent in training observers, and the cost of ground support and the transport of fuel. Typical costs, for instance, of a sample survey covering 5 to 10% of a rangeland area, fall in the range of US\$1 to 3 per km² of total area under investigation. The largest cost component is usually salaries, especially when allowance is made for data processing and report writing: aircraft hire costs are secondary. When an aircraft is purchased, together with special equipment such as a radar altimeter and a Very Low Frequency navigation system, the initial capital cost is high, but when averaged out over many surveys, the cost per survey remains reasonable.

It is hoped that the proceedings of this workshop will be useful to researchers who carry out low-level aerial surveys and to managers and planners who use survey results, and that further improvements in survey methods will follow. In the final analysis, the value of low-level aerial surveys must be assessed in terms of their contribution to sound management plans and successful development projects.

2. RESOURCE INVENTORY, MAPPING AND MONITORING

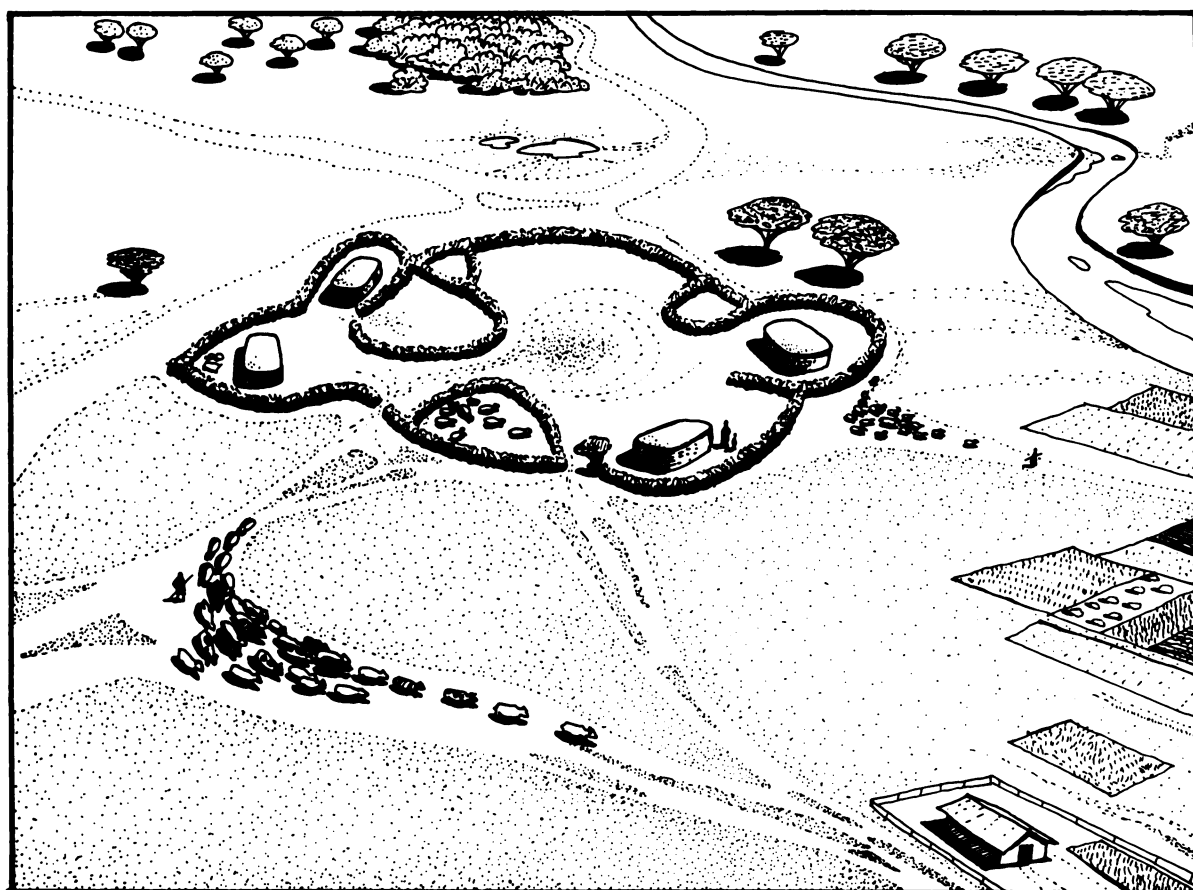

Six papers presented in this section describe the experience of individuals and organizations in carrying out aerial surveys for resource inventory and mapping and for monitoring changes in resources over time. This introduction is based on the remarks of the chairmen of the relevant sessions of the workshop - S M Cobb, M D Gwynne and K Milligan - and on comments by J J R Grimsdell, C F Hemming, A D Graham and P A Sihm.

Resource inventory, mapping and monitoring surveys involve the collection of a wide range of ecological data. Most such surveys are conducted with management objectives in mind. Here, the majority of papers concern initial, or baseline, surveys performed to describe a system or area under study. The results of these surveys contribute to the formulation of development or management plans, which should be based on reliable ecological knowledge: inventories of all the relevant resources in an area and maps of their distribution are essential for development planning and defining development zones (Pratt, 1975).

Several aerial techniques may be used for resource inventory and mapping. One, described at the meeting by C F Hemming, uses a light aircraft, such as a Piper Super Cub or a helicopter, as a 'flying Landrover' to collect both aerial and ground data. This method provides a means of describing and mapping static features, such as vegetation types and land systems, quickly over very extensive areas. For example, in Kenya's southern Turkana area, it was possible to map geomorphological units over 9 500 km² of very difficult terrain in only 33 days (Hemming, 1972). In addition to collecting information from the air, an experienced pilot was able to land a Piper Super Cub in inaccessible parts of the study area so

that ground observations could be made and plant and soil specimens collected. Actual boundaries of geomorphological units were later defined, based on these observations and on the annotation of aerial photographs made as part of the same study.

Animal distributions are often best recorded by low-level aerial survey. For instance, A D Graham described a national wildlife survey conducted in Botswana, whose object was to map the distribution of all the larger species of wild animals in relation to existing and proposed land use. An unstratified systematic sampling design was chosen since it is particularly suited to mapping animal distribution and provides good animal population estimates. Each survey sample covered some 2% of the total area under investigation. Problems of aerial navigation are acute in Botswana because the country is generally flat and featureless, and therefore the production of reliable animal distribution maps would not have been feasible without the use of special navigation equipment. Graham and his team used the GNS-500, a Very Low Frequency (VLF) navigation system, only recently available for use in light aircraft. This equipment allowed accurate placement of flight transects and the accurate location of the animals observed. Observations were made from a Cessna 210 aircraft by a survey team of two - a pilot/observer and a front-seat observer. On return from each flight, tape-recorded observations were typed out in a simple code and entered directly into a computer at Gaborone. In this way, it was possible to produce computer-generated distribution maps, in grid-square format, within a few days of the survey. The combined results of surveys over a 4-year period were used to define a number of wildlife management areas as a component of national land-use plans.

In their paper, M D Gwynne and H Croze outline the development of light aircraft survey methods from the early pioneers in East Africa to the present situation, where aerial surveys are carried out in many parts of the world as one component of a sophisticated, multi-dimensional environmental information-gathering system. S W Taiti, in his paper, describes the development of aerial survey in Kenya in more detail. For inventory and mapping work and ecological monitoring, two major sampling techniques have been developed, based on similar data collec-

tion methods. Several examples of stratified random sampling techniques are given in the paper by R M Watson and C I Tippet, while aerial sampling by systematic reconnaissance flights (SRFs) is described in the paper by J G Stelfox and D G Peden, based on the work of the Kenya Rangeland Ecological Monitoring Unit (KREMU). KREMU's development is also described in the paper by D K Andere. Again emphasizing the use of low-level aerial survey as one part of a multi-level data collection system, D C P Thalen considers how the various survey levels, from ground surveys to data collected by satellite, each make different contributions to the overall inventory and mapping process, and are, therefore, best used in combination.

These papers describe baseline resource inventory and mapping surveys, as well as surveys designed to monitor changes in resources over time. No papers were presented on monitoring development implementation, and this is clearly a field where present experience is inadequate. The question of development planning and implementation was raised at the workshop in the context of rangeland and pastoral development, since aerial survey techniques are particularly useful for studying rangelands and pastoral societies. Most rangeland areas are large and partly inaccessible to ground survey, and it is often difficult to obtain accurate information from interviews with pastoral livestock owners. Low-level aerial survey is at present the most effective way to obtain accurate data on livestock numbers and distribution as well as other relevant information, such as human population size derived from house counts. The ratio of livestock to human numbers also provides an index of the nutritional status of a pastoral society which can be monitored over time.

In order to be useful for development planning, however, aerial surveys must be carried out within the time frame for project formulation followed by many international funding agencies. Projects funded by the World Bank, for instance, are conceived as stages in a 'project cycle', which, for rangeland and pastoral development projects, includes:

- identification phase (1 year): project selection
- preparation phase (1-2 years); feasibility studies and initial surveys

- appraisal and negotiation phase (1 year): review of all aspects of the project and arrangements for financing, culminating in approval and ratification of the project agreement between the government and the donor agency
- implementation phase (5-6 years): management under the supervision of the government and donor agency.

The structure and timing of such a project cycle permits a baseline study during the preparation phase and monitoring surveys during the implementation phase. Although implementation monitoring provides a useful feedback to management, monitoring should begin earlier in the project cycle in order to influence project design. Therefore, a longer preparation phase would seem desirable for rangeland and pastoral development projects, so that detailed development plans can be based on a thorough understanding of the dynamics of the production system in the project area.

LIGHT AIRCRAFT AND RESOURCE MONITORING

M D Gwynne and H Croze
Global Environmental Monitoring System
United Nations Environment Programme

THE DEVELOPMENT OF LIGHT AIRCRAFT SURVEY METHODS IN EASTERN AFRICA

The potential of very-low-altitude flying for gathering habitat information has long been recognized. In eastern Africa, some of the earliest and best low-altitude aerial photographs were taken in the 1920s by the Royal Air Force (RAF) flying Fairey III F bi-planes fitted with floats. Operating as low as 50 feet (15 m), the RAF crews made a unique early record of the eastern African countryside and its wildlife. This was followed closely by M Johnson, who made a number of excellent documentary films which included low-altitude sequences taken from his aeroplane.

The Royal Air Force pictures now form part of the official RAF photograph collection, while those of Johnson are housed at Eastman Kodak in Rochester, New York. Both these early collections represent valuable records and it is surprising that no ecologist has yet used these photographs as a baseline against which to measure indications of ecological change, such as the alteration of woody vegetation over time.

Both H Williams (writing about the RAF venture) and M Johnson emphasized the potential usefulness of low-flying aircraft for gathering what would today be termed habitat data for land-management purposes. It was not, however, until well after World War II that events in eastern Africa led those concerned with land management to the deliberate use of light aircraft for ecological

information gathering. At first this work was concerned almost entirely with spotting wildlife and with anti-poaching activities, although there were a number of progressive ranchers in the region who used aircraft as a ranch management tool.

By the late 1950s, park wardens and wildlife biologists were using aircraft in attempts to obtain total counts of particular wildlife species in specific areas. This initiative by wildlife management specialists coincided with a realization by the three East African governments of the economic and strategic importance of developing their vast semi-arid and arid areas. The governments turned to the ecologists and range management specialists working in eastern Africa at that time to produce basic information on these arid and semi-arid areas as quickly as possible with minimum expenditure.

Given this request, biologists and land managers took to the air to gain an overview of the areas which they were to study. To start with, these aerial surveys were no more than low-altitude reconnaissance flights and were mainly used to annotate aerial photographs taken from high-altitude survey aircraft. It soon became apparent, however, that it was possible to gather simultaneously a great deal of information about a number of habitat parameters and their interrelationships from light aircraft.

By this time, biologists concerned with wildlife census had begun to realize that greater economies in time and money could be ensured by using some form of sampling rather than always attempting total counts. At this time also, it was becoming apparent that trends in animal populations were perhaps more important than total numbers for management purposes. In order to understand more fully the dynamics of wildlife populations it would also be necessary to supplement animal number information with details of herd structure and composition, such as the ratio of young to adult females, and such details could not always be obtained from the air but rather called for special ground surveys.

The two approaches - habitat data recording and animal censusing on a sample basis - were soon combined into a single operation. This allowed analysis of the

reasons why animal species occur where they do. At the same time it led biologists to recognize the need for repetitive sampling over time in order to establish better correlations between the various habitat parameters and to understand the ecological processes more fully. In this way, it became possible to distinguish changes in spatial and temporal relationships so that, for example, not only could changes in animal numbers be detected, but also changes in distribution, both seasonally and in the longer term. Thus the concept of ecological monitoring was developed.

At this stage, in December 1968, a workshop was held on the use of light aircraft in wildlife management in eastern Africa. It is significant that nearly all the 19 papers presented at that workshop related to aspects of counting animals. Two papers considered the collection of other types of ecological information, and only one dealt in any detail with the need for repetitive monitoring flights. The relationships between data gathered from the air and those obtained on the ground by more conventional means were largely ignored. Nevertheless, the workshop was a landmark that conferred a respectability, previously lacking, on the use of light aircraft for animal census work.

The workshop was important in another respect. Although it was not noticed at the time, this workshop also marked the end of the period when the primary purpose of most light aircraft surveys was to collect animal census data and the beginning of the emphasis on some form of environmental or habitat survey in which animal numbers are just one of the variables considered, albeit an important one.

Up to 1968, the use of light aircraft in eastern Africa for counting animals had parallels in other parts of the world, most notably in North America. After 1968, however, low-level aircraft surveys in eastern Africa acquired their own distinctive character. Increasingly, data gathered by aircraft flights were related to information gathered separately, but often simultaneously, on the ground. These ground surveys provided information on parameters that could not be examined easily from the air with the technology available at the time - such as rainfall,

aspects of primary production, plant species, plant part composition and animal population age structures.

This two-level data collection system could provide information not only to land managers, who were primarily concerned with changes in the short term, but also to development planners who needed sound information on which to base projections for the future. It is no accident that at this time aerial surveys began to be used for range management and livestock development studies.

In 1972, a new level of data acquisition was added with the launching by the United States of LANDSAT 1 (then called ERTS-1), the first of the earth resources assessment satellites. Biologists in eastern Africa were quick to realize the usefulness of this new technology, and added it to the information gathering system then in use. Initially, it provided the overview necessary to delimit land systems and land forms and to facilitate the demarcation of 'self-contained land systems' appropriate to the needs of particular surveys. As satellite remote sensing technology developed, new techniques also allowed some of the temporal and spatial habitat changes to be monitored from space (e.g. green flush events, burning, desertification).

By 1974, therefore, the ecological monitoring unit approach was well established, with information gathered from three levels - space, air and ground. The quality of the information collected improves as one proceeds from space to ground, but the cost of data collection also increases. For example, LANDSAT image analysis can produce low-resolution data at a cost of approximately US\$0.01 per km², while a vegetation survey carried out by a ground team produces detailed data at a cost of around US\$100.00 per km². The quality of the information collected by satellite can be improved much more readily than the cost of information collected on the ground can be reduced. A primary consideration in ecological monitoring is thus to balance effectively the low cost of extensive data collection methods with the need for high-quality information from more intensive techniques.

SURVEY METHODS AND OBJECTIVES

The balance between intensive and extensive methods has to be considered in relation to the objectives of each particular survey undertaken and the potential uses of the information to be collected. These objectives and uses must be known before the survey begins and must be related to limitations of time, manpower and money so that an inventory survey or a monitoring system can be designed that meets the needs of those sponsoring the survey, that provides useful, reliable information and that stays within the available resource constraints.

This flexibility of approach should be the mark of an ecological monitoring unit. When such a unit is functioning efficiently it becomes possible, for example, to relate micro-events in production recorded on the ground and meso-events in animal distribution recorded from the air to the macro-scale produced by a set of LANDSAT spectral reflectance signatures over hundreds of square kilometres. The combination of methods allows correlations which eventually should result in the phasing out of the more expensive intensive techniques. Management and planning decisions may then be made as a matter of course, using the cheapest data collection method, backed up and checked at a manageable frequency with quality control sampling from the air and on the ground.

In this context, low-level light aircraft survey forms part of a more comprehensive survey methodology. The exact role of light aircraft and the weight assigned to the data gathered at this level depend on the characteristics of the survey being undertaken.

INFORMATION FLOW

Planners and managers often claim that they do not have time to wait for scientists to undertake lengthy investigations. If adequate information is not available planners have to make do with what they have, and make guesses where specific

information is lacking. This may be regrettable, but it is a fact of life which must be recognized. Decisions will be made, and it is in everyone's interest to ensure that those who make them have access to the best available data.

Extensive inventory and monitoring methods are aimed at collecting reliable information as cheaply and efficiently as possible and communicating it to those who can best use it with the minimum of delay. A monitoring project that does not release its data for 2 or 3 years (and there are now many examples of this) is not functioning properly, and there is little justification in continuing the exercise.

Figure 1 is adapted from a rangeland monitoring project document used by the Global Environmental Monitoring System (GEMS). It shows a typical work plan for the collection and analysis of information and its dissemination to managers and planners. The steps are logical and simple: the approach is planned, the initial stratification is executed from low-intensity survey flights, preliminary boundaries are fixed over the study area, data collection is initiated at three levels (ground, air and space), the data are analysed, preliminary results are produced, the depth and scope of the information obtained are reviewed (and data collection methods revised if necessary), reports are prepared for management and planning staff and follow-up programmes are initiated.

Given careful organization in the initial planning phase and a degree of bureaucratic autonomy, the review state should be reached within 18 months of the inception of a monitoring project. Thus managers and planners should have relevant, sound reports and recommendations in less than 2 years. Moreover, due to the flexibility of the strategy, the full programme can be short-circuited in cases of urgent need for rapid policy decisions. In such cases, useful data can be available within 3 to 6 months. If ecological monitoring is to have practical impact, the results of each aerial survey must be analysed and written up from 3 to 6 weeks after the conclusion of the survey. This is not an impossible schedule: it has been achieved many times, as shown in the literature.

Figure 1. Flow chart for ecological monitoring

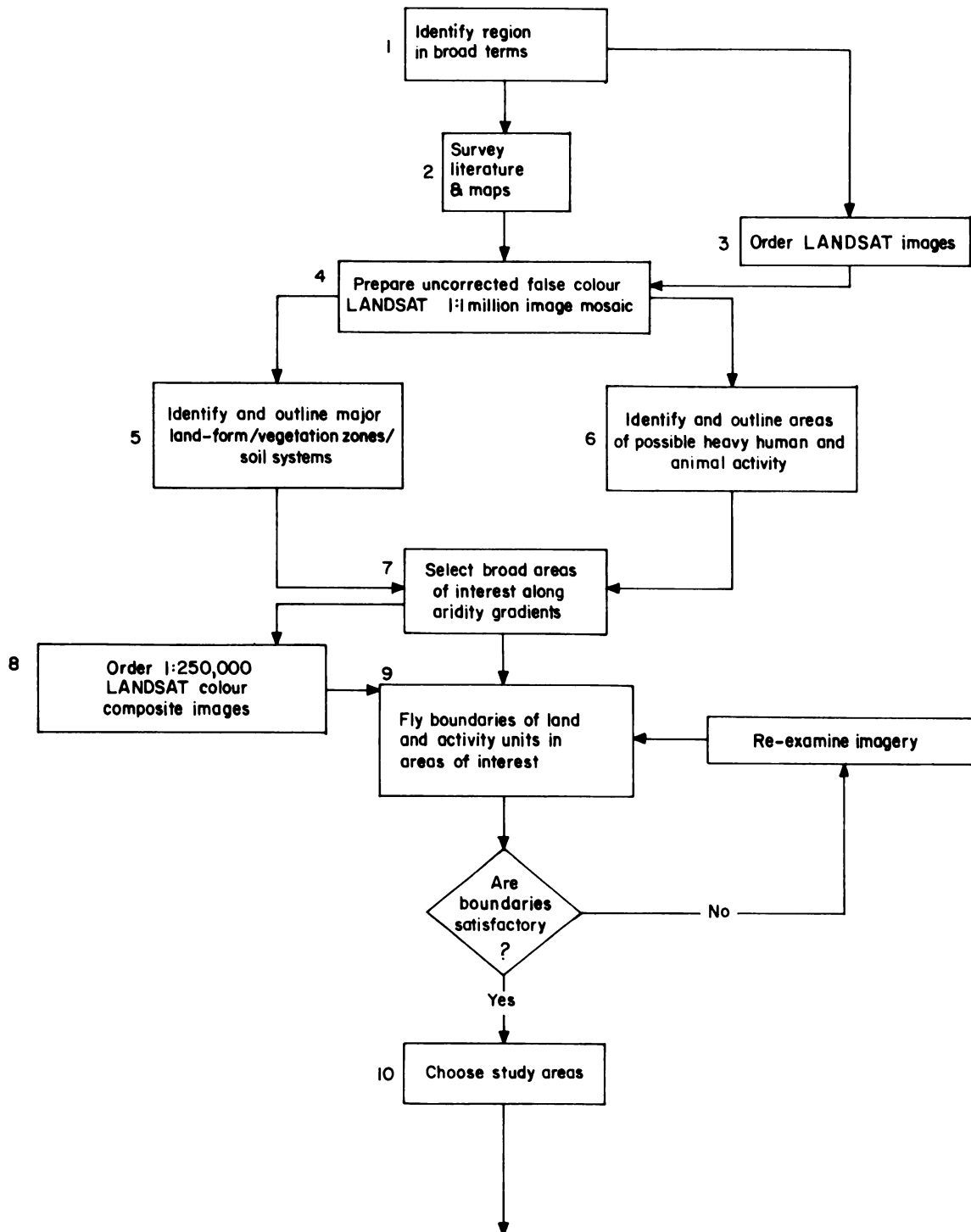
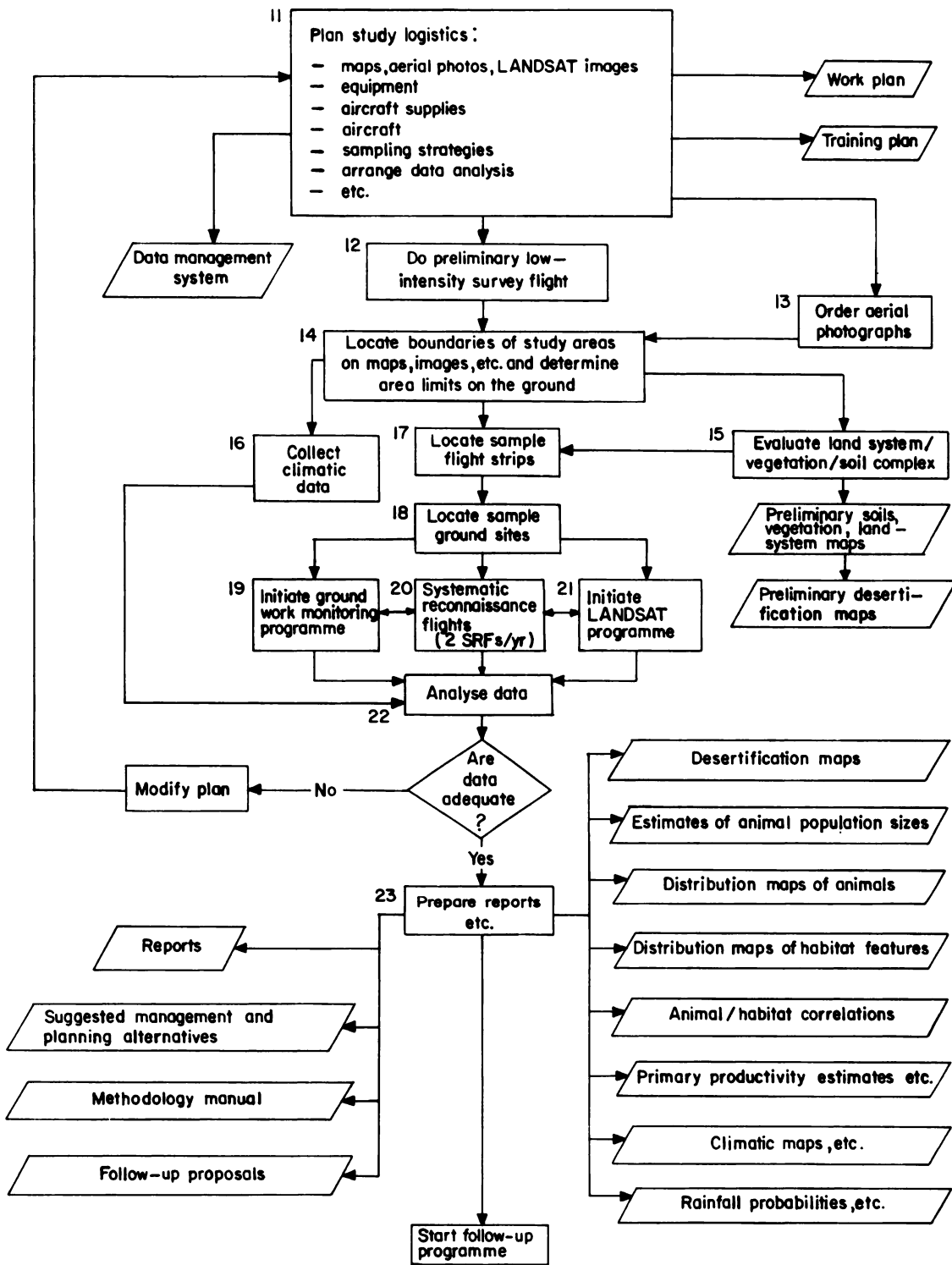

Figure 1, cont.



In the past, too little importance has been attached to the flow of information to the users. The cause of delay is not so much the analysis of data as poor machinery and channels within government for transferring survey information to potential users and supplementing it with information derived from other sources, such as socio-economic data. These lessons have been learned and new monitoring projects now being designed pay particular attention to questions of information transfer.

Since 1968, two major sampling techniques have been developed and are currently being used in aerial monitoring surveys. Both techniques use similar data-gathering methods from low-flying light aircraft and similar analysis techniques. They differ only in terms of sampling pattern. Stratified random sampling has normally been associated with surveys designed particularly for animal census. An area is first stratified according to estimated attribute density after preliminary reconnaissance flights, or according to terrain type, administrative blocks or potential management units as required by the survey objectives. Each stratum is then surveyed at a sampling intensity proportional to a function of the estimated attribute density. This approach has proved successful for estimating animal numbers and densities and has been widely applied in Africa.

A need was also identified for a sampling system which displays distributional data more readily, not just of animals but of other habitat features. This has led to the development of the systematic reconnaissance flight (SRF) technique whereby data are collected on a systematic basis and stored and displayed in a cellular pattern within a grid system design. As in the stratified random approach, the sampling units for numerical estimates are transects crossing the sample area. If the cellular display is used, information collected from ground, space and from other data sources can also be assigned to appropriate cells within the grid. Computer techniques allow the ready recall of cell groups for particular analytical purposes, and such analyses can be independent of any previous stratification. The SRF system has been used for a number of multi-facet resource surveys. Both methods have their positive and negative aspects, and both have particular uses. Both can and will evolve further in association with other resource inventory and

monitoring methods now being developed.

These two methods are not the only possible approaches to aerial survey design. Other possibilities include spiral surveys for use in difficult terrain, such as isolated hill masses, and for censusing animal species that are rare or infrequent and have an importance disproportionate to their density, such as lion or kudu. There are also zig-zag designs for valley bottom surveys in heavily dissected country, and total block surveys which are particularly useful for animal counts in densely bushed areas.

GLOBAL MONITORING

The development of aerial survey in eastern Africa has been traced from early pioneers to the present situation, where aerial survey is one component of a multi-dimensional environmental information-gathering system. This has been done in order to point out the steady development of survey techniques, producing the range of methods now available from which the most appropriate can be chosen for a given purpose. The present information-gathering system typified by the ecological monitoring unit is a powerful, yet flexible, resource management tool whose real influence still lies in the future. For this reason, the system is now used by UNEP and its associated United Nations agencies as the basis for a global renewable resource monitoring network.

GEMS is already involved in monitoring the renewable resources of the world's arid and semi-arid regions, which brings it into the realm of range management and anti-desertification programmes. GEMS is also involved in forest-cover and soil-degradation monitoring and will soon be active in the co-ordination of resource monitoring in the Global Biosphere Reserve network. Genetic resource monitoring, including a focus on threatened species, and food-production monitoring are two further activities with which GEMS will be concerned in the future. In all of these, it is expected that the techniques described here will play a major role.

Techniques are currently being developed and applied to new fields and situations in other parts of the world. For example, an aerial survey was carried out in 1979 by a consultant firm for the Kenya Ministry of Health. In parts of Kitui District, non-biological variables were inventoried in a socio-economic survey to determine the relationships between human settlement patterns and health services. In a few years' time, the use of light aircraft for surveys of this type will probably be commonplace.

Similarly, survey techniques are being adapted to high-potential agricultural areas. In eastern Africa the aerial components of some rangeland resource surveys have recorded the state of agriculture in the marginal areas over which they flew, distinguishing major crops and their stages of growth. In Ethiopia, the United Nations Children's Fund (UNICEF) is relating aerial survey data on agricultural areas to ground data supplied by administration officials in an attempt to predict potential crop yields. This method appears promising and should help overcome the difficulties in determining crop yields in peasant farming areas which were encountered during the Large Area Crop Inventory Experiment (LACIE). The LACIE programme attempted to predict crop yields from satellite-derived remote sensing data. It is being viewed with interest in the Philippines for obtaining rice production estimates.

Forests, particularly humid tropical forests, are among the most difficult ecosystems to survey and monitor. Recently, however, low-flying light aircraft surveys have been used to provide interpretive details on tree communities and tree species composition for use with satellite images and high-altitude aerial photographs. Again, aerial surveys formed part of a three-level data acquisition system. These forest cover surveys were carried out as part of a monitoring project in West Africa (Benin, Cameroon and Togo) for GEMS. Now that appropriate forest-cover monitoring methods have been developed, they will be expanded into other tropical forest regions in Latin America and southeast Asia.

A world-wide network of ecological monitoring units is currently being initiated in arid and semi-arid regions for inclusion within GEMS, based on

systematic reconnaissance flights. A few examples will show the kind of surveys being undertaken. In Bolivia, the monitoring unit will survey a central rift valley system which contains large flocks of domestic llama, alpaca, sheep and pigs, usually managed together. Serious ecological degradation has resulted from overgrazing, coupled with the removal for fuel of all woody vegetation down to a depth of about 1 m below ground. This survey should present no special problems except that the floor of the valley system is at an altitude of 3962 m so that supercharged aircraft must be used. Specific aerial census techniques will also be used to determine the population of wild vicuna in the study area. Additional special surveys are required for the adjacent rugged Andean valleys at even higher altitudes. East of the Andes, large areas of degraded *chaco* bushland and thicket, on sandy soil, will be inventoried and monitored during an initial 4-year period. The information gained from this project will be used to assist the Bolivian Government to develop a practical plan of action to counteract desertification.

A similar project will monitor the Argentinian northern rangelands and a large area of cold desert in southern Patagonia, a major sheep production region about which comparatively little is known. Sheep numbers and primary and secondary production data will be investigated. Low-level aerial surveys in cold weather present their own peculiar problems.

In Peru, coastal hill lands, or *lomas*, are entirely supported by occult precipitation from the seasonally prevalent fogs: in many of these areas it has never been known to rain. The natural vegetation of the *lomas* is adapted to intercepting fog moisture from July to September. At this time a dense vegetation of grass and herbs occurs, which dies down during the rest of the year. The *lomas* are grazed heavily by livestock as long as forage is available, and then the animals are moved down to valleys to graze the stubble of irrigated fields. In the dry months of April to June, the stock are taken up to high Andean meadows at altitudes of 3353 m, after which they return to the *lomas*. This livestock production system is not fully understood and the *lomas* have been badly degraded. The government wishes to rehabilitate these areas and is participating in a 5-year inventory and monitoring project that will provide specific management and development proposals. The

nature of the terrain and the objectives of the project will require the application of special aerial survey techniques.

In Pakistan, the Thal desert lies between two branches of the Indus River. Part of this desert is under irrigation agriculture while the rest is used by resident, but mobile pastoralists. In addition, the area is traversed seasonally by nomadic pastoralists taking their livestock from the west out of Baluchistan to feed on the stubble fields of the Indus irrigation network. The Thal is also the southernmost grazing area of other nomads who move their stock seasonally north to the pastures of the high Himalayas. The government wishes to establish an ecological monitoring unit to obtain information on these livestock production systems which can be used as a basis for range improvement and anti-desertification measures. The development of agricultural survey methods will pose particular problems in the Thal project.

In Afghanistan, a nomad corridor in the southern part of the country will be studied by an ecological monitoring unit to be established within the Ministry of Agriculture to determine the number of livestock present and the seasonal carrying capacity of the land. The main livestock species is sheep, which are wintered in the valley bottoms and moved to mountain meadows in the spring. Stock congregate in such numbers in the valleys during winter that aerial photography census methods will have to be used. The seasonal dispersal into the mountains can also only be understood adequately through investigation from the air.

In Senegal, the Food and Agriculture Organization (FAO) is cooperating with UNEP in a project to inventory and monitor Sahelian pastoral ecosystems. This 4-year project is adapting the methodologies developed in eastern Africa to the conditions peculiar to the Sudano-Sahelian zones. The information obtained is being used by the government to improve its range management programme, including the formulation of anti-desertification measures, and to develop the national livestock industry. It is hoped that this project can be coordinated with similar efforts planned in Mali and Nigeria, and that this type of activity will increase throughout the West African region.

Table 1. Renewable natural resource surveys using systematic reconnaissance flights

Country	Region	Area ₂ (km ²)	Systematic reconnais- sance flights	Ground survey	Satellite assess- ment
Afghanistan	Southeast	20 000	x	x	x
Argentina	Gran Chaco	24 000	x	x	x
	Los Llanos	25 000	x	x	x
	Patagonia	50 000	x	x	x
	Santa Rosa	120 000	x	x	x
Bolivia	Altiplano	39 000	x	x	x
	Chaco	12 500	x	x	x
	Santa Cruz	35 000	x	x	x
Botswana	Western State Lands	576 000	x	x	x
Ivory Coast	Comoe	104 000	x	x	-
Kenya	Kajiado	22 000	x	x	x
	Lamu-Southern Garissa	30 000	x	x	x
	Marsabit	35 000	x	x	x
	Masai Mara	6 575	x	x	-
	Samburu	16 000	x	x	-
	Tana River	42 000	x	-	-
	Tsavo	45 000	x	x	x
	Ilkisongo- Amboseli	8 000	x	x	x
	Kenya rangelands	500 000	x	x	x
Mali	Niono/Mopti	60 000	x	x	x
Pakistan	Thal	20 000	x	x	x
Peru	Lomas	20 000	x	x	x
Saudi Arabia	Arabian South Shield	110 000	x	-	-
Senegal	Ferlo Région Sylvo-Pastorale	30 000	x	x	x
Sudan	Jonglei	56 000	x	x	x
Tanzania	Arusha	90 000	x	x	x
	Ruaha	15 000	x	x	-
	Rukwa	33 000	x	-	-
	Rungwa	20 000	x	-	-
	Selous	124 000	x	x	-
	Serengeti	30 000	x	x	-
	Simanjiro	15 000	x	-	-
	Stiegler's Gorge	19 000	x	x	-
	Tabora	110 000	x	x	x
Uganda	Kabalega	3 000	x	-	-
	Rwenzori	2 000	x	-	-
Zaire	Bili-Vere	9 350	x	x	x
	Garamba	4 480	x	x	x

Other similar projects in Asia, Latin America and Africa are at various stages of discussion. All of them will be based on systematic reconnaissance flights combined with other forms of aerial census and survey according to the objectives of each individual project. Table 1 shows those regions that have been or are about to be surveyed by systematic reconnaissance flights, either for inventory purposes or as part of an ecological monitoring programme. Approximately 33% of the earth's land surface is arid or semi-arid, and this table shows that systematic reconnaissance flights cover 4.7% of these zones.

This resource monitoring network being established as part of GEMS depends very much on the establishment of national monitoring projects. Renewable natural resources, particularly in the developing world, are of very great economic significance to national governments. If these resources are monitored through national projects, the governments concerned will have control over the release and use of the data which are collected.

The success of this approach depends on the availability of a standard methodology for resource survey which is readily applicable and allows results to be compared from different countries and regions. For this reason, GEMS places great importance on the standardization of survey methodology.

**AERIAL SURVEY METHODS: THE EXPERIENCE IN KENYA
FROM 1968 TO 1978**

S W Taiti

**Wildlife Conservation and Management Department
Kenya Ministry of Natural Resources**

INTRODUCTION

Today among government officers, businessmen and land resource and environment managers, there is an unprecedented demand for comprehensive, accurate and timely information about environmental issues and resources over large areas of the country. This demand is likely to increase with expanding human population, industrialization and more complicated land-use planning and legislation. Improved data collection methods are being sought and developed to meet the growing demand for information to provide a basis for planning, monitoring trends and prediction. One of the areas of technology development which promises to improve substantially on conventional data collection capabilities when dealing with large geographic areas is remote sensing and one of the most important developments in this field is aerial survey.

Aerial survey combines remarkable advantages of speed, convenience, economy and replicability. Its main drawback is limited accuracy, which is complicated by the problem of controlling errors due to sampling procedures and the inconsistency of human observers. This drawback is the principal limitation on the extension of the method in the long run. Currently, but probably only temporarily, the application of the method is also being undermined by lack of consensus among leading practitioners on how to reduce sampling errors by choosing the best sampling design and approach to statistical analysis. This workshop was organized on the premise that an appropriate survey design and method of data analysis can only be chosen with a clear view of the objectives for which a survey is performed.

A great deal of pioneering aerial survey work has been carried out in Kenya. This work has focused almost entirely on wildlife research because game managers and biologists have been searching for a simple, accurate technique for estimating wild animal populations since the turn of the century. After World War II, light aeroplanes became available commercially and wildlife managers began to use them informally for counting animals in their natural habitats. In Kenya and the rest of eastern Africa, light aircraft were first used for counting game in the 1950s. Early aerial surveys were mostly total censuses (Grzimek and Grzimek, 1960; Zaphiro, 1959; Darling, 1960; Talbot and Talbot, 1963; Talbot and Stewart, 1964). The technique had been developed for a decade by 1968 when a workshop on the Use of Light Aircraft in Wildlife Management was held at Kilaguni in Kenya. Developments since then are described by Pennycuick (1969), Watson et al (1969), Watson (1970a), Norton-Griffiths (1972, 1975), Cobb (1976), Gwynne and Croze (1975) and Western (1976).

The most significant positive outcome of the 1968 workshop was to encourage the use of appropriate statistical analysis of aerial survey data. Since then, disagreements have persisted concerning the best approach to survey design and ways of making estimates more accurate and precise. The lack of accuracy and precision achieved has cast doubts in some quarters on the usefulness of aerial survey techniques to provide the information needed by planners and managers.

As with any other research tool, the future use of aerial survey will depend not only on its value in terms of accuracy and precision, but also on its costs and benefits in relation to stated objectives and to the relative merits of alternative techniques. If present methodological disputes can be resolved and acceptable levels of accuracy and precision achieved, attention in future can be focused on the results of aerial surveys and how they can be translated into improved planning and management.

AERIAL SURVEY PROJECTS IN KENYA

A discussion of the aerial surveys which have been carried out in Kenya might serve as a basis for evaluating the various methodologies which have been used. Table 1 lists the aerial surveys carried out over the past 10 years, along with their purposes and sponsoring agencies. At present, an estimated 200 persons are employed in aerial survey work in Kenya, including pilots, observers, scientists and support personnel.

The users of aerial survey data listed in Table 1 include government ministries, universities and private organizations. Most predevelopment surveys of livestock and wildlife in the rangeland areas have been commissioned by the Kenya Government. These surveys have usually been based on stratified random sampling. By contrast, rangeland monitoring surveys have generally been based on systematic reconnaissance flights, and most current government projects appear to be using systematic sampling methods. In spite of these methodological differences, the data collected for predevelopment surveys and for monitoring are essentially similar.

Most aerial survey reports include tables of results and describe the procedures followed, with very little interpretation of the data in relation to the objectives of the survey. The agencies which have sponsored these surveys very seldom appear to have critically evaluated the information provided. The surveys have been carried out by a heterogeneous assortment of students, generalists and specialists with widely varying training, experience and interests. They are not united by any common goals or social commitment, nor by common views on development or the environment, nor by common techniques or standards.

The projects which have included aerial survey have also frequently overlapped geographically, causing unnecessary duplication of effort. Some projects have involved the collection of unnecessary data or have been totally ill-founded. Overall, there has been a proliferation of aerial surveys whose justification has often been artificial in terms of management or policy decisions. There is clearly

Table 1. Aerial surveys carried out in Kenya between 1968 and 1978^a

Project	Sponsoring Agency	Purpose of Project and Sample Design
1. A census of domestic stock in North Eastern Province (1969)	Ministry of Economic Planning and Development	predevelopment survey; stratified random
2. Survey of large mammal populations in South Turkana (1969)	Royal Geographical Society South Turkana Expedition	scientific; stratified random
3. Aerial livestock surveys of Kaputiei Division, Samburu District (1970)	Ministry of Finance and Economic Planning	predevelopment survey; stratified random
4. Livestock and land-use surveys of Narok, Kajiado and Kitui Districts (1970)	Ministry of Finance and Economic Planning	predevelopment survey; stratified random
5. Livestock and land-use surveys of Marsabit and Isiolo Districts (1970)	Ministry of Finance and Economic Planning	predevelopment survey; stratified random
6. Livestock, wildlife and land-use surveys of Lamu-Garissa Districts (1971)	UNDP/FAO Kenya Range Management Project	ecosystem dynamics, pre-development surveys; systematic
7. Livestock, wildlife and land-use surveys of Lamu-Garissa Districts (1972-73)	UNDP/FAO Habitat Utilization Project; Ministry of Tourism and Wildlife	ecosystem dynamics, development surveys, national park and reserve delineations; systematic
8. Survey of dugong in the coastal waters of Kenya (1975)	UNDP/FAO Habitat Utilization Project; UNDP/FAO Wildlife Management Project	dugong distribution and population estimates; systematic
9. Ilkisongo monitoring programme (1973-)	New York Zoological Society, USA	ecosystem dynamics and land-use planning for Amboseli; systematic
10. Tsavo monitoring project (1973-74)	S Cobb in association with Kenya National Parks	ecosystem dynamics; systematic
11. Wildlife management project (1972-77)	UNDP/FAO Kenya Wildlife Management Project; Ministry of Tourism and Wildlife	game cropping in Kajiado District; systematic
12. Tana River elephant survey project (1974-75/76)	Ministry of Tourism and Wildlife, Game Department Research Division	scientific and planning for Bura Irrigation Project; systematic
13. Land-use in the Nguruman area	Ministry of Tourism and Wildlife, Game Department	predevelopment; stratified random
14. Kenya rangeland ecological monitoring project (1976-1980)	Ministry of Tourism and Wildlife, KREMU	monitoring land-use and animal numbers and distribution; systematic
15. Aerial census of kongoni on Athi Kapiti plains and Nairobi National Park	University of Nairobi	scientific; systematic
16. Bura irrigation project (1975)	Tana River Development Authority; World Bank	predevelopment survey; systematic
17. Game survey in Narok District	Game Department Research Division	regulation of hunting offtakes; systematic
18. Study of rhinoceros in Masai Mara Game Reserve (1972)	University of Nairobi	scientific; stratified
19. Wildlife census around Samburu Game Reserve	University of East Anglia	scientific; systematic
20. Mortality of animals in Nairobi National Park (1973/74)	East African Wildlife Society	scientific; systematic
21. WWF/IUCN/SSC elephant conservation study (1977-78)	IUCN/SSC Elephant Specialist Group	international conservation programme; systematic
22. Aerial census of Tsavo National Park (1978)	IUCN/SSC Elephant Survey and Conservation Group	international conservation programme; systematic
23. Study of very large herbivores (1978/79)	World Bank/Mwenge International Ltd	game management; systematic
24. Integrated Project on Arid Lands (1977-)	UNEP/UNESCO	predevelopment study; systematic
25. Total count of black rhinoceros in Tsavo National Park (1978)	Wildlife Conservation and Management Department	game management; systematic

^a Other projects which included minor elements of aerial counting are not listed.

a need for better coordination and more serious evaluation of aerial survey projects.

CONCLUSIONS

Experience in Kenya over the past 15 years indicates that quantitative data on natural resources and the environment can be collected quickly and economically over large areas of land by visual survey from low-flying aircraft. However, aerial surveys do not always produce acceptable levels of accuracy, in spite of significant advances over the years in sample design, observer selection and training. In addition, in Kenya there has been a proliferation of isolated surveys and some have lacked well-defined objectives and have been of questionable practical value.

Inadequate levels of accuracy have resulted partly from inappropriate sample design: the choice of sample design is a major point of dispute among practitioners in the field. The limitations of human observers are another source of error. More careful observer selection and training have recently been initiated, but it has been found difficult to assess or compare observer performance objectively.

A number of innovations have been introduced over the past decade to increase the accuracy of aerial survey work. These include high-altitude photographs and satellite imagery, height control aids such as radar altimeters and shadow-meters, the improved use of photography and other data recording devices, in some cases the use of thermal infrared scanners, and the coordination of aerial survey work with other types of data collection activities on the ground.

There has also been a sharply increasing awareness over the past decade of the information needs of administrators and development planners. The future of aerial survey work in Kenya depends on the accuracy, the relevance, the timeliness and the cost-effectiveness of the information which this technique can provide,

relative to other types of data-collection activities. The present workshop was organized with the hope that some of the practical and methodological problems can be resolved and that aerial survey techniques can be fruitfully applied to a wider range of administrative and development problems.

EXAMPLES OF LOW-LEVEL AERIAL SURVEYS CONDUCTED IN
AFRICA FROM 1968 TO 1979: ONE FIRM'S EXPERIENCE

R M Watson and C I Tippet
Resource Management and Research

INTRODUCTION

The role of light aircraft in collecting information about natural resources has been recognized for some time, particularly in the context of development planning (Watson et al, 1975). Wilson and Adams (1977) and Wilson (1979) have pointed out that surveys conducted from light aircraft can be interposed with great advantage between information collection exercises based on remote sensing, particularly aerial photography and, more recently, satellite imagery, and traditional ground-level surveys. These authors describe a series of surveys carried out in western Sudan where each increasingly precise level of survey guided the successive stages of work with appreciably lower overall costs. In this context, low-level aerial survey is one of a spectrum of area survey methods (see Figure 1).

In this discussion, the role of light aircraft remote sensing methods will be described, using as examples a number of surveys of different kinds carried out by Resource Management and Research (RMR), often in association with other organizations and individuals. This consulting firm has extensive experience in the field, having carried out surveys in nine African countries and over international waters since 1968, covering a total of 3.5 million km² with an estimated 69 million domestic livestock, 6.5 million wild animals, more than 17.5 million ha of cropland and more than 35 million people.

Figure 1. The spectrum of area survey methods

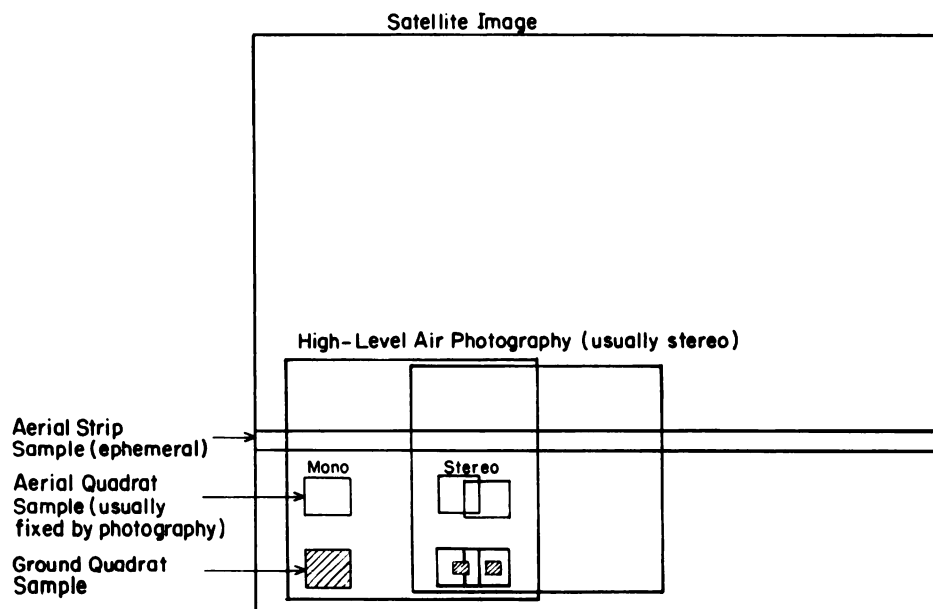

Vehicle	Scale of General Use	Usual Cover	Sensors	Resolution	Primary Use
Satellite	1:1 000 000 - 1:250 000	total	various: basically scanning radiometers	gross (1 - 2 ha)	mapping
High-Level Aircraft	1:20 000 - 1:100 000	total	cameras		mapping + overall (gross) quantifications of resources + use patterns
Low-Level Aircraft or Helicopter	1:300 - 1:20 000	sampling: usually quadrats	cameras		quantifications of resources + use patterns requiring photogrammetric base
Low-Level Aircraft or Helicopter	not applicable non-photogrammetric	sampling: usually strips	human observers and oblique small-format cameras		quantifications of resources + use patterns not requiring photogrammetric base
Landrover, Helicopter, STOL Light Aircraft or Foot	not applicable non-photogrammetric	sampling: usually quadrats, frequently linked with low-level photogrammetry	human observers using a range of resource survey equipment	fine (microscopic)	'ground truth'

SURVEY OBJECTIVES

This workshop appears to have been structured as though the ultimate survey objective or use to which information is to be put automatically determines methodology. The present authors consider this approach misleading. There is no inherent difference between a count of animals carried out for a census, for development planning or for project monitoring. In certain circumstances, monitoring surveys might require higher precision and tolerate larger uncorrected biases, development surveys occasionally tolerate lower precision but place more importance on distribution information, and censuses, in theory at least, might not require distributional information, though such a situation would be unlikely. In this way, the intended use of survey information does influence the way in which it is collected. However, in the experience of the authors, the intended use of a survey is seldom, if ever, defined with sufficient precision to be used as the sole basis of survey design. In practical terms, if the purposes of a survey are to provide a useful definition of the methods to be used, the following information must be provided at the outset:

- the subject or subjects of the survey (e.g. livestock numbers and distribution or a map of range vegetation)**
- the time(s) and season(s) when the survey should be carried out, if relevant**
- the numerical, spatial and possibly temporal levels of precision desired**
- the level of accuracy required (in fact, all surveys seem to require high levels of accuracy)**
- the funding available for the survey.**

Alternatively, if the user can provide a sufficiently detailed account of the objectives of the survey, the information listed above could be derived as a basis for survey design. Pratt (personal communication) suggests that an appropriate survey method could be devised on the basis of a classification of the uses to which the survey information will be put. The experience of the authors, however, does not suggest that such a classification could provide an adequate basis for survey design.

In practice, survey design is defined primarily in terms of the budget, with the method adopted a compromise between the information parameters desired, as listed above, and the available funds. Very often, the critical trade-off is between numerical precision and cost. Light aircraft survey was devised in the unsophisticated environment of field research operated on shoestring budgets, and it has become a tool in commercial survey operations largely because it is inexpensive. A review of survey objectives may well indicate in some cases that the use of light aircraft is less appropriate than other approaches, or that, although no other approach is technically or economically feasible, neither will the use of light aircraft provide sufficiently extensive, precise, frequent or accurate information on enough topics to warrant its use, given the available funding.

Essentially, light aircraft survey involves the operation of the aircraft as an observation platform in order to collect information about resources and their use. Broadly speaking, to complete such a survey, five groups of problems must be solved, though they overlap to some extent:

- administrative problems, including management, finance, purchasing, staffing contractual terms, clearances and insurance
- operational problems, including flying, fuelling and maintaining the aircraft, operating sensing and recording equipment and arranging the work, food, sleep and leisure of the crews at the survey site
- survey design problems, including flight patterns, stratification, sampling, aircraft heights and speeds
- observational problems, involving the translation of the information on the ground into a record which relates in a known manner to that information
- processing problems, involving the transformation of the records collected from the aircraft into a form which the client can use.

The objectives of a survey influence only the problem of survey design, and even here their influence is limited by operational and observational considerations. The authors' experience has been that the main difficulties in light aircraft survey methods

lie in the administrative, operational and observational areas, while the most serious controversies lie in the observational and, to a much lesser extent, the survey design realms. In conclusion, a classification of methods according to objectives, even if these are comprehensively and unambiguously defined, would seem to be of limited value, either for describing methods or for resolving some of the controversies which exist in the field of low-level aerial survey. Figure 2 illustrates the relationship between survey objectives and methods.

In the following sections, the chief features will be described of a number of low-level aerial surveys which have been carried out since 1968. These descriptions illustrate the versatility and usefulness of the basic light aircraft survey method and indicate some important variations in survey design.

A SURVEY OF CROCODILE IN WESTERN AND CENTRAL UGANDA

A survey of crocodile in western and central Uganda was carried out by Watson with I S C Parker under a contract between Wildlife Services Ltd, the Uganda Fisheries Department and the Uganda National Parks (see Parker and Watson, 1969, 1970). It involved an early attempt to account for major sources of bias by calibration.

A total count of crocodile along river banks and lake shores was made from a Cessna 185 aircraft flying at 128-160 km/hr from 30 to 20 m above the water. This approach was considered feasible because the distribution of crocodile was sufficiently confined to the river banks. The main features of the survey design are illustrated schematically in Figure 3.

The authors were well aware that their total count was a gross underestimate of the number of crocodile in the area, and so attempted to calibrate their figures (i.e. derive a bias factor) by counting a section of the river using supposedly more accurate methods. Counts were made from a helicopter in daylight, from a helicopter at night using spotlights and from a boat at night, also using spotlights. It

Figure 2. The influence of objectives on methods of low-level aerial survey

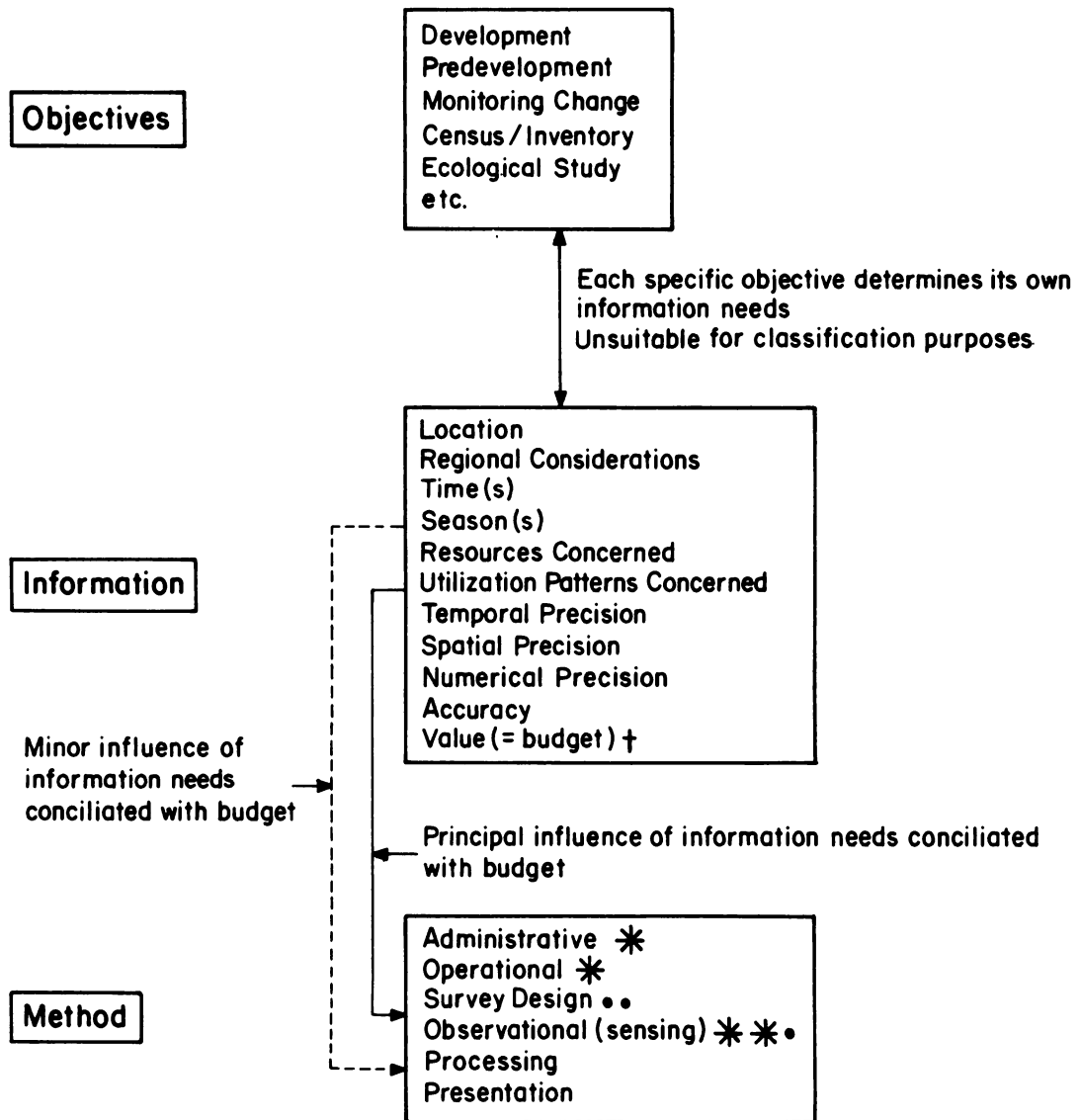

- † Indicates dominant factor.
- * Indicates areas of problems.
- Indicates areas of controversies.

was assumed that all crocodile were seen from the boat at night because this method yielded the highest counts for a particular stretch of river. From these figures, a bias factor was derived which was used to correct the total count for the entire area. Graham (1968) corrected crocodile counts carried out at Lake Turkana in the same way.

A SURVEY OF LIVESTOCK ON THE ALLEDEGHI PLAINS OF ETHIOPIA

A survey of livestock on the Alledoghi plains of Ethiopia was carried out by Watson under a contract between RMR and the Awash Valley Authority (see Watson et al, 1973a). It consisted of a typical stratified survey using random strip sampling. A Piper Super Cub was flown at 97 km/hr at a height of 113 m, as determined by radar altimetry. Counting was carried out through an open window.

The Awash Valley Authority wished to satisfy themselves that the pilot/observer could count groups of livestock accurately. They therefore placed small groups of cattle, sheep, goats and camels on the plains accompanied by members of their staff carrying large identifying numbers. In addition, some larger groups of cattle were confined in enclosures for counting. Remote, visual counts were made of small groups of about 15 or less, while counts of larger groups were made from photographs. Both types of counts proved sufficiently accurate.

This and other experience has suggested that for most people remote counting becomes inaccurate for groups of 15 or more individuals. To illustrate this, the reader should count the small circles in Figure 4 without touching or marking the page, i.e. by remote counting. The results should be recorded and then the items recounted by touching and/or marking.

A SURVEY OF LAND USE AND LAND POTENTIAL IN KARAGO-GICIYE, RWANDA

A survey of land use and land potential in Karago-Giciye, Rwanda was

Figure 3. Schematic view of crocodile survey in Uganda

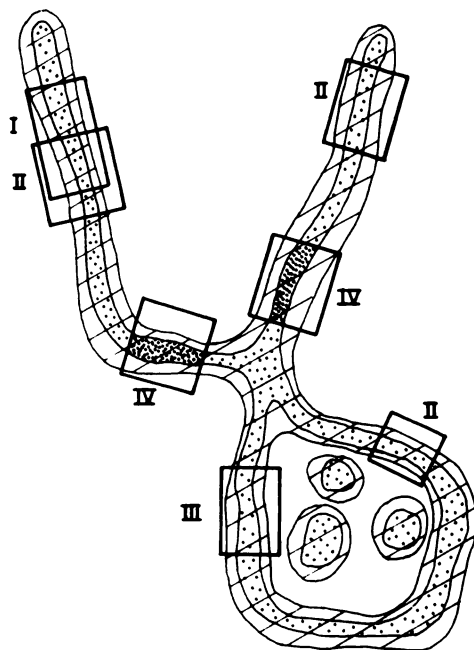

Limits of distribution of crocodile (assumed on ecological + biological grounds)



High density of crocodile determined from survey



Area totally counted from low-level aircraft

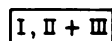

Trials performed on randomly selected subsections of river bank and lake shore to find a method which reduces or eliminates bias. Method II (night counts from a boat using spotlights to count eyes) was judged to give the least bias (but does not eliminate it).

This method was then applied to further sections of bank + shore to give a reasonably precise correction factor for the whole population.



Photogrammetric quadrat sampling of sections of river bank + lake shore lines occupied by densest crocodile populations provided status information. Since no segregation took place these data were taken to apply to the whole population.

Figure 4. Remote counting test

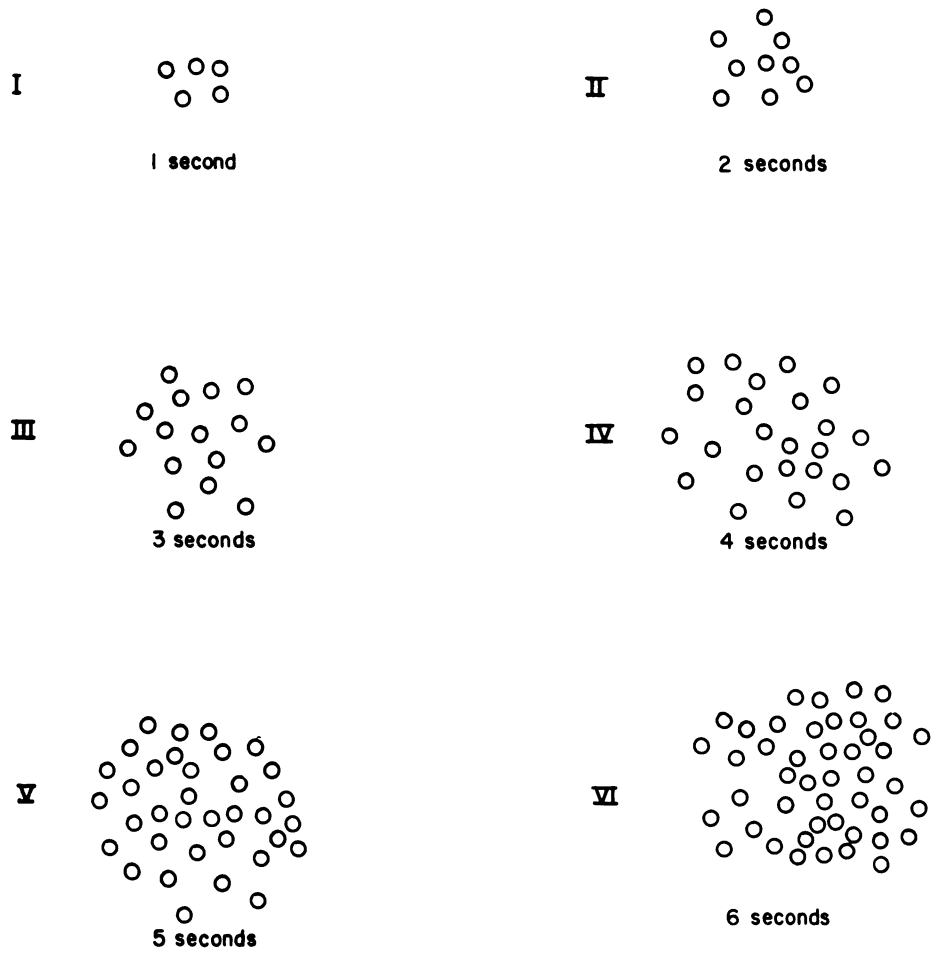

Count each group quickly (the approximate time for a quick count is given) without touching or marking the page and record your results. Then count in about the same time using a pencil to touch and or mark each individual. Most people will find a marked loss of accuracy in the remote (ie first) counts of the larger groups.

carried out by Watson and Tippet under a contract between RMR and the World Bank (see Watson et al, 1973b). Because the area covered was characterized by steep slopes and the items to be estimated occurred in high densities, a STOL (short takeoff and landing) aircraft was needed. A Piper Super Cub was used which could climb steeply and fly sufficiently slowly for the observer to count or photograph all the items seen in the sampling strip. Counting and photographing were done through an open window.

The World Bank was particularly interested in the development of small-holder tea production, so the sample was stratified in terms of altitude, topography and current patterns of land use. Two types of sampling were used. First, to estimate livestock numbers, human population (by means of house estimates) and overall land-use patterns, stratified random sampling of carefully oriented strips was employed. The regularity of the valley system in Rwanda and the altitudinal variations associated with this valley system (a deeply dissected sloping peneplain) made it more than usually important to randomize (with probability proportional to size) the selection of sampling strips and to orientate these strips at right angles to the primary ecological axis (Watson and Tippet, 1975). Second, for a more detailed investigation of soils, cropping patterns and socio-economic parameters, a random selection of quadrat sampling units was photographed vertically in stereo at a scale of about 1 : 3000. These sampling units were also surveyed on the ground to determine soil types, identify standing field crops, establish recent cropping histories and obtain simple socio-economic information by questionnaire from families whose houses and/or fields fell within the sampling unit.

The two authors carried out this survey as a team, alternating as pilot and passenger. At the outset, it was planned that the passenger would operate stop watches to record land-use categories and would possibly count houses in the sampling strip, in addition to his primary function of changing film magazines and checking camera functions. It was discovered, however, that the passenger's performance fell off markedly after the first hour's flying, and after the first 2 days the pilot made all the observations and took all the 35 mm photographs. The design used for this survey is represented schematically in Figure 5.

Figure 5. Simplified schematization of survey design used for resource investigation in Karago-Giciye, Rwanda

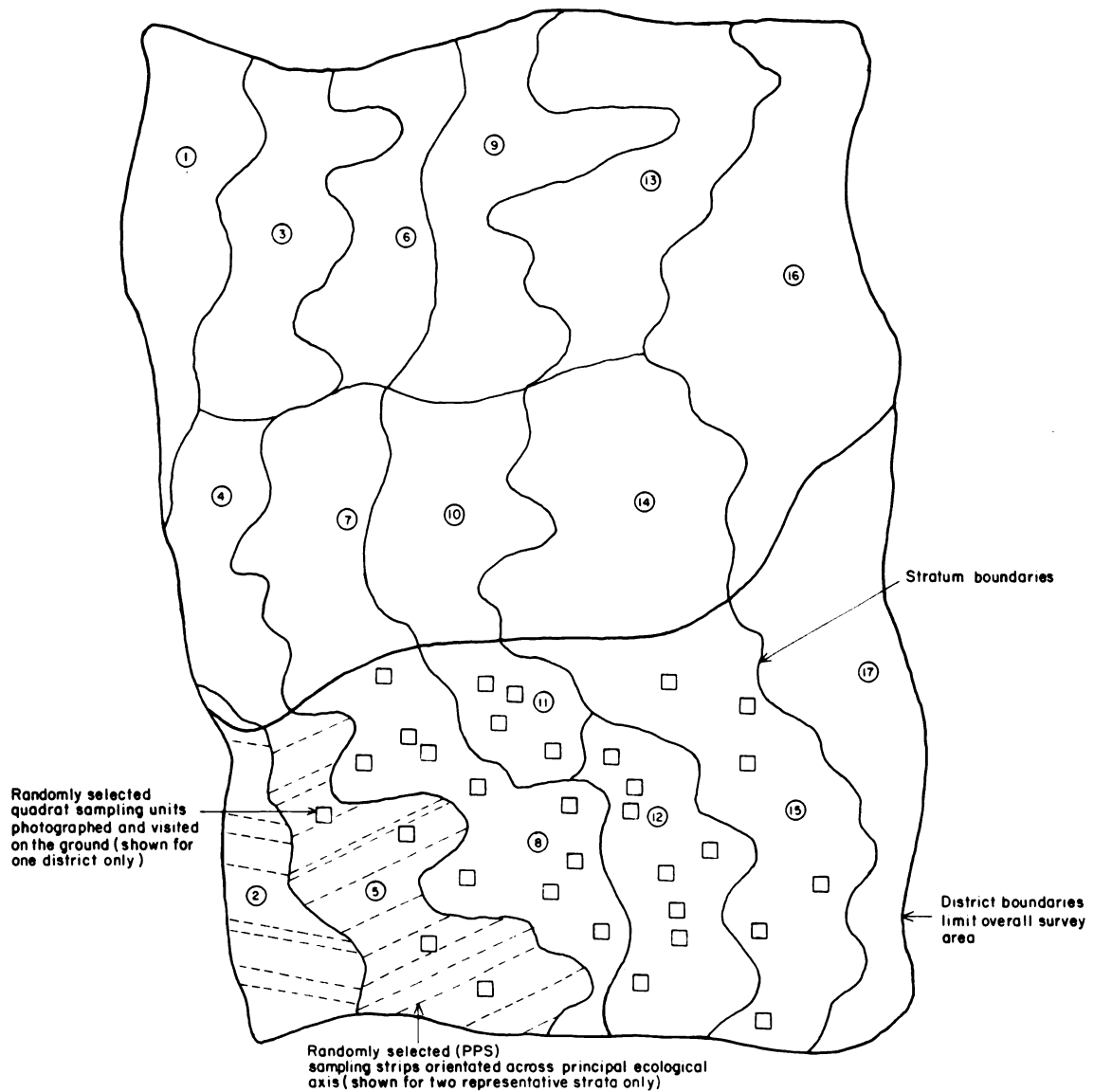

Strata

- 1, 2, 16, 17** Too high or too low for tea-growing potential. Sampled at low intensity to build up overall land-use picture since farmers in other strata also cultivate fields and graze livestock on these higher and lower lands. Only aerial strip sampling used.
- 6, 7, 8** High strata with limited tea potential. Strata 6 and 7 were differentiated on the basis of soil differences, sampled at medium density by aerial strip sampling and at low density by aerial quadrats which were photographed and then visited on the ground. Area frame sampling was extended to cognate frame sampling by investigation of households whose number and distribution had been established from strip sampling.
- 9, 10, 11, 12** Middle-altitude strata with high tea-growing potential. Strata 9 and 10 were differentiated on the basis of soil differences; strata 11 and 12 were differentiated on the basis of densities of human land use. These strata were sampled at high density by both aerial strip sampling and quadrat (aerial and ground) sampling with area frame extended to cognate frame as already described.
- 13, 14, 15** Low strata with limited tea-growing potential. Strata 12 and 13 were differentiated on the basis of soil differences. Sampling as for 6, 7 and 8.

A PHOTOGRAMMETRIC AND QUESTIONNAIRE INVESTIGATION OF THE AGRICULTURAL SYSTEMS OF FIVE FAMINE-AFFECTED PROVINCES IN ETHIOPIA

A photogrammetric and questionnaire investigation of the agricultural systems of five famine-affected provinces in Ethiopia was carried out by Watson and Tippett under a contract between RMR and the Ethiopian Ministry of Agriculture (see Watson et al, 1974). The ministry asked for a detailed assessment of crop-production systems in the five provinces, with special emphasis on the status of agricultural production during the 1973 famine.

A two-stage stratified random sample was carried out, using quadrat sampling units demarcated as vertical photographs of 13 cm format at scales between 1 : 3000 and 1 : 6000. Because altitude and the aspect of slope are the most important determinants of rainfall in the Ethiopian highlands, stratification was based mainly on these two factors. A random selection of the quadrat sampling units was identified for the second stage of sampling by trained agricultural enumerators on the ground. This involved a detailed ground-level examination of the photographed sites and interviews with the local people using a questionnaire. The ground teams were provided with a 1 : 50 000 aerial photograph and a 1 : 3000 - 6000 sampling unit photograph to guide them to their sites, but some of them had difficulty finding the sites and the aircraft was used to guide them. The survey design is shown schematically in Figure 6.

The enumerators proved unwilling to walk to the sampling sites which fell at substantial distances from the roads. Therefore, the ground-level investigation had to be based on units falling sufficiently close to the roads to be reached by Landrover. Because this departure from random selection might have introduced an element of bias, a helicopter was used to collect information from a few very inaccessible sampling units and tests were carried out to see if there were detectable correlations between accessibility (in this case distance from a motor road) and any of the measured parameters of the rural economy.

Figure 6. Simplified schematization of survey design used for crop production study in the Ethiopian highlands

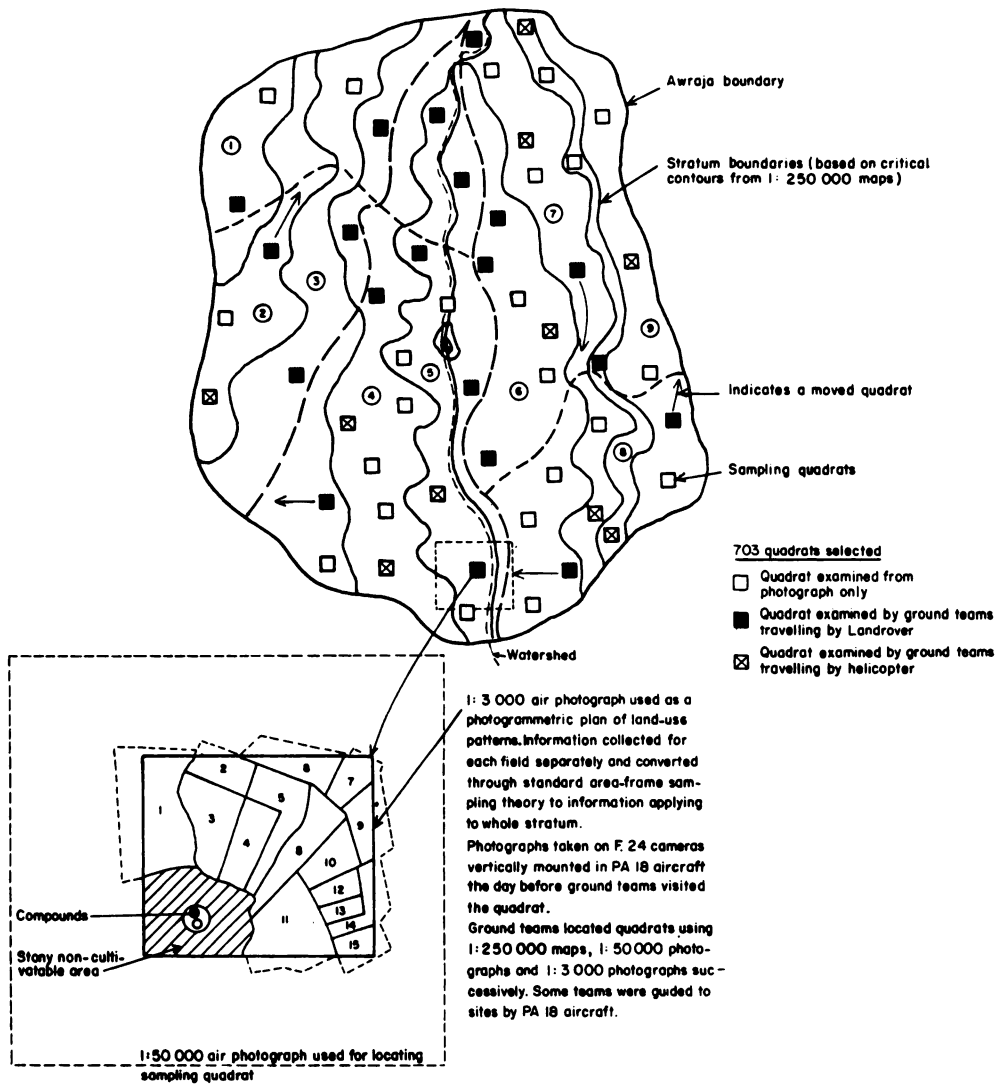

- Strata**
- 1 1500m to 1800m western facing slopes: low-density cropping and other human use, low-density sampling effort.
 - 2, 3, 4 Western facing slopes 1800 - 2100, 2100 - 2300, 2300 - 2500 m respectively: high-density cropping and other human use, high-density sampling effort.
 - 5, 6 2500-2800m slopes, western and eastern facing respectively: medium-density cropping and other human use, medium-density sampling effort.
 - 7, 8 Eastern facing slopes, 2200 - 2500, 1900 - 2200m respectively: high-density cropping and other human use, high-density sampling effort.
 - 9 1900 - 1700m eastern facing slopes: very low-density cropping and other human use, very low-density sampling effort.

Because of the rugged terrain in the Ethiopian highlands and the short air-strips in the area, a Piper Super Cub aircraft was used. In addition to carrying out the survey work, this slow-flying, manoeuvrable aircraft proved useful in guiding the enumerators to their sites.

A PILOT FORESTRY INVENTORY IN SOUTHERN SUDAN

An inventory of forests and woodlands was carried out by Watson and Tippet in southern Sudan with assistance from J J Beckett and F Jolly, as a contract between RMR and the Sudan Forestry Department (see Watson et al, 1976). A three-stage random sample was constructed, based on the identification of woodland/forest types from 1 : 40 000 aerial photographs which were already available. Initially, systematic aerial reconnaissance was carried out and these photographs were annotated and a 1 : 40 000 base map prepared. Each woodland/forest type became one stratum in the survey design.

Within each stratum, quadrat sampling units were selected at random. At the first stage, a vertical monochrome photograph at 1 : 3000 - 6000 was taken of all the sampling units. Within each of these quadrats (i.e. photographic frames), a smaller quadrat was selected at random and marked on the photographic print. At the second stage, these smaller quadrats were photographed vertically or semi-vertically using 35 mm Ektachrome film and the photographs were examined at 6 times enlargement and the species of 80% of the tree canopy identified. At the third stage, a random selection of these sampling units was visited on the ground by trained teams of foresters. Each team had a copy of the monochrome print of the original sampling quadrat which they annotated by identifying the species of trees in the smaller second-stage quadrat area and estimating timber volumes using standard forestry methods. The enlarged Ektachrome images were then compared with the annotated monochrome prints and a key was developed for species identification. Similarly, canopy size and timber volume relationships were constructed for each species and type of species. The key was then applied to the sampling units which were not visited on the ground, to provide estimates (of known precision) of species

composition and timber volume for each forest type in the entire area. A schematic presentation of the survey design is given as Figure 7.

A slow-flying Piper Super Cub with open panels was used for this work. In addition to aerial surveying, the aircraft was used to guide ground teams to the sampling sites and to drop monochrome prints to the teams at each site, as the film was processed at some distance from the field camp.

A NATIONAL SURVEY OF LIVESTOCK AND OTHER RESOURCES IN SIERRA LEONE

A livestock and natural resources survey was carried out by Watson in Sierra Leone under a contract between Hunting Technical Services and the Government of Sierra Leone (see Watson, 1979). The government wished to bring together information on a wide range of resources simultaneously in order to evaluate and compare a number of development possibilities.

The design of this survey was influenced by the fact that the ecological units, which are usually the basis of stratification in a livestock and natural resource survey, are very small in Sierra Leone and occur in repeated patterns in association with a well developed drainage system. For this reason, in devising a stratification of the country, greater emphasis had to be placed on administrative units and sheer convenience, and this had a profound influence on the subsequent development of the survey method.

For one thing, it was known that there were virtually no livestock in the southern districts, so it was possible to demarcate large strata in the south and sample them at very low density. In this way, sampling effort could be concentrated in the areas where most of the livestock occur, resulting in more efficient estimates. A similar focusing of sampling effort was used for the Sudan National Livestock Census and Resource Inventory (see Watson et al, 1977).

Figure 7. Simplified schematization of survey design used for forestry/timber inventory in southern Sudan

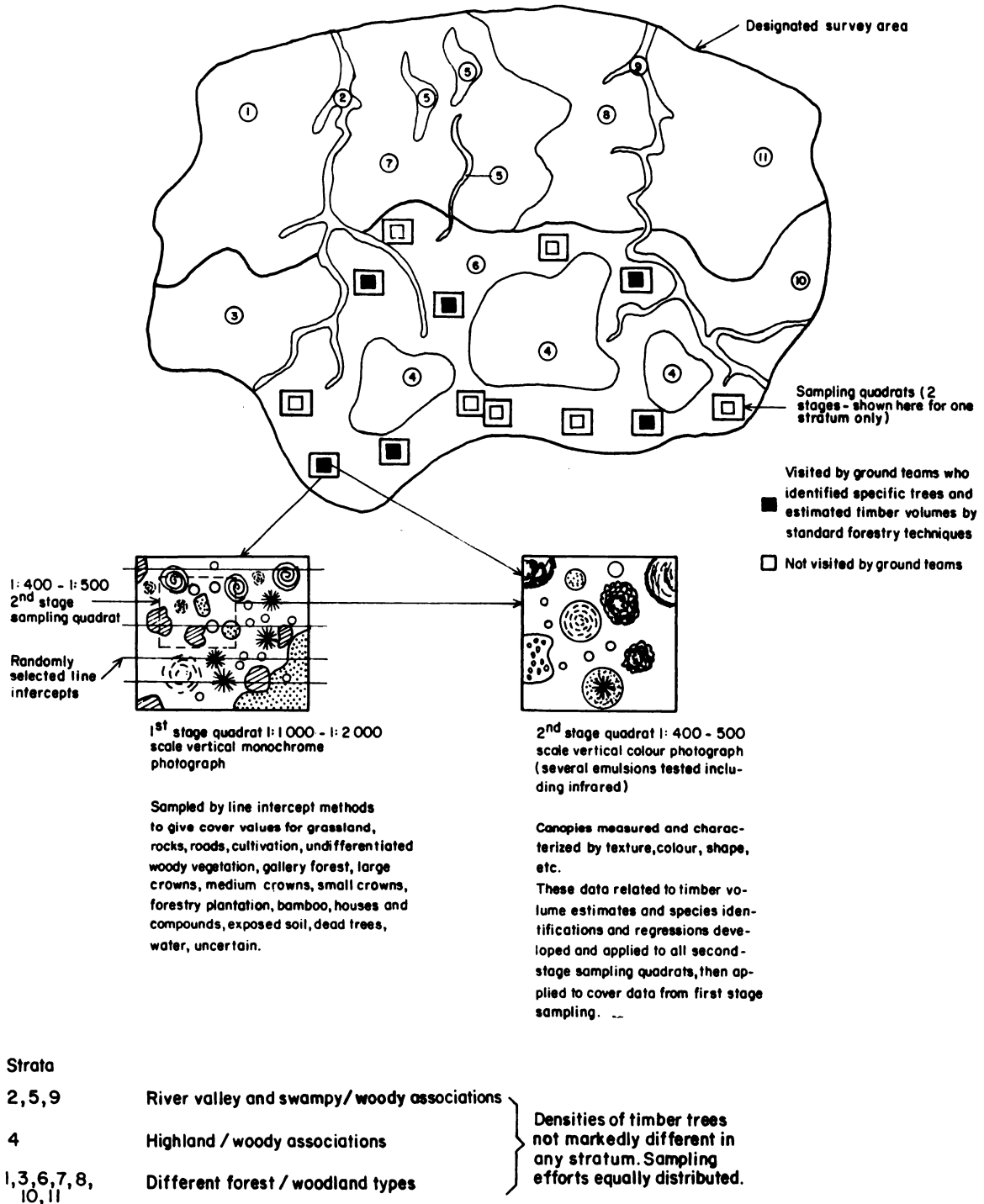

Each sampling stratum was extremely heterogeneous in terms of ecology and land use. This situation posed two problems: first, it was difficult to describe the system of livestock utilization in terms of distributions derived from the survey, and second, if calibration factors had been developed for entire strata or groups of strata, as is usually the case, the corrections for bias would have had high variance. These problems were dealt with by classifying each animal or group of animals observed according to an ecological or land-use type. As the proportion of each ecological or land-use type in each stratum was also recorded, it then became possible to break down estimates of livestock numbers and densities at the stratum and national levels according to ecological or land-use types. This produced an initial understanding of the overall system of livestock keeping and land use. In addition, calibration factors could be developed for each ecological or land-use type, providing more precise correction factors for bias.

This study also involved special observation problems. The livestock in Sierra Leone, and in particular the cattle, occur in very small groups or frequently as isolated animals. The animals are also smaller and of more uniform colour than the East African breeds, being a dwarf type and generally a pale tawny brown. In addition, the vegetation of the country is composed of dense forest, woodland or wooded grassland, with very tall mature grasses. Thus, the only time to carry out an aerial survey was at the end of the dry season, when most of the tall grass had been burnt and many of the livestock were grazing the fallow croplands. Even at this time, calibration methods showed very large bias. During the wet season, aerial survey methods would probably not be acceptable.

In each sampling strip, a large number of resources and utilization features were recorded. Because of the high density of information observed, a slow-flying Piper Super Cub was used. A full list of the features recorded is given in Table 1 and the survey design is represented schematically in Figure 8.

Table 1. Items included in a national survey of livestock and other resources in Sierra Leone

1. **Livestock**
Cattle, sheep, goats, camels, donkeys, horses and mules
2. **Houses - occupied dwellings**
Type 1 - Circular houses with conical grass roofs, set on mud, stone, brick or timber walls
Type 2 - Houses with conical grass roofs which extend to the ground, concealing, or in place of, circular walls
Type 3 - Houses with ridged grass roofs, which extend the whole length of the building, over square or rectangular mud, stone, brick or timber walls
Type 4 - Houses with ridged grass roofs, but whose ridges do not extend the whole length of the building (and whose roofs therefore have a pitch on all four sides), over square or rectangular mud, stone, brick or timber walls
Type 5 - Houses with iron roofs
3. **Other structures**
Type 6 - Agricultural shelters: Various grass-roofed structures used by farmers in their fields, but not permanently occupied
Type 7 - Field stores of agricultural products and byproducts
Type 8 - Abandoned agricultural shelters
Type 9 - Abandoned houses of other types
4. **Compounds and villages**
Type 10 - Compounds presumably occupied by a single family or household characterized by one (or several) dwelling(s) with marked or fenced compounds, small stores, kitchens, etc
Type 11 - Villages and small towns in which individual household compounds are not always present or distinguishable
5. **Livestock-associated structures**
Type 12 - Occupied livestock 'enclosures' (which in many cases have no surrounding fence, and can be identified only from the accumulation of dung and the compaction of earth)
Type 13 - Abandoned livestock 'enclosures'
Type 14 - Small fenced salting places, where a mixture of salts and soil from termitaria is provided to cattle
6. **Land-use**
Code 1 - Valley grazing: This category includes fallows, which are not easily distinguished from undisturbed land in the valleys. In fact it could be argued that all the grassy valley floors are fallow lands since the climax vegetation of these valleys is palms and other woody vegetation
Code 2 - Flooded valley grazing
Code 3 - Irrigated cassava on valley floors

Table 1, cont.

- Code 4 - Valley palm lands: These are valley floors which have not been cultivated recently, or ever
 - Code 5 - Rice growing in valleys or on parts of the wider flood plains
 - Code 6 - Rice fallow: This category is difficult to distinguish in narrow valleys from valley grazing . The rice fallows recorded thus refer only to rice cultivations on the flood plains
 - Code 7 - Fallow lands other than those of the narrow valleys and flood plains. A substantial proportion of these are rice fallows
 - Code 8 - Rain-fed cassava on hill slopes
 - Code 9 - Other crops on hill slopes
 - Code 10 - Bananas on hill slopes
 - Code 11 - Oil palm: This category presents special problems. Oil palms occur at low density over much of the country, and only a very small proportion of these are intensively managed and exploited in plantations. In this survey, land use has been categorized as under oil palm when trees are spaced on average at less than 50 m. Clearly, other forms of land use can take place under such low densities of palm, and this category of land-use does not exclude other types
7. **Wildlife**
All wildlife resources are recorded by species
8. **Surface water sources**
Flowing rivers, wells, rain water pools, riverine pools, small shallow reservoirs, large (man-made) reservoirs, boreholes, etc.
-

Source: Watson (1979).

A VEGETATION MAP OF THE CENTRAL RANGELANDS OF SOMALIA

A vegetation map of the central rangelands of Somalia was prepared by Watson and Tippett in association with C F Hemming, J B Gillett, J J Beckett and V Scholes as a contract between RMR and the Somali National Range Agency (see Watson et al, 1979 and Watson and Tippett, 1979).

For this study, excellent 1 : 250 000 enhanced colour composite LANDSAT prints and 1 : 100 000 topographical maps were available. Initially, these materials were annotated by systematic aerial reconnaissance flights at 305 to 3 050 m, producing precise maps of range-vegetation and land-system boundaries. Except

Figure 8. Simplified schematization of the design used for national livestock and resource survey in Sierra Leone

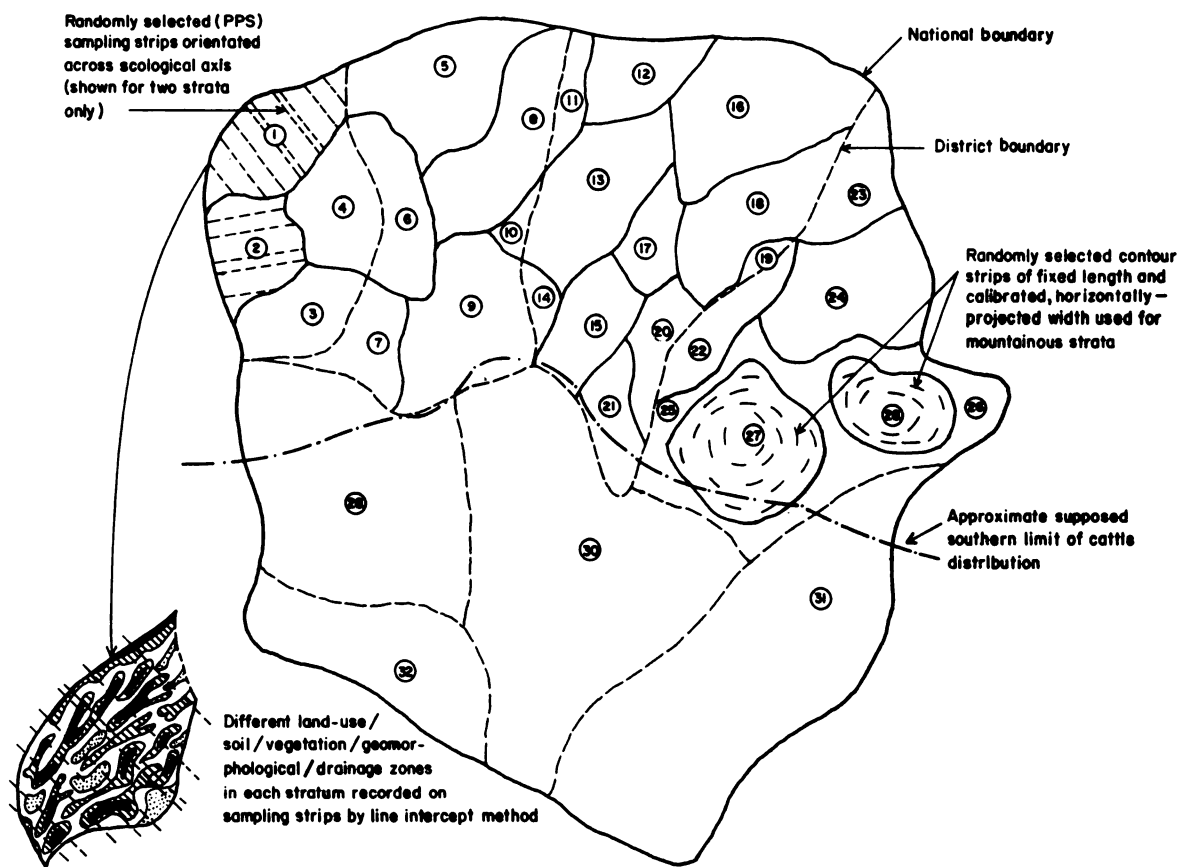

Strata

1 - 26

Strata very heterogeneous in physical and biotic terms. In general, areas of high livestock density were more intensely stratified. Because of this, and since some districts were specified as more important by the client, each district boundary was used in addition as a stratum boundary. Each stratum was classified according to the proportions of land in different land-use / soil / vegetation / geomorphological / drainage zones, determined by line intercept sampling. Livestock observed and counted in sampling strips were ascribed to these same zones. Those strata with higher livestock densities were sampled more intensively.

27, 28

Mountainous strata sampled with randomly selected contour sampling strips of fixed length. These strata were fairly uniform and were treated as such.

29, 32

These districts support very few livestock, each district has therefore been considered as a single stratum, and was sampled unintensively. Strata were not classified for ecological zones, nor were livestock so ascribed.

In the entire survey over 60 strata were identified.

where vegetation or land-system boundaries of great complexity or poor definition were encountered, this reconnaissance work was done from a Cessna 210 aircraft looking through perspex panels. The aircraft flew in two basic patterns: a systematic series of parallel lines 20 km apart at 1 525 m, while the observers studied vegetation and land-system boundaries at least 10 km on either side of the aircraft, and a more variable pattern over all the land-system boundaries and most of the range-vegetation boundaries.

Next, two-stage sampling quadrats were selected from the land-system units, using limited randomization. The sampling units were selected at random, but they were then moved to the nearest point at which they could be easily relocated, either from the air or on the ground. If this resulted in movement of a sampling unit to another range vegetation type or another variant of the original type, then it was rejected and another sampling unit selected. Once the sampling sites were identified, vertical or semi-vertical 35 mm Ektachrome photographs were taken at 1 : 4 000 - 12 000. For most sites, photographs were taken at three scales. The more accessible halves of the sampling units were also visited on the ground, and land use, soils and the taxonomy and structure of the vegetation were described. Because of the importance of browse for the livestock of the area, the taxonomic composition of the vegetation was considered particularly important. A representative selection of these sampling units was visited by Hemming and Gillett, who recorded detailed botanical descriptions. The survey design is shown in simplified schematic form in Figure 9.

The emphasis in this study on the relocatability of sampling sites was a response to the Somali Government's wish to establish a range vegetation monitoring programme based on fixed sampling sites. Because this survey was carried out as a preliminary to a much greater research and management effort financed through the World Bank, a wide range of materials was prepared. These included:

- a report on static range resources, including topography, climate, geomorphology, soils, drainage, erosion and land use

Figure 9. Simplified schematization of the design used for range-vegetation and land-system mapping and resource inventory of Somali central range-lands

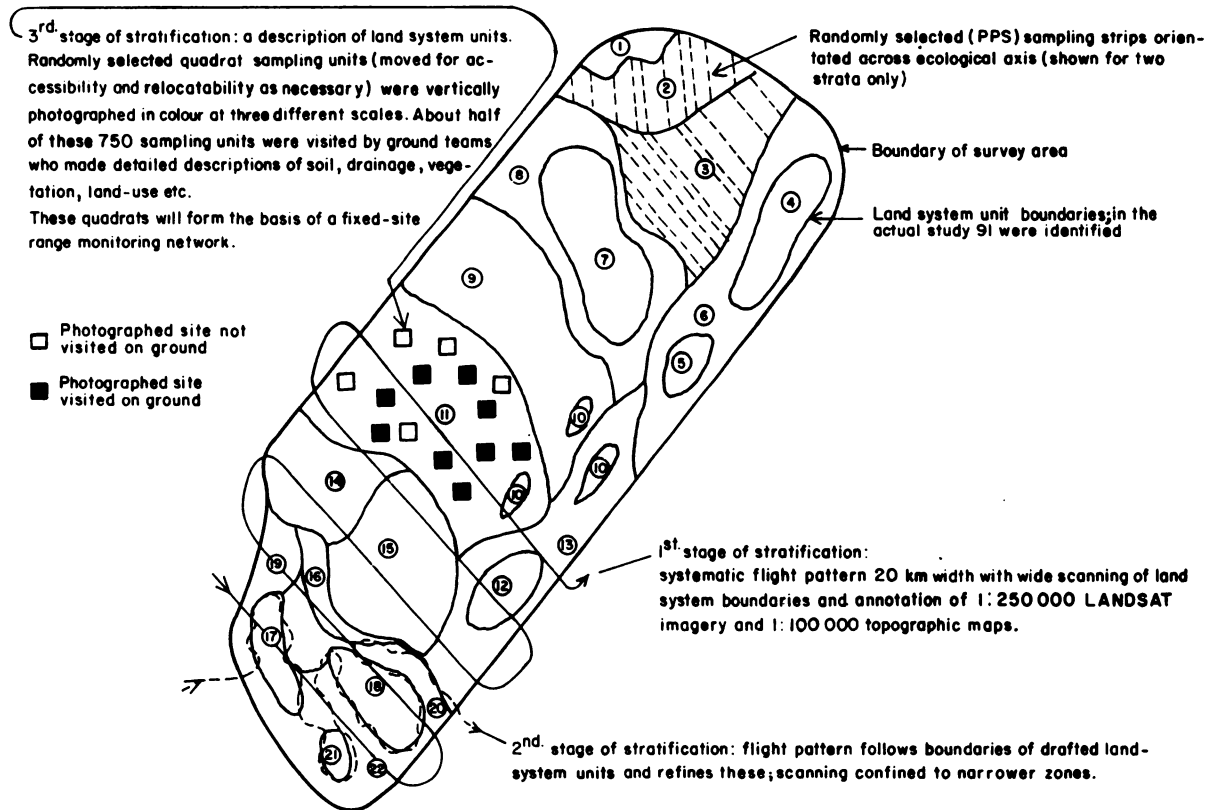

Strata
 1 - 22

Strata were classified into biological classes (9) and ecological zones (26).
 Strip sampling effort was proportionally greater in strata of higher livestock density and greater human use.
 Quadrat sampling effort was fairly uniform over the entire survey area.

- a set of maps at 1 : 1 000 000 accompanying the report
- more than 4 000 colour transparencies, indexed and fully documented, from about 750 sampling sites, which will form the basis of a fixed-site range monitoring programme
- a set of colour plates of a selection of ground and aerial sampling sites, illustrating the information available in the colour transparencies
- a collection of more than 800 identified herbarium specimens
- a preliminary checklist of plants in the area for use by range workers
- the enhanced colour composite LANDSAT prints, with a mosaic added to match the longitude/latitude format of the 1 : 1 000 000 maps
- 200 copies of a land-systems/range-vegetation map at 1 : 250 000 in 18 sheets
- acetate negatives and positives of 1 : 250 000 and 1 : 100 000 land system/range-vegetation maps
- computer printouts of wet- and dry-season census results, covering livestock, wildlife, houses by structural types, crop production patterns, surface water sources and boreholes
- 1 : 1 000 000 maps of the wet- and dry-season distribution of these features
- a report on the survey methods used and the main implications of the information provided by the census for possible development alternatives.

CONCLUSIONS

These examples of surveys conducted from light aircraft suggest the usefulness and versatility of this approach to information gathering, especially when used together with other survey techniques. Rather simple area frame sampling rules are followed and a system of stratification is devised appropriate to the information being collected.

A number of controversies exist among different practitioners in this field, however. The position of the authors on five issues will be discussed, mentioned in order of importance.

Bias

Bias, due to animals which are hidden or simply not noticed by the observer, is the most serious problem of current light aircraft survey methods. Livestock surveys have revealed biases (underestimation) of 3 to 59%, and the problem is more serious for wild species: 800% bias has been measured for reedbuck in tall grassland and 450% for elephant in medium bush woodland. It appears that medium or large groups of animals are much more likely to be spotted than individuals or small groups, regardless of the size, colour or even, to some extent, the behaviour of the animals. This increase in the probability of being spotted exceeds the level which would be expected from simple area or numerical relationships, and probably explains why undercounting is so much more substantial for wild animals than for livestock. Any aerial survey technique will always involve some degree of bias.

The aircraft platform

The authors have found that it is not possible to record information on strip samples from aircraft moving at high speeds. When the items to be observed occur in very high densities, quadrat sampling with a photographic record becomes necessary. It has also been found that a perspex window is a significant barrier between the observer and the subject being observed and that objects on photographs taken through a perspex window are more difficult to count.

Observers

Pilots, in our experience, produce more accurate counts when flying themselves than when they or other observers are being flown. The main reason for this is that an observer experiences stress when he attempts to perform a precise

visual task while being subject to movement which he does not control and cannot anticipate. This stress is evident as nausea, sickness, fatigue and lack of concentration. The authors have never flown with an observer who was capable of more than 2 hours' continuous attention, and at least half the observers with whom they have flown have slept within the first 4 hours of flight.

Training and motivation

The present authors believe that competent observers are born, not trained. The aerial survey method is essentially nontransferable until sensors replace human observers.

Stratification and selection of sampling units

In the authors' view, stratified sampling is always preferable to systematic sampling. Any basis of stratification is better than none, but a stratification based on ecological information is preferable to one which is artificial. The authors believe that the grids and other presentations of distribution based on systematic sampling provide illusions of precision; more detailed analysis of grid data, based on small numbers of non-independent sampling units is not justified by any statistical or mathematical arguments encountered by the authors.

THE KENYA RANGELAND ECOLOGICAL MONITORING
UNIT (KREMU)

D K Andere *

Kenya Rangeland Ecological Monitoring Unit

INTRODUCTION

The Kenya Rangeland Ecological Monitoring Unit (KREMU) was launched early in 1976 as a joint programme between the Governments of Kenya and Canada. Its purpose is the long-term monitoring of Kenya's rangelands, livestock and wild herbivores.

While rational wildlife management policies were being developed in Kenya to maximize income benefits to land-owners from tourist and hunting fees and to preserve wildlife as an alternative land-use resource, certain wildlife species were found to be seriously endangered and the hunting policy as a whole came into question. This crisis situation added impetus to the establishment of a national ecological monitoring programme. Beyond national park and game reserve boundaries, wild herbivores were sharing available grazing resources with livestock, and in these areas there was an urgent need to monitor trends in rangeland conditions and animal populations and distributions to ensure the conservation of wildlife and formulate the most appropriate multi-purpose land-use strategies.

The Kenya Government had recognized for some time the value of ecological monitoring as a tool for resource management. Ecological monitoring methods had been developed in eastern Africa for over a decade, though on a relatively small scale, for example by the Serengeti and the Ilkisongo Ecological

* The author wishes to thank D G Peden and J G Stelfox for reviewing this paper and W E Stevens for his continuous encouragement.

Monitoring Programmes. The value of these monitoring activities was becoming apparent, for instance in case studies involving the collection of baseline data for management of Amboseli National Park. With the establishment of KREMU, the methods which had been developed were adapted for large-scale monitoring activities.

KREMU was established as part of Phase II of the Kenya Livestock Development Project under the Ministries of Agriculture and Tourism and Wildlife. The Unit is directed by a Steering Committee, which meets regularly to provide policy guidelines, decide on priority survey areas and species and approve the reports produced. This committee is composed mainly of government officials from relevant ministries, and is chaired by the Permanent Secretary of the Ministry of Environment and Natural Resources. KREMU's reports and recommendations, particularly on land-use and conservation strategies, are also presented to an Inter-Ministerial Committee for implementation.

KREMU's main objectives are:

- to establish the basis for a reliable and continuous flow of information on livestock, wildlife and cultivation in the rangeland areas
- to suggest recommendations to the Government of Kenya on rangeland utilization
- to train Kenya nationals in the techniques necessary to carry out the objectives of the unit.

Several activities are carried out in pursuit of these objectives. Some of the main ones are:

- providing up-to-date baseline data on livestock and wildlife populations and distributions, as well as the extent and nature of cultivation in the rangeland areas of Kenya
- analysing and processing relevant data into a usable form for transmission to the Inter-Ministerial Committee with the approval of the Steering Committee
- making predictions on significant changes in numbers and spatial and temporal distributions of wildlife, livestock and cultivation in the Kenya rangelands
- indicating requirements and suggesting priorities for intensive follow-up research by other Kenyan ministries and agencies

- developing a computerized data storage and retrieval system for use by the unit
- developing and submitting recommendations on land-use issues to the Inter-Ministerial Committee with approval of the Steering Committee.

THE INITIAL TASKS

Very few precedents existed for planning and implementing a national ecological monitoring programme in Kenya. The first tasks could be described as 'ground work'. These included acquiring the necessary office facilities and purchasing and testing equipment. Further initial tasks will be discussed in more detail.

Identifying ecological units

Because KREMU's terms of reference cover the entire rangeland area of Kenya - some 500 000 km² - it was necessary at the outset to define manageable study areas. A number of factors were taken into consideration, including KREMU's capabilities in terms of manpower, equipment, time and other resources. Priorities in the selection of survey areas were also dictated by the requirements of the Kenya Livestock Development Project, Phase II.

A major initial task was to demarcate the Kenya rangelands into ecological units appropriate for monitoring purposes. Accordingly, a LANDSAT false-colour mosaic was prepared and 44 ecological units chosen, based on background knowledge and experience concerning types of vegetation, topography, animal migration patterns and seasonality factors affecting regional rangeland ecology (Figure 1). A series of survey flights was then undertaken to check and adjust the ecological boundaries of the units. These 44 units have since been used as a basis for KREMU's on-going ecological surveys. This work was done with the assistance of M D Gwynne under the auspices of the UNDP/FAO Kenya Habitat Utilization Project, working in cooperation with KREMU's senior scientific staff.

Testing survey methods

To some extent, KREMU was able to adopt methods which had already been tested and applied in eastern Africa, but it became increasingly clear that new

Figure 1. KREMU's 44 ecological units covering the rangelands of Kenya

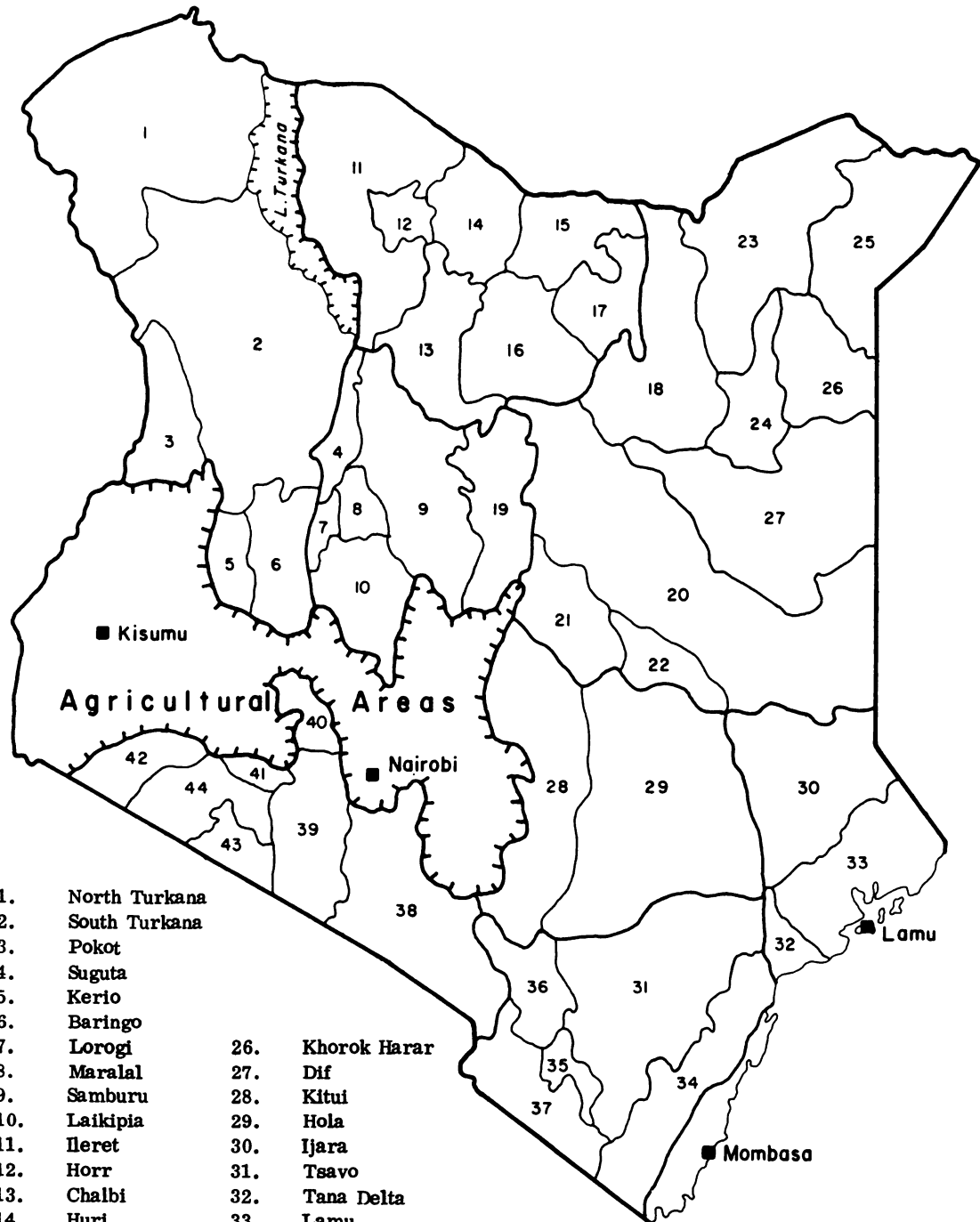

- | | |
|-------------------|------------------|
| 1. North Turkana | |
| 2. South Turkana | |
| 3. Pokot | |
| 4. Suguta | |
| 5. Kerio | |
| 6. Baringo | |
| 7. Lorogi | 26. Khorok Harar |
| 8. Maralal | 27. Dif |
| 9. Samburu | 28. Kitui |
| 10. Laikipia | 29. Hola |
| 11. Ileret | 30. Ijara |
| 12. Horr | 31. Tsavo |
| 13. Chalbi | 32. Tana Delta |
| 14. Huri | 33. Lamu |
| 15. Sololo | 34. Kilifi/Kwale |
| 16. Marsabit | 35. Taita Hills |
| 17. Chera | 36. Mito Andei |
| 18. Bokhol | 37. Jipe |
| 19. Archer's Post | 38. Amboseli |
| 20. Ewaso Ngiro | 39. Magadi |
| 21. Meru | 40. Naivasha |
| 22. Garissa | 41. Narok |
| 23. Tupo | 42. Logorien |
| 24. Wajir | 43. Loita |
| 25. Mandera | 44. Mara |

methods had to be developed, tested and standardized, particularly for the ground monitoring programme. A systematic ground survey (SGS) programme was launched, aimed at determining vegetation trends, soil moisture and rainfall patterns. This information had to be standardized for varying vegetation communities to allow meaningful analysis and interpretation of results.

Training staff

Once staff members were selected, a residential aerial observer training course was organized, as described by Dirschl et al (1978a). On-the-job training was provided to biologists and ecologists in the techniques of aerial and ground-level ecological monitoring. Trainees were also taught how to use LANDSAT images to enhance ground data collection.

Designing appropriate computer programmes

An appropriate data storage and retrieval system was designed, along with the necessary statistical procedures for the analysis of survey data. Most of KREMU's data processing has been carried out by the Central Bureau of Statistics with an IBM 370 computer. For simple data analysis, KREMU also has its own mini-computers (HP 9830 and Radio Shack TRS 80). The design of appropriate sampling strategies for the collection of biological and ecological data has been an on-going activity of the entire scientific staff, involving continuous exchange of views.

ACCOMPLISHMENTS

The discussion of KREMU's accomplishments will focus on the ecological surveys and censuses carried out within the framework of the on-going ecological monitoring programmes.

National censuses

An initial systematic aerial census of about 20 wildlife species plus cattle, sheep, goats, camels and donkeys was completed in October 1977 for the entire country. The objective of this survey was to provide baseline data on numbers and distributions of animal communities in the study areas as a basis for future improved sampling strategies. A sampling fraction of 2.2% was chosen for this survey. Preliminary results are reported in Dirschl et al (1978b).

A second national census was conducted in 1978. This was carried out in the same locations and at the same season as the 1977 census, but the sampling fraction was increased to 4.5% in an effort to increase precision. Some results of this census are reported in Stelfox et al (1979b). Based on the 1977 ecological survey and previous work on the distribution of wildlife in Kenya (Stewart and Stewart, 1963), KREMU has produced density distribution maps for over 20 wildlife species and for cattle, sheep, goats, camels and donkeys (Stevens and Mbugua, 1979).

Special surveys

In addition to the national animal censuses, a number of special surveys have been conducted in priority areas, such as Meru and Bisanadi Conservation Areas (see Wetmore et al, 1977; Stelfox, 1979; Kufwafwa and Stelfox, 1979; Stelfox and Mugambi, 1979). Monthly surveys have also been conducted in the Masai Mara study area as part of the monitoring programme.

Population status of endangered wildlife species

Special reports have been written on the population status of Grevy's zebra (Dirschl and Wetmore, 1978), and on the distribution, densities and population trends of elephant and rhinoceros (Stelfox et al, 1979a), based on data from the national censuses. The purpose of these special reports is essentially to emphasize the decline in population of these species and to make some preliminary recommendations to assist on-going conservation efforts.

Precision-accuracy studies

Precision-accuracy studies are part of KREMU's on-going programme to design and evaluate appropriate survey methods. A number of factors are taken into consideration, such as flying heights, strip widths, the behaviour of the species in question and priority among different species in terms of conservation and economic importance.

Ground survey and monitoring programmes

Considerable work has been done under KREMU's ground survey and monitoring programmes in delineating study plots and collecting data on biomass, species composition, vegetation cover, rainfall and soil moisture. Vegetation types have been identified for the Kenya rangelands south of the equator. In these areas a routine monitoring programme has been established which is now being extended to other rangeland areas.

Use of remote sensing

Remote sensing is being used increasingly as a tool in KREMU's ecological surveys. A habitat map has been prepared for the Narok area and a library of available LANDSAT imagery has been organized according to specific study areas, such as Narok, Marsabit, Lamu, Baringo and the Tana River delta. KREMU has also begun taking its own high-level aerial photographs of vegetation plots to enhance the collection of ground survey data and to provide a basis for a library of aerial photographs of specific study areas. In its remote sensing work, KREMU has cooperated closely with other institutions such as the Regional Centre for Remote Sensing and the UNESCO/UNEP Integrated Project on Arid Lands (IPAL) at Mount Kulal in Marsabit District.

Data analysis and communication

KREMU's data management section is responsible for designing appropriate computer programmes for various kinds of statistical analysis. The results of

these analyses have been published as technical reports, several of which are currently in production. A data storage and retrieval system has also been established in cooperation with the Central Bureau of Statistics, and a great deal of useful ecological data has been collected over the past few years. When these data are fully analysed and interpreted, they should provide a useful baseline for detecting ecological changes in the arid and semi-arid areas of Kenya.

Training

Manpower development and training are major aspects of KREMU's activities. On-the-job training is a regular feature of KREMU's research programmes, and, in addition, several staff members have been sponsored by the Canadian International Development Agency (CIDA) for post-graduate training at the University of Nairobi and overseas, for example at the University of British Columbia in Canada and the International Institute for Aerial Survey and Earth Sciences (ITC) in the Netherlands. A few technical assistants have also been sponsored for in-service training at Egerton College and the Animal Health and Industry Training Institute in Kenya. Plans for other types of specialized training are also being made, with the ultimate aim of making KREMU self-sufficient in terms of manpower.

PROBLEMS

In its establishment and operations, KREMU has experienced its share of problems. This would be expected in any new organization whose mandate is the collection and analysis of ecological data on an interdisciplinary basis over a wide area.

Recruiting counterpart staff

Problems encountered in recruiting counterpart staff have been a basic constraint on the transfer of knowledge from Canadian advisers to Kenyan personnel. Recruitment problems have been due to a scarcity of qualified people in certain

fields and the relatively low levels of remuneration offered by the civil service. The demand for these categories of staff, e.g. pilots and systems analysts, is very high in the private sector, which generally offers high salaries.

Purchasing and testing equipment

Although equipment was purchased on time in Canada, delays in delivery were encountered. New equipment also had to be tested before it could be used, which further delayed KREMU's schedule of operations.

Survey logistics

The logistics of carrying out survey work caused some problems as KREMU became operational. Logistical problems were particularly serious because KREMU's initial surveys covered the entire country.

Public relations

In some cases, KREMU's field operations have been impeded by local people who have not been adequately informed about KREMU's objectives and activities. This has occasionally led to delays in planning and implementing field surveys. The potential users of the data collected by KREMU, particularly government administrators, also need to be better informed about the activities of the unit.

Staff motivation

The success of an ambitious programme such as KREMU's depends heavily on the interest and motivation of the staff. Each staff member should feel that his or her contribution to the programme is valuable. Career and training opportunities function as powerful incentives, and these and other motivations are necessary if the programme as a whole is to succeed.

Data flow

The collection of data is only the first phase of KREMU's responsibilities. These data must then be analysed and presented in reports which are distributed to the relevant government ministries. When data-analysis and report-writing capabilities are inadequate, substantial delays occur between the collection and the dissemination of information.

PROJECTS

Within the Kenya Government and elsewhere, the value of KREMU's ecological monitoring work has been recognized. Data collected by KREMU have been used in planning the development of Kenya's arid and semi-arid areas, as embodied in the 1979-83 Development Plan. KREMU is thus committed to continuous ecological monitoring and survey work focused on the Kenya rangelands. Specific projects which have been carried out are listed below. The results of all of these have proven useful to government planners and administrators in the relevant ministries:

- population levels, declines and trends of animal communities in the Kenya rangelands; populations of elephant, rhinoceros and Grevy's zebra have been shown to be declining (see Stelfox et al 1979a; and Dirschl and Wetmore, 1978)
- seasonal dispersal of wildlife and livestock in Meru and Bisanadi Conservation areas (see Dirschl and Wetmore, 1978; and Stelfox, 1979)
- animal distributions and densities in the rangelands of Kenya, particularly comparing distribution data collected in 1977 and 1978
- vegetation trends in the Narok area
- wildlife population trends in Masai Mara Game Reserve
- rainfall and soil moisture indices in Narok (see Wahome and Kuchar, 1979).

Results of the 1977 census indicated that the confidence limits for population estimates were too wide. For this reason, the number of transects was doubled in 1978.

At the same time, six East African aerial biologists were trained as front-seat observers to collect a variety of environmental data. These data included information on herbaceous and woody vegetative cover and greenness, surface water, fires, crops and cultivation patterns, roads and human settlement. This information was ultimately correlated with the herbivore density and distribution data.

Four pairs of observers, all East Africans, were given 3 months of intensive training in 1976 under various conditions. This was the first training programme ever offered for East African aerial survey observers. They learned to identify, count and record some 30 wild and domestic herbivore species. Once the regular surveys were initiated, they were able to improve the accuracy of their herd-size estimates by comparing their visual counts with photographic counts (Dirschl et al, 1978a). Their performance was carefully calibrated with levels achieved by experienced observers elsewhere until they reached a high level of accuracy and consistency (Norton-Griffiths, 1977).

Three Cessna 185 aircraft were used, equipped with radar altimeter, global navigation and intercom systems. Strip widths were delineated by two parallel rods extending back from the wing struts. Numerical data on herbivores were collected by pairs of rear-seat observers who made their observations into tape recorders and photographed all groups of over 10 animals for subsequent counting under a microscope.

adopted a survey technique which was considered the best compromise among several alternatives and which had proved reliable for a number of multi-species herbivore surveys in East Africa (Norton-Griffiths, 1977). The survey methods developed were largely influenced by the advice of H Croze, H J Dirschl, M D Gwyne, M Norton-Griffiths and D Western.

Initial aerial surveys were carried out on a nation-wide basis in 1977 and 1978, using systematic strip-transsects oriented in an east-west direction and a flying height of 300 ft (91 m). The transect strips were 112 m wide on either side of the aircraft. With the transects spaced at regular 10 km intervals in 1977 and at 5 km intervals in 1978, sampling intensities of 2.2 and 4.5% were achieved, giving a total coverage of 11 000 and 22 000 km² respectively. For these censuses, KREMTU

METHODS

- to determine suitable sampling strategies for major species/habitat combinations in Kenya.
 - to train Kenya nationals in the methodology of aerial and ground surveys
 - to establish a monitoring programme which will determine the seasonal abundance and distribution of livestock and wild herbivores throughout the rangelands (500 000 km²) of Kenya
- The major objectives of the aerial survey section have been:
- to establish a monitoring programme which will determine the seasonal abundance and distribution of livestock and wild herbivores throughout the rangelands (500 000 km²) of Kenya
 - to train Kenya nationals in the methodology of aerial and ground surveys
 - to determine suitable sampling strategies for major species/habitat combinations in Kenya.
- for data management.

The Kenya Rangeland Ecological Monitoring Unit (KREMTU) is composed of four sections, responsible for aerial, ground and remote sensing survey work and

INTRODUCTION

J G Skellom and D G Peden
Kenya Rangeland Ecological Monitoring Unit

THE AERIAL SURVEY PROGRAMME OF THE KENYA RANGELAND
ECOLOGICAL MONITORING UNIT: 1976-79

- indicating requirements and suggesting priorities for intensive follow-up research by other Kenyan ministries and agencies
 - making predictions on significant changes in numbers and spatial and temporal distributions of wildlife, livestock and cultivation in the Kenya range-lands
 - analysing and processing relevant data into a usable form for transmission to the Inter-Ministerial Committee with the approval of the Steering Committee
 - providing up-to-date baseline data on livestock and wildlife populations and distributions, as well as the extent and nature of cultivation in the range-land areas of Kenya
- the main ones are:

- Several activities are carried out in pursuit of these objectives. Some of
- to train Kenya nationals in the techniques necessary to carry out the objectives of the unit.
 - to suggest recommendations to the Government of Kenya on rangeland utilization
 - to establish the basis for a reliable and continuous flow of information on livestock, wildlife and cultivation in the rangeland areas
- KREMU's main objectives are:

Ministerial Committee for implementation.

particularly on land-use and conservation strategies, are also presented to an Inter-Environment and Natural Resources. KREMU's reports and recommendations, evant ministries, and is chaired by the Permanent Secretary of the Ministry of produced. This committee is composed mainly of government officials from rel-guidelines, decide on priority survey areas and species and approve the reports Unit is directed by a Steering Committee, which meets regularly to provide policy opment Project under the Ministries of Agriculture and Tourism and Wildlife. The KREMU was established as part of Phase II of the Kenya Livestock Development Program. The value of these monitoring activities was becoming activities.

methods which had been developed were adapted for large-scale monitoring management of Amboseli National Park. With the establishment of KREMU, the apparent, for instance in case studies involving the collection of baseline data for Monitoring Programmes. The value of these monitoring activities was becoming

* The author wishes to thank D G Peden and J G Stelfox for reviewing this paper and W E Stevens for his continuous encouragement.

The Kenya Government had recognized for some time the value of ecological monitoring as a tool for resource management. Ecological monitoring methods had been developed in eastern Africa for over a decade, though on a relatively small scale, for example by the Serengeti and the Ilkisongo Ecological Rangeland conditions and animal populations and distributions to ensure the conservation of wildlife and formulate the most appropriate multi-purpose land-use strategies. In these areas there was an urgent need to monitor trends in with livestock, and in these areas there were sharing available grazing resources reserve boundaries, wild herbivores were seriously endangered and the hunting policy as a whole national ecological monitoring programme. Beyond national park and game came into question. This crisis situation added impetus to the establishment of a national ecological monitoring programme. Beyond national park and game species were found to be seriously endangered and the hunting policy as a whole to maximize income benefits to land-owners from tourist and hunting fees and to preserve wildlife as an alternative land-use resource, certain wildlife While rational wildlife management policies were being developed in Kenya to maximize income benefits to land-owners from tourist and hunting species were found to be seriously endangered and the hunting policy as a whole national ecological monitoring programme. Beyond national park and game reserve boundaries, wild herbivores were sharing available grazing resources with livestock, and in these areas there was an urgent need to monitor trends in rangeland conditions and animal populations and distributions to ensure the conservation of wildlife and formulate the most appropriate multi-purpose land-use strategies.

The Kenya Rangeland Ecological Monitoring Unit (KREMU) was launched early in 1976 as a joint programme between the Governments of Kenya and Canada. Its purpose is the long-term monitoring of Kenya's rangelands, livestock and wild herbivores.

While rational wildlife management policies were being developed in Kenya to maximize income benefits to land-owners from tourist and hunting fees and to preserve wildlife as an alternative land-use resource, certain wildlife species were found to be seriously endangered and the hunting policy as a whole national ecological monitoring programme. Beyond national park and game reserve boundaries, wild herbivores were sharing available grazing resources with livestock, and in these areas there was an urgent need to monitor trends in rangeland conditions and animal populations and distributions to ensure the conservation of wildlife and formulate the most appropriate multi-purpose land-use strategies.

INTRODUCTION

Kenya Rangeland Ecological Monitoring Unit

D K Andere *

UNIT (KREMU)

THE KENYA RANGELAND ECOLOGICAL MONITORING

In the authors' view, stratified sampling is always preferable to systematic sampling. Any basis of stratification is better than none, but a stratification based on ecological information is preferable to one which is artificial. The authors believe that the grids and other presentations of distribution based on systematic sampling provide illusions of precision; more detailed analysis of grid data, based on small numbers of non-independent sampling units is not justified by any statistical or mathematical arguments encountered by the authors.

Stratification and selection of sampling units

The present authors believe that competent observers are born, not trained. The aerial survey method is essentially nontransferable until sensors replace human observers.

Training and motivation

Visual task while being subject to movement which he does not control and cannot anticipate. This stress is evident as nausea, sickness, fatigue and lack of concentration. The authors have never flown with an observer who was capable of more than 2 hours' continuous attention, and at least half the observers with whom they have flown have slept within the first 4 hours of flight.

Pilots, in our experience, produce more accurate counts when flying themselves than when they or other observers are being flown. The main reason for this is that an observer experiences stress when he attempts to perform a precise

Observers

The authors have found that it is not possible to record information on strip samples from aircraft moving at high speeds. When the items to be observed occur in very high densities, quadrat sampling with a photographic record becomes necessary. It has also been found that a perspex window is a significant barrier between the observer and the subject being observed and that objects on photographs taken through a perspex window are more difficult to count.

The aircraft platform

Bias, due to animals which are hidden or simply not noticed by the observer, is the most serious problem of current light aircraft survey methods. Livestock surveys have revealed biases (underestimation) of 3 to 59%, and the problem is more serious for wild species: 80% bias has been measured for reedbuck in tall grassland and 45% for elephant in medium bush woodland. It appears that medium or large groups of animals are much more likely to be spotted than individuals or small groups, regardless of the size, colour or even, to some extent, the behaviour of the animals. This increase in the probability of being spotted exceeds the level which would be expected from simple area or numerical relationships, and probably explains why undercounting is so much more substantial for wild animals than for livestock. Any aerial survey technique will always involve some degree of bias.

Bias

A number of controversies exist among different practitioners in this field, however. The position of the authors on five issues will be discussed, mentioned in order of importance.

These examples of surveys conducted from light aircraft suggest the usefulness and versatility of this approach to information gathering, especially when used together with other survey techniques. Rather simple area frame sampling rules are followed and a system of stratification is devised appropriate to the information being collected.

CONCLUSIONS

- a set of maps at 1 : 1 000 000 accompanying the report
- more than 4 000 colour transparencies, indexed and fully documented, from about 750 sampling sites, which will form the basis of a fixed-site range monitoring programme
- a set of colour plates of a selection of ground and aerial sampling sites, illustrating the information available in the colour transparencies
- a collection of more than 800 identified herbarium specimens
- a preliminary checklist of plants in the area for use by range workers
- the enhanced colour composite LANDSAT prints, with a mosaic added to match the longitude/latitude format of the 1 : 1 000 000 maps
- 200 copies of a land-systems/range-vegetation map at 1 : 250 000 in 18 sheets
- acetate negatives and positives of 1 : 250 000 and 1 : 100 000 land system/range-vegetation maps
- computer printouts of wet- and dry-season census results, covering live-stock, wildlife, houses by structural types, crop production patterns, surface water sources and boreholes
- 1 : 1 000 000 maps of the wet- and dry-season distribution of these features
- a report on the survey methods used and the main implications of the information provided by the census for possible development alternatives.

Figure 9. Simplified schematization of the design used for range-vegetation and land-system mapping and resource inventory of Somali central range-lands

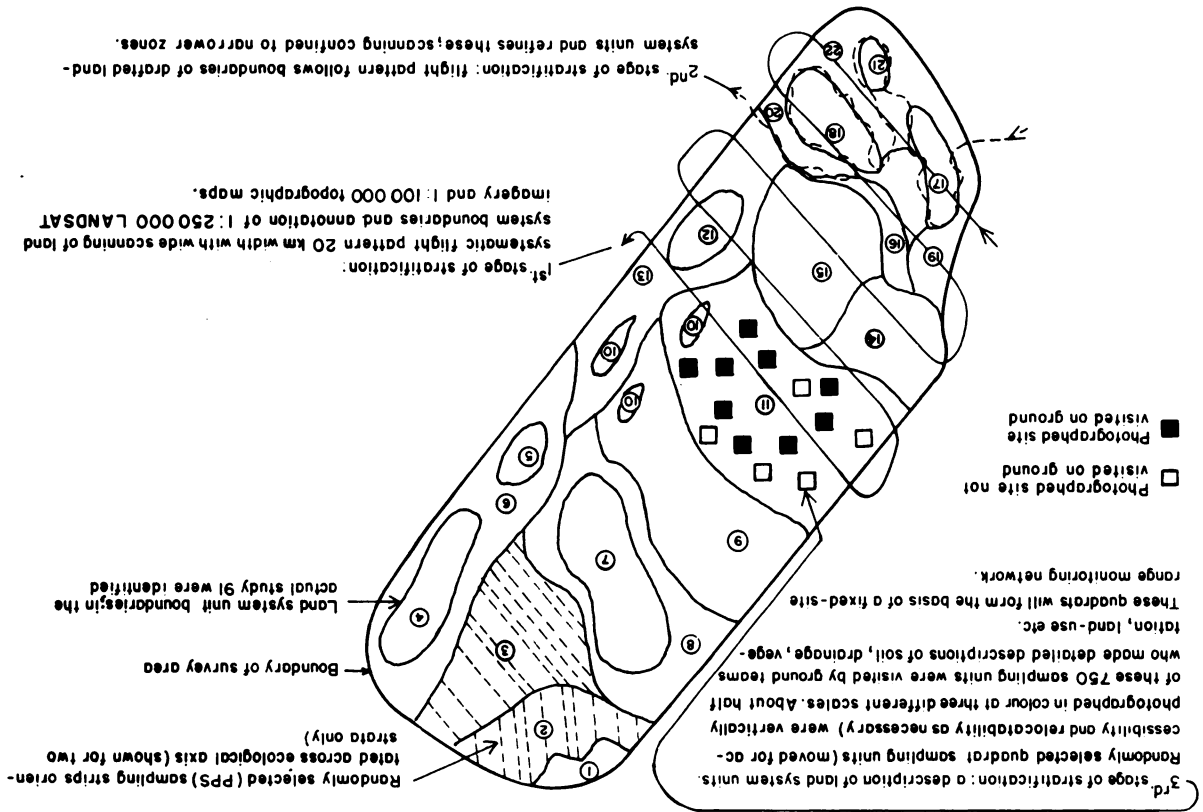

Strata were classified into biological classes (9) and ecological zones (26).
 Strip sampling effort was proportionally greater in strata of higher livestock density and greater human use.
 Quadrat sampling effort was fairly uniform over the entire survey area.

Strata
 1 - 22

where vegetation or land-system boundaries of great complexity or poor definition were encountered, this reconnaissance work was done from a Cessna 210 aircraft looking through perspex panels. The aircraft flew in two basic patterns: a systematic series of parallel lines 20 km apart at 1 525 m, while the observers studied vegetation and land-system boundaries at least 10 km on either side of the aircraft, and a more variable pattern over all the land-system boundaries and most of the range-vegetation boundaries.

Next, two-stage sampling quadrats were selected from the land-system units, using limited randomization. The sampling units were selected at random, but they were then moved to the nearest point at which they could be easily relocated, either from the air or on the ground. If this resulted in movement of a sampling unit to another range vegetation type or another variant of the original type, then it was rejected and another sampling unit selected. Once the sampling sites were identified, vertical or semi-vertical 35 mm Ektachrome photographs were taken at 1 : 4 000 - 12 000. For most sites, photographs were taken at three scales. The more accessible halves of the sampling units were also visited on the ground, and land use, soils and the taxonomy and structure of the vegetation were described. Because of the importance of browse for the livestock of the area, the taxonomic composition of the vegetation was considered particularly important. A representative selection of these sampling units was visited by Hemming and Gillett, who recorded detailed botanical descriptions. The survey design is shown in simplified schematic form in Figure 9.

The emphasis in this study on the relocatability of sampling sites was a response to the Somali Government's wish to establish a range vegetation monitoring programme based on fixed sampling sites. Because this survey was carried out as a preliminary to a much greater research and management effort financed through the World Bank, a wide range of materials was prepared. These included:

- a report on static range resources, including topography, climate, geomorphology, soils, drainage, erosion and land use

Table 1. A summary of population estimates and standard errors from a 2.2% sample in 1977 and a 4.5% sample in 1978 for the entire Kenya rangelands, uncorrected for visibility bias

Value	1977	1978	1977	1978	1977	1978	1977	1978	1977	1978	1977	1978
	Cattle		Sheep and Goats		Camels		Donkeys		Elephant		Rhinoceros	
PE ^a	4 072 600	4 224 300	7 074 600	8 511 00	602 900	640 600	134 900	187 100	59 800	42 800	1 820	730
SE ^b	4.0	3.4	3.4	3.1	5.9	4.8	8.7	7.3	13.4	24.3	17.8	23.9
	Giraffe		Buffalo		Eland		Oryx		Kongoni		Topi	
PE	79 200	77 600	63 300	85 600	40 600	51 300	63 800	74 800	39 600	59 300	86 900	138 600
SE	5.8	4.5	29.5	25.3	13.1	14.9	8.6	8.4	10.7	9.0	9.9	12.5
	Hunter's Hartebeest		Wildebeest		Ostrich		Thomson's Gazelle		Grant's Gazelle		Impala	
PE	2 400	7 500	148 100	207 400	32 200	39 700	163 700	244 200	236 300	331 100	145 900	253 700
SE	32.7	17.3	12.7	13.6	8.3	7.7	8.4	8.8	4.5	3.1	8.9	9.4
	Gerenuk		Waterbuck		Lesser Kudu		Burchell's Zebra		Grant's Zebra		Warthog	
PE	49 300	55 600	21 600	18 200	16 900	19 200	147 200	182 500	13 300	7 900	36 900	36 300
SE	3.7	6.5	24.0	10.3	9.6	6.5	9.0	8.7	21.8	14.4	8.2	6.2

^a PE = population estimate.

^b SE = standard error as a % of PE.

A visibility bias of 50% is used for rhinoceros (Goddard, 1970) and 25% for elephant. Information should become available in 1980 which will provide a basis for correcting the population figures obtained for most other animal species, but at present these are not corrected. The data collected so far suggest that the KREMU aerial survey programme is obtaining estimates of populations and trends of sufficient reliability, even for scarce species such as rhinoceros which probably number fewer than 2 000 throughout Kenya.

Reliability of aerial survey data

The accuracy of aerial survey data is affected by counting bias and sampling error. Both of these factors will be discussed.

Counting bias. Efforts to reduce counting bias include the thorough training of observers and the use of photographs to count groups of over 10 animals. Counting bias is also reduced by using a narrow strip width of 112 m and the lowest flying height (300 ft or 91 m) and slowest speed (150 kph) in keeping with acceptable safety standards.

To examine levels of bias, aerial survey counts have been compared with data obtained from photographs and counts on the ground. This approach only achieves an approximation of counting bias; however, unless the true populations are known. For example, four observers were flown independently over a swampy area in Meru National Park containing a population of elephant, buffalo, zebra, waterbuck, impala and ostrich. A Cessna 185 was used, flying at 150 kph, 300 ft (91 m) above the ground. The four independent visual counts from the air averaged 86.6% of the figures obtained by repeated ground counts made from an adjacent raised platform using binoculars. On another occasion, it was known that 470 buffalo were present in the swamp; the visual population estimates of four aerial observers averaged 90.7% of this figure.

Aerial and ground counts of herbivores were also compared along 150 m

strips of the Mara plains adjacent to the Keekorok-Serena road during March, June and August 1979. The results for eight wild herbivores, as shown in Table 2, indicate a counting bias of 11%, assuming that the roadside ground count was accurate. In fact, the grassland vegetation contained only small, isolated patches of shrubs and trees so that most animals were readily visible from the road. However, some gazelle were evidently hidden in the tall grass in March and June because greater numbers were observed from the air than from the ground. The aerial counts of topi, gazelle and buffalo were closer to the populations recorded on the ground than were the aerial counts of giraffe, impala, kongoni, zebra and wildebeest.

Table 2. Numbers of wild herbivores counted along a strip on the Mara plains, 150 m wide and 20 km long on both sides of the Keekorok-Serena road

	March 1979		June 1979		August 1979		Combined ^a	
	Aerial Ground		Aerial Ground		Aerial Ground		Aerial Ground	
Gazelle	62	57	204	99	41	99	307(120.4)	255
Impala	88	88	55	101	26	82	169(62.4)	271
Topi	100	51	52	80	10	11	162(114.1)	142
Kongoni	14	20	0	0	1	1	15(71.4)	21
Buffalo	17	8	4	0	1	0	22(275.0)	8
Wildebeest	1	4	0	0	89	111	90(78.3)	115
B. Zebra	0	2	2	1	161	219	163(73.4)	222
Giraffe	0	6	0	0	3	4	3(30.0)	10
Totals ^a	282	236	317	281	332	527	931	1044
	(119.4)		(112.8)		(63.0)		(89.2)	

^a Figures in brackets are the aerial counts as a percentage of the ground counts.

In August 1979, wild herbivore population estimates from aerial counts were compared with ground counts on a 25 km² block of the Mara plains. On two separate days aerial surveys and ground counts were carried out simultaneously,

Table 3. Population estimates of wild herbivores from aerial surveys (300 ft, 150 m strip widths, 48.8% sampling intensity) and total ground counts of a 25 km² block on the Mara plains, August 1979

Elephant	Giraffe	Zebra	Wildebeest	Topi	Gazelle	Impala	Kongoni	Buffalo	Ostrich	Total
0	4	2225	781	484	16	0	8	16	6	3540
25	0	1256	818	648	16	18	14	25	10	2820
Aerial estimates 1 & 2 (Count x 100 ÷ 48.8)										
6	2	1231	526	496	39	1	61	7	6	2375
15	0	1159	647	528	22	44	43	9	6	2473
Ground counts 1 & 2 (total count)										
80.6	200.0	145.6	136.3	110.6	52.5	40.0	21.2	256.2	133.3	131.2
Aerial counts as a % of ground counts										

covering 150-m-wide strips from a flying height of 300 ft (91 m) at a 48.8% sampling intensity. The results are shown in Table 3. On average, the aerial counts were 131.2% of the ground counts. They were highest for buffalo, giraffe, wildebeest, zebra and ostrich, but considerably lower than the ground counts for gazelle, impala and kongoni.

During the same month, aerial, aerial photographic and ground counts were compared for a 3.5 x 5.0 km block, also on the Mara plains. The aerial survey was conducted from a Cessna 185, flying at 300 ft (91 m) along seven east-west transects spaced 0.5 km apart. Strip widths were 120 and 124 m and the sampling intensity was 48.8%. These counts were converted to population estimates by multiplying by 2.23. The photographic count was made from a complete coverage at a height of 600 ft (183 m), using 35 mm colour film. The ground count was made along 0.25 km strips on either side of two Landrovers, moving parallel along east-west transects 0.5 km apart. This approach also achieved total coverage. Several interesting patterns emerged from a comparison of the three counts, as shown in Table 4:

- On average for all species, the population estimate from the aerial survey was 71.7% of the ground estimate and 70.5% of the photographic count.
- The aerial population estimate for giraffe was only 10% of the ground count and 7% of the photographic count.
- Estimates of wildebeest and zebra populations were similar for all three surveys, while for topi the aerial count was only about 50% of the numbers obtained from the aerial photographs and on the ground.
- The photographic counts of gazelle and impala were respectively 38.8% and 13.5% higher than the figures obtained from the air and on the ground. As these small herbivores were difficult to identify from photographs, it is likely that the high figures obtained were the result of misidentifying inanimate objects.

Table 4. Comparisons of aerial, ground and aerial photographic counts of herbivores on a 3.5 x 5 km plot, Masai Mara, August 1979

	Elephant	Giraffe	Zebra	Wildebeest	Topi	Gazelle	Impala	Kongoni	Buffalo	Total
Aerial	0	1	544	283	106	8	0	4	4	950
Ground	5	10	601	349	286	22	1	54	3	1325
Photographic	0	14	538	275	224	194	90	6	5	1348
Aerial count as % photographic count	100.0	7.1	101.1	102.9	47.3	4.1	0	66.7	80.0	70.5

- Overall, the aerial counts of elephant, giraffe, wildebeest, zebra, topi, kongoni and buffalo were 72.4% of the ground counts and 88.6% of the photographic counts. These species are all considered to be clearly visible from the air.

Linear regression equations were applied to data obtained during KREMU's 1977 national aerial census in order to relate observer counts to photographic counts of cattle, sheep and goats, elephant, buffalo, impala and Thomson's and Grant's gazelle (Ng'ang'a et al, 1979). These were the only species included in the aerial survey for which a sufficient number of photographs were available to make a comparison possible. A total of 2 794 photographs were analysed.

In general, the visual counts were smaller than the photographic counts. The two estimates were closer for cattle, sheep and goats and elephant than for buffalo, impala and gazelle. Estimates of cattle and sheep and goat populations varied considerably among individual observers. The coefficients of determination were relatively low for all species and all observers, so these regressions have little predictive value. On the assumption that photographic counts are generally more accurate than observer counts, KREMU has adopted a policy of using photographic counts whenever they are available. As already mentioned, the observers normally photograph all groups of more than 10 animals.

Counting bias has also been investigated in a number of accuracy-precision surveys. For instance, population estimates were compared from six repetitive surveys carried out in each of five ecological regions of Kenya. Each survey covered two subareas comprising 45 sampling units of 5 x 5 km each. East-west transects were spaced 5 km apart, and three strip widths were used, each at two flying heights. Differences in animal density were compared for different sampling units, species groups, left- and right-seat observer positions, flying heights and strip widths, using 5-way analyses of variance. Second-order interactions were also tested, but higher-order interactions were ignored (Peden et al, 1979).

Population estimates and their standard errors were calculated for each combination of species group, flying height, strip width, observer position and sub-area at each location. A regression equation was estimated to evaluate the relationship between population estimates and standard errors. If it is assumed that sampling error is not significantly different among the six surveys and that over-estimation of true animal numbers is unlikely, then the highest observed densities should be most accurate, although the true densities were unknown in these trials. These assumptions need to be tested, however.

The narrower strip width consistently resulted in higher observed densities. Observed densities at middle and wide rod settings, which determine strip widths, also varied according to observer position in the aircraft, which is undesirable. It is possible that with wide rod settings observers find it difficult to maintain a consistent strip of ground in view. There was generally little or no difference in observed densities at different flying heights except in Tsavo East National Park where observed densities were higher at 300 than at 400 ft (91 and 122 m). Since the effects of height were not consistently significant, future surveys will generally be conducted at 400 ft (122 m) in the interest of flight safety.

A 6-day accuracy-precision trial was also conducted at Galana Ranch, where the total cattle population was known to be 15 208 head. The analysis of variance did not reveal significant differences ($P < 0.05$) among observed densities with different flying heights, strip widths or combinations of these factors. By treating the entire 6 days of data collection as a single census, the cattle population was estimated at 12 567. The 95% confidence limits ranged from 10 030 to 15 103, which did not contain the known population size. The average counting bias was 17.4% of the true value. Most of the animals missed were probably calves, which were known to number 1 609.

Sampling errors. A frequent measure of precision is the standard error, expressed as a percentage of the population estimate (SE%). The SE% can be broken into several components:

$$SE\% = CV \sqrt{\frac{1}{n} - \frac{1}{N}}$$

where CV is the coefficient of variation of the data, i.e. (standard deviation/sample mean) x 100, where n is the sample size and N is the total number of possible sampling units. Precision thus depends upon CV, n and N, and it follows that a decrease in CV or N, and an increase in n will increase precision. For given flying costs, precision will clearly be increased by observing as large an area as practical. For this reason, KREMU has adopted a strategy of using the widest possible strip width which does not jeopardize accuracy.

Based on KREMU's 1977 census of 16 species of animals in 44 eco-units, Peden (1980) found that:

$$CV = 969 \text{ Log } (G) - 825 \text{ Log } (D) - 522$$

where G is the mean size of groups of animals in the ecological unit and D is the mean density of animals in the unit. The multiple coefficient of determination ($R^2 = 0.87$) was highly significant. It follows from these two equations that, for any given sampling effort, the greatest precision is possible when populations occur in small groups and at high densities.

It would appear very difficult to obtain precise population estimates of species which are highly grouped or have a low density. Based on the 1977 data from the Tsavo ecological unit, for example, with a strip width of 112 m on both sides of the aircraft, about 25 000 km of transects would have to be covered to obtain an SE% of 10 for livestock. This is equivalent to about 50 days of flying and could not be considered practical. Situations must be acknowledged where it would be too time-consuming or expensive to conduct aerial surveys of the required level of precision, and efforts should be concentrated on areas or species where more economic surveys can obtain valid results. From recent studies in high-priority districts of Kenya, KREMU has determined the best combination of survey height, strip width and sampling intensity for a few high-priority species. Once the optimum combination for any given area is identified, the number of sampling units can be calculated which will result in the desired level of precision for any given species.

Other herbivore species will also be monitored, but the weakness of the results obtained must be acknowledged.

A survey of the elephant population in and adjacent to Tsavo National Park was conducted in 1979. Based on a recent accuracy-precision study of the area, a combination of 400 ft (122 m) flying height and 294 m strip widths on either side was chosen. The required number of sampling units was determined to achieve 95% confidence limits of 10%, using the formula:

$$n = \frac{N^2 S_y^2}{(SE)^2 + N S_y^2}$$

where n is the sample size, N is the total area under study divided by the average area of a sampling unit, SE is the standard error desired and S_y^2 is the sample variance. A transect spacing of 10 km was chosen, based on the time available for the survey. With this sampling intensity, a standard error of about 2 000 was predicted for the total elephant population of approximately 10 000. The results of the survey gave a standard error of 1 996, indicating that this method of determining survey strategy is sound.

SAMPLING DESIGN FOR FUTURE KREMU SURVEYS

Based on data collected during the 1977 and 1978 national censuses and the results of accuracy-precision studies and in-depth surveys of specific areas, it is now possible to design aerial surveys which will optimize accuracy and precision within given constraints of funding, time, man-power and equipment. Aerial surveys must be practical and must provide reliable data which can be combined with information collected from ground vegetation studies and remote sensing to provide an integrated ecological overview. Basically, aerial surveys must be simple, repeatable and reliable. The data must be analysed and presented in concise, understandable terms and interpreted accurately in an ecological context which will be meaningful for land-use planning and management.

More surveys are required to provide fuller information on herbivore stocking rates, distributions and ranges as these relate to seasonal changes in forage biomass and greenness, water, cultivation and fires. Because one of KREMU's responsibilities is to provide advice on proper balances between livestock and wild herbivores, more information is needed on habitat preferences and inter-specific competition to provide a picture of existing range resource partitioning among the various herbivore species.

The objectives of future surveys will be examined to identify which herbivores are considered to have high priority in a given region. The most desirable and practical levels of accuracy and precision will be determined and the region will be stratified into density zones based on data obtained from previous surveys. For example, in the Loita ecological unit, by stratifying the area into livestock density zones and omitting the non-habitat areas, the standard error of the 1977 cattle population estimate was decreased from 24 742 to 20 700. This could result in saving 320 km of flying in future surveys. Finally, the results of previous accuracy-precision studies will be used to show what combination of flying height and strip width will yield the most accurate and precise population estimates for a given species, and the appropriate sampling intensity will be selected.

AN APPROACH TO EVALUATING TECHNIQUES FOR
VEGETATION SURVEYS ON ARID RANGELANDS

D C P Thalen

International Institute for Aerial Survey and Earth Sciences
The Netherlands

INTRODUCTION

Direct data collection from low-flying light aircraft is currently one of the inventory and monitoring techniques most frequently used on eastern African rangelands, and is being applied increasingly elsewhere. Developed primarily as an animal census method, the technique has also shown its usefulness in the inventory of other rangeland features, such as water bodies, vegetation structure and greenness and human settlements, especially for planning and management purposes.

The technical aspects of aerial survey are discussed in detail in other contributions to this workshop. In this paper, an attempt is made to evaluate the usefulness of the technique, particularly in relation to other techniques, for the collection of data on vegetation as part of arid rangeland surveys.

Keeping in mind the usual context in which rangeland surveys are carried out, complementary survey techniques should be integrated to make the most effective use of each. The improved inventory and monitoring data output which could be achieved would allow the early detection of range

trends and facilitate improved management of arid range areas which are often seriously deteriorated.

RANGELAND AND VEGETATION SURVEY IN LAND-USE PLANNING

Surveys are planned and carried out with certain objectives. In the case of rangeland surveys, these objectives are usually related to evaluating the suitability of land for alternative uses or to formulating improved management practices. When little is known about the land to be surveyed and a large area must be covered, a three-phase approach might be considered, as illustrated in Figure 1. The first phase involves a reconnaissance-level inventory followed by a qualitative land evaluation. Recently developed techniques of land evaluation are discussed in FAO (1976), Beek (1978) and Zonneveld (1979). A land evaluation exercise should indicate the relative suitability of an area for specific uses. With this information, and their own additional input, planners and decision-makers may select priority areas to be surveyed in greater detail, usually in about 10 times greater detail than the original reconnaissance survey. This is the second phase. After a quantitative land evaluation, preferably in economic terms with a cost/benefit analysis for each land-use type, the costed alternatives are again presented to the planners and decision-makers. Project design and implementation, or rather the execution of management practices, should follow as the third phase. The impact of these practices should be monitored to provide feedback of information to the planners and decision-makers.

Rangeland survey is important at all three stages. Figure 2 shows in detail how a rangeland survey fits into an evaluation exercise. For each land unit mapped, the suitability of the land for current and potential uses is evaluated and compared. The survey and analysis of vegetation as a key resource is one important component of the evaluation, along with consideration of soil types, landforms, water availability, socio-economic conditions and other factors.

Figure 1. Land-use planning flow chart (survey and evaluation activities shaded)

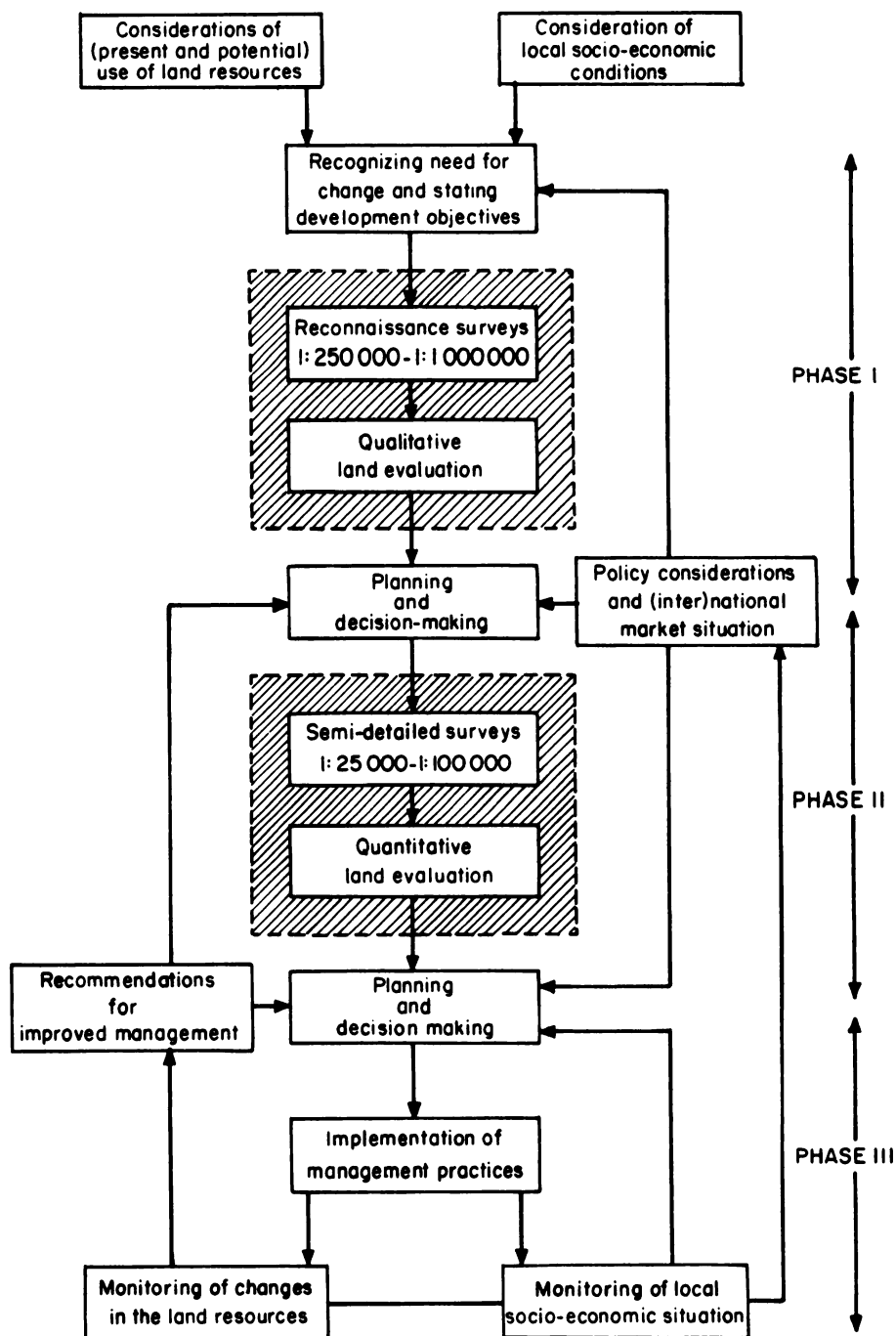
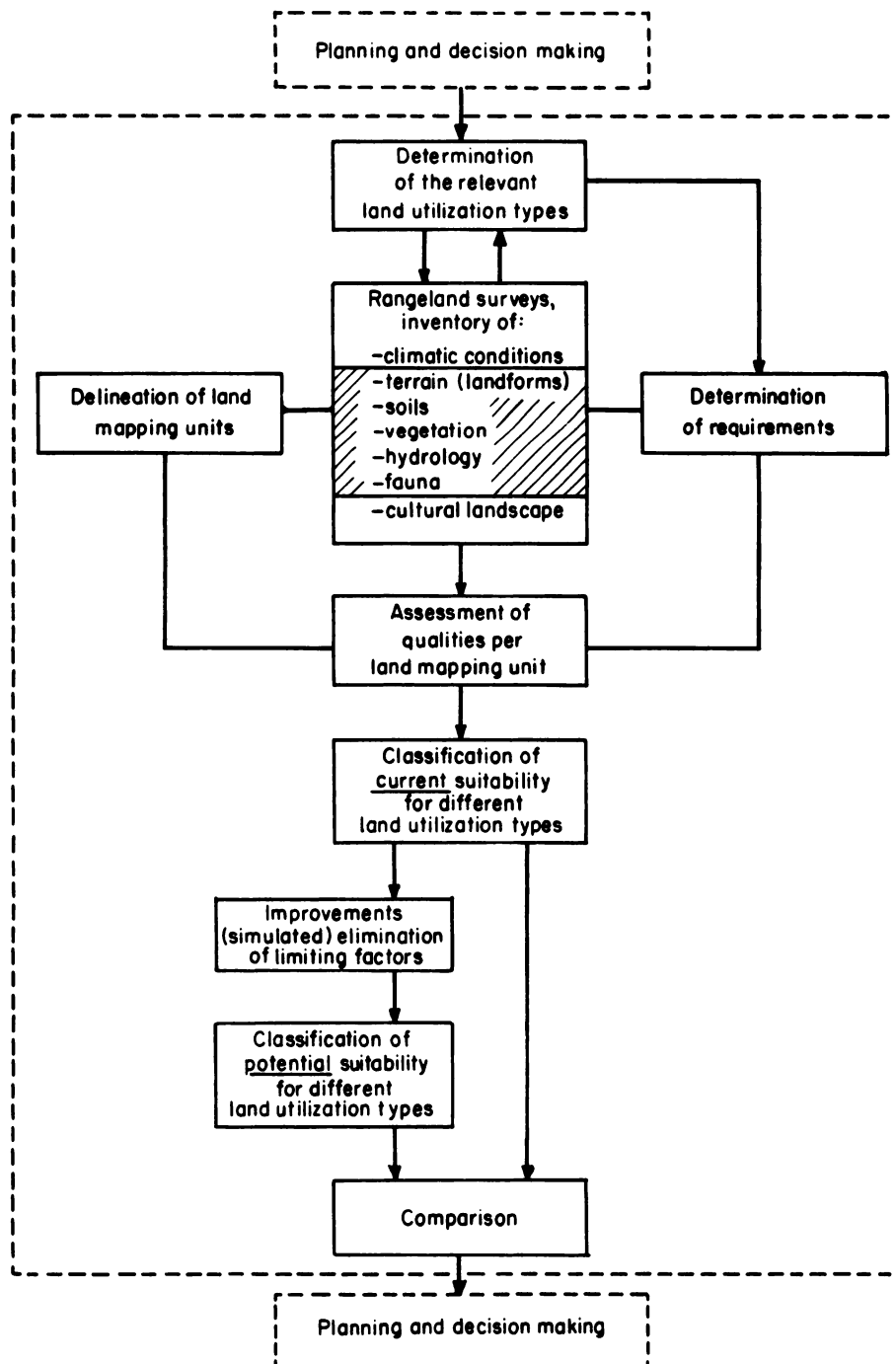

Figure 2. Land-use survey flow chart (rangeland survey activities shaded)



OVERALL VEGETATION DATA REQUIREMENTS

To devise optimum management strategies for vegetation in arid rangelands, it is necessary to know *what grows where and when, how much there is and how good it is*. Thus, information is required on species composition and the structure of the vegetation community. The question of location may be related to particular sites or the total area covered. In an assessment of techniques where spatial resolution (the smallest element that can be seen separately) is important, this distinction is crucial.

The seasonality of the vegetation cover is another important factor. In arid rangelands, very pronounced seasonal differences in vegetation occur. A carpet of ephemerals may develop after a rainfall, and perennial shrub species may change in a few weeks from a dry dormant stage to lush green bushes. Survey coverage must be repeated to record phenological stages and the development of new growth.

Range managers are interested in the quantity of forage available at any particular time for their livestock or game animals. The quality of the available forage is also important. This can be expressed in terms of palatability and nutritive value, and also in terms of the health of the vegetation - whether it is infested with pests or diseases.

EVALUATION OF SURVEY TECHNIQUES

Survey techniques may be evaluated in terms of the answers they provide to the five questions which arise in the management of vegetation on arid rangelands - *what, where, when, how much and how good*. Such an evaluation can be schematized by entering the five information requirements on one axis of a two-axis matrix and the survey techniques on the other, as illustrated in Table 1. The evaluations depicted in this table are based on the author's subjective views rather than on any conclusive research or analysis of survey results.

Table 1. Comparative evaluation of the usefulness of survey techniques in relation to information required for the vegetation component of arid rangeland surveys

	Location: site, particular features	Area: distribution, boundaries	Species: composition, structure	Seasonality: phenology, growth	Quantity: phytomass, available forage	Quality: palatability, nutritive value, plant health
Conventional aerial photography ^a	●	○	○	●	● ⁱ	○
Special-purpose aerial photography ^b	○	●	● ⁱ	● ^j	○ ⁱ	●
Present LANDSAT MSS optically processed ^c	●	○	●	○	●	○
Present LANDSAT digitally processed ^d	○	○	●	○	○	○
Future, improved satellite MSS system ^e	●	●	○ ^k	○	●	○
Light aircraft direct observation ^f	○	●	○ ^j	●	○	○
Light aircraft with use of imagery ^g	○	●	○ ^j	●	○	○
Ground sampling with laboratory analysis ^h	○	●	○	○	●	○

Key:

- almost useless (or impossible)
- little value
- some value
- useful
- extremely useful

^aUsually panchromatic black and white at 1 : 20 000 to 1 : 60 000.

^bFull colour, colour infrared, (very) large scale, etc.

^cLargest scale available is 1 : 250 000; image enhancement possibilities rather limited.

^dScales to 1 : 50 000 still useful; image enhancement techniques offer good possibilities.

^eFew days' temporal resolution, several metres spatial resolution, narrow spectral bands observation, etc.

^fThe pilot and/or observer have no access to imagery of the survey area.

^gThe pilot and/or observer have access to imagery at a convenient scale (e.g. LANDSAT 1 : 250 000 colour enlargements) in the aircraft.

^hConsidered as a complementary technique, rather than a survey technique in itself.

ⁱMore promising when trees and shrub species are surveyed.

^jImprovement depends on finances available for repeated flights.

^kProvided a sort of 'crop calendar' for the natural vegetation can be established for calibration and reference.

As illustrated in the table, conventional and special-purpose aerial photography gives the best information on location and area. Only sampling on the ground gives highly accurate information on species composition in particular locations, except in situations where shrub or tree vegetation is surveyed and can be recognized either from aerial photographs or from direct observation from low-flying aircraft. Future satellite multispectral scanning (MSS) systems have been rated 'useful' in determining location and area of vegetation, presupposing increased knowledge of the spectral signature and plant development calendar of various species, similar to the crop calendar used, for instance, by the United States to monitor worldwide wheat production as part of the Large Area Crop Inventory Experiment (LACIE).

Information on the timing of vegetation growth will be gathered most efficiently by future satellite MSS systems once a high temporal resolution is technically feasible, as has been developed, for example, for the Netherlands' Agricultural Real Time Image Sensing System (ARTISS).

No adequate remote sensing system yet exists to record the production and nutritive value of forage. However, band-ratio work based on the use of a spectrophotometer (now well known as the 'green machine') has shown promising results. This technique is already being used, but it requires further adjustment, refinement and probably repeated intensive calibration before it can be considered generally applicable. At present, ground sampling is still the best technique for acquiring information on forage production and quality.

An informal cost evaluation suggests that the conventional techniques of ground sampling and aerial photography are most expensive. LANDSAT MSS optically processed imagery is least expensive, and observation from light aircraft falls in an intermediate position. Estimates of relative costs are presented in Table 2. Though ground sampling provides the most accurate and detailed information, due to its substantial cost it must be complemented by other techniques such as aerial photography or high-resolution satellite imagery. This evaluation

Table 2. General evaluation, major constraints and relative cost per unit area of various survey techniques

	General Evaluation	Major Constraint(s)	Relative Cost per Unit Area
Conventional aerial photography	suitable type for (complex) only, stereo, some large woody species identification possible	delineation (process) information	high cost
Special-purpose aerial photography	highly suitable for detailed delineation and moderately suitable for large woody species identification	usually no temporal (process) information	very high cost
Present LANDSAT MSS optically-processed	good large-area and some seasonal information	many (see Table 1)	low cost
Present LANDSAT MSS digitally-processed	moderately to highly suitable for special purpose information on small areas	information on area not accurate, possibilities for identification still limited	high cost
Future improved satellite MSS system	potentially very valuable	still far from operational, political restrictions likely	unknown
Light aircraft direct observation	moderately to highly suitable for inventory and monitoring, but only on (strip) sampling basis; very good for object surveys (and monitoring)	only limited information on area	variable, from relatively low to high cost
Light aircraft with use of imagery	as above, but without the area restriction	none	as above
Ground sampling with laboratory analysis	most suitable for description on basis of points, identification, and for reliable quality assessment	only information on points	usually very high cost

suggests that the most cost-effective approach overall for vegetation survey in arid rangelands is observation from light aircraft, using LANDSAT imagery or detailed topographical maps as complementary techniques. However, this approach only yields very general data on species composition and forage quantity and quality. A considerable improvement is achieved when it is combined with ground sampling, as done, for example, by Watson et al (1979) in their rangeland survey in Somalia. It is also possible that the role of observation from light aircraft might be partly filled in the not too distant future by an improved satellite MSS system.

As mentioned, this evaluation of the usefulness of future satellite MSS systems is based on work currently under way with LANDSAT and ground multi-spectral sensing which is still at the experimental stage. Satellite sensing is particularly appropriate for vegetation surveys on arid rangelands because of two characteristics of these regions:

- they are large areas under extensive use with low production per unit area, and
- relatively unpredictable short-term processes occur which affect the vegetation cover and availability of surface water, usually directly linked with rainfall.

These characteristics call for a survey technique which can cover large areas frequently at low cost.

The evaluation of survey techniques presented in Tables 1 and 2 clearly suggests that there is no single most suitable technique. Instead a set of complementary techniques is generally best suited to yield the required information at least cost in each situation. Rather than trying to improve specific techniques for use in isolation, future research should focus on information needs which no existing system is meeting adequately and on improved combinations of complementary techniques. Thus for example, LANDSAT imagery can be used most profitably in combination with conventional black-and-white aerial photography, rather than trying to replace the older technique.

INTEGRATING COMPLEMENTARY TECHNIQUES: AN EXAMPLE

An example of the systematic integration of survey techniques is provided by the system of vegetation survey which has been developed at the International Institute for Aerial Survey and Earth Sciences (ITC) in the Netherlands (Zonneveld et al, 1979). Intensive stereoscopic image interpretation was combined with detailed ground sampling in the following steps:

1. assembly of photographs or photomosaics, examination of selected photo-pairs under the stereoscope and preparation of a base map. This step should quickly provide a general impression of the entire survey area. Light aircraft reconnaissance flights along transects can be useful at this stage;
2. systematic stereoscopic photointerpretation, delineating areas with similar features (recurrent patterns) and describing preliminary mapping units in photographic terms, such as pattern, texture and grey tones;
3. transfer of the photointerpretation results to the base map by means of a colour scheme;
4. stratified field sampling on the ground, based on strata corresponding to the units identified by photointerpretation;
5. classification of the ground samples into types, based on the presence or absence of different vegetation species and their associations;
6. matching the vegetation classification units (typology) with the photointerpretation units to determine units to be used for the map legend;
7. reinterpretation of photographs, based on information from the ground samples, to check for inconsistencies;
8. preparation of the final legend linked to a logical colour scheme;
9. preparation of the final map and explanatory report.

Figure 3. Flow chart from rangeland survey of Kalahari desert area in Botswana (240 000 km²) and maps produced

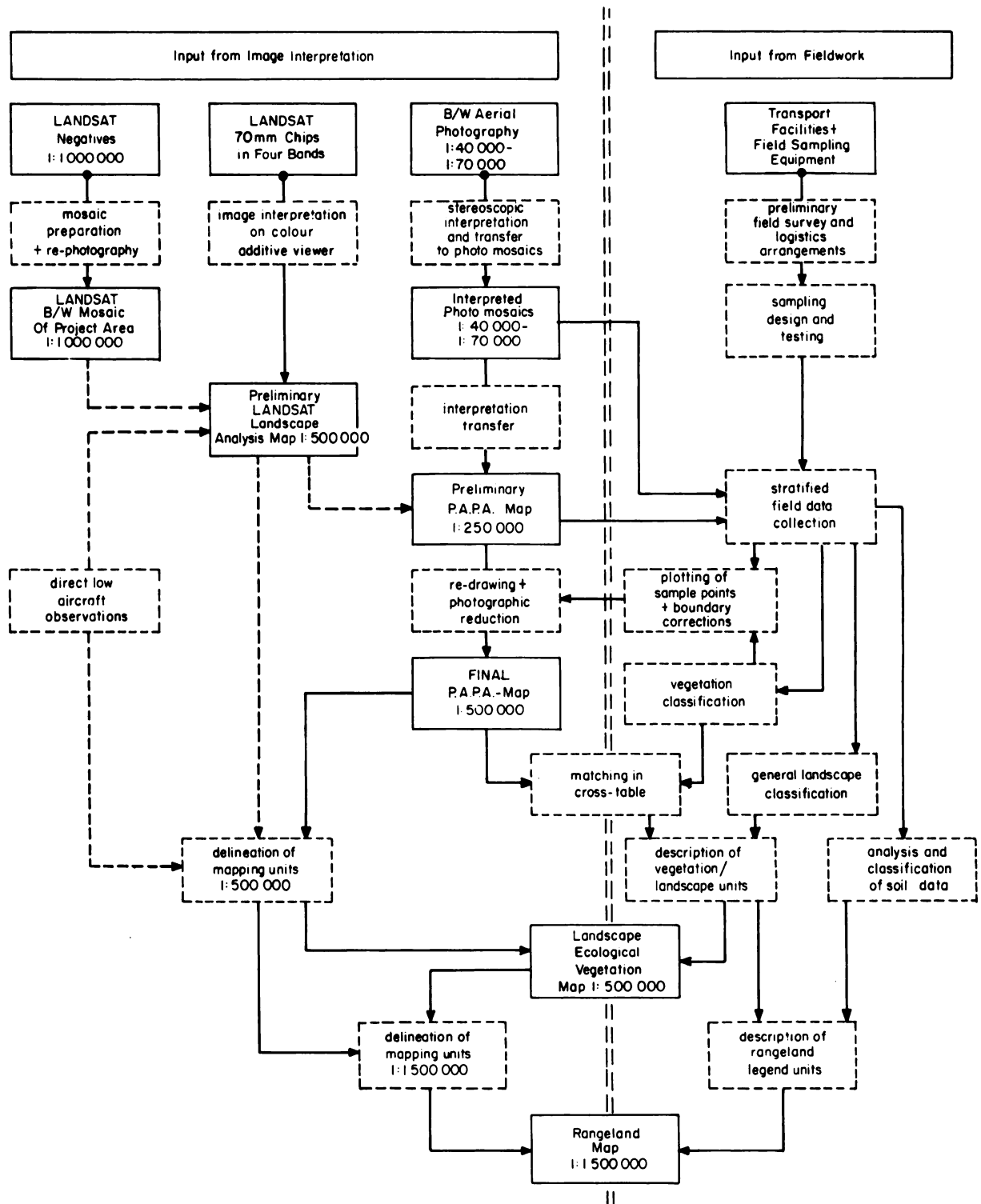

Source: D H V Consulting Engineers (1979).

Figure 4. Possible combinations of complementary rangeland survey techniques

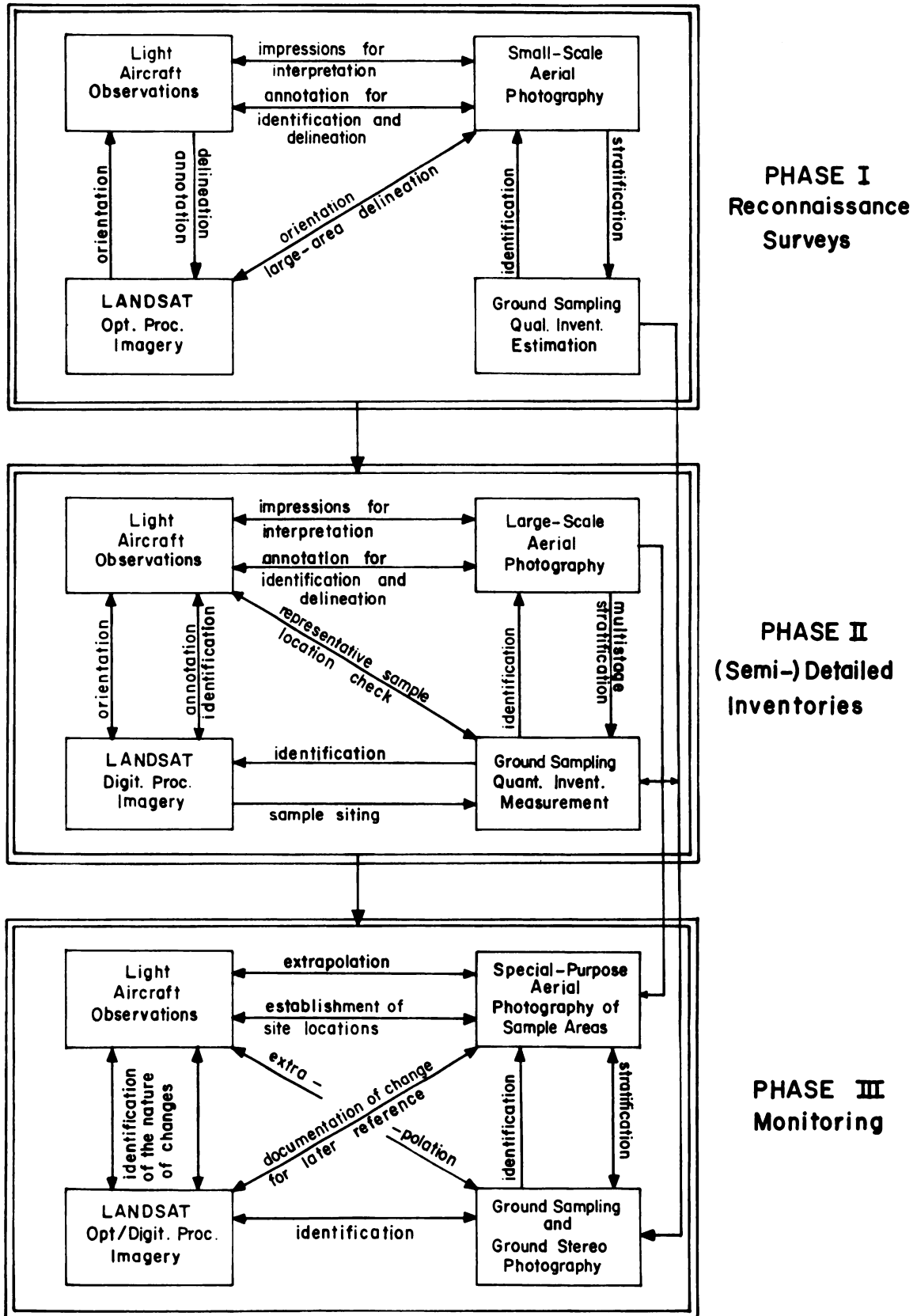

The crucial step in this process is number 6, when all the ground sampling points are entered in a matrix with the preliminary photointerpretation units along one axis and the vegetation typology classes along the other (see Zonneveld et al, 1979). The photointerpretation is used to delineate the units and the ground sampling data to describe them. Recent vegetation maps prepared using this integrated approach can be found in various studies carried out at ITC, such as Baig (1977), Florence (1979), Spiers (1978), the project carried out in Mali (ITC, 1979) and the Botswana study conducted by DHV Consulting Engineers (1979).

In the Botswana study, LANDSAT satellite imagery at different scales was used together with black-and-white panchromatic aerial photography at scales of 1 : 40 000 to 1 : 70 000, direct observations from low-flying light aircraft and field sampling on the ground. The combination of complementary techniques is depicted schematically in Figure 3. The survey results were presented in several forms, including interpreted black-and-white photomosaics, a colour map of the rangelands at a scale of 1 : 500 000 and more detailed maps of selected areas. This presentation is appropriate as a basis for land-use planning at various scales.

The combination of these complementary techniques seems a most promising approach for vegetation inventory and monitoring of arid rangelands. This approach can be broken down into three phases - reconnaissance or general inventory survey, detailed or semidetailed inventory survey and monitoring. Some of the possibilities are depicted in Figure 4.

3. ANIMAL CENSUS

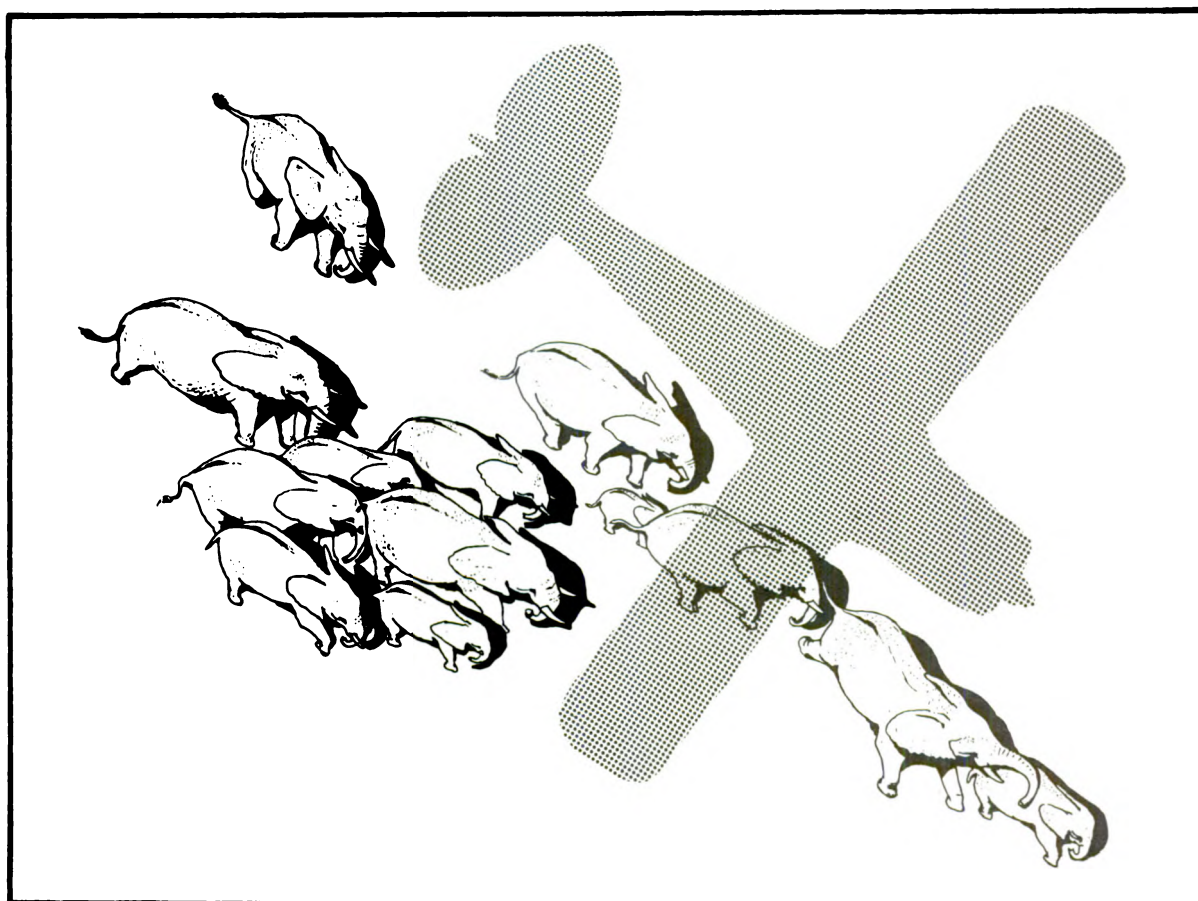

The papers in this section are chiefly concerned with techniques for counting animals and ways of interpreting the results. The use of light aircraft in animal census formed the central theme of the previous workshop held in 1968, and the papers given at that time greatly influenced aerial census techniques in eastern Africa over the next decade. A useful account of these techniques, together with more recent developments in methodology, is given by Norton-Griffiths (1978).

Whereas the primary interest in 1968 was in wild animal census, more emphasis has subsequently been placed on livestock census in rangelands, as the pressure to develop these areas increases. The paper by J J R Grimsdell, J C Bille and K Milligan reviews possible alternative techniques for aerial livestock census and shows how these may sometimes differ from those developed for wild animals. Some of these alternative techniques are speculative, however, and require further testing. J G Stelfox, the chairman of this session, stressed the importance of a flexible approach because no one census technique meets all requirements. Possible techniques must be evaluated in terms of the objectives of each survey, the location, the animals being counted, the financial, manpower and equipment constraints, and the levels of accuracy and precision required.

In their paper on elephant population census, I Douglas-Hamilton and A K K Hillman show how the value of a census is enhanced by the inclusion of carcass counts because a useful mortality index may be obtained from the ratio of dead to live elephants. This technique could be applied to other species and situations; for example, in evaluating cattle mortality in drought-stricken rangelands.

A note by I Douglas-Hamilton, A K K Hillman and C J Moss is also included on techniques for deriving age structures of elephant populations by vertical aerial photography. This is not a census method, but is closely related, since the combination of census and age-structure information provides a basis for evaluating the dynamics of the population under study. Although the method described was developed for elephants, it could be applied to other large mammals, both domestic and wild.

ALTERNATIVE METHODS OF AERIAL LIVESTOCK CENSUS

J J R Grimsdell, J C Bille and K Milligan

International Livestock Centre for Africa

INTRODUCTION

Cattle, sheep and goats are the principal livestock species in Africa, and the only livestock species in many areas. They are generally more conspicuous from the air than wild animals because they are often found in large groups and the coat colour of individuals is often variable, with many light-coloured varieties. Because they are relatively conspicuous, it is possible to count them from higher altitudes than is usually the case with wild animals. Thus, larger areas can be covered and larger proportions of livestock populations sampled in a limited flying time, which helps improve the precision of estimates. Livestock population estimates may also be based on counts of human habitations combined with estimates of average livestock holdings.

THE PRECISION OF POPULATION ESTIMATES BASED ON SAMPLING

Total counts of livestock populations may be practical for small areas where the accurate plotting of herd positions is feasible. In general though, sampling is usually superior to total counts (Norton-Griffiths, 1978). When sampling is used, two main factors affect the precision of the resulting population estimates: the sampling fraction and the degree of aggregation or clumping of the population being sampled.

The sampling fraction

The sampling fraction is defined as n/N where N is the total number of sampling units in the population and n is the number of units actually sampled. The inverse of the sampling fraction (N/n), or expansion factor, is used for calculating the variance associated with a population estimate, which indicates its precision (see Cochran, 1977). A finite population correction can also be used in calculating variance when the population contains a finite number of sampling units. The variance of a population estimate is calculated as follows:

$$\frac{N^2}{n} \cdot \frac{N-n}{N} \cdot s_y^2$$

where the first term is the expansion factor, the second the finite population correction and the third the variance in the number of animals (y) per sampling unit as estimated from the sample.

The first and second terms can be combined, as for example in Jolly's (1969a) method 1 for equal-sized sampling units:

$$\frac{N(N-n)}{n} \cdot s_y^2$$

where s_y^2 (for random samples) = $\frac{1}{n-1} \left\{ \sum y^2 - \frac{(\sum y)^2}{n} \right\}$

The sampling fraction may be modified in two ways: by increasing or decreasing the number of units sampled (n), or by increasing or decreasing the size of the sampling units, thus altering the value of N . The influence of the sampling fraction on the precision of a population estimate is illustrated by a cattle survey carried out in Nigeria (Milligan et al, 1979). Based on this census, the second approach was adopted: the number of sampling units (transects) was kept fixed, but their size (width) was altered. For convenience, a single value of s_y^2 has been used to illustrate the sampling fraction effect, as shown in Figure 1. This figure shows the strong curvilinear relationship between the standard error of a population estimate and the sampling fraction. This is chiefly due to the expansion factor because the finite population correction only has a significant effect when the sampling fraction is high.

Figure 1. The relationship between sampling fraction and the standard error of a cattle population estimate from Nigeria

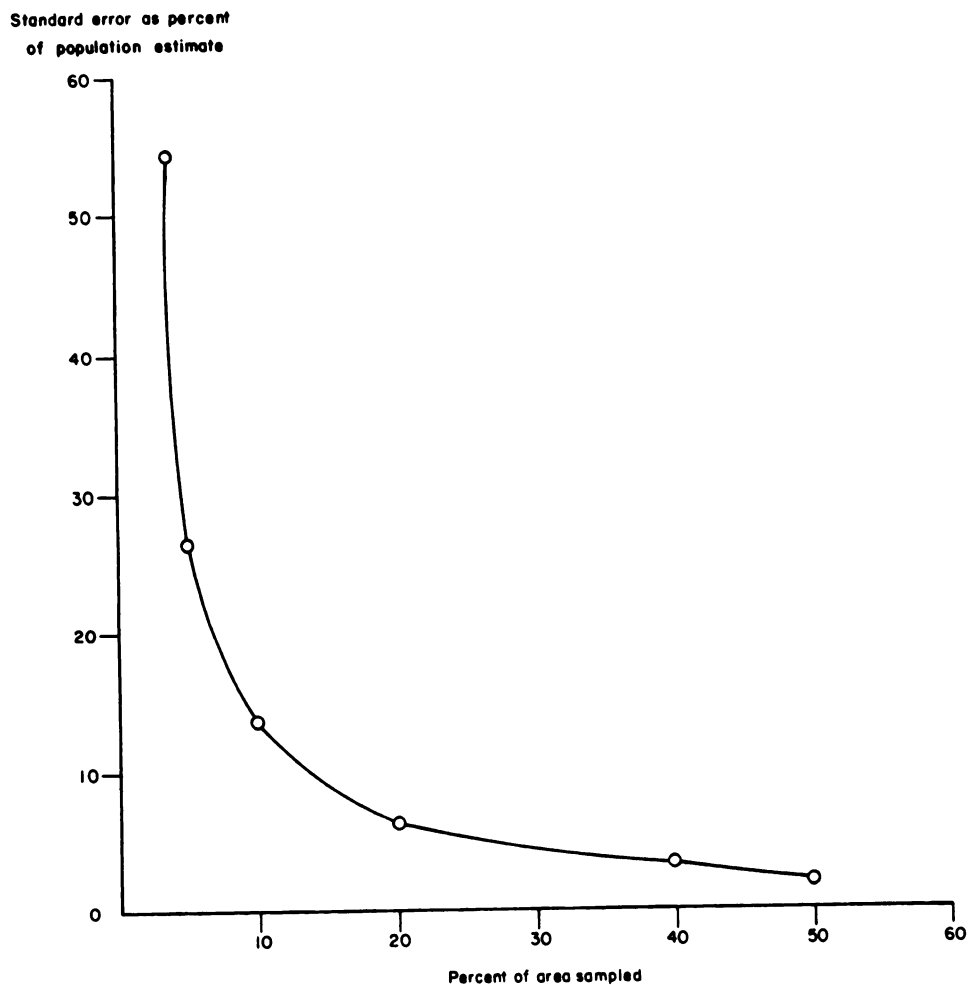

Curves of this nature are useful in deciding how to improve the precision of estimates. For instance in the example illustrated in Figure 1, it is clear that at least 15% of the census area must be sampled to obtain a reasonably low standard error (i.e. less than 10% of the population estimate).

The influence of animal aggregation

The spatial distribution of an animal population also influences the precision with which it can be estimated. Livestock on rangelands, for instance, would be expected to show a clumped or contagious pattern, owing partly to the patchy distribution of resources and partly to the management practices of pastoralists. For example, in the northeastern rangelands of Ethiopia the distribution of cattle groups

was analysed over a 4450 km² study area. Data were collected by systematically sampling 5 x 5 km grid squares, giving a relative index of the number of groups per unit of rangeland. Table 1 shows that the frequency distribution of cattle groups was far from random, as indicated by the fact that it does not fit a Poisson series. The fit is only somewhat better with the negative binomial (Bliss and Fisher, 1953). All this indicates that groups of cattle in the study area were highly clumped. Such a distribution pattern produces transect densities which are positively skewed, because low or medium livestock numbers are found on most transects, but high or very high numbers are found on a few. An example from a cattle survey is depicted in Figure 2.

Table 1. Observed frequency distribution of cattle groups per 5 x 5 km grid square compared with expected frequency distributions for a Poisson series and the negative binomial

Groups of Cattle per Grid Square	Observed Frequency	Expected Frequency (Poisson)	Expected Frequency (negative binomial)
0	81	35.6	81.0
1	33	57.0	55.9
2	19	40.9	19.3
3	14	21.4	8.8
4	15	8.9	4.6
5+	16	4.7	8.4

When the frequency distribution of transect densities is skewed in this way, the variance of the sample tends to be large, chiefly due to the extreme values. Therefore, population estimates based on such samples are likely to be imprecise. If, however, all the areas showing high values are identified and counted in a different way, perhaps by a total count, then the variance of the remaining sample is greatly reduced (Cochran, 1977). This is, in fact, a form of stratification.

Figure 2. Frequency distribution of transect densities from a cattle survey in Ethiopia

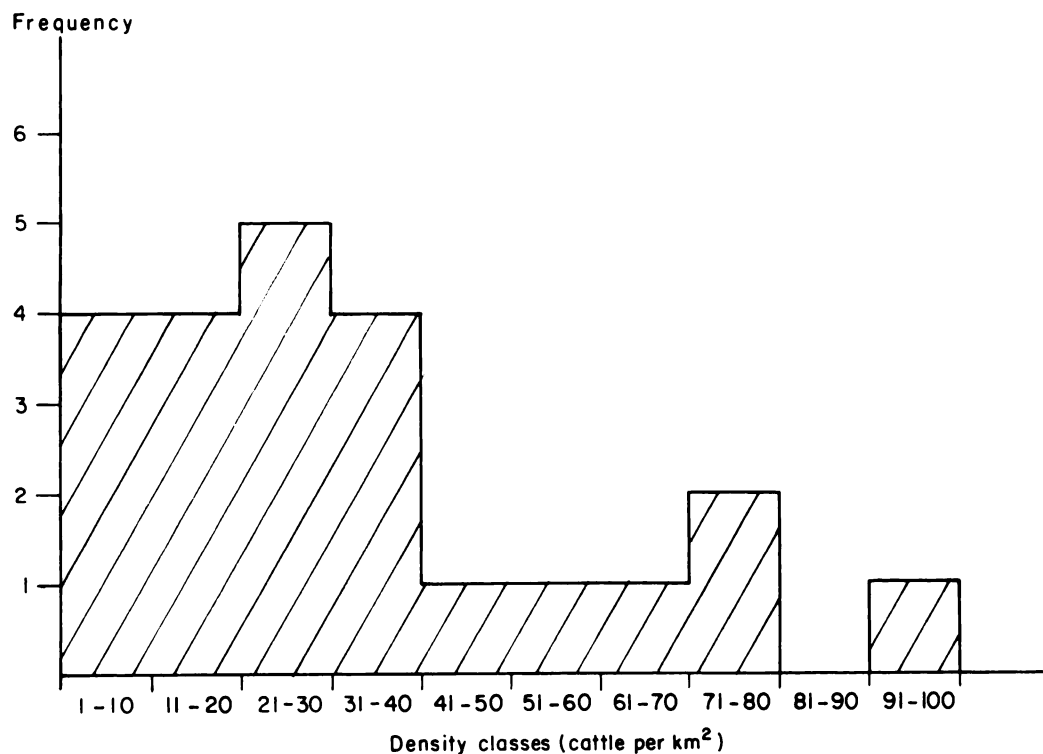

SIX POSSIBLE SAMPLING METHODS

Six alternative methods will be discussed for estimating livestock populations based on aerial surveys. For the first three methods, the discussion will focus on the problem of sampling fraction: for the fourth, the focus will be on problems related to animal aggregation. The last two methods are based on relating livestock population estimates to settlement counts.

The first three methods are compared in terms of the precision of the population estimate obtained at a given cost, as shown in Table 2. The number of transects has been held constant at one every 5 km. Although the variance formulae used here are exact for random samples, it is recognized that they may contain some degree of bias when used for systematic sampling (Pennycuick et al, 1977).

1. Low-level aerial survey with small sampling fraction

Estimates of wild or domestic animal populations are often based on low-level surveys covering small sampling fractions. The aircraft is normally flown at 300 to 400 ft (91 to 122 m) and observations are made along 150 to 300 m wide strips on either side (e.g. Pennycuik and Western, 1972). This approach has two main advantages: the chances of missing groups of animals are reduced because of the low flying height and the narrow strip width, and groups, when spotted, can be counted by eye or from photographs taken with a standard (e.g. 50 mm) lens. The primary disadvantage is that with only one transect every 5 km the sampling fraction is only 8%, so that large standard errors usually result.

Table 2. Comparison of three methods of estimating livestock populations, based on cattle data from Nigeria^a

Method	Sampling Fraction ^b	Standard Error as % of Population Estimate
1	8%	± 21%
2	20%	± 8%
3	40%	± 13% ^c

^aOriginal data from 20% sample of 5 x 5 km grid squares, analysed by Jolly's (1969a) method 1.

^bNumber of transects fixed; sampling fractions varied by changing transect widths.

^cBased on ±3% standard error for number of groups and ±5% standard error for mean herd size, using the following formula (Goodman, 1960):

$$\text{Var } \hat{Y} = (\hat{X}^2 \cdot \text{Var } \bar{Z}) + (\bar{Z}^2 \cdot \text{Var } \hat{X}) - (\text{Var } \hat{X} \cdot \text{Var } \bar{Z})$$

where \hat{X} = estimated total number of groups

Var \hat{X} = estimated variance of \hat{X}

\bar{Z} = estimated average group size

Var \bar{Z} = estimated variance of \bar{Z}

Source of data: Milligan, et al (1979).

2. Medium-level survey with larger sampling fraction

To cover a larger sampling fraction, a survey may be carried out at 500 to 1000 ft (152 to 305 m) with strip widths of 500 m on either side of the aircraft. Groups of animals must be photographed from this height with a telephoto lens (100 to 300 mm). This method has been used, for example, for counting cattle in Nigeria (Milligan et al, 1979). With one transect every 5 km, the sampling fraction is 20%, so the standard error is fairly small. In addition, more data are collected per grid square, giving a better idea of animal distribution than with the first approach. However, this method is only practical for large conspicuous groups of animals in open or moderately open country: in general, it is most useful for herds of cattle. Though small groups may not be spotted, the degree of bias can be checked by surveying the same area at a lower altitude with a narrower strip width.

3. Combination of two aerial surveys at different heights

Livestock population estimates may be obtained by carrying out two independent aerial surveys and combining the results. First, the aircraft is flown, for example, at 2000 ft (610 m) and 1000 m sampling strips are surveyed on either side. From this height with one transect every 5 km, 40% of the study area is sampled, but only the number of groups or herds is recorded as it is not possible to count individual animals. A representative sample of groups is also photographed and counted from a lower altitude, and from this sample an estimate of the mean group size is obtained. The total population is then calculated from the results of the two surveys by multiplying the estimated total number of groups by the estimated average group size. The standard error of the population estimated is calculated according to the formula given in Table 2.

This approach yields a fairly precise estimate of the number of groups because the sampling fraction for the higher-altitude survey is large. If the average size of groups can be estimated precisely, then a population estimate can be calculated with a moderately low standard error. Reliable information on livestock distribution can also be collected.

In practice, however, it may be difficult to obtain a precise estimate of average group size. The frequency distributions of cattle group sizes were examined for four study areas in Nigeria (Milligan et al, 1979) and one in Ethiopia during both wet and dry seasons. It was found that herd sizes varied considerably in different locations and at different seasons. The frequency distributions of herd sizes were never symmetrical, so the estimated variance tended to be large. In addition, small groups were sometimes not spotted from the air. These surveys indicate that average cattle herd size can vary appreciably within one study area, so great care is needed to obtain a representative sample. This may involve flying systematically over the entire study area, photographing a large sample of herds - perhaps more than 100 - which will add significantly to survey costs.

4. Aerial survey plus total count of large groups

As already mentioned, the precision of a population estimate can be improved if any large groups within the census area are counted separately. This is a form of stratification, but, owing to animal movements, the positions of the high-density strata are not known at the outset of the survey. Rather, the positions of large groups are mapped during the survey and the groups are counted later. Norton-Griffiths (1978) describes this method, taking as an example a census of topi in the Serengeti. The locations of large herds, falling either inside or outside the survey transects, were marked on a map, but the herds were not counted. Then after the main survey was completed, each of the large herds was photographed to obtain a total count. Two population estimates were then produced: one based on the transect count but excluding large herds and one based on a total count of large herds. These were added together to give the final population estimate. The standard error was taken from the transect estimate, as the total count involved no variance.

This method should be applicable to livestock counts, although it does not appear to have been used for this purpose up to now. Precise population estimates are achieved, provided all the large groups can be located and counted. However, in some cases it may be difficult to locate all the large groups, and counting them

separately also increases survey costs.

5. Surveys at two altitudes to count livestock at settlements

Livestock populations may also be estimated by locating all the human settlements in an area from an aircraft flying at about 5000 ft (1524 m), and then revisiting them at a lower altitude to make a total count of livestock holdings. This was done by Western (personal communication) in Kenya's Amboseli basin, where aerial photographs were made at each Masai settlement in the early morning when the cattle had just been let out of their night pens (*bomas*). A total cattle count was made from the photographs.

This approach is only practicable, however, if there are not too many settlements in a study area and they can all be accurately mapped. It does not provide much information on livestock distribution, for instance in relation to environmental factors. Counting from photographs may be difficult if the animals are too closely bunched together, and accurate counts are not obtained in situations where some animals are not penned at night.

6. Livestock estimates based on house counts

House counts in pastoral areas probably provide a good index of total livestock numbers, provided average household livestock holdings are known. Reliable estimates of average holdings may be obtained from ground or aerial surveys, while houses or settlements should be relatively easy to count from the air. One advantage of this approach is that a large sampling fraction of houses can be covered in limited flying time. However, this method will not be very reliable if household livestock holdings vary considerably, for instance over time.

CONCLUSIONS

A number of aerial survey methods may be considered for estimating livestock populations, some of which are quite different from those which have been developed for counting wild animals. The selection of a particular method depends on a number of factors, such as the types of livestock present in the study area, the accuracy and precision required, the time and money available, and any additional information which needs to be collected in the course of the survey.

ELEPHANT CARCASSES AND SKELETONS
AS INDICATORS OF POPULATION TRENDS

I Douglas-Hamilton and A K K Hillman*
World Wildlife Fund/International Union
for the Conservation of Nature
Elephant Survey and Conservation Programme

INTRODUCTION

Elephants have always posed problems to authorities, either as crop raiders, major agents of habitat change or as a potentially valuable natural resource. Decision-makers have had to consider such diverse questions as whether elephants should be culled as an ecological management policy within a park, or whether anti-poaching forces should be reinforced and the ivory trade banned to prevent their elimination. The true status of elephant populations has been confused by their apparent over-abundance in some areas and their disappearance from others. In every case where decisions must be made, knowledge is required of how many elephants there are and how their numbers are changing. The most basic requirement is a series of censuses which are accurate enough to indicate trends in numbers and densities over the years.

Unfortunately, research on elephants over the past 15 years has been very uneven. Some parks have been the subject of intensive and repeated studies, while others have been neglected. The object of elephant field surveys sponsored by the

*The authors are grateful to C Moss, R Weyerhauser, M Barengo, K Behrensmeyer, H Bunn, D Western and other individuals and organizations mentioned in the text for provision of data on elephants. Thanks are also due to the New York Zoological Society, the World Wildlife Fund and the International Union for the Conservation of Nature for their support of the work described here.

International Union for the Conservation of Nature (IUCN) has been to supplement data already available, to provide current information on particular areas where research was carried out in the past, and to census previously uncounted areas. This information, combined with a questionnaire survey, will serve as a basis to monitor the trends of key elephant populations in Africa, and by extrapolation the elephant population of the continent as a whole.

So far, 17 surveys have been carried out in Kenya, Tanzania, Uganda and Zambia supported by the World Wildlife Fund and the New York Zoological Society (WWF/NYZS), together with the national wildlife departments and national parks in each country. In addition, aerial censuses have been carried out by others in 17 other countries where African elephants are found.

The purpose of this paper is to review methods of recording dead elephants, and to discuss how carcass records can be interpreted. In addition, the usefulness of this type of information will be discussed. The methods used for elephant carcass surveys are based on systematic counting from the air along sampling strips, as described by Norton-Griffiths (1975) and Western (1976). Although elephants are one of the least cryptic wildlife species, it is still possible for an observer to miss not only single animals, but even whole herds. Since for these surveys observers were used of varying experience and ability, easily scannable strip widths were chosen, usually around 150 m, irrespective of terrain. These strip widths were calibrated by flying 20 to 30 times over markers on a runway and taking the average strip width seen by the observers. It has been found that more accurate strip widths are obtained by adjusting the strut markers, rather than by making adjustments using mathematical formulae.

In addition to censusing live elephants in the surveys which have been carried out, dead elephants were recorded as an indicator of mortality, often as supplementary evidence to confirm a trend. The methods suggested here for recording elephant carcasses have been developed from previous work.

PREVIOUS STUDIES

It is a curious fact that elephant carcasses were very seldom recorded by researchers in the late 1960s, when some of the most important studies on elephant population dynamics were carried out. A reference was made to the apparent lack of dead elephants by Lamprey et al (1967), who remarked of the Serengeti that '... since 1961, wardens and biologists have flown for a total of over 2 000 hours over the Park and have only located eight elephant skeletons'. This observation was used to support the hypothesis that elephants had only recently arrived in the Serengeti. However, the elephant population had been on the order of 2 000 over the preceding 3 years, and it must be assumed that a natural mortality rate of 3 to 4% would have resulted in 60 to 80 skeletons a year, which had apparently largely gone unnoticed.

A single exception to the general lack of carcass observations was Graham and Laws's (1971) study in Murchison (now Kabalega) Falls National Park in Uganda. These authors were not so much concerned with measuring mortality trends through carcass observations as with identifying available quantities of ivory. In any event, they suggested some criteria for estimating carcass age since death and estimated that they had seen about 26% of all the dead elephants which were probably in the park.

No other quantitative records of elephant carcasses were made in the late 1960s. Evidently they were not considered a sensitive enough indicator of the moderate rates of elephant mortality which prevailed during that time, so no baseline was established in areas which have subsequently experienced a great increase in elephant mortality. As elephant carcasses became more abundant in the early 1970s, counting them by various methods became more widespread.

Following increased elephant mortality in Kenya's Tsavo East National Park, triggered by the 1970-71 drought, Corfield (1973) carried out a study with the objective of measuring mortality through ground and aerial carcass counts. A year later in the neighbouring Tana River District, Watson et al (1973c) recorded

carcasses and commented that the observed increase in the frequency of recent carcasses was undoubtedly caused by increased killing for ivory, resulting from a recent rise in ivory prices. According to later counts, his estimate of 900 dead elephants out of a live population of 32 000 was decidedly low. However, this count was made in the rains and it is likely that many of the dead elephants were hidden.

Subsequent aerial monitoring in Tsavo National Park and elsewhere, carried out by Cobb (1976), Leuthold (1976), the Kenya Wildlife Conservation and Management Department (WCMD), the Kenya Rangeland Ecological Monitoring Unit (KREMU) and the authors, all included counts of elephant carcasses seen within transects. Several of these studies, using somewhat different criteria, have attempted to identify carcasses that have been dead for less than a year, with the intention of estimating annual mortality. Standard methods of recording and classifying carcasses will be discussed.

CLASSIFICATION OF CARCASSES

A classification system for elephant carcasses is suggested which includes four categories recognizable from the air. These are described as follows.

Category 1: fresh

This category comprises elephants which have died recently, perhaps 2 to 3 weeks previously at the most. The skin is still present, and the flesh has not yet been eaten or rotted away, but gives the body a rounded appearance. Vulture droppings may cover the skin and surrounding area, which is often well trampled by scavengers. Carcasses only remain in this category for a short while, but their numbers can be of use to pinpoint waves of mortality which may merit investigation by management authorities.

Category 2: bones with rot patch

The second category also covers elephants which have died recently. The presence of skin and the scattering of bones are not reliable indicators of age, especially in areas where predators are dense and the rainfall is relatively high, so these have not been used as primary criteria. As Graham and Laws (1971) pointed out, a rot patch caused by the release of decomposition fluids often kills grass around a carcass and stains the surrounding soil. This is usually identifiable and lasts until the next heavy rains. The rot patch is taken as the primary criterion for this category.

Category 3: bones without rot patch

After heavy rain the rot patch is usually washed away, and grass or other vegetation may grow over it. The skin may or may not disappear, depending on rainfall and scavenger density, but the white skull and bones are often clearly visible, depending on the vegetation cover. There is no sharp distinction between this and the second category.

Category 4: old bones

After several years, the bones begin to develop cracks and pieces chip and flake off. They turn a greyish colour and become extremely cryptic. From the air, the skeletons no longer stand out as distinct entities. Twelve-year-old bones at Lake Manyara were similar in appearance to 11-year-old bones at Galana Game Ranch which resulted from an elephant culling operation carried out by Laws and Parker in 1967 (Laws, 1969).

FACTORS AFFECTING THE RATE OF CARCASS BREAKDOWN

In order to attach ages to the four carcass categories, the factors affecting the rate of breakdown and visibility need to be considered. These factors will be discussed, and then the average rate of decomposition will be described for two samples of carcasses of known age from Amboseli and Manyara National Parks.

The most important factors affecting the disintegration and disappearance of carcasses were found to be rainfall, scavengers, sunlight and shade. The first two of these will be discussed.

Rainfall

An increase in rainfall generally increases the rate of carcass breakdown by softening the skin and allowing the action of invertebrate decomposers. Graham and Laws (1971) give an example from the high-rainfall area of Kabalega of a skeleton which was already grey and crumbling (i. e. category 4) after only 4 years. One 4-year-old carcass observed by the authors was classified as category 3 in 1977, yet only a year and a half later in August 1978, following heavy rains, the skin had disintegrated and the bones were almost hidden by grass. Although the carcass was at least 5 years old, the bones were uncracked since they had been sheltered from the sun during most of that period by the skin. Shaded and sheltered bones may last indefinitely (like the relics of saints), but an elephant corpse which was well shaded and sheltered would not be visible from the air.

The rapid disappearance of the skin associated with heavy rains occurred in all 20 elephant carcasses monitored in Amboseli during 1978. As the rains that year were heavy throughout Kenya, the presence of skin on any carcasses seen within the following 12 months could be used as an indicator of death since mid-1978. The other effect of heavy rainfall is the increased grass growth which reduces visibility. For this reason carcass counts should only be made in the dry season, preferably after the grass has been burned.

By contrast, in an arid zone of relatively low scavenger density, such as Amboseli during recent dry years, many of the elephants which have died have dried up, with the bones held together by hardened skin. From their work on the taphonomy of carcasses in Amboseli, Behrensmeyer and Western (personal communication) estimated that large skeletons, such as elephant skeletons, could remain visible for up to 10 years.

Scavengers

If a carcass is scavenged by lions or hyenas during the first few days while the skin is soft, the skin may be partially or completely removed and bones scattered. This exposes the bones to weathering, makes it easier for them to be hidden by vegetation and renders the skeleton more difficult to see from the air than if it were a compact mass. In an area of high scavenger density, for example Seronera in the Serengeti, carcasses are rapidly dismembered. An elephant that died only 2 months previously, but was immediately attacked by scavengers, left only a skull and a few scattered bones visible from the air. In this case, there was also no visible rot patch, which suggests that most of the animal must have been eaten before it had time to decompose. In Kenya's Aberdares National Park, hyenas are abundant and scatter a carcass within days; rapid vegetation growth then renders the carcass invisible (P Snyder, personal communication).

ALLOCATION OF AGES TO CARCASS CATEGORIES

The decomposition of 32 known-age carcasses in Manyara National Park and 25 in Amboseli National Park has been followed intermittently over a 3-year period. The dates of death and locations of carcasses at Amboseli were furnished by C Moss, and similar information was recorded during long-term elephant monitoring in Manyara. The population densities of scavenger species (lion and hyena) were similar in both areas.

For each carcass, the following information was recorded at each observation:

- category (1 - 4)
- wear stage of bones, as defined by Behrensmeyer (1978)
- scatter of bones
- presence or absence of skin
- aerial visibility of crania and other major bones
- broad vegetation type

- recent rainfall
- scavenger use
- other qualitative information.

The results of these surveys are summarized in Table 1. In Manyara, with a mean annual rainfall of 760 mm, the average age of category 1 carcasses was 7 days, for category 2 the average was 5 months, for category 3 it was 14 months, and for category 4 ages ranged from 12 to 25 months. In Amboseli, with annual rainfall averaging 300 mm, there is no record of how long carcasses remained in category 1, but for category 2 the average age was 9 months, for category 3 it was 23 months, and for category 4 the age range was from 20 to 60 months. Real age varied widely within each category and overlapped with adjoining categories. The transition from category 2 to 3 in Manyara generally occurred before the end of the first year, while in Amboseli category 2 carcasses could be older than 1 year. This pattern indicates the effect of heavier rainfall, which tends to increase the rate of carcass breakdown and disappearance.

The proportion of carcasses in each category with skin visible was similar in the two parks. In category 1, 100% of the carcasses had skin, in category 2, 80 to 90% had skin; and in category 3, 20 to 30% had skin.

The most useful distinction is between carcasses less than and more than 1 year old. The identification of carcasses less than 1 year old gives a relative measure of annual mortality when compared with live populations, and indicates differences in mortality between areas. An absolute measure of mortality is not possible because not all carcasses are seen and some break down or disappear within less than a year.

Results from several areas indicate that the transition between categories 2 and 3 generally occurs at around 1 year after death. The results, however, also indicate the importance of considering scavenger density, average rainfall and recent short-term rainfall patterns in each area. Despite some imprecision in relating carcass categories to age, a baseline of carcass densities for different

Table 1. Ages of carcass categories as determined from known-age carcasses in Manyara and Amboseli National Parks

Location	Mean Annual Rainfall (mm)	Cate-gory	N	Mean Age (months)	Age Range (months)	Average Wear Stage	Scatter (m)	% Visible From Air	% with Skin (nearest 10%)
Manyara	760	1	4	0.12	0-0.2	0	2	100	100
		2	11	5.30	0.07-8.0	0-1	4	90	90
		3	11	14.50	10-19	1-3	10	70	30
		4	6	19.00	12-25+	2-5	13	50	0
			—						
			32						
Amboseli	300	1	1	0.2	-	0	2	100	100
		2	7	8.6	0.07-30	0-1	5	90	80
		3	6	23.0	20-60	1-3	9	100	20
		4	11	45.6	20-60	1-3	18	80	0
			—						
			25						

populations is now being accumulated by a number of research teams. Where monitoring flights are carried out on a regular basis, it is possible to identify trends in mortality rates.

APPLICATION OF THE METHOD

Although the technique of aging elephant carcasses is new, comparative results offer some insight into recent patterns of elephant mortality in eastern Africa. The results can be presented as a ratio of dead to live animals seen during a count. The use of this ratio may to some extent even out biases due to individual observers, since a good observer is likely to see more carcasses and more live elephants than a poor observer so the ratio should not change.

Figure 1 gives a range of dead to live ratios in conditions of similar visibility. Only the ratios for the Selous, Ruaha and Manyara areas appear to represent normal mortality. The ratios for Selous and Ruaha, in particular, are likely to be accurate since they are derived from large samples. At the other end of the scale, the Tsavo, Tana, Lamu-Garissa and Samburu areas show ratios that indicate heavy mortality.

To illustrate the usefulness of information provided by elephant surveys using carcass data, three recent case studies will be described. The three situations and the information needed by wildlife managers and decision-makers were as follows:

- Kabalega Falls National Park, Uganda, 1976: Had most of the elephants in the park been killed or had they just left the park?
- Tsavo National Park, Kenya, 1978: Was it drought or was it poaching which caused a major elephant population crash?
- Luangwa Valley, Zambia, 1979: Were there still too many elephants in the area and should they be culled, as recommended by a UNDP/FAO report (FAO, 1973), or had they been affected by poaching, and if so to what extent?

Figure 1. Ratios of dead to live elephants in various localities of eastern Africa, 1976-77

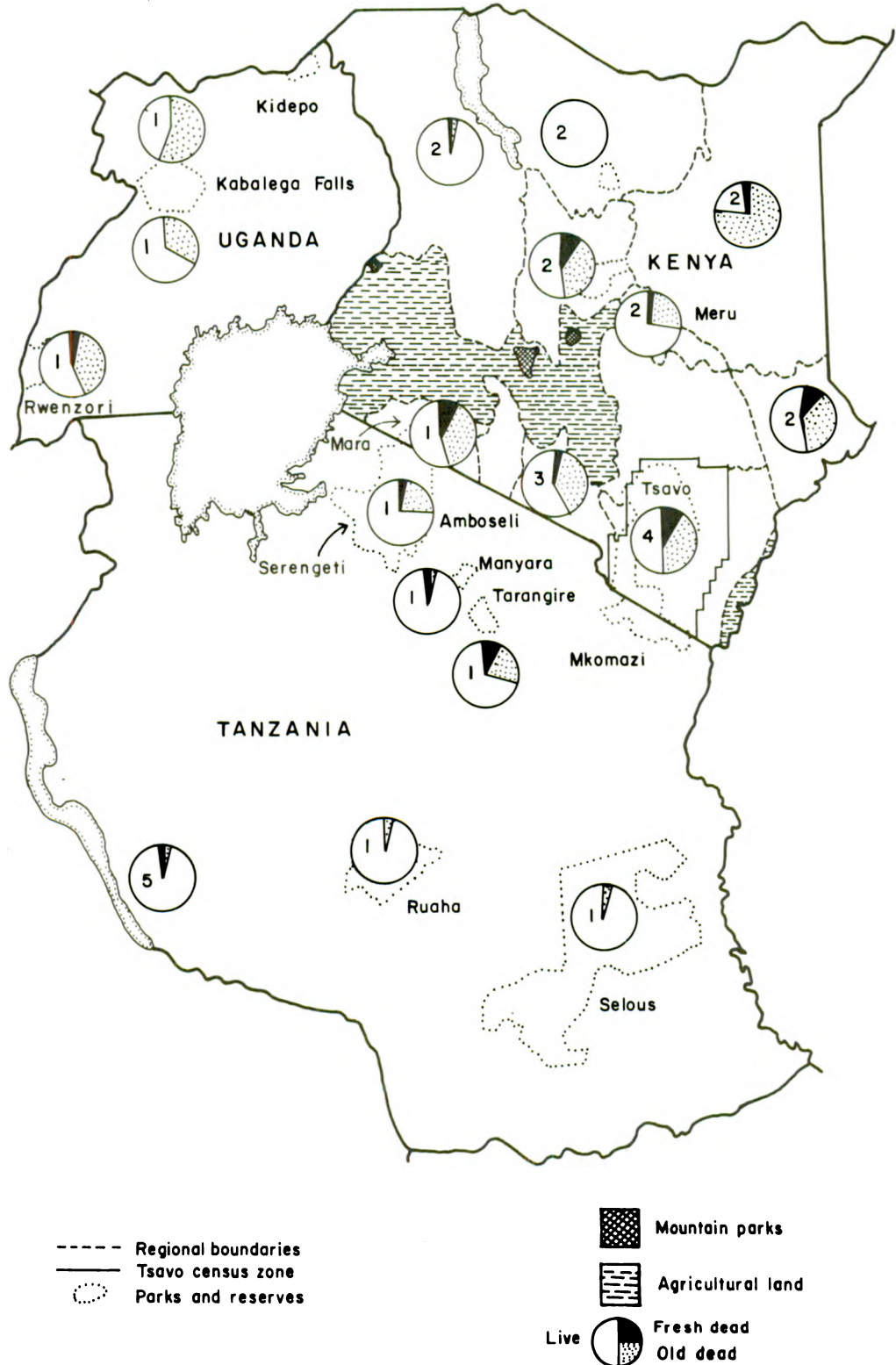

Sources: 1 = IUCN; 2 = KREMU; 3 = D Western; 4 = WCMD; 5 = Ecosystems Ltd.

The first question concerned the Kabalega Falls National Park, Uganda. In 1976 at the time of the third East African Wildlife Symposium, Eltringham and Malpas (1980) had recently completed a series of aerial sample counts of the Kabalega Falls National Park, which suggested a catastrophic elephant population crash. Doubt had been cast on the validity of their results, however, since it was suggested that the population crash might not be real owing to sampling errors, or that elephant numbers had not really decreased, but that the elephants had merely taken refuge in the neighbouring Budongo Forest.

At the invitation of the Uganda Institute of Ecology, I S C Parker and Douglas-Hamilton made a total count which followed exactly the methods used by Parker 10 years previously. Only 1 713 elephants were counted, compared to the 1967 estimate of at least 8 000. This confirmed Eltringham and Malpas's conclusion that the population in the park had declined, but was this due to mass migration, as alleged?

Unfortunately, there was no previous baseline against which to measure carcass density, but according to Parker's recollection carcass density appeared to have increased: 912 category 3 carcasses were counted, estimated to be over a year old by the absence of rot patch, and it was estimated that only 26% of the carcasses actually present in the park had been seen, according to Graham and Laws's (1971) undercount factor. In fact, as the total count was primarily focused on live elephants, not carcasses, the proportion of carcasses seen was probably even less. These results strongly suggested that the elephants had not moved out of the park, but had been killed, and counts carried out in the Rwenzori National Park indicated a similar trend. Some idea was also gained of rates of skeleton disappearance in this particular area, because there were virtually no bones left at the site of the culling which took place in 1967.

In Kenya's Tsavo National Park, it had been disputed whether an observed reduction in the elephant population was due to drought or poaching. In 1967 when

Laws was working in Tsavo, carcasses were so few that they were not considered worth recording. However, in 1970-71 an unusually dry period resulted in the death of some 6 000 elephants, almost entirely along the Galana River in the eastern part of the park (Corfield, 1973). Over subsequent years there were shorter periods of elephant starvation, the last of which was in 1975/6 when, according to Sheldrick (1976), about 9 000 elephants probably died of all causes.

Yet mortality due to drought was not immediately apparent from aerial survey results. Successive estimates, using the same sampling techniques within the Tsavo census zone defined by Cobb (1976), are summarized in Figure 2. Cobb's series of counts during 1973-74 gave population averages close to the previous rough estimate of 35 000 (Laws, 1969). Cobb's last count, made in November 1974, is especially interesting because for the first time he also counted all dead elephants, including skeletons which were several years old. From this count he estimated a population of 37 827 live elephants and 11 837 dead, giving a total of nearly 50 000 elephants. This figure raises the possibility that there may have been more elephants in the area in 1967 than previously estimated, and that many of the dead which Cobb recorded had been killed by the drought. Results from another count, made by Leuthold in 1975, were not significantly different from Cobb's.

In the years following the drought, the park warden commented on an unprecedented increase in poaching and a spread in poacher activities from a fringe along the northern boundary to all parts of the park (Sheldrick, 1976). In June 1976, a sample count made by the WCMD registered a sharp drop in elephant numbers, accompanied by a dead to live ratio of 44:100. Fresh carcasses had increased from a mean of 602 estimated by Cobb to 2 600. A second count was made in September 1976; the average of the two counts is given in Figure 2. KREMU carried out counts in 1977 and 1978. When these results are modified to apply to the same Tsavo census zone as previous counts, minus Mkomazi, they give an average of about 19 000 live elephants, which is not significantly different from the IUCN count of nearly 20 500 made in April 1978. Visibility conditions during the IUCN survey resulted in a much lower dead elephant count because there

Figure 2. Elephant population estimates in the Tsavo census zone

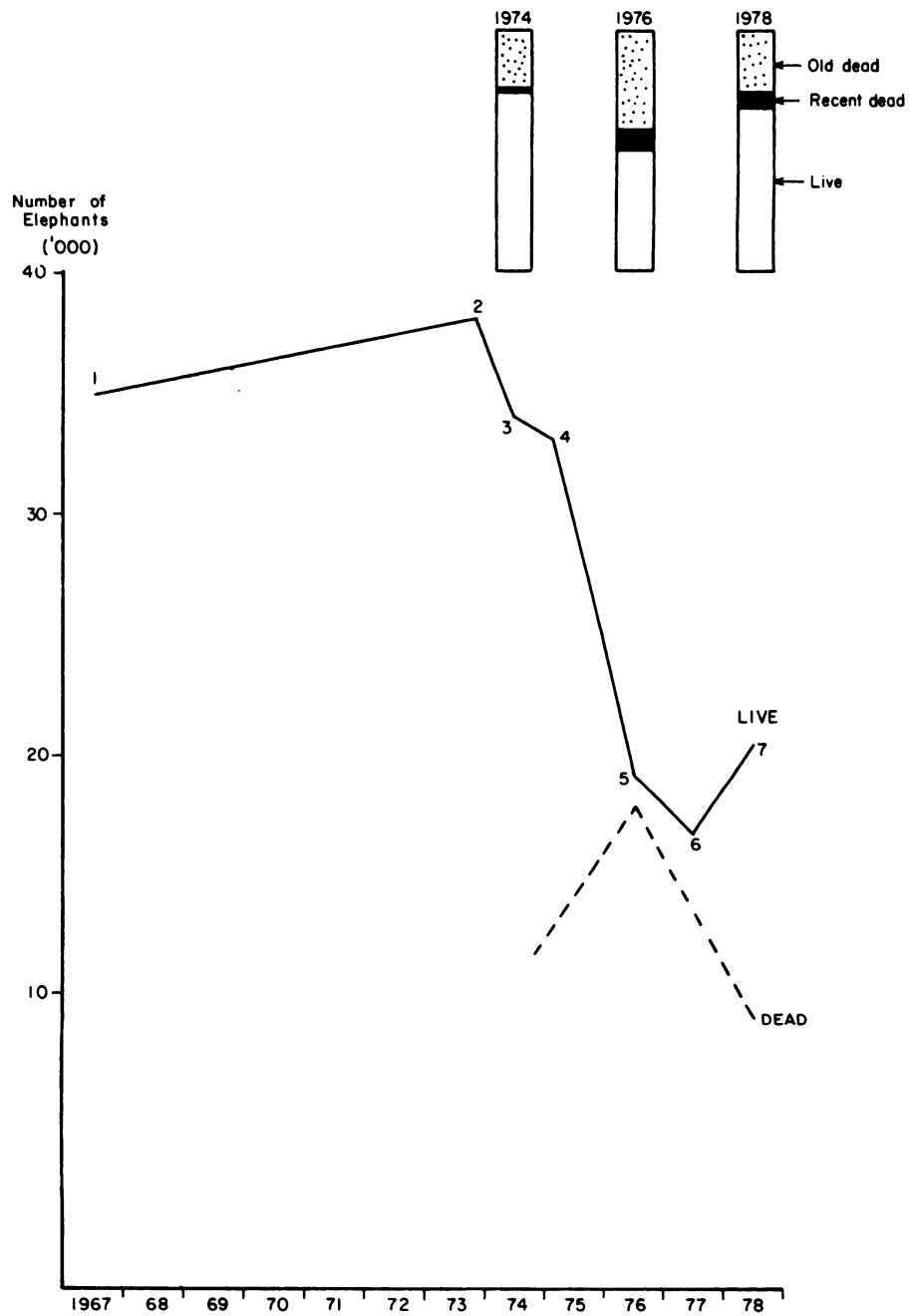

Sources: 1. Laws (1969); 2. Cobb (1976); 3. Cobb (1976, mean of five counts);
 4. Leuthold (1976); 5. WCMD (mean of two counts); 6. KREMU;
 7. IUCN.

Table 2. Elephant population estimates in three areas of Luangwa Valley, 1973 and 1979

Location	Area (km ²)	1973 Estimates		1979 Estimates			
		total	density per km ² standard error	total	density ² per km standard error		
North Luangwa	4 460	17 700	3.97	2 790	7 360	1.65	1 520
Munyamadzi corridor	2 400	6 700	2.79	1 430	3 350	1.39	455
South Luangwa	9 420	31 600	3.35	2 650	22 800	2.42	3 500
Total or mean	16 280	56 000	3.44		33 510	2.06	

	Munyamadzi corridor		South Luangwa		Total
	North Luangwa		South Luangwa		
Decline in numbers, 1973-1979	10 340	3 350	8 800		22 400
Percent decline, 1973-1979	58%	50%	38%		40%

Sources: For 1973, Caughley and Goddard (1975); for 1979, Douglas-Hamilton et al (1979).

Figure 3. Elephant live to dead ratios for Luangwa Valley census zone, October 1979

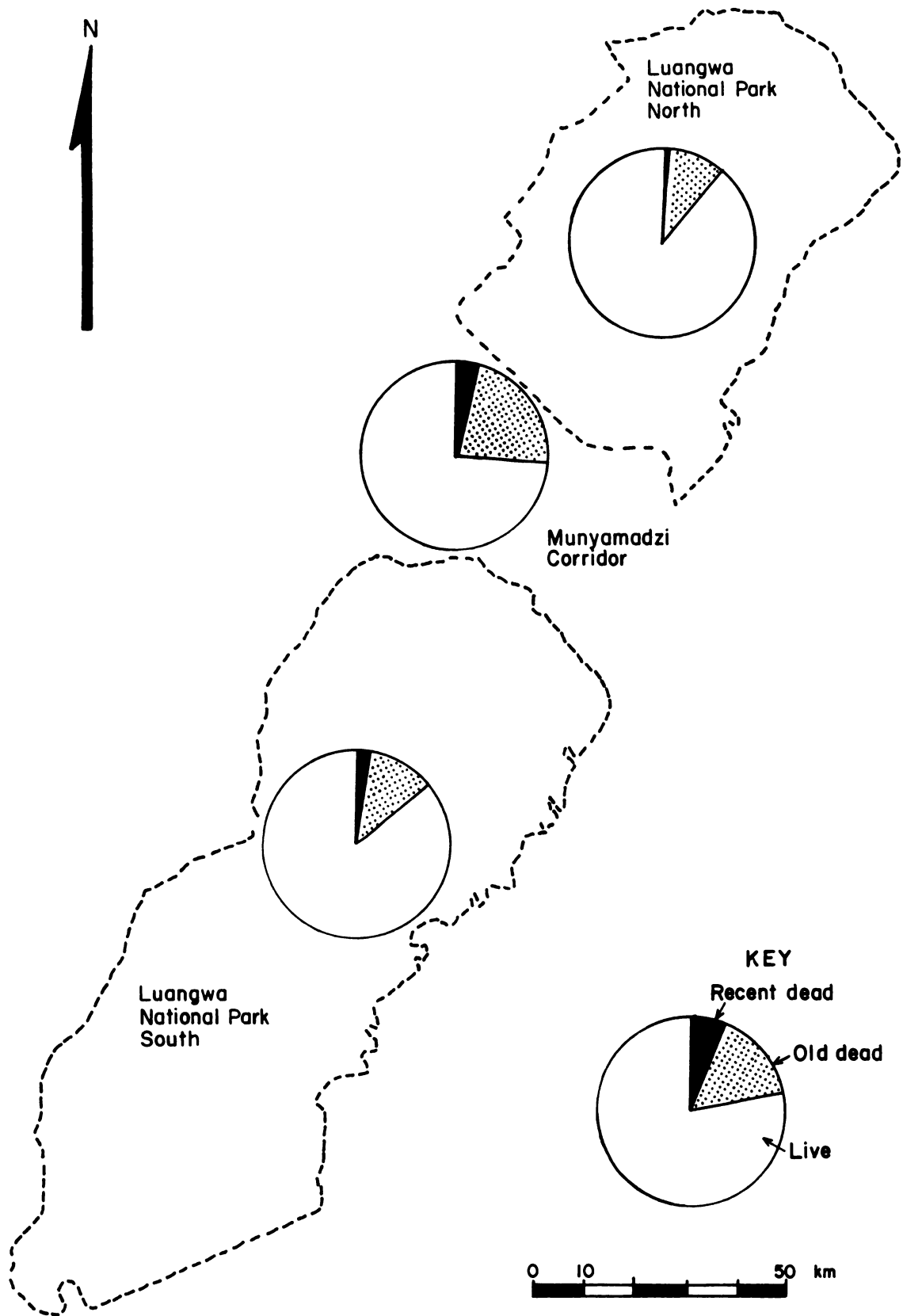

had been heavy rains and the entire area had a thick ground cover of grass and herbs which largely concealed elephant carcasses and skeletons. The information from these aerial surveys indicates that the most substantial drop in elephant numbers occurred after 1975 and could thus only be due to poaching, not drought. This fact is of considerable concern to those responsible for managing the park.

Douglas-Hamilton et al (1979) counted live elephants and carcasses in Zambia's Luangwa Valley, including Luangwa North and Luangwa South National Parks and the Munyamadzi corridor. Their methods were similar to those of Caughley and Goddard (1975) who conducted a census in 1973. A comparison of information from the two counts is given in Table 2. Assuming that the two counts were of similar accuracy, it would appear that the population has shown an overall decline of 40% during the 6-year period. Further evidence for a decline in population, probably caused by poaching, is provided by the carcass analysis, which suggests a substantial ratio of dead to live elephants (see Figure 3). The situation in Luangwa is reminiscent of Tsavo in 1974 after the drought, but before the surge in poaching. The survey information indicates that wildlife managers in the Luangwa Valley should take measures to counteract poaching; culling programmes should not be considered until poaching can be shown to be under control.

In conclusion, the main purpose of this paper has been to stimulate comments on ways to improve the methods of counting and interpreting elephant carcass densities and to encourage those conducting elephant surveys to record carcasses in a standardized way. This information should be important in interpreting long-term changes in elephant mortality which will help wildlife and resource managers make better decisions concerning the management of elephant populations.

NOTES ON VERTICAL PHOTOGRAPHY OF ELEPHANTS FOR
AGE DETERMINATION

I Douglas-Hamilton, A K K Hillman and C J Moss*
World Wildlife Fund/IUCN Elephant Survey and
Conservation Programme and
African Wildlife Leadership Foundation

INTRODUCTION

Age structures of elephant populations may be estimated from vertical aerial photography (Laws, 1969; Croze, 1972; Leuthold, 1976). Two methods have been used, both of which depend on relating the length of backs to age. They are:

1. The ratio method, in which the largest females photographed from the air are assumed to have attained maximum (or asymptotic) back length. Lengths of other elephants on the photographs are then expressed as a proportion of this maximum length and these proportions are converted to ages using an age/length ratio key (see Croze, 1972).
2. The absolute length method, in which back lengths are calculated using the following formula:

$$L = \frac{I \times A \times 100}{F}$$

where L = back length of the elephant in cm

I = back length as measured from photographs in mm

* The authors are grateful to H Croze, D Western and Ecosystems Ltd for information which contributed to this paper, to J Scherlis, R Weyerhauser, H Rubin, O Douglas-Hamilton and the wardens of Amboseli and Manyara National Parks for valuable assistance; and to the New York Zoological Society and the World Wildlife Fund for financial support.

A = height of aircraft above ground in m

F = focal length of lens in mm.

A radar altimeter must be used since the exact height of the aircraft above ground is used in the calculation. Ages are then determined directly from curves of length compared with age (see Laws, 1969).

The purpose of this paper is to review some of the sources of error in the two methods and also to compare the two methods by reference to elephants of known age in Manyara National Park in Tanzania and Amboseli National Park in Kenya. The ages of these elephants were recorded by registration at birth by Douglas-Hamilton in Manyara and Moss in Amboseli. Up to 10 photographic flights were made over known elephant groups while observers plotted the position of individual elephants on the ground. Individuals were then identified on the photographs and calculated ages were compared with known ages.

SOURCES OF ERROR IN CALCULATING ELEPHANT AGES FROM MEASUREMENTS OF LENGTH

Photogrammetric errors

Five types of photogrammetric errors occur in calculating the ages of elephants from measurements of length taken from aerial photographs. These are related to focusing, radial scale, measurement, the use of a radar altimeter and tilt. Focusing errors, however, do not affect aerial photography in the same way as they do ground photogrammetry provided the focus is maintained constantly at infinity and the focus ring is taped in position.

Radial scale error is a property of every lens. If a scale with equidistant points is photographed at right angles to the optical axis of the lens, so that the scale image passes through the principal point of the negative, it will be found that the scale points will not be separated by equal distances on the negative and that the

error increases towards the edge of the frame. Radial scale error is minimized by using a good quality (e. g. Nikon) 50 mm lens, which has minimum radial distortion, and by measuring elephants only in the centre of the negative, i. e. within two-thirds of the radius taken from the photocentre.

Measurement error is proportionally greater the smaller the image. It can be reduced by enlarging the image by projection. This has the disadvantage of increasing blurring and therefore the problem of deciding exactly where the elephant begins and ends. It also introduces extra distortion by introducing more lenses and it is difficult to ensure absolutely perpendicular projection and standard degrees of enlargement. It is also impractically cumbersome in the absence of a permanent dark room.

Measurement error can also be reduced by enlarging the image by examination under a microscope fitted with a very fine measuring scale. This approach is easy to carry out and to standardize and avoids many of the possible distortion errors which occur when the image is projected. However, it requires delicate manipulation, and the small field of view increases the chances of measuring an elephant more than once. Yet on balance, this method seems preferable; it gives accurate readings according to the calibrations of the measuring scale used.

The accuracy of different radar altimeters varies according to the manufacturer. In practice, a radar altimeter must be calibrated for gross errors against the pressure altimeter. For example, calibration of a King Gold Crown altimeter installed in a Cessna 185 demonstrated that the altimeter was inaccurate at 600 ft (183 m) or more. For this reason and also because larger images give better results, photographs were taken at a maximum height of 500 ft (152 m). It is also possible to test the accuracy of a radar altimeter by photographing a scale set on the ground from different heights. This was done in Manyara National Park using a 35 mm camera with a 50 mm lens to photograph a 1 metre scale. The results of these trials are shown in Figure 1, which indicates a maximum deviation of only 2.5% from the theoretical power curve appropriate to a 50 mm lens. This suggests that the methods used were sufficiently accurate for measuring elephants.

Figure 1. Size of photographic image of 1 m scale on ground in relation to height of aircraft

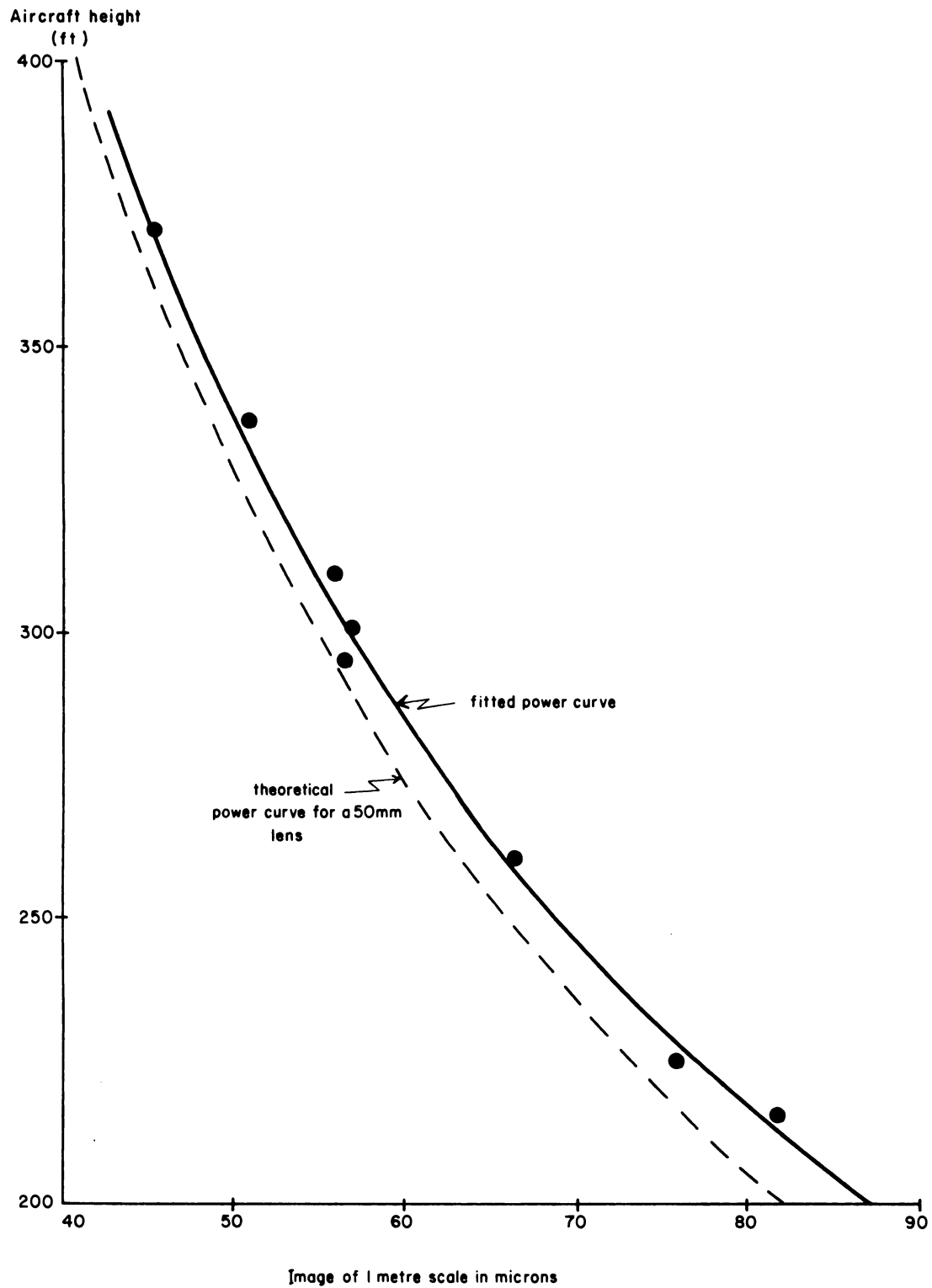

In lining up a camera vertically above an elephant group, the aircraft may occasionally have a slight bank at the moment of the altimeter reading. The altimeter projects and receives pulses in a cone, with the reading taken from the point on the ground nearest to the aircraft. Bank will not therefore affect the reading if it is kept within the limits specified for the radar altimeter in question.

Tilt error occurs because elephants on the peripheries of a photograph will inevitably be viewed at a slight angle from the vertical. The higher the aircraft, the smaller this angle will be. Eliminating the peripheral third of a photograph will also minimize this possible source of error.

A more important source of error due to tilt is the possibility of the camera being tilted from the vertical. Absolute perpendicularity could be ensured by attaching the camera to the aircraft and using the aircraft instruments to ensure that it is horizontal. However, this would make it extremely difficult to line up the camera in exactly the right place over a group of elephants, which can add to the time and cost of a survey. It has proved most practical to hold a camera by hand outside an aircraft with the door removed. The error caused by a 10% tilt of the focal plane of the camera is only 3.12% at 400 feet (122 m) above ground. Furthermore, the possibilities of tilt error are minimized by rejecting all photographs on which the elephants' feet can be seen laterally.

Elephant-related errors

Errors in calculating the age of elephants from length measurements taken from aerial photographs may also relate to different features of the elephants themselves. Lengths may be miscalculated due to anal flaps or different heights of elephants above the ground. Age calculations from length are based on the maximum (asymptotic) size of the largest females observed, which may vary, particularly between small herds. Elephant calves hiding under their mothers may also be missed from the air, and finally there may be some discrepancy in the relationship of back length to age among older animals. Each of these possible

sources of error will be discussed.

Application of the anal flap correction factor given by Croze (1972) made only a 1% difference in a sample of elephants measured. This procedure was therefore considered unnecessary, both from the standpoint of the extra time involved and in comparison with the magnitude of errors arising from other sources.

The height of an elephant above the ground and the height differential between adults and calves affect the calculation of length from aerial photographs. The lower the aircraft, the greater this effect will be. Assuming a mean asymptotic shoulder height of 250 cm and a difference in shoulder height of 150 cm between adults (250 cm) and calves (100 cm), percentage errors can be expected as shown in Table 1. This table suggests that flying height should be at least 300 ft (91 m).

Table 1. Percentage errors in elephant length calculations due to height of animals

Flying Height (m)	Percentage Errors	
	adults	adult/calf differential
30	8.0	5.00
61	4.0	2.50
91	2.7	1.60
122	2.1	0.98
152	1.6	0.98
183	1.4	0.82
213	1.2	0.70
244	1.0	0.62

Using the ratio method, each sub-adult animal is aged in relation to an asymptotic length of adult females, based on 10% of the individuals in the frame. Thus, variations in the asymptote have a considerable effect on the rest of the age estimations. The smaller the group, the proportionally higher the possible variations. There are three main sources of this variation. For one thing, inclusion of bulls raises the value of the asymptote. The aircraft should make low passes over each group to note the presence of bulls and where necessary oblique photographs should be taken to locate the bulls in relation to the rest of the group. Secondly, the size of matriarchs can vary considerably, as has been observed in Amboseli. As mentioned, the smaller the group, the more the variation in sizes of adult females can effect the estimated ages of younger animals. Finally, error may result from a lack of adult females. In certain areas, such as Galana Ranch in Kenya, heavy, uncontrolled hunting has resulted in the elimination of the majority of adult elephants (M Stanley-Price, personal communication). An asymptote derived from such a population would result in overestimation of ages. The absolute length method must therefore be used to estimate the ages of populations of this kind.

Errors also occur due to the undercounting of calves. Elephant calves less than 1 year old tend to hide under their mothers when an aircraft flies over. It is therefore easy to miss calves on aerial photographs. Low passes, allowing oblique observation, should be made in order to count all the young calves.

Finally, the relationship between back length and age is assumed to be similar to the growth curve given by Laws (1969) for shoulder height compared with age. This is based on Laws's assertion that back length 'is found to be almost exactly equal to the shoulder height measurements . . . , but the elephant continues to grow in length after growth in shoulder height has ceased or greatly slowed down'. This statement has been checked by plotting back length and shoulder height, as measured from photographs of elephants taken at Amboseli National Park by H Croze, C Moss and D Western (Figure 2). Similar comparisons have been made using data given by Laws and Parker (1968) for cropped elephants from Tsavo and Murchison Falls National Parks. The results confirm Laws's statement: back

Figure 2. Relationship between back length and shoulder height for 24 elephants in Amboseli National Park, measured from photographs and calibration poles

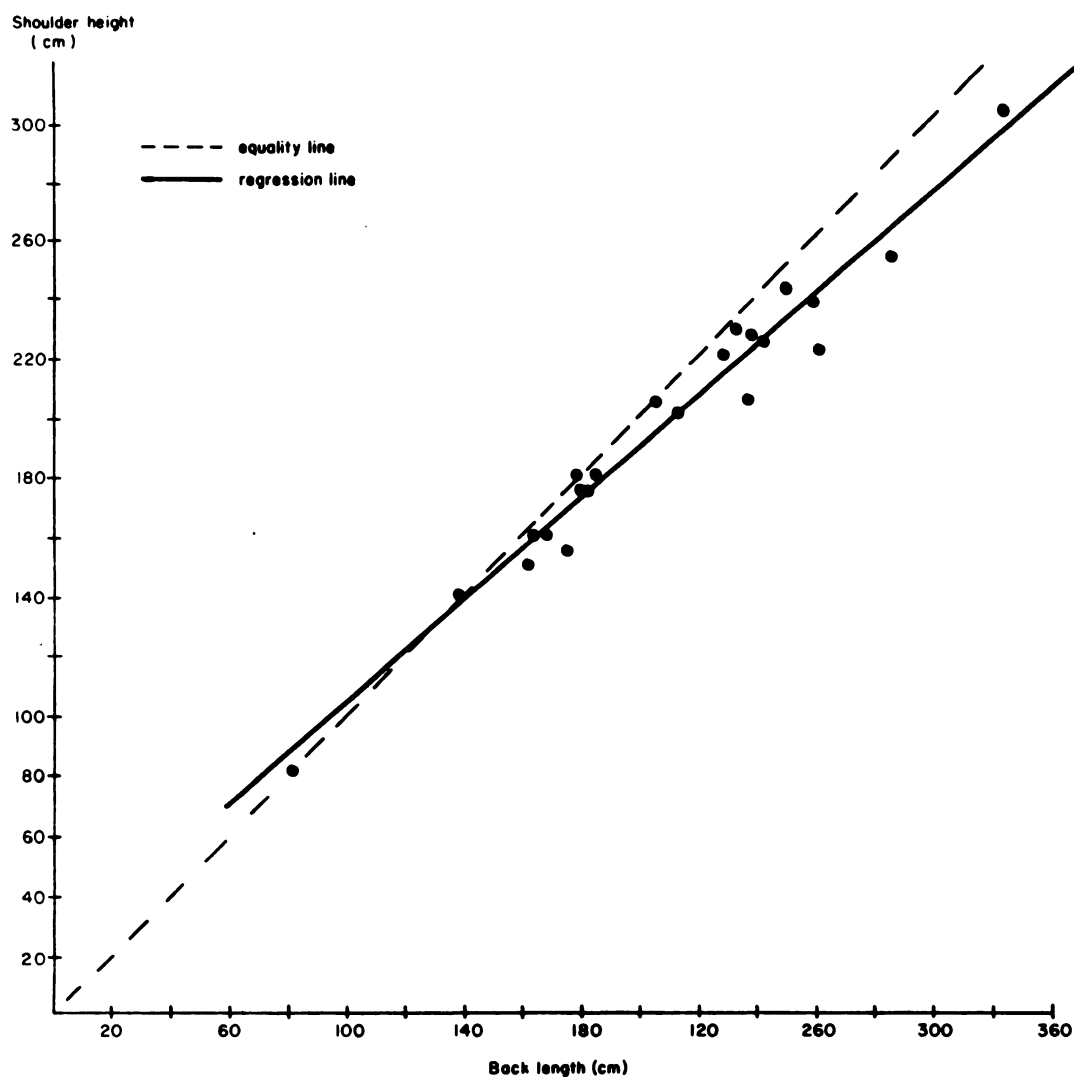

length and shoulder height are similar up to about 15 years of age, but thereafter only growth in length continues. The rate of growth is also faster for males than for females. However, the discrepancy between back length and shoulder height in older animals is small, so that the shoulder height curve can still be used to estimate age from observed back length.

COMPARISONS OF CALCULATED AGE WITH KNOWN AGE

The results of comparing calculated with known elephant ages are summarized for Amboseli and Manyara National Parks in Figures 3 and 4. Both the ratio method used in Amboseli and the absolute length method used in Manyara give calculated ages which allow accurate identification of calves less than 1 year old. The scatter increases with age, but the regression shows a close correspondence between calculated age and known age for both methods. This suggests that the technique is valid for the identification of first-year calves and for the reconstruction of age structures from large samples.

RECOMMENDATIONS

On the basis of experience, and considering the sources of error and bias already discussed, the following recommendations can be made for future elephant surveys involving estimates of age from aerial photographs:

1. The radar altimeter should be calibrated both against the pressure altimeter and by photographing and measuring scales on the ground from different heights.
2. The optimum flying height is 300 to 400 ft (91 to 122 m).
3. The most practical way to photograph groups of elephants from the air is by using a camera with a 50 mm lens, held by hand right outside the aircraft fuselage and pointing straight down. It has been found easier to work with the right-hand door of the aircraft removed. The pilot lines up for a straight run over the elephants and as they disappear from his view, under the nose of the aircraft, the camera operator leans out and directs the pilot's final adjustments by hand signals. It is easier to fly directly into the wind, but sometimes if the elephants are spread out in a line it is necessary to fly along their axis taking a series of pictures.

Figure 3. Comparison between known age of 20 elephants in Amboseli National Park and age estimated by ratio method

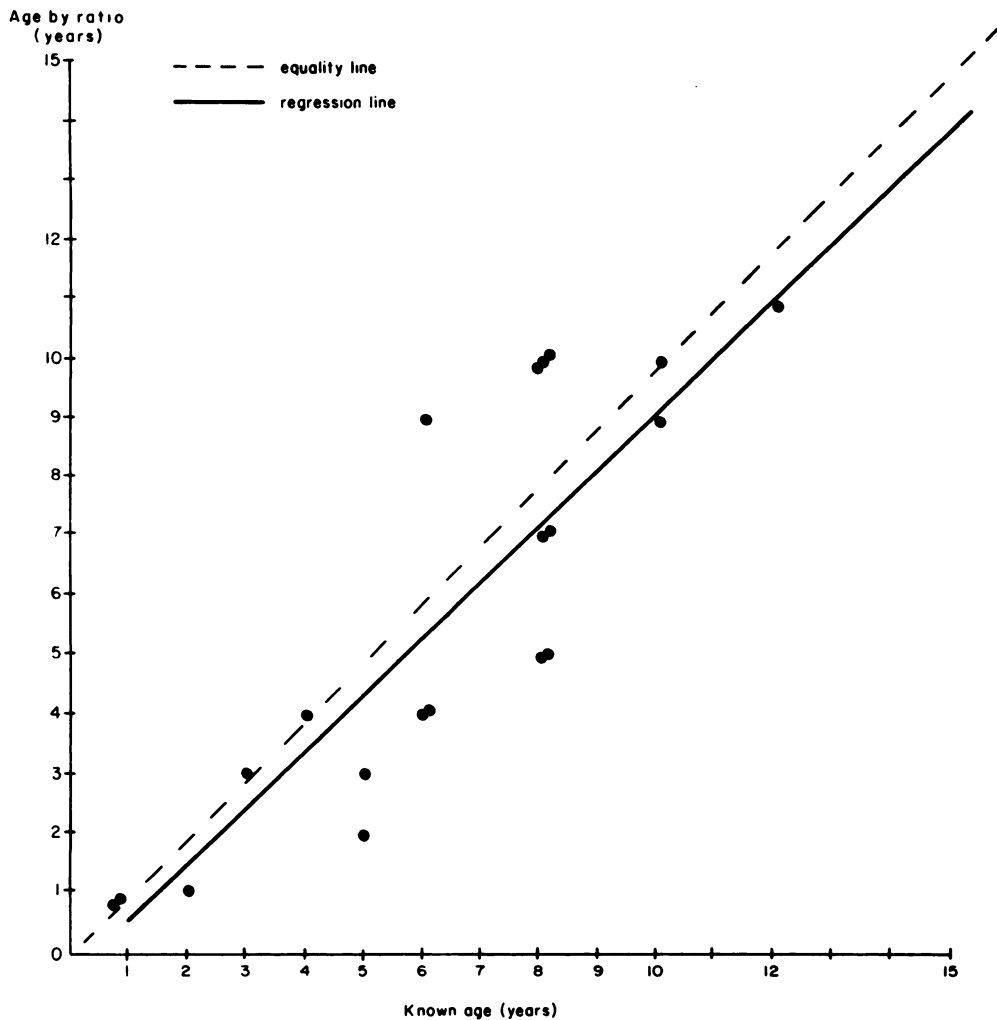

4. A radar altimeter reading should be made each time a photograph is taken. This can be done if the photographer signals the pilot at the moment a picture is taken and the pilot reads the altimeter, or by an electrical connection between the camera shutter, the altimeter and a recording device.
5. The aircraft bank should be kept within the specifications of the radar altimeter.

Figure 4. Comparison between known age of 25 elephants in Manyara National Park and age estimated by absolute length method

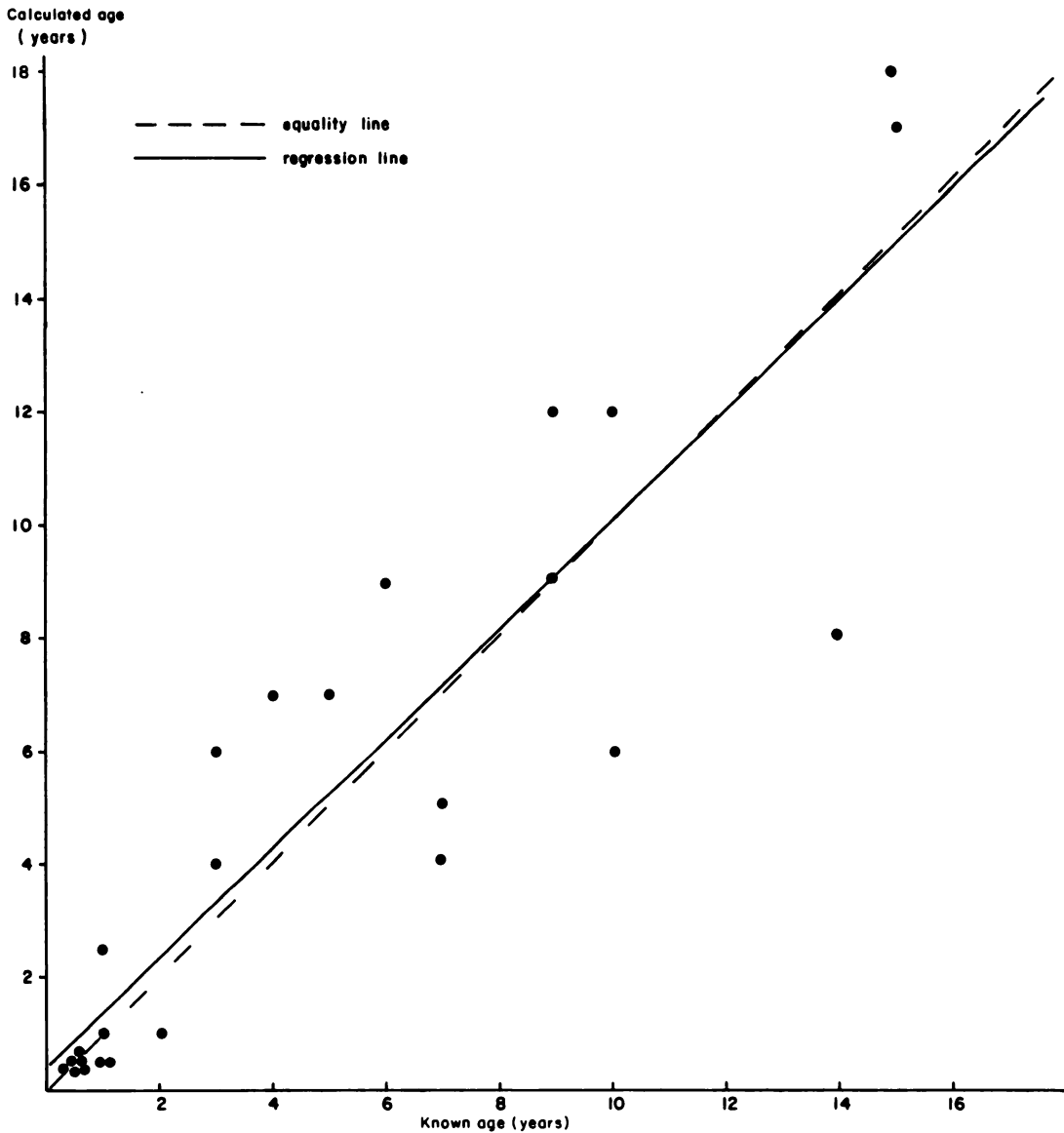

6. **Low passes should be made to count the bulls and young calves in each group.**
7. **Fine-grain colour film should be used to minimize the inaccuracy of measurements and the difficulties of interpretation.**
8. **A series of overlapping frames should be photographed whenever a group is too large to be included in one frame.**

9. Detailed notes should be made of aircraft height and the position and number of frames taken of each group.

4. SURVEY DESIGN AND SAMPLING PROCEDURE



During the workshop, a strong plea was made for greater interchange of experience with survey design and sampling procedures among the various organizations concerned with aerial survey. In particular, it would be useful, and should be possible, to achieve some convergence of opinion on the means by which strata are determined.

There was no general agreement on the use of stratified or unstratified sampling or random or systematic sampling in aerial surveys, but the three papers presented in this section provide some guidance to workers in the field. The first two papers, by G M Jolly and G E J Smith, give general accounts of these sampling procedures. Jolly compares unstratified systematic sampling with stratified random sampling, favouring the latter for most purposes, while the third paper, by M Norton-Griffiths, argues in favour of unstratified systematic sampling for obtaining distribution data and for stratification after the survey is completed.

SAMPLING UNITS AND THEIR SELECTION

Random sampling combined with standard analytical procedures is known to give unbiased results under all circumstances. However, a substantial body of opinion has favoured systematic (that is, regularly spaced) sampling units, trading off slightly reduced precision for better estimates of distribution of animals or other parameters.

There was general agreement at the workshop on the greater efficiency of transects as sampling units, as compared with quadrats. Edge effects in transects, although potentially large, should not produce bias or materially increase random sampling error, provided strip widths are properly calibrated. Edge effects also occur in quadrats or blocks that cannot be clearly defined by ground features. Quadrat sampling tends to be more subjective, and bias may result when large quadrats are searched, due to missing or overlapping areas. The costs of surveys based on quadrats are generally higher than those of surveys based on transects - by as much as 40%. Finally, air sickness in observers is more common in quadrat surveys.

A quadrat may be the most appropriate sampling unit in a few situations, however, such as when sampling segmented forest areas or when surveying the area in a photographic frame. A further advantage of sampling based on quadrats is the possibility of spending more time searching over the sampling unit and flushing out cryptic animals.

Subunits of a transect cannot be considered as independent samples because of the possibility of autocorrelation. Most practitioners favour the use of complete transects as sampling units on which to base their estimates of sampling error. If grid square data from systematic transects are used in the analysis of population estimates, then the estimate of sampling error changes according to the degree of subdivision of the transect. Sampling effort may be distributed over seasons, rather than collecting more precise data at one time, and two-stage sampling is also permissible, provided the appropriate formulae are used.

STRATIFICATION

The usefulness of stratification to improve precision and to allow estimates to be made for separate areas was agreed, but subsequent discussion revealed a spectrum of opinion as to whether the most effective stratification was one based on permanent land features or on ephemeral factors affecting animal distributions.

Also, a stratification which is appropriate for one parameter might not be appropriate for others. Strong views were expressed on the desirability of making use of relatively low-cost information from LANDSAT and ecological maps to produce initial strata which can be modified in the light of further information. Other, equally strong views suggested that a systematic sample, recorded in discrete attribute sections along each transect, gives the best indication of distributions on which to base any subsequent stratification. A combination of these methods is used by KREMU, which routinely covers the entire Kenya rangelands systematically, but uses stratifications, such as the designation of 44 ecological units, for special localized surveys.

The probable cost-effectiveness of a stratification scheme should be estimated where possible. Information is often required by both planners and managers for separate administrative districts, but such information can be derived from a weighted average of estimates from the component strata. The heterogeneity of administrative districts in terms of development needs must also be recognized.

A REVIEW OF THE SAMPLING METHODS USED IN AERIAL SURVEY

G M Jolly

Agricultural Research Council Unit of Statistics

University of Edinburgh

Whether or not the use of aircraft in research has increased during the last decade, there has undoubtedly been a growing awareness of the need for a high standard of reliability in aerial data. It now appears to be generally accepted that counting animal populations from the air requires a different level of skill from counting a nearby single file of sheep jumping over a gate - and even the latter might produce substantial errors in the most wide-awake observer. The present paper is not concerned with the ultimate uses of aerial survey data, but rather with the procedures for obtaining reliable information on animal populations, other ecological features and land use generally from low-flying aircraft by direct observation or conventional photography.

Types of sampling unit will be discussed first. Methods of sample selection will also be considered briefly, and the relative merits of unstratified systematic and stratified random sampling discussed.

TYPES OF SAMPLING UNIT

The four main types of sampling unit are strip samples, quadrats or blocks, line intercepts, and line transects. All are artificial units, which is an advantage in terms of variability, since natural units are generally more homogeneous within themselves and therefore give correspondingly greater variation among units.

Strip sample

The strip sample or transect, not to be confused with 'line transect', is now a widely accepted sampling unit for aerial survey. Its merits are discussed by Norton-Griffiths (1978), for example. For rigorous estimation of population values from a strip sample, it is essential that strip width be calibrated in the way described by Caughley (1977a), Norton-Griffiths (1978), Watson and Tippet (1975) or Jolly and Watson (1979). When height is recorded by radar altimeter, the effect of calibration on the total sampling error should be negligible, provided adequate calibration data have been obtained. Many papers which have reported results from strip sample surveys have made no mention of calibration, leaving the reader to speculate on whether or not the sampling errors reported represent the total sampling error. In the absence of any attempt to calibrate, and depending on the exact sampling method used, results will also be biased to an unknown extent.

Typical examples of strip sampling are Bell et al (1973) for lechwe, Norton-Griffiths (1973) for wildebeest using vertical photography at 10-second intervals along the strip, Caughley and Goddard (1975) for elephant, Ross et al (1976) for large ungulates including elephant and giraffe, and Watson et al (1977) for domestic livestock, other species and miscellaneous agricultural and ecological features.

When a strip runs through a large herd, the simplest method of sampling would be to count animals within the strip only. However, this method ignores information on the herd itself and is not the most efficient method of enumeration. Watson and Tippet (1975) adopt an alternative procedure when a herd is encountered some members of which lie outside the strip. Wing struts are marked off in units of one strip-width as seen by the pilot-observer, thus allowing a quick, approximate estimate to be made of the total 'width' of the herd. The aircraft then deviates from its path, if necessary, to count or photograph the complete herd. If the herd extends over w strip widths, the total herd count is then weighted by a factor of w^{-1} in the analysis. This also enables the distribution of herd size to be estimated. The theory for this and other similar procedures, which are not specific to aerial sampling, is given in Jolly (1979).

Quadrat or block

The only distinction between a quadrat and a block is that a quadrat usually refers to a square or rectangular area and a block, according to the definition of Norton-Griffiths (1978), to an irregularly shaped area defined by features on the ground. For present convenience, the term quadrat will be used to include blocks. In most situations, the area of each quadrat must be known, at least approximately. Pioneers of aerial sampling such as Siniff and Skoog (1964) tended to use quadrats, probably following the general requirement that a sampling unit must be an exactly defined portion of the population (as indeed it must). They also seemed reluctant to have sampling units of unequal size. Quadrats are still favoured by some surveyors, as evidenced by Cook and Martin (1974) and Floyd et al (1979).

Clearly, searching a large quadrat from the air presents difficulties in regard to areas included twice from adjacent overflights or missed completely. There seems to be no convincing description of how observations from quadrats should be recorded so as to avoid these problems. To say that a 'systematic search' was made is merely to invite the original question: 'How should an aerial survey be conducted to provide quantitative information?' Given time, one might think of a satisfactory method of 'systematically searching' a haystack, but would hesitate to assess the chances of finding the proverbial needle.

Laws et al (1975) argue in favour of quadrats and list five advantages compared with strip sampling. Unfortunately, they have not taken account of the now well-established methodology of strip sampling, which has led Caughley (1977b) to produce appropriate counter-arguments. In agreeing with Caughley as to the higher efficiency of strip sampling, a further contributory factor can be added. Since a long, narrow strip covers a greater range of habitat or animal groups than does the more compact quadrat, the sampling error for strip sampling will be less than that for quadrats for the same observing effort expended over the same total sample area. This effect of shape of sampling unit is discussed by Norton-Griffiths (1978). A further improvement in efficiency can be achieved by choosing the direction of strips parallel to the direction of maximum change in animal density. One

interesting point made by Laws et al (1975) is the claim that the repeated circling of aircraft over a quadrat makes cryptic animals reveal themselves. Therefore, it would be a mistake to maintain that strips are necessarily superior under all circumstances.

Line intercept

The use of a straight line, whose length intercepting a particular category of land use is recorded, is a standard sampling method for estimating areas. The percentage of land in each category is taken as proportional to the length of line intercepting land in that category. The technique is referred to, for example, in Yates (1960) as line sampling and in Jolly (1979). A fixed point, say on the inner marker, is used as the imaginary line whose length can be measured by stop-watch or from distinguishable points on a map. Watson and his team have incorporated this procedure as part of their observational routine.

Line transect

The term 'line transect' is customarily taken to mean a straight line from which the observer views to either side and measures the distance to the animal (or other object) when sighted, either from himself or perpendicularly from the line. The assumptions made are that animals on the line are always seen but that the probability of sighting decreases with distance from the line or observer according to some law. The method has been used mainly by observers walking through dense vegetation and is not established as a commonly applied aerial technique. Eberhardt (1978) and Gates (1979) are useful guides to the theory, while Anderson et al (1979) provide a practical account of the method. The principle is equivalent to calculating a bias factor by which to multiply the numbers observed to produce a population estimate.

Leatherwood et al (1978) have used line transect methods from aircraft to estimate numbers of bottlenosed dolphin herds. They found difficulty in fitting a

theoretical curve to represent density of herds as a function of distance from the line because the observed density was consistently greatest some distance from the line instead of on it as expected. They could have tried fitting an empirical curve as explained by Burnham and Anderson (1976) or Gates (1979). However, without further understanding of why the sightability curve does not reach its maximum on the line, the authors are justified in reserving judgement on the method. They also used quadrats (3.2 km x 3.2 km) and strip sampling for comparison, concluding that, of the three methods, quadrats were the least satisfactory because of the difficulty of locating and covering them in four to six parallel passes without missing or overlapping. Clearly, a featureless ocean must be especially unfavourable for quadrats.

In general, the assumption that everything on the line is seen makes the line transect of doubtful applicability for aerial survey. Since this assumption can hold only for the larger species in open conditions, correction factors for bias are still necessary in most situations. Thus, the only argument in favour of this method would be if sightings outside the strip of uniformly good visibility can contribute enough information to offset diversion of the observer's attention from the strip. Since recognizing and counting an object must surely take longer as distance from the strip increases - especially in dense cover - the price paid for the additional information seems too high. Or, to put it another way, if it could be shown that, for a particular width of strip, line transect methods could improve efficiency (that is, lower sampling error for given cost), then might this not suggest that the strip is too narrow and that strip sampling from a greater height or with a wider positioning of markers would give still greater efficiency?

SAMPLE SELECTION

The literature on aerial survey shows some degree of consensus that the stratified random sample is generally useful, irrespective of type of sampling unit. Stratification is associated with major differences in population, and, in spite of words of caution on the part of some authors, there seems no reason in practice

why stratification should not be carried out either after or during sample selection if no prior information is available on density variations. Jolly and Watson (1979) suggest a sampling intensity proportional to the square root of density in a stratum, that is, a number of sampling units proportional to the product of stratum size and the square root of density. However, such findings depend on the distribution of the population, so that experience may be better than rigid rules and some departure from the optimum will not greatly affect the final sampling error. The theory of optimum allocation in stratified sampling is given in Cochran (1977).

Since sampling units usually vary in size, either method (2) or method (3) as described in Jolly (1969a) should be used. Jolly and Watson (1979) discuss briefly the relative merits of method (2), the ratio method, and method (3), sampling with probability proportional to the size of sampling unit, with respect to strip sampling; the same remarks apply to quadrats. However, for small sampling fractions, the difference in favour of one method or the other is likely to be undetectable: only with large sampling fractions (say over 15%) will the ratio method begin to show the advantage of sampling without replacement.

One minor point not mentioned in the literature is that when sampling is without replacement, the formula for estimation of variance strictly requires the addition of a small term. The argument is that observations from a sample strip are not exactly repeatable for two reasons, even if the aircraft could be flown along exactly the same flight line with the animals in exactly the same positions. One reason is that variation in the width of strip actually seen due to random movements of the observer's head, rolling of the aircraft and similar factors leads to non-repeatability of what the observer includes as being on the strip. The second reason is that, in circumstances when an adjustment for bias is necessary because of animals being missed, the same animals would not necessarily be missed in a repeat run. Normally, therefore, the sampling should be regarded as two-stage, in which one second-stage unit, corresponding to one of a virtual infinity of estimates, is made on each transect. For sampling with replacement, the variance is validly estimated from the same formula as in one-stage sampling, but when sampling is without replacement a further small term should be added. In most situations, the

additional term is probably negligible, as evidenced in part by the Jolly and Watson (1979) reference to the smallness of the effect of random variation in strip width seen. Cochran (1977) gives variance formulae for two-stage sampling, but estimation of the additional component is not a straightforward procedure in the present context and would require some investigation.

Complete counts are still occasionally found useful, especially for elephant. Eltringham (1977) made complete counts of elephant up to 4 times a year over the period 1968-72. Ross et al (1976), who used both complete and sample counts of elephant (among other species) between 1967 and 1972, found that a 25% sample gave sampling errors in excess of 30%, which was unacceptably high. Likewise for buffalo, Kenyi (1978) made a complete count of herds from 150 m, covering the entire area of the Rwenzori National Park in 2-km-wide strips.

A NOTE ON UNSTRATIFIED SYSTEMATIC VS STRATIFIED RANDOM SAMPLING

A review of sampling methodology would not be complete without referring to the perpetually contentious subject of unstratified systematic vs stratified random sampling.

The theory behind stratified random sampling is simple and fully valid in every respect regardless of animal distribution. The user has the option of adopting any reasonable stratification policy that will help to reduce sampling error. Strata, therefore, may be based on permanent features associated with differences in land use or on more temporary aspects such as seasonal concentrations of animals. Within strata, transects are selected at random at right angles to a suitably chosen axis. Data are recorded along the transects and can be related to positions along the transects if desired.

The main argument for stratified random sampling is that it is fully valid, giving unbiased estimates of population parameters and their sampling errors. The use of strata related to permanent features provides a rational basis for repeated monitoring and gives information on the distribution of animals, assuming that distribution is related primarily to permanent land characteristics.

The theory behind systematic sampling is complex unless animals, as individuals or as herds, are distributed at random. Transects are demarcated at regular intervals, each extending continuously across the survey area, with observations made along the transects in such a way that they can be grouped as desired for sections of the transect.

The main argument in favour of unstratified systematic sampling is that it gives a more precise (not necessarily more accurate) estimate of population size and a better indication of animal distribution over an area. Stratification can be carried out subsequently, if required, according to the distribution of animals. Also, repeated monitoring of the same transects leads to efficient estimation of changes.

Bearing in mind that in random sampling data can be related to positions along a transect exactly as in systematic sampling, the two sampling designs are capable of achieving closely similar ends in slightly different ways. In stratified random sampling, a comparison of transects within a stratum enables distributions to be examined over the entire area as in unstratified systematic sampling. Having regard to the large variation among individual transects or parts thereof, any effect on precision of regular, as opposed to random, positioning of transects will usually be very small. Thus, for example, restratification for a particular parameter after completion of a survey can be carried out with either method. The problems of obtaining an approximately correct sampling error from a systematic sample are evident from Pennycuik et al (1977).

In conclusion, some of the alleged advantages and disadvantages of the two methods are imaginary rather than real. The full validity of stratified random sampling is a factual advantage. In particular, it eliminates disputes over published work following the suspected failure of a systematic sample to allow for the special characteristics of a particular animal distribution. In a random sample any peculiarities of distribution are fully taken into account by the confidence limits.

With regard to spatial patterns or relationships with other observations, the random sample will always produce valid results. The systematic sample, on the other hand, while it may be more sensitive in detecting one particular pattern, may completely miss another.

Whether they are sampled systematically or at random, the most effective monitoring units for measuring changes in animal densities are based on some relatively permanent aspect of animal distribution. In other words, such units should be as free as possible from ephemeral movements of animals across their boundaries since, otherwise, detection of changes in density between one survey and the next is more difficult.

SOME THOUGHTS ON SAMPLING DESIGN

G E J Smith*

Biometrics Division
Canadian Wildlife Service

INTRODUCTION

The survey practitioner is always faced with the problem of survey design. There are numerous sampling designs and methods from which to choose and each has its merits. The choice is influenced by many factors, such as the objectives of the survey, the properties of the population to be sampled, the number and type of quantities to be measured, the auxiliary information available, and the limitations of funds, equipment and manpower.

This discussion will be limited to two aspects of sampling which have been of particular interest in low-level aerial surveys - stratification and systematic vs random sampling. These two concepts lead to four basic sampling strategies:

- random sampling without stratification
- systematic sampling without stratification
- stratified random sampling
- stratified systematic sampling.

The ensuing discussion will attempt to outline some of the advantages and disadvantages of each method. These issues will not be covered completely, since many books have been written on sampling. However, some thoughts will be provided for those involved in survey design, implementation, analysis and interpretation.

* The author wishes to thank G Butler for her valuable suggestions based on an earlier draft of this paper.

DEFINITION OF TERMS

Before proceeding further, several concepts should be clarified which are often confused by practitioners. For simplicity, reference will be made, when appropriate, to a specific hypothetical example - the estimation of the elephant population of Tsavo National Park on 1 November 1979. Five concepts used in this discussion are defined as follows:

1. **Parameter:** any quantity in which there is interest, for example, the total elephant population of Tsavo on the date specified.
2. **True parameter value:** the true value of the parameter independent of any survey, for example, the actual number of elephants in Tsavo Park on the given date.
3. **Estimate or estimated parameter value:** this refers to a number based on the collection of data, such as from a survey. If the survey is carefully done, the estimate will be an approximation of the true parameter value. How good the approximation is will depend on the survey design, the sample size and the mathematical formula used to calculate the estimate.
4. **True precision (variance, standard error) of an estimate:** suppose, after a survey is designed and the sample size n decided upon, the survey could be repeated many times under exactly the same conditions, each time selecting a different sample until all possible samples of size n were selected. If the estimated parameter value were calculated for each sample, then the average amount by which all these estimates differed from their average value would be the true precision of the estimate. The true variance and true standard error are measures of the true precision and could be calculated using standard formulae if the results were known from all possible samples.
5. **Estimated precision (variance, standard error) of an estimate:** in a real survey situation, data are not collected from all possible samples of size n ,

but only from one. Hence, the true precision (true variance, true standard error) of the estimate is not known. However, it is approximated from the data obtained, using appropriate formulae. Thus, when the standard error of an estimate is calculated from survey results, it is not the true standard error but an estimate of it, i.e. the estimated standard error.

STRATIFICATION

Stratification is the process of dividing the target population (or in the context of the example, the Tsavo elephants) into subpopulations or strata. The reasons for stratifying fall into two broad categories, as discussed below.

Methodological factors

Populations are often stratified to improve the precision of an estimate. This is accomplished by delineating strata so that the area within each is as homogeneous as possible, but differences among strata are as large as possible. For example in the case of the Tsavo elephant population, it might be possible, prior to a survey, to subdivide Tsavo National Park into one stratum of generally high elephant density, one of medium density, and one of low density. This might be accomplished by using habitat type, annual rainfall, or some other criterion as a guide. There would then be three somewhat uniform strata, each widely differing from the others.

The extent of homogeneity within each stratum with respect to the parameter being measured determines the potential effectiveness of the stratification (i.e. the increase in precision per unit sampled). For a survey in which a single parameter is being measured, suitable strata can probably be found. However, several parameters may be of interest, some of which may not be related, such as elephant, zebra and cattle populations. In these cases, one effective stratification for estimating all parameters will be difficult to find because a set of strata which is

appropriate for one parameter may not be for another.

After stratification, the sample size within each stratum is determined. This process is called sample allocation. Often samples of the same size are chosen within each stratum, but if additional information is available, the precision of any estimate can be further increased by using an optimum sample allocation (Cochran, 1977). However, a good allocation of sampling intensity for estimating one parameter may be very poor for estimating another, and hence sample allocation of equal intensity may be appropriate in a survey in which many parameters are being measured.

An unequal sample allocation may decrease the precision of any additional estimates made other than the one for which the allocation was specifically intended. When there are several parameters of interest, their relative importance must be considered, as well as the additional effort required to plan a stratified design. There may be one important parameter for which precise estimation is required, even if this means decreasing the precision of the estimates of other parameters.

Management and operational factors

In many instances information is required for particular geographic subdivisions, such as states or management areas. If a certain precision is required for each subdivision, regardless of its size, then a sufficient sample size must be obtained within each. This will require different sampling intensities (sample allocation) within each subdivision which can only be obtained through stratification. In this case, the principal objective is to obtain estimates of a required precision for each stratum, at the possible expense of some loss of precision at the aggregate level.

SYSTEMATIC VS RANDOM SAMPLING

So as not to confuse the issue of systematic vs random sampling with strati-

fication, it will be discussed in the context of an unstratified population. The discussion will also apply equally well to strata within a stratified sampling scheme.

In making preparations for a survey, the area of interest is divided, at least conceptually, into sampling units. In a transect survey, the units are long narrow parallel rectangles of equal width. An example is given in Figure 1. For a random sample, transects are chosen by some chance or random procedure. In a systematic sample, transects are often chosen at regular intervals, say every k^{th} transect, after an initial transect has been chosen at random from among the first k .

Figure 1. All possible transect sampling units

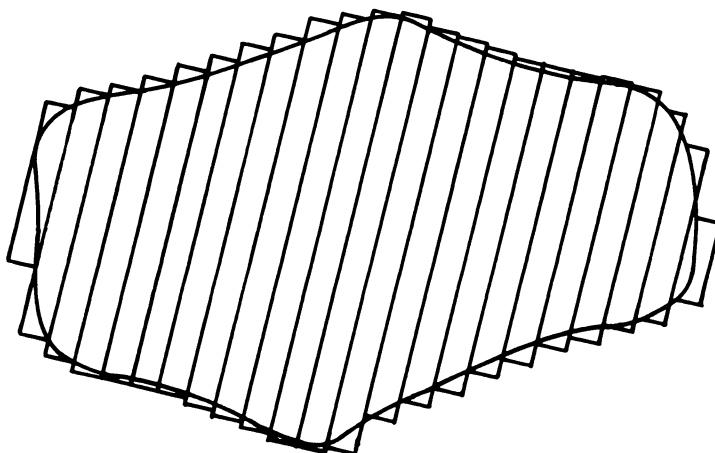

If an area is relatively homogeneous with respect to the variable being measured, i. e. the variation is of a purely random nature, then there is little practical difference between the two methods. If there is variation of habitat, altitude or other features which creates, in addition to the random effect, a trend or slow variation across the region of interest, then a systematic sample generally produces more precise estimates. There is, however, the danger of periodic variation which corresponds to the distance between adjacent sampling units. In

this case, systematic sampling is less precise than random sampling. The survey designer must assess all these possibilities. If, for instance, a systematic approach is selected, care should be used in designing the survey to avoid periodic variation.

An advantage of random sampling is the availability of relatively unbiased estimates of the true standard error, regardless of the underlying distribution of the data. For systematic sampling, additional assumptions are necessary before such estimates can be obtained. Cochran (1977) discusses several methods when the sampling units are of equal size and also describes the conditions under which these methods are valid. Often these estimated standard errors are biased upwards so that they tend to be conservative or to overestimate the true standard error.

To clarify this idea, a hypothetical example may be considered where there is a trend in elephant density across a region such that a systematic sample will produce a more precise estimate. If both a systematic and a random sample of the same size are chosen, a situation might arise as shown in Table 1. The values given in the table are purely hypothetical, but the relationships between them are typical.

Table 1. Standard error (SE) expressed as % of true population: a hypothetical case

	True SE	Estimated SE
Random sampling	10%	about 10%
Systematic sampling	5%	about 8%

The systematic procedure gives an estimate of the population whose true standard error is half that of an estimate from a random sample. Only estimated

standard errors can be obtained, however. In the case of random sampling, the estimated standard error is about right, whereas in the case of systematic sampling the true standard error tends to be less than its estimate. Thus, in a situation where systematic sampling produces more precise estimates than random sampling, systematic sampling may be used to obtain a more precise estimate together with a conservative estimate of its precision, or random sampling may be used to obtain a less precise estimate along with a good estimate of its precision.

CONCLUSIONS

Some basic ideas in the choice of sampling design have been discussed with respect to stratification and the choice between systematic and random sampling. The most important point throughout is that no design can claim to be superior in all, or even most, circumstances. Each project must be assessed and, if a survey is required, this must be designed to suit the project's specific characteristics and objectives. To do anything less is to invite disaster, and disasters occur often enough when they are uninvited.

UNSTRATIFIED SYSTEMATIC SAMPLING:
RATIONALE AND METHOD

M Norton-Griffiths
Ecosystems Ltd

THE BASIS FOR SYSTEMATIC SAMPLING

Unstratified systematic sampling is now widely used throughout the world for collecting baseline data on animal numbers and distributions and for monitoring through time the changes in patterns of distribution and their relationships to biotic and abiotic features of the environment. In this paper, the method will be discussed and its relative strengths and weaknesses compared with those of stratified random sampling.

Throughout the biological and physical sciences, more data are probably collected by systematic sampling than by any other method. For example, hydrological, oceanographic, geophysical and geological data are largely derived from samples taken systematically through time and space. Also in the collection of meteorological data, ground networks are designed to cover areas as evenly as possible, spreading sampling effort systematically through space. At each ground station, data are then collected systematically over time - for instance every day or every month.

The many applications of systematic sampling share one common theme: the analysis of pattern. In general, the most appropriate method of describing and analysing a pattern - be it an X-ray source, a rainfall intensity, an electronic signal, the structure of a cell or the movements of wildebeest across the Serengeti - is from data collected systematically through space and through time.

STRATIFICATION

In most applications of systematic sampling to ecological research, the sampling has been unstratified. There is a reason for this: stratification leads to a loss of information. For example, if a rangeland area is stratified into vegetation types or land systems, then information about events occurring within each vegetation type or land system may be lost or become much less accessible.

An example of the advantage of unstratified systematic sampling is given by Maddock's (1979) analysis of wildebeest movements within the Serengeti ecosystem. The data are presented in two ways - on a grid of 10 x 10 km squares and, derived from the grid squares, on the basis of land systems. The grid square data could be re-stratified in a number of different ways. A vegetation map could be superimposed, or a soil map, or a grassland-productivity map, or a rainfall map, or a distance-from-permanent-water map, or a tourist-viewing-area map. In this way, many different associations can be studied. However, had the data been collected by stratified sampling - for example on the basis of land systems - it would no longer be feasible to re-stratify except by lumping the strata into larger and larger units.

The flexibility offered by the unstratified approach can be particularly useful for examining the factors which appear to influence the distributions of a range of animal species. Some species may be chiefly influenced by static features of the environment such as vegetation type, while the distribution of other species may be governed by ephemeral features such as grass condition and surface water. Stratified sampling would be inappropriate for this situation because the strata of static and ephemeral features would be unlikely to match each other, making it difficult to assess the relative influence of both types of features.

Stratified random sampling and unstratified systematic sampling represent two very different approaches. The former best answers the question: How many animals are there? It does this by absorbing as much of the inherent variation in spatial distribution as possible into homogeneous strata. As a result it reduces

sampling error and gives an answer of maximum precision for any given sampling effort. By contrast, unstratified systematic sampling collects information about spatial and temporal variations in density, in order to use these variations as a tool for explaining the relationships between animals and their environment. It is best for answering such questions as: What are the major determinants of animal distribution in the area? Which animals are most affected by these determinants? How does the influence of these determinants vary through space and time? These questions can be answered by the analysis of variance (see Sokal and Rohlf, 1969).

ANALYSIS OF VARIANCE

The analysis of variance can be illustrated by reference to the results from three aerial surveys recently carried out by Ecosystems Ltd, a consulting firm which specializes in ecological survey. These surveys were conducted in the area likely to be affected by a proposed hydroelectric dam in Selous Game Reserve, Tanzania. The objectives of the surveys were to obtain baseline data on the numbers and seasonal distribution patterns of wildlife in the area and to analyse their existing relationships to the areas most likely to be affected by the dam. With this information, a preliminary assessment could be made of the probable impact of the dam on the animals in the reserve.

Unstratified, systematic sampling was used, with the same flight lines (transects) surveyed during the wet season, the early dry season and the late dry season. The sampling intensity was around 10%. The raw data comprised the numbers of 12 different wildlife species observed along successive, 1-minute segments of each flight line, repeated during the three seasons. These data were stratified in 25 different ways, but for brevity only five of the stratifications will be considered here - the major vegetation zones, the major land systems, the distance from permanent water, the greenness of grass and the abundance of surface water.

Three questions are of particular interest: How important are these strati-

fications in determining the distribution of all animals in the impact area? How does this vary on a seasonal basis? Which animal species are most affected on a seasonal basis? These questions are answered by the analysis of variance against the null hypothesis that all animals are distributed randomly with respect to all of the stratifications.

The first question is answered by a two-way analysis of variance of each stratification against all animals. Taking vegetation zones as an example, the data on which the analysis is based are the densities along the segments of flight lines passing through each vegetation stratum. The individual 1-minute intervals and grid squares are not used. This two-way analysis of variance breaks down the variation into four sources - variance resulting from different species within different strata, variance resulting from different species, variance resulting from different strata and variance resulting from the interaction between the individual species and the strata. What is left over is the error variance. Thus the components of the overall variation can be analysed separately.

The variance component for the strata gives the proportion of the total variation in animal distribution that can be explained by the stratification. Table 1 shows the variance components for the five stratifications. It is clear from this table that the importance of the stratifications as determinants of animal distribution varies on a seasonal basis. In the wet season, the vegetation zones and the land systems are the major determinants of animal distribution: in other words animals are responding to characteristics of the vegetation at this time of the year. However, in the dry season the major determinants of animal distribution are distance from permanent water and the greenness of the grass. Vegetation type selection has become relatively unimportant. Thus, even at this early stage in the analysis, a clear idea has been formulated of how the animals are responding to the environment within the impact area and how this response varies on a seasonal basis.

To answer the third question, the sums of squares for each species are broken down for each stratification, with reference always to the null hypothesis.

Table 1. Seasonal variance components for five stratifications in Selous Game Reserve, Tanzania

	Wet Season	Early Dry Season	Late Dry Season
Major vegetation zones	17.2	11.3	4.3
Major land systems	11.2	6.7	1.4
Distance from permanent water	0.6	4.1	11.7
Greenness of grass	3.6	2.9	7.3
Abundance of surface water	0.9	6.8	1.3

Table 2 shows this stage of the analysis for impala, hippopotamus and zebra. The distributions of impala are determined in the wet season primarily by the major land systems and the vegetation zones, while in the dry season distance from permanent water is a strong influence. Not surprisingly, the distribution of hippopotamus is mainly determined by the distance from permanent water. For zebra, the vegetation zones are the most important determinants of distribution in the wet season, while the greenness of grass is most important in the dry season.

It is possible to analyse the information further, that is, by inspecting individual densities within each stratum of a given stratification. Questions can be asked, such as: Which of the vegetation types are being selected? Which are being avoided? What is the distribution of a wildlife species with respect to permanent water sources? It is also possible to investigate two, or even three, levels of stratification in more detail. In the study of the Selous Game Reserve, one land system was stratified on the basis of vegetation types, while another was stratified on the basis of distance from permanent water. Similarly, for a survey in Tanzania's Tabora Region, the relationship between livestock densities and hut densities was investigated in different agricultural areas. The region was first stratified on the basis of agricultural areas and then on the basis of hut densities, and within these strata the cattle densities were analysed.

Table 2. Seasonal variance component for five stratifications and three wildlife species in Selous Game Reserve, Tanzania

	Wet Season	Early Dry Season	Late Dry Season
Impala			
vegetation	36	15	8
land systems	27	18	15
permanent water	5	4	13
grass greenness	4	4	1
surface water	2	8	0
Hippopotamus			
vegetation	13	26	25
land systems	19	20	12
permanent water	18	34	67
grass greenness	1	3	11
surface water	5	5	2
Zebra			
vegetation	18	22	5
land systems	15	4	0
permanent water	0	3	0
grass greenness	2	2	12
surface water	2	6	1

CONCLUSIONS

Unstratified systematic sampling gives considerable flexibility to methods of data analysis because no information on the variation in distribution is lost through stratification. Stratified random sampling is most useful for census purposes. The role of both techniques may be illustrated, taking the Serengeti

migratory wildebeest as an example. Three questions would need to be answered in order to conduct a wildebeest census, namely: Where are the wildebeest? Where are the areas of high and low wildebeest density? How many wildebeest are there?

The first two questions were answered by systematic sampling with the objective of mapping the density distribution of animals. A random sample was then taken within each density stratum in order to answer the third question (Norton-Griffiths, 1973).

Finally, the question of grid squares should be mentioned. Unstratified systematic sampling is often, but not always, carried out within a framework of grid cells. Grid cells provide a useful means of presenting distribution data, but that is all. They are not sampling units nor are they used in analysis; they are used purely as a convenient way of displaying information visually.

5. BIAS

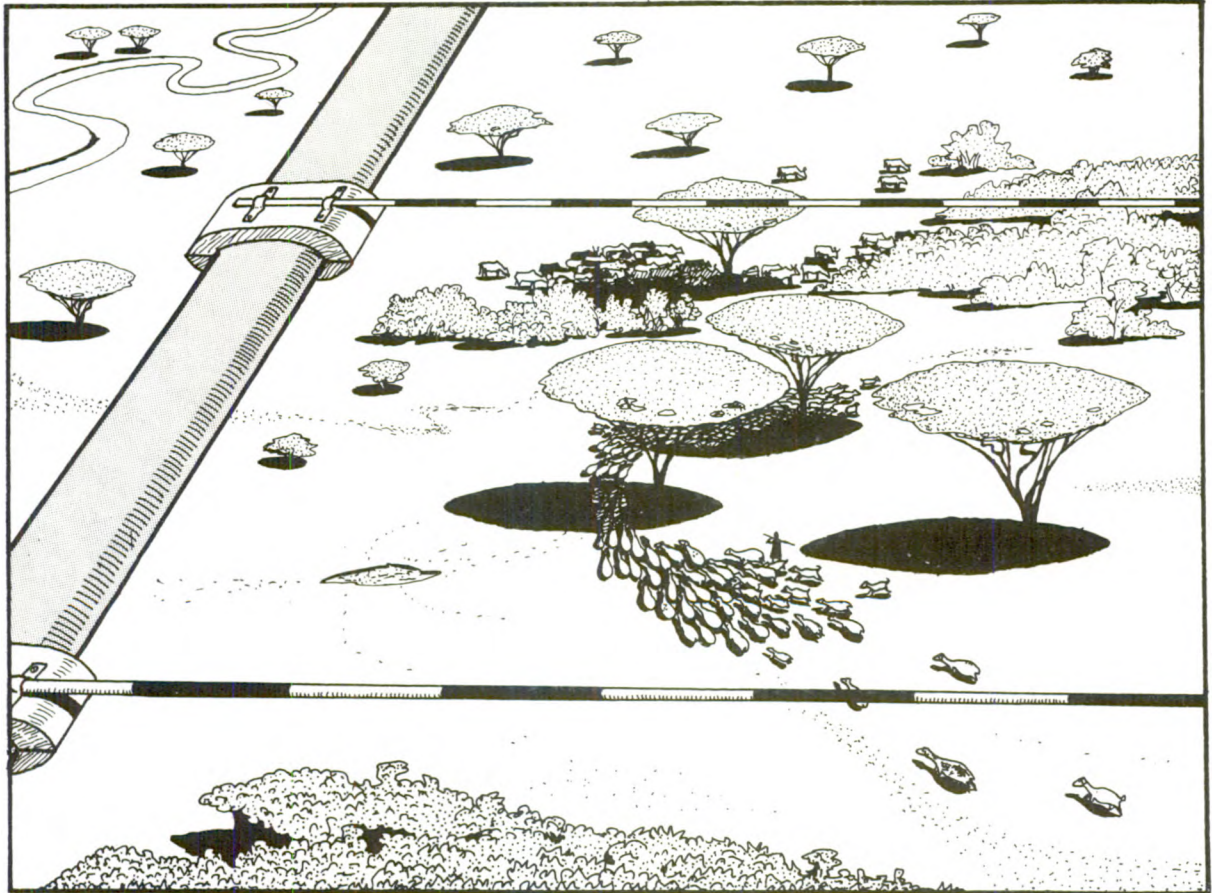

Four major sources of bias in aerial survey were discussed during the workshop. Bias may originate with the investigator in defining the objectives of a survey or in analysing or interpreting the results. Bias may also result from stratification and the selection of sampling units. Bias may be due to the operation of the aircraft: for example, time-of-day effects, crew fatigue or incorrect flying - especially with respect to height control, crabbing into wind and deviating from the planned flight path. Finally, bias may occur in spotting and counting animals, involving misidentification, missing individuals, missing herds and miscounting those animals seen.

In discussing bias which originates with the investigator, it was concluded that scientific impartiality has to be assumed. It was also agreed that bias related to stratification and the selection of sampling units should not occur, provided that standard procedures are followed.

Studies on bias due to the operation of the aircraft have sometimes given conflicting results. For example, time-of-day effects, arising from changes in animal behaviour during the day, do not seem to be important when survey results are analysed. Similarly, while some studies have demonstrated a small effect on survey results due to observer fatigue or boredom, other studies have shown no such effects (Norton-Griffiths, 1976).

Bias was discussed which arises from crabbing into wind, deviating off the

planned flight path or flying low over hill crests and high over valley bottoms. The lack of satisfactory investigations into these sources of bias was agreed. However, it was felt that these sources of bias, while obviously present, are unlikely to be large and some are easily corrected.

The 'decision-line' method of correcting bias due to aircraft crabbing was discussed. This technique involves the in-flight adjustment of a line which runs from a point outboard on the strut to the fuselage so that the line lies at right angles to the flight path. The line then represents a true cross-section of the transect, as opposed to the wing axis which is askew when the aircraft is crabbed.

It was agreed that spotting and counting problems represent the single most important source of bias in aerial census. Numerous studies have demonstrated this type of bias. Spotting and counting bias is influenced by the density of the vegetation, by the size and colouring of the animals, by their herding behaviour, by their reaction to an overflying aircraft, and by the height, speed and strip width selected for the census. Height, strip width and speed are probably the three most important influences on this form of bias, although the influence of vegetation cover and camouflage have been less systematically studied. Spotting and counting bias may also be greatly influenced by the number of species and other variables to be counted: bias in a complicated census is likely to be higher than in a census for one, or just a few variables, though a higher workload, up to a point, may help maintain observer concentration. While economic considerations often lead to multi-species censuses, the special problems of bias in this type of survey have yet to be examined in any detail. Newsome et al, in their contribution to this report, use multiple regression to quantify the effect of mean group size and forage conditions on the percentage of cattle seen.

There was also considerable discussion on the relative merits of aerial survey work carried out by a single pilot also acting as observer. Those practitioners who work in this way estimate that they are able to carry out observations almost continuously while piloting their aircraft. At flying speeds below 130 kph, the risk of collision with vultures is sufficiently low to require no particular vigilance.

Clearly, a pilot acting as observer can conduct aerial surveys effectively, but the considerable skill and experience required are not readily transferable.

CORRECTING BIAS

While it is impossible to eliminate bias from an aerial census, its effect can be minimized at the design stage and then partially corrected after the census. Opinion at the workshop was divided as to how much bias remained after correction. Considerable discussion centred on the use of correction factors - the factors by which an estimate obtained by an observer is multiplied in order to bring it closer to the true number of the population. Different correction factors are required for each animal species to be counted and for each type of vegetation cover. Different views were expressed at the workshop on whether general correction factors could be determined for different animal/vegetation combinations or whether correction factors had to be calculated for each survey. The approach suggested by Caughley (1974) was discussed in some detail. It was felt that, although this approach indicated the relative importance of the various factors influencing spotting and counting bias, it was not adequate for calculating correction factors due to the large standard errors associated with the regression technique used.

Photographic correction factors are widely employed, and photography, as an aid to counting, is used almost universally in aerial census. However, a photograph in itself does not remove all bias. Animals remain hidden by vegetation or within large herds. Also, photographic correction factors apply only to the animal groups detected. They do not correct for animal groups or herds missed altogether. Observers are probably unlikely to miss large herds, especially of domestic stock, but are more likely to miss smaller herds and individual animals, particularly in multi-species censuses.

A method was described whereby the number of 'missed animals' could be calculated from the probability of sighting a single individual, but concern was expressed over ways of testing the reliability of such a method. The merits of

counting blocks of land containing known numbers of animals were also discussed as a method of obtaining a single correction factor, covering both animal groups detected and those missed. Another method, when the true numbers are unknown, is to observe a large number of animal groups: each is first counted, and perhaps photographed, as in a survey, then immediately recounted in an intensive search from very low altitude to obtain a 'true density'. In both methods, the two counts are used to calculate a correction factor which is then applied to subsequent aerial censuses of the species under similar conditions.

In general, all workshop participants saw the need for more research into methods of correcting spotting and counting bias. It was felt that organizations such as UNEP, ILCA and KREMU could be approached to fund, carry out or coordinate research for improving survey and monitoring methodologies.

METHODS OF BIAS CORRECTION

G M Jolly

Agricultural Research Council Unit of Statistics

University of Edinburgh

Four types of correction for bias will be discussed. These all relate to bias from spotting and counting, whether directly or from photographs, when animals may be concealed in vegetation and therefore missed or may be counted twice by the observer. Watson and Tippett (1975) examine some sources of bias separately, but here the focus is on the aggregate spotting and counting bias from all sources. This discussion refers largely to animal counts. However, the possibility of bias should also be recognized, for example, in estimating areas of a crop or counting static features such as camps, wells or individual dwellings.

CORRECTION FACTORS

The essential feature in estimating a correction factor is to find some accurate method of counting for which it can be assumed that virtually no error exists. This is not achieved merely by comparing two methods of counting or surveying and choosing the one that gives the higher count, nor by carrying out surveys by the same method and comparing the results. The literature contains several useful discussions on how to improve the accuracy of a count, including Caughley (1974, 1977a) and Norton-Griffiths (1976, 1978). Watson and Tippett (1975) present a definitive procedure for estimating overall correction factors for a range of species. The associated theory is given in that report and briefly in Jolly and Watson (1979).

According to Watson's procedure for obtaining correction factors for a given species under specific conditions of open, medium or dense cover, data are obtained independently of the survey itself by flying over typical areas and first counting an observed animal group as in the survey. The aircraft is then taken to a very low level and the group is circled until the pilot-observer is satisfied that an accurate count or photograph has been obtained of the entire group. This may entail waiting for the group to move out of vegetation on to open ground. Data are accumulated over a period until the correction factor, calculated as the ratio of the total accurate count to the total survey count for the same groups, has an acceptably small standard error. The sampling error of the unadjusted survey data is then increased according to given formulae: this increase is quite small given sufficient data. Another slight adjustment is made to allow for the fact that a group of one to, say, four or five animals has a good chance of being missed from the normal survey height. A typical correction factor for cattle in medium cover in Sudan's South Kordofan Province is 1.035 with a coefficient of variation of 0.0055. Under more difficult conditions in Sierra Leone, Watson (1979) recognized five categories of cover, giving correction factors for cattle ranging from 1.06 to 1.59.

Other examples of aerial correction factors estimated for particular situations include those of Le Resche and Rausch (1974), who compared sample data with known numbers of moose in 1 mi² enclosures, Sargeant et al (1975) who checked against carefully conducted group counts of red fox families, Leighton et al (1979) who intensively searched sample areas on the ground for the number of breeding aeries of bald eagles, and Floyd et al (1979) who counted radio-tagged deer in quadrats. Norton-Griffiths (1974) also used this type of correction to adjust visual counts by photographic counts on a sub-sample. In each case, corrections are based on the assumption that the actual count of the sub-sample is accurate.

REGRESSION

Caughley et al (1976) have conducted experiments observing kangaroos at

unknown densities and sheep at known densities at different heights, speeds and transect widths, and also similar laboratory experiments with dots on a screen. Multiple regression equations are established to express observed densities of animals, y , as functions of height, speed and transect width and, by extrapolation, estimates of y are obtained corresponding to zero values of the three independent variables. In spite of a few inconsistencies, the authors claim generally good agreement between estimated and true densities.

However, on closer examination, the standard errors of the estimated densities are very high - understandably so since the regressions have been extrapolated well outside the range of observations. For example, in one experiment having a true density of 141 per km², estimates from the regression for two observers were 145 ± 60.8 and 149 ± 58.2 . When applying this regression to adjust estimates from an actual survey, these estimates will already have their own sampling error prior to adjustment, so that the sampling variance of the adjusted estimate is the sum of two (independent) variance components. Many more data would therefore be required to produce acceptable levels of precision. Also, given more data, it is possible that the simple regression fitted will prove to be unsatisfactory; in fact, it would be surprising if further curvature were not found when data closer to the zero values of height, speed and strip width are included.

A possible result is that the technique will tend to approach the simpler Watson-type correction factor when suitably refined by using more data, especially nearer to the zero values of the independent variates. Large quantities of data would be required to examine such models.

DOUBLE SURVEY

Magnusson et al (1978) suggest employing the principle of two surveys by independent observers using either the same or different methods. The objects observed must be capable of identification so that they can subsequently be classified as seen by only one or both observers. The combined estimate in its simplest form

is then

$$N = \frac{(B+S_1) \cdot (B+S_2)}{B}$$

where S_1 and S_2 are seen by the first and second observer respectively, but not by the other, and B is seen by both. The authors apply their method to crocodile nests.

If each object has the same probability of being observed by a given observer, the bias in their separate estimates will be fully corrected. Otherwise, N will still underestimate the true number; this possibility can be seen by considering a situation where certain of the objects are completely concealed.

CORRECTION BASED ON ASSUMED DISTRIBUTIONS

By making some fairly restrictive assumptions on the distribution of animals, Cook and Martin (1974) produce a complex model from which certain parameters, including proportion of animals seen, can be estimated by computer. To test a model which depends on several assumptions not easily verified, it would be necessary to check the authors' estimate by comparison with a known population. Although they apply their method to several sets of real data, they do not attempt any such validation, thus leaving the reader to speculate on the success of the method. This approach may be too dependent on its assumptions to be generally applicable.

MEASURING BIAS IN AERIAL SURVEYS
DUE TO DISPERSION OF ANIMALS

A E Newsome, M L Dudzinski and W A Low*

Commonwealth Scientific, Industrial and Agricultural Research
Organization, Australia

INTRODUCTION

Biases due to methodology in aerial surveys of wild animals have been critically examined recently by Caughley et al (1976). By randomly varying air speeds, heights above the ground and widths of transect, these authors generated a multiple regression whose intercepts on the ordinate provided an estimate of the percentages of wild kangaroos (*Macropus* spp.) and sheep seen and counted. Differences between observers were also examined.

Biased estimates of the density of a species due to its dispersion have apparently not yet been examined systematically. The actual dispersion, i.e. sizes of groups, may be one problem (Müller et al, 1976; Evans, 1979), and habitat usage could also be related (Newsome, 1965). In the present study, possible bias due to dispersion was examined using extensive data on cattle collected by Low, and adjustments to estimates were sought.

METHODS

The numbers and distribution of free-ranging shorthorn cattle in a paddock of 170 km² in central Australia were estimated by aerial survey almost fortnightly

* The authors are grateful to Dr G Caughley for initial discussion of these problems and for his critical comments. Mr W J Müller provided valuable assistance in preparing the data.

from September 1970 to April 1975 (Low, 1972). The total area was surveyed each time, methods being standardized at an air speed of 130 kph, a height of 120 m, and a transect width of 0.4 km per observer on each side of the aircraft. The transects were always flown shortly after dawn using the same observers. On 10 occasions during the study, the cattle were mustered and totally counted. On those occasions, some cattle were culled or added, depending on forage conditions. Numbers also changed due to breeding.

During the study, climatic conditions varied from drought to good rainfall, with forage conditions varying accordingly. The quantity and quality of forage were assessed as part of every survey. Three classes of greenness and four of ground cover were combined to form a forage index as follows:

Forage Index

Quantity (ground cover)	1	1	1.5	2
	2	1	2	3
	3	2	3	4
	4	2.5	3.5	5
		1	2	3
		Quality (greenness)		

This index was designed to increase as pastures deteriorated during droughts and decrease as pastures improved. As environmental conditions changed, the cattle shifted among 11 major habitats in the paddock, ranging from open plains, to dense mulga scrublands (*Acacia aneura*) 10-15 m tall, to hills. The size of each group of cattle seen was noted, as well as their position to an accuracy of one quarter of the total transect width, or 0.2 km.

The data used in this paper were gathered during 12 aerial surveys carried out just before the cattle were mustered, plus 12 extra sets obtained by inter-

polation between successive musters during which numbers of cattle were the same or little changed (see Table 1). The data were analysed by multiple regression, which incorporated the first principal component of habitat usage by cattle. The application of principal components in multiple regression has been discussed by Dudzinski (1975).

RESULTS

The data and some statistics are presented in Tables 1 and 2. The percentages seen between 9 March and 16 August 1971, when cattle numbers were virtually constant, included low and high values of 42.9 and 72.3%. Similarly the range between 15 November and 30 December 1971, when numbers were constant, was 59.0 to 75.5%.

Let the numbers seen on each survey be Y and the numbers at each muster be X . Their relationship (Figure 1) was as follows:

$$Y = -16.6 + 0.679 X \quad (r = 0.821; \quad P < 0.001) \quad (1)$$

The intercept (-16.6) was not significantly different from zero ($P > 0.05$), and the slope indicates that about 68% of the cattle were seen on average in aerial surveys. The percentage seen bore no relationship, however, to the actual numbers. There was a good relationship between the percentage seen and the average size of groups of cattle ($r = 0.73$; $P < 0.001$) (Figure 2). There was also a relationship between average group size and the forage index ($r = 0.415$; $P < 0.01$), though neither of these relationships was linear (Figure 3). There appeared to be a threshold effect with large groups forming when forage conditions were good, i.e., below a forage index of about 2.

The first principal component from the analysis of habitat usage, $Z(1)$, accounted for 34.9% of the variation. The hills and mulga scrub which had an understorey of perennial grasses (corresponding loadings: -0.556 and -0.254) were strongly contrasted with the floodplains and adjacent woodland savanna

Table 1. Cattle seen in aerial surveys and in musters

Survey No.	Muster			Aerial Survey										Forage Index
	Date	No. of cattle	Cattle seen (%)	Mean group size	% in habitats					Mulga/annual grass		Mulga/perennial grass		
					Hills	Foot-hill fans	Flood-plains	Gilgai plains	Open wood-lands	annual grass	perennial grass			
1	6.2.71	690	64.1	8.7	0	10	19	12	14	35	5	2.98		
2	6.2.71	550	65.9	9.3	21	9	19	0	5	37	8	1.86		
3	a	553	42.9	6.1	6	9	19	11	3	28	3	1.86		
4	a	554	56.4	7.4	24	0	2	8	4	31	14	2.12		
5	a	556	63.1	8.2	11	10	19	1	2	20	12	2.86		
6	a	557	70.4	7.7	0	17	14	5	30	16	17	3.32		
7	a	558	50.9	5.6	16	0	9	5	38	22	8	3.60		
8	a	559	64.9	8.4	17	22	6	8	18	22	7	3.93		
9	a	560	71.8	7.9	30	15	4	3	16	12	16	4.13		
10	a	562	57.5	7.5	13	15	17	5	11	20	7	4.13		
11	a	563	72.3	9.9	33	0	18	14	18	15	1	3.74		
12	a	564	63.8	7.5	4	19	14	4	21	22	13	2.48		
13	24.8.71	565	59.1	8.4	17	3	32	20	10	9	1	4.08		
14	4.11.71	624	53.0	7.2	15	8	12	1	39	8	13	4.64		
15	4.11.71	376	59.0	8.9	41	10	3	0	11	14	19	4.64		
16	a	376	66.5	6.4	0	0	56	10	22	13	0	2.08		
17	a	376	75.5	15.0	0	0	50	1	28	21	1	1.82		
18	4.1.72	376	75.3	8.3	0	0	21	14	11	50	0	1.94		
19	16.5.72	439	70.8	14.1	0	48	16	1	22	14	0	1.13		
20	18.10.72	576	57.3	7.9	1	22	7	0	19	48	3	3.52		
21	2.7.73	673	73.4	11.5	1	21	11	1	35	31	0	1.88		
22	4.11.73	726	62.8	9.7	2	16	13	20	18	13	1	1.00		
23	3.5.74	567	89.6	14.5	1	15	20	0	43	14	1	1.00		
24	10.12.74	864	73.4	14.1	1	7	38	5	30	13	0	1.69		
Loadings of First Principal Component					-0.56	-0.08	0.71	0.04	0.33	-0.09	-0.25			

^a Interpolations.

Figure 1. Relationship between cattle numbers recorded from aerial surveys and populations counted on the ground

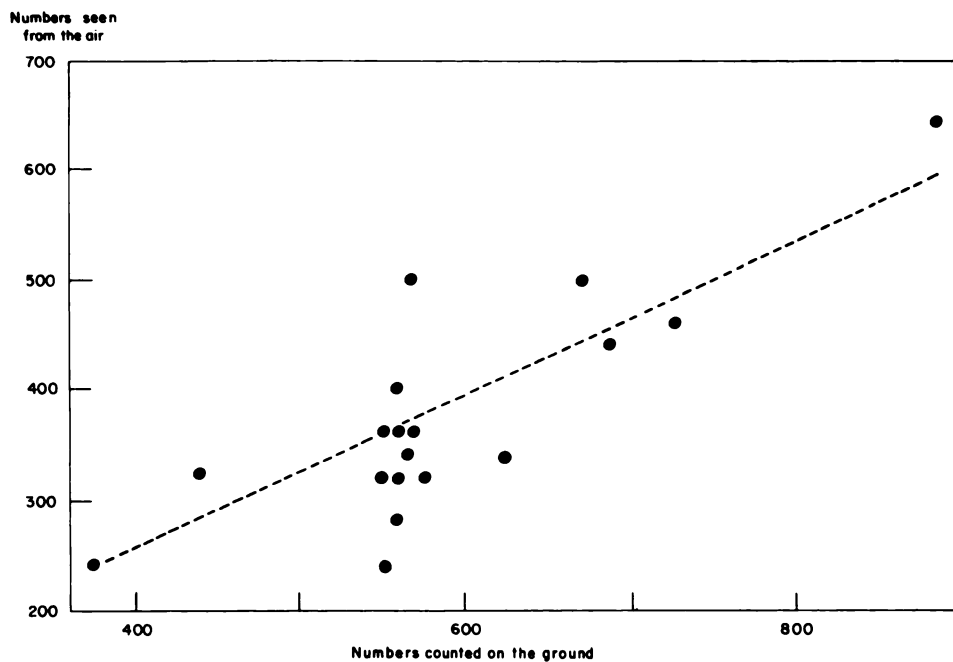

Figure 2. Percentage of cattle populations recorded from aerial surveys compared with mean group size

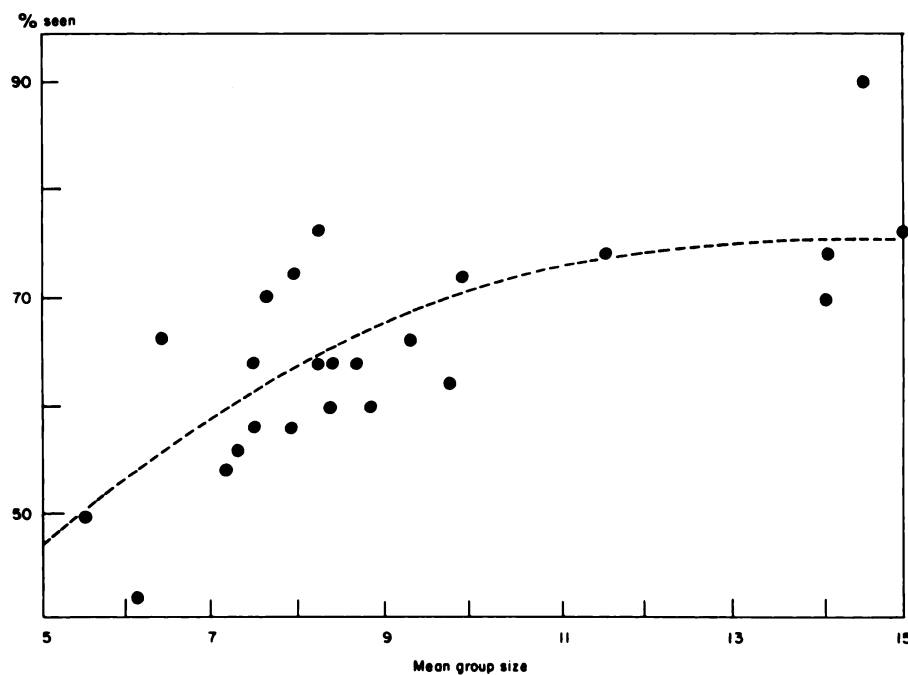

Figure 3. Relationship between average size of cattle groups and forage quantity and greenness

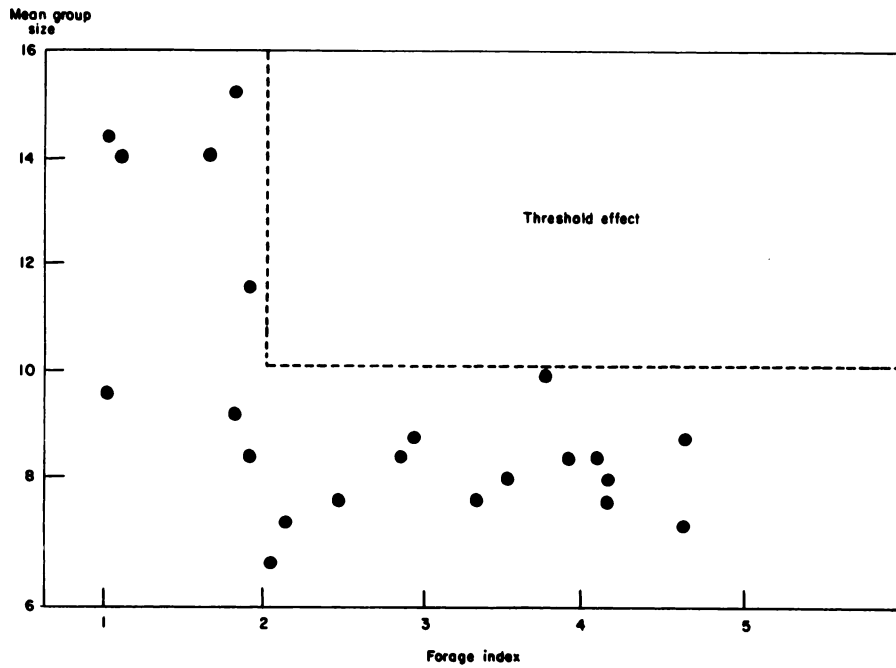
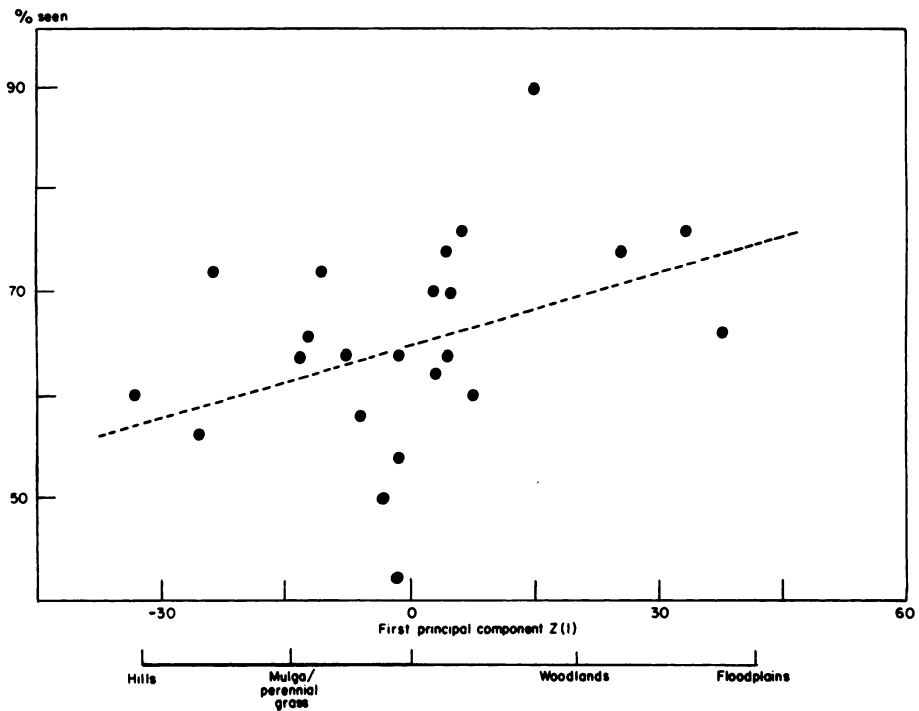

Figure 4. Percentage of cattle populations recorded from aerial surveys according to habitat



(corresponding loadings: 0.709 and 0.326). The former habitats served as drought refuges, while the latter were preferred when forage was good. These relationships can be seen in Figure 4, and the values of $Z(1)$ for each survey are given in Table 2.

These analyses indicate that the percentage of cattle seen in the study (Y) was best related to mean group size (X_1), with a minor contribution from habitat preference as expressed by $Z(1)$, as follows, and as shown in Figure 2.

$$Y = 0.0073 + 0.1119 X_1 - 0.0042 X_1^2 + 0.0014 Z(1) \quad (R^2 = 0.6; P < 0.001) \quad (2)$$

The inter-relationships of variables and their associated correlation coefficients are presented as a flow diagram in Figure 5.

CONCLUSIONS

The results from 12 aerial surveys of free-ranging cattle indicate that the dispersion of cattle significantly influences the accuracy of counts from the air. Group size alone accounted for 53.2% of the variability in percentages seen, increasing to 60% allowing for curvature in the relationship (Figure 2) and the distribution of cattle between habitats (Figure 4). Thus allowance may be necessary for biologically induced counting biases, as well as biases due to methods (Caughley et al, 1976). Depending on species, bias may operate in opposite directions for the same forage conditions. For example, in central Australia, red kangaroos (*M. rufus*) flock during drought whilst cattle disperse into the scrublands and hilly country. After good rains, however, cattle flock on the open plains and red kangaroos scatter into the scrublands (Newsome, 1965; Low et al, in press). It has also been shown that sheep, like cattle, bunch in good seasons and disperse in drought (Arnold and Dudzinski, 1978).

The obvious source of bias in aerial survey would be under-estimation of very large groups, whether of ruminants, marsupials or water birds. In the pre-

Table 2. Statistics and corrections from equation (2)

Survey Number	Scores from First Principal Component on Habitats Z(1)	- Deviations from Total Counts -		
		before correction	after correction	(%)
1	4.1	248	28.2	(4.1)
2	-11.9	188	5.8	(1.1)
3	- 1.6	316	106.5	(19.3)
4	-25.8	243	5.9	(1.1)
5	- 6.8	205	0.5	(0.1)
6	3.6	165	-70.8	(-12.7)
7	- 3.1	274	-13.0	(-2.3)
8	-13.8	196	-17.0	(-3.0)
9	-24.0	158	-117.1	(-20.9)
10	- 5.4	239	25.3	(4.5)
11	- 9.9	156	-28.6	(-5.1)
12	- 1.3	204	-28.4	(-5.0)
13	6.9	231	59.0	(10.4)
14	- 0.9	293	66.1	(10.6)
15	-33.2	154	18.9	(5.0)
16	37.0	126	-37.6	(-10.0)
17	33.0	92	14.6	(3.9)
18	5.3	93	-57.0	(-15.2)
19	4.1	128	26.2	(6.0)
20	- 5.6	246	44.0	(7.6)
21	4.9	179	9.1	(1.4)
22	2.9	270	75.1	(10.3)
23	15.7	59	-95.7	(-16.9)
24	25.5	235	56.4	(6.4)

Figure 5. Interrelationship of variables affecting percentage of cattle populations recorded from aerial surveys, with correlation coefficients^a

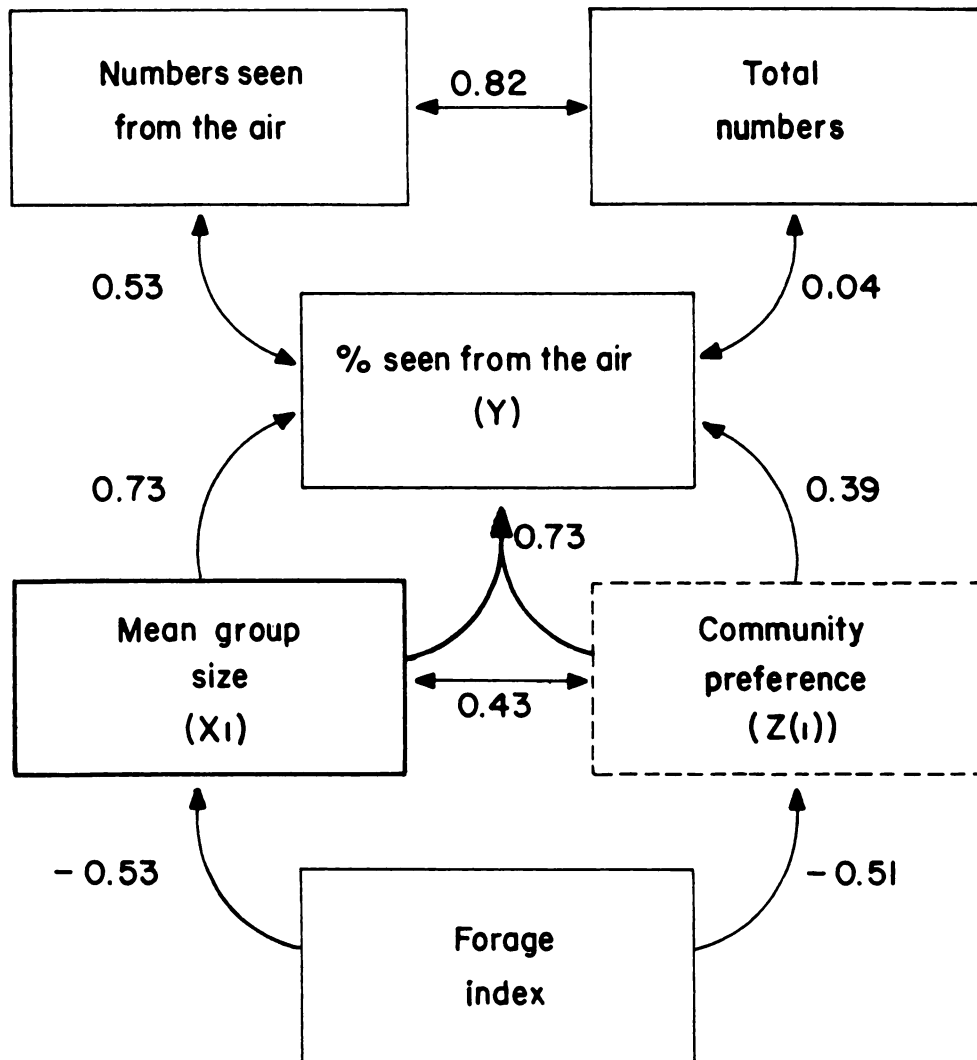

^aNumbers next to arrows are correlation coefficients.

sent study, there were no very large groups. Figure 2 and equation (2) indicate that underestimation remained steady at around 25% for mobs averaging 12 or more. Counting when groups are small might therefore seem an appropriate solution. In this study, however, even greater proportions were missed when groups averaged about five, with errors of about 55% caused by cattle scattering into scrublands and hills where visibility was poor. Because the percentages of cattle seen were known

from the periodic musters and could be predicted basically in terms of group sizes, the errors in counting could be adjusted using equation (2). Original deviations in counts ranged from -57.1 to -10.4% of total numbers (from Table 1), but ranged from -20.9 to +19.3% after adjustment.

This study indicates the need to measure biases due to dispersion, especially in habitats which obscure visibility. Photography may help count large groups, but cannot eliminate error due to dense habitats. To reduce bias, information may be required on the biology of a species or group of species in order to choose propitious times to carry out a survey. To avoid such biases, musters or sample counts on the ground may also be necessary for calibration.

THE STATIC MODEL SAMPLING STRIP FOR
INVESTIGATING OBSERVER BIAS IN AERIAL SURVEYS

R M Watson and C I Tippet
Resource Management and Research

and G M Jolly*
Agricultural Research Council Unit of Statistics
University of Edinburgh

INTRODUCTION

Central to all applications of low-level aerial observation is the problem of spotting the item or items which are then to be photographed, timed, or, in the case of small groups of individuals, counted. No trials have ever been undertaken which have tested the observer's ability to perform this task in the context of strip sampling, which is now the commonest method in use. Such trials as have been carried out have tested the observer's ability to spot known numbers of animals or people confined to fixed, clearly defined areas, which are then searched by the aerial observer in the fashion used for total counts (see Watson et al, 1969; Watson, 1970b; Le Resche and Rausch, 1974). The results of these trials have been disappointing, and have led some workers to doubt the usefulness of low-level aerial observation methods. For example, Watson et al (1969) showed that experienced observers and pilot/observers were able to count an average of 75% of 155 people

* The authors are grateful to M Russel, A Russel, P Tilley, C Hemming, D Thalen, D Brown, B Davidson, V Scholes and I Romalin for helping to carry out the field exercise described in this paper; to the pilots and observers who took part; to I Douglas-Hamilton and H Croze who provided their own aircraft; to D Hopcraft for making available the facilities of his ranch; and to UNEP for providing financial support for the exercise.

restricted to a small (5 km^2) area of medium-density wooded shrubland, while Le Resche and Rausch (1974) showed that only 68 and 43% of known numbers of moose in small paddocks were counted from the air. In these trials, the group sizes of animals and people were so small that errors due to counting, as distinct from errors due to spotting (or sighting), were considered to be minor.

It must be emphasized, however, that these trials have tested the observer's ability to spot animals and people when flying, or being flown, not along sampling strips, but in a searching pattern over blocks or quadrats of land. The strip has been widely adopted as a sampling unit, largely because it was believed that errors due to spotting problems would be standardized and minimized within a narrow strip. Although users of the sampling strip believed they were reducing bias by using this method, it has been almost impossible to demonstrate this in quantitative terms. This is a consequence of the nature of the sampling strip and of the items usually being observed. The sampling strip exists for the observer only at the moment the aircraft is flying over it: it is not fixed on the ground and could only be fixed if some expensive photographic technique were used. In general, this has not been justified because the animals in the strip are mobile, being judged as inside or outside only at the moment when the decision line on the sampling demarcators passes over them (Watson and Tippett, 1975). As a result, tests of strip sampling methods have necessarily been performed on different sampling strips, and therefore precise comparisons have been impossible.

Ingenious methods of assessing spotting or sighting bias (also commonly called visibility bias) have been devised, which are described in this paper and elsewhere in this report. However, this discussion will focus largely on one approach tested during the workshop, based on a static model sampling strip.

THE STATIC MODEL SAMPLING STRIP

Game Ranching Ltd at Athi River was offered by the owner for the establishment of a static model sampling strip. The ranch is just outside the Nairobi flight control zone and surrounded by a conspicuous game-proof fence some 55 km long.

The night before the exercise, a number of models were positioned and fixed inside the perimeter fence. The models were of three types: 1 m² sheets of light brown card, 2 x 1.5 m sheets of shiny black polythene, and 2 x 1.5 m sheets of clear polythene. They were positioned along the transect in three ways:

- The cards were positioned in groups of up to 4, all within 100 m of the inner edge of the perimeter fence.
- The black polythene sheets were laid out in groups of up to 40 (but mostly of 6 or less) within 150 m of the inner edge of the fence.
- The clear polythene sheets were placed singly up to 250 m from the inner edge of the fence.

The distance of all sheets more than 80 m from the fence was recorded.

In all, 1027 models were laid out, including 192 cards, 621 black polythene sheets and 214 clear polythene sheets. Their distribution is shown in Table 1. The average density of all the models was 118 per km² or 18 per km of transect, while the average density of groups was 47 per km² or 7 per km of transect. These can be considered as moderately high densities for counting purposes.

The 55 km sampling strip was flown 13 times in one day, involving 4 different aircraft and 12 observers. Because of adverse early morning weather, the whole exercise began much later than anticipated, and so it was only possible to test a limited number of observer/aircraft combinations. Each observer/aircraft combination calibrated strip widths by reference to a grid of marker, spaced at 10 m intervals, which were laid out along the side of the airstrip at the ranch. Specimens were positioned close to this grid so that pilots and observers could familiar-

Table 1. Distribution of cards and polythene sheets on the static model sampling

Fence Section	Length (km)	No. of Cards	Group Sizes and Total Numbers of Black Polythene Sheets	Numbers and Distance from Fence of Clear Polythene Sheets
A	11.2	28	5, 6, 1, 3, 5, 7, 5, 5, 2, 6, 10 = 55	12 at less than 80 m 2 at 120 m 2 at 160 m 1 at 200 m = 15
B	1.4	12	10, 6, 5, 11, 5, 5, 13, 5, 5, 10 = 75	12 at less than 80 m 2 at 120 m 2 at 160 m 1 at 200 m = 15
C	3.6	9	6, 8, 5, 5, 2 = 26	9 at less than 80 m 2 at 120 m 1 at 200 m = 12
D	5.9	21	4, 4, 5, 3, 20, 3, 3, 4, 6, 7, 1, 1, 5 = 66	15 at less than 50 m 4 at 120 m 3 at 160 m 3 at 200 m = 25
E	1.9	16	4, 4, 4, 3, 15, 10 = 40	9 at less than 80 m 2 at 120 m 2 at 160 m 1 at 200 m = 14
F	2.5	5	6, 4, 6 = 16	5 at less than 80 m 2 at 240 m = 7
G	4.0	5	6, 7, 7, 5, 5, 3 = 33	12 at less than 80 m 1 at 230 m = 13
H	4.7	15	4, 5, 7, 6, 5, 3, 2 = 32	6 at less than 80 m 3 at 150 m 3 at 190 m = 12
I	9.3	32	5, 4, 7, 6, 6, 4, 4, 3, 3, 2, 4, 6, 10, 2, 3, 2, 6, 3, 3, 2, 4, 2, 1, 3, 3, 2, 3, 4, 5, 3, 5, 3, 4 = 127	34 at less than 80 m 2 at 120 m 1 at 160 m 2 at 250 m = 39
J	3.0	5	5, 3, 2, 2, 4, 3, 6, 3 = 28	5 at less than 80 m 4 at 220 m = 9
K	2.1	22	2, 3, 5, 6, 7, 5, 4, 3, 2, 7, 4, 4, 3, 4 = 59	21 at less than 80 m 2 at 140 m 2 at 160 m 2 at 210 m = 27
L	5.9	22	3, 3, 4, 2, 1, 5, 1, 1, 3, 2, 2, 2, 4, 1, 2, 2, 4, 6, 7, 3, 4, 3 = 65	17 at less than 80 m 2 at 120 m 2 at 160 m 1 at 200 m = 22
Total	55.5	192 in 77 groups	621 in 138 groups	157 at less than 80 m 173 at less than 120 m 175 at less than 140 m 178 at less than 150 m 192 at less than 160 m 195 at less than 190 m 203 at less than 200 m 205 at less than 210 m 209 at less than 220 m 210 at less than 230 m 212 at less than 240 m 214 at less than 250 m

ize themselves with the appearance of the models. Pilots and observers were briefed about the essentials of the trial and were given maps, as shown in Figure 1. Pilots used VHF (very high frequency) contact to maintain safe separations, for three aircraft were in the air simultaneously throughout the day.

During the trial flights, pilots attempted to keep the observer's inner strip marker just inside the boundary fence. In this way, the expected numbers of the three types of models could be calculated for a given strip width, and these could then be compared with numbers observed. Results of these trials are presented in Table 2.

DISCUSSION

The results of the static model sampling strip trial raised a number of issues. Concerning the relative advantages of counting through perspex or open windows, Graham and Bell (1969) and Watson and Tippet (see their paper in this report) considered that counting through perspex would be less efficient than counting through an open window, partly because of light reflected back from the perspex panel. Yet the results of the trial failed to reveal any significant difference between counts made through an open window and those made through perspex. This is shown in Table 3 for experienced observers and pilot/observers. Sample sizes are small, however, so the results must be considered preliminary. Perspex windows can also make photography more awkward and may affect the quality of photographs, although these effects were not tested here.

The efficiency of pilot/observers has been questioned by Norton-Griffiths (1978), but the trial showed that pilot/observers are just as effective as straight observers (see Table 3). Unfortunately, the sample sizes are small, but the results suggest that any differences between pilot/observers and straight observers are not large. The static model sampling strip also provides a good means of testing this issue more thoroughly in future.

Figure 1. The static model sampling strip

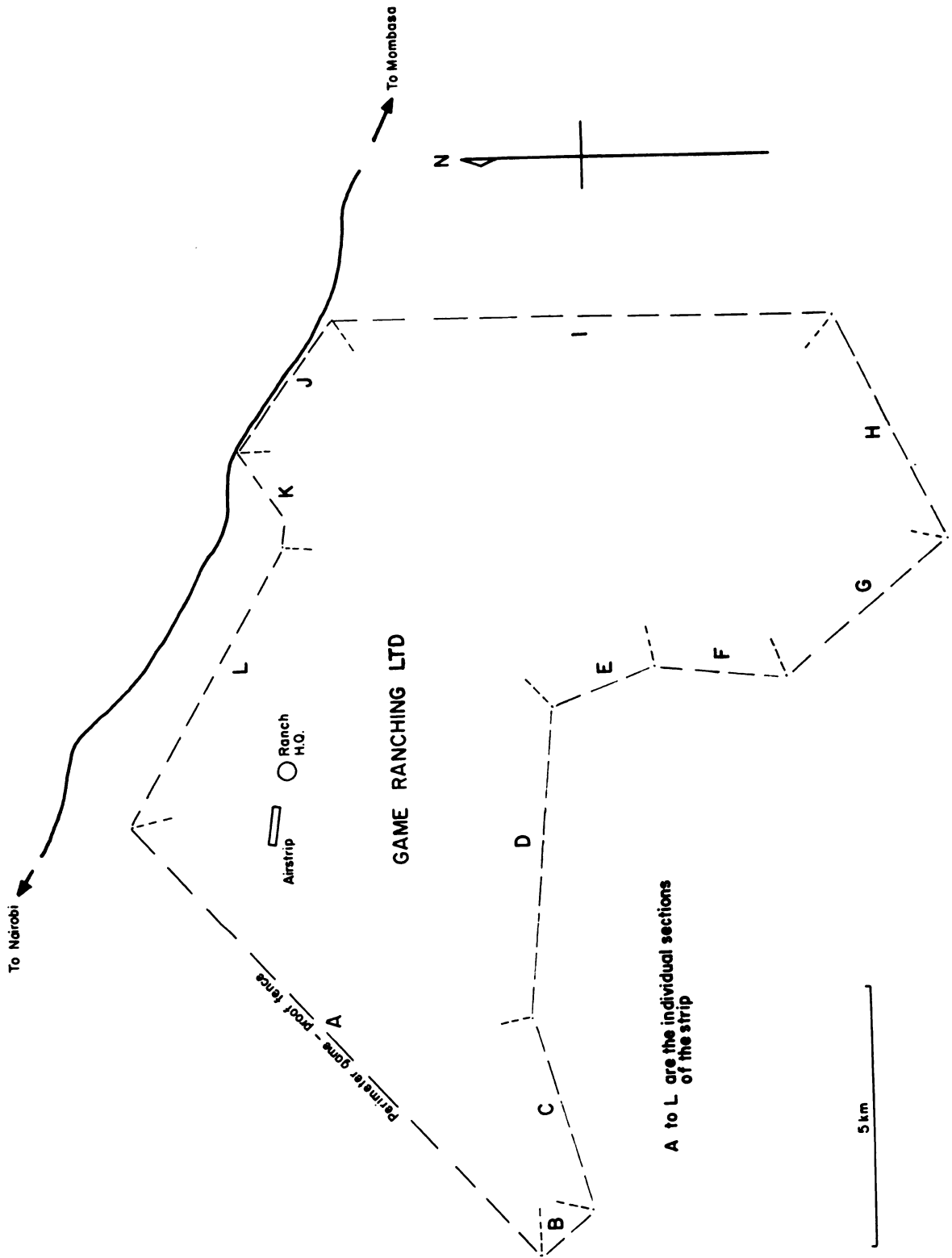

Table 2. Results of the trials flown along the static model sampling strip

Observer and Aircraft Type ^a	Time Elapsing (mins)	No. of Circles Made ^b	Speed from Data Forms (km/h)	Calculated Speed ^c (km/hr)	Strip Width Calibrated (m)	Time of Count (local)	Seat ^d	Open Window or Perspex ^e	% of Black Models Seen	% of Clear Models Seen	% of Cards Seen	% of All Models Seen
EP PA18	40	8	97	105	140	11.25	1	OW	91	91	95	92
EP PA18	50	20	97	111	250	16.45	1	OW	85	96	102	90
EO P 68	27	10	150	198	150	16.01	2	P	79	88	89	83
O PA18	52	20	97	105	250	16.45	2	P	73	84	93	79
EO 182	27	nil	121	-	138	11.00	2	P	86	97	94	89
EO 185	-	nil	121	-	-	-	2	P	88	-	103	-
EO 182	-	nil	121	-	132	15.54	2	P	87	84	96	88
EO 182	26	nil	121	129	144	-	2	P	91	84	105	92
EO 185	45	nil	112	74	135	11.45	2	P	82	85	100	86
O PA18	55	10	97	74	200	15.30	2	OW	82	79	111	87
EO 185	25	nil	121	132	170	15.40	2	P	85	91	106	90
O PA18	40	8	97	105	150	12.30	2	OW	-	-	tape recorder malfunction	-
EO 185	27	nil	129	123	140	17.30	2	P	82	95	106	89
Average for all trials	-	-	-	-	-	-	-	-	84	89	100	87

^a EP = experienced pilot/observer, EO = experienced observer, O = observer. PA 18 = Super Cub, 182 = Cessna 182, 185 = Cessna 185, P68 = Partenavia.

^b Circles made over certain groups of models in order to make a more accurate count.

^c Based on assumption that each circle takes 1 minute.

^d 1 = pilot's seat, 2 = first passenger's seat.

^e OW = open window, P = perspex.

Table 3. Comparison of counts made through perspex and open windows by experienced observers and pilot/observers

Model Type	Percent of Models Counted	
	through perspex (observers)	through open window (pilot/observer)
Black sheet	85% (n = 8)	88% (n = 2)
Clear sheet	89% (n = 7)	94% (n = 2)
Card	100% (n = 8)	99% (n = 2)
All models	88% (n = 7)	91% (n = 2)

It was intended to test the influence of aircraft speed on the accuracy of counts, as other tests (Watson, 1970b; Caughley, 1974) had indicated that this is an important factor. Given the time available, however, it was not possible to test the effect of aircraft speed. It was noted that the aircraft performing the trials were in a nose-up, slow-flight attitude, and that both calculated and indicated speeds were below those recommended for cruising (see Table 2).

It was possible to divide the observers into three groups based on experience : very experienced, experienced and inexperienced. The comparative performance of these three groups is shown in Table 4. As would be expected, experienced observers appear to be more accurate and consistent than inexperienced ones. Again, the static model sampling strip offers an excellent means of further testing observer performance.

In summary, the static model sampling strip appears to provide, for the first time, a means of testing cheaply and precisely the influence of many of the variables associated with low-level aerial survey. In addition, this method could have appreciable value in training programmes and in monitoring observer performance. Its most important potential, however, probably lies in the field of estimating visibility bias.

Table 4. Observer experience and performance in counting all models

Observer Experience	Range of Counts around Actual Numbers (%)	Mean % of Models Seen	Mean % Overcounting
Very experienced (n = 2)	11	91	0.33
Experienced (n = 8)	16	88	0.61
Inexperienced (n = 2)	24	83	1.83

Bias of this type has been examined in the past chiefly in two ways, called for convenience the Caughley method (Caughley, 1974; Caughley et al, 1977), and the Watson-Jolly method (Jolly, 1969b; Watson and Tippett, 1975; Jolly and Watson, 1979). The Caughley method suffers from a lack of precision, due to the high variability of sampling strip counts which cannot be eliminated because of the ephemeral nature of the sampling unit, and from the weakness of the mathematical assumptions in the critical area of the extrapolation it implies. The Watson-Jolly method, which is a form of calibration, is more expensive than the Caughley approach, as it involves additional flying. It is also restricted in its usefulness to those animals which have coherent and stable social groups, and which respond to the aircraft's herding actions in specific ways.

Other approaches have been attempted to measure sighting bias along sampling strips. Robinette et al (1974) carried out trials of strip sampling over an area of known populations of mobile and immobile objects. Watson (1970b), surveyed sampling strips first in the usual way, but, each time animals were sighted, searched the area within the strip boundaries (as judged from memory) more thoroughly at lower levels. Watson and Tippett (1976) used a polaroid camera to establish the boundaries of sampling strips at critical positions, which were then searched more carefully at lower levels, using the aircraft to flush out small and

furtive species. None of these approaches, however, has appeared likely to offer a general, inexpensive and precise means of estimating sighting bias.

The use of a static model sampling strip appears more promising. Models of greater sophistication could be constructed to simulate real animals more closely. They could be moved to test the influence of animal behaviour and aggregated in various ways to test the influence of group size. More importantly, it might be possible to develop a general theory of sighting bias from a series of carefully designed experiments, which would improve the acceptability of low-level aerial survey methods by resource managers and other users.

6. FIELD EQUIPMENT



AIRCRAFT TYPES

A panel of experienced low-level aerial survey pilots discussed the various aircraft types available and their qualities. Since 1968, there has been little change in the types of aircraft available, so the summary tables comparing aircraft types provided by Tippett (1968) are still useful guides, except as regards costs. The single important new type is the high-winged, twin-engined Partenavia (P-68), which is a relatively high-performance, inexpensive aircraft now being used successfully in survey and census work by KREMU in Kenya and ILCA in West Africa.

The main qualities which are important in choosing an aircraft for low-level survey work are: high wings, slow speed capability (i.e. less than 160 kph), good pilot/observer visibility, range, comfort (including low noise), safety and low cost. Suitable aircraft were ranked within three groups as follows, based on performance, cost and serviceability:

- Super Cub group: Piper Super Cub (PA-18), Piper Cruiser (PA-12) and Cessna 150 (modified for high performance)
- Single-engined Cessna group: Cessna 182, Cessna 206, Cessna 180, Cessna 185, Cessna 210 and large single-engined aircraft such as Helicourrier, Beaver and Pilatus-porteur
- Light twin-engined group: Partenavia (P-68) and Cessna 337.

Of these three groups, the Super Cub type is the most suitable for pilot/observers working alone and is the least expensive. There was some discussion, however, as to whether the slow speeds of this aircraft type may restrict its usefulness, for

example to census work requiring a high degree of accuracy, surveys over rough terrain, or surveys involving frequent landing to observe features on the ground.

Although their relative operating costs have decreased considerably in recent years, in 1980 helicopters still cost about 50% more to operate than fixed-wing aircraft. However, for surveys which require hovering capability or frequent landings, there is no substitute for a helicopter. Tethered balloons with remote sensors were also mentioned as being of potential use, but so far there has been no development of such systems for ecological survey work.

THE USE OF SENSING EQUIPMENT

Discussion on sensing equipment ranged widely during the workshop, but centred around three types of sensor systems, still and ciné photography, video-recorders and thermal scanners.

Still and ciné photography

Still and ciné photography - including special film types - already plays an important role in survey and census work, which is likely to increase. Regular 8 and Super 8 ciné systems are useful alternatives for continuous and spot recording along aerial transects, as the capital and operating costs of these systems are relatively low. The cost-effectiveness of using ciné could be improved if a time-interval regulator were attached to the camera so that the minimum number of frames were taken in order to cover the sampling strip. The film could then be stopped at particular frames to allow counting.

Video-recorder systems

Video-recorders were first used for aerial census on an experimental basis in eastern Africa in the late 1960s and early 1970s, but the equipment available at that time was heavy and very expensive. Resolution on professional standard colour video-tape (2 in wide) was excellent as long as the tape was moving. If it was

stopped, however, to allow large herds to be counted, the repetitive scanning necessary to freeze the action resulted in major distortion and loss of clarity. A 2-hour colour video tape for a professional system cost at that time about US\$3 000 and had a use-life of about 1 000 hours. The new generation of portable video-recorders are said to be much more efficient and, since they are solid state, they last longer and give clearer images. The new 2-hour colour video tapes only cost US \$ 150, but the camera, recorder and ground replay equipment cost about US \$ 60 000. The operational life of the new tapes is not known. Video-recorders have been linked to thermal infrared scanners for livestock surveys in Europe so that hot spots are indicated on the video tape.

The workshop participants agreed that video-recorder systems show promise as tools for use in aerial census and survey work, although few of those present had actually used these systems. High capital costs tend to prevent both government agencies and private firms from acquiring video-recorder systems. In view of the need for experimental work in this field, it was urged that the international organizations, such as UNEP, contact the manufacturers to arrange suitable tests and trials. These should include comparisons with ciné systems.

Thermal scanners

Thermal scanners have been used to determine the presence and/or numbers of animals not readily observable, such as beavers and muskrats in their lodges during winter. Thermal scanning has been used in Canada to count bison, moose, deer and elk in comparison with aerial survey and ground counts. The total number of ungulates in one trial was estimated at 2 175 using a thermal scanner, compared with 1 010 and 1 231 using conventional air survey methods (Intera Environmental Consultants, 1976). Sources of error included hot spots from other sources, such as solar heated objects, vacated sleeping spots and non-target animals. Sex and age information could not be obtained, and it also proved difficult to identify species of animals detected, although this was possible to a certain extent based on social behaviour characteristics. Costs were about US \$ 50 per 2.5 km².

Further developments

Discussion also drew attention to the possible adaptation for aerial survey and census work of technology developed for military purposes, such as 'sniffers' to detect odours specific to different animal species and sensitive microphones trailed from aircraft or located on the ground. Light intensifiers and night-vision equipment have already been adapted from original military use.

In general, the workshop participants agreed that more information is needed on sensors and sensor systems, including side-looking airborne radar (SLAR) and ultra-violet detection (see Lavigne et al, 1977). More conventional sensor systems - particularly ciné and video-recorders - offer great potential in aerial survey work, though trained human observers will play a major part in aerial surveys for a considerable time to come. Though human observers are affected by many types of bias, they also adapt more rapidly to changes in observing situations than sensing devices: for instance, there is generally no obvious time-of-day effect on aerial animal counts by human observers.

7. DATA PROCESSING AND INFORMATION TRANSFER

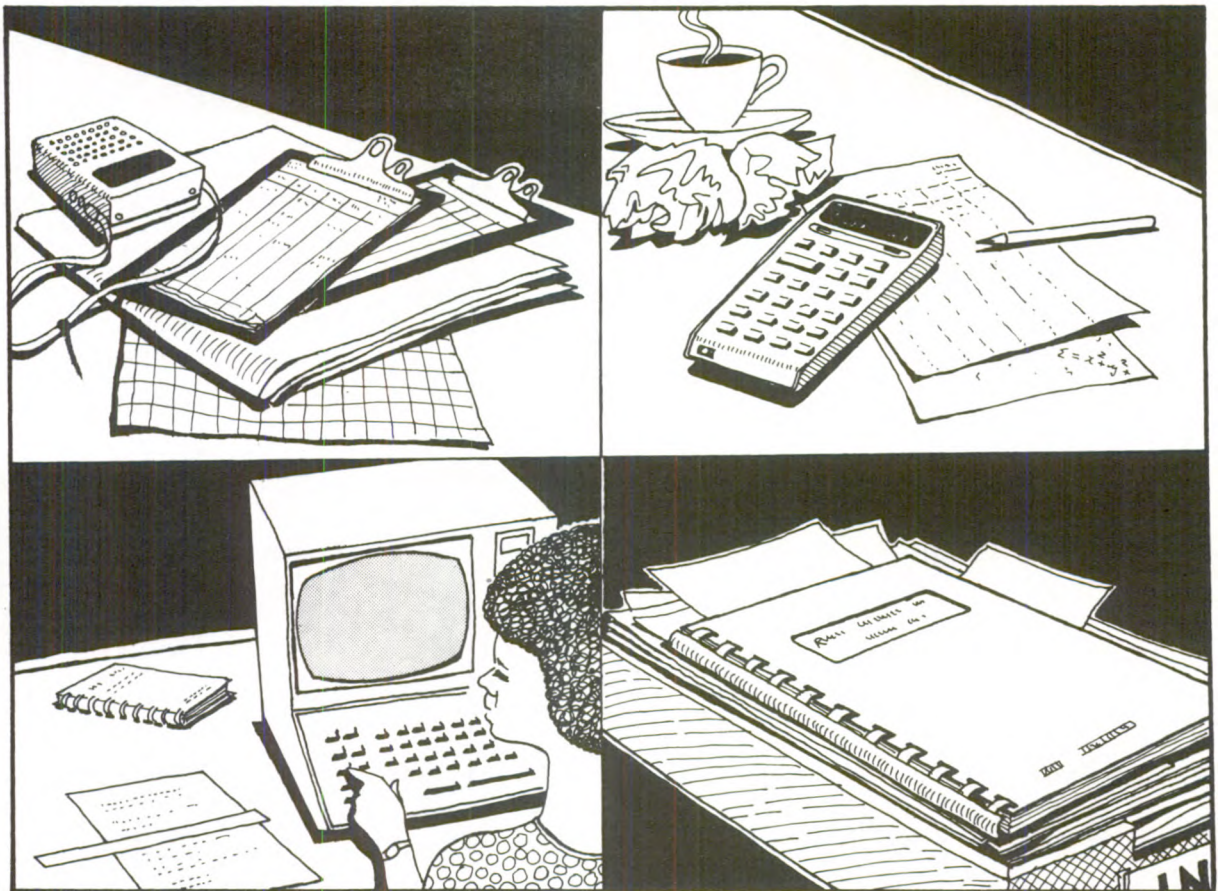

The seminar on data processing, transfer and use, which took place on the third day of the workshop, focused on two areas: first, on some specific problems of data processing and, second, on more general problems of data transfer and use. The participants generally agreed on a number of points in both areas.

DATA PROCESSING

Prior to conducting a survey, care is needed in the definition of the data to be collected. Unambiguous definitions of such terms as 'group', 'herd', 'habitat type' or 'hut' are needed in order to avoid a situation where different observers record the same phenomena in different ways. To avoid confusion, the definitions must be strictly followed. Categories can be constructed so that data can be recorded as numbers, thus saving time and simplifying subsequent analysis.

Survey data should be carefully checked and edited at all stages, including the recording, coding and key punching stages. The person who collected the data should assist in preparing a clean data form.

Computers not only synthesize observations quickly but also, if wrongly programmed, accumulate errors quickly. Computers can separate the user

from the data and may limit the flexibility of analysis. With small data sets, analysis is often better carried out using a pocket calculator. Also, if statistical packages are used, they should be carefully selected to be suitable for the desired analysis. Finally, data collection and editing procedures should be thoroughly documented and made available to future users.

A special problem concerns confidence limits. As animals are often distributed irregularly, the frequency distribution of transect densities tends to be positively skewed. In this situation, the usual method of calculating confidence limits may give an unrealistic lower limit, or even a negative value in some cases. One way of dealing with this problem was proposed during the seminar by G M Jolly: sensible confidence limits are derived by adding and subtracting

$$t \cdot \sqrt{\frac{\text{Var}(\hat{N})}{4\hat{N}}} \quad \text{to} \quad \sqrt{\hat{N}}$$

where \hat{N} is the estimate of numbers or density. These limits are then squared, with the result that the upper limit is greater than the lower one. It must be realized, however, that this is only a rough, empirical way of dealing with a complex distribution problem. It was also noted that some practitioners prefer to give standard errors rather than 95% confidence limits and to leave the user to choose appropriate confidence limits. For instance, some users might be prepared to accept 80% confidence limits.

DATA TRANSFER AND USE

Good communication between managers, statisticians and aerial survey workers is essential for the efficient flow of data. This implies that resource managers should be involved in planning aerial surveys. Data transfer and use will only be efficient if the objectives of the survey are well formulated and clearly stated. Managers should also be informed of the limitations of the survey method so that they are aware of the limitations of the data which are made available.

It must also be recognized that some kinds of information and analyses require the collection of data over a long period, for instance over 10 years. Thus conclusions are not available for some time, a situation which should not be confused with an inefficient flow of information.

The following suggestions were made for improving the flow of data from those who carry out aerial surveys to those responsible for decision-making and resource management:

- better communication between managers and survey workers**
- thorough documentation of all data collection and processing procedures**
- preparation of a clean data set which is available to future users**
- provision of adequate incentives to key individuals to ensure their role in maintaining the flow of data.**

8. TRAINING AND MOTIVATION

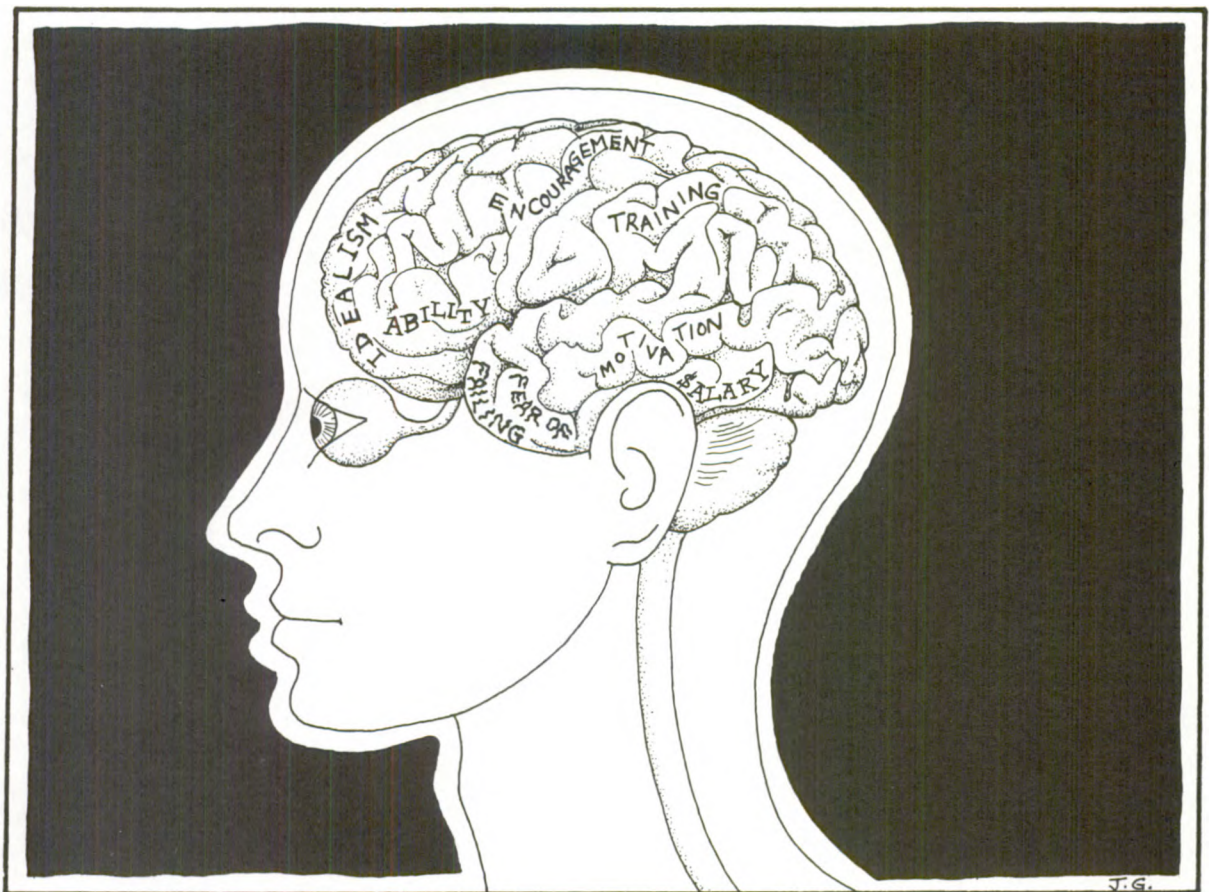

A number of points emerged from discussion which took place on the third day of the workshop during a seminar on the training and motivation of aerial survey personnel. It was generally agreed that various types of remote sensing equipment are promising developments which merit further testing, but they are unlikely to replace human observers for some time. Meanwhile, all those involved in the field-work and data-handling aspects of aerial surveys are likely to require some type of specialized training.

Very little information is available on the training of aerial observers. A notable exception is the report prepared by Dirschl et al (1978a) for KREMU, where a systematic training programme was carried out prior to initiating aerial survey work. Once they are trained, aerial observers should be subject to routine periodic testing and calibration. They should also occasionally be given other duties in order to avoid staleness and boredom. Front-seat observers, who record environmental variables, should probably be qualified biologists, with further training and calibration in the specific features which are to be recorded.

There was general agreement that natural aptitude is a crucial requirement for pilots who carry out low-level aerial survey work; training by itself is probably insufficient to produce safe and competent pilots. Experience is also important, however: as a rough guide, pilots should log a minimum of 1000 hours of flying time before undertaking low-level flying with passengers.

Observer performance appears to be influenced primarily by three factors:

- **ability, based on aptitude and training in aerial observation**
- **motivation, based on idealism, positive incentives or fear of failing**
- **additional training in related fields, such as ground sampling, and data handling and application.**

Positive incentives for both pilots and aerial observers include team spirit, credit for good work, encouragement, opportunities for further training and, above all, adequate remuneration.

9. WORKSHOP SUMMARY AND RECOMMENDATIONS

The International Workshop on Low-Level Aerial Survey Techniques, held in Nairobi, Kenya from 6 to 12 November 1979, was planned as a sequel to a Workshop on the Use of Light Aircraft in Wildlife Management in East Africa, held in 1968. Specialists in aerial survey from eastern Africa and other parts of the world were brought together to:

- review developments in aerial survey techniques and applications which have occurred in the 11 years since the first workshop
- assess the usefulness of aerial surveys in providing information for different planning and management situations
- evaluate the various techniques currently in use
- recommend further research, testing and training activities to improve the quality of future low-level aerial surveys.

In addition to 5 days of discussion, a 2-day field exercise was held on a game and livestock ranch near Nairobi. Four light aircraft were used to count plastic and card models which had been placed along a fixed transect. Counts were made by a number of different plane/pilot/observer combinations in order to:

- demonstrate various survey configurations and techniques
- assess differences in performance in surveying more and less cryptic models.

The workshop participants agreed that aerial survey is a relatively accurate and cost-effective technique for obtaining a wide range of environmental information. However, aerial surveys are most effective when undertaken together with complementary ground surveys, which provide detailed information, as well as the analysis of satellite imagery and high-altitude aerial photographs which expand the possibilities of inexpensive and repeatable extrapolation.

Two main types of aerial surveys were identified. Inventory or resource surveys might be undertaken to enumerate one or a few animal species or a broad range of environmental attributes. Only one or two surveys are usually carried out, giving broad coverage and the most appropriate combination of precision and accuracy. Monitoring surveys, on the other hand, are usually carried out at intervals over an extended period of time. Their aim is to detect change, or lack of change, and therefore a higher level of precision may be required. Sample design and the location of sampling units must be consistent over repeated surveys.

Two main issues emerged during the workshop as particularly important to the future development and application of aerial survey methods. They can be described in general terms as problems of accuracy and precision and problems of information transfer.

PROBLEMS OF ACCURACY AND PRECISION

There was general agreement that efforts to improve aerial survey methodology over the next few years should aim at reducing or accounting for bias and controlling the precision of estimates. Accuracy is influenced by flying and observing procedures; precision, by survey design.

The problems of spotting objects from the air were discussed in detail during several workshop sessions. Issues covered included the relative merits of different types of aircraft, the use of pilot/observers or pilots with observers who fly as passengers and the development of various types of remote

sensing devices.

Discussions of survey design tended to focus on two major controversial issues - the use of systematic or random sampling and the selection of bases for stratification.

Both systematic and random sampling produce numerical and distribution data. Random sampling usually produces more useful numerical data, while practitioners who use systematic sampling feel that this approach produces more useful distribution data. Two possible disadvantages in systematic sampling were discussed. Sampling units which are spaced at regular intervals might resonate with regular habitat features, but experienced aerial survey specialists who are familiar with the terrain should be able to position their sampling units so as to avoid this problem. Systematic sampling may also lead to the overestimation of variance, though some workers may prefer to have an overestimation of this statistic.

If information is available on factors in the survey area which influence the distribution of the attributes to be surveyed, it is probably advantageous to stratify the area according to these factors in order to minimize variance within the sample. The advantages of stratification decrease, however, in complex surveys which include a large number of attributes. A general resource survey, for instance, may cover wildlife, domestic livestock, land use and infrastructure: in such a situation, it becomes difficult to identify one set of strata which is appropriate for all the attributes being surveyed. In most stratified samples, the strata are determined by administrative boundaries, land-system boundaries or boundaries based on ephemeral events, such as animal movements or the availability of surface water. The choice of an appropriate stratification for a particular region depends on the extent to which different types of boundaries explain the variability of important attributes.

The different approaches to aerial survey design may usefully be viewed in the context of information needs at different stages of development planning and

implementation. First, in the predevelopment stage, the requirement is usually for broad resource surveys, yielding general numerical information and fairly precise data on the distribution of a number of attributes. Even if pre-development information needs are focused on one attribute, say livestock, planners also need information on factors which make up the geophysical, biotic and socio-economic context of livestock development. During the development phase, information is most likely needed on a few key attributes and how they change over time. A series of surveys may be conducted, using a sample which is stratified according to land systems or distribution data from the predevelopment surveys.

PROBLEMS OF INFORMATION TRANSFER

Figure 1 illustrates the flow of information from the point of collection to the planners and managers who must use it. Discussion at the workshop was largely confined to the second box in this figure - methods of data collection - although it became clear that more attention should be directed to the analysis, presentation and ultimate use of the information which is collected through aerial surveys. Improvements in the area of data analysis should focus on the issues of standardization and quality control. To improve the communication and use of information, decision-makers and managers need to be more specific in stating what they want from survey specialists when surveys are still at the planning stage. At the same time, aerial survey specialists must educate planners and managers concerning the types of information they can provide and its possible uses, and they must plan their surveys within the context of development needs and priorities.

If decision-makers and resource-managers are to use technical information produced by aerial surveys, findings must be presented in a format which they can readily understand, such as summary tables, coloured maps or thematic overlays. At the same time, a complete set of raw data should be made available to scientists and technicians, perhaps through an environmental data bank maintained by a suitable international organization. The flow of information, particularly within

Figure 1. Flow of information to decision-makers and managers

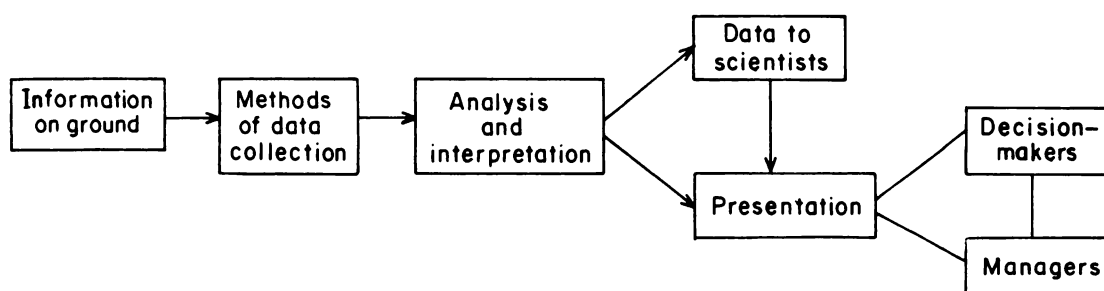

national governments, also needs to be speeded up, perhaps by streamlining bureaucratic processes, issuing phased reports to encouraging decision-makers to seek out information actively.

Many countries still lack trained personnel and organizational units capable of carrying out aerial surveys and must rely on the services of expatriate specialists. Though reliance on highly trained and experienced specialists may provide information quickly which is urgently needed by development planners and managers, nevertheless in the long term some resources should probably also be devoted to building up a national aerial survey capacity.

One special issue which arises from the present dependence on commercial consulting firms for aerial survey work is the occasional reluctance of these specialists to share information about the methodologies and techniques they have developed. To the extent that this attitude slows down development in the field, it should be discouraged, perhaps by reminding practitioners that their own scientific training was undoubtedly obtained in an atmosphere characterized by the free and open exchange of information. National governments and donor agencies, as clients of aerial survey specialists, might also insist that information on methodologies presented with reports of aerial survey work be made more widely available. GEMS is preparing a *UNEP Handbook*

on Ecological Monitoring which includes a description of aerial survey techniques. This compendium should be issued in 1982.

FUTURE DIRECTIONS

A number of important issues involved in aerial survey methodology were not discussed in detail at the workshop. These included:

- the possibility that the ratio of various attributes may be estimated with less bias than the absolute numbers involved
- the possibility that bias levels may be different when several attributes, such as different animal species, are counted rather than single attributes only
- ways to determine the levels of precision required in specific survey situations
- the feasibility of measuring primary production by remote sensing devices
- the recruitment and training problems reflected in the lack of aerial survey practitioners from Third-World countries.

Methodological improvements to ensure greater accuracy and precision in aerial survey work should be a common goal of all practitioners, as well as those who use survey information. To achieve this goal, information needs to be collected and made available on methodological developments, technological innovations and the full range of data sources. In addition, experimental work needs to be carried out on cost-effective approaches to bias control, both by developing technologies which produce a minimum of bias and devising correction factors for a wide range of attributes and situations.

Individual practitioners and consultancy firms, national governments and international organizations all have a role to play in the development of aerial survey

methodology. Consultancy firms should concentrate on survey information which is urgently needed and which they can provide relatively quickly and cost-effectively. They might also assist national governments in setting up their own survey systems. Government survey units should concentrate on routine resource monitoring, carrying out other types of research as their resources allow. Finally, international organizations have an important role in maintaining data banks, coordinating efforts to improve survey methodology, distributing information on survey techniques and assisting in the formation of national survey systems.

RECOMMENDATIONS

The following recommendations arose from the workshop:

1. More research and development are needed on ways to reduce or account for bias in aerial sampling and on ways to control the precision of estimates. This should lead to the development of techniques which involve a minimum of bias and correction factors for a wide range of attributes and situations.
2. Observer and pilot fatigue are regarded as a major source of bias in aerial survey. The military services of different countries around the world have acquired a wealth of basic physiological and medical experience concerning the effects of fatigue on efficiency. This experience should be collected, summarized and made available to those conducting aerial resource surveys.
3. More attention should be given to the development of methodologies and schedules for training aerial observers, with particular attention to methods for alleviating in-flight boredom.
4. Attention also needs to be focused on the development of methods to determine appropriate sampling strata.
5. Standardization and quality control need to be improved in the collection, analysis and presentation of aerial survey data.

6. **High capital costs have prevented practitioners in government and the private sector from acquiring video-recorder systems. In view of the need for experimentation in this field, international organizations should contact the manufacturers to arrange suitable tests and trials. These should include comparison with ciné systems.**
7. **A report should be prepared based on available information on airborne sensor systems for resource survey, including the use of sensors for enumeration, mapping and primary production assessments.**
8. **Experiments and trials with the various airborne sensor systems should be arranged and reports on such experiments made available to those planning resource surveys.**
9. **The flow of information from surveyors to managers needs to be improved through documentation of all data collection and processing procedures, preparation of a clean data set for future users, and provision of adequate incentives to individuals responsible for the flow of information.**
10. **There should be greater interchange of experience among the various organizations concerned with aerial survey.**

REFERENCES

- Anderson, D R, Laake, J L, Crain, B R and Burnham, K P (1979). Guidelines for line transect sampling of biological populations. *J. Wildl. Manage.* 43: 70-78.
- Arnold, G W and Dudzinski, M L (1978). *Ethology of free-ranging domestic animals*. New York, Elsevier.
- Baig, M S (1977). Inventory and evaluation of rangeland: An example for rangelands in arid zones worked out for the Quetta-Pishin area, Baluchistan, Pakistan. M.Sc. thesis. Enschede, International Institute for Animal Survey and Earth Sciences (ITC).
- Beek, K J (1978). *Land evaluation for agricultural development*. Publication No. 23. Wageningen, International Institute for Land Reclamation and Improvement.
- Behrensmeyer, A K (1978). Taphonomic and ecological information from bone weathering. *Paleobiology*. 4 (2): 150-162.
- Bell, R H V, Grimsdell, J J R, van Lavieren, L P and Sayer, J A (1973). Census of the Kafue lechwe by aerial stratified sampling. *E. Afr. Wildl. J.* 11 : 55-74.
- Bergerud, A T and Manuel, F (1969). Aerial census of moose in central Newfoundland. *J. Wildl. Manage.* 33: 910-916.
- Bliss, C I and Fisher, R A (1953). Fitting the negative binomial distribution to biological data. *Biometrics*. 9: 176-200.
- Burnham, K P and Anderson, D R (1976). Mathematical models for nonparametric inferences from line transect data. *Biometrics*. 32: 325-336.
- Caughley, G (1974). Bias in aerial survey. *J. Wildl. Manage.* 38: 921-933.
- Caughley, G (1977a). *Analysis of vertebrate populations*. New York, Wiley.
- Caughley, G (1977b). Sampling in aerial survey. *J. Wildl. Manage.* 41: 605-615.

- Caughley, G and Goddard, J (1975). **Abundance and distribution of elephants in the Luangwa Valley, Zambia.** *E. Afr. Wildl. J.* 13: 39-48.
- Caughley, G, Sinclair, R and Scott-Kemmis, D (1976). **Experiments in aerial survey.** *J. Wildl. Manage.* 40: 290-300.
- Caughley, G, Sinclair, R C and Wilson, G R (1977). **Numbers, distribution and harvesting rate of kangaroos on the inland plains of New South Wales.** *Aust. Wildl. Res.* 4: 99-108.
- Cobb, S M (1976). **The distribution and abundance of the large herbivore community of Tsavo National Park, Kenya.** Ph.D. thesis. Oxford University.
- Cochran, W G (1977). *Sampling Techniques.* Third edition. New York, Wiley.
- Cook, D C and Martin, F B (1974). **A model for quadrat sampling with 'visibility bias'.** *J. Am. Stat. Assoc.* 69: 345-349.
- Corfield, T T (1973). **Elephant mortality in Tsavo National Park.** *E. Afr. Wildl. J.* 11:339-368
- Croze, H (1972). **A modified photogrammetric technique for assessing age structures of elephant populations and its use in Kidepo National Park.** *E. Afr. Wildl. J.* 10: 91-115.
- Darling, F F (1960). **An ecological reconnaissance of the Mara Plains in Kenya Colony.** *Wildlife Monogr.* 12.
- DVH Consulting Engineers (1979). **Countrywide animal and range assessment project, Botswana: Draft final report.** Report to the Botswana Department of Wildlife, National Parks and Tourism. Amersfoort, The Netherlands.
- Dirschl, H J and Wetmore, S P (1978). *Grevy's zebra abundance and distribution in Kenya in 1977.* KREMU Technical Report No. 4. Nairobi, Ministry of Tourism and Wildlife.
- Dirschl, H J, Norton-Griffiths, M and Wetmore, S P (1978a). *Training of aerial observers and pilots for counting animals.* KREMU Technical Report No. 15. Nairobi, Ministry of Tourism and Wildlife.
- Dirschl, H J, Mbugua, S W and Wetmore, S P (1978b). *Preliminary results from an aerial census of livestock and wildlife of Kenya's rangelands.* KREMU Technical Report No. 3. Nairobi, Ministry of Tourism and Wildlife.
- Douglas-Hamilton, I, Hillman, A K, Holt, P and Ansell, S (1979). **IUCN/WWF/ NYZS Luangwa Valley elephant, rhino and wildlife survey.** Nairobi.

- Dudzinski, M L (1975). Principal components analysis and its use in hypothesis generation and multiple regression. In V J Bofinger and J L Wheeler, eds. *Developments in field experimental design and analysis*. Bulletin No. 50. Hurley, Commonwealth Bureau of Pastures and Field Crops.
- Eberhardt, L L (1978). Transect methods for population studies. *J. Wildl. Manage.* 42: 1-31.
- Ecosystems, Ltd (1978). An investigation into sources of sample error in aerial census of large mammals for KREMU. Report to the Kenya Ministry of Tourism and Wildlife. Nairobi.
- Eltringham, S K (1977). The numbers and distribution of elephant *Luxodonta africana* in the Rwenzori National Park and Chambura Game Reserve, Uganda. *E. Afr. Wildl. J.* 15: 19-39.
- Eltringham, S K and Malpas, R C (1980). The decline in elephant numbers in Rwenzori and Kabalega Falls National Parks, Uganda. *Afr. J. Ecol.* 18: 73-86.
- Evans, C D, Troyer, W A and Lensink, C J (1966). Aerial census of moose by quadrat sampling units. *J. Wildl. Manage.* 30: 767-776.
- Evans, P G H (1979). Habitat preferences of ungulates in closed savanna of central Africa. *Mammal Rev.* 9: 19-32.
- FAO (Food and Agriculture Organization) (1973). *Luangwa Valley conservation and development project, Zambia: Game management and habitat manipulation*. Rome, UNDP/FAO.
- FAO (Food and Agriculture Organization) (1976). *A framework for land evaluation*. Soils Bulletin No. 10. Rome.
- Florence, G R (1979). Survey and evaluation of rangelands in the Hukuntsi-Ngwatle pan area, Kalahari, Botswana, including an evaluation of some remote sensing techniques for rangeland inventory and monitoring. Draft M.Sc. thesis. Enschede, International Institute for Aerial Survey and Earth Sciences (ITC).
- Floyd, T J, Meck, L D and Nelson, M E (1979). An improved method of censusing deer in deciduous-coniferous forests. *J. Wildl. Manage.* 43: 258-261.
- Gates, C E (1979). Line transect and related issues. In R M Cormack, G P Patil, and D S Robson, eds. *Sampling biological populations*. Statistical Ecology Series Vol. 5. Fairland (USA), International Cooperative Publishing House.

- Goddard, J (1970). Age criteria and vital statistics of a black rhinoceros population. *E. Afr. Wildl. J.* 8:105-121.
- Goodman, L A (1960). On the exact variance of products. *J. Am. Stat. Assoc.* 55: 708-713.
- Graham, A D (1968). The Lake Rudolph crocodile population. Report by Wildlife Services Ltd to the Kenya Game Department. Nairobi.
- Graham, A D and Bell, R H V (1969). Factors influencing the countability of animals. *E. Afr. Agric. For. J.* 34 (special issue): 38-43.
- Graham, A D and Laws, R M (1971). The collection of found ivory in Murchison Falls National Park. *E. Afr. Wildl. J.* 9: 57-65.
- Graves, H B, Bellis, E D and Knuth, W M (1972). Censusing white-tailed deer by airborne thermal infrared imagery. *J. Wildl. Manage.* 36: 875-884.
- Grzimek, M and Grzimek, B (1960). Census of plains animals in the Serengeti National Park, Tanganyika. *J. Wildl. Manage.* 24: 27-37.
- Gwynne, M D (1978). Kenya Rangeland Ecological Monitoring Unit. Project TF/KEW/43 (Can). Nairobi, FAO.
- Gwynne, M D and Croze, H (1975). East African habitat monitoring practice: A review of methods and application. In International Livestock Centre for Africa. *Evaluation and mapping of tropical African rangelands.* Addis Ababa.
- Hemming, C F (1972). The ecology of South Turkana: A reconnaissance classification. *Geog. J.* 138:15-40.
- ITC (International Institute for Aerial Survey and Earth Sciences) (1978). Projet de développement rural intégré de la région du Kaarta, République du Mali: Rapport final, phase de reconnaissance du volet 8: Cartographie. Enschede.
- Intera Environmental Consultants Ltd (1976). Report on thermal sensing of ungulates in Elk Island National Park. Calgary (Canada).
- Jolly, G M (1969a). Sampling methods for aerial censuses of wildlife populations. *E. Afr. Agric. For. J.* 34 (special issue): 46-49.
- Jolly, G M (1969b). The treatment of errors in aerial counts of wildlife populations. *E. Afr. Agric. For. J.* 34 (special issue): 50-55.
- Jolly, G M (1979). Sampling of large objects. IN R M Cormack, G P Patil and D S Robson, eds. *Sampling biological populations.* Statistical Ecology Series Vol. 5. Fairland (USA), International Cooperative Publishing House.

- Jolly, G M and Watson, R M (1979). Aerial sample survey methods in the quantitative assessment of ecological resources. In R M Cormack, G P Patil and D S Robson, eds. *Sampling biological populations*. Statistical Ecology Series Vol. 5. Fairland (USA), International Cooperative Publishing House.
- Kenyi, J M (1978). Aerial counts of buffalo herds in Rwenzori National Park, Uganda. *E. Afr. Wildl. J.* 16: 221-222.
- Kufwafwa, J W and Stelfox, J G (1979). Distribution of livestock and wildlife in areas within and adjacent to the Lake Kenyatta Settlement Scheme and some implications of proposed land-use plans on the conservation of wildlife in the area. KREMU Technical Report No. 8. Nairobi, Ministry of Tourism and Wildlife.
- Lamprey, H F, Glover, P E, Turner, M and Bell, R H V (1967). Invasion of the Serengeti National Park by elephants. *E. Afr. Wildl. J.* 5: 151-166.
- Lavigne, D M, Oritsland, N A and Falconer, A (1977). Remote sensing and ecosystem management. Publication No. 166. Oslo, Norsk Polarinstitutt.
- Laws, R M (1969). The Tsavo research project. *J. Reprod. Fert.* 6 (supplement): 495-531.
- Laws, R M and Parker, I S C (1968). Recent studies of elephant populations in East Africa. *Symp. Zool. Soc. London.* 21: 319-369.
- Laws, R M, Parker, I S C and Johnstone, R C B (1975). *Elephants and their habitats*. Oxford, Clarendon Press.
- Leatherwood, S, Gilbert, J R and Chapman, D G (1978). An evaluation of some techniques for aerial censuses of bottlenosed dolphins. *J. Wildl. Manage.* 42: 239-250.
- Leighton, F A, Gerrard, J M, Gerrard, P, Whitefield, D W A and Maher, W J (1979). An aerial census of bald eagles in Saskatchewan. *J. Wildl. Manage.* 43: 61-69.
- Le Resche, R E and Rausch, R A (1974). Accuracy and precision of aerial moose counting. *J. Wildl. Manage.* 38: 175-182.
- Leuthold, W (1975). Group size in elephants of Tsavo National Park and possible factors influencing it. *J. Anim. Ecol.* 45: 425-439.
- Leuthold, W (1976). Age structure of elephants in Tsavo National Park, Kenya. *J. Appl. Ecol.* 13: 435-444.
- Low, W A (1972). Community preference by free-ranging shorthorns in the Alice Springs District. *Proc. Aust. Soc. Anim. Prod.* 9: 381-386.

- Low, W A, Dudzinski, M L and Müller, W J (1981). The influence of forage and climatic conditions on range community preference of shorthorn cattle in central Australia. *J. Appl. Ecol.* 18: 11-26.
- Low, W A, Müller, W J and Dudzinski, M L (in press). Grazing intensity of cattle on a complex of rangeland communities in central Australia. *Aust. Rangel. J.*
- Low, W A, Müller, W J, Dudzinski, M L and Low, B S (1981). Population fluctuations and range community preference of red kangaroos in central Australia. *J. Appl. Ecol.* 18: 27-36.
- Maddock, L (1979). The 'migration' and grazing pressure. In A R E Sinclair and M Norton-Griffiths, eds. *Serengeti: Dynamics of an Ecosystem*. University of Chicago Press.
- Magnusson, W E, Caughley, G J and Grigg, G C (1978). A double-survey estimate of population size from incomplete counts. *J. Wildl. Manage.* 42: 174-176.
- Milligan, K, Bourn, D and Chachu, R (1979). Aerial surveys of cattle and land use in four areas of the Nigeria sub-humid zone. Consultants' report to the International Livestock Centre for Africa. Addis Ababa.
- Müller, W J, Low, W A, Lendon, C and Dudzinski, M L (1976). Variation in grazing patterns of free-ranging cattle in a semi-arid area. *Proc. Aust. Soc. Anim. Prod.* 11: 461-464.
- Newsome, A E (1965). The abundance of red kangaroos, *Megaleia rufa* Desmarest, in central Australia. *Aust. J. Zool.* 13: 269-287.
- Ng'ang'a, S N, Peden, D G and Stelfox, J G (1979). Relations between observer counts and photo counts in KREMU's 1977 survey data. KREMU Technical Report No. 7. Nairobi, Ministry of Tourism and Wildlife.
- Norton-Griffiths, M (1972). *Serengeti Ecological Monitoring Programme*. Nairobi. African Wildlife Leadership Foundation.
- Norton-Griffiths, M (1973). Counting the Serengeti migrating wildebeest using two-stage sampling. *E. Afr. Wildl. J.* 11: 135-149.
- Norton-Griffiths, M (1974). Reducing counting bias in aerial censuses by photography. *E. Afr. Wildl. J.* 12: 245-248.
- Norton-Griffiths, M (1975). The numbers and distribution of large mammals in Ruaha National Park, Tanzania. *E. Afr. Wildl. J.* 13: 121-140.
- Norton-Griffiths, M (1976). Further aspects of bias in aerial census of large mammals. *J. Wildl. Manage.* 40: 368-371.

- Norton-Griffiths, M (1977). Kenya Rangeland Ecological Monitoring Unit: Consultant's report. Nairobi, Ministry of Tourism and Wildlife.
- Norton-Griffiths, M (1978). *Counting animals*. Second edition. Nairobi, African Wildlife Leadership Foundation.
- Parker, I S C and Watson, R M (1969). Crocodile (*Crocodylus niloticus* Laurenti) distribution and status in the major waters of western and central Uganda in 1969. Report by Wildlife Services Ltd to the Uganda Fisheries Department and the Trustees of the Uganda National Parks. Nairobi.
- Parker, I S C and Watson, R M (1970). Crocodile distribution and status in the major waters of western and central Uganda in 1969. *E. Afr. Wildl. J.* 8: 85-103.
- Peden, D G (1980). A precision-based strategy for allocating sampling effort in nationwide surveys. KREMU Technical Report No. 32. Nairobi, Ministry of Environment and Natural Resources.
- Peden, D G, Stelfox, J G, Mutiro, J K and Mwange, J (1979). *Factors affecting the precision and accuracy of nation-wide aerial censuses of animal populations*. KREMU Technical Report No. 9. Nairobi, Ministry of Tourism and Wildlife.
- Pennycuick, C J (1969). Methods of using light aircraft in wildlife biology. *E. Afr. Agric. For. J.* 34 (special issue); 24-29.
- Pennycuick, C J and Western, D (1972). An investigation of some sources of bias in aerial transect sampling of large mammal populations. *E. Afr. Wildl. J.* 10: 175-191.
- Pennycuick, C J, Sale, J B, Stanley-Price, M and Jolly, G M (1977). Aerial systematic sampling applied to censuses of large mammal populations in Kenya. *E. Afr. Wildl. J.* 15: 139-146.
- Pratt, D J (1975). Predevelopment survey: The initial stages. In International Livestock Centre for Africa. *Evaluation and mapping of tropical African rangelands*. Addis Ababa.
- Robinette, W L, Loveless, C M and Jones, D A (1974). Field tests of strip census methods. *J. Wildl. Manage.* 39: 81-96.
- Ross, I C, Field, C R and Harrington, G N (1976). The savanna ecology of Kidepo Valley National Park, Uganda. *E. Afr. Wildl. J.* 14: 35-48.
- Sale, J B, ed (1968). Report of the working group on the distribution and status of East African mammals. Phase 1: Large mammals. Nairobi, East African Wildlife Society.

- Sargeant, A B, Pfeifer, W K and Allen, S H (1975). A spring aerial census of red foxes in North Dakota. *J. Wildl. Manage.* 39.
- Sheldrick, D W (1976). Report on poaching in the Tsavo National Park. Nairobi.
- Sinclair, A R E (1979). Dynamics of the Serengeti ecosystem: Process and pattern. In A R E Sinclair and M Norton-Griffiths, eds. *Serengeti: Dynamics of an ecosystem*. University of Chicago Press.
- Siniff, D B and Skoog, D O (1964). Aerial censusing of caribou using stratified random sampling. *J. Wildl. Manage.* 28: 391-401.
- Sokal, R R and Rohlf, F J (1969). *Biometry*. San Francisco, W H Freeman.
- Spiers, B (1978). A vegetation survey of semi-natural grazing lands (*dehesas*) near Mérida, S W Spain: A basis for land-use planning. *I T C Journal* (Netherlands). 4: 649-679.
- Stelfox, J G (1979). Population estimates of herbivores within Meru National Park and Bisanadi Conservation Area from aerial surveys using stratified and unstratified sampling: February and September, 1979. KREMU report. Nairobi, Ministry of Tourism and Wildlife.
- Stelfox, J G and Mugambi, M (1979). *Tana delta herbivore and habitat survey, February 2-5, 1979*. KREMU Technical Report No. 7. Nairobi, Ministry of Tourism and Wildlife.
- Stelfox, J G, Kufwafwa, J W and Mbugua, S W (1979a). *Distribution, densities and trends of elephant and rhinoceros in Kenya, 1977-1978 from KREMU's aerial surveys*. KREMU Technical Report No. 24. Nairobi, Ministry of Tourism and Wildlife.
- Stelfox, J G, Kufwafwa, J W, Mbugua, S W and Peden, D G (1979b). *Livestock and wild herbivore populations in Kenya rangelands in 1977 compared with 1978*. KREMU Technical Report No. 6. Nairobi, Ministry of Tourism and Wildlife.
- Stevens, W E and Mbugua, S W (1979). Distribution and densities of cattle, shoats (sheep and goats), camels, donkeys and wildlife in the rangelands of Kenya. KREMU report. Nairobi, Ministry of Tourism and Wildlife.
- Stewart, D R M and Stewart, J (1963). The distribution of some large mammals in Kenya. *J. E. Afr. Nat. Hist. Soc.* 24: 1-52.
- Talbot, L M and Stewart, D R M (1964). First wildlife census of the entire Serengeti-Mara region, East Africa. *J. Wildl. Manage.* 28: 815-827.
- Talbot, L M and Talbot, M H (1963). The wildebeest in western Masailand, East Africa. *Wildlife Monogr.* 12.

- Thalen, D C P (1979). *Ecology and utilization of desert shrub rangelands in Iraq*. The Hague, W Junk.
- Tippett, C I (1969). A comparison of the available range of light aircraft. *E. Afr. Agric. For. J.* 34 (special issue): 6-15.
- Wahome, E K and Kuchar, P (1979). *Calibration and use of soil moisture neutron probe in ecological monitoring*. KREMU Technical Report No. 12. Nairobi, Ministry of Tourism and Wildlife.
- Watson, R M (1970a). *Aerial livestock surveys of Kaputiei Division, Samburu District and N E Province*. Nairobi, Ministry of Economic Planning and Development.
- Watson, R M (1970b). *A report on trials of aerial counting methods in the Kiboko area*. Nairobi, FAO/UNDP Range Management Programme.
- Watson, R M (1979). *An aerial survey of livestock and other resources in Sierra Leone: A national survey*. Report to Hunting Technical Services Ltd. Borehamwood (U K).
- Watson, R M and Tippett, C I (1975). *A pilot census of livestock and natural resources for South Kordofan District. Volume 02: Methodology and bibliography*. Khartoum, Veterinary Research Administration, Ministry of Agriculture, Food and Natural Resources.
- Watson, R M and Tippett, C I (1976). *Sudan national livestock census and resource inventory. Volume 26: Ecological considerations*. Khartoum, Ministry of Agriculture, Food and Natural Resources.
- Watson, R M and Tippett, C I (1979). *Somali Democratic Republic central rangelands survey. Volume 1, Parts 1 - 12: Static range resources*. Mogadiscio, National Range Agency.
- Watson, R M, Jolly, G M and Graham, A D (1969). Two experimental censuses. *E. Afr. Agric. For. J.* 34 (special issue): 60-62.
- Watson, R M, Tippett, C I, Tippett, M J and Marrian, S J (1973a). *A livestock survey of the Alledoghi plains, Ethiopia*. Addis Ababa, Awash Valley Authority.
- Watson, R M, Tippett, C I, Tippett, M J and Marrian, S J (1973b). *Land use in Karago-Giciye, Rwanda and the implications for a smallholder tea project*. Washington, International Bank for Reconstruction and Development.
- Watson, R M, Tippett, C I, Tippett, M J and Marrian, S W (1973c). *Livestock, wildlife, land-use and land-potential surveys of Tana River District, Lamu District and South Garissa District*. Nairobi, Resources Management and Research.

- Watson, R M, Tippett, C I, Tippett, M J and Marrian, S J (1974). The results of a photogrammetric and questionnaire investigation of the agricultural system in part of Eritrea, the agricultural segments of Tigre, Wollo and northern Shoa and part of Haraghe Provinces. Addis Ababa, Planning and Programming Department, Ministry of Agriculture.
- Watson, R M, Razig, M T A and Gadir, F A (1975). The South Kordofan pilot census and its application to national planning. *Bull. Off. Int. Epizoot.* 84: 637-643.
- Watson, R M, Tippett, C I, Beckett, J J and Jolly, F (1976). A pilot forest inventory employing aerial methods for the Loka region of southern Sudan. Khartoum, Forestry Department, Ministry of Agriculture, Food and Natural Resources.
- Watson, R M, Tippett, C I, Bell, R H V, Rizk, F, Beckett, J J, Jolly, F, Scholes, V, Thackway, R and Casbon, F (1977). Sudan national livestock census and resource inventory. 33 volumes. Khartoum, Veterinary Research Administration, Ministry of Agriculture, Food and Natural Resources.
- Watson, R M, Tippett, C I, Beckett, J J and Scholes, V (1979). Somali Democratic Republic central rangelands survey. Volumes 2 - 4: Dynamic range resources. Mogadiscio, National Range Agency.
- Western, D (1976). An aerial method of monitoring large mammals and their environment. Document No. 9. Nairobi, UNDP/FAO Wildlife Management Project.
- Western, D and Andere, D (1978). A review of the status of Grevy's zebra and recommendations for its conservation. Confidential report to the Permanent Secretary. Nairobi, Ministry of Tourism and Wildlife.
- Western, D and Grimsdell, J J R (1979). *Measuring the distribution of animals in relation to the environment.* Handbook No. 2. Second edition. Nairobi, African Wildlife Leadership Foundation.
- Wetmore, S P, Dirschl, H J and Mbugua, S W (1977). *A comparison of six aerial censuses of Meru National Park and Bisanadi Conservation Area.* KREMU Technical Report No. 2. Nairobi, Ministry of Tourism and Wildlife.
- Wilson, R T (1979). Recent resource surveys for rural development in Southern Dafur, Republic of Sudan. *Geogr. J.* 145: 452-460.
- Wilson, R T and Adams, M E (1977). Rural development surveys in western Sudan. Enschede, ITC Jubilee Symposium.
- Yates, F (1960). *Sampling methods for censuses and surveys.* Third edition. London, Griffin.

Zaphiro, D (1959). The use of light aircraft to count game. *Wild Life (Nairobi)*.
1: 31-36.

Zonneveld, I S (1979). Land evaluation and land(scape) science. In *ITC textbook of photo-interpretation*. Vol. 7. Second edition. Enschede, ITC.

Zonneveld, I S, van Gils, H A M J and Thalen, D C P (1979). Aspects of the ITC approach to vegetation survey. *Doc. Phytosociol.* (Lille). 4 (new series): 1029-1063.

APPENDIX: WORKSHOP PROGRAMME

Tuesday 6 November 1979

a. m. I Introduction

- 1. Acknowledgements and welcome (S W Taiti)**
- 2. Aerial survey methods: Experience in Kenya, 1968 - 1978
(S W Taiti)**

II Why Aerial Survey? (Chairman: M D Gwynne)

- 3. Why aerial survey? (I S C Parker)**
- 4. A review of the sampling methods used in aerial survey
(G M Jolly)**

p. m. III General Ecological Surveys and Monitoring (Chairman: S M Cobb)

- 5. Light aircraft and global resource monitoring (M D Gwynne
and H Croze)**
- 6. An approach to evaluating techniques for studying vegetation
on arid rangelands (D C P Thalen)**
- 7. An overview of the Kenya Rangeland Ecological Monitoring
Unit (KREMU) (D K Andere)**
- 8. The aerial survey programme of the Kenya Rangeland
Ecological Monitoring Unit: 1976-79 (J G Stelfox
and D G Peden)**

Wednesday 7 November 1979

- a.m. IV **Surveys for Development (Chairman: K Milligan)**
9. **The role of aerial surveys in livestock development programmes (P A Sihm, J J R Grimsdell and K Milligan)**
 10. **Examples of low-level aerial surveys conducted in Africa from 1968 to 1979 : One firm's experience (R M Watson and C I Tippet)**
 11. **Aerial surveys for development in Botswana (A D Graham)**
 12. **Light aircraft methods and other approaches (C F Hemming)**
- p.m. V **Animal Census (Chairman: J G Stelfox)**
13. **Unstratified systematic sampling: Rationale and method (M Norton-Griffiths)**
 14. **Alternative methods of aerial livestock census (J J R Grimsdell, J C Bille and K Milligan)**
 15. **Elephant carcasses and skeletons as indicators of population trends (I Douglas-Hamilton and A K K Hillman)**
- VI **Seminars**

Thursday 8 November 1979

1. **Stratification and selection of sampling units: Effects on the bias and precision of estimates**
Panel: G M Jolly (Chairman), G E J Smith, R M Watson, M Norton-Griffiths and D G Peden
2. **Bias**
Panel: M Norton-Griffiths (Chairman), G M Jolly, G E J Smith and A D Graham
3. **Observers versus sensors**
Panel: M D Gwynne (Chairman), R M Watson, J G Stelfox and A D Graham

Friday 9 November 1979

4. Data processing, transfer and use
Panel: D G Peden (Chairman), G E J Smith and J O Ayieko
5. Training and motivation
Panel: D K Andere (Chairman), Solomon Bekure,
M Norton-Griffiths and C I Tippett
6. The aircraft platform
Panel: H Croze (Chairman), G M Milne, R M Watson and
C I Tippett
7. Appropriate technologies for aerial surveys in Africa, with regard
to government policy and cost/benefit considerations
Panel: J J R Grimsdell (Chairman), D C P Thalen,
D K Andere and M Stanley-Price

Saturday and Sunday 10 and 11 November 1979

VII Field Exercise (Organizer: R M Watson)

Monday 12 November 1979

- VIII Workshop Conclusions (Chairman: S W Taiti)
1. Summary of field exercise (R M Watson)
 2. Short summaries by the Section and Seminar Chairmen
 3. A summary of the workshop (H Croze)
 4. Concluding remarks (S W Taiti)



2
2