

How to look after your crop

- Keep it weed free
- Apply fertilizer (TSP) 1 bag per acre per year in the long rains
- After every cut apply manure in a furrow and cover with soil

How to use your crop

Cut the desmodium and napier when the napier is 2-3ft high



How to prepare the feed

Chop the mixture to avoid wastage



Leave stumps of 4" above the ground level for both crops

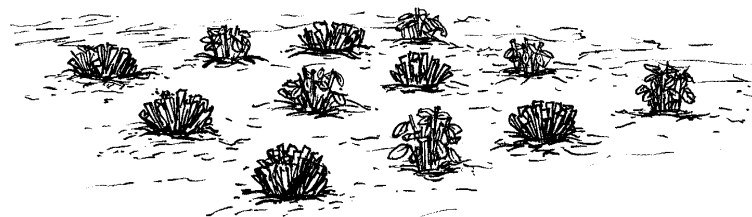

Feed to the animal

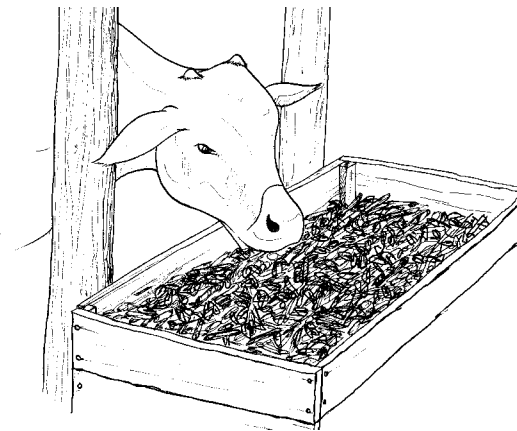

Compiled by: D.M. Mwangi, G.N. Gichungu, Ben Mungai
For more information contact The Ministry of Agriculture / KARI
Leaflet supported and funded by
DFID through The Small Holder Dairy Project
Produced by Development Communication and Media Trust

FEED
DESMODIUM
FOR MORE MILK
AND MONEY

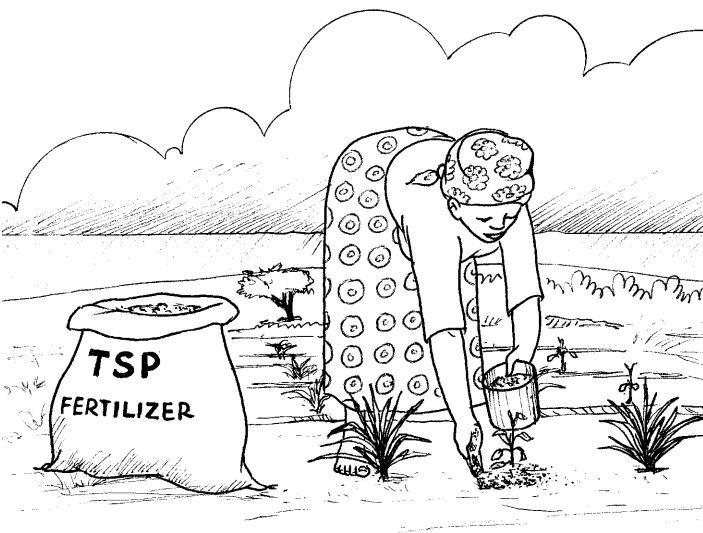
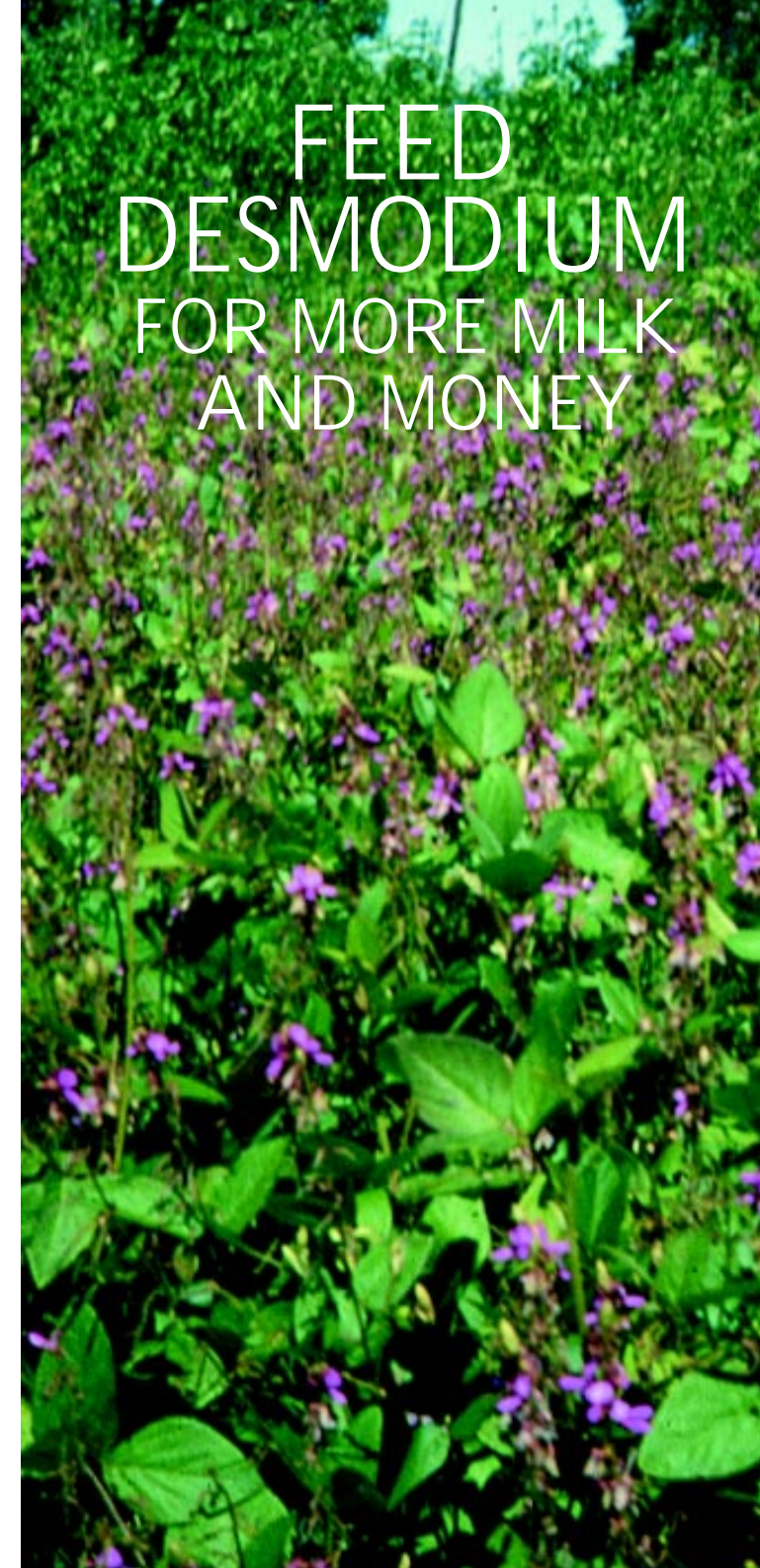

Dairy cows fed on Napier and Desmodium produce more milk



When Desmodium and Napier are grown together, the overall yield is increased



Desmodium can be grown from seeds or cuttings. It is cheaper to grow from cuttings.

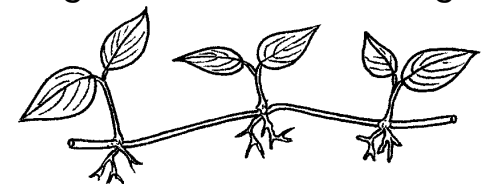

Grows best in coffee areas

How to grow desmodium from seed

Prepare a good seed bed 10ft x 10ft and raised 6 ins high. Make shallow furrows 1 in deep spaced 1ft apart

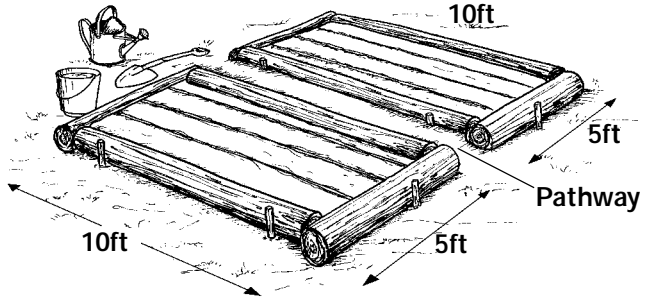

Mix seeds with "innoculant" which will help seed start growing. Read instructions on "innoculant" package.

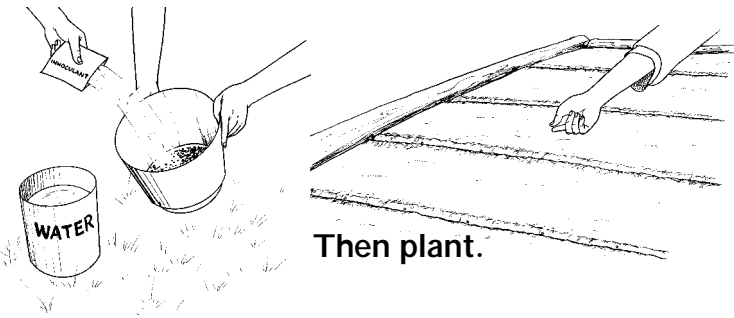

Water carefully and often.

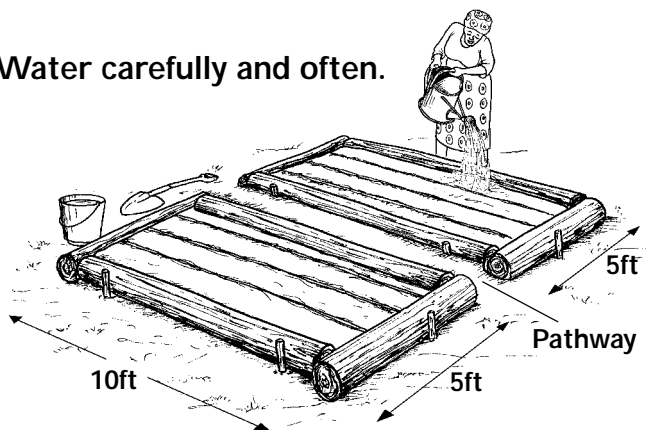

How to grow desmodium from cuttings

- Prepare a small plot in your farm as a nursery say 5ft x 10ft
- Bring desmodium vines 2 ft long, with soil still attached to the new roots

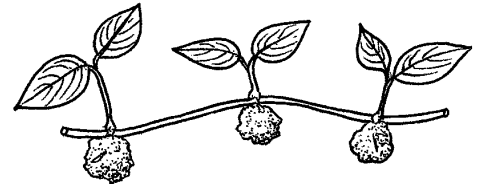

- Plant desmodium vines with a spacing of 1ft x 1ft and water often.

Mix seed with a hand full of soil from another desmodium plot and plant.

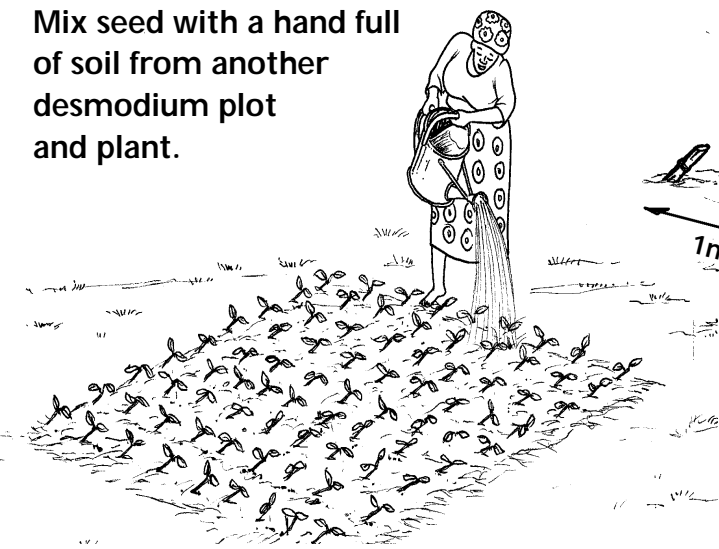

How to plant desmodium cuttings in the field

- Make small holes between the newly planted napier canes (or grass splits)
- Add 2-3 x 2kg tins of farm yard manure
- Take your cuttings from either your seed-bed or the small plot
- Plant your cuttings as you would sweet potato vines

