

# **Livestock and Sustainable Nutrient Cycling in Mixed Farming Systems of sub-Saharan Africa**

## **Volume II: Technical Papers**

Proceedings of an International Conference  
International Livestock Centre for Africa (ILCA)  
Addis Ababa, Ethiopia  
22–26 November 1993

*Edited by*

*J. M. Powell, S. Fernández-Rivera, T.O. Williams and C. Renard*

ISBN 92-9053-294-7

Correct citation: Powell J M, Fernández-Rivera S, Williams T O and Renard C (eds). 1995. *Livestock and Sustainable Nutrient Cycling in Mixed Farming Systems of sub-Saharan Africa. Volume II: Technical Papers*. Proceedings of an International Conference held in Addis Ababa, Ethiopia, 22-26 November 1993. ILCA (International Livestock Centre for Africa), Addis Ababa, Ethiopia. 568 pp.

# Table of Contents

Acknowledgements

Foreword

## Setting the scene

An overview of demographic and environmental issues in sustainable agriculture in sub-Saharan Africa

*M.A. Mohamed-Saleem and H.A. Fitzhugh*

An overview of mixed farming systems in sub-Saharan Africa

*J.M. Powell and T.O. Williams*

Nutrient cycling and its importance in sustaining crop–livestock systems in sub-Saharan Africa: An overview

*P.J. Stangel*

## Interactions between animals and plants

Animal/plant interactions: Nutrient acquisition and use by ruminants (Keynote paper)

*J.W. Stuth, R.K. Lyons and U.P. Kreuter*

Relationship between nutrient content of the veld and productive performance of the grazing ruminant in southern Africa

*C.T. Kadzere*

Quantitative and qualitative estimation of nutrient intake and faecal excretion of zebu cattle grazing natural pasture in semi-arid Mali

*E. Schlecht, F. Mahler, M. Sangaré, A. Susenbeth and K. Becker*

Foraging behaviour of cattle grazing semi-arid rangelands in the Sahel of Mali

*L. Diarra, P. Hiernaux and P.N. de Leeuw*

Feeding livestock for compost production: A strategy for sustainable upland agriculture on Java

*J.C. Tanner, S.J. Holden, M. Winugroho, E. Owen and M. Gill*

## Interactions between animals and soils

Manure as a key resource in sustainable agriculture (Keynote paper)

*K.H. Murwira, M.J. Swift and P.G.H. Frost*

Faecal excretion by ruminants and manure availability for crop production in semi-arid West Africa

*S. Fernández-Rivera, T.O. Williams, P. Hiernaux and J.M. Powell*

Pour un système durable de production au Mali-Sud: accroître le rôle des ruminants dans le maintien de la matière organique des sols

*R. Bosma, M. Bengaly et T. Defoer*

Nitrogen intake and losses by sheep on *Medicago* spp and barley pastures in northern Syria

*P. White, A.V. Goodchild, T.T. Treacher and J. Ryan*

Carbon and potassium dynamics in grass/legume grazing systems in the Amazon

*C.E. Castilla, M.A. Ayarza and P.A. Sanchez*

Soil aspects of nutrient cycling in a manure application experiment in Niger

*J. Brouwer and J.M. Powell*

Feed factors affecting nutrient excretion by ruminants and the fate of nutrients when applied to soil

*Z. C. Somda, J.M. Powell, S. Fernández-Rivera and J. Reed*

### **Interactions between plants and soils**

Nutrient recycling in pastures, rangeland, fallow and cut-and-carry systems in sub-Saharan Africa (Keynote paper)

*A. A. Agboola and A. A. Kintomo*

The role of forage legume fallows in supplying improved feed and recycling nitrogen in subhumid Nigeria

*G. Tarawali and M.A. Mohamed-Saleem*

The benefits of forage legumes for livestock production and nutrient cycling in pasture and agropastoral systems of acid-soil savannahs of Latin America

*R.J. Thomas and C.E. Lascano*

Millet and cowpea in mixed farming systems of the Sahel: A review of strategies for increased productivity and sustainability

*S.V.R. Shetty, B.R. Ntare, A. Batiano and C. Renard*

A critical review of crop-residue use as soil amendment in the West African semi-arid tropics

*A. Bationo, A. Buerkert, M.P. Sedogo, B.C. Christianson and A.U. Mokwunye*

Nitrogen in dryland farming systems common in north-western Syria

*H.C. Harris, J. Ryan, T.T. Treacher and A. Matar*

The interactive effects of rainfall, nutrient supply and defoliation on the herbage yields of Sahelian rangelands in north-east Mali

*P. Hiernaux, P.N. de Leeuw and L. Diarra*

### **Nutrient cycling in mixed farming systems**

Socio-economic dimensions of nutrient cycling in agropastoral systems in dryland Africa (Keynote paper)

*I. Scoones and C. Toulmin*

Nutrient transfers from livestock in West African agricultural systems

*P.N. de Leeuw, L. Reynolds and B. Rey*

Manure utilisation, drought cycles and herd dynamics in the Sahel: Implications for cropland productivity

*T.O. Williams, J.M. Powell and S. Fernández-Rivera*

Nutrient flux between maize and livestock in a maize-coffee-livestock system in central Kenya

*J.K. Ransom, J. Ojiem and F.K. Kanampiu*

Farmer and pastoral strategies in Saurashtra, Gujarat: An analysis of landless pastoralism and dependence on the manure market

*R.P. Cincotta and G. Pangare*

The sustainability of rangeland to cropland nutrient transfer in semi-arid West Africa:  
Ecological and social dimensions neglected in the debate

*M. Turner*

Measuring the sustainability of crop–livestock systems in sub-Saharan Africa:  
Methods and data requirements

*S. Ehui and M.A. Jabbar*

The role of livestock in sustainable agriculture and natural resource management

*J.D. Reed and J. Bert*

### **Modelling nutrient cycles in plant/animal/soil systems**

Modélisation et simulation dans l'élaboration de systèmes de production animale durables  
(Keynote paper)

*H. Breman*

Modelling the effects of livestock on nutrient flows in mixed crop–livestock systems

*P.J. Thorne*

Myth and manure in nitrogen cycling: A case study of Kaloleni Division in Coast  
Province, Kenya

*L. Reynolds and P.N. de Leeuw*

A static model of nutrient flow on mixed farms in the highlands of western Kenya  
to explore the possible impact of improved management

*K.D. Shepherd, E. Ohlsson, J.R. Okalebo., J.K. Ndufa and S. David*

African semi-arid tropical agriculture cannot grow without external inputs

*J. McIntire and J.M. Powell*

# Acknowledgements

We gratefully acknowledge the contributions from the following sponsors:

International Crops Research Institute for the Semi-Arid Tropics (ICRISAT)

International Centre for Research in Agroforestry (ICRAF)

International Fertilizer Development Center (IFDC)

and from:

Swiss Development Cooperation (SDC)

Canadian International Development Agency (CIDA)

and the cooperation of:

Food and Agriculture Organization of the United Nations (FAO)

Tropical Soil Biology and Fertility Programme (UNEP)

The Netherlands:

Technical Centre for Agriculture and Rural Cooperation (CTA)

Projet Production Soudano-Sahélienne (PPS)

Royal Tropical Institute (KIT)

Principal support was provided by the donors of the International Livestock Centre for Africa (ILCA)

We also recognise

Conference organiser: J M Powell

Scientific editors: J M Powell, S Fernández-Rivera, T O Williams and C Renard

Translators: G Gérard-Renard, assisted by P Hiernaux and C Renard

Language editor: A Nyamu

French text and abstracts edited and revised by S Adoutan

# Foreword

Achieving sustainable increases in agricultural production in sub-Saharan Africa is both a regional and a worldwide concern. High human and animal population densities in some areas have surpassed land-carrying capacities causing environmental degradation and undermining the long-term stability of these production systems. In attempts to meet the increasing food demands of larger populations, farmers are cultivating more land permanently, grazing lands have diminished and many traditional farming practices that formerly allowed land to rejuvenate are disappearing.

An efficient cycling of nutrients among crops, animals and soil is crucial to the sustained productivity of low-input mixed farming systems in sub-Saharan Africa. Access to agricultural inputs such as fertiliser and improved seed is limited. Nutrient balances, or the difference between nutrient inputs and harvests, are negative for many production systems. Although animal manures are perhaps the most important fertility amendment that many farmers apply to cropland, livestock can also contribute to these nutrient imbalances. Excessive removal of vegetation by grazing animals or harvesting feeds can deplete soil-nutrient reserves and result in decreases in soil productivity. A major portion of nutrients consumed by livestock may also be unavailable for recycling due to volatilisation, erosion and leaching losses, and uneven deposition of nutrients by animals in the landscape.

The climatic and socio-economic changes currently taking place in many parts of sub-Saharan Africa suggest that sustainable increases in agricultural production from an increasingly fragile ecosystem require new and innovative crop, livestock, and soil-management strategies. To further this objective, the International Livestock Centre for Africa (ILCA) and its cosponsors convened this conference to bring together national and international experts in livestock (cattle, sheep and goats) nutrition and management, ecology, agronomy, soil science and socio-economics to address fundamental issues of nutrient balances, agricultural productivity and the well being of the people, livestock and environment of sub-Saharan Africa.

The objectives of this conference were to:

- review the present state of knowledge on nutrient cycling in mixed crop–livestock systems
- identify research methodologies for investigating nutrient cycles in the plant/animal/soil interfaces of mixed farming systems
- identify future research priorities and integrated approaches for improving the role of livestock in the nutrient cycles of mixed farming systems.

Fifty-six national and international experts attended the conference. A total of 35 presentations from 18 countries reported on various livestock feeding and nutrient-cycling strategies in intensively and extensively managed mixed farming systems. The opening session provided an overview of the demographic and environmental changes and challenges facing sub-Saharan Africa today and the roles of livestock in mixed farming systems. Papers presented at the technical sessions addressed issues related to how animals acquire and utilise nutrients for their productivity, the fate of nutrients excreted by livestock, methods to improve nutrient capture and recycling and the social and economic processes that influence the availability of nutrient sources and flows in mixed farming systems. Issues related to resource management were examined at the field, farm, community and regional levels.

Volume I of the conference proceedings summarises the major discussions, findings and recommendations of the conference as gleaned from the rapporteur reports. This volume contains the full texts of the papers presented at the conference.

**Setting the scene**



# An overview of demographic and environmental issues in sustainable agriculture in sub-Saharan Africa

M.A. Mohamed-Saleem and H.A. Fitzhugh

International Livestock Centre for Africa (ILCA)  
P O Box 5689, Addis Ababa, Ethiopia

## Abstract

Ever-increasing human population and urbanisation are intensifying the demand for agricultural commodities in sub-Saharan Africa (SSA). As a result, the traditional balance between people, their habitat and socio-economic systems is fast disappearing. Excessive deforestation, land clearing and cultivation are occurring in an attempt to meet rising food demands. Land degradation and pollution threaten sustainable increases in agricultural productivity and endanger the survival of present and future generations. Changes in agricultural production are needed soon in sub-Saharan Africa to avert large-scale human suffering. Despite the rapidly growing population and enormous production constraints, SSA can become agriculturally self sufficient. This will require imaginative food production techniques and management approaches that protect the environment at unprecedented scales. These changes can only be realised through changes in political will and national attitudes.

## Aspects démographiques et environnementaux d'une agriculture durable en Afrique subsaharienne

M.A. Mohamed-Saleem et H. A. Fitzhugh

Centre international pour l'élevage en Afrique (CIPEA)  
B.P. 5689, Addis-Abeba (Ethiopie)

## Résumé

*La demande en plusieurs produits agricoles augmente rapidement en Afrique subsaharienne en raison de la pression démographique sans cesse croissante et de l'urbanisation. En conséquence, l'équilibre naturel entre les populations, leur habitat et leurs systèmes socio-économiques est en train d'être rapidement compromis. Pour satisfaire les besoins alimentaires croissants, les populations déciment des forêts et défrichent et mettent en culture des terres nouvelles. La dégradation des terres et des formes variées de pollution des terres, de l'eau et de l'atmosphère menacent tout développement agricole durable ainsi que la survie des générations présentes et futures. Des changements appropriés doivent intervenir rapidement dans le mode de production agricole de cette région en vue d'y prévenir une véritable tragédie humaine. Car, malgré sa croissance démographique rapide et les nombreux obstacles à la production, l'Afrique subsaharienne peut devenir autosuffisante sur le plan agricole. Cela passe cependant par l'adoption généralisée de techniques novatrices de production alimentaire ainsi que de modes de gestion propres à préserver l'environnement. Ces transformations ne peuvent intervenir sans un changement de la volonté politique et de l'attitude au niveau des pays.*

## Introduction

*In ancient times people were few and wealthy and without strife. People at present think that five sons are not too many, and each son has five sons also, and before the death of the grandfather there are already 25 descendants. Therefore people are more and wealth is less, they work hard and receive little. The life of a nation depends upon people having enough food, not upon the number of people. Han Fei-Tzu, Chou dynasty, c. 500 BC (cited in Hicks, 1975).*

Agriculture accounts for a large share of Gross Domestic Product (GDP) and exports, and employs more than 70% of the work force in sub-Saharan Africa (SSA). The success or failure of agriculture therefore determines the economic growth of countries in that region, at least in the short term. Many African countries are unable to meet their target food requirements, provide other basic commodities and generate stable incomes because of rapid population growth and accelerated urbanisation. In less than 35 years the population of SSA will increase 2.6 times reaching 1294 million, a figure almost equal to China's projected population for 2025 (Winrock International, 1992). Social, economic and cultural determinants of fertility, mortality and migration are unlikely to change in the immediate future to reverse this trend in population growth.

Over the past 25 years, the numbers of all the major domestic animal species in SSA have also increased. Total tropical livestock units (TLUs) rose from 112 million in 1961–63 to 168 million in 1986–88, an average annual growth rate of 1.7% (Table 1). Some species and countries seem to show more rapid growth than others. The combined pressure of human and animal populations on natural resources may lead to excessive deforestation, loss of biological diversity, soil degradation and various forms of pollution and contamination (Table 2).

**Table 1.** *Livestock in sub-Saharan Africa—Tropical livestock units (TLU) by species, and growth rates, 1961–63 to 1986–88.*

	1961–63		1979–81		1986–88		Average %
	Million TLU	%	Million TLU	%	Million TLU	%	
Cattle	77.5	69.4	106.5	68.9	113.7	67.6	1.5
Sheep	7.8	7.0	11.3	7.3	12.4	7.4	1.9
Goats	9.9	8.8	13.2	8.5	14.5	8.6	1.6
Camels	7.9	7.1	11.6	7.5	13.2	7.8	2.1
Sub-total	103.1	92.3	142.6	92.2	153.8	91.4	1.6
Non-ruminants							
Poultry	2.4	2.2	4.8	3.1	5.9	3.5	3.6
Pigs	0.8	0.7	1.7	1.1	2.2	1.3	4.0
Horses	1.9	1.7	2.4	1.5	3.2	1.9	2.2
Mules	0.9	0.8	0.5	0.3	0.4	0.2	-3.4
Asses	2.5	2.3	2.6	1.7	2.8	1.7	0.4
Sub-total	8.6	7.7	12.0	7.8	14.5	8.6	2.1
Total	111.7		154.6		168.3		1.7

Source: Winrock International (1992).

**Table 2.** *Causative factors of human-induced soil degradation (million ha).*

	Deforestation	Over-exploitation	Over-grazing	Agric. activities
Africa	67	63	243	121
Asia	298	46	197	204
S. America	100	12	68	64
C. America	14	11	9	28
N. America	4	–	29	63
Europe	84	1	50	64
Oceania	12	–	83	8
World	579	133	679	552

Source: Oldeman et al (1990).

Ecological, economic and social imbalances affect both present and future generations. Therefore, the present living conditions of the African poor that compel them to endanger the natural resource base will have to be changed. New sustainable agricultural systems that not only support increased production but also conserve the natural resource base will have to be found. It is projected that the economies of SSA countries must expand by 4 to 5% annually to provide food security, more employment and better incomes (Winrock International, 1992).

Sub-Saharan African countries need to intensify agricultural production but they must avoid the problems of pollution and waste disposal that developed countries encountered in the process of intensification. The choice of production systems, technologies and policies for SSA will therefore have to be guided by knowledge of the potential of the resources at the farm, community, district and regional levels and the consequences of their misuse.

## Consequences of demographic growth

The consequences of rapid population growth in SSA cannot be fully assessed without projecting demographic trends and food demands. For example, annual meat and milk production will have to reach 19 and 43 million tonnes, respectively, to meet the demand in 2025. Demand for some other commodities in selected countries is shown in Table 3. Rapid population growth need not necessarily lead to falling per capita income although it is commonly argued that when labour force grows on fixed resources, the additional people will have fewer complementary resources to work with. Production per person therefore decreases and returns to labour diminish. In fact, population growth in 18<sup>th</sup> century Europe influenced higher labour productivity and economic growth, even where land seemed relatively scarce. Since other factors changed in that continent, technologies improved, new supplies and methods to re-use natural resources were found, better health, nutrition, education and training improved human skills and economies of scale in production and consumption rose. However, such changes are not occurring in Africa.

In SSA the productive population (15 to 64) was about 200 million in 1980 and is growing at a rate of about 3.2% annually. At the same rate of annual increase, by the year 2000 this population will have almost doubled to 378 million and could reach 700 million by 2020. Even under low population projections, the productive population would increase to slightly over 600 million in 2020 (World Bank, 1986). Estimates of the distribution of the human population in SSA by agro-ecological zones suggest that about 25% now live in the semi-arid zone, 25% in the subhumid zone, 20% in the humid zone, 15% in the highlands and about 10% in the arid zone (ILCA, 1987). Population is believed to be growing faster in the subhumid zone than in the arid, semi-arid or humid zones. Of the total population 5% are pastoralists, concentrated in the arid and semi-arid areas of East and West Africa.

The distribution of ruminant species is more strongly influenced by agro-ecological conditions than is the distribution of non-ruminants. The arid and semi-arid zones, which together make up 54% of the total land area of SSA, account for 57% of the ruminant livestock (including camels) measured as TLUs (Table 4; Winrock International, 1992). In contrast, the humid zone makes up 19% of the land mass, but accounts for only 6% of ruminant TLUs. The arid zone has the largest share of goats (38%) and sheep (34%). Most cattle are found in the semi-arid (31%) and the subhumid zones (23%).

In many SSA countries, rapid population growth combined with a poor initial socio-economic position inherited from colonial powers, and subsequent policy failures have culminated in the present state of decline in per capita income. Therefore, improving productivity at the farm level alone cannot absorb more people. Labour inputs will have to be complemented by policy changes and new investments in roads, seeds, fertilisers, disease eradication, irrigation etc. Without these complementary investments, much of the land will not be economically useful. In effect, the sub-Saharan African population is growing so fast that even investment in complementary resources comparable to that of developed countries during the past 50 years would only marginally improve living standards.

**Table 3.** Target demands (million tonnes) for selected food commodities and countries in West Africa for the years 2000 and 2025.

Countries	Cereals	Pulses	Roots	Sugar	Oils	Banana/ Plantain	Meat	Milk
2000								
Benin	0.9	0.1	2.2	0.0	0.2	0.02	0.03	0.1
Burkina Faso	2.1	0.3	0.2	0.1	0.1	0.0	0.1	0.3
Cameroon	1.7	0.2	3.7	0.2	0.3	1.4	0.1	0.2
Côte d'Ivoire	2.5	0.0	6.2	0.3	0.5	1.6	0.1	0.3
Ghana	1.7	0.0	6.2	0.1	0.2	1.2	0.1	0.1
Mali	2.1	0.1	0.2	0.1	0.1	0.0	0.2	0.4
Niger	3.0	0.5	0.2	0.1	0.1	–	0.2	0.4
Nigeria	19.0	1.4	55.4	1.8	2.5	2.7	0.8	2.1
Senegal	2.0	0.0	0.1	0.2	0.5	0.01	0.1	0.5
2025								
Benin	1.5 (77)	0.1 (77)	3.9 (77)	0.0 (75)	0.3 (77)	0.04 (77)	0.1 (77)	0.1 (76)
Burkina Faso	4.0 (91)	0.5 (91)	0.4 (91)	0.2 (90)	0.2 (90)	0.01 (100)	0.1 (91)	0.5 (90)
Cameroon	3.5 (102)	0.4 (102)	7.5 (102)	0.5 (102)	0.6 (102)	2.8 (102)	0.3 (103)	0.4 (102)
Côte d'Ivoire	5.2 (107)	0.03 (100)	12.9 (107)	0.6 (107)	1.0 (107)	3.4 (107)	0.2 (106)	0.6 (107)
Ghana	3.0 (76)	0.03 (74)	10.9 (76)	0.2 (76)	0.4 (77)	2.2 (77)	0.1 (77)	0.2 (76)
Mali	4.4 (105)	0.2 (105)	0.5 (105)	0.2 (107)	0.2 (105)	0.01 (75)	0.5 (106)	0.8 (106)
Niger	6.6 (121)	1.1 (121)	0.5 (121)	0.1 (122)	0.2 (116)	- 0.4 (120)	0.9 (121)	
Nigeria	34.6 (82)	2.6 (82)	101.1 (82)	3.3 (82)	4.6 (82)	4.9 (82)	1.4 (82)	3.8 (82)
Senegal	3.8 (91)	0.1 (89)	0.1 (91)	0.3 (63)	0.9 (91)	0.03 (93)	0.2 (91)	0.9 (91)

(Figures in parentheses indicate percentage increase over the year 2000).

Source: Fischer et al (1992).

## Demographic growth and systems of production

Inappropriate policies alone may not have caused agricultural growth to lag behind population growth. Land potential varies substantially among the different regions of SSA and population densities differ widely, depending on historical circumstances and local farming conditions. For example, at present Kenya, Malawi, Nigeria and to a lesser extent Senegal are experiencing substantial population pressure. As a result land area per person will decline sharply and cultivable land per person will be less than 1 ha (Figure 1). The extent to which rapid population growth exerts pressure on agricultural potential is determined both by the way land is used and by the inherent land potential itself. In many parts of SSA, traditional fallow-field rotation to restore fertility still predominates. Expanding the land

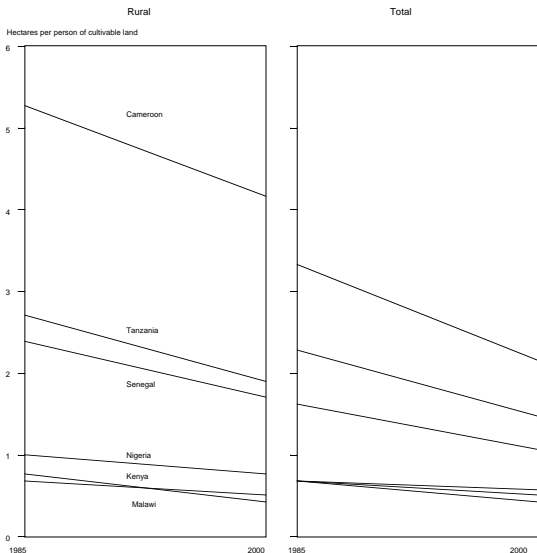
**Figure 1.** "Arable" land per capita in some African countries, rural and total populations, 1985 and 2000.

Source: Lele and Stone (1989).

area for cultivation means shortening fallow periods; the consequent decline in yields from the same land can only be avoided through improved cultivation methods, e.g. fertilisers or better tools.

Population densities are generally low to moderate in areas where forest fallows are common but tends to be higher in savannahs. Renewable resources — land, forests and fisheries — can be continuously used as long as extraction rates do not exceed the rate of (natural or managed) regeneration. The risk of overuse and permanent degradation is greater with a large and rapidly rising population. Population density is clearly the most significant factor influencing the extent of erosion in the peasant farming areas than in large-scale commercial farming areas of Zimbabwe (Table 5; Whitlow, 1988).

**Table 4.** *Distribution (%) of domestic ruminant livestock by agro-ecological zone and geographic region, sub-Saharan Africa.*

Location	Cattle	Sheep	Goats	Camels	All domestic ruminants
Agro-ecological zone					
Arid	20.7	33.7	38.2	100	29.8
Semi-arid	30.6	22.9	26.3	0	27.1
subhumid	22.7	14.4	16.5	0	19.6
Humid	6.1	8.3	9.4	0	6.1
Highland	19.9	20.8	9.6	0	17.4
Total	100.0	100.0	100.0	100	100.0
Geographic region					
West	24.8	34.2	42.3	15.2	26.3
Central	6.6	4.1	6.4	0.0	5.8
East	54.1	59.5	46.2	84.8	56.3
Southern	14.5	7.2	5.2	0.0	11.6
Total	100.0	100.0	100.0	100.0	100.0
Number, millions					
1979	144.5	98.4	122.6	11.1	137.3
1986-88 <sup>b</sup>	162.5	123.8	144.9	13.2	153.8

Source: Winrock International (1992).

**Table 5.** *Population density/mean erosion variations in Zimbabwe.*

Population density/km <sup>2</sup>	Communal lands	General lands	Zimbabwe
0	7.5 (1.2)	20.2 (1.0)	22.6
1-10	26.1 (4.5)	41.9 (1.8)	30.7
11-20	25.7 (7.3)	22.6 (2.0)	21.5
21-30	13.6 (10.9)	6.6 (2.2)	9.0
31-40	13.2 (12.8)	5.4 (2.5)	8.4
Over 40	13.9 (15.3)	3.3 (2.2)	7.8
Totals	100.0%	100.0 %	100.0 %

Source: Whitlow (1988).

The problem of land degradation may also be severe when resources are held in common, and traditional institutions have been rendered ineffective to control access and market mechanisms within the socially recognised boundaries. A particular case in point in SSA is the pastoral system that depends on access to common lands. Rapid increases of human and animal populations have contributed to a reduction in common grazing lands resulting in overgrazing and faster degradation of communal lands in some parts of the region.

Forests are declining in all of Africa's ecological regions except in forested mountain areas where reforestation programmes appear to be marginally off-setting the rate of extraction. As population increases more forests and woodlands are cleared for cultivation and to meet fuelwood demand especially around large urban cities. In Ethiopia, for example, the initial impetus to deforestation came from food requirements for expanding human and animal populations, but at present a major reason for it is to meet fuel requirements. Ethiopia is among the least energy-intensive economies of the world, and 90% of the energy used for household purposes is derived from fuelwood, charcoal, agricultural residues and dung (Biswas et al, 1987).

Deforestation can cause a reduction in soil fertility by increasing soil erosion and runoff. Trees are an integral part of nutrient cycling in any ecosystem and diversion of dung and crop residues for use as fuel when wood is scarce could seriously affect the balance of the nutrients required by the production systems.

The sharp increase in stock numbers coupled with prolonged drought reduced grassland productivity in the Sahel countries from the mid-1970s. The botanical composition of the herbaceous layer changed considerably from one year to the next depending on the rainfall. Biological recovery of herbaceous grasses and forbs is normally anticipated in the second or third year of normal weather after multi-annual drought. This, however, depends on the seed stock in the ground and the extent of human and animal pressure during the previous dry period. Denudation of rangelands surrounding regular watering points may develop even in normal years because of stock concentration (Le Houérou, 1989; ILCA, 1991).

## Demographic growth and the environment

People directly affect the environment by manipulating the soil surface and its plant cover. According to de Leeuw (1992), relative rates of impact are governed by two major interacting factors:

- population pressure expressed as the number of persons/km<sup>2</sup> within specified time frames (past, present and future)
- "resilience" of the local environment, approximated by land quality (rainfall, length of growing period (LGP), land forms, soils and vegetation).

A simple matrix of the causes and effects of population density and environmental resilience (as shown in Table 6) can be used to determine the agricultural production systems appropriate to given agroclimatic circumstances. For instance, the plant fraction removed by grazing increases with livestock density but is reduced by increased feed supplies per unit area. The proportion of rangelands within a target region is a function of rural population density and demand for arable land for cropping per inhabitant. Also, the potential of fire as a tool to reduce plant cover for animal feeding, fuelwood and timber extraction increases with longer LGPs and is inversely related to population density and to the intensity of past and current land use. Hence, single or combined pressures of both people and livestock on ecosystems with low resilience means that these systems are likely to suffer the greatest degradation.

Feed resources exceed livestock demand in many areas of SSA; animal agriculture may therefore not be the initial cause for degradation. Low biomass and high animal stocking rates and densities may predispose grazing lands to degradation. Such risks occur in the semi-arid zones of Nigeria, Cameroon, The Gambia, Ethiopia and Tanzania (20–35 cattle/km<sup>2</sup>) and in most of the East African highlands where cattle densities average about 40 head/km<sup>2</sup> but may rise to 85–105 head/km<sup>2</sup>, e.g. in Kenya and Uganda (de Leeuw, 1992). High livestock densities seem to be generally localised, due to seasonal feed availability and land use. They may occur in such areas as flood plains in the dry season, off-farm areas during growing seasons or when livestock are concentrated in a few areas as a precautionary measure to avoid disease etc.

**Table 6.** Sources of pressure and their impacts by agro-ecological zones in sub-Saharan Africa at two levels of populating density.

Zone	Semi-arid		Subhumid		Humid		Highlands <sup>1</sup>
	low	high	low	high	low	high	high
<b>Pressures</b>							
Grazing	XX	XXX	X	XX	X	X	XXX
Cropping	X	XX	X	XX	X	XX	XXX
Land clearing	XX	X	XX	X	XXX	X	X
Fuel extraction	X	XXX	X	XX	X	X	XX
Fires/burning	XX	X	XXX	XX	XX	X	
Timber extraction	X	XX	X	XX	XXX	X	X
<b>Impacts</b>							
Wind erosion	XXX	XXX	X	X	–	–	X
Water erosion	X	XX	X	XX	X	X	XXX
Soil fertility depletion	X	XX	X	XXX	XX	XX	XXX
Pollution of water sources	X	X	X	XX	X	X	XXX
Air pollution	XXX	XX	XX	X	XX	X	X

Importance ranking: XXX= major; X = minor.

Source: de Leeuw (1992).

## Soil degradation

Soil degradation is a formidable obstacle to development. The major causes of soil degradation are deforestation, water and wind erosion, salinisation, sodification, acidification, leaching, toxicity and physical and biological degradation. The final stage of a combination of various forms of soil degradation in any of the ecozones is desertification.

Land is the fundamental resource base for all types of agriculture and forestry. Sustainable agricultural production is dependent on soil and crop practices that conserve soil and water. Without these measures, rangelands and cultivated lands become degraded and their productive capacity is impaired. Erosion is most severe on slopes from which ground cover has been removed. For instance, soil loss during the peak of the rainy season from a traditionally cultivated maize field (20% slope) in the Ethiopian highlands was estimated to be 19.5 t/ha as opposed to 0.02 t from a pasture (21% slope) and a four-year-old Juniperus forest (65% slope) — a thousandfold difference between cropped and pasture and forest areas (Prinz, 1986). Restoring degraded lands may take decades, and for severely affected areas effective and economic methods of rebuilding their former productive capabilities are not even known. Soil is a living system. Its structure, composition and biological diversity must be understood and protected for agriculture to be productive and sustainable.

## Water and its quality

The importance of water as an agricultural resource cannot be overemphasised. In common with other natural resources, there seems to be a tendency to regard water as an infinite resource. If water waste and the severe ecological disturbances that can be caused by water (e.g. erosion, salinisation etc) are



to be prevented, research is urgently required to better understand and control the complex relations between water, soil and plants in many agro-ecological locations in SSA.

Fresh water is a very vital but limited resource. In SSA rain water is available for only part of the year and irrigation water is scarce. Soil may be considered as a bank in which water and essential crop nutrients are stored. Rain water can be harvested and held in tanks or earthworks while runoff can be restrained by maintaining ground cover, ridging and terracing hillsides. However, the way water is replenished, maintained, protected and controlled depends on soil conditions and demographic demands.

While most agriculture in SSA is sustained by direct rainfall, potentially rain water can be supplemented by irrigation from surface and ground water, i.e. from rivers, natural and man-made lakes, catchments and subterranean aquifers. At present, less than 5% of the land under cultivation in Africa is irrigated (FAO, 1992). Even though water is the limiting resource throughout the arid and semi-arid zones, surface water from lakes and such perennial rivers as the Zaire, Niger, Senegal, Limpopo and Zambezi is not used for crop irrigation as much as it could be. Sizeable aquifers in sedimentary basins and crystalline basements are believed to exist below near-arid regions. However, utilisation of transboundary rivers and water resources needs to be monitored and managed to the benefit of the regional environment and multistate economies.

Given Africa's population growth and uneven, and often uncertain, rainfall it is improbable that the continent can come close to food self-sufficiency without substantial investment in economically designed, efficiently managed irrigation.

At present, aquifers recharged by precipitation are overdrawn because of poor planning and management. Damage from siltation, salinity from irrigation schemes and contamination of ground and surface water by industrial effluent and agricultural chemicals are potential hazards to human health and food security and to aquatic resources and wildlife.

## **Atmosphere**

Land clearing is an agriculture-related activity that has probably made the largest contribution to the greenhouse gas build-up. Forest and crop residue burning is common in traditional farming, contributing substantial amounts of CO<sub>2</sub> annually. Rapid deforestation in the tropics may also be a significant source of increased N<sub>2</sub>O emissions from soils. The increasing concentrations of CO<sub>2</sub> and other "greenhouse gases" are expected to change temperature, rainfall and cloud patterns. In ecozones where ruminant livestock populations are low due to disease problems, subsistence farmers find it easier to burn crop residues after each harvest than to incorporate them into the soil with their simple tools. Burning communal lands in the subhumid and drier zones is also common in Africa.

Cattle contribute 57% of the global methane (Burke and Lashof, 1990). Methane emission from livestock is affected by differences in feed quantity and quality, body weight, age, energy expenditure and enteric ecology. Increased use of draft animal power and highly productive dairy animals to support growing peri-urban milk demand in SSA are potential sources of methane.

## **Environment-related health problems**

Infectious diseases cause one-third of all deaths globally (UNEP, 1991). These diseases affect the agricultural labour force and output. In developing countries the higher prevalence of metazoan, protozoan, bacterial and viral diseases is linked to malnutrition, inadequate water supply and poor sanitation and hygiene as a result of overcrowded living conditions. There is a growing concern that a significant proportion of cardiovascular diseases and cancers are directly or indirectly caused by environmental factors. Environmental risk factors include exposure to ionising radiation and carcinogenic chemicals in the air, food and water.

## **Demography and agricultural intensification**

The scope for production increases within traditional systems diminishes as land reserves are exhausted and yields per hectare stagnate at a low level. Farmers' needs are generally satisfied by constant or increasing returns to increasing labour inputs, as they change from shifting cultivation to fallow-farming to exploit the naturally regenerated soil fertility. If the rising population continues to use traditional practices to intensify land-use, returns to labour will decrease. Over time, this "involution" will create smaller farms, featuring higher-yielding low-quality tubers as the principal crops and poorly nourished and disease-prone people, with no space for expansion (Ruthenberg, 1983).

Involution can also affect livestock. Encroachment of arable farming on traditional grazing land, without alternative sources of natural or sown feed, could increase the number of poorly fed livestock, unless they are integrated into mixed farming systems.

Land-use systems in SSA are at different stages of the agricultural "evolution–involution syndrome". Many areas have reached the "low-level equilibrium trap" as a result of rapid population growth and poor economies. Except for out-migration, increasing per-hectare and per-animal productivity by introducing yield-increasing and environmentally sustainable production innovations seems to be the only way out for many SSA countries.

## **Sustainability and production systems**

Sustainable systems of agriculture and food security have now become major international concerns. Industrialised and relatively prosperous countries subsidised agrochemical use for many years to intensify agricultural production. This practice has contributed to the present levels of environmental pollution. In these countries, survival of people is not at risk if more food and fibre are not produced. The urgency, therefore, is not for technologies to increase production but for those that will disrupt the environment and natural resources less. In contrast, poorer nations in SSA will have to produce more to satisfy their fast-growing populations.

Sustainable systems are specific to location and agro-ecological and socio-ecological situation and are therefore different for developing and developed nations. Farmers in SSA need more sophisticated technologies than the low-input technologies they already have to meet changing demands.

Food security does not mean equipping farmers with resources to ensure subsistence from their land. As more people move into urban areas, they depend on the rural farmer for their food supplies. Agricultural production in the African countries will therefore have to be integrated with economic and efficient systems of preservation, processing and distribution.

## **Agricultural intensification**

Intensification is an alternative to expanded cultivation of marginally productive lands that may be vulnerable to degradation. Livestock seem to provide opportunities for using labour that is not required for other farming operations. A number of studies reveal that farmers engaged in mixed crop–livestock production earn half or more of their cash income from animal products (ILCA, 1987). Gryseels (1988) reports that livestock provide a dominant part of the cash income and gross margin in smallholder cereal–livestock farms in the Ethiopian highlands.

According to McIntire et al (1992), livestock are introduced into farming systems when population pressure causes the expansion of land for cultivation and reduces fallow and pasture to the point where farmers seek substitutes to maintain soil fertility. As population increases further, farmers shift from paddocking to systems of collection, processing and incorporating manure on crops. Herders depend more on crop residues as a source of feed, and they also begin to grow crops. The next step is a shift from livestock systems that are based on field grazing of crop residues and pastures to systems in which animals are confined and residues are harvested and preserved. This results in more intensive use of both the residues and animal wastes. Finally, manual labour is replaced by animal traction and

mechanisation which become economical because of the high intensity of land use that has been achieved.

### Agricultural intensification — Implication for ecozones

Possible paths to agricultural intensification in the major ecozones of sub-Saharan Africa are given in Table 7. There are still large areas of thinly settled land in the subhumid zone (SHZ) where human population density is lower than in the arid and semi-arid zones because of human disease pressure. Livestock density is also low, primarily because of trypanosomiasis, but the situation is changing rapidly. In West Africa, pastoralists from the north are moving into the subhumid zone, as are coastal peoples from the south. Population increases and the associated cultivation are altering the zone's ecology, reducing the tsetse population and trypanosomiasis pressure.

**Table 7.** *Agricultural intensification to mixed crop and livestock systems by major climate and length of growing-period zone in SSA.*

Length of growing period (days)	Principal crops	Crop-livestock systems					
		Traditional	Cattle	Small ruminants	Potential livestock enterprise	Crops (ha)	TLU
365 <sup>+</sup> (N) <sup>1</sup> humid	Cassava/maize/ banana/rice/ groundnut/ beans/oilpalms	Farmers and agropastoralists (trypanotolerant small and large ruminants)	X	XX	Peri-urban dairy	2-5	1-2
270-365 <sup>+</sup> days (N) humid	Cassava/maize/ rice/groundnut/ banana/oilpalm						
180-269 days (N) subhumid	Maize/millet/ groundnut/ cassava/beans/ rice/sorghum	Agro-pastoralists transhumance	XX	X	Dairy Animal traction mixed agriculture	2-5	20-100
75-179 days (N) arid/semi-arid/ subhumid	Millet/banana/ beans/maize	Transhumance	XXX	X	Ranching	10-15	30-80
1-74 days (N) arid	Sorghum/ millet/beans	Nomadism	XXX	XX	Production of young animals	5-10	5-10
Cool tropics (Highlands)	Teff/wheat/ oats/maize/ pulses	Sedentary	XXX	XX	Dairy mixed agriculture	1-5	1-8

X = Less important; XXX = Very important.

Adapted from Mohamed-Saleem and Fisher (1993).

As the human population density in the subhumid zone increases, land scarcity (particularly in the most desirable areas) is increasing friction between livestock grazers and crop farmers. Conflicts over use of crop residues, fallow land, access to dry-season forages and to water are accentuated by the influx of migrants who lack rights to the land.

Arid zones, which receive 0–500 mm rainfall annually, cannot support cropping except in land depressions which tend to be moist for a longer period during the year. Recent releases of early maturing crop varieties have made cropping more reliable in the semi-arid zones of SSA. With increasing population, it is likely that large communal rangelands may be brought under cultivation. Farm-power requirements for tilling after harvest and nutrient replenishment will encourage mixed crop–livestock systems in this zone.

Population growth in the humid zone has caused serious deforestation. As deforestation is ecologically undesirable productivity increases only in already cleared areas need to be encouraged. Coastal cities that have already absorbed large numbers of people migrating from rural areas will be both a market opportunity and a threat to environmental safety.

Highlands are already overpopulated with people and livestock and mixed crop–livestock intensification is fully developed. Land degradation and loss of productivity in the more fertile lower parts of the highlands have forced cultivation and grazing to move further up to the steeper and more fragile slopes. Work oxen provide farm power and manure is seldom used to fertilise crop fields since it is used as cooking fuel.

## **Demographic challenges and prospects for change**

Sub-Saharan Africa's ability to generate and apply modern agricultural technology at a level sufficient to meet its food requirements into the 21<sup>st</sup> century, merits the attention of both national governments and the international community.

The technical problems limiting agricultural production should be grouped by ecological zone because they cut across national borders. Most nations of West Africa include areas in at least two zones. There is also a great diversity of ethnic and cultural groups and traditions between and within the populations of the countries of the region. It is therefore more cost effective to implement agricultural and resource-management strategies by joint priority setting, especially given the resource limitations in the region.

More research is required to develop strategies that will enable a shift to practices that conserve land and are capable of generating employment opportunities.

Setting priorities to reverse the negative consequences of rapid population growth in SSA should take into account the natural resources and human and livestock populations, the complexity of the farming systems and their potentials for and constraints to development. While commercial agriculture may be highly commodity specialised, smallholder farming is not and smallholders are the majority of the farming population in the region. New strategies should therefore involve intensification of agriculture, integration of crop and livestock production, investments in technology generation and transfer, infrastructure and inputs, and the formulation of relevant policies.

## **Productivity improvement of crops**

Plants are adapted to a wide range of agro-ecological conditions. Sustainable production systems depend on crop types that thrive in particular agro-environments. An efficient cropping system will gain maximum benefit from solar radiation, rainfall, soil nutrients and living organisms in various complementary and symbiotic ways.

However, stable plant genotypes adapted to different environments cannot be determined by short-term experiments. Like any other system that produces outputs agriculture requires a number of

inputs to sustain productivity. At the very least it is necessary to replace the nutrients removed by harvested crops. Even this basic requirement is not met in many African countries where current mineral fertiliser use is less than 10 kg of nutrients per hectare, implying net removal of nutrients by harvested crops. Much needs to be learnt about how to manage the infertile fragile soils and sensitive vegetation for maximum production. Methods to minimise nutrient losses by maintaining adequate soil protective cover, afforestation practices and recycling of nutrients removed in the non-useful aerial and sub-aerial crop components need to become common farming practice. Crop residue management, rotation and ley farming and techniques to maximise the recovery of plant nutrients from livestock in the crop–livestock systems are research examples in this direction. But how the research results can best be utilised by the small farmer is yet not clear.

### **Productivity improvement of livestock**

Besides providing farm power and manure, livestock make other contributions to the agricultural economy. They serve as a reserve, readily convertible to cash, to cushion farm enterprises against a changeable climate and unstable commodity prices. Livestock provide an outlet for damaged grains, root crops, and other crops that are not marketable or needed for human consumption. They are also a means of converting surplus food crops to high-value commodities, providing food grain producers with an alternative source of income. In addition, ruminants can utilise lignocellulosic biomass (which includes crop residues and by-products) that has little other value except as an addition to soil organic matter. The nutrients and value of these products would largely be lost if they were not consumed by livestock. Livestock thus serve to transform feeds into food and marketable products, adding value to farming enterprises, increasing income, and enhancing the biophysical and economic viability of agriculture.

It is estimated that feed energy supplies will be barely sufficient in SSA for the ruminant and equine populations of 245 million TLUs projected for 2025. Under normal weather conditions there may be sufficient biomass to carry about 270 million TLUs. However, the situation would be precarious during drought when, as estimated by Penning de Vries and Djiteye (1982), carrying capacities would decline to 42 ha/TLU in the very arid zone, 20 ha/TLU in the arid zone and 15 ha/TLU in the semi-arid zone. This would lower SSA's overall carrying capacity to about 205 million TLU, or 20% below the projected number. Forage production must therefore be significantly increased to support the targeted increase in ruminant production (Winrock International, 1992).

Protein supplies are in even shorter supply. Ruminant and equine populations in SSA will require 63 million tonnes of crude protein in 2025, but only 50 million tonnes will be available. The imbalance is, of course, much higher when seasonal variations in the protein supply from natural sources are considered. Also, assuming that 7% is the lowest protein content that will support both maintenance and minimal production, ruminants in all the zones dependent on natural pastures will suffer serious protein deficiencies, except for a few months in the rainy season. Over the last few years there has been a concerted effort to screen forage legumes in SSA through IARC and NARS collaborations. Efforts by the Alley Farming Network (AFNETA), the African Feed Resources Network (AFRNET) and the Agroforestry Research Network (AFRENA) have raised hopes that herbaceous and tree legume species could be integrated into farming systems to improve soil fertility maintenance and animal production.

Research is needed to increase the understanding of the interactive effects of grazing, weather and fire on extensively used rangelands. Information is needed on the influences of biotic and abiotic factors on the control of rangeland vegetation and ecology and how management affects vegetative changes. It is also important to understand the dynamics of non-equilibrium systems and, how management of these systems differs from the traditional equilibrium systems upon which most range management strategies are based. Much can be learned about range management by further study of successful pastoral systems.

The greatest opportunity for expanding agricultural production in SSA lies in the medium-rainfall region (the subhumid zone and the adjoining higher rainfall areas of the semi-arid zone), where the annual rainfall is 750 to 1500 millimetres. The potential of this region for producing grain, root and oilseed crops, and pastures, forages and multi-purpose trees for livestock is substantially underexploited.

High-priority needs include the development (through farming systems research) of technology packages designed to enhance the productivity of mixed crop–livestock systems in different agro-ecological zones and markets, and with different cropping patterns and production practices. Improved technologies will involve upgraded varieties of food and feed crops, forages, legumes and tree crops as well as improved genetic stocks of indigenous cattle, sheep and goats. Improved strategies for transferring these technologies and more effective extension services are also needed.

Development strategies that aim to raise the productivity of specific mixed crop–livestock systems must carefully consider the nature and stage of crop–livestock interactions in the target area, availability of technology to improve productivity, availability and cost of inputs and whether or not policies favour mixed crop–livestock farming. No single set of actions is applicable to all situations.

Research on livestock management, organised around production systems, is needed to define the most productive management strategies under varying agroclimates, available technologies, feeds, inputs, and market demand. It is closely allied with farming systems research and will be generally site specific. As agricultural intensification in SSA increasingly moves towards mixed crop–livestock production systems, livestock will be particularly predisposed to soil-borne bacterial diseases (such as anthrax), infectious reproductive tract diseases (such as brucellosis), diarrhoeas and pneumonias of the newborn, mastitis, sheep and goat pox, Newcastle disease, internal parasites and mineral deficiencies even though some major diseases such as rinderpest and trypanosomiasis are controlled using chemotherapeutic agents or genetic resistance. Effective surveillance and control measures are needed to prevent losses from most of the diseases of intensification (Winrock International, 1992).

## **Policy changes**

Ecological factors such as population, climate, soils and water are ineffectively used in overall national land-use planning. Technical factors should interact with government policies, as well as farmer initiatives and strategies if new land systems are to succeed. Donor investment and aid conditions are also becoming important factors influencing policy changes.

Government agencies are faced with problems when implementing land-use practices as there are inconsistencies between national policies and farmers' objectives. Frequently the unfavourable reaction of farmers to government policies is explained as "ignorance" rather than inadequate understanding by the government of the concerns behind farmers' land-use decisions. A farming systems approach makes it possible to understand the rationale behind the farmers' decision-making, and to guide government policies.

## **Policies for communal rangelands**

In sub-Saharan African rangelands the number of animals which a herd owner can accumulate is constrained only by the availability of labour. According to Mascarenhas et al (1986) two factors seem important to pastoral economies. One, households must ensure that their herd size is above the minimum number of animals needed to safeguard economic viability. The other is the ecological carrying capacity and the actual aggregate stocking rate on the communal land surrounding the croplands. With a growing population consisting of a multitude of independent households, each trying to convert as much communal wealth (pasture) into individual wealth (animals) as possible, overstocking may become common unless other processes intervene. Relief work, better human and animal disease treatments and other government and non-governmental assistance in many countries have all encouraged stock build-up and overstocking in the rangelands.

African pastoralists are helpless and lack the ability to rapidly adjust to oscillations of short- and long-term rangeland productivity. They have therefore adapted "opportunistic management" of the rangelands featuring high stocking rates and migratory forage exploitation. Given the erratic rainfall patterns, particularly in the arid and semi-arid ecozones, opportunistic management is probably very efficient. Outright changes to this type of management may therefore not be advisable and blanket recommendations for all rangeland types may be inapplicable. The well known improvements in the pastoral sector such as watering points, dams, veterinary services, improved marketing facilities etc have not been able to solve the basic problem of the constantly increasing number of herds. Appropriate marketing strategies that will cater for or absorb the sudden surplus of animals during bad years may help, as it will provide some redress for the losses to the pastoralists.

The apparently conflicting land-use management practices in cropping and grazing lands and forest reserves need to be resolved by better land adjudication that allows safeguards to practise a land-use type. Given the variations in the natural and social environment, any framework developed for land adjudication in SSA must be flexible and allow for variations in tenure, including provision that it will not be a hinderance to livestock mobility. Research on means to prevent expansion of cultivation in the rangelands is also needed.

### **Policies for forest reserves**

The forest services in many countries in SSA have not evolved concrete land-use programmes to justify keeping large areas of land under forests. Hence, forests have always been viewed as potential agricultural land and farmers do not hesitate to clear a site for cropping if need be.

Policies embodying options such as regulatory control incentives by subsidies for afforestation or forest protection, taxation disincentives, property rights regulations which define liability and penalty for damage to forests and land-based resources need to be strengthened.

### **Policies to arrest land degradation**

Few governments in SSA have laws to prohibit degradation and destruction of arable land by urban and industrial spread and other non-agricultural uses. Industrial and urban developers can often reap higher returns from good land than farmers. Consequently, farmers sell their land and realise greater immediate profit than if they cultivate it. Since the area of arable land is much smaller than that of land that cannot be cultivated there needs to be a policy to encourage the use of the poor land for urban and industrial exploitation and to protect and preserve arable land for agriculture.

In high-income countries, measures to control soil degradation are embedded in the development process. However, African countries have yet to recognise soil degradation as a major threat to human existence in large parts of their national territories.

Techniques to prevent and cure soil degradation are known. In most situations of SSA, application of this knowledge has not been effective because there is no combination of technology, organisation and more importantly, structural measures. Therefore, soil degradation and the recovery of soil resources should become a political issue so that legal, organisational, educational and technological aspects can be properly co-ordinated.

Under suitable conditions and good management, irrigation can play a significant role to intensify and stabilise agricultural production and in reducing adverse impacts of droughts and facilitating rural development. Legislation and agreements are, however, needed at the country and regional levels to monitor the flow and extraction rates from transboundary resources such as rivers, reservoirs etc. The increasing population is placing an unprecedented demand on water resources. Large differences in water-use priorities in countries sharing the resource necessitate the establishment of a complex management and cooperation mechanism.

## **Policies to aid agricultural intensification**

Agricultural intensification occurs naturally in SSA. Transition from crop and livestock agriculture to mixed crop–livestock farming needs to have new technologies and policies to be capable of maintaining and preserving resources. Autonomous intensification as a result of population growth is by itself unlikely to achieve the expected gains in per capita agricultural production and rural income (Lele and Stone, 1989). Strategies are also needed to assist the shift to high yielding and higher value crops and more productive land and to resolve the land tenure problems facing the areas in SSA where mixed crop–livestock systems are evolving.

Spatial implications of agricultural practices have been inadvertently ignored in the past. There is a need for better co-ordination to understand the long-term effects of agricultural practices. Socio-economic and biophysical indicators are therefore needed to guide the policy and management activities to optimise, on a sustainable basis, the goods and services from an agro-ecosystem.

## **Sub-Saharan Africa: Beyond the year 2000**

Population growth in sub-Saharan Africa is not expected to stabilise until 2050. By that time 1.7 billion people will have to be supported on the same resource base. How this stability will be reached cannot be ascertained. To what extent the natural resource base could contribute to national development depends on its sustainable potential.

Sub-Saharan Africa is a mosaic of soils, climate, different lengths of growing period (LGPs), crops, animals, people and civilisations. These differences enable subdivisions of the resource base into:

- low-potential areas vulnerable to faster land degradation
- high-potential areas for continuous use with relatively low risk of degradation
- protected areas, like forests, that are genetic reserves.

Vulnerable and low potential areas are unfavourable for accelerated agricultural development.

In SSA, human population density and distribution do not correspond to the land potential. For instance, low potential Sahel areas account for approximately 10% of the population and over 50% of the land area. Political boundaries do not follow land potential either. Hence, resources in some countries are inadequate to support the growing populations at the level of existing technologies.

The greatest impact of the rapid population growth in the immediate future is expected to be on agricultural resources. Marginal lands, normally avoided because of low fertility are increasingly brought under cultivation as yields decline on more suitable lands. Crop yields therefore have to be improved, but the cost of fossil energy based yield-increasing technologies are prohibitive to SSA farmers.

Development in SSA has to be rapid and sustainable and must guarantee the well being of all people. This demands that each member of the society be given access to both resources and the required services. This will mean a reassessment of the present access to and control of wealth.

Wherever agricultural intensification has taken place in SSA, especially in areas favourable for cattle, mixed farming has developed. The intensification process has been facilitated by land ownership. Livestock seem to be a viable means of replacing manual labour, replenishing soil fertility and providing cash income for other household needs.

Productivity assessments have indicated that sub-Saharan African needs for the growing population can be met from available resources if land productivity can be increased. The potential yields of some land types can be much higher than the current average, but the prevailing prices and marketing strategies in some countries are disincentives for farmers to venture into new forms of land development.



Sub-Saharan Africa is ecologically diverse. Very few plants and animals are known and domesticated. There may be many wild species that are biologically more efficient than domestic species and these have to be located, adapted and sustained.

The capacity to improvise, imitate and invent has served the human race whenever the need arose. So far Africans have been improvising and emulating others. However, many nations now appreciate the urgency for invention of new methods to utilise available resources. The countries also recognise the importance of regional cooperation for managing the renewable resources. There is therefore a need for political change and cultural adjustments to provide equity and sustenance to all parts of the region.

## References

- Biswas A K, Masakhalia Y F O, Odera-Ogwel L A and Pallangyo E P. 1987. Land use and farming systems in the horn of Africa. *Land Use Policy* 4:419–443.
- Burke L M and Lashof D A. 1990. Greenhouse gas emissions related to agriculture and land use practices. In: *Impact of carbon dioxide, trace gases and climate change on global agriculture*. ASA Special Publication 53. ASA (American Society of Agronomy), Madison, Wisconsin, USA. pp. 27–43.
- FAO (Food and Agricultural Organization of the United Nations). 1992. *Sustainable development and the environment. FAO policies and actions. Stockholm 1972 – Rio 1992*. FAO, Rome, Italy. 88 pp.
- Fisher G W, Shah M M, Mohamed-Saleem M A and von Kaufmann R. 1992. *Potential for forage legumes and relevance to food and livestock production in West Africa*. Vol. 1. IIASA/ILCA.
- Gryseels G. 1988. *Role of livestock on mixed smallholder farms in the Ethiopian highlands: A case study from the Baso and Worena wereda near Debre Berhan*. PhD dissertation, Agricultural University, Wageningen, The Netherlands. 249 pp.
- Hicks C S. 1975. *Man and natural resources: An agricultural perspective*. Croom Helm, London, UK. 120 pp.
- ILCA (International Livestock Centre for Africa). 1987. *ILCA's strategy and long-term plan*. ILCA, Addis Ababa, Ethiopia. 99 pp.
- ILCA (International Livestock Centre for Africa). 1991. *ILCA 1990: Annual Report and Programme Highlights*. ILCA, Addis Ababa, Ethiopia. 81 pp.
- Le Houérou H N. 1989. *The grazing land ecosystem of the African Sahel*. Ecological Studies 75. Springer-Verlag, Berlin, Germany. 282 pp.
- de Leeuw P N. 1992. Potential environmental impacts. In: ILCA (ed), *Potential for impact: ILCA looks to the future*. Working Paper 2. ILCA (International Livestock Centre for Africa), Addis Ababa, Ethiopia. pp. 11–26.
- Lele U J and Stone S W. 1989. *Population pressure, the environment and agricultural intensification: Variations on the Boserup hypothesis*. MADIA Paper 4. The World Bank, Washington, DC, USA.
- Mascarenhas A, Odera-Ogwel L A, Masakhalia Y F O and Biswas A K. 1986. Land use policies and farming systems. Kenya, Tanzania, Zambia and Mozambique. *Land Use Policy* 3:287–305.
- McIntire J, Bourzat D and Pingali P. 1992. *Crop-livestock interaction in sub-Saharan Africa*. World Bank Regional and Sectoral Studies. The World Bank, Washington, DC, USA. 246 pp.
- Mohamed-Saleem M A and Fisher M J. 1993. Role of ley farming in crop rotations in the tropics. In: *Proceedings of the XVII International Grassland Congress held in Rockhampton, Australia, 18–21 February 1993*. Vol. III. New Zealand Grassland Association, New Zealand. pp. 2179–2187.
- Oldeman L R, Hakkeling R T A and Sombroek W G. 1990. *World map of the status of human-induced soil degradation. An explanatory note*. International Soil Reference and Information Centre, Wageningen, The Netherlands.
- Penning de Vries F W T and Djiteye M A (eds). 1982. *La productivité de pâturages sahéliens – Une étude des sols, des végétations et de l'exploitation de cette ressource naturelle*. PUDOC, Wageningen, The Netherlands. 525 pp.

- Prinz D. 1986. Cropping techniques in the tropics for soil conservation and soil improvement. *Quarterly Journal of International Agriculture* 25:86–89.
- Rutherberg H. 1983. *Farming systems in the tropics*. Clarendon Press, Oxford, UK. 424 pp.
- UNEP (United Nations Environment Programme). 1991. *Environmental data report*. Third edition. Basil Blackwell, Oxford, UK.
- Whitlow R. 1988. Soil erosion and conservation policy in Zimbabwe. Past, present and future. *Land Use Policy* 5(4):419–433.
- Winrock International. 1992. *Assessment of animal agriculture in sub-Saharan Africa*. Winrock International Institute for Agricultural Development, Morrilton, Arkansas, USA. 125 pp.

# **An overview of mixed farming systems in sub-Saharan Africa**

*J.M. Powell<sup>1</sup> and T.O. Williams<sup>2</sup>*

1. 458 Glenway Street, Madison WI 53711, USA (formerly with ILCA)
2. International Livestock Centre for Africa (ILCA) Semi-arid Zone Programme  
ICRISAT Sahelian Center, BP 12404, Niamey, Niger

## **Abstract**

Mixed farming systems, involving complementary interactions between crops and livestock such as using animal traction and manure for cropping and feeding crop residues to livestock, are increasing in importance in sub-Saharan Africa (SSA). Traditional specialised production systems of shifting cultivation and nomadism are being replaced by more sedentary forms of crop and livestock production that involve permanent cultivation and reduced grazing. The full integration of crop and livestock production into the same unit is an evolutionary process mediated principally by regional differences in climate, population densities, disease, economic opportunities and cultural preferences. Mixed farming is well developed in the highlands of SSA and poorly developed in the humid zone due to pests and diseases, and in the arid zone due to lack of cropping. The greatest potential opportunity for increasing agricultural productivity exists through mixed farming in the subhumid and wetter parts of the semi-arid zone of SSA. This paper provides an overview of mixed farming systems in SSA by first examining their evolution and current distribution by agro-ecological zone. It examines socio-economic constraints to crop–livestock integration, animal feed issues and the use of animal manure in intensively and extensively managed mixed farming systems and ends with a synopsis of strategies for attaining sustainable improvements in crop and livestock production.

## **Synthèse des recherches sur les systèmes agricoles mixtes en Afrique subsaharienne**

*J.M. Powell<sup>1</sup> et T.O. Williams<sup>2</sup>*

1. 458 Glenway Street, Madison WI 53711 (E.-U.) (précédemment en service au CIPEA)
2. Centre international pour l'élevage en Afrique (CIPEA), Programme de la zone semi-aride  
Centre sahélien de l'ICRISAT, B.P. 12404, Niamey (Niger)

## **Résumé**

*Les systèmes agricoles mixtes, avec les interactions complémentaires entre les cultures et le bétail comme par exemple l'utilisation de la traction animale et du fumier dans l'agriculture et l'alimentation des animaux avec des résidus de récolte, ne cessent de gagner du terrain en Afrique de l'Ouest. Les systèmes traditionnels de production caractérisés par les cultures itinérantes et le nomadisme reculent progressivement au profit de formes plus sédentaires d'agriculture et d'élevage caractérisées par des cultures permanentes et une baisse de l'utilisation des pâturages. L'intégration de l'agriculture et de l'élevage au sein d'une même unité est un processus dynamique qui dépend essentiellement des différences climatiques entre les régions, des densités de population, des types de maladies rencontrées, des opportunités économiques et des préférences culturelles. Les systèmes agricoles mixtes sont très développés dans les hauts plateaux d'Afrique subsaharienne, mais moins développés dans les zones humide et aride en raison respectivement des maladies et de la rareté des cultures. Les systèmes mixtes offrent les meilleures chances possibles d'accroître la productivité agricole et ce,*

*dans la zone subhumide et les régions les plus arrosées de la zone semi-aride. Cet article présente un aperçu des systèmes agricoles mixtes en Afrique subsaharienne. Il examine d'abord leur évolution et leur répartition par zone agro-écologique, puis les obstacles socio-économiques à l'intégration de l'agriculture et de l'élevage, les problèmes de l'alimentation du bétail et de l'utilisation du fumier dans les systèmes mixtes intensifs ou extensifs. Il se termine par un tableau synoptique des stratégies propres à promouvoir une amélioration durable de la productivité des cultures et du bétail.*

## **Introduction**

Cattle, sheep and goats represent over 90% of all domestic ruminant livestock in sub-Saharan Africa (Winrock International, 1992). The association of livestock husbandry with cropping benefits both enterprises. Crop residues are important animal feeds while animals provide manure and draft power for cropping. Animals also provide meat and milk for households and cash income for farmers that can be invested in crop production. They are a means of storing capital, buffering food shortages in years of poor crop production and meeting social and religious obligations of farmers.

Traditionally in sub-Sahara Africa (SSA), crops and livestock have been operationally separated but functionally linked enterprises. The exchanges between sedentary crop farmers and migratory pastoralists of grain, crop residues and water for manure have linked crop and livestock production for years in many regions (van Raay, 1975; McCown et al, 1979; Toulmin, 1983; Powell, 1986; Mortimore, 1991). But these specialised forms of crop and livestock production by different ethnic groups are under transition. Increasing human populations combined with long-term weather changes are transforming the specialised systems, based on extensive shifting cultivation and grazing, to more intensively managed enterprises. The transformation from specialised to integrated systems is a dynamic and evolutionary process. As livestock husbandry becomes more settled it increasingly incorporates crop production while the specialised, extensive cropping system integrates animals. In the process, many of the traditional exchange relationships between pastoralists and crop farmers are disappearing. Although many crop–livestock interactions continue to be mediated by barter and market transactions between separate crop and livestock producers, they increasingly occur within closely integrated mixed farms.

For the purpose of this review, mixed farming is the cultivation of crops and the raising of cattle, sheep and/or goats by the same economic entity, such as a household or a 'concession', with animal inputs (e.g. manure, draft power) being used in crop production and crop inputs (e.g. residues, fodder) being used in livestock production. Although manure use is an important component of mixed farms in SSA, it is only one of various benefits accruing from the integration of crops and livestock. The benefits of mixed farming depends not only on the demands for manure to enhance soil fertility but also on the need for, and benefits gained from animal power, crop-residue feeding and farm diversification.

This paper provides an overview of mixed farming systems in SSA. While mixed farming is just one form of crop and livestock production, it occupies an important phase in the evolution of agricultural intensification. The first part of the paper reviews the evolution of specialised and mixed farming systems and their distribution across the agro-ecological zones of SSA. It then proceeds to describe various socio-economic constraints to crop–livestock integration and the biophysical interactions, specifically feed and manure linkages, between crops and livestock on mixed farms. The paper concludes by discussing strategies for attaining long-term gains in crop and livestock production from mixed farming systems in SSA.

## **Evolution of mixed farming systems**

Interactions between crop and livestock enterprises evolve through four stages in the process of agricultural and overall economic development: (1) pre-intensification phase where crop production and livestock husbandry are operationally separate enterprises; (2) intensification phase where crop

and livestock production integrate mostly through animal draft power and manure linkages; (3) income diversification phase when investments are made to improve forage supply and quality; and (4) a return to specialisation through commercialisation (Table 1; Pingali, 1993). The driving force in moving from specialisation to integration and back to specialisation is the opportunity costs of land, labour and urban income growth (McIntire et al, 1992; Pingali, 1993).

**Table 1.** *Evolution of mixed farming systems in SSA.*

	Phases in evolution of mixed farming systems <sup>1</sup>			
	I	II	III	IV
Determinants of mixed farming evolution				
Population density	Low	High	High	High
Transport infrastructure	Low	Low/Moderate	Moderate	High
Urbanisation	Low	Low/Moderate	Moderate	High
Production methods				
Power source	Human	Animal	Motor	Motor
Soil fertility	Fallows	Manure	Fertilisers	Fertilisers
Animal feed	Natural pastures	Crop residues and pastures	Crop residues and pastures	Improved pastures and purchased feed

1. (I) Pre-intensification phase when crops and livestock are independent activities; (II) Intensification phase when crop–livestock integration occurs; (III) Income diversification phase; and (IV) Specialisation phase.

Source: Adapted from Pingali (1993).

The evolution of mixed farming systems is viewed by other researchers as a meaningful model for developing a taxonomy of mixed farming systems. Mortimore (1991) reviewed seven principles on which a typology of mixed farming systems may be based and concluded that farming intensity, as influenced by human population density, is the most useful typological principle for the purpose of understanding crop–livestock integration and its effect on the environment. At low population pressures and when only simple technologies (e.g. manual labour, no external inputs) are used for agricultural production, specialised and independent crop and livestock production systems are more attractive than integrated systems because land is abundant. Labour is the major constraint and its cost is high relative to land. Soil fertility is maintained through fallowing, which is preferred to manure because it requires less labour. Low inelastic demand for agricultural produce, due to low population growth and incomes, also ensures low demand for animal power and manure.

As population pressures rise, the demand for arable land increases. Because fallows occupy too high a proportion of the land, farmers look for alternatives to maintain soil fertility. During these initial stages of agricultural intensification, cropping and livestock husbandry remain separate enterprises and crop farmers make various arrangements with livestock owners to acquire manure. Manuring cropland is initiated through exchange contracts between farmers and pastoralists. The point at which integration replaces exchange depends on farming intensity, transaction costs, costs of other soil amendments (e.g. fertilisers) and other benefits derived from integration.

When new markets or technologies create opportunities for growth, more intensive agriculture is further stimulated. This usually involves the use of more manure, animal power and crop residue as feed per unit of land and output. Crop farmers begin to keep livestock for manure and traction, pastoralists settle to grow crops and integrated mixed farming systems are born.

The evolution to mixed farming can be problematic. For instance, as the pressure on land increases, herds are confined to smaller grazing areas during the cropping season to avoid crop damage. This may pose nutritional problems for livestock and increase the risk of overgrazing and environmental degradation. During the dry season, traditional grazing lands may become inaccessible when low-lying

areas are transformed into irrigated gardens. In many areas of SSA, crop damage by pastoralist herds has resulted in tragic ethnic conflicts. Yet, it is during this initial phase in the evolution of mixed farming that livestock depend on crop residues as feed, especially during long dry seasons when there are few alternatives. As animal pressures increase, free grazing gives way to the harvesting of grasses and crop residues which are bartered, sold or fed to the farmers' own livestock. Manure is used to fertilise the fields of the livestock owners. Further along the shift to intensive mixed farming, although not yet a widespread practice in SSA, is the growing of forage legumes specifically to increase livestock productivity with the additional benefits of increasing soil productivity and crop yields through nitrogen fixation and improved soil physical properties.

As markets continue to develop and technical changes increase, a movement away from integration and a return to specialisation may occur (McIntire et al, 1992). This occurs when market conditions and public policies result in fertilisers being used instead of manure, when tractors replace animal power and cultivated forages and diet supplements are used instead of crop residues. At this point, the economic incentive for a mixed farm enterprise to provide its own inputs diminishes and specialisation becomes more profitable.

## **Crop–livestock integration by agro-ecological zone**

People, cattle, sheep and goats are distinctly distributed across the five agro-ecological zones of sub-Saharan Africa (Table 2). The arid zone stands out for its high livestock per person ratio and low cropping potential. The semi-arid and humid zones have somewhat similar land areas and fairly similar rural population densities. The arid and semi-arid zones occupy 54% of the total land area and account for 57% of the cattle, sheep and goats in SSA. The highlands, comprising only 5% of the total land mass, are the most densely populated of all the agro-ecological zones both in terms of people and animals. The following discussion briefly examines the influence that population densities, animal disease, and economic conditions have had on the evolution of crop–livestock interactions and mixed farming systems in the five agro-ecological zones of SSA.

### **Arid zone**

Pure pastoralism, one of the few specialised forms of livestock husbandry still occurring in SSA, is practised in the arid zone and in the more arid parts of the semi-arid zone. Rangeland vegetation in these regions is of high quality and there is a low incidence of livestock pests and diseases. The survival of pastoralism depends on herd mobility to exploit seasonal water and forage supplies.

The arid zone does not support crop production to any extent (except in the favourable microclimates of oasis farming) so mixed farming and interactions between crops and livestock within the zone, by definition, are limited. Seasonal transhumance of livestock from the arid into the semi-arid and subhumid zones, however, does allow for interactions between pastoralists and crop farmers along livestock routes or at the dry season site. As the expansion of cropping reduces grazing lands in the semi-arid zone, animal movement becomes more restricted and the viability of pastoralism is reduced. An exception to this is in eastern Africa where pastoralists have their own land rights.

### **Semi-arid zone**

In most parts of the semi-arid zone, farmers own animals and pastoralists are increasingly growing crops. Crop residues provide a vital feed source during the 6- to 8-month dry season and animal manure enhances soil fertility for crop production. Manure is obtained either from one's own animals, from the livestock of other farmers or through exchange relationships with pastoralists. Although manuring contracts between farmers and pastoralists are still important in some areas (e.g. along trekking routes), farmers have developed a variety of ways to combine their own smaller herds in order to manure sizable areas of cropland.

**Table 2.** Demographic and agricultural characteristics of five agro-ecological zones in SSA.

	Zone				
	Arid	Semi-arid	Subhumid	Humid	Highlands
<b>Demographics</b>					
Area (% of total)	36	18	22	19	5
Rural population density (persons/km <sup>2</sup> )	–	14.6	23.0	13.3	71.1
<b>Livestock</b>					
Cattle, sheep and goats (head x 10 <sup>6</sup> )	116.7	101.7	67.0	28.6	62.3
Cattle (% of total)	27	45	49	31	46
Sheep (% of total)	32	23	21	28	34
Goats (% of total)	41	32	30	41	20
TLU/person	1.6	0.5	0.5	0.1	0.6
Traditional livestock husbandry	Transhumance	Transhumance Agropastoral	Transhumance Agropastoral	Sedentary	Sedentary
<b>Cropping</b>					
Annual rainfall (mm)	0–500	500–1000	1000–1500	>1500	1000–2000
Growing season (days)	<90	90–180	180–270	>270	<20°C <sup>1</sup>
Cultivated area <sup>2</sup> (ha/household)	n.a.	10–15	2–5	2–5	1–5
Main crops	n.a.	Millet sorghum cowpea groundnut	Sorghum maize rice groundnut	Maize cassava yam tree crops	Wheat teff barley sorghum potatoes
<b>Crop–livestock interactions</b>					
Animal power	n.a.	Little to moderate	Little to moderate and expanding	Little or none	Moderate to high
Manure use	n.a.	Little to moderate	Little to moderate	Little or none	Moderate to high
Crop residues	n.a.	Moderate to high	Little to moderate	Little or none	Little to moderate
Sown forages	n.a.	Little or none	Little but expanding	Little or none	Moderate to high

1. Mean daily temperature during growing period is <20°C.

2. Greater range found within some zones (e.g. Powell and Williams (1992) found 3–9 ha/household in semi-arid Niger).

Sources: Jahnke (1982); ILCA (1987); McIntire et al (1992).

Although crop–livestock interactions and mixed farming systems have long been well established in the semi-arid zone, these systems are continuously changing. The low and erratic rainfall and periodic drought in this zone can cause large fluctuations in livestock numbers and herd composition (Williams et al, this volume). Because the reproductive cycle of cattle makes herd reconstitution longer, many producers are shifting to sheep and goats when rebuilding their livestock after drought.

Livestock ownership patterns also continue to change. Increasingly the greater proportion of animals are being kept by sedentary agropastoralists, farmers, and absentee entrepreneurs rather than transhumant pastoralists (Toulmin, 1983; van Raay, 1975). Women are often the principal owners of sheep and goats (Taylor-Powell and Okali, unpublished). Little information is available on the relationships between animal ownership and manure use within the household.

### **Subhumid zone**

The subhumid zone has traditionally been used by pastoralists as a dry season grazing reserve. However, human and livestock numbers are increasing in this zone on a permanent basis due to the gradual reduction in tsetse fly populations, periodic droughts in the adjacent more arid areas, and population pressures in both the drier and more humid zones. Pastoralists and their livestock now reside year round within the zone (Bourn et al, 1986) and are successfully cropping (Powell and Taylor-Powell, 1984).

The subhumid zone holds the greatest opportunity for increasing agricultural productivity in SSA (Winrock International, 1992). Livestock production mostly takes place under mixed farming. Although various interactions exist between crop and livestock production in this zone, the integration is seldom complete. Rarely are the principal interactions of mixed farming that include animal power, manure, crop residues and sown forages integrated into the farming enterprise. Exceptions are found in parts of Mali, Senegal, Malawi and Zimbabwe where farm investments are associated with cash crops and livestock are an integral part of the production system.

In the subhumid zone, the expansion of cropping and reduction in fallowing raises the risk of environmental degradation (Ruthenberg, 1980). The soils of the region have been impoverished by the relatively high rainfall. The natural regeneration of dicotyledons or mixed grass vegetation is gradually being replaced by annual grasses which are less effective in soil-fertility regeneration and have poor feeding value. Legumes that provide dietary supplements for grazing animals and improve soil fertility have a high potential for increasing both crop and livestock production in this zone.

### **Humid zone**

Crop diversity is greatest in the humid zone. Farmers cultivate a wide range of cereal, legume, tuber and tree crops in very complex cropping patterns. However, trypanosomiasis and other diseases restrict livestock production in many parts of the zone. Where livestock production does occur it usually involves dwarf trypanotolerant small ruminants, especially goats. The clearing of forested lands for cropping decreases the tsetse challenge thereby making it possible to increase livestock integration in the production system.

Large human populations along the coast of West Africa create huge demands for livestock products. This in turn creates a high potential for greater crop–livestock integration, especially in terms of animal feeding. Although the abundant rainfall in the zone leads to the production of large amounts of feed, much of it is of poor quality. The nutrients taken up by forage grasses are diluted due to the vast quantities of biomass being produced. The nutrient requirements of crops and forages is, therefore, great in the humid zone.

### **Highlands**

Occupying only 5% of the total land area of SSA (Table 2), the highlands lie predominantly in East and southern Africa. These areas are characterised by high human and livestock population densities resulting in the development of well integrated mixed farming systems. Most farmers in this zone own and manage animals. Oxen are commonly used for draft power, particularly in Ethiopia and Madagascar. Farmers feed crop residues, sow fodder crops and recycle manure for soil fertility or fuel.



## **Feed/manure interactions in mixed farming systems**

The most important biological interactions between cropping and livestock in SSA are the use of animal traction and manures in cropping and the feeding of crop residues and other cropland forages to animals. Whereas forage and manure linkages are common to most mixed farming systems, animal traction is associated mainly with cash cropping, or is practised in high population density areas where markets are readily accessible (McIntire et al, 1992). The following discussion highlights key issues related to feed and manure linkages in the mixed farming systems of SSA.

### **Feeding livestock**

Feeding strategies can be classified into unrestricted grazing, stall feeding, semi-stall feeding and tethering systems. As more land is cultivated, grazing lands diminish. The shift from pasture to cropland has several consequences for feed availability and quality (Sandford, 1990). Not only is there a total reduction in the amount of pasture available, but pastures may become seasonally inaccessible due to fragmented cropping and/or the expansion of dry-season gardening in low-lying areas. This is common in West Africa where cropping is encroaching on traditional dry season pastures, jeopardising the livelihood of pastoralists (Traoré and Breman, 1992).

As livestock are confined to smaller grazing areas and tethering becomes necessary, the nutritional constraint facing livestock may shift from the dry to the wet season. The lack of wet-season feed, however, may be accompanied by an increase in the dry season feed supply. Croplands provide more feed of higher quality and animals perform better grazing crop residues than livestock grazing natural pastures (van Raay and de Leeuw, 1974).

Cereal stovers and other crop residues are vital livestock feeds during the dry season, especially in semi-arid environments (Sandford, 1990). In these drier areas, however, the competition for crop residues between livestock and soil conservation is most acute. High soil temperatures, wind erosion, and sand blasting of young plants pose severe limitations to crop establishment and production. When left in the field, cereal stovers provide a physical barrier to soil movement, allow soil and organic matter to accumulate and enhance soil chemical properties (Geiger et al, 1992) and crop yield (Bationo and Mokwunye, 1991). Returning crop residues to fields, however, is not a viable strategy for most mixed farmers in SSA given the lack of alternative feeds. In drier areas animals are kept to meet necessary household needs, including their consumption and sale during years of poor rainfall and crop production. Therefore, most biomass in these mixed farming systems is fed to animals. Only later does it become available as a soil amendment in the form of manure (and urine).

Under crop-residue grazing, animals remove greater amounts of biomass and nutrients than they return in the form of manure (Powell and Williams, 1993). This nutrient removal by livestock can be attributed to the spatial distribution of animal voidings in the landscape which are usually concentrated around watering points, resting areas and along paths of animal movement. However, excessive removal of biomass from cropland without adequate replenishment rapidly reduces soil-nutrient reserves. As a result, nutrient balances (inputs minus offtakes) have become negative for many farming systems in SSA (Stoorvogel and Smaling, 1990).

### **Manuring cropland**

Many mixed farming systems in SSA continue to rely on organic matter recycling for maintaining soil productivity. Livestock have long played a key role in this process. The cycling of biomass through animals into excreta (manure and urine) that fertilises the soil is an important linkage between livestock and soil productivity in many farming systems of SSA.

## **The livestock component**

The types and amount of animal-excreted nutrients available for recycling depend upon the types and numbers of animals kept by farmers, animal diet, watering regime, and the spatial and temporal distribution of livestock and their voidings in the landscape. For example, in semi-arid areas livestock population and species shifts can occur often due to weather changes. It is also clear that although cattle produce more manure than small ruminants, the nitrogen (N) and phosphorus (P) content of sheep, and especially of goat manure, is higher than that of cattle manure (Williams et al, this volume). Manure capture rates are very different in mixed farming systems based on extensive grazing versus intensive stall-feeding systems (Fernández-Rivera et al, this volume).

Affecting manure output is the wide fluctuation in feed availability and quality that characterise most grazing systems of SSA. Animals gain weight during the latter part of the rainy season and early part of the dry season when sufficient good quality pastures and crop residues are available. Animals lose weight during the latter part of the dry season and early wet season as grazing resources diminish. As a consequence of these variations in feed availability, manure output varies. The daily manure output of grazing cattle during the wet season can be twice the manure output during the dry season (Siebert et al, 1978; Omaliko, 1980). The nutrient content in the manure of grazing cattle is up to three times greater during the wet season and crop-residue grazing period than during the dry season (Powell, 1986).

Whereas N is voided in both urine and faeces, most P is voided in faeces (CAB, 1984; Ternouth, 1989). The proportion of N voided in faeces and urine and the susceptibility of N to losses in the environment, depends on animal diet. Highly digestible feeds, such as certain legumes and concentrates, pass quickly through ruminants and result in large N excretions in the form of urine. Animals that have diets of lower digestibility excrete relatively higher amounts of N in the form of manure. Urine-N can be readily volatilised and leached through the soil whereas manure-N decomposes slowly in soil and therefore is more available for recycling by plants.

## **Farmers' practices**

There are two principal methods of manuring cropland in SSA: farmers either corral their animals overnight on fields between cropping seasons or manure is gathered from stalls and hand-spread on cropland. Corraling returns both manure and urine to soil and results in greater crop yields than when only manure is applied (Powell and Ikpe, 1992; ILCA, 1993a; Williams et al, this volume, pp. ). Corraling requires no labour for manure handling, storage, and spreading. Since approximately 40 to 60% of the N excreted by ruminants is in the form of urine, the potential for nutrient loss is greater under stall-feeding since only manure can be captured and spread on cropland. The move from extensive livestock management based on grazing, to more intensive stall-feeding (Winrock International, 1992) could increase nutrient losses and jeopardise long-term soil productivity if technologies are not available that capture and recycle the nutrients voided by stationary animals.

The amount and frequency of manure being applied to cropland is influenced by rainfall, cropping and livestock densities and the type of livestock being kept. Farmers tend to apply greater amounts of manure and at shorter intervals in areas of higher rainfall where cultivation densities are greater and cattle are more important than small ruminants (Powell and Williams, 1993). In the drier regions, low and erratic rainfall can cause fluctuations in livestock numbers and changes in herd composition resulting in changes in manure availability. Also, farmers tend to apply less manure in drier areas given the risk of "crop burning" under dry conditions.

In comparing soil properties in manured and non-manured plots, manuring has been found to increase soil pH, soil organic matter, total-N and available-P (Table 3). Of particular interest is the large beneficial effect of manuring on available P in the soil. Soils in semi-arid West Africa are more deficient in P than N (Breman and de Wit, 1983) and manuring appears to greatly offset this deficiency. An accelerated release of P in manure can be of particular importance to soil productivity in savannah soils that are deficient in P (Ruess, 1987).

**Table 3.** *Effects of manure on soil surface chemical properties in West Africa (samples taken at first crop harvest after manure application).*

Manure application	pH	Organic matter (%)	Total nitrogen (mg/kg)	Available phosphorus (mg/kg)	Source
0	5.37 (4.98) <sup>a</sup>	0.39 (0.29)	202 (153)	10.3 (5.3)	1
20.0	6.21 (4.98)	0.58 (0.29)	285 (153)	22.9 (5.3)	1
NR <sup>b</sup>	5.8 (5.1)	0.33 (0.26)	164 (131)	9.6 (4.6)	2
3.6	6.51 (6.18)	0.18 (0.15)	NR (4.3)	5.7	3
2.1	5.04 <sup>c</sup> (4.86)	0.31 (0.28)	NR	NR	3
3.1	5.45 (5.20)	0.31 (0.28)	150 (138)	11.0 (6.1)	4
10.1	5.68 (5.20)	0.33 (0.28)	169 (138)	26.8 (6.1)	4

a. Values in parenthesis are soil properties in non-manured plots.

b. Not recorded.

c. pH in KCl, otherwise pH in water.

Sources: 1. Bationo and Mokwunye (1991);

2. Powell (1986);

3. Powell (unpublished) from 40 farmers fields in Niger;

4. Brouwer (unpublished) from on-station trials in Niger.

Sustainable organic matter recycling, and manuring in particular, depend on land and animal management practices that do not deplete the soil nutrient supply in one location in order to maintain or improve soil productivity in another location. The sustainability of nutrient transfers, where livestock graze and gather nutrients during the daytime to be corralled to fertilise cropland at night, or feed is harvested and transported to stalls for feeding, depends on a balance between the feed supply and livestock numbers. While a portion of nutrients voided in corrals at night are from grazed cropland, most of these nutrients come from rangelands, especially from trees and browse (Swift et al, 1989) and during the latter part of the dry season when cropland residues have been exhausted. Sustainable nutrient transfers from rangeland to cropland for various mixed farming systems require from 4 to 40 hectares of rangeland for each hectare of manured cropland (Bremner and Troaré, 1986; Swift et al, 1989).

## Socio-economic constraints to crop–livestock integration

Population pressure on a limited land resource base, well-developed markets and adequate purchasing power appear to be prerequisites for the integration of crop and livestock production. Cash income permits investments in soil fertility and feed production. Yet, even in areas where further intensification of crop and livestock production is feasible and desirable, a variety of social and economic constraints may inhibit greater integration.

A recurring situation in many parts of SSA is periodic and prolonged drought. This can lead to large livestock losses due to limited availability of forage and the weakened state of livestock arising from low body reserves. The loss of animals through death or distress sales reduces the quantity of manure available for recycling (Williams et al, this volume). Reconstructing herds, particularly cattle, may take several years resulting in multiple year reductions in manure availability and cropland productivity.

Inadequate livestock holdings due to lack of capital to purchase animals may also hinder crop–livestock integration. Indeed, under open access and common property grazing, the principal constraint to livestock holdings and further integration at the individual household level may not be the shortage of feed, but the liquidity position of the farmer that prevents animal purchase or necessitates the frequent sale of livestock.

There is evidence to suggest that beyond certain critical levels of herd sizes and cultivation densities, competition increases between crops and livestock for scarce resources, particularly labour and land (Sandford, 1989; van Keulen and Breman, 1990; Sandford, 1990; McIntire et al, 1992). Land competition varies across the agro-ecological zones. It is lowest in the humid zone where livestock are restricted due to pests and diseases, high in parts of the semi-arid zone, and particularly prominent in the highlands where population density and stocking rates are already high. The competition for land and labour between crops and animals for the production of food and feed continues, even in fully integrated crop–livestock systems such as those found in the highlands and elsewhere in densely settled areas. It has been estimated that cattle numbers in the subhumid zone of Nigeria can continue to expand up to cultivation densities of 20 to 40% (Bourn et al, 1986). It may be expected that when such numbers are reached, the more extensive systems of crop–livestock production will give way to the more intensive, highly integrated mixed farming systems.

More intensive, integrated systems are labour-demanding in terms of fodder production, crop-residue harvesting and storage, feeding work oxen and manure spreading. Major bottlenecks may develop, for instance, where labour needs for manuring conflict with labour demands for crop production. Although the point at which labour conflicts appear will differ in land-scarce and land-abundant zones, the potential for conflict between cropping and livestock for labour is nonetheless real in both systems (Delgado, 1989; McIntire et al, 1992). It is also clear that the roles of men, women and children in crop and animal production vary and are highly influenced by ethnicity, religion and stage of agricultural development. Whereas in crop production men may be responsible for the more laborious tasks of land preparation, women are involved in planting, weeding, harvesting, manual threshing and grain processing and marketing. Most of the herding and corralling of animals on cropland for manuring is done by men, while women may be major providers of fodder and water and haul manure from stalls in intensively managed mixed farming systems.

While the low literacy rates among SSA producers may be considered a constraint to implementing technological improvements, it is clear that these farmers and herders have vast experience and knowledge of crop and livestock production. Such indigenous knowledge can be a valuable resource in designing appropriate technologies and extension programmes for improving agricultural productivity. Studies of traditional practices have shown that indigenous knowledge pertaining to crop and livestock production is generally scientifically sound. Methods of learning from, and incorporating indigenous knowledge into technology development are needed. For instance, although farmers and pastoralists have no past experience in feed production *per se*, their indigenous knowledge of natural pastures and feeding systems needs to be understood and incorporated into research aimed at improving animal nutrition (Traoré and Breman, 1992).

## **Strategies for improving crop–livestock interactions**

A recent report on the future of animal agriculture in SSA (Winrock International, 1992) suggests that the greatest opportunity for sustainable increases in agricultural productivity lie in agricultural intensification through the evolution and maturation of mixed crop–livestock farming systems, especially in the subhumid and wetter portions of the semi-arid zones. The evolution and development

of mixed farming can be improved by developing high-yielding legumes and other forages; improving the quality of crop residues for feeding through genetic means; increasing animal resistance to disease and parasites; improving the productivity of indigenous livestock; establishing effective input (e.g. fertiliser) and support services (e.g. veterinary delivery systems); establishing infrastructure (e.g. roads, processing and marketing facilities); strengthening government institutions; and developing supportive fiscal, incentive and trade policies for smallholder farming.

There is evidence which indicates that, irrespective of the extent of crop–livestock interaction, many of the benefits of closer integration are limited (Sandford, 1989; McIntire et al, 1992). The notable benefits of manuring to improve soil quality (Table 3) and animal traction may not always result in large increases in crop yields. This implies that along with closer crop–livestock interactions, exogenous technical changes involving new seed varieties, fertilisers and improvement in animal nutrition are needed to raise overall agricultural productivity. Lack of recognition of what is appropriate research to promote mixed farming in each agro-ecological zone has contributed to the failure of many intervention efforts in the past.

### **Socio-economic considerations**

Farmers in SSA keep different types and classes of livestock and practice different management and production strategies as influenced by the ecological base and the varying levels of resources they command. An initial assessment of the constraints to, and opportunities for improving agricultural productivity within existing farming systems needs to be done. Problems common to most producers across all agro-ecological zones include inadequate feed resources, poor reproductive performance and health of livestock, reduced fallow periods (and declining soil fertility), seasonal labour shortages, lack of access to inputs, encroachment of cropping on grazing and marginal lands and inadequate market opportunities (ILCA, 1993b). The relative importance of these constraints varies greatly among mixed farms within a zone.

The initial challenge to research and technology development is to identify the predominant production systems and target the key research issues that are likely to have the maximum positive impact on crop and livestock production. This must take into account the indirect contribution of one sector to the other through cash income (McIntire and Gryseels, 1987). Different research strategies exist and the one chosen must depend on the current degree of crop and livestock integration. For example, strategies to improve manure utilisation will be dictated by the stage of farming system evolution. In integrated systems where manure use is already significant, the problem will be how to improve the efficiency of nutrient cycling, while in systems where crop and livestock production are independent and manure is obtained through contracts between farmers and pastoralists, the issue might be how best to ensure that contracts are as efficient as possible.

Farming systems research utilising rapid rural appraisal techniques can be used to identify the stage in the evolution of crop–livestock integration, the feasibility of further integration, and the physical, social and economic constraints to sustainable increases in the productivity of the mixed farming system. Furthermore, classification of crop–livestock producers into homogeneous units with similar constraints and characteristics using quantitative techniques such as cluster analysis can be particularly useful in identifying important issues that component biological research should address (Williams, 1994; Monicat et al, 1992).

### **Improving feed supply and quality**

An increase in feed productivity and quality and the development of diet supplementation techniques to overcome the seasonal nutritional constraints are needed in all parts of SSA. A move from extensive livestock management based on grazing to intensive stall-feeding of livestock will require not only more feed of high quality but also improved feed harvesting and storage techniques.

The proper use of chemical fertilisers will be crucial in increasing the feed supply and its quality (Bremner, 1990; Powell and Fussell, 1993; McIntire and Powell, this volume); however, fertilisers continue to be costly and unavailable to most farmers. The small amounts of fertilisers that are available need to be used judiciously with organic-nutrient sources such as N-fixing legumes, crop residues and manures. The necessary increase in fertiliser use may require loans and/or subsidies to farmers, proper instruction in fertiliser use, the provision of fertiliser-responsive varieties and policies that give farmers timely access to fertiliser, at reasonable costs and attractive prices for their commodities.

The integration of grain and forage legumes and browse trees can serve an important role in sustaining the productivity of crops and livestock in SSA. In production systems where fallowing is practised, forages which fix atmospheric N can be more effective than native grasses in restoring soil fertility, thereby reducing fallow period requirements. Forage legumes can improve animal feed, suppress weed growth, accelerate nutrient cycling and improve soil moisture conservation. Wind breaks using leguminous browse and perennial grasses can control soil erosion, enhance soil productivity, and provide food, fodder and wood.

The adoption of ley farming instead of utilising natural grasslands depends on its superior soil fertility restoring capacity; ability to support more livestock; more efficient use of farm labour; and large benefit:cost ratio (Ruthenberg, 1980). Land allocation to forage production is positively related to land-tenure security (especially of access rights) and is negatively related to access to communal or other land, and to the ability to acquire additional land. Increased labour requirements to produce forages in relation to the effect of forages on livestock output impedes forage production for most producers (McIntire et al, 1992).

Research has shown that the integration of forage legumes with cereal crops (e.g. hedgerow intercropping, undersowing, rotations) can lead to sustainable increases in feed and soil productivity. However, forages are rarely grown, probably because they do not contribute directly to food security (Mohamed-Saleem, 1985). Also, when forage legumes are intercropped with cereals, there may be initial trade-offs in grain and feed output. Forage legume-cereal intercropping often increases the quantity and feeding value of crop residues, but decreases the yield of the companion cereal crop (Mohamed-Saleem, 1985; Kouamé et al, 1993). However, grain yields are improved when cereals are rotated with short-term fallows of forage legumes (Mohamed-Saleem and Otsyina, 1986). Profitable management techniques are still required if forage legumes are to be widely cultivated in SSA. They have to be easy to cultivate and need to regenerate readily and not be a hazard to the succeeding crop. The problem in many tropical regions is the lack of legume persistence when grown in association with grasses.

Grain legumes (cowpeas, pigeon peas, groundnuts etc) are already an integral part of many mixed-farming systems. Their residues are valuable diet supplements for livestock and income sources for rural households. Many grain legumes, however, shed their leaves upon grain maturity which greatly reduces their feeding value. Dual-purpose grain legumes that retain their leaves are needed to provide both food and feed. Whereas many forage legumes regenerate from seed, grain legumes have to be replanted.

Research is clearly needed on methods to reduce the competition between animals and soil conservation for crop residues. Growing forages to substitute for crop residues, the partial rather than total removal of crop residues (Powell and Fussell, 1993), and an improved balance between feed supplies and animal populations can mitigate the competition between livestock and soil conservation for crop residues (Unger et al, 1991). Long-term trials with producer involvement are needed to assess the feasibility and impact of various forage management techniques on animal and soil productivity (nutrient balances, trampling etc).

## **Manure utilisation**

The current widespread practice of daytime grazing and overnight corralling of animals on cropland recycles a relatively high proportion of nutrients. A move to stall-feeding may increase nutrient losses since only manure-bound nutrients may be available for recycling. Such changes in livestock management will demand new resources and management methods. There is a need to develop improved manure (and urine) handling and storage techniques that capture the maximum amount of nutrients excreted by animals.

Strategies are also required that synchronise manure application and its nutrient release with plant nutrient demands. The application of organic amendments to soil such that their decomposition and nutrient release coincide with crop nutrient demands can greatly increase the efficiency of nutrient cycling in low-input farming systems (McGill and Myers, 1987; Ingram and Swift, 1989; Swift et al, 1989). Nutrient release from manure is faster and appears to be more synchronous with crop nutrient demands than the nutrient release patterns of forages applied to soils (Somda et al, this volume). Timely and strategic placement of manure through improved manure handling, storage and land-spreading techniques can enhance nutrient cycling in these mixed farming systems.

Although the transfer of nutrients from uncultivated to cultivated areas by animals is a critical component of nutrient cycling in mixed farming systems of SSA, the transfer mechanisms are poorly understood. The capacity of rangelands to support livestock and nutrient harvesting needs to be assessed at various rangeland:cropland ratios. Long-term information is needed on nutrient acquisition and use by animals including grazing behaviour and orbits, and the effects of grazing and browsing on rangeland vegetation and long-term animal and soil productivity. The move from extensive to intensive crop and livestock production not only requires more feed and better feed management but also new methods of manure, urine, feed refusal and land management that enhance nutrient cycling.

## **Interdisciplinary research approach**

The range of cultural, technical and socio-economic issues involved in crop–livestock interactions necessitates an interdisciplinary approach to ensure that the development of techniques will be synchronised with the agroclimate and farming system under consideration. An understanding of the key interactions between plants, animals and soils and farmer management practices is needed for developing scientifically sound and socially acceptable technologies that improve resource management. Whole farm and crop–livestock simulation models can be useful tools for evaluating the impact of various resource management practices on long-term crop and livestock productivity. The appropriateness and adoption of improved plant–animal–soil management systems will depend largely on their profitability from the producer's perspective. Therefore, farmers need to be intricately involved in all stages of technology development and assessment.

## **Conclusions**

The climatic and socio-economic changes occurring in many areas of SSA have put increased pressure on the natural resource base to produce more food and feed. Traditional practices of shifting cultivation and transhumance continue to give way to more sedentary forms of crop and livestock production. Whereas many mixed farming systems are well developed, many are still in the early stages of evolution. When moving from extensive to more intensive modes of agricultural production, the risk of degradation increases. Intensification of land use without proper inputs and management can lead to widespread environmental degradation and jeopardise the long-term productivity of mixed farming systems.

Significant increases in crop and livestock production are possible through increased fertiliser use, genetic improvement, greater integration of legumes into the farming system and improved animal nutrition, especially by ameliorating the quantity and feeding value of crop residues. Research needs to develop management strategies that minimise the competition between crops and livestock,

especially the conflicting demands of animal feed and soil conservation for crop residues. Reducing nutrient losses from manure and urine can improve the role of livestock in nutrient cycling and lead to higher crop and forage yields and animal production.

An interdisciplinary approach to defining research priorities and strategies is needed for developing ecologically sound, economically viable, and socially acceptable technologies that increase agricultural productivity. The key interactions between plants, animals, and soils need to be understood and farmers' perceptions and priorities factored into the research process. The sustained productivity of these farming systems over the long-term depends on conserving the natural resource base while maintaining a balance between human and animal populations.

## References

- Bationo A and Mokwunye A U. 1991. Role of manures and crop residues in alleviating soil fertility constraints to crop production: With special reference to the Sahelian and Sudanian zones of West Africa. In: Mokwunye A U (ed), *Alleviating soil fertility constraints to increased crop production in West Africa*. Kluwer Academic Publishers, Dordrecht, Germany. pp. 217–226.
- Bourn D, Milligan K and Wint W. 1986. Tsetse, trypanosomiasis and cattle in a changing environment. In: von Kaufmann R, Chater S and Blench R (eds), *Livestock systems research in Nigeria's subhumid zone*. Proceedings of the Second ILCA/NAPRI Symposium held in Kaduna, Nigeria, 29 October–2 November 1984. ILCA (International Livestock Centre for Africa), Addis Ababa, Ethiopia. pp. 85–109.
- Breman H. 1990. No sustainability without external inputs. In: *Beyond adjustment: Sub-Saharan Africa*. Africa Seminar. Maastricht, The Netherlands. pp. 124–134.
- Breman H and de Wit C T. 1983. Rangeland productivity and exploitation in the Sahel. *Science* 221:1341–1347.
- Breman H and Traoré N. 1986. *Analyse des conditions de l'élevage et proposition de politiques et de programmes*. Burkina Faso. SAHEL D (86) 300. OECD (Organization for Economic Cooperation and Development), Paris, France. 202 pp.
- CAB (Commonwealth Agricultural Bureaux). 1984. *The nutrient requirements of ruminant livestock*. Supplement 1. The Lavenham Press Ltd., Lavenham, Suffolk, UK. 45 pp.
- Delgado C L. 1989. The changing economic context of mixed farming in savanna West Africa: A conceptual framework applied to Burkina Faso. *Quarterly Journal of International Agriculture* 28:351–364.
- Geiger S C, Manu A and Bationo A. 1992. Changes in a sandy Sahelian soil following crop residue and fertilizer additions. *Soil Science Society of America Journal* 56:172–177.
- ILCA (International Livestock Centre for Africa). 1987. *ILCA's strategy and long-term plan*. ILCA, Addis Ababa, Ethiopia. 99 pp.
- ILCA (International Livestock Centre for Africa). 1993a. *ILCA 1992: Annual Report and Programme Highlights*. ILCA, Addis Ababa, Ethiopia. 81 pp.
- ILCA (International Livestock Centre for Africa). 1993b. *ILCA's long-term strategy, 1993–2010*. ILCA, Addis Ababa, Ethiopia. 114 pp.
- Ingram J A and Swift M J. 1989. Sustainability of cereal–legume intercrops in relation to management of organic matter and nutrient cycling. *Farming Systems Bulletin East and Southern Africa* 4:7–21. CIMMYT (International Maize and Wheat Improvement Center), Harare, Zimbabwe.
- Jahnke H E. 1982. *Livestock production systems and livestock development in tropical Africa*. Kieler Wissenschaftsverlag Vauk, Kiel, Germany. 253 pp.
- Kouamé C N, Powell J M, Renard C A and Quesenberry K H. 1993. Plant yields and fodder quality related characteristics of millet–stylo intercropping systems in the Sahel. *Agronomy Journal* 85:601–605.
- McCown R L, Haaland G and De Haan C. 1979. The interaction between cultivation and livestock production in semi-arid Africa. In: Hall A E, Cannell G W and Lawton H W (eds), *Agriculture in semi-arid environments*. Springer-Verlag, Berlin, Germany. pp. 297–332.
- McGill N B and Myers R J K. 1987. Controls on the dynamics of soil and fertilizer nitrogen. In: Follett R F, Stewart J W B and Cole C V (eds), *Soil fertility and organic matter as critical components of production*



- systems. SSSA Special Publication 19. SSSA (Soil Science Society of America), Madison, Wisconsin, USA. pp. 73–99.
- McIntire J and Gryseels G. 1987. Crop–livestock interactions in sub-Saharan Africa and their implications for farming systems research. *Experimental Agriculture* 23:235–243.
- McIntire J, Bourzat D and Pingali P. 1992. *Crop–livestock interaction in sub-Saharan Africa*. World Bank, Washington, DC, USA. 246 pp.
- Mohamed-Saleem M A. 1985. Effect of sowing time on grain and fodder potential of sorghum undersown with stylo in the subhumid zone of Nigeria. *Tropical Agriculture (Trinidad)* 62:151–153.
- Mohamed-Saleem M A and Otsyina R M. 1986. Grain yields of maize and the nitrogen contribution following *Stylosanthes* pasture in the Nigerian subhumid zone. *Experimental Agriculture* 22:207–214.
- Monicat F, Borne P M and Maron P. 1992. Zonage et typologie des exploitations possédant des petits ruminants dans les systèmes de production traditionnels du Zimbabwe. *Les Cahiers de la Recherche Développement* 32(2):38–56
- Mortimore M. 1991. *A review of mixed farming systems in the semi-arid zone of sub-Saharan Africa*. Livestock Economics Division Working Document 17. ILCA (International Livestock Centre for Africa), Addis Ababa, Ethiopia. 181 pp.
- Omaliko C P E. 1981. Dung deposition, breakdown and grazing behavior of beef cattle at two seasons in a tropical grassland ecosystem. *Journal of Rangeland Management* 34:360–362.
- Pingali P L. 1993. *Crop–livestock systems for tomorrow's Asia: From integration to specialization*. Paper presented at the International Workshop on Crop–livestock Interactions, Khon Kaen, Thailand, 27 September–1 October 1993. IRRI (International Rice Research Institute), Los Banos, The Philippines.
- Powell J M. 1986. Manure for cropping: A case study from Central Nigeria. *Experimental Agriculture* 22:15–24.
- Powell J M and Fussell L K. 1993. Nutrient and carbohydrate partitioning in millet. *Agronomy Journal* 85:862–866.
- Powell J M and Taylor-Powell E. 1984. Cropping by Fulani agropastoralists in central Nigeria. *ILCA Bulletin* 19:21–27. ILCA (International Livestock Centre for Africa), Addis Ababa, Ethiopia.
- Powell J M and Williams T O. 1993. *Livestock, nutrient cycling, and sustainable agriculture in the West African Sahel*. Gatekeeper Series SA37. IIED (International Institute for Environment and Development), London, UK. 15 pp.
- Ruess R W. 1987. The role of large herbivores in nutrient cycling of tropical savannas. In: Walker B H (ed), *Determinants of tropical savannas*. The International Union of Biological Sciences Monograph 4. IRL Press, Oxford, UK. pp. 67–91.
- Ruthenberg H. 1980. *Farming systems in the tropics*. The Clarendon Press, Oxford, UK. 424 pp.
- Sandford S. 1989. Crop residue–livestock relationships. In: *Soil, crop, and water management systems for rainfed agriculture in the Sudano-Sahelian zone*. Proceedings of an International Workshop, ICRISAT Sahelian Center, Niamey, Niger, 7–11 January 1987. ICRISAT (International Crops Research for the Semi-Arid Tropics), Patancheru, India. pp. 169–182.
- Sandford S. 1990. Integrated cropping–livestock systems for dryland farming in Africa. In: Unger P W, Sneed T V, Jordan W R and Jensen R (eds), *Challenges in dryland agriculture — A global perspective*. Proceedings of the International Conference on Dryland Farming held in Amarillo, Bushland, Texas, 15–19 August 1988. Texas Agricultural Experiment Station, College Station, Texas, USA. pp. 861–872.
- Siebert B D, Romero A, Hunter R A, Megerrity R G, Lynch J J, Glasgow J D and Breen M J. 1978. Partitioning intake and outflow of nitrogen and water in cattle grazing tropical pastures. *Australian Journal of Agricultural Research* 29:631–644.
- Stoorvogel J J and Smaling E M A. 1990. *Assessment of soil nutrient depletion in Sub-Saharan Africa: 1983–2000*. The Winand Staring Centre, Wageningen, The Netherlands.
- Swift M J, Frost P G H, Campbell B M, Hatton J C and Wilson K. 1989. Nutrient cycling in farming systems derived from savanna: In: Clarholm M and Berstrom D (eds), *Ecology of arid lands: Perspectives and challenges*. Kluwer Academic Publishers, Dordrecht, Germany. pp. 63–76.

- Ternouth J H. 1989. Endogenous losses of phosphorus by sheep. *Journal of Agricultural Science* 113:291–297.
- Toulmin C. 1983. *Herders and farmers or farmer-herders and herder-farmers?* Pastoral Development Network Paper 15d. Overseas Development Institute, London, UK. 22 pp.
- Traoré N and Breman H. 1992. External inputs could save pastoralism: New wine in old bags? *ILEIA Newsletter* (9)1:10–12. ILEIA (Information Centre for Low-External-Input and Sustainable Agriculture), The Netherlands.
- Unger P W, Stewart B A, Parr J F and Singh R P. 1991. Crop residue management and tillage methods for conserving soil and water in semi-arid regions. *Soil & Tillage Research* 20:219–240.
- van Keulen H and Breman H. 1990. Agricultural development in the West African Sahelian region: A cure against land hunger? *Agriculture, Ecosystems and Environment* 32:177–197.
- van Raay H G T. 1975. *Rural planning in a savannah region*. University Press, Rotterdam, The Netherlands. 183 pp.
- van Raay H G T and de Leeuw P N. 1974. *Fodder resources and grazing management in a savannah environment: An ecosystem approach*. ISS Occasional Paper 45. ISS (Institute of Social Studies), The Hague, The Netherlands. 28 pp.
- Williams T O. 1994. Identifying target groups for livestock improvement research: The classification of sedentary livestock producers in western Niger. *Agricultural Systems* 46:227–237.
- Winrock International. 1992. *Assessment of animal agriculture in Africa*. Winrock International, Morrilton, Arkansas, USA. 125 pp.

# Nutrient cycling and its importance in sustaining crop–livestock systems in sub-Saharan Africa: An overview

*P.J. Stangel*

SAAC, Route 7, P O Box 380, Florence, AL 35630, USA

## Abstract

Nutrient cycling in crop–livestock systems requires major improvements before it is considered sustainable under sub-Saharan conditions. This is due in part to the inherent low fertility of the soils within the region. However, the major impediments are the intense levels of soil erosion and the common practice of diverting large amounts of crop residue and animal manure to non-farm uses (e.g. energy and building materials) rather than returning them to the soil. In addition, significant quantities of nutrients are lost due to leaching, volatilisation and off-farm transit of grains, meat and livestock by-products. Preliminary estimates of net losses of nutrients annually from all sources average 49 kg/ha per year or 9.3 million t/yr of nutrients for the entire region. This is four times as high as the average use of fertiliser in sub-Saharan Africa and one-half the world rate of use. A strategy to reduce nutrient losses by at least one-half and build soil fertility to improve nutrient cycling in crop–livestock systems is advanced in this paper. This includes the creation of pilot areas to verify and adapt already known research findings to local conditions. The specific areas include establishment of soil fertility reserves, creation of agricultural input centres, establishment of agroforestry zones and development of land-use centres. Research areas identified deal with nutrient balance studies, finding ways to increase soil organic matter in agricultural soils to levels attained under native conditions, and examining ways to reduce nutrient losses in crop–livestock systems. Also considered is an assessment of the impact of landless livestock enterprises on the environment in and around urban areas.

## Synthèse des recherches sur le recyclage des éléments nutritifs et son importance dans la durabilité des systèmes de production mixtes en Afrique subsaharienne

*P.J. Stangel*

SAAC, Route 7, P.O. Box 380, Florence, AL 35630 (E.-U.)

## Résumé

*Le processus de recyclage des éléments nutritifs dans les systèmes mixtes de l'Afrique subsaharienne doit subir d'importantes modifications avant de devenir durable dans les conditions prévalant aujourd'hui dans cette région. L'inefficacité actuelle est en partie due à la faible fertilité des sols de cette région. Toutefois, les principaux obstacles à surmonter sont la forte érosion des sols et l'utilisation d'importantes quantités de résidus de récolte et de fumier à des fins non agricoles (ex. énergie et construction) en lieu et place du recyclage dans la terre. Par ailleurs, d'importantes quantités d'éléments nutritifs sont perdues par lessivage et évaporation et par suite de l'exportation de céréales, de viande et de sous-produits animaux vers des secteurs non agricoles. Selon des estimations préliminaires, les pertes nettes d'éléments nutritifs se chiffrent en moyenne à 49 kg/ha/an, soit 9,3 millions de tonnes par an pour l'ensemble de la région. Cela représente quatre fois la quantité moyenne d'engrais utilisée dans la région et la moitié de celle utilisée dans l'ensemble du monde. Une stratégie a été proposée en vue de réduire de moitié au moins ces pertes et de reconstituer la fertilité des sols pour améliorer le processus de recyclage de ces éléments. Celle-ci préconise, entre autres,*

*la création de zones pilotes pour vérifier les résultats de recherche déjà confirmés et les adapter aux conditions du milieu. Plus spécifiquement, elle prévoit la création de réserves pour l'amélioration de la fertilité ainsi que de centres d'intrants agricoles, de zones de développement agroforestier et de structures de mise en valeur des terres. Les travaux envisagés concernent les échanges d'éléments nutritifs, les moyens d'accroître les taux de matière organique des sols agricoles aux niveaux observés dans les terres vierges et enfin les moyens de réduire les pertes en éléments nutritifs. Il a en outre été proposé d'évaluer l'effet des activités des éleveurs sans terre sur l'environnement urbain et péri-urbain.*

## **Introduction**

Efficient nutrient cycling is an essential component of most crop–livestock systems that are sustainable over the long term. Such systems are characterised by their ability to provide the essential nutrients needed to sustain growth of the desired naturally occurring grasses and legumes and for crop production. The magnitude, type and efficiency of nutrient cycling systems varies not only with the physical and chemical conditions prevailing within a given agro-climatic zone but also with the level of management and a host of economic, social, political and environmental factors. All these have an impact on how farmers and herdsmen use the ingredients that contain the essential nutrients.

The need to find ways to improve the efficiency of nutrient cycling by making the system more closed has increased as population pressures and the attendant demand to increase the supplies of food have intensified. As a result, the amount of potentially arable land has diminished in quality and more marginal lands have been brought into production. Two factors that reinforce this need are the growing awareness that land and plant nutrients are non-renewable resources and the increasing concern over the impact traditional agricultural systems have on the overall environment.

The purpose of this paper is to provide an overview of nutrient cycling in major crop–livestock systems in sub-Saharan Africa (SSA), to identify the source and cause of current inefficiencies in nutrient cycling, and to propose strategies for its improvement.

## **Nutrient cycling in mixed farming systems of sub-saharan Africa**

The systems of nutrient cycling currently practised by the majority of the farmers and herdsmen to sustain crop–livestock systems were developed over a number of centuries. This was at a time when population pressures were low and supplies of potentially arable land of good quality were plentiful. The time proven method of cropping or grazing land for 2–4 years followed by a period of "rest" (fallow) for 7–20 plus years allows the soil to rebuild its fertility. This method proved to be a very satisfactory, low input sustainable agricultural system. As population pressure increased and forced increases in the production of food and fibre, the intervals between fallow were shortened. In addition, marginal land was brought into production. This led to an overall decline in productivity of the various systems and as fertility dropped more soils became degraded and lost their basic chemical and physical coherence. This resulted in the destruction of a major segment of the land resource base in sub-Saharan Africa. The current situation regarding nutrient recycling is different from that practised by farmers and herdsmen as recently as 100 years ago. The fallow system no longer provides a base soil fertility that sustains crop or animal production at a level that will meet the basic needs of an exploding population. Furthermore, farmers lack the financial resources and basic institutions necessary to accept and sustain the modern high inputs oriented technology introduced in some areas from the developed countries. As a result most of the systems are not economically viable. Further complicating the situation is the growing concern by national and international groups about the impact agriculture has on the environment. In a growing number of cases this concern transcends the values and needs of the individual or members of the local village. When placed into law, this concern superimposes a series of social and political values on top of an already complex set of cultural values and economic needs which determine whether or not a system or group of systems are sustainable. Thus farmers and herdsmen alike find themselves in a difficult situation.

The present crop and livestock systems are not economically viable. However, the farmers lack the financial resources and/or are culturally not willing to accept the modern alternatives. Furthermore, because of the fragility of most soil systems in SSA and the growing concern over the impact crop–livestock systems have on the environment, there is a growing question as to whether many of the present, much less proposed, nutrient cycling systems are sustainable.

### **Crop–livestock management systems**

Livestock are vital to subsistence and economic development in SSA (Brumby, 1979). They provide a flow of essential food products throughout the year, are a major source of government revenue and export earnings, sustain employment and income of millions of people in rural areas, contribute draft power for crop production and are the only food and cash security to many Africans. The sale of livestock and their products often constitutes the only source of cash income in rural areas (they often provide the only effective avenue of selling surplus food crops or forage). This is often the only way in which subsistence farmers can buy consumer goods and procure the improved seeds, fertilisers and other inputs needed to increase crop yields. Where livestock development has been successfully pursued, a steady increase in productivity of food grains and forage legumes has been noted (Jahnke, 1982).

Livestock produce neither nutrients nor organic matter. They are net consumers of each and highly dependent upon adequate supplies of a natural vegetative system and/or specific agricultural crops grown in near proximity for their overall nutrition and sustenance.

While there are numerous means of classifying livestock systems, the five categories proposed by Jahnke (1982) fit best when discussing the interaction of nutrient cycling in crop–livestock systems. The five categories are:

1. Pastoral range–livestock production systems.
2. Crop–livestock production systems in the lowlands.
3. Crop–livestock production systems in the highlands.
4. Ranching systems.
5. Landless livestock production systems.

Although efficient nutrient cycling is most interactive in crop–livestock systems (categories 2 and 3) there are also considerable opportunities for improvements in the others as well. The major crops associated with livestock production systems vary significantly. In the semi-arid zone millet, sorghum, chick peas and cowpeas are the principle crops. Maize is dominant in the semi-arid and subhumid zone, while cassava (Figure 1) and sugar-cane predominate in the subhumid and humid zones. Forages (legume and grass) are increasing in presence, particularly in the subhumid and, to a lesser extent, the semi-arid zones.

Crop–livestock production systems are land-use systems in which livestock husbandry and cropping are practised in association. This association may be close and complex or livestock husbandry and cropping may be parallel activities without interaction, possibly not even belonging to the same management unit. Pastoral livestock systems are operative in areas where 90 days of good climate and 500 mm of rainfall (mono-model pattern) prevail. This minimal amount of rainfall makes it safe to secure suitable yields of millet and thereby provide pastorlists with suitable supplies of crop residue (forage) during the dry season.

Crop–livestock interactions are few in the humid zone because animal diseases and cropping patterns based on root crops discourage animal production. Interactions become more frequent and more intense in the subhumid and semi-arid zones. The interactions are based on using animal traction, manure (in cropping) and crop residues (as livestock feed). Interactions are most frequent in highland zones, where cereals are the major crop grown. Interaction in the highlands involves intensive milk production, animal traction, manure production and sown fodder crops (Jahnke, 1982).

**Figure 1.** Suitability classification and yields of major food crops in African tropical lowland ecological zones at low input levels.

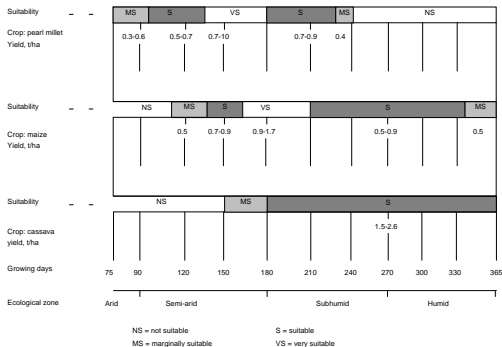

Source: FAO (1978).

Source: FAO (1978).

West Africa displays the co-existence of arable farming and grazing systems in areas definitely suitable for cropping on the largest scale. There is a long tradition of at least seasonal penetration of pastoral herds into the more humid areas. This has led to the creation of forage banks and, as the crop-livestock system develops, farms that produce forage legumes on a large scale.

### Essential plant nutrients

There are 16 chemical nutrients deemed essential to plant growth. These are carbon (C), hydrogen (H), oxygen (O), nitrogen (N), phosphorus (P), potassium (K), calcium (Ca), magnesium (Mg), sulfur (S), iron (Fe), boron (B), manganese (Mn), copper (Cu), Zinc (Zn), molybdenum (Mo) and chlorine (Cl). All except C, H and O are derived from the soil. The availability of six (N, P, K, Ca, Mg and S) of these in soil solution and soil organic matter (SOM) greatly influences the levels required and therefore are the nutrients most likely to limit crop growth.

The nutrients required to sustain animal growth include the 16 elements already mentioned plus cobalt (Co), iodine (I) and selenium (Se). All of these are also found in and supplied by a wide range of sources including soil reserves, crop residues, animal manure, biological nitrogen fixation (BNF), commercial fertilisers, industrial by-products and other sources. For purposes of this discussion, the principle nutrients most likely to be limiting to crop-livestock systems in SSA soils are N, P, K, Ca, Mg and S.

### Sustainability defined

The traditional agricultural production systems are no longer capable of producing the current needs of food and fibre for SSA. Changes in the crop and livestock systems in particular are required if the

region is going to produce the basic needs of future generations and move to a higher economic and social standard. It is important that these new systems are sustainable.

The literature contains numerous definitions of sustainable agriculture (TAC, 1988; Edwards, 1990; Harwood, 1990; ILCA, 1992; Rattan, 1992). The definitions presented by TAC (1988) and ILCA (1992) are presented for purposes of discussion in this paper. The definitions are:

- "Sustainable agriculture should involve successful management of resources for agriculture to satisfy changing human needs while maintaining or enhancing the natural resource base and avoiding environmental degradation." (TAC, 1988:3).
- Sustainable agriculture produces food and fibre while increasing the inherent productive capacity of natural and biological resources earning profits for farmers, providing consumers with wholesome, safe food and minimising adverse impacts on the environment (Benbrook, 1991).
- "A sustainable agricultural system is thus one that maintains or enhances the quality of the environment, meets current and future demands of society and ensures the economic and social welfare of the farming community." (ILCA, 1992: ix).

Each definition requires an increase in output while calling for the preservation/improvement of the environment. While these may seem to be mutually exclusive goals, both can be achieved through judicious marshalling of resources.

Several points of agreement which are relevant to efficient nutrient cycling in the crop–livestock systems of SSA appear common to most groups defining sustainability. The key points are:

- crop–livestock systems must be increasingly productive and efficient in using indigenous resources (specifically non-renewable resources)
- effects must continue to make the biological processes within the crop–livestock systems much more controlled from within rather than by the use of external inputs such as feed concentrates, commercial fertiliser and various feed additives
- nutrient cycles within the farm must be much more closed
- crop nutrients must come from management of nutrient flow into and out of the soil organic matter (SOM) fraction, a "farming of the SOM" rather than the "farming of soil nutrient solutions".

The new systems should create sinks of SOM that contain "nutrient pools" protected from forces that would otherwise cause them to be immobilised or lost to the system but that are available when needed by crops or livestock. This point is of particular importance in finding ways to improve the efficiency of nutrient cycling in crop–livestock systems in SSA.

## Nutrient supply sources

Historically, sub-Saharan African farmers and herdsmen have derived the nutrients necessary to support crop–livestock systems from soil reserves, crop residues, animal manures and biological nitrogen fixation (BNF). In recent years, commercial fertilisers and industrial waste residues have become increasingly important. However, these still fall far short of levels of usage common in other developing countries and are nowhere near the amounts needed to sustain the crop–livestock systems of the region. In spite of this, the major sources of plant nutrients for most sustainable crop–livestock systems will continue to come from judicious use of the nutrients found in soil, crop residues, animal manure and those supplied through biologically fixed N.

## Soil reserves

The colloidal fraction of the soil consisting of clay minerals and organic residues is the main source of plant nutrients and has a major impact on nutrient availability (intensity) at a specific point in time (Sanchez, 1976). Loss of the organic matter and clay components (usually in the top 10 cm of the profile) from a soil represents a major loss in nutrient availability and overall fertility. These soil

constituents also determine the ability of the soil system to sustain the supply of a given level of nutrient over an extended period of time (nutrient capacity).

The nutrient supply capability of a given soil for the major cations—its cation exchange capacity (CEC)—is determined by the type and amount of the clay mineral and organic colloids present. For example, soils with a limited clay fraction that are highly weathered and have a preponderance of kaolinitic clay generally have a very low CEC (1–6 meq/100 g or less). The greater the amount of clay minerals with limited surface area such as kaolinite or the absence of even this fine fraction and the preponderance of coarse sands, the lower the CEC. The greater the presence of such clay minerals as illite or montmorillonite as well as decomposed (colloidal) organic residues, the higher the CEC. Mineral soils with a higher percentage of expanding clay minerals (montmorillonite and illite) and organic matter levels of 2–5% or higher have high CECs. Under these conditions, cation exchange capacities of 1–25 meq/100 g of soil are common in many areas of SSA where variable charge clays co-exist with illitic clays.

The amount of K, Ca, or Mg present will depend largely on the original composition of the parent material, the previous management of the soil system, and the amount of weathering that has taken place (Sanchez, 1976). Generally, the greater the amount of rainfall the less there are of these bases. The organic fraction is a major source of N, P and S. In addition, this fraction supplies the pH buffering capacity of the soil. The actual amounts of available N, P, K and S are determined in part by the total level of SOM and its rate of decomposition as organic matter is the centre of biotic activity in the soil (IAEA, 1984; Lal, 1990). For example, the availability of phosphate is dictated in part by the type and amount of clay and organic matter present. Where kaolinite is the dominant clay mineral in coarse-textured soils, the capacity to supply native phosphate is limited and retention of added phosphate is minimal. Clay soils rich in sesquioxides of iron or aluminium and containing considerable organic colloids have a significant capacity to supply phosphate to plants. The degree to which this occurs varies with the level of management. Soils high in reactive iron and aluminum also have a high capacity for phosphate retention (Sanchez, 1976). Thus, availability of phosphate (natural or added) in soils with these properties is usually low and is strongly influenced by crop, soil and fertiliser management (Sanchez and Benites, 1987; Fox, 1988). Loss of either the organic or clay mineral fraction of the soil either through cropping, erosion, leaching, or cultivation severely restricts nutrient availability unless manures, crop residues, or commercial fertilisers are added to replenish the system.

Organic matter is also the centre of biotic activity in the soil which, in addition to its many other functions, provides the process that governs the availability of essential plant nutrients (Lal, 1990). In the tropical soils of SSA, the SOM fraction constitutes the major portion of total N, P and S reserves (Nye and Greenland, 1960). Typically 95% of the total N and S are in the organic form, while the proportion for P is lower — 60–80% (Sanchez, 1976) and 20–75% (Duxbury et al, 1989). A decline in SOM by two-thirds, such as happens when soils are continuously cropped or there are major losses due to soil erosion, represents a serious decrease in both the total reserve and availability of essential plant nutrients.

In general, sub-Saharan soils are old (more than 1 million years) and depending upon the climate (temperature and rainfall) and vegetation, are considered highly weathered and infertile, particularly in N, P and S.

### **Humid/subhumid zone**

The soils found in the humid and subhumid zones (rainfall >1500 mm/yr) are located in forests or former forests (derived savannah) and dominated by the acid infertile kaolinitic and low base Oxisols and Ultisols soil groups. Their pH is frequently below 5.0, and they are low in CEC (<5 meq/100 g soil) with expandable clay minerals generally absent. Soil organic matter in these soils is about 1–2% if undistributed but drops very rapidly (<0.5%) once the forest cover is removed and the soils are cultivated.



Another group of soils that are also kaolinitic but have high base saturation predominate in the drier forest and subhumid zone of West and East Africa. These are called Alfisols and are coarse-textured and highly erodible. They have low available water, low to medium fertility and, generally, low phosphate retention. Alfisols derived from basement complex rocks have a moderate capacity to supply K, while those derived from sedimentary rocks have a low capacity. Like the Oxisols and Ultisols, the Alfisols are low in available P. Generally Ca and Mg levels are low and while total phosphorus levels may be high (5000–10 000 ppm) available P is very low (5–20 ppm Olsen method; Watanabe and Olsen, 1970). A large proportion of the total nutrient stocks in these soils are in the organic form and exist primarily in the biomass, litter and SOM. Natural forest ecosystems were able to thrive under such fertility systems because of their "closed" nutrient cycling systems (Nye and Greenland, 1960) and negligible export of nutrients in the form of biomass. Given these soil constraints the management of organic inputs and SOM is crucial for sustainable productivity of these soils.

### **Semi-arid (dry) zone**

The entire dry zone (200–1200 mm annual rainfall) to the south of the Sahara is characterised by a long dry season with one short season of rain (monomodal) in West Africa and two short seasons of rain (bimodal) in East Africa. Historically, the balance between soil, climate, vegetation cover and man has generally been in equilibrium. The area contains:

1. A dry pastoral zone with natural cover of dry steppe with annual rainfall of 200 mm or below.
2. An area of marginal farming with natural vegetation typical of dry savannah. Annual rainfall ranges from 400 to 600 mm making it suitable for growing millet and some sorghum (Figure 1).
3. A zone roughly comprising the Sudano-Sahelian, Sudan, and Sudano-Guinean (northern Guinea Savannah) areas carrying a cover of shrubs and trees. Rainfall ranges from 500 to 1200 mm making it suitable for a range of crops including sorghum, maize and a range of forages.

The soils in each of these zones are very old, highly weathered and low in fertility. Organic matter is limiting (usually <0.5%), CEC is low (<5 meq/100 g soil), and the colloidal fraction of the soil is very low. Total P is low (<200 ppm) as is available P (8–30 ppm Olsen method; Watanabe and Olsen, 1970). In general, the soils of these zones are very fragile and do not withstand intense pressures from population or cultivation (Bationo and Mokwunye, 1991; Pieri, 1992). An important point to remember about these soils is that almost all the nutrients (N, P and S) are found in the SOM. Loss of this component renders the soil non-productive.

### **Subhumid highlands**

There is a significant group of soils, called Vertisols, located in the highlands of East Africa that lend themselves to crop–livestock systems. These soils are comparatively shallow, high in expandable clay minerals (illite and montmorillonite), have a CEC of 30–45 meq/100 g soil, have adequate supplies of Ca, Mg and K and therefore have a pH of 6.5–7.5. The soils are low in available P (<10 ppm Olsen method; Watanabe and Olsen, 1970) and have modest amounts of SOM (<1.5%) and therefore crops grown on these soils respond well to N and P. These soils are usually not very permeable to rain, easily become waterlogged and are very hard when dry. Animal traction is required to till these soils.

### **Crop residues**

Crops are grown for a range of reasons. Farmers may use the entire above-ground portion of the crop (grain and stover), as in the case of alfalfa or maize for forage, or they may harvest just the grain or edible portions of the crop, as in the case of wheat, millet, sorghum, maize (for grain), rice and soybeans. Depending on the crop in question, the unused portion of the crop (crop residue) contains major quantities of plant nutrients and in particular, K, Ca and Mg. It is also a major source of organic matter.

Crop residues represent a major source of plant nutrients and, if properly processed and returned to the field from which they were grown, they could serve as an effective means of maintaining the organic and nutrient fraction of the soil. However, crop residues do not represent a new source of nutrients and therefore, their addition is not likely to correct nutrient deficiencies that prevailed in the soil from which the crop was grown. Furthermore, there are alternative and competing uses for crop residues, many of which prevent the return of nutrients to the soil of their origin. These uses include animal feed, energy sources, building material etc. The importance of these will be discussed in a later section of this paper.

### **Animal manures**

For centuries, animal manure was considered the only major external source of nutrients used to maintain the nutrient level of soils. The type, quality and quantity of available manure depends upon the animal enterprise and the degree to which it is integrated into the farming system. The nutrient composition of animal manure varies significantly with poultry manure being the richest followed by sheep/goats, cattle and swine (Bockman et al, 1990). In addition, there is great variation within a given source of manure as affected by feed management, handling of manures, and mode of application to soils. This is particularly true for the N and K components of the manure.

The value of manure is fully recognised by both the farmers and herdsmen of SSA. For example, agropastoralists concentrate their herds for as much time as possible in areas that are to be used for cultivation. If the pastoralists do not themselves cultivate the land, it is common for them, particularly in West Africa, to enter into arrangements with cultivators whereby herds are kept on fields destined for cultivation. Smallholder dairy farmers in the highlands of East Africa generally feed animals in stalls and are careful to collect manure in pits and store it. Also, in West Africa forage banks are being established in increasing numbers, in part, to attract herds for grazing in order to benefit from the animal droppings that result.

Like crop residues, animal manure may not represent a new source of nutrients and organic matter to a given soil. Manure merely represents a transfer of nutrients from one point to another. Animal droppings in arid and semi-arid zones are also important for their fuel value. The often scanty production of dry wood is needed for building temporary huts and of night enclosures for animals, while green woody vegetation is left as dry season fodder reserve. In this situation, the droppings may constitute the only available source of fuel (Jahnke, 1982).

### **Biological nitrogen fixation (BNF)**

A major source of N to many crops and natural vegetation is derived from legumes (woody and herbaceous). The quantities fixed from the air vary with the species, the fertility conditions of the soil and overall climatic conditions (La Rue and Patterson, 1981). The quantities fixed range from a high of 212–290 kg N/ha for alfalfa (*Medicago sativa*), white clover (*Trifolium repens*) and Egyptian clover (*Trifolium indica*) to lows of 10–30 kg of N/ha for common bean (*Phaseolus vulgaris*) and English pea (*Pisum sativum*). Soils low in available P and/or legume seeds that are poorly inoculated and/or planted in very acid soils frequently fix comparatively small quantities of N. Therefore, in many of the region's soils the crop will not fix much N unless the pH and P problems of the soil are corrected.

The BNF process requires and consumes considerable amounts of energy to fix N from the atmosphere and is very sensitive to stress conditions in soil (i.e. acidity, water and phosphate availability etc). In cropping systems used in areas extremely short of land and striving for maximum production, the N derived from legumes through the biological fixation process and related energy expended to fix this N must be carefully weighed against other alternative sources of supply.

The competition/complementary functions of crop–livestock systems is strongly modified by herbaceous/woody legumes capable of BNF. This is the case in the subhumid/semi-arid savannahs where land can be claimed for both livestock and crop production functions. The production of food

and forage legumes (herbaceous or woody) can supply N to current or subsequent non-legume crops, provide forage for livestock, organic material to build SOM as well as fuel and wood to meet local demand for energy and building materials.

### Commercial fertiliser

Throughout the world agriculture has intensified and the export of food, feed, meat and animal products from the farm has increased. It has become necessary to apply increasing amounts of commercial fertiliser to restore the plant nutrient status, and hence productivity, of a given soil. Since 1950 the world's population has more than doubled, increasing from 2.5 billion to just over 5.6 billion in 1993 (Stangel et al, 1993). During that period, world agricultural production more than matched the food and fibre needs of the planet's population. This increase has come primarily through increased yield per land unit area. Nutrients from soil reserves, crop residues, biologically fixed N (BNF), and manures supplied the majority (70%) of the nutrients required for the production of food and fibre before 1950. However, it was primarily the rise in the use of commercial fertiliser that accounted for at least 50% of the increase in production of food and fibre since 1950 and promises to account for the major share of any additional increases between 1992 and 2020 (Baanante et al, 1989; Bockman et al, 1990).

Agriculture in SSA has not experienced this rapid increase in production. Over the past three decades, yields per hectare of basic crops, i.e. sorghum, millet and maize, have remained static or actually declined and, because of the rapid increase in population, food production per capita has actually declined (UNDP, 1992).

Part of this poor performance is associated with improper agricultural policy. However, much of it is related to failure to recycle available nutrients and use commercial fertiliser (IFDC, 1993). As a result, fertiliser use in SSA lags far behind other regions in the world. In 1990, total fertiliser consumption amounted to 3.6 million tonnes of nutrients or less than 2.5% of the total consumed world-wide in 1990 even though the population of the region represented nearly 12% of the world total. As a result, fertiliser use on arable land for individual countries averaged from 4–50 kg/ha of nutrients and averaged about 12 kg/ha of nutrients for the region as a whole. This is about one-eighth of the 93.3 kg/ha world average (Stangel et al, 1993). Although there are plausible reasons for this poor performance in fertiliser use, it is highly unlikely that agriculture, and particularly crop–livestock systems, can survive in the region without the nutrient cycling systems becoming more closed and efficient and a dramatic increase occurring in the use of commercial fertiliser.

### Other sources

There are other sources of nutrients many of which occur in special locations and, where in close proximity to crop–livestock systems, could be used as either feed, bedding or source of crop residue. Examples of these are sugar cane, bagasse, saw-dust, rice hulls, brewers' grain and blood/hof meal derived from the sugar, lumber, milling, brewery and slaughter industries, respectively (Chaney et al, 1992).

## Nutrient cycling systems and source and magnitude of losses

Population pressures, absence of basic infrastructure, inappropriate agriculture policies and land tenure practices that prevent individual ownership of land collectively have had a major impact on the types of nutrient-cycling systems operating in the region and on the source and magnitude of nutrient loss within these systems.

### Major nutrient cycling systems

Four basic systems are advanced as examples of nutrient transport systems to and from a given land area. These vary in complexity and difficulty in effectively cycling nutrients. These systems are nutrient cycling in natural systems, agricultural cropping systems without direct livestock

involvement, commercial farming including crop–livestock enterprises and finally those involving a region (several farms, processing plants and one or more urban areas).

### Natural systems

This system is the simplest and most closed (Figure 2). Nutrients are made available in the soil through normal weathering processes. Plants take up these nutrients which in turn are assimilated into natural vegetation which dies and decomposes. The nutrients are returned to the organic and inorganic pools in the soil. Sources of nutrient loss in this system are limited to those directly related to natural processes operating in the soil due to erosion, leaching (mainly nitrates) and gaseous losses (ammonia volatilisation and denitrification as  $\text{NO}_x$ ). Nutrients are added to the system primarily from weathering (physical, chemical and biological) involving the colloidal mineral and organic pools. Nutrient additions (other than the parent material of soil) are from natural means and come from the atmosphere primarily as BNF derived from the native legumes (woody and/or herbaceous) present. While there may be transport of nutrients on and off the location by wildlife this is thought to be random (in and out) resulting in a zero balance from this source. Therefore, net nutrient losses in this system depend upon the degree to which the soil remains covered by natural vegetation.

**Figure 2.** *Nutrient cycling in natural systems.*

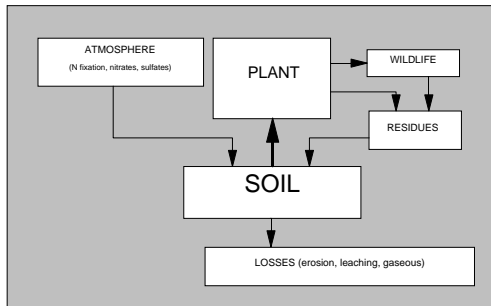

In the humid and subhumid zones of Africa the soil remains covered by significant quantities of natural herbaceous and woody plant species. The quantity of this is controlled by rainfall and the base fertility of the SOM and mineral fractions of the soil. As one moves toward lower rainfall zones the amount of biomass declines and soil cover may become more sparse. The amount of nutrients retained in the SOM becomes critical. As a result, losses due to soil erosion, by wind (in particular) and water, increases. Net nutrient losses in this natural system are likely to range from negligible amounts (1–3 kg/ha) in the humid and subhumid zones to significant (5–20 kg/ha) in the arid and semi-arid zones.

### Agricultural cropping systems

This system differs from the previous one regarding nutrient cycling in three basic areas. First, soils must be disturbed (tilled) once or twice a year to plant agricultural crops like millet, sorghum, maize

and cowpeas. Second, crops are sold (hence nutrients) and transported off the farm and third, fertiliser from external sources may be added to the soil (Figure 3).

**Figure 3.** Nutrient cycling in an agricultural cropping systems.

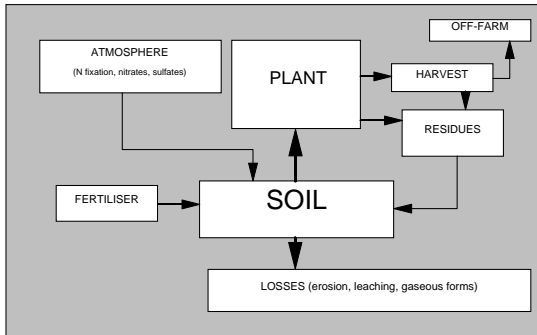

Disturbing the soil by various means of tillage dramatically increases the biological activity of the system (IITA, 1992). This results in rapid conversion of the organic pools of nutrients into the inorganic form that is readily available to plants and subject to loss. As a result of this the SOM drops to a new steady state equilibrium, frequently only one half to three-fourths the level that prevailed in the natural system (Stangel et al, 1993). The actual level will be determined by the amount of crop residue returned to the soil. The freshly released nutrients in this soil are vulnerable to potential loss mechanisms such as leaching ( $\text{NO}_3\text{N}$ ), volatilisation ( $\text{NH}_3$ ) and denitrification ( $\text{NO}_x$ ). These losses can be minimised depending upon the type of crop that is planted and the percentage of time the soil is covered by an actively growing crop.

Soil tillage also exposes the soil to losses due to wind and water erosion. This involves the colloidal component of both the mineral and organic fractions of the soil. Loss via this mechanism can be as little as 5 t and as much as 100 t of soil per hectare per year (Lal, 1990). Major quantities of SOM are lost thus strongly affecting the N, P and S nutrient levels in the soil. Where significant expandable clays are present in the colloidal fraction, major quantities of Ca, Mg and K are also lost.

Off-farm transport of agricultural products can result in the movement of anywhere from 25–40 kg/t of grain produce sold (Pieri, 1992) and triple that amount per tonne if the entire above-ground portion of the crop is sold. If crop residue is retained but burned, as much as 60% (Greenland and Nye, 1960) of the N and S are lost to the atmosphere.

Nutrient additions from the atmosphere (mainly as BNF) from commercial fertiliser can be substantial. Depending on the crop, amounts anywhere from 10–300 kg/ha of N may be added if a legume is planted as a main crop or included in the crop rotation. Commercial fertiliser is used to make up the deficit required to sustain the desired crop yields. Frequently this is not possible because commercial fertiliser may not be available or is uneconomical to use (IFDC, 1992). If fertiliser is improperly used, considerable losses may occur (Stangel, 1982). For example, urea N if surface applied

and not worked into the soil may lose anywhere from 10–60% of the amount of N applied. Similarly, N supplied in the nitrate form is highly subject to leaching losses the magnitude of which are affected by the time and method of application, amount of rainfall and crop grown.

There may be net gains or losses of nutrients within this system. These may range from a positive 20–50 kg of nutrients per hectare per year to a loss in excess of 100 kg of nutrients per hectare per year if serious erosion occurs, residues are not returned and fertilisers are not added.

### Commercial crop–livestock enterprises

This system has a large potential for major gains or losses of nutrients. All the mechanisms of gains or losses described in the natural system and the agricultural crop systems are operative in the commercial crop–livestock system. However, there are three additional variables involving livestock that could tilt the nutrient budget to a net gain or net loss (Figure 4).

**Figure 4.** *Nutrient cycling on a commercial farm including crop and livestock enterprises.*

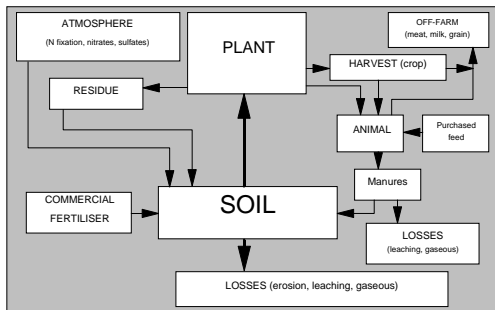

Linking the crop–livestock enterprises allows the conversion of some of the harvested crop from the farm to be converted to meat and various livestock by-products (milk, eggs and wool). This allows a major portion (40–85%) of the crop that would have otherwise been sold to be returned to the field in the form of animal manure. Therefore the inclusion of livestock in the system provides added value to the feed grain and returns anywhere from 40–80% of the nutrients that would otherwise be exported off the farm as feed grain or food. Additional nutrients are also introduced in the form of feed concentrates and forage that when fed through animals can be returned to the soil in the form of manure. It is therefore possible, if soils, crops, fertiliser and manures are carefully managed, for the input/output of nutrients to be in equilibrium or even surplus. This would depend on the quantities of feed purchased, manure effectively managed and returned to the soil and commercial fertilisers used. Unfortunately the present system of handling manures leads to losses ranging from 30–80% of the N and up to 90% of the K that may have been present. In addition, animal feed purchased in most crop–livestock systems results in a net transfer of plant nutrients (through nomadic pastoral grazing and forage banks) from natural and agricultural cropping systems to the crop–livestock enterprises. As a result the crop–livestock enterprises may show a nutrient balance or even a surplus for the immediate area

whereas the other two systems will have an even greater deficit than previously thought if the nutrients contained in the feed transferred were not replaced. The net result is that there may be major distortions in the fertility of soils, causing environmental damage to both systems either because of too much or too little nutrient.

### Nutrient cycling within a region

Environmental concerns will increasingly force the linkage of nutrient cycling in crop–livestock systems to entire watersheds and the nutrient handling systems contained therein (Stangel et al, 1993). This is important to the discussion for three basic reasons. First, the final destination of food and fibre shipped off the farm is primarily to meet the needs of the urban population (Figure 5). This means many of the nutrients end up in the various processing plants, land fills, sewage treatment plants and rivers in or near the major cities. For sub-Saharan Africa, this could amount to about 2–6 kg/ha of nutrients per person per year or 1–3 million tonnes of nutrients that are excreted annually by humans, 50% of whom live in urban areas. In addition to this source, there are other livestock-related processing plants located in or near the major cities that also serve as a source of plant nutrients. Ironically, the region as a whole may show a net surplus in nutrients while individual farms may show a negative balance. Eventually efforts will need to be made to recycle these nutrients back to agriculture. Nutrient losses within this cycle remain unchecked and will become an increasing problem to urban areas if corrective measures are not taken. This will be a major problem for landless livestock enterprises which are usually located in close proximity to cities.

### Major sources of nutrient loss

#### Soil erosion

Nutrient loss due to soil erosion is perhaps the number one threat to the productivity of crop–livestock systems. Fully 40% of all nutrient losses in SSA is due to soil erosion. This has a devastating effect not only on the mineral content of soil but also on the soil itself. While a soil can be formed in as little

Figure 5. Nutrient cycling in a region.

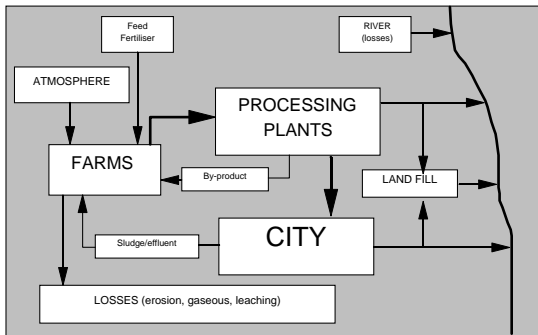

as 200 years in the humid tropics, under normal conditions in most parts of SSA it takes anywhere from 100–400 years to produce 1 cm of soil and between 3000 and 12 000 years to build enough soil to form productive land (FAO, 1992). This means that soil is, in effect, a non-renewable resource. Once destroyed, it is gone at least for the foreseeable future.

Major erosion occurs in the highlands of Ethiopia, Kenya, Tanzania, Uganda, Malawi, Zambia and Lesotho where losses of 15–30 t/ha per year are common (Balek, 1977; Brown, 1981; Chaklea, 1981). Some of the highest rates of soil loss occur in Madagascar and Nigeria where between 100 and 250 t/ha per year have been measured (Fournier, 1966; Oyebande, 1981). Severe erosion also occurs in the mountainous and undulating regions of subhumid and semi-arid sub-Saharan Africa. Severity of erosion in all these regions is attributed to high population density, soils that are prone to erosion due to both harsh climate and intensive arable land use, uncontrolled grazing and excessive stocking rates, and soil profile characteristics that render them susceptible to under cutting and gully erosion.

### **Alternative uses for crop residues and manure**

The second major loss of nutrients to the soil of SSA is caused by the failure of farmers and herdsmen to recycle crop residues and manures back to the soils. This creates a nutrient deficit in the soil. More importantly this deprives the soil of a major source of organic matter needed to protect existing nutrients from further loss or immobilisation.

There is ample, albeit indirect, evidence that there are strong external forces (demand for energy, fodder and building materials) competing for crop residue produced on-farm. As a result, the nutrients available to the crop are frequently diverted to non-farm uses (in the case of forage, non-crop uses) with the net effect that basic soil fertility and overall crop production declines. The reasons for this have been well documented by a number of researchers — most recently in identifying agricultural production constraints in the Sudano-Sahelian zone of sub-Saharan Africa (Pichot et al, 1981; Pieri, 1986; 1989; Bationo and Mokwunye, 1991; Pieri, 1992). Mokwunye (1993) states that fully half, and in many cases all, of the crop residues in farmers fields in West Africa are for non-farm use.

### **Leaching and gaseous losses**

Nitrogen, when converted and applied as urea, nitrate, ammonia or ammonium form to the surface of most soils, is prone to losses either through leaching or gaseous avenues (denitrification or volatilisation). In addition, S in the sulfate form can be lost through leaching or if burned in crop residues, can be volatilised.

Up to 60% of N and S can be lost if crop residues are burned. Anywhere from 10–50% of the N in fertiliser can be lost if surface applied as urea (IFDC, 1993). The availability of N declines as manures age and are composted. As manures are exposed to wetting, drying and microbial activity, the inorganic forms of manure are lost by leaching and volatilisation and the more readily decomposed organic N compounds are converted to more stable forms (Chaney et al, 1992). In general, composts and manures containing less than 1.5% N (dry basis) will supply little or no N to crops in the first few weeks. Moist manure, when exposed to the air, undergoes significant loss of N as volatile ammonia. Losses can reach 15%/day and be especially severe if surface applied on warm windy days when the evaporative potential is high.

### **Net impact of losses**

The major problem constraining the improvement of nutrient cycling in crop–livestock systems is the lack of a proper supply of plant nutrients and the lack of a stable livestock system. Evidence to support this has been advanced by several researchers (Pieri, 1986; 1989; Stoorvogel and Smaling, 1990; Bationo and Mokwunye, 1991; Pieri, 1992). They have concluded that phosphate, N and S (in that order) are the nutrients most limiting to crop growth in the Sudano-Sahelian zone, (there is also evidence that these nutrients are the most limiting in other regions of SSA). These workers have



recognised that commercial fertiliser is an effective and essential means of increasing yields in arable farming systems without fallows. However, Pieri (1989; 1992) cautions that long-term problems may arise, especially in the more arid areas if only chemical fertiliser containing N, NP, or NPK are used. He points out that most of the soils are low in exchangeable Mg and Ca and generally acid. To substantiate this observation, he cites Pichot et al (1981):

*Application of NP and NPK fertiliser results in increased yields for some years, but in the long run leads to decreasing base saturation, acidification of the soil, and a drop in soil pH. These phenomena, associated with the use of only N fertilisers, are characterized by increasing K deficiency, decreasing pH and occurrence of Al toxicity. Application of organic matter, such as green manures, crop residue, compost or animal manure counteract the negative effects of chemical fertiliser.*

Pieri (1989) accepted the basic premise of Pichot et al (1981) that soil fertility in intensive arable farming systems in the Sudano-Sahelian zone can only be sustained through efficient recycling of organic material, in combination with effective use of N-fixing leguminous species and chemical fertilisers. However, he took issue regarding the benefits of green manure and crop residues as to their real contribution in building stable levels (humic) of organic carbon in soil. These materials overstimulate microbial activity which results in excessive mineralisation of native SOM and eventually the immobilisation of N during the decomposition process. Crop residues and forages should be composted or preferably recycled through the animal. Stoorvogel and Smaling (1990), Bationo and Mokwunye (1991) and Pieri (1992) further pointed out the difficulty of recycling the crop residue or collecting adequate supplies of animal manure. They felt that until a more stable livestock system was introduced and alternative sources were found for competing off-farm forces (energy and building material) for crop residues and manure, it would be impossible to sustain the base fertility of the soils within the region without heavy reliance on external inputs. They have showed that much of the Sudano-Sahelian zone possesses an abundance of naturally occurring phosphate rock which when finely ground can serve as an effective source of phosphate for the crop (IFDC, 1990).

## Basic strategies for improving the efficiency of nutrient cycling

There are several lessons to be learned from the information presented in the previous section. Collectively these lay the foundation for understanding the magnitude and nature of the problem. In addition, they allow one to postulate basic strategies for pilot projects and researchable areas that, if successful will lead to an improvement in the efficiency of nutrient cycling for key crop–livestock systems. Eventually these will allow the orderly development of a sustainable soil fertility programme that will effectively support a series of crop–livestock systems that are not only economically viable but also socially acceptable and environmentally sound. The purpose of this section is to identify this foundation and outline this strategy.

### The foundation — Understanding the problem

The key issues upon which this strategy is designed to address can be summarised in five statements.

*Nutrient cycling, as currently practised in most crop–livestock systems operating in SSA on the average, is very poorly linked. As a result, major net losses of nutrients occur from soils that produce the feed grain, fibre and forage.*

The magnitude and type of loss depends on a host of factors including the intensity in the production and management of the crop–livestock systems, the degree to which nutrients in crop residues and manure are returned to the soils of origin; the amount and magnitude of losses caused by leaching, soil erosion, surface runoff and volatilisation; products sold off-farm (meat, milk and grain); and the quantity of external inputs (feed concentrate and chemical fertiliser) that are used and applied to the cultivated soils. While precise estimates are difficult to obtain and few are reported, recent work suggests nutrient losses from the farm region and country levels can be substantial. For example, work

by Stoorvogel and Smaling (1990) suggests nutrient losses in 1983 for the SSA region as a whole averaged 49 kg/ha (23 kg N, 7 kg P<sub>2</sub>O<sub>5</sub> and 19 kg K<sub>2</sub>O) of arable land and represented 9.3 million tonnes of nutrients (N, P<sub>2</sub>O<sub>5</sub> and K<sub>2</sub>O) for the region as a whole. They further projected annual losses to increase 40% by the year 2000 and will average 60 kg/ha (27 kg N, 8 kg P<sub>2</sub>O<sub>5</sub> and 25 kg K<sub>2</sub>O) and 13.3 million tonnes of nutrients annually for the region. Losses for individual countries are also significant averaging 350 000 t of nutrients for Zimbabwe (Stoorvogel and Smaling, 1990) and 235 000 t of nutrients for Togo (IFDC-Afrique, 1991).

*Agriculture as presently practised in SSA cannot be sustained and will eventually collapse if the present rate of nutrient losses is allowed to continue.*

Most of the soils in the region are old, highly weathered and therefore already low in base fertility (particularly in N, P and S). They are also very fragile and very sensitive to changes in soil chemistry (i.e. low in cation exchange capacity, low in organic matter, and have only a limited supply of expandable clay minerals) and hence become unstable when one or more of these variables is only marginally changed. This is a glaring weakness in the critical natural resource base that supports most agricultural systems in the region. It is this basic weakness coupled with the ever-increasing pressure from an exploding population (animal and human) that will almost certainly push large segments of African agriculture into a state of decline. Once this trend begins to accelerate and if the fertility of the soil resource base is not restored, major soil degradation will occur (in many cases irreversible) and damage to the environment will extend the levels of destruction to areas far beyond the points of origin.

*Improved efficiency of nutrient cycling in the current as well as improved crop–livestock systems is the only real choice most farmers and livestock entrepreneurs of the region have to stop and eventually reverse the present trends in nutrient loss.*

Linking the strategy to reduce nutrient losses to improved nutrient cycling in crop–livestock systems is critical to the overall development of agriculture within the region. The region lacks the resources to finance and the infrastructure to distribute large quantities of commercial fertiliser. The region is also locked into a strong communal land tenure system that discourages individual efforts to improve land productivity. This strategy is necessary because demand for meat and animal by-products is increasing at a rate more rapid than that of other major agricultural products (i.e. demand for meat, dairy products, eggs and other by-products for groups experiencing rising incomes, particularly in cities, is relatively inelastic when compared to demand for basic cereals). While increased production of cereals is possible in most parts of SSA, farmers have difficulty in disposing of marketable surplus directly to cities because of limited markets and low prices. Therefore, the increased production and improved quality of cereals and fodder crops are essential ingredients to the success of most livestock systems and an important incentive to many farmers producing agricultural crops. Linking these systems more closely through the sale of cereals and forages in exchange for manure and animals will improve nutrient cycling and result in an increase in the overall fertility and productivity of the soil.

*Tangible and sustainable reductions in nutrient losses and improvements in nutrient cycling must involve dialogue with, and active participation by individuals from key institutions at the national, regional, local and the entrepreneurial levels.*

There are comparatively few factors under the direct control of the individual or village authorities that are immune to external influences and which will have a direct impact on reducing nutrient losses. Conversely, actions on key factors by the regional or national authorities require strong local and individual support if they are to be adopted by individual farmers or villages. The more significant of these factors are:

- strong cultural attitudes toward land ownership (communal grazing lands and land tenure)
- scarcity of capital
- limited infrastructure (farm to market roads and water access to ports)

- lack of basic agricultural institutions
- lack of or improper agricultural policies (proper prices and incentives needed for long-term investments)
- scarcity of commercial energy supplies
- improper monetary policy
- under-developed marketing systems for inputs and outputs.

A number of these problems are best addressed at the national level. However, because of the diverse set of conditions at the local level (culturally, physically and economically), solutions must be tailored to local conditions. Otherwise, the entire effort will fail.

*Limitation of capital resources and strong cultural, political and economic influences make it critical that realistic and clear priorities are set and a plan of action agreed upon before strategies are implemented.*

There are vast differences in the goals of the society, the individual and the various crop–livestock systems operating in SSA. Six goals for crop–livestock systems can be defined: profit, quality of food/feed, accumulation of assets, reduction in nutrient losses, employment and land conservation. The satisfaction of these goals in accordance with producer and societal expectations is central to the successful implementation of any strategy designed to curb nutrient losses and improve nutrient cycling. In dairying, for example, the high capital requirements for this enterprise forces managers to maximise profits, strive for quality of feed/food, implement land conservation policies and put into place practices that will cause a reduction in N, P and K losses. The likelihood of farmers doing this will be determined by the degree of control the farmer has over his land (ownership or at least long-term leases). However, asset accumulation (in the form of cattle numbers) and employment are more important for range systems and of paramount importance in pastoral systems. Thus within this comparison it will be easiest to implement practices to reduce nutrient losses and improve the efficiency of nutrient cycling in crop–dairying systems (assuming the land tenure problem can be solved) and most difficult in pastoral–crop systems. Knowledge of these different goals, their relative importance and the ability to prioritise them at the operational level is crucial if the limited resources available to the system are to be used effectively.

In summary, the current system of nutrient cycling in the crop–livestock systems of SSA results in extensive nutrient losses to the soil system, is the root cause of the current decline in soil fertility and productivity and if it continues at the present rate will cause serious and perhaps permanent damage to the region's land resource base. The region lacks the basic infrastructure and the financial resources to be able to correct this through a direct import of chemical fertilisers and feed concentrates. However, the region does possess considerable indigenous sources of phosphate and other potential inputs. Therefore, crop–livestock systems, if better co-ordinated and more interactive, offer a major solution to the nutrient-loss problem through improved efficiency in nutrient cycling by better utilising manures, crop residues and increased use of external inputs (feed concentrates and fertiliser) to stimulate production of crops, livestock or both. Tangible solutions to this problem and implementation of these strategies require input not only at the national and regional levels but more specifically involvement of individuals and institutions at the local level. Furthermore, these solutions must be prioritised in accordance with the economic, cultural and political goals of the crop–livestock system in question. These fundamental principles are central to the basic strategy presented in the next section.

## **The strategy**

The solution to the problems outlined in the previous section must reduce the amount of crop residue and manure that are diverted to non-agricultural uses; reduce by at least three-fourths, the magnitude of soil and plant nutrients lost due to soil erosion; and increase by at least one-half the amount and quality of animal manure and crop residue that is recycled through animals and effectively returned to the soil. To accomplish this, several options are proposed. These come under the headings of "pilot

projects" (i.e. the basic and applied research has been done but, now must be adopted to specific areas) involving the market testing of specific technologies already proven and "researchable areas" where further basic and applied work needs to be done but, targeted specifically to provide solutions to the problems outlined in the previous section.

### **Pilot areas**

Pilot projects are proposed that address four distinct areas. These include the establishment of:

- soil fertility reserves to serve crop–livestock systems
- agroforestry zones aimed at serving livestock but, also controlling soil erosion, supplying N to crops and providing at least a partial solution to the energy/building material problem
- agricultural input/output centres allowing farmers and herdsman ready access to basic inputs and opportunities to sell basic outputs
- land-use centres that provide a practical solution to the land tenure problem while providing the farmer and herdsman the opportunity to invest in technologies that will reduce soil erosion, build soil fertility and encourage careful use of indigenous resources (land, agromineral, manures and crop residues).

### **Fertility reserves**

In a sense, these already exist as forage banks in West Africa. The concept could be expanded to include the establishment of fertility reserves on communal lands in the arid/semi-arid zones (400–800 mm rainfall per year) where finely ground phosphate rock could be applied to specific zones and drought-tolerant forage legumes planted. The idea is to create a reserve of forage that would be used during periods of shortage. It would hopefully reduce the extent of overgrazing and foster closer linkages between crop–livestock enterprises.

### **Agroforestry zones**

These would build on the concept of alley cropping, offset its limitations and provide a basis for good land management. These measures would reduce soil erosion, provide a source of animal feed and also serve as an alternative to crop residues as a source of energy and building materials. By so doing, major strides may be made in reducing the two major causes of nutrient loss.

### **Agricultural input/output centres**

It is highly unlikely that any agricultural production system will be able to intensify to sufficient levels to meet the basic demands of an expanding population without the intensive use of inputs. The creation of the basic institutional framework to supply agricultural inputs (animal feed, seed, fertiliser etc) and, at least initially, to purchase certain outputs to ensure proper cash flow is central to any strategy designed to improve the effectiveness of basic crop–livestock systems. Provision of a limited amount of inputs will help close the nutrient cycle and thereby improve the overall efficiency of recycling nutrients in these systems.

### **Land-use centres**

Perhaps the greatest impediment to reducing the nutrient losses is the limited amount of individual ownership that is allowed. Strategies need to be developed that allow farmers and herdsman alike to make long-term investments in the land that will reduce erosion, make better use of water and build production and fertility of the soil.

## Researchable areas

A significant amount of basic and applied research needs to be done to backstop the nutrient cycling work done in the pilot areas and at the same time anticipate and address the nutrient cycling problems likely to occur in crop–livestock systems over the next decade. These researchable areas include studies on nutrient balance, SOM management, indigenous based nutrient supply systems, strategies to reduce nutrient losses in animal-based nutrient supply systems, reducing the diversion of crop residues and manures to non-farm uses and identifying the impact landless livestock systems are likely to have on the environment of surrounding urban areas.

### Nutrient balance studies

There is increasing evidence that the nutrient balance studies of the type conducted by Stoorvogel and Smaling (1990) and IFDC-Afrique (1991) need to be done at more locations at the field, watershed and national levels. The crop–livestock interaction needs to be studied more closely and estimates of off-farm transport of animal products and by-products verified and refined. In addition, the estimates of nutrient losses in various storage, handling and application systems need to be refined.

### Soil organic matter management

Maintaining SOM in equilibrium is extremely important to sustainable land-use management particularly in the arid and semi-arid zones. Efforts must be made to find ways of building SOM back to equilibrium levels feasible in the natural state. The potential for animal manure to counter the effects of soil acidity resulting from the use of fertilisers also need to be investigated. This is particularly true for crop–livestock systems in the Sudano/Sahelian interface. The contribution of root mass distribution also needs investigation and researchers should expand on the work done by Lamotte and Bourliere (1978) and Chopart (1980). These researchers showed that naturally occurring species of shrub and grassy savannah contribute 10–30 times as much root mass as do cultivated crops such as sorghum, pearl millet, groundnut and maize.

### Indigenous-based nutrient supply systems

Considering the serious limitations in infrastructure, the generally weak economies and the limited institutional framework, it is highly unlikely that SSA will be able to finance massive imports of key agricultural inputs. Most of these basic needs will have to be met through the use of indigenous resources. Pieri (1989) and Bationo and Mokwunye (1991) proposed a system whereby legumes (tree and animal crops) should be combined with judicious use of phosphate (mainly from local deposits of phosphate rock) and significant quantities (2–5 t/ha) of manure or crop residue supplemented by the import of some fertiliser. The research in this area should include evaluation of various sources of BNF (trees and annual legumes) to supply N to crops and be fed through livestock; the value of local phosphate rocks as a P source to the system; the ability of the farmers to recycle manure and retain crop residue; and the need for, and the availability of external input (animal feeds and fertiliser).

### Strategies to reduce nutrient losses

The entire nutrient cycling system in crop–livestock systems is too leaky. Major steps need to be put forth to reduce the nutrient losses particularly in storage/handling and application. In addition, major efforts need to be made to find a means to confine livestock such that some external means of management might be used to reduce losses in paddocks, feedlots and stalls.

### Reducing the diversion of crop residues and manure

While several other projects proposed indirectly address this area, it is so important to the success of any effort to improve nutrient cycling that a specific direct effort needs to be made to solve this

problem. This research should include the effect ruminants have in decomposing hemicellulose, lignocellulose and other compounds difficult to use as animal roughage and the subsequent value of these products as manure.

### **Environmental impact of landless livestock systems**

Most landless livestock systems (poultry and swine) are increasingly located at or near urban areas. This trend is likely to continue as urbanisation accelerates and personal incomes rise. Considering the already poor sanitation facilities in and around urban areas and recognising the limited capacity of many of the soils in SSA it is not too early to examine the potential of this problem and lay the groundwork for research programmes that will recover and possibly recycle nutrients back to the cropland.

### **Conclusions**

Efficient nutrient cycling is an essential component of most crop–livestock systems if they are to be sustainable in the long run. The fallow systems of nutrient cycling currently practised by the majority of the farmers and herdsmen in sub-Saharan Africa have been developed over a number of centuries. These systems were developed when population pressures were lower and the opportunities to increase production through expanded land use were substantial. As population pressures have increased expansion to marginal lands has resulted and increases in production have not kept pace with population demand. The fallow component of the crop cycle has been shortened and, in some cases, eliminated. Soil fertility has therefore been reduced and overall productivity levels have declined.

There are several sources of plant nutrients that may be used to increase soil fertility. These include soil reserves, crop residues, biologically fixed nitrogen, animal manures, commercial fertilisers and a number of special sources from industrial waste. The soil reserves of nutrients for most of sub-Saharan Africa are low by world standards. This is particularly true for N, P and S. Crop residues grown on these soils frequently reflect these limitations by containing comparatively low levels of these nutrients. There are opportunities to add BNF via the growth of legumes (herbaceous or woody). However, the amount fixed is limited if the low P and acid conditions of the soil are not corrected. This low fertility situation is further aggravated by the diversion of large amounts of crop residue and manure for use as energy and building material. In addition, limited infrastructure and high cost prevent the use of commercial fertiliser. Average rates of application are about 12 kg/ha per year or about one-eighth of the 93.3 kg/ha per year for the world. This low base fertility and inability of the system to return crop residues and manures has led to some very serious soil problems that, if not corrected, threaten the entire crop–livestock system in SSA. Overgrazing and overstocking, failure to build soil fertility and lower amounts of organic matter in soil have caused severe soil erosion in many areas resulting in losses of soil at rates of 15–100 t/ha per year. Collectively this has led to serious drops in soil productivity.

Preliminary estimates of net nutrient losses from all sources (and taking into account additions) suggest that an average of 49 kg/ha per year are lost annually. This is expected to increase by 40% by the year 2000 will average at over 60 kg/ha per year. This totals 9.3 million t/yr for 1983 (Figure 6) and is expected to rise to nearly 14 million t/yr by 2000. Approximately 70% of these losses are due to soil erosion and diversion of crop residues and animal manures to non-farm use.

A strategy to reduce nutrient losses by at least one-half and build soil fertility to improve nutrient cycling in crop–livestock systems is proposed and includes the development of pilot areas to verify and adapt research findings to local conditions. This includes the establishment of soil fertility reserves (forage banks and commercial grazing areas), creation of agricultural input and output centres, design of agroforestry areas, and development of land-use centres. All of these are designed to test and demonstrate technologies that will curb soil erosion, meet the non-farm energy and building material

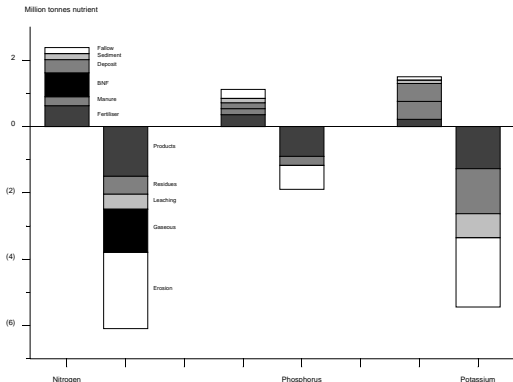
**Figure 6.** NPK balance for sub-saharan Africa — 1983.

Source: Stoorvogel and Smaling (1990).

needs, encourage long-term investment in land conservation and build soil fertility and nutrient crop cycle systems that will sustain the long-term growth of integrated crop-livestock systems.

Research areas are also needed. Activities identified include: nutrient balance studies with emphasis on the role of livestock in nutrient cycling, improved management of SOM, identification of ways to curb nutrient losses and investigate the potential environmental problems of landless livestock systems.

## References

- Baanante C A, Bumb B L and Thompson T P. 1989. *The benefits of fertilizer use in developed countries*. IFDC Paper Series P-8. IFDC (International Fertilizer Development Center), Muscle Shoals, Alabama, USA.
- Bationo A and Mokwunye A U. 1991. Role of manures and crop residue in alleviating soil fertility constraints to crop production with special reference to the Sahelian Sudanian zones of West Africa. *Fertilizer Research* 29:117–125.
- Bockman O C, Kaarslad O, Leie L H and Richards I. 1990. *Agriculture and fertilizers*. Agricultural Group, Norsk Hydro a.s., Oslo, Norway. 245 pp.
- Brumby P. 1979. The dairy situation in India. *Indian Dairyman* 357–364.
- Chaney D E, Drinkwater L E and Pettygrove G S. 1992. *Organic soil amendments and fertilizers*. University of California, Oakland, California, USA. 36 pp.
- Chopart J L. 1980. *Etude au champ des systèmes racinaires des principales cultures pluviales au Sénégal (arachide-mil-sorgho-riz pluvial)*. PhD thesis, Veg. Qual. Prod. Inst. Nat. Polytech de Toulouse, France. 160 pp.

- Duxbury J M, Smith M S and Doran J W. 1989. Soil organic matter as a source and sink of plant nutrients. In: Coleman D C, Oades J M and Uehara G (eds), *Dynamics of SOM in tropical ecosystems*. University of Hawaii Press, Honolulu, Hawaii, USA. pp. 33–67.
- Edwards C A. 1990. Sustainable agricultural systems. In: Edwards C A, Lal R, Madden P, Miller R H and House G (eds), *Sustainable agricultural systems*. Soil and Water Conservation Society, Ankeny, Iowa, USA. 696 pp.
- FAO (Food and Agriculture Organization of the United Nations). 1978. *Report on the agro-ecological zones project. Vol. 1. Methodology and results for Africa*. World Soil Resources Report 48. FAO, Rome, Italy. 158 pp.
- FAO (Food and Agriculture Organization of the United Nations). 1992. *Protect and produce*. FAO, Agriculture Department, Rome, Italy. 36 pp.
- Fox R L. Phosphorus – A basic nutrient for soil improvement. In: *Proceedings of the International Conference on the Management and Fertilization of Upland Soils in the Tropics and Subtropics*. Nanjing, People's Republic of China.
- Harwood R R. 1990. A history of sustainable agriculture. In: Edwards C A, Lal R, Madden P, Miller R H and House G (eds), *Sustainable agricultural systems*. Soil and Water Conservation Society, Ankeny, Iowa, USA. pp. 3–19.
- IAEA (International Atomic Energy Authority). 1984. *Soil and fertilizer nitrogen*. Technical Report Series 244. IAEA, Vienna, Austria.
- IFDC (International Fertilizer Development Center). 1990. *International Fertilizer Development Center Annual Report 1989*. IFDC, Muscle Shoals, Alabama, USA.
- IFDC (International Fertilizer Development Center). 1992. *International Fertilizer Development Center Annual Report 1991*. IFDC, Muscle Shoals, Alabama, USA.
- IFDC (International Fertilizer Development Center). 1993. *International Fertilizer Development Center Annual Report 1992*. IFDC, Muscle Shoals, Alabama, USA.
- IFDC-Afrique. 1991. "Approvisionnement, commercialisation et demande des engrais en République du Togo", Centre international pour le développement des engrais — Afrique, Lomé, Togo. IFDC (International Fertilizer Development Center), Muscle Shoals, Alabama, USA.
- IITA (International Institute of Tropical Agriculture). 1992. *Sustainable food production in sub-Saharan Africa IITA's contribution*. IITA, Ibadan, Nigeria. 208 pp.
- ILCA (International Livestock Centre for Africa). 1992. *ILCA 1991: Annual Report and Programme Highlights*. ILCA, Addis Ababa, Ethiopia. 81 pp.
- Jahnke H E. 1982. *Livestock production systems and livestock development in tropical Africa*. Kieler Wissenschaftsverlag Vauk, Kiel, Germany. 253 pp.
- King L D. 1990. Soil nutrient management in the United States. In: Edwards C A, Lal R, Madden P, Miller R H and House G (eds), *Sustainable agricultural systems*. Soil and Water Conservation Society, Ankeny, Iowa, USA. pp. 89–106.
- Lal R. 1990. Soil erosions and land degradation. In: Lal R and Stewart B A (eds), *Advances in soil science*. Vol. II. Springer-Verlag, New York, USA. pp. 129–172.
- Lamotte M and Bourliere F. 1978. *Problèmes d'écologie, structure et fonctionnement des écosystèmes terrestres*. Masson, Paris, France. 345 pp.
- La Rue T A and Patterson T G. 1981. How much nitrogen do legumes fix? In: Braady N (ed), *Advances in agronomy*. Vol. 34. American Society of Agronomy, Madison, Wisconsin, USA. pp. 15–38.
- Nye P H and Greenland D J. 1960. *The soil under shifting cultivation*. Commonwealth Bureau of Soils Technical Communications 51. Harpenden, UK. 156 pp.
- Pieri C. 1986. Fertilisation des cultures vivrières et fertilité des sols en agriculture paysanne subsaharienne. *Agronomie Tropicale* 41:1–20.
- Pieri C. 1989. Fertilité des terres de savannes. *Bilan de trente ans de recherche et de développement au sud du Sahara*. Agridoc-International, Paris, France. 444 pp.



- Pieri C. 1992. *Fertility of soils — A future for farming in the West African savannah*. Springer-Verlag, Paris, France. 346 pp.
- Rattan V W (ed). 1992. *Sustainable agriculture and the environment: Perspectives on growth and constraints*. Westview Press, Boulder, Colorado, USA.
- Sanchez P A. 1976. *Properties and management of soils in the tropics*. John Wiley and Sons, New York, USA. 618 pp.
- Sanchez P A and Benites J R. 1987. Low-input cropping for acid soils of the humid tropics. *Science* 238:1521–1527.
- Stangel P J, Pieri C and Mokwunye U. 1993. Maintaining nutrient status of soils. In: Greenland D (ed), *Soil resilience and sustainable land use*. CABI (Commonwealth Agricultural Bureaux International), Wallingford, UK (in press).
- Stoorvogel J J and Smaling E M A. 1990. *Assessment of nutrient depletion in sub-Saharan Africa: 1983–2000*. Wageningen, The Netherlands.
- TAC (Technical Advisory Committee). 1988. *Sustainable agricultural production: Implications for international agricultural research*. (AGR/TAC: IAR 87/22). CGIAR (Consultative Group on International Agricultural Research), Washington, DC, USA. 108 pp.
- UNDP (United Nations Development Programme). 1991. *Special report on the African crisis*. UNDP, New York, USA. 55 pp.
- Watanabe F S and Olsen S R. 1970. *Soil Science Society of America Proceedings* 29:677–678.

# **Interactions between animals and plants**

# Animal/plant interactions: Nutrient acquisition and use by ruminants

*J.W. Stuth, R.K. Lyons and U.P. Kreuter*

Ranching Systems Group, Department of Rangeland Ecology and Management  
Texas A&M University, College Station, Texas, USA

## Abstract

Nutrient intake constitutes the interface between animals and plants within the soil–water–atmosphere–plant–animal–human (SWAPAH) continuum. This interface also represents a major impact point of human management decisions affecting the animal's well being, ecosystem productivity for human endeavours, biodiversity of plants and animals, nutrient cycling, water quality/yield and soil stability. The hierarchical nature of herbivore diet selection processes and associated physiological needs, relative to the spatial configuration of natural and man-made landscape features, sets limits regarding where animals harvest nutrients and how effectively nutrients are ingested, absorbed and recycled in the ecosystem. The selected mix of animal species and their dietary requirements, relative to the available diversity of plant species, determines how efficiently nutrients are acquired at the landscape level. The nutritional balance of the grazing ruminant is determined by a complex set of factors regulating dry-matter intake, diet quality/composition, and nutrient requirements for critical animal physiological processes. To understand the factors influencing dry-matter intake requires knowledge of a species' sex/age class and breed attributes, physiological stage, effects of terrain on foraging energetics, environmental conditions (temperature, wind, mud/snow), forage quality/availability, and use of supplemental feeds, minerals, hormones and ionophores. The amount of nutrients harvested relative to the animal's requirements determines the potential of the animal to convert critical nutrients, particularly crude protein and energy, for weight gain, milk production, reproductive performance and offspring performance. This paper presents a "whole-animal-system" perspective of nutrient acquisition in the context of the SWAPAH continuum. Emerging nutritional decision support systems and faecal near-infrared reflectance spectroscopy (NIRS) monitoring technologies are emphasised.

## Interactions animaux–plantes: consommation et utilisation des éléments nutritifs chez les ruminants

*J.W. Stuth, R.K. Lyons et U.P. Kreuter*

Ranching Systems Group, Department of Rangeland Ecology and Management  
Texas A&M University, College Station, Texas (E.-U.)

## Résumé

*L'ingestion d'éléments nutritifs constitue l'interface entre les animaux et les plantes à l'intérieur du complexe sol–eau–atmosphère–plante–animal–êtres humains. Cet interface constitue un domaine essentiel dans les décisions humaines en matière de gestion des ressources. Ces décisions influencent les conditions de vie des animaux, la productivité de l'écosystème en rapport aux activités humaines, la biodiversité végétale et animale, le recyclage des éléments nutritifs, la qualité/quantité d'eau et la stabilité du sol. La nature hiérarchisée du processus de sélection des aliments chez les herbivores et les besoins physiologiques pertinents, compte tenu de la configuration spatiale des paysages naturels et autres, fixe les limites non seulement des lieux où les animaux prélèvent les éléments nutritifs, mais également de l'efficacité des processus d'ingestion, d'utilisation desdits éléments et de leur recyclage dans l'écosystème. L'ensemble des espèces animales et leurs besoins nutritionnels déterminent le*

*mode de prélèvement des éléments nutritifs dans la nature au vu de la diversité végétale disponible. L'équilibre de l'alimentation des ruminants au pâturage dépend d'un ensemble complexe de facteurs déterminant l'ingestion de matière sèche, la composition/qualité du régime alimentaire et les besoins en éléments nutritifs pour les processus physiologiques vitaux de l'animal. Pour comprendre les facteurs déterminant l'ingestion de matière sèche, il faut connaître les caractéristiques du sexe et/ou de la classe d'âge et la race de l'animal, son état physiologique, l'effet du sol sur les dépenses énergétiques de pâture, les conditions de milieu (température, vents, boue/neige), la quantité/qualité du fourrage disponible, les caractéristiques de la complémentation alimentaire, minérale et hormonale ainsi que l'apport d'ionophores. La quantité d'éléments nutritifs prélevée détermine, par rapport aux besoins de l'animal, la capacité de celui-ci de transformer les éléments essentiels (protéines brutes, énergie) en vue de la production du lait, de la reproduction et du développement des jeunes. Cet article présente une vision holistique du prélèvement des éléments nutritifs dans le contexte du système sol-eau-atmosphère-plante-animal-êtres humains, en mettant l'accent sur les innovations dans le domaine des logiciels d'aide aux décisions nutritionnelles et celui des techniques d'étude des fèces par spectroscopie dans le proche infrarouge.*

## Introduction

When addressing the animal/plant interface, researchers have tended to focus on biological processes and ignore the major agent controlling the interface, *Homo sapiens*. Furthermore, study of the animal/plant interface must consider the effects of other principal interfaces between soil, water, atmosphere and people. Figure 1 represents the hierarchy of the animal-plant interface within the context of the Soil, Water, Atmosphere, Plant, Animal and Human continuum (SWAPAH) (Stuth, 1991; Carlson, 1993; Welch, 1993). The primary factors driving SWAPAH are climatic. Climate drives plant growth, affects animal intake and nutrient requirements, and creates runoff/erosion and ground water recharge. In turn, actions of animals and the subsequent reaction of plants to herbivory alter how climate has an impact on the SWAPAH continuum. However, it is human activities that have the greatest effect on many of these interactions. For instance, rangeland managers' goals, needs and perception determine decisions concerning numbers and kinds of animals to stock, where and when to graze them, when to remove animals, and husbandry practices used. Moreover, animals are indirectly affected by human manipulation of plant resources (brush management, seeding and land conversion) and spatial arrangement of facilities (wells, windmills, troughs, corrals, mineral stations and feeding sites).

Blending Maslow's (1954) concepts of the human hierarchy of psychological needs with Herzberg's (1966) treatment of human needs in the workplace, Stuth and Stafford-Smith (1993) developed a hierarchy of the grazing-land manager's needs. Grazing-land management decisions are thus made subject to individual experiences, level of internalised knowledge, cultural values, social constraints, current needs and stage in life relative to intergenerational transfer of wealth (Stuth et al, 1993). These internalised variables comprise the framework for perceptual filters through which humans view the world and formulate solutions to problems (Stuth and Stafford-Smith, 1993).

This paper focuses on those biological attributes of ecosystems that affect nutrient acquisition by ruminants subject to management influences by mankind. The reader should remember that these processes generally occur in managed environments. Individual people have their own "view of the world" which can promote or constrain the animal's ability to acquire nutrients. This world view must be clarified through a greater understanding of the processes internalised within the psyche of the grazing land decision maker.

## Grazing environments

Six broad categories of managed grazing environments can be identified and range from extensive environments, where animal diet selection is maximum, to confinement where human control of diet selection is absolute.

### **Extensive-static landscape environments**

In extensively grazed environments where animals remain in one pasture people affect nutrient acquisition by selecting the kinds, classes and breeds of animals, and by determining the placement of water sources, mineral stations, fences, roads, access ways and handling facilities. The husbandry practices used determine the extent to which nutrients supplied by forage resources meet animal needs and thus affect both reproductive performance and disease resistance.

### **Extensive-multiple landscape environments**

Nutrient acquisition by livestock can be controlled by regulating the frequency and intensity of grazing among multiple landscapes. This level of control is designated by "grazing management systems" which are designed to improve plant resources, improve foraging efficiency on diverse landscapes, and (or) improve animal productivity.

### **Extensive herding across multiple landscapes**

Transhumance herding practices involve human control of both livestock access to plant communities within a given landscape and herd movement across landscapes to remote areas with seasonally limited forage supplies. Man exerts control over the nutrient acquisition process in these situations through constant observation of the grazing process coupled with a knowledge of remote forage conditions far beyond the senses of the animal. Pastoral systems in fragile, highly variable ecosystems minimise risk to both livestock and human populations by maintaining access to large areas of diverse landscapes and moving the stock to the best forage conditions throughout the annual forage production cycle.

### **Intensive herding within a static set of landscape conditions**

Where human populations gather into permanent villages and physical land-use boundaries are ill-defined, herding is required to prevent crop damage by livestock and to physically control forage utilisation in the surrounding landscape. Decisions concerning intra-landscape plant community access by animals become more critical than in transhumance systems to prevent overuse of the geographically limited forage supply.

### **Tethered grazing, rotating among patches**

When human populations increase to densities where most available land area is dedicated to cropping, animals are physically confined (usually by being tethered) to marginal land around fields, along roads, and between dwellings, or on crop residues. Tethered grazing is also extensively used to exploit unallocated forage resources where people are landless or where fields require manuring to sustain soil fertility.

### **Confined feeding/zero-based grazing/cut-and-carry**

Absolute human control of livestock nutrient acquisition occurs when animals are confined to a limited space where feed is brought to them. In this case, diet selection by animals is replaced by human perceptions of animal needs. Amount of forage offered and forage nutrient concentration is influenced by humans. Two extreme examples are high-input livestock feeding in feedlots and under subsistence conditions where landuse for crop production and human shelter is maximised.

## **Diet-selection process**

When an animal grazes an individual plant, a hierarchy of instinctive responses and behavioural actions has taken place that lead to the point of prehension and consumption (Senft et al, 1985; McNaughton, 1987; Senft et al, 1987; Figure 1). Each landscape unit is composed of a complex arrangement of plant

Figure 1. Hierarchical relationship of the soil–water–animal–plant–atmosphere–human continuum.

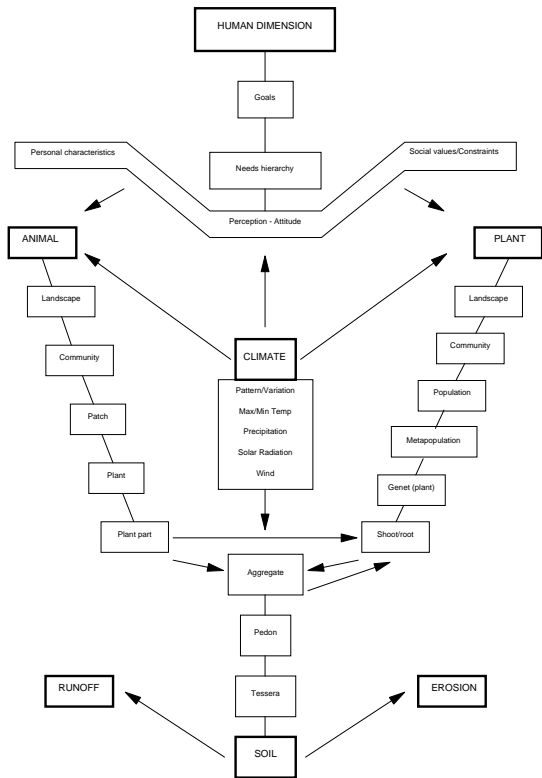

communities or habitats which are delineated by plant species present, and their spatial arrangement and structural configuration (Stuth, 1991). Plant communities can be further divided into patches of relatively more homogeneous plant groupings. Once an animal has oriented itself within a patch it selects feeding stations along its grazing path within which it selects its diet among individual plants and plant parts. Diet selection thus has two major components that must be clearly distinguished, spatial choice and species choice.

### **Spatial choice**

At the landscape level, diet selection is characterised by those physiognomic and thermic factors that influence animal movement patterns. They include boundaries (home range, migration routes and fences), distribution of plant communities (soil, elevation, aspect, community structure and species composition), degree of accessibility (slope, woody plant density, terrain roughness, trails, openings, water courses and gullies) and distribution of water, thermal shelter, supplemental feeding/mineral and loafing and bedding foci.

These features affect the extent to which ungulates can meet their physiological needs. Stafford-Smith (1988) proposed that ungulates have a hierarchy of primary physiological needs with thresholds, beyond which activities and subsequent movements of animals within landscapes are affected. These needs were ranked as water, thermal regulation, food acquisition, night-time and rumination/rest. Conflicting needs that can supersede these primary needs, but which are either short lived or random in occurrence, include socialisation, reproduction, predator avoidance and recuperation from disease (NRC, 1987).

### **Hierarchy of ruminant needs**

#### **Water**

Water accounts for 50–80% of a ruminant's live weight depending on age and degree of fatness. An animal can lose almost all its fat and almost half its protein yet survive, but the loss of 10% of its body water can be fatal (Standing Committee on Agriculture, 1990). Water consumption is required for waste excretion, regulation of blood osmotic pressure, production of secretions (milk, saliva, digestive fluids), foetal development, growth, and thermoregulation through evaporation.

Animals obtain water in three ways: through drinking, ingestion of forage moisture and absorption of metabolic water formed during oxidation of ingested nutrients and body tissues. Consumption of free standing water is influenced by the water content of available forage, level of forage intake, and genetic predisposition for water turnover. There is generally a strong positive correlation between moisture content and forage digestibility and intake. Forages vary from 10% (standing dead) to 90% (lush young growth) moisture content. Although metabolic water is important to the animal's water economy, its contribution from the catabolism of fat, carbohydrates, or protein is relatively small in most ruminants. (Standing Committee on Agriculture, 1990).

Under most grazing-land conditions, it is apparent that availability of free-standing water is critical for meeting ruminants' needs (Shirley, 1985). Because daily water requirements and watering frequency set the distance from water that an animal can search for nutrients in a landscape (Louw, 1984), the spatial placement of watering facilities in many cases determines the "effective foraging area". For instance, cattle will drink once or twice daily while certain desert goat species can water every 2–5 days and camels may drink at intervals of up to 21 days. If animals require water daily, the biologically optimum grazing radius is considered to be 0.8 km and the practical upper limit about 1.6 km (Valentine, 1947).

Total water intake of sheep, goats and cattle has been shown to be positively correlated to dry matter intake. Most of the watering recommendations of ARC (1980) and NRC (1987) are for livestock

adapted to temperate conditions up to 25°C, but most extensive grazing lands experience higher temperatures and are frequently stocked with breeds of tropical origin. The Standing Committee on Agriculture (1990) modified standards to account for these differences. For instance, at temperatures of 25°C and 35°C non-pregnant *Bos taurus* cattle should consume 5.5 and 10 litres of water per kg of ingested forage, respectively. *Bos indicus* cattle, by contrast, require 4.5 and 8 litres per kg of intake, respectively, under the same conditions. When in the last months of pregnancy, both breeds require 30% more water per day, and during lactation water allowances should be increased by one litre of water per kg of milk production.

### **Thermal regulation**

Ruminant distribution within landscapes is highly regulated by behaviour to maintain homiothermy (Finch, 1984). For instance, *Bos taurus* cattle seek shade when their respiration rates exceed 60 breaths/min regardless of hunger level (Loza et al, 1992). Shade location relative to water therefore influences landscape utilisation by grazing ruminants, and when shade and water are co-located, the domain of attraction is strong (Loza et al, 1992). Furthermore, patterns of use of north and south slopes and associated cover of woody plants reflect habitat use for both thermal regulation and food acquisition (Stuth, 1991).

### **Food acquisition**

Foraging behaviour can be divided into search time, time spent travelling between feeding stations, biting rates within feeding stations, and duration of biting while at a feeding station (Stuth and Searcy, 1987). Ruminants adjust time allocated to grazing (min/d) and intake rate (g/min) in an attempt to maintain daily ingestion of dry matter (kg/d). Generally, ruminants increase grazing time and biting rate as forage supply and associated bite size declines (Alden and Whittaker, 1970; Chacon and Stobbs, 1976; Arnold and Dudzinski, 1978; Arnold, 1981; Forbes et al, 1985; Standing Committee on Agriculture, 1990). Animals tend to forage on plant communities that allow the most energetically efficient manner of harvesting nutrients subject to constraints of water replenishment and thermal regulation. Senft et al (1987) noted that forage quantity and quality were closely related to the ratio of time spent grazing a community and the area of the community within the landscape. Abundance of seasonally preferred plant species has also been shown to influence patterns of plant community use (Senft et al, 1985). The greater the density of high-quality forage species, the slower the grazing velocity and thus the greater residence time and intake level attained relative to other communities available to the animal (Senft et al, 1987). If high-density, high-quality communities lie between or in close proximity to important water and thermal foci, site preference is magnified (Stuth, 1991).

### **Rumination/rest**

Much of the non-grazing period or resting time characterised by loafing and bedding by ruminants is spent ruminating. Only about 20–30 min/d are actually spent sleeping by cattle (Walker and Heitschmidt, 1989). The less a ruminant masticates the forage initially ingested the greater the time spent chewing regurgitated forage. Generally, chewing during rumination occurs at a slower rate than during grazing (Van Soest, 1982). Increasing intake generally reduces the time spent ruminating, with the upper limit being set by the limits to course particle fill in the rumen.

### **Conflicting needs**

Although Stafford-Smith (1988) placed "night-time" in the hierarchy of needs, we perceive it to conflict with food acquisition needs. In sheep, cessation of grazing at night is primarily a predator avoidance response. By contrast, cattle appear to limit night-time grazing due to restricted visual cues since they generally forage only near grazing termination points at dusk (Walker and Heitschmidt, 1989). Night-time grazing seldom exceeds one hour except when animals are subject to extended day



time temperatures exceeding their upper critical temperature. Night-time grazing may, however, increase to approximately 2.5 hours during hot summer months (Stuth, 1991). Socialisation related to dominance establishment, libido, parturition, care of offspring and migration results in reduced grazing time and increased time allocated to challenging sexual dominance in a group and to species perpetuation. Animals experiencing infections are incapacitated for periods of time to fight diseases. With some diseases the animal survives but foraging behaviour is suppressed and nutrient acquisition reduced.

### **Plant choice**

Herbivores exhibit an evolutionary predisposition to feed on plant species from one or more of their primary food groups — grasses, forbs and browse. The grazing value of plants within each group depends on the animal species in question. Species preference by an animal involves proportionally greater choice of one plant species relative to others on offer (Stuth, 1991). The preference status of a particular plant species is largely dependent upon its inherent abundance, its morphological, phenological, and chemical characteristics, the array of species on offer, and the species of animal in question. Preference constantly changes as abiotic factors alter the nature of the plant community.

Plants have been classified into five general selectivity categories: preferred, desirable, undesirable, toxic and non-consumable (Stuth, 1991). Preferred species form a greater proportion of the diet than they occur in the plant community, while desirable species are normally selected in proportion to their availability. Species that are consumed less frequently than they are encountered in the field are designated as undesirable, while species that result in death of the animal when consumed are classified as toxic. Non-consumable species are ingested only under extreme conditions. Stuth (1991) indicated that most species will remain in these broad categories over a wide range of standing crops as measured by a selectivity index.

### **Kinds of ruminants**

The kinds of plants (grass, forbs and browse) and plant parts (leaf, stem and fruit) selected by ruminants are highly related to anatomical features of the ruminant, especially prehensile morphology and rumeno-reticular architecture relative to body weight and volume (Demment and Van Soest, 1985). As ruminant body size increases, the relative rumen volume and weight of rumen contents increase while rate of passage of ingested forage declines. This results in increased forage demand but a proportional reduction in faecal output expressed as a percentage of body weight with increasing body size and relative rumen capacity.

Ruminants and non-ruminant herbivores have been categorised into as many as six groups based on forage types eaten (Langer, 1984). A modified version of the ruminant classification presented by Hofmann and Stewart (1972) which includes bulk/roughage grazers, intermediate feeders and concentrate selectors is used here.

#### **Bulk/roughage grazers**

Cattle, bison, cape buffalo and yak are examples of bulk/roughage grazers. Huston and Pinchak (1991) indicated that bulk/roughage grazers exhibit relatively low selectivity and ingest herbage by wrapping their tongues around individual clumps of plant tissue and breaking the clump loose with a short jerk of the head. Once in the mouth, material is wetted with salivary secretions, chewed slightly and swallowed. The ingested "bolus" is mixed in the rumen and later regurgitated, chewed extensively, then reswallowed (rumination).

#### **Intermediate feeders**

Goats and many of the medium to large Indian antelopes fall into this category. Intermediate feeders characteristically exhibit high dietary plasticity. They can be separated into two subcategories — browse preferring and grass preferring. For example, goats are considered browse preferring

intermediate feeders while sheep are placed in the grass preferring subcategory. Members of the browse-preferring subgroup generally have smaller rumen content-weight to body-weight ratios, greater faecal output as a percentage of fat-corrected body weight and higher net basal metabolism than those of the grass-preferring subgroup. However, intermediate feeders have the ability to switch food groups when the preferred food group is in limited supply. This allows them greater opportunity to survive conditions which restrict forage on offer.

### Concentrate selectors

White-tailed deer and many of the small African antelopes represent this category of ruminants. Concentrate selectors characteristically have highly manipulative and often split lips, soft muzzles and agile tongues (Huston and Pinchak, 1991) as well as the ability to stand on their hind legs to acquire food from heights greater than their normal standing height. This category of ruminants can thus select plants and plant parts high in cell contents and low in cell wall components. Bite sizes are smaller and more discrete, allowing for greater selectivity of small, younger plant parts. This group of ruminants is generally smaller in body size which means the animals have higher metabolic rates (greater nutrient requirements), lower absolute dry matter requirements, higher intake as a percentage of body weight, and higher faecal output as a percentage of body weight. Therefore, concentrate selectors must select high quality diets but possess prehensile organs and graze a sufficient length of time to select among forage species in their landscape to meet their needs. High rates of passage do not penalize this group of ruminants since plant parts selected are high in readily digestible cell contents and the cell wall can be subjected to a higher proportion of hind-gut fermentation.

### Factors affecting intake

To further understand nutrient acquisition beyond spatial choice and plant selectivity, one must focus on those factors that affect forage intake. Voluntary intake can be calculated using two primary components, faecal output and the indigestible fraction of the diet, as follows:

$$\text{Voluntary intake (kg DM/d)} = \frac{\text{Faecal output (kg DM/d)}}{\text{Diet indigestible fraction (kg IDM/kg DM)}}$$

where:

$$\text{Diet IDM} = 1 - (\text{TDN} \% * 0.01)$$

TDN = total digestible nutrients

This voluntary intake equation is described by Ellis et al (1988) as the "physical-constraints" model of intake which assumes that faecal output is a constant percentage of the fat-corrected body weight of an animal in stable metabolic and physiological state (Ellis, 1978; Forbes, 1980; Minson, 1982; Launchbaugh, 1990; Stuth and Lyons, 1994). The positive relationship between daily voluntary intake and digestibility and the non-significant relationships between digestibility and faecal output (Figure 2) both suggest that increased intake with increased digestibility is attained by increasing the dry-matter load within the gastro-intestinal tract (Ellis et al, 1988).

The indigestible fraction is determined by the reciprocal of the total digestible nutrients (TDN) in the diet selected by the animal. As digestibility increases, intake increases as long as indigestible dry-matter intake limits are not exceeded. Faecal output changes as the size of the gastro-intestinal tract changes due to anatomical differences between species, breeds and individuals as well as physiological stages of the animal. We submit that constant faecal output level within species and within physiological state of an animal can be used as a driving variable to predict potential forage intake. Furthermore, these faecal-output factors can be used as driving variables in simulation and decision-support models.

**Figure 2.** Effect of digestibility of forage consumed on daily intake and faecal output of cattle grazing bermuda grass and rye grass (after Ellis et al, 1988).

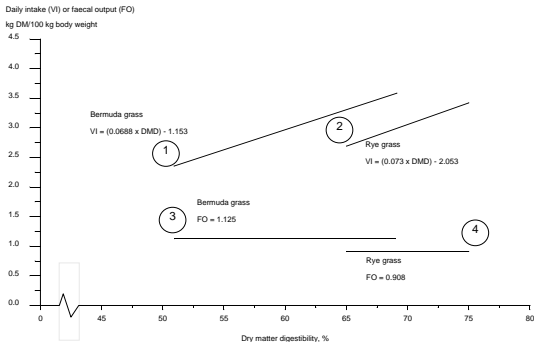

Both NRC (1987) and ARC (1980) define intake based on an animal's energy requirements and assumed feed energy content. As the Standing Committee on Agriculture (1990) stated "most of the schemes developed in other feeding standard systems are applicable only to housed or other hand-fed animals." In other words, these intake formulae estimate what animals need to consume to meet energy requirements not what they will consume ad libitum. Therefore, in many instances, voluntary intake of ruminants in free-ranging conditions exceeds that predicted by NRC (1987) or ARC (1980) intake equations.

Under extensive grazing, intake is simultaneously influenced by amount of forage on offer and concentration of critical nutrients (energy, crude protein, minerals). Faecal output is not only sensitive to animal metabolic and physiological state but to diet crude protein concentration, forage availability, environmental conditions, feed supplements/additives, and hormones (NRC, 1987; Fox et al, 1988). Concentration of critical plant nutrients is affected by photosynthetic pathway (C3 vs C4), growth habit (grass, forb, browse), stage of growth, rate of growth at the time of ingestion, and level of leaching from senescent plant tissue.

The following aspects affecting ruminant intake must be considered when assessing the level of demand that animals will place on forage resources and the subsequent nutrient balance of the animal.

### Body condition

A primary assumption of nutritional requirement systems should be that animal weight is standardised to a given level of fatness. Standard reference weights for cattle should be based on an observable average fatness index or body condition score 5 on a 1–9 system. This corresponds to a body-fat content of 22% in cattle. Too many intake studies have been reported on a per cent of body weight basis without any correction for fatness, leading to a wide array of "intake relationships" that cannot be compared or contrasted. The use of a standard reference weight with average fatness allows intake determinations

across a wide array of body fatness, and ensures that intake estimates reflect gastro-intestinal tract size rather than animal weight (Figure 3). Body condition and age relationships in growing animals also present the issue of higher faecal output factors for animals exhibiting "compensatory gain" (Koong et al, 1982; Abdalla et al, 1988). For example, with nutritionally stressed, growing animals, failure to correct body weight for fatness would result in underestimates of intake because gastro-intestinal tract capacity in these animals is greater than indicated by body weight alone. This particular example is also age dependent because weight per condition score increases until maturity.

**Figure 3.** Adjustment factors for standardising body weight to an average body condition score of 5 (1–9 scoring system).

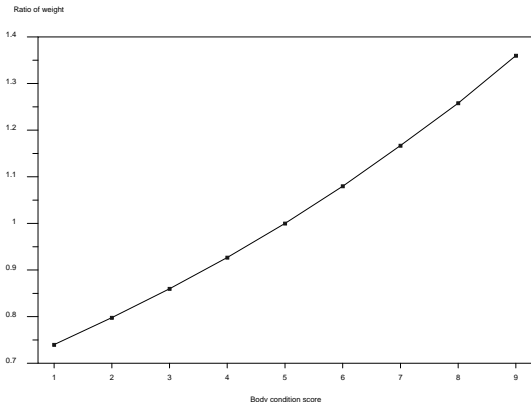

## Species

As stated earlier, smaller ruminants have proportionally smaller fore stomachs and faster passage rates of digesta, which generally results in increased faecal output as a percentage of body weight (Figure 4). Typical baseline faecal output constants (kg dry-matter intake per kg of fat-corrected body weight) for dry, open female cattle, sheep and goats are 0.01, 0.011 and 0.012, respectively (Ellis et al, 1988; Ranching Systems Group, 1993).

## Breeds

Dairy cattle breeds have higher gastro-intestinal capacity relative to body volume than other ruminants, probably due to high milk production levels. This greater capacity results in proportionally higher intake and faecal output for equivalent fat-corrected body weights compared to *Bos taurus* breeds. Fox et al (1988) indicated that intake would be 8% higher for Holsteins and 4% higher for Holstein crosses.

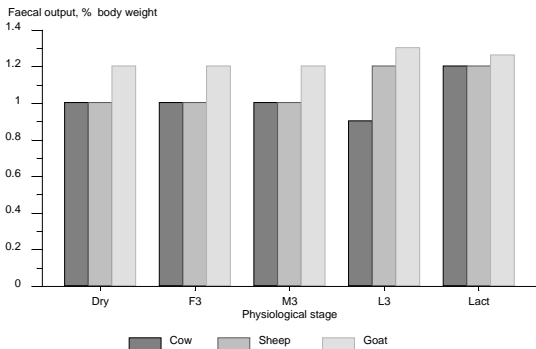
**Figure 4.** Species differences in faecal output resulting from differences in gastro-intestinal capacity.

Special attention needs to be placed on many of the dual purpose breeds to determine the deviation of their faecal output relationships relative to traditional beef breeds. This is because cattle breeds of tropical origin (*Bos indicus*) have been reported to adjust net basal metabolism and probably faecal-output patterns seasonally in a manner different from those of *Bos taurus*.

### Physiological stage

The gastro-intestinal capacity and faecal output constants of animals that are not carrying a foetus, or that are in the first two trimesters of pregnancy, are similar. However, at least with cattle, there may be as much as a 10% reduction in faecal output during the last trimester (Figure 5). Although, this reduction has usually been attributed to reduced rumen capacity in relation to the growing foetus, some evidence indicates that increasing oestrogen levels may be at least partly responsible (Forbes, 1984).

Given the profound impact of lactation on animal nutrient demand, special emphasis should be placed on greater understanding of faecal output dynamics associated with lactation, especially in gain/loss situations (Standing Committee on Agriculture, 1990). Once lactation begins, the digestive tract expands (hypertrophy) to accommodate increased gut fill. This results in an increased capacity for nutrient absorption and increased nutrient flow into the metabolisable nutrient pool of the dam (Collier, 1985). Increased gastro-intestinal capacity results in greater faecal output per unit of fat-corrected body weight (BW) (Figure 5). Increase in faecal output (% BW) lags behind increase in milk production and attains a peak value approximately 16, 8 and 6 weeks after parturition in cattle, goats and sheep, respectively (Standing Committee on Agriculture, 1990). The degree of nutrient stress during early lactation can reduce peak milk yields and the subsequent linear decline phase of the lactation curve (Collier, 1985). For example, in cattle a decrease in body condition score from 6 to 3 (1–9 system) during the first 20 weeks of lactation can result in a 7% reduction in milk production per unit decline in condition score unit, i.e. 21% reduction from 6 to 3 condition score (Grainger et al, 1982).

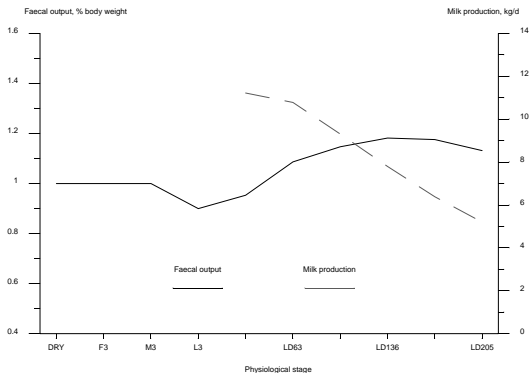
**Figure 5.** Effect of physiological stage of cows on their faecal output.

## Environmental factors

The thermal neutral zone (TNZ) of ruminants is the range in temperatures within which they are at relative equilibrium with the environment (NRC, 1987). Thermal conditions above and below the TNZ have a major effect on forage intake (Huston and Pinchak, 1991). Generally, beef cattle have a TNZ for voluntary intake of 10–25°C (NRC, 1981; Finch, 1984) (Figure 6). Below the TNZ (cold stress), intake increases in response to heat loss down to –25°C provided fill limitations are not encountered (NRC, 1987). However, animals exposed to sustained temperatures below –25°C may restrict grazing activity and intake to minimise energy expenditures for grazing (Adams et al, 1986; 1987; Young, 1986).

With animals subjected to muddy conditions or rainy/wet snow conditions, intake is depressed as temperatures decrease (Fox et al, 1988). Moreover, extended periods of rain have been observed to depress intake, regardless of animal thermal status. Intake decreases in response to increasing temperature above the TNZ (heat stress). Furthermore, if high temperatures and high humidity persist during the night, dissipation of daytime heat load is reduced and there is less opportunity for the body to cool before the next day's heat load, resulting in greater intake depression (Collier and Beede, 1985; Fox et al, 1988). Obviously, inherent genetic characteristics of ruminant species and breeds, affect the upper and lower critical temperatures at which the above responses occur. Hide thickness, hair length, body surface area, and water turnover through evaporation (respiration and sweating) are key characteristics affecting voluntary intake response to heat and cold stress (Fox et al, 1988; Loza et al, 1992). Heat stress not only reduces intake but also decreases milk yield (Stephenson et al, 1980; NRC, 1981). Milk yield also decreases when temperatures fall below –5°C even though intake rises (NRC, 1981).

In many arid climates, animals walk long distances to water sources resulting in reduced forage intake, particularly as ruminants require daily access to water. Gordon (1965) observed no changes in intake during the first two days of deprivation in Merino sheep but a 46% decrease in intake was

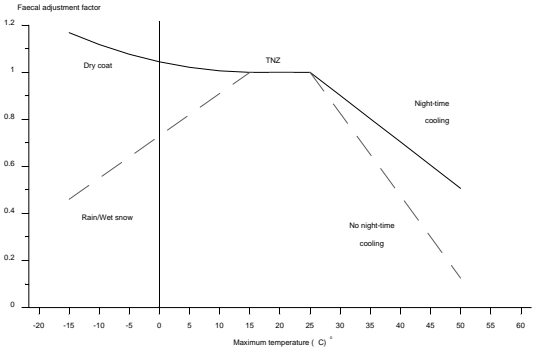
**Figure 6.** Effect of maximum air temperature on relative faecal output of cattle.

observed by the fourth day of deprivation. Weeth et al (1967) similarly noted a 50% reduction of each preceding day's intake during four days of water deprivation in Hereford heifers.

### Forage availability

An underlying assumption of voluntary intake computations is that quantity of forage on offer does not limit the ability of animals to meet their dry matter fill constraints. However, under most forage conditions, animals are subject to standing crops (kg/ha) that restrict forage intake. An extensive review by Huston and Pinchak (1991) indicated a wide range in threshold levels for restricted voluntary intake. They concluded that the intake of cattle and sheep became restricted when standing crop on temperate grasslands was <1000 kg/ha, but they noted that on improved temperate and tropical pastures, standing crops between 1000 and 4000 kg/ha limit intake. NRC (1987) and the Standing Committee on Agriculture (1990) indicated that intake is restricted below 3000 kg/ha and declines linearly by 15% between 3000 and 1000 kg/ha (Figure 7). As standing crop declines below 1000 kg/ha, the impact on intake becomes exponential.

Most standing crop/intake studies confound the effects of forage availability with the effects of not correcting body weight for fatness, one possible source of the large variation reported for intake threshold values across studies. Although the cause of this disparity is not clear, Hendrickson and Minson (1980) suggested the source of this variation may be due to the fact that total herbaceous standing crop is an inappropriate expression of forage availability. With heterogeneous pastures, they suggested measurement of leaf and stem yields and composition as appropriate variables for estimating intake.

Launchbaugh et al (1990) noted that in shrub lands, faecal output of young cows subjected to "graze out" situations did not decline as a percentage of body weight until green herbage standing crop was below 400 kg/ha. In shrub lands, total herbaceous standing crop below 900 kg/ha can moreover, result

**Figure 7.** Observed faecal output adjustment factors for cattle compared to NRC (1987) intake adjustment factors (0–3,000 kg/ha standing crop of forage).

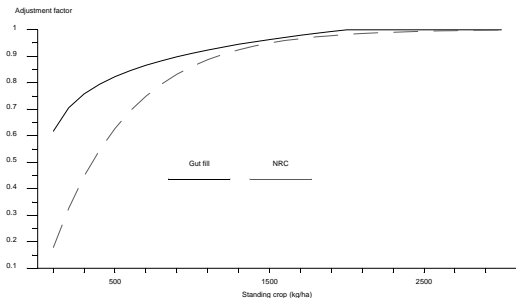

in a dietary shift to browse by cattle attempting to meet their indigestible dry matter fill constraint (Hanson, 1987; Launchbaugh et al, 1990; Stuth and Lyons, 1994). Recently, we have found that the relative decline in faecal output was similar to those reported in NRC (1987) when herbage standing crop was >1000 kg/ha (Figure 7). However, when herbaceous standing crops were <1000 kg/ha, decreases in faecal output were found to be less than those reported by NRC (Hanson, 1987; Stuth and Lyons, 1994). This deviation resulted from differential effects of concomitant drops in forage availability and digestibility on intake.

### Forage quality

Intake by the animal is determined not only by gastro-intestinal tract capacity but also by concentration of indigestible dry matter of the diet (Ellis et al, 1988). Forage quality, as it pertains to intake, generally refers to digestibility, crude protein, secondary compounds and mineral content. The level of digestion is generally related to the relative proportion of cell contents and composition of cell wall components (structural carbohydrates). These components are influenced by: (1) their content of specialised tissues of inherently different digestibilities, (2) the intrinsic composition of structural carbohydrates, (3) changes with age in composition of structural carbohydrates and (4) association of potentially digestible entities with indigestible entities (Ellis et al, 1988).

Digestibility of forages and its impact on intake by the animal must be viewed in terms of the rate and extent of digestion. The extent of digestion within a given segment of the gastro-intestinal tract is influenced by the composition and indigestibility of each chemical entity within the forage residue and the residence time of the residue within the gastro-intestinal segment.

Essential to this process is the health of the microbial population in each segment. Micro-organisms hydrolyse and ferment forage constituents to obtain the nutrients they need for maintenance and growth. Where the rate of nutrient acquisition limits microbial growth, e.g. limited nitrogen and plant crude protein, the rate of digestion slows and, depending on residence time in the gastro-intestinal segment, may decline. Such reduced microbial activity thus results in reduced forage intake. Minson (1982) suggested that the critical forage crude protein concentration below which intake declines is 7%.



## Feed and feed additives

When dietary crude protein is below 7%, a protein supplement can stimulate dry matter intake (Leng, 1984). At levels above 7% CP, protein supplements can be used to meet protein requirements for a desired level of animal performance. When animals exhibit both a crude protein and net energy imbalance, then energy concentration (NEm and NEg) in the feed must be considered in conjunction with its crude protein content. Combinations of a protein supplement and high energy feed (soluble sugar in molasses or highly fermentable carbohydrate of grains) or high-fat protein supplements, such as whole cottonseed, are often used in these situations. Associative effects can manifest themselves when feeding highly fermentable carbohydrates in two ways: (1) increases in protozoa in the rumen which can reduce microbial protein available to the animal, or (2) reduced digestibility of ingested forage due to lower ruminal pH which inhibits bacterial cellulolytic activity. A general guideline is that grain intake should remain below 0.4% of fat-corrected body weight to minimise negative associative effects.

Ionophores such as monensin and lasalocid are feed additives used to improve efficiency of feed/forage conversion to liveweight gain in growing animals. Allocation of these microbial population modifiers, can affect dry matter intake of forage, net energy for maintenance value of the forage ingested, digestibility of forage crude protein, and possibly net basal metabolism of the animal at the tissue level (Byers, 1980; NRC, 1984; Garrett, 1987). Ellis et al (1988) noted that forage digestible organic matter (DOM) was increased by 4% with a quadratic effect on faecal output (% body weight), a negative impact on faecal output below 45% or above 65% DOM, and a peak increase in faecal output at 55% DOM. Greater turnover and escape of ingested forage can also lead to higher propionate levels and more efficient yield of microbial protein synthesis that escapes rumen degradation thereby increasing crude protein availability (NRC, 1984; Garrett, 1987; Ellis et al, 1988).

## Nutritional management decision techniques

A major limitation to making nutritional management decisions is the inability of managers and advisors to determine diet quality under field conditions. Recent advances in near infrared reflectance spectroscopy (NIRS) have, however, made it possible to detect faecal by-products of digestion and relate these constituents to dietary crude protein (CP) and digestible organic matter (DOM) (Stuth et al, 1989; Lyons and Stuth, 1991; Stuth et al, 1991; Leite et al, 1992; Lyons and Stuth, 1992; Lyons et al, 1993; Pearce et al, 1993; Leite and Stuth, 1994). Spectral signatures are determined by the types and concentrations of chemical bonds in the faeces. The primary wave lengths of the predictive equations generated by NIRS software for CP and DOM appear to be associated with fibre and possibly microbial and/or alkane concentrations in the faeces, respectively (Lyons and Stuth, 1992).

Predictive equations can be developed for a wide array of forage conditions using faecal and oesophageal extrusa samples of animals sharing the same landscape. For instance, Lyons and Stuth (1992) developed cattle faecal NIRS equations that predict dietary CP and DOM at similar levels of accuracy as standard wet chemistry lab analyses. To date, these cattle equations appear to be highly reliable across a broad spectrum of forage types including subtropical shrublands, temperate and tropical pastureland, temperate and sub-tropical grasslands, desert shrublands, desert grasslands, mediterranean annual grasslands, hardwood forests, coniferous forest, marshland, and mountain meadows in the USA. In addition, recent success in NIRS profiling of faecal P and modelling of phosphorus balance in cattle is providing a new set of tools for livestock managers to assess if current supplements are meeting requirements for certain minerals (Stuth, unpublished). NIRS faecal profiling thus offers a mechanism to nutritionally profile free-ranging animals in large, diverse landscapes.

Information from NIRS analyses is intended for use in programs such as the Nutritional Balance Analyser (NUTBAL) which models the CP and net energy (NE) status of cattle, sheep, goats and horses (Ranching Systems Group, 1992; 1993). This computerised decision aid lets the user define the kind, class and breed of animals to be monitored, characterise their body condition and

environmental conditions, establish weight performance targets and enter NIRS results. From this information NUTBAL calculates animal intake from estimated faecal output (adjusted for ambient temperature, standing crop and estimated diet crude protein) and the indigestible fraction of the diet. The program then produces a nutritional balance report for protein and net energy. If energy or protein deficiencies exist for the specified level of animal performance, NUTBAL also estimates the least-cost feeding regime to remedy the deficiencies.

In the USA, mature cow weight gains and losses at various physiological stages have been predicted with a high degree of accuracy using NIRS/NUTBAL technology. For example, in College Station, Texas, most of the predicted weight changes fell within the 95% confidence limits of the observed values (Figure 8).

**Figure 8.** Comparison of weight changes predicted using NIRS/NUTBAL technology (*P*) and actual average weight changes of mature cows (*O*).

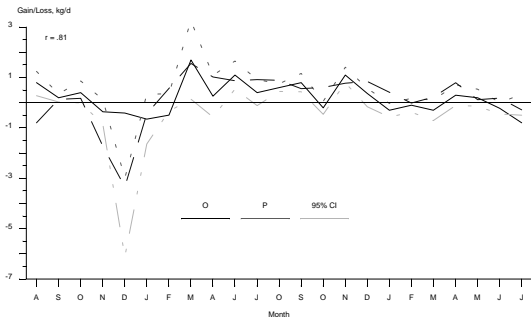

Application of the NIRS/NUTBAL decision support system, has identified a major research question concerning characterisation of standing crops (Ranching Systems Group, 1993). When herbaceous standing crops fall below 1000 kg/ha the ability of the decision maker to judge available forage becomes critical to assessing livestock nutritional status. A clearer understanding is needed regarding how various standing crop components are related to faecal output and thus voluntary forage intake. In other words, is effective standing crop green grass, green leaf, green leaf of key species of total grass biomass above mean collar height etc? How does available browse influence this relationship from the perspective of grass-preferring versus browse-preferring animals? Does 1000 kg/ha standing crop in a grazed sward have the same impact on faecal output as 1000 kg/ha in an ungrazed sward? Solutions to these questions and suitable field monitoring techniques need to be derived to better estimate nutrient acquisition by grazing animals.

## Conclusion

The process of nutrient acquisition by ruminants must be viewed in the context of the system in which the animal is foraging. Human control of the process varies according to the degree of control of animal diet selection. However, it must be recognised that animals make spatial decisions as well as individual

plant or feeding station decisions. How nutrients are harvested and redistributed is highly influenced by the spatial configuration of water sources, thermal regulation foci and relative value of forage available to the animal. Therefore, the capacity of the land to support animals is not only related to the productivity of forage resources and the nutrient requirements of the grazing animal but the spatial configuration of animal life support features within a landscape.

A major key to understanding nutrient acquisition is knowledge of factors affecting voluntary intake of ruminants. There have been many calls for improved methods to measure intake. However, given the complexity of factors affecting ruminant intake, modelling of intake may provide the only reasonable solution to incorporate this complexity. A major constraint to intake modelling has been our inability to accurately depict diet quality and represent available forage. Recent advances in NIRS technology are addressing the first concern of predicting diet crude protein and digestibility. However, greater effort needs to be expended to determine the relationship between forage availability and faecal output (% fat-corrected body weight). Underpinning this need is a clear definition of how to define and monitor available forage.

## References

- Abdalla H O, Fox D G and Thonney M I. 1988. Compensatory gain by Holstein calves after underfeeding protein. *Journal of Animal Science* 66:2687–2695.
- Adams D C, Nelsen T C, Reynolds W L and Knapp B W. 1986. Winter grazing activity and forage intake of range cows in the Northern Great Plains. *Journal of Animal Science* 62:1240–1246.
- Adams D C, Cochran R C and Currie P O. 1987. Forage maturity effects on rumen fermentation, fluid flow, and intake in grazing steers. *Journal of Range Management* 40:404–408.
- Alden W G and Whittaker I A McD. 1970. The determinants of herbage intake by grazing sheep: The interrelationships of factors influencing herbage intake and availability. *Australian Journal of Agricultural Research* 21:755–766.
- ARC (Agricultural Research Council). 1980. *The nutrient requirements of ruminant livestock*. Commonwealth Agricultural Bureaux, Slough, UK. 351 pp.
- Arnold G W. 1981. Grazing behavior. In: Morley F H W (ed), *Grazing animals*. Elsevier Publishers, New York, USA. pp. 79–104.
- Arnold G W and Dudzinski M L. 1978. *Ethology of free-ranging domestic animals*. Elsevier, New York, USA. 198 pp.
- Byers F M. 1980. Determining effects of monensin on energy value of corn silage diets for beef cattle by linear or semi-log methods. *Journal of Animal Science* 50:158–169.
- Carlson J R. 1993. Strategies for maintenance and restoration of soil, water, flora, and fauna resources in cold temperate rangelands. II. Technology transfer through a fully integrated natural resource decision-support system. In: *Proceedings of the XVII International Grassland Congress held in Palmerston North, New Zealand/Hamilton, New Zealand and Lincoln, New Zealand, 13-16 February 1993*. Vol. II. New Zealand Grassland Association, New Zealand. pp. 1779–1783.
- Chacon E A and Stobbs T H. 1976. Influence of progressive defoliation of a grass sward on the eating behavior of cattle. *Australian Journal of Agricultural Research* 27:709–727.
- Collier R J. 1985. Nutritional, metabolic, and environmental aspects of lactation. In: Larson B L (ed), *Lactation*. The Iowa State University Press, Ames, Iowa, USA. pp. 80–128.
- Collier R J and Beede D K. 1985. Thermal stress as a factor associated with nutrient requirements and interrelationships. In: McDowell L R (ed), *Nutrition of grazing ruminants in warm climates*. Academic Press, Inc. Orlando, Florida, USA. pp. 59–72.
- Demment M W and Van Soest P J. 1985. A nutritional explanation for body-size patterns of ruminant and non-ruminant herbivores. *The American Naturalist* 125:641–672.
- Ellis W C. 1978. Factors determining grazed forage intake and digestibility. *Journal of Dairy Science* 61:1828–1840.

- Ellis W C, Wylie M J and Matis J H. 1988. Dietary-digestive interactions determining the feeding value of forages and roughages. In: Orskov E R (ed), *Feed science*. Elsevier, Amsterdam, The Netherlands. pp. 177–229.
- Finch V A. 1984. Heat stress as a factor in herbivores under tropical conditions. In: Gilchrist F M C and Mackie R I (eds), *Herbivore nutrition in the subtropics and tropics*. Science Press, Craighall, South Africa. pp. 81–105.
- Forbes J M. 1980. A model of the short-term control of feeding in the ruminant: Effects of changing the animal or feed characteristics. *Appetite* 1:21–41.
- Forbes J M. 1984. The effect of sex hormones, pregnancy, and lactation on digestion, metabolism, and voluntary food intake. In: Milligan L P, Grovum W L and Dobson A (eds), *Control of digestion and metabolism in ruminants*. Prentice-Hall, New York, USA. pp. 420–435.
- Forbes T D A, Smith E M, Razor R B, Dougherty C J, Allen V G, Erlinger L L, Moore J E and Rouquette F M Jr. 1985. The plant–animal interface. In: Watson V H and Wells C M Jr (eds), *Simulation of forage and beef production in the southern region*. USDA Southern Cooperation Series Bulletin 308. pp. 95–116.
- Fox D G, Sniffen C J and O'Connor J D. 1988. Adjusting nutrient requirement of beef cattle for animal and environmental variations. *Journal of Animal Science* 66:1475–1495.
- Garrett W N. 1987. The influence of monensin on the efficiency of energy utilisation by cattle. Proceedings of the 9th International Symposium on Energy Metabolism. *EAAP Publication* 29:104–107.
- Gordon J A. 1965. The effect of water deprivation upon the rumination behavior of housed sheep. *Journal of Agricultural Science* 64:31–35.
- Grainger C, Wilhelms G D and McGowan A A. 1982. Effect of body condition at calving and level of feeding in early lactation on milk production of dairy cows. *Australian Journal of Experimental Agriculture and Animal Husbandry* 22:9–17.
- Hanson D M. 1987. *Influence of contrasting Prosopis/Acacia communities on diet selection and nutrient intake of steers*. MSc thesis, Texas A & M University, College Station, Texas, USA. 236 pp.
- Hendrickson R and Minson D J. 1980. The feed intake and grazing behavior of cattle grazing a crop of Lablab purpureus cv. Rongai. *Journal of Agricultural Science (Cambridge)* 95:547–554.
- Herzberg F. 1966. *Work and the nature of man*. World Publishing, Cleveland, Ohio, USA.
- Hofmann R R and Stewart R D M. 1972. Grazer or browser: A classification based on the stomach structure and feeding habits of East African mammals. *Mammalia* 36:226–240.
- Huston J E and Pinchak W E. 1991. Range animal nutrition. In: Heitschmidt R K and Stuth J W (eds), *Grazing management: An ecological perspective*. Timber Press, Portland, Oregon, USA. pp. 27–64.
- Koong L J, Ferrell C L and Neinaber J A. 1982. Effects of plane of nutrition on organ size and fasting heat production in swine and sheep. Proceedings of the 9th Symposium on Energy Metabolism. *EAAP Publication* 29:245–248.
- Langer P. 1984. Anatomical and nutritional adaptations in wild herbivores. In: Gilchrist F M C and Mackie R I (eds), *Herbivore nutrition in the subtropics and tropics*. Science Press, Craighall, South Africa. pp. 185–203.
- Launchbaugh K L, Stuth J W and Holloway J W. 1990. Influence of range site on diet selection and nutrient intake of cattle. *Journal of Range Management* 43:109–116.
- Leite E R and Stuth J W. 1994. Influence of duration of exposure to field conditions on viability of fecal samples for NIRS analysis. *Journal of Range Management* 47(5):312–314.
- Leite E R, Stuth J W, Lyons R K and Angerer J P. 1992. Using near infrared spectroscopy to monitor nutritional status of free-ranging goats. In: Goat, Wool & Mohair CPR, Texas Agricultural Experiment Station, College Station, Texas, USA. pp. 35–41.
- Leng R A. 1984. Supplementation of tropical and subtropical pastures for ruminant production In: Gilchrist F M C and Mackie R I (eds), *Herbivore nutrition in the subtropics and tropics*. The Science Press, Craighall, South Africa. pp. 129–144.
- Louw G N. 1984. Water deprivation in herbivores under arid conditions. In: Gilchrist F M C and Mackie R I (eds), *Herbivore nutrition in the subtropics and tropics*. The Science Press, Craighall, South Africa. pp. 106–126.
- Loza H J, Grant W E, Stuth J W and Forbes T D A. 1992. Physiologically based landscape use model for large herbivores. *Ecological Modelling* 61:227–252.

- Lyons R K and Stuth J W. 1991. Procedures for processing cattle fecal samples for NIRS analysis. *Animal Feed Science and Technology* 35:21–36.
- Lyons R K and Stuth J W. 1992. Fecal NIRS equations predict diet quality of free-ranging cattle. *Journal of Range Management* 45:614–618.
- Lyons R K, Stuth J W, Huston J E and Angerer J P. 1993. Predictions of the nutrient composition of the diets of supplemented versus unsupplemented grazing beef cows based on near-infrared reflectance spectroscopy of feces. *Journal of Animal Science* 71:530–538.
- Maslow A H. 1954. *Motivation and Personality*. Harper and Row, New York, USA.
- McNaughton S J. 1987. Adaptation of herbivores to seasonal changes in nutrient supply. In: Hacker J B and Ternouth J H (eds), *The nutrition of herbivores*. Academic Press, New York, USA. pp. 391–408.
- Minson D J. 1982. Nutritional differences between tropical and temperate pastures. In: Morley F W H (ed), *Grazing animals*. World Animal Science Subseries B. Vol. 1. Disciplinary approach. Elsevier, Amsterdam, The Netherlands. pp. 143–157.
- NRC (National Research Council). 1981. *Effect of environment on nutrient requirements of domestic animals*. National Academy Press, Washington, DC, USA. 152 pp.
- NRC (National Research Council). 1984. *Nutrient requirements of beef cattle*. National Academy Press, Washington, DC, USA. 90 pp.
- NRC (National Research Council). 1987. *Predicting feed intake of food-producing animals*. National Academy Press, Washington, DC, USA.
- Pearce R A, Lyons R K and Stuth J W. 1993. Influence of handling methods on fecal NIRS evaluations. *Journal of Range Management* 46:274–276.
- Ranching Systems Group. 1992. *NIRS fecal profiling*. Department of Rangeland Ecology and Management, Texas A&M University, College Station, Texas, USA. 2 pp.
- Ranching Systems Group. 1993. *Nutritional balance analyser user's guide*. Department of Rangeland Ecology and Management, Texas A & M University, College Station, Texas, USA. 148 pp.
- Senft R L, Rittenhouse L R and Woodmansee R G. 1985. Factors influencing patterns of cattle grazing behavior on shortgrass steppe. *Journal of Range Management* 38:82–87.
- Senft R L, Coughenour M B, Bailey D W, Rittenhouse L R, Sala O E and Swift D M. 1987. Large herbivore foraging and ecological hierarchies. *Bioscience* 37:789–799.
- Shirley R L. 1985. Water requirements for grazing ruminants and water as a source of minerals. In: McDowell L R (ed), *Nutrition of grazing ruminants in warm climates*. Academic Press, Inc., Orlando, Florida, USA. pp. 37–57.
- Stafford-Smith M.S. 1988. *Modeling: Three approaches to predicting how herbivores impact is distributed in rangelands*. New Mexico Agricultural Experiment Station, Las Cruces, USA.
- Standing Committee on Agriculture. 1990. *Feeding standards for Australian livestock: Ruminants*. CSIRO Publications, East Melbourne, Victoria, Australia. 266 pp.
- Stephenson, R G A, Hooley R D, Findley J K and Hopkins P S. 1980. Effects of heat stress on the lactation performance of ewes accustomed to tropical conditions and the total fluid intake of their lambs. *Australian Journal of Biological Sciences* 33:449–456.
- Stuth J W. 1991. Foraging behavior. In: Heitschmidt R K and Stuth J W (eds), *Grazing management: An ecological perspective*. Timber Press, Portland, Oregon, USA. pp. 65–85.
- Stuth J W and Lyons R . 1994. Impact of declining forage supply on fecal output of steers grazing south Texas shrublands. *Beef Cattle Research in Texas* (in review).
- Stuth J W and Searcy S. 1987. A new electronic approach to monitoring ingestive behavior of cattle. In: Hacker J B and Ternouth J H (eds), *The nutrition of herbivores*. Academic Press, New York, USA. pp. 81–82.
- Stuth J W and Stafford-Smith M. 1993. Decision support for grazing lands: An overview. In: Stuth J W and Lyons B G (eds), *Decision support systems for the management of grazing lands*. Parthenon Publishing Group, Casterton Hall, Carnforth, UK. pp. 1–36.

- Stuth J W, Kapes E D, and Lyons R K. 1989. Use of near infrared spectroscopy to assess nutritional status of cattle diets on rangeland. In: *Proceedings of the XVI International Grassland Congress, Nice, France, October 4-11, 1989*. Association Française pour la Production Fourragère, Versailles, France. pp. 889-890.
- Stuth J W, Lyons R K, Angerer J P and McKown C D. 1991. Role of NIRS-based nutritional monitoring systems for grazing and nutritional management of range livestock. In: *Proceedings of the Grazing Livestock Nutrition Conference*. Steamboat Springs, Colorado, USA. pp. 83-93.
- Stuth J W, Hamilton W T, Conner J R and Sheehy D P. 1993. Decision support systems in the transfer of grassland technology. In: *Proceedings of the XVII International Grassland Congress held in Palmerston North, New Zealand/Hamilton, New Zealand/Lincoln, New Zealand and Rockhampton, Australia, 8-21 February 1993*. Vol. I. New Zealand Grassland Association, New Zealand. pp. 749-757.
- Valentine K A. 1947. Distance from water as a factor in grazing capacity of rangeland. *Journal of Range Management* 45:749-754.
- Van Soest P J. 1982. *Nutritional ecology of the ruminant*. O & B Books, Inc., Corvallis, Oregon, USA. 373 pp.
- Walker J W and Heitschmidt R K. 1989. Some effects of rotational grazing treatment on cattle grazing behavior. *Journal of Range Management* 42:337-342.
- Weeth H J, Sawhney D S and Lesperance A L. 1967. Changes in body fluids, excreta and kidney function of cattle deprived of water. *Journal of Animal Science* 26:418-423.
- Welch B L. 1993. Strategies for maintenance and restoration of soil, water, flora, and fauna resources in cold temperate rangeland. I. Grass is not always king; manage for diversity. In: *Proceedings of the XVII International Grassland Congress held in Palmerston North, New Zealand/Hamilton, New Zealand and Lincoln, New Zealand, 13-16 February 1993*. Vol. II. New Zealand Grassland Association, New Zealand. pp. 1775-1777.
- Young B A. 1986. Food intake of cattle in cold climates. In: Owens F N (ed), *Proceedings of the Symposium on Feed Intake by Beef Cattle*. Oklahoma State University, Stillwater, Oklahoma, USA. pp. 328-340.

# **Relationship between nutrient content of the veld and productive performance of the grazing ruminant in southern Africa**

*C.T. Kadzere*

Department of Livestock and Pasture Science, University of Fort Hare  
P B X1314, Alice 5700, South Africa

## **Abstract**

Over 75% of the cattle, sheep and goat population in southern Africa are kept under smallholder farming conditions. The nutritional base for these livestock and for those under commercial ranching systems is the natural pasture. This nutrient base is subject to seasonal nutrient fluctuations which have direct and indirect influences on the productivity of the grazing ruminant. The paper reviews the relationship between the nutrient content of the veld and its implications on the productivity of ruminant livestock.

## **Relation entre la teneur en éléments nutritifs des fourrages des savanes du veld et la productivité des ruminants en Afrique australe**

*C.T. Kadzere*

Department of Livestock and Pasture Science, University of Fort Hare  
P.B. X1314, Alice 5700, République d'Afrique du sud

## **Résumé**

*Plus de 75% des bovins, ovins et caprins d'Afrique du Sud sont élevés dans les petites exploitations. La base de l'alimentation de ces animaux et de ceux élevés dans des ranchs commerciaux sont les pâturages naturels. Cette base dépend des fluctuations saisonnières des éléments nutritifs, lesquelles ont une influence directe et indirecte sur la productivité des ruminants au pâturage. Cet article examine la relation entre la teneur en éléments nutritifs des fourrages des savanes du veld et la productivité des ruminants.*

# Quantitative and qualitative estimation of nutrient intake and faecal excretion of zebu cattle grazing natural pasture in semi-arid Mali

*E. Schlecht*<sup>1</sup>, *F. Mahler*<sup>2</sup>, *M. Sangaré*<sup>3</sup>, *A. Susenbeth*<sup>4</sup> and *K. Becker*<sup>1</sup>

1. Institute for Animal Production in the Tropics and Subtropics, University of Hohenheim  
70593 Stuttgart, Federal Republic of Germany
2. University of Hohenheim/ICRISAT, BP 12404, Niamey, Niger
3. Station de Recherches Zootechniques du Sahel (SRZ/S), BP 12, Niono, Mali
4. Institute for Animal Nutrition, University of Hohenheim, 70593 Stuttgart, Federal Republic of Germany

## Abstract

From 1988 to 1992, 30 zebu bulls and 8 oesophageally-fistulated oxen, initially weighing between 150 and 200 kg, were grazed on natural pastures in central Mali. During dry seasons, 15 bulls and 4 oxen were supplemented with local crop by-products. Based on *in vitro* digestibilities of extrusa samples from four oxen in each treatment group, and on estimations of total faecal excretion, the intake of organic matter (IOM), nitrogen (IN) and metabolisable energy (IME) were calculated. Retention of body protein and fat were determined *in vivo* using the deuterium dilution technique. Average dry season IOM of unsupplemented animals varied from 63 g/kg  $W^{0.75}$  ( $\pm 11$ ) to 88 g/kg  $W^{0.75}$  ( $\pm 17$ ), IME varied from 512 kJ/kg  $W^{0.75}$  ( $\pm 93$ ) to 719 kJ/kg  $W^{0.75}$  ( $\pm 135$ ) and IN from 516 mg/kg  $W^{0.75}$  ( $\pm 144$ ) to 1629 mg/kg  $W^{0.75}$  ( $\pm 469$ ). Rainy season IOM was not different from that observed during the dry season. Supplementation increased total IOM, IME and IN but tended to substitute for intake from pasture with increasing vegetation quality. While the additional weight gain of supplemented cattle on pastures with low vegetation density and quality was 53% higher than that of unsupplemented animals, it decreased to 33% on pastures with high densities of good-quality vegetation. There were no significant differences between treatment groups in the relative proportions of empty body water, protein and fat. For an unsupplemented animal of 250 kg body mass, average faecal excretion of organic matter (FOM) and nitrogen (FN) varied within a range of 1.8 kg OM/d ( $\pm 0.3$ ) to 2.4 kg OM/d ( $\pm 0.5$ ) and 20 g N/d ( $\pm 3$ ) to 47 g N/d ( $\pm 9$ ), respectively, in the dry season. Supplementation did not increase FOM and FN. During the wet season total-N excretion increased due to greater urine excretion caused by a surplus of N relative to energy in the diet. The transfer of nutrients from pasture to cropland through manure and urine can contribute considerably to the maintenance of soil fertility in mixed farming systems of the Sahelian zone. Supplementing the diet of free ranging animals has little effect on nutrient cycling.

## Evaluation quantitative et qualitative de l'ingestion et de l'élimination fécale d'éléments nutritifs chez des bovins Zébu élevés sur pâturages naturels en zone semi-aride au Mali

*E. Schlecht*<sup>1</sup>, *F. Mahler*<sup>2</sup>, *M. Sangaré*<sup>3</sup>, *A. Susenbeth*<sup>4</sup> et *K. Becker*

1. Institut de production animale en zones tropicale et subtropicale, Université de Hohenheim  
70593 Stuttgart (Allemagne)
2. Université de Hohenheim/ICRISAT, B.P. 1204, Niamey (Niger)
3. Station de recherches zootechniques du Sahel (SRZ/S), B.P. 12, Niono (Mali)
4. Institut de nutrition animale, Université de Hohenheim, 70593 Stuttgart (Allemagne)



## Résumé

De 1988 à 1992, 30 taureaux zébus mâles et 8 boeufs de labour fistulés à l'oesophage, pesant au départ entre 150 et 200 kg, ont été élevés sur pâturages naturels dans le Mali central. Au cours des saisons sèches, 15 des 30 taureaux et 4 des 8 boeufs ont reçu une complémentation de sous-produits agricoles locaux. L'ingestion de matière organique (IMO), d'azote (IN) et d'énergie métabolisable (IEM) a été déterminée à partir des taux de digestibilité *in vitro* d'échantillons fistulaires prélevés sur 4 boeufs par traitement à partir de l'estimation de l'élimination totale de fèces. La rétention de protéines et de lipides corporels a été déterminée *in vivo* avec la technique de dilution au deutérium. Pendant la saison sèche l'IMO des animaux sans complémentation variait en moyenne de 63 g P<sup>0,75</sup> (±11) à 88 g P<sup>0,75</sup> (±17), l'IEM variait de 512 kJ P<sup>0,75</sup> (±93) à 719 kJ P<sup>0,75</sup> (±135) alors que l'IN allait de 516 mg P<sup>0,75</sup> (±144) à 1629 mg P<sup>0,75</sup> (±469). L'IMO de saison des pluies était semblable à celle de la saison sèche. La complémentation augmentait l'IMO, l'IEM et l'IN mais avait également tendance à remplacer une partie du pâturage ingéré lorsque la végétation était de meilleure qualité. Avec la complémentation, les gains de poids des animaux sur pâturage de faible densité et de qualité médiocre étaient de 53% mais tombaient à 33% sur pâturage de forte densité et de bonne qualité. Aucune différence significative n'avait été enregistrée entre les traitements en ce qui concerne l'eau, les protéines et les lipides du corps. Pour un animal de 250 kg dont l'alimentation n'était pas complétement, l'élimination fécale de matière organique (FMO) et d'azote (FN) allait respectivement de 1,8 kg MO/j (±0,3) à 2,4 kg MO/j (±0,5) et de 20 g N/j (±3) à 47 g N/j (±9), pendant la saison sèche. La complémentation n'augmentait pas ces paramètres. Au cours de la saison humide, l'excrétion totale d'azote augmentait, en raison d'une élimination accrue d'urine due à un excès d'azote par rapport à l'énergie dans la ration. Le transfert d'éléments nutritifs des pâturages aux terres cultivées par le biais du fumier et de l'urine peut largement contribuer au maintien de la fertilité des sols dans les systèmes agricoles mixtes du Sahel. Cependant, la complémentation de l'alimentation des animaux élevés sur pâturage n'a pas beaucoup d'effet sur le recyclage des éléments nutritifs.

## Introduction

Feed supply from Sahelian rangelands is highly dependent on annual precipitation and its seasonal distribution, whereby interannual fluctuations of net primary production are even higher than rainfall variability (Le Houérou et al, 1988). Pastoralists are often blamed for overgrazing and thus being mainly responsible for the progressing degradation of natural pastures (Charney et al, 1975; Sinclair and Fryxell, 1985). However, droughts and increasing population pressure put additional stress on the natural resources of the Sahel. Rangelands are increasingly being cultivated. The overall efficiency of grazing animals is often best, albeit low, on marginal arid and semi-arid land (Till, 1981).

Using crop residues at certain times and in certain amounts to supplement animals on pasture in order to compensate for the biomass scarcity improves animal production (Penning De Vries and Djitéye, 1982). As there are alternative uses for crop residues, strategic utilisation of this resource in crop production and animal nutrition is an important factor within the sustainable agropastoral system in order to optimise its efficiency (Preston, 1994). It does not only stabilise livestock productivity during the critical period of the late dry season but also has the potential to provide more manure as fertiliser and therefore increase plant production while preventing resource degradation.

This paper therefore addresses pasture-livestock interactions as an important factor influencing nutrient cycling in mixed farming systems. It describes the quantitative and qualitative feed intake of cattle grazing natural pasture and how it is influenced by temporary supplementation with crop residues. The grazing animal is characterised as a vector for the carry over of nutrients between natural pasture and cropping areas by quantifying its intake, retention and excretion of nutrients. Organic matter and nitrogen flux between natural pasture and cropping areas are calculated and the influence of crop residues used as supplements on the intensity and direction of the nutrient flow is discussed. From the observed data an example for the nutrient transfer between pasture and cropping area within a sustainable agropastoralist system in semi-arid Mali is presented.

## Study area

The research was conducted at Niono in central Mali in collaboration with the Station du Sahel (SRZ/S), a national research station, and the International Livestock Centre for Africa (ILCA). In 1988 and 1989 smallholder cattle in a village 25 km east of Niono were studied (village herd). From 1990 to 1992, the research continued on the protected rangelands and with cattle from the Station du Sahel (station herd).

The study area is located in the southern Sahelian Zone (latitude 14°17' North, longitude 5°08' West, altitude 295 m NN) and has a semi-arid climate with a single rainy season from June to October. During the study daily temperature during the cool dry season (November to February) averaged 24.6°C with maximum around 30°C. During the hot dry season (March to May) the average daily temperature was 31.4°C with a maximum of around 40°C. In the rainy season (June to October) average daily temperature was 29.4°C and the maximum 37°C. Annual rainfall during the preceding 30 years was 487 mm ( $\pm 134$ ). From 1987 to 1992 the precipitation averaged 480 mm with a minimum of 292 mm in 1990 and a maximum of 659 mm in 1991 (Table 1).

**Table 1.** Annual precipitation during the study period.

Year	1987	1988	1989	1990	1991	1992*
Rain (mm)	438	558	588	292	659	350

\* exceptional 69 mm in January 1992.

## Materials and methods

### Animals, pastures and supplement

Two local breeds of zebu cattle (*Bos indicus*) were used in the experiments. Both the village and the station herds consisted of 30 bulls each. At the onset of the experiments (1988), the animals of the village herd had an average body mass of 204 kg ( $\pm 34$ ). When the studies were resumed in July 1990, the average body mass of the bulls of the station herd was 152 kg ( $\pm 18$ ). Eight castrated zebus of comparable body mass, fitted with oesophagus fistulae (OE-animals) were added to both herds.

Herbaceous pasture vegetation was dominated by *Schoenfeldia gracilis*, *Cenchrus biflorus*, *Panicum laetum*, *Zornia glochidiata* and *Tribulus terrestris*. Amongst the trees and shrubs, *Acacia*, *Combretum* and *Grewia* species, and *Guierrea senegalensis*, *Pterocarpus lucens*, *Sclerocaria birrea* and *Commiphora africana* contributed to the diet particularly during the dry season.

The animals were supplemented with cowpea (*Vigna unguiculata*) hay and rice-feed-meal. The drought in 1990 led to a shortage in the supply of cowpea hay so it was substituted by cottonseed cake from November 1990 (Table 2). Supplements were always offered in balanced mixtures with the ratio of crude protein to metabolisable energy being 13 g/MJ.

**Table 2.** Average nutritional quality of supplements offered.

Supplement	OM (g/kg DM)	Nitrogen (g/kg OM)	ME (MJ/kg)	OMD (%)
Rice-feed-meal	887	17.9	11.2	61
Cowpea hay	893	22.7	10.7	70
Cottonseed expeller	940	46.9	9.9	61

DM = dry matter; ME = metabolisable energy; OM = organic matter; OMD = organic-matter digestibility.

## Management and feeding

According to traditional practice, the cattle were grazing on pasture from 0800 to 1800 hours, with a rest of two to three hours around noon. The village herd grazed on communal rangelands and harvested millet fields while the station herd was only grazed on the protected natural pasture of the research station. To simplify matters the different types of rangelands and the harvested fields are subsumed under "grazed areas" while "pasture" is used in its proper meaning.

Both herds were subdivided into two groups ( $n = 15 + 4$  OE-animals) which underwent different feeding regimes. The control group was exclusively grazed while the animals from the supplement group were additionally fed crop by-products. At night the two groups were kept in separate corrals and supplement mixtures were offered individually. At the village level (1988–89) supplements were distributed during the second half of the dry season (January to June) with the animals receiving 1 kg/d of cowpea hay during the night and 0.5 kg/d of rice-feed-meal (fresh matter) in the morning before leaving the corral. From 1990 to 1992, the supplement ration was offered throughout the dry season until the establishment of the rainy season (November to mid-July). All the supplement mixture was offered in the evening. Balancing forage supply from pasture and adjusting periodically, the quantities distributed varied from 0.7 kg/d in the early dry season to 1.5 kg/d in the late dry season.

Animals were watered once daily and mineral licks were available *ad libitum*. Regular vaccination and treatment against parasites were carried out. Every two weeks all animals were weighed to the nearest kg; weighing always took place in the early morning.

## Determination of feed intake and nutritive quality from natural pasture

The organic matter intake from pasture (IOM) was calculated from faecal organic matter excretion (FOM) and the average *in vitro* organic matter digestibility (OMD) of the selected diet (equation 1).

$$\text{IOM} = \text{FOM} * (1 - \text{OMD})^{-1} \quad (1)$$

According to Mahler (1991) the quantity of faeces was determined with the help of the external marker polyamide (granulated). Daily excretion was calculated from the average marker concentration in faeces ( $C_{PA}$ ), the administered marker dose (PA) and the recovery rate (R) (equation 2).

$$\text{FOM} = \text{PA} * \text{R} * C_{PA}^{-1} \quad (2)$$

Intake studies were conducted with the OE-animals at four- to five-week intervals. Every 12 hours a gelatine capsule containing 45 g PA-marker was administered through the oesophagus fistula. After an adaption period of four days, rectal grab-samples of faeces were taken every seven hours for seven days. Samples were analysed for marker concentration. Residual humidity, ash and nitrogen (N) were determined in dried, marker-free faeces according to standard procedures (Naumann et al, 1983). Nitrogen losses due to drying were estimated from a number of samples which were analysed both in fresh and dried form.

To determine digestibility and nutritive quality of the selected diet, feed samples were collected by means of the oesophagus fistula on five consecutive days during the period of grab-sampling. Collection times were limited to a maximum of 30 minutes and were spread equally over the day using a Latin-square design to eliminate interactions between animals and collection times. The extrusa was collected into water-tight bags and kept on ice until further processing. Pre-dried samples (49°C) were analysed for residual humidity, ash and nitrogen according to standard procedures. As there is still no conformity in literature about correction of extrusa samples for nitrogen contamination by saliva (Langlands, 1966; Marshall et al, 1967; Little, 1972; Scales et al, 1974; Cohen, 1979), this was not done. Organic matter digestibility and metabolisable energy (ME) content were derived from the *in vitro* incubation of extrusa with rumen liquor (Menke et al, 1979).

## Measurements of body composition

Body composition was studied *in vivo* using the deuterium-dilution technique (Byers, 1979); tracer concentration was determined only after equilibration (Chigaru and Holness, 1983). Measurements took place regularly at the beginning of the rainy and dry seasons. After overnight fasting (12 hours), the animals were weighed to the nearest kg and deuterium oxide (D<sub>2</sub>O) of 90.4% enrichment was injected intravenously at a dose of 0.45 g/kg of body mass. When D<sub>2</sub>O had equilibrated after a further fast of eight hours, blood samples (3 x 10 ml) were taken from the jugular vein and stored frozen until analysis. Deuterium concentration was assayed by infrared spectrometry. The body chemical composition was calculated using the regression equations described by Stetter (forthcoming).

## Data analyses

The statistical analyses were performed using the General Linear Model Procedure in SAS (1987). All differences mentioned in this paper are significant at the  $P \leq 0.05$  probability level unless otherwise stated.

## Results and discussion

### Quality of the diet selected on pasture

The quality of the diet selected on pasture was characterised by the organic matter digestibility and the content of nitrogen and metabolisable energy of extrusa samples (Table 3). To correct for ash contamination by saliva, all values were expressed on the basis of organic matter (Neel et al, 1985).

**Table 3.** Nutritive quality of extrusa samples from natural pasture (means and standard deviations;  $n = 50$  samples per month).

Period	OM in DM (g/kg)	OMD (%)	N in OM (g/kg)	ME in OM (MJ/kg)	N:ME (g/MJ)
Dry season					
Mar–Jun '88	867 ± 22 <sup>a</sup>	56 ± 2.5 <sup>a</sup>	8.0 ± 1.8 <sup>a</sup>	8.3 ± 0.5 <sup>a</sup>	1.0 <sup>a</sup>
Jan–Jun '89	835 ± 41 <sup>b</sup>	56 ± 3.0 <sup>a</sup>	14.1 ± 3.0 <sup>b</sup>	8.2 ± 0.5 <sup>a</sup>	1.7 <sup>b</sup>
Nov–Jul '90/91	844 ± 23 <sup>ab</sup>	56 ± 4.9 <sup>a</sup>	12.4 ± 3.3 <sup>b</sup>	8.1 ± 0.9 <sup>a</sup>	1.5 <sup>b</sup>
Nov–May '91/92	840 ± 29 <sup>b</sup>	56 ± 4.2 <sup>a</sup>	17.2 ± 5.5 <sup>c</sup>	8.1 ± 0.7 <sup>a</sup>	2.1 <sup>c</sup>
Rainy season					
Aug–Oct '90	744 ± 73 <sup>c</sup>	63 ± 3.3 <sup>b</sup>	37.0 ± 4.2 <sup>d</sup>	9.1 ± 0.6 <sup>b</sup>	4.1 <sup>d</sup>
Aug–Oct '91	769 ± 78 <sup>c</sup>	67 ± 5.2 <sup>c</sup>	33.7 ± 8.0 <sup>e</sup>	10.0 ± 1.0 <sup>c</sup>	3.4 <sup>e</sup>

DM = dry matter; ME = metabolisable energy; N = nitrogen; N:ME ratio of nitrogen to metabolisable energy; OM = organic matter; OMD = organic matter digestibility.

Figures in the same column with different letters differ at  $P \leq 0.05$ .

Within the observed dry seasons variations in organic matter, organic matter digestibility and metabolisable energy content in extrusa were not significant. Moreover, organic matter digestibility was similar to values of 53–57% OMD reported for the same area by Dicko et al (1983). In contrast to the other quality parameters, dry season nitrogen contents showed significant inter- and intra-seasonal variations. Comparing the quality of the extrusa to the nutrient contents of browse and herbaceous vegetation during the dry season (Diagayete, 1981; Göhl 1981; Guerin et al, 1988) it can be concluded that the nitrogen content of the selected diet is related to the ingestion of browse whereas digestibility and metabolisable energy content are initially determined by the ingestion of dry herbaceous vegetation (standing hay). While the chemical composition of standing hay does not

undergo remarkable change throughout the whole dry season, the proportion of browse in the selected diet depends on the floristic composition of the grazed area and the precipitation of the previous rainy season. The decrease in availability of herbaceous vegetation towards the end of the dry season increases the time spent browsing trees and shrubs from a maximum of 8% of total grazing time in the early dry season to 14% and sometimes even 56% in the late dry season (Dicko 1985). However, for the dry season of 1991/1992 the exceptional rainfall in January 1992 significantly increased the nitrogen content of the diet selected by provoking germination and growth of herbaceous species in the following month.

For rainy seasons inter- and intraseasonal variations in the different quality parameters were higher than for dry seasons. While intraseasonal variations are related to the successive maturity stages of the gramineae, interannual variations are linked to precipitation patterns. For the observed rainy seasons, the digestibility and energy content of extrusa increased by more than 12% as compared to dry season values, and nitrogen content increased by more than 200%.

### Quantitative intake from pasture and supplements

The intake of organic matter (IOM), metabolisable energy (IME) and nitrogen (IN) from pasture and supplements is illustrated in Table 4. Except for 1988 where biomass availability was apparently very low, the average dry season IOM during the studied period was in agreement with the 80 to 100 g OM  $W^{-0.75}$ /day, reported by Oyenuga and Olubajo (1975), Dicko-Touré (1980), Dicko (1985) and Burns et al (1991).

**Table 4.** Daily intake of organic matter, metabolisable energy and nitrogen from pasture and supplements (means and standard deviations;  $n = 4$  OE-animals per group and month).

Period	Intake	Control group		Supplement group	
		Pasture	Pasture	Supplement	
Dry season					
Mar–Jun	IOM" (g)	63 ± 11 <sup>a</sup>	70 ± 23 <sup>ab</sup>	22 ± 2	
1988	IME" (kJ)	512 ± 93 <sup>a</sup>	590 ± 202 <sup>ab</sup>	235 ± 26	
	IN" (mg)	516 ± 144 <sup>a</sup>	512 ± 144 <sup>a</sup>	461 ± 50	
Jan–Jun	IOM" (g)	83 ± 14 <sup>bcd</sup>	94 ± 14 <sup>d</sup>	17 ± 2	
1989	IME" (kJ)	675 ± 127 <sup>bcd</sup>	792 ± 142 <sup>cd</sup>	189 ± 17	
	IN" (mg)	1284 ± 360 <sup>b</sup>	1216 ± 288 <sup>b</sup>	368 ± 34	
Nov–Jul	IOM" (g)	80 ± 18 <sup>bcd</sup>	77 ± 28 <sup>abc</sup>	14 ± 6	
1990/1991	IME" (kJ)	695 ± 187 <sup>bcd</sup>	642 ± 227 <sup>ab</sup>	137 ± 53	
	IN" (mg)	1236 ± 795 <sup>b</sup>	1130 ± 559 <sup>b</sup>	321 ± 136	
Nov–May	IOM" (g)	88 ± 17 <sup>bc</sup>	76 ± 15 <sup>bc</sup>	15 ± 5	
1991/1992	IME" (kJ)	719 ± 135 <sup>bcd</sup>	619 ± 146 <sup>ab</sup>	156 ± 47	
	IN" (mg)	1629 ± 469 <sup>b</sup>	1366 ± 553 <sup>b</sup>	364 ± 105	
Rainy season					
Aug–Oct	IOM" (g)	74 ± 10 <sup>ab</sup>	74 ± 10 <sup>ab</sup>		
1990	IME" (kJ)	681 ± 116 <sup>abc</sup>	681 ± 116 <sup>abc</sup>	—	
	IN" (mg)	2783 ± 578 <sup>c</sup>	2783 ± 578 <sup>c</sup>		
Aug–Oct	IOM" (g)	83 ± 12 <sup>bcd</sup>	83 ± 12 <sup>bcd</sup>		
1991	IME" (kJ)	802 ± 188 <sup>d</sup>	802 ± 188 <sup>d</sup>	—	
	IN" (mg)	2343 ± 702 <sup>c</sup>	2343 ± 702 <sup>c</sup>		

IME" intake of metabolisable energy, IN" intake of nitrogen, IOM" intake of organic matter per kg metabolic body mass ( $W^{0.75}$ ) and day.

Rainy season values are identical for both groups as supplementation stopped with the establishment of the first rains.

Figures within columns and rows with different letters differ at  $P \leq 0.05$ .

Rainy season IOM and IME did not significantly differ from dry-season values. The low intake during summer 1990 was due to late rains (mid-July). As could be expected from extrusa quality, the intake of nitrogen was distinctly higher during rainy seasons than during dry seasons ( $P \leq 0.001$ ). The dry season supplementation generally increased total IOM, IME and IN. While in years of poor or average pasture quality (1988 and 1989) supplementation increased intake from pasture *per se*, the supplementation substituted for pasture vegetation in dry seasons with extraordinary vegetation quality (1991/92). This coincides with the increased substitutional effect of supplements with increasing quality of the roughage ration as described by Menke and Huss (1987). With respect to varying N:E ratios (Table 3), it can be assumed that nitrogen supply from a balanced supplement ration is already sufficient to stimulate IOM and IME. The animal does not need to select for protein, i.e. it can reduce browsing and has more time available to consume herbaceous vegetation. When cattle are only herded during the day time, additional feeding of supplements during the night also increases total eating time, which is extremely limited towards the end of the dry season when ground vegetation becomes scarce and animals have to walk distances of 15 to 24 km per day in search of feed (Dicko, 1985; Mahler, 1991).

### Changes in body mass and nutrient retention

Over a period of two consecutive dry and rainy seasons (February 1988 to September 1989) the supplement group of the village herd gained 95 kg ( $\pm 30$ ) of body mass compared with a gain of 62 kg ( $\pm 38$ ) for the control group (Table 5). In a comparable period (July 1990 to May 1992) the weight gain of the supplemented animals within the station herd averaged 187 kg ( $\pm 25$ ) and that of the control group 141 kg ( $\pm 21$ ). While the additional gain of supplemented animals during these two-year periods was 53% on the communal grazed areas, it was reduced to 33% on the protected rangelands of the station. This indicates that the beneficial effect of supplementing grazing cattle with a fixed amount of by-products is greater on marginal lands where, over an extended period of the year, the natural vegetation supplies only about 60 to 70% of the animals' maintenance requirements (Dicko et al, 1983). With increasing nutrient supply from the rangelands, the advantage of supplementation progressively decreases.

**Table 5.** *Body-mass changes of zebu cattle grazing natural pasture and receiving dry season supplementation (n = 15 animals per group).*

	Date	Control group		Supplement group	
		Body mass (kg)	Changes (%)	Body mass (kg)	Changes (%)
Village herd	15.02.88	205 $\pm$ 35		203 $\pm$ 33	
	24.06.88	174 $\pm$ 32	-15	205 $\pm$ 29	+ 1
	15.11.88	232 $\pm$ 34	+ 33	262 $\pm$ 27	+ 28
	04.07.89	205 $\pm$ 28	-12	270 $\pm$ 29	+ 3
	19.09.89	267 $\pm$ 31	+ 30	298 $\pm$ 25	+ 10
Station herd	15.07.90	148 $\pm$ 13		157 $\pm$ 21	
	15.10.90	210 $\pm$ 19	+ 42	221 $\pm$ 29	+ 41
	29.06.91	185 $\pm$ 15	-12	228 $\pm$ 23	+ 3
	31.10.91	273 $\pm$ 24	+ 48	309 $\pm$ 27	+ 36
	30.05.92	289 $\pm$ 22	+ 6	344 $\pm$ 31	+ 11

The *in vivo* measurements of body composition gave no indication of significant differences in the relative proportions of water, protein and fat in the empty body of supplemented and non-supplemented animals. The average daily retention or mobilisation of nitrogen and energy in different periods of the year was calculated from increases and decreases in body protein and fat (Table 6).

**Table 6.** Seasonal changes in the retention of nitrogen and energy in zebu cattle grazing natural pasture and receiving dry season supplementation ( $n = 15$  animals per group).

Period & duration	Group	Retention ( $W^{0.75}$ per day)					
		Nitrogen (mg)			Energy (kJ)		
		Minimum	Mean	Maximum	Minimum	Mean	Maximum
<b>Dry season</b>							
Nov–Jun '90/91 (248 d)	Control	-73	39 <sup>a</sup>	15	-71	-54 <sup>a</sup>	-34
	Suppl.	-44	-1 <sup>b</sup>	53	-49	-18 <sup>b</sup>	24
Nov–May '91/92 (218 d)	Control	5	21 <sup>c</sup>	70	-35	7 <sup>b</sup>	34
	Suppl.	4	32 <sup>c</sup>	67	6	33 <sup>b</sup>	70
<b>Rainy season</b>							
Jul–Oct '90 (89 d)	Control	137	286 <sup>d</sup>	396	154	261 <sup>d</sup>	363
	Suppl.	157	305 <sup>d</sup>	448	11	235 <sup>d</sup>	354
Jul–Oct '91 (124 d)	Control	204	297 <sup>d</sup>	386	112	175 <sup>e</sup>	323
	Suppl.	231	289 <sup>d</sup>	336	69	117 <sup>f</sup>	153

$W^{0.75}$  metabolic body mass.

Figures in the same column with different letters differ at  $P \leq 0.05$ .

During the dry season of 1990/91 the animals of both groups had to mobilise body fat and protein to cover the respective expenses of the organism, whereas the dry season of 1991/92 allowed for a moderate retention of nitrogen and energy. While nitrogen retention was comparable for the rainy seasons of 1990 and 1991, energy retention significantly decreased in the second rainy season.

When comparing the intake of nitrogen and metabolisable energy to the respective retention, allowance has to be made for non-linear interactions between maintenance requirements and feeding level, protein quality and the ratio of nitrogen to energy in the diet, and age (or weight) of the animal. Moreover, maintenance requirements tend to increase at low levels of fat retention and vice versa. Compensatory growth as expressed by undernourished cattle during a period of re-alimentation also has a distinct and non-linear positive influence on the efficiency of the utilisation of nutrients (Menke and Huss, 1987). As energy requirements for maintenance of body mass include requirements for maintenance and locomotion they vary with respect to the grazing orbit of the animal.

### Organic matter and nitrogen return by manure and urine

The faecal excretion of organic matter (FOM) and nitrogen (FN) was converted to an animal of 250 kg body mass (tropical livestock unit, TLU) (Table 7) for ease of comparison within the system.

As the total amount of recycled organic matter from grazed areas and supplements is correlated to IOM times OMD of the total ration, supplementation did not increase FOM significantly because of

its higher OMD as compared to pasture vegetation. Moreover, FOM decreased during the wet season because of insignificant differences between dry season and wet season IOM combined with a significantly higher OMD of the wet season vegetation (Tables 3 and 4).

**Table 7.** Excretion of organic matter and nitrogen by zebu cattle grazing natural pasture and receiving dry-season supplementation (means and standard deviations;  $n = 4$  OE-animals per group and month).

Period	Group	Faecal excretion (per TLU per day)	
		Organic matter	Nitrogen
Dry season			
Mar–Jun '88	Control	1.8 ± 0.29 <sup>a</sup>	20 ± 3 <sup>a</sup>
	Supplement	2.4 ± 0.47 <sup>bc</sup>	27 ± 5 <sup>ab</sup>
Jan–Jun '89	Control	2.3 ± 0.33 <sup>b</sup>	32 ± 5 <sup>bc</sup>
	Supplement	2.7 ± 0.25 <sup>b</sup>	38 ± 4 <sup>cd</sup>
Nov–Jul '90/91	Control	2.1 ± 0.48 <sup>ab</sup>	39 ± 11 <sup>cde</sup>
	Supplement	2.5 ± 0.88 <sup>bc</sup>	47 ± 12 <sup>ef</sup>
Nov–May '91/92	Control	2.4 ± 0.53 <sup>bc</sup>	47 ± 11 <sup>def</sup>
	Supplement	2.3 ± 0.43 <sup>b</sup>	48 ± 9 <sup>ef</sup>
Rainy season			
Aug–Oct '90	Control	1.8 ± 0.21 <sup>a</sup>	53 ± 13 <sup>fg</sup>
	Supplement	1.8 ± 0.21 <sup>a</sup>	53 ± 13 <sup>fg</sup>
Aug–Oct '91	Control	1.8 ± 0.27 <sup>a</sup>	58 ± 17 <sup>g</sup>
	Supplement	1.8 ± 0.27 <sup>a</sup>	58 ± 17 <sup>g</sup>

TLU Tropical Livestock Unit, animal of 250 kg body mass; rainy season values are identical for both groups as supplementation stopped with the establishment of the first rains.

Figures in the same column with different letters differ at  $P \leq 0.05$ .

Average nitrogen content of excreted faeces during the dry season of 1990/91 was 17.1 g/kg OM ( $\pm 2.23$ ); it was 19.7 g/kg OM ( $\pm 2.04$ ) during the 1991/92 dry season. During the 1991 and 1992 wet seasons the nitrogen content increased to 29.5 g/kg OM ( $\pm 6.15$ ) and 33.1 g/kg OM ( $\pm 6.02$ ), respectively. The nitrogen content of fresh and dried faecal samples was not significantly different with nitrogen losses due to drying of 1.9 g N/kg OM ( $\pm 2.31$ ,  $n = 30$ ). The nitrogen content of dried faeces was therefore not corrected for nitrogen losses.

Total N-excretion was estimated from the difference of ingested and retained nitrogen while the approximate urine nitrogen deposit was calculated as the difference between total and faecal nitrogen excretion (Figure 1). As intake was studied with castrated animals and retention figures were derived from entire males, the total nitrogen excretion might have been slightly underestimated. As Figure 1 indicates, the distinct variations of total N excretions are mainly caused by variable urine N excretion while faecal N excretion shows very little variation even between dry and wet seasons. Increased urine N excretion can be partly explained by an N:ME ratio exceeding microbial N-fixing capacity (1.7 N/MJ) (Rohr et al, 1986) and leading to increased ammonia concentrations in the rumen.



**Figure 1.** Estimated intake and excretion of nitrogen in urine and faeces of zebu cattle grazing natural pasture and receiving dry season supplementation.

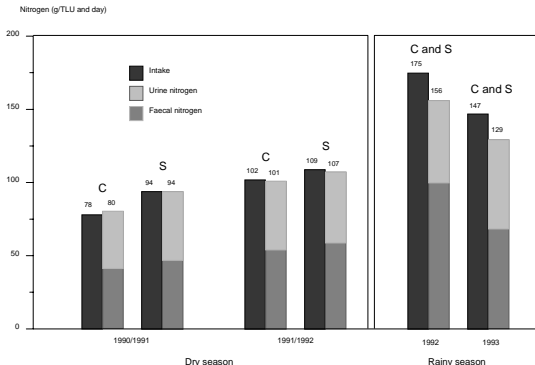

TLU = tropical livestock unit, animal of 250 kg body mass; C = control group; S = supplement group.

### Nutrient flux from grazed areas to crop land

"Corralling livestock at night on crop land is perhaps the most efficient traditional animal and manure management practice for maximising nutrient cycling" (Powell and Williams, 1993: 6). Based on this hypothesis an attempt was made to estimate OM and N transfer from grazed areas (natural pasture and harvested fields) to cropland during the dry season. The calculations were based on observations obtained during the study period and reflect management practices in the region. It was assumed that:

- biomass and nitrogen yield of a 1 ha millet field (straw and grain) is totally exported
- the exported nutrients are recycled by manure from cattle corralled during the night
- corraling takes place from December to June (180 days)
- nutrients are imported from grazed areas only (without supplementation)
- the stocking rate of grazed areas is 0.07 TLU/ha (15 ha/TLU) (Penning de Vries and Djitéye, 1982).

Based on data from Tielkes et al (1992) biomass production (OM) for a 1 ha millet field (grain + straw) is 2800 kg, containing 30 kg of nitrogen. Observations from this study during the dry seasons of 1988 and 1989 showed that defecation in the corral (1830 to 0730 hours) is 43% ( $\pm 11.2$ ,  $n = 458$ ) of total daily faecal excretion. With an average dry season faecal excretion of 2.2 kg OM/TLU per day and 35 g N/TLU per day (Table 7), 0.9 kg FOM and 15 g FN are excreted in the corral. In addition, the diurnal patterns of urine deposit were not measured but it was assumed that the proportion excreted during the night was comparable to that of faeces. An additional 17 g of urine-N is therefore recycled

each night. Replacement of exported OM during the 180 days requires 16 TLU (2800 kg/180 days per 0.95 kg). With the same number of animals 43 kg of faecal nitrogen and approximately 50 kg of urine-N are recycled. Consequently at a stocking rate of 15 ha/TLU, manuring 1 ha of cropland would exploit 240 ha of pasture. If only grain is harvested the quantity of OM that has to be recycled is reduced to 600 kg/ha. The cropland/rangeland ratio is thus reduced to 1:50.

## Conclusions

Results of this study indicate that OMD of intake from natural pasture during the dry season can be assumed to be constant even during several consecutive years, whereas rainy season OMD is much more variable. The N content of the selected diet shows high interannual variability and is significantly higher during the wet season. Whereas the nitrogen content of dry season pasture intake is related to browse vegetation, OMD and energy content of the diet depend on the nutrient quality of the herbaceous layer. IOM values for the dry and wet seasons indicate that with a normal annual precipitation biomass availability during the consecutive dry season is sufficient to allow for maximum IOM. Because of comparable IOM and increased OMD, FOM decreases during wet season compared to the dry season whereas N concentration in faeces and total N excretion are significantly higher during the wet season. The increased N excretion is due to an increased urine N excretion, caused by an unbalanced N:ME ratio in intake. Using these data to calculate OM and N transfer between grazed areas and cropland, it can be concluded that recycling of nutrients by manure and urine considerably contributes to maintaining soil fertility in farmers' fields.

Supplementation of free-ranging animals has a minor influence on recycling of nutrients to cropland. The ratio of grazed area to cropland largely depends on the system's extraction rate and on the primary production of natural pasture. However, it must be noted that in a sustainable system both productivity of cropland as well as of rangeland should be maintained.

## Acknowledgements

The authors wish to thank all colleagues from SRZ/Sahel and ILCA, Mali, for assistance in completion of this project. We express our appreciation to the Department for Animal Nutrition of Hohenheim University for the deuterium analyses. The project was supported by Deutsche Forschungsgemeinschaft (DFG), Deutscher Akademischer Austauschdienst (DAAD) and Studienstiftung des Deutschen Volkes.

## References

- Burns J C, Pond K R and Fisher D S. 1991. Effects of grass species on grazing steers. II. Dry matter intake and digesta kinetics. *Journal of Animal Science (Cambridge)* 69:1199-1204.
- Byers F M. 1979. *Measurement of protein and fat accretion in growing beef cattle through isotope dilution procedures*. Ohio Beef Cattle Research Report. pp. 36-47.
- Charney J G, Stone P H and Quirk W J. 1975. Drought in the Sahara: A biophysical feedback mechanism. *Science* 187:434-435.
- Chigaru P R N and Holness D H. 1983. Estimation of body water and fat in cattle using tritiated water space and live weight with particular reference to the influence of breed. *Journal of Agricultural Science (Cambridge)* 101:257-264.
- Cohen R D H. 1979. Factors influencing the estimation of the nutritive value of the diet selected by cattle fistulated at the oesophagus. *Journal of Agricultural Science (Cambridge)* 93:607-618.
- Diagayete M. 1981. *Untersuchungen zur Erweiterung der Kenntnisse über den Futterwert westafrikanischer Futterpflanzen*. PhD thesis, University of Hohenheim, Hohenheim, Germany.
- Dicko M S. 1985. *Nutrition des bovins du système agro-pastoral du mil en zone sahélienne: Comportement et ingestion volontaire*. ILCA Niger Research Report 85/12. 20 pp. (unpublished)

- Dicko M S, Lambourne J, de Leeuw P N and de Haan C. 1983. Nutrition animale: Les bovins. In: Wilson R T, de Leeuw P N and de Haan C (eds), *Recherches sur les systèmes des zones arides du Mali: résultats préliminaires*. CIPEA Rapport de recherche 5. ILCA (International Livestock Centre for Africa), Addis Ababa, Ethiopia. pp. 96–101.
- Dicko-Touré M S. 1980. Measuring the secondary production of pasture: An applied example in the study of extensive production systems in Mali. In: Le Houérou (ed), *Browse in Africa: The current state of knowledge*. ILCA (International Livestock Centre for Africa), Addis Ababa, Ethiopia. pp. 247–253.
- Göhl B. 1981. In: *Tropical feeds*. FAO Animal Production and Health Series 12. FAO (Food and Agricultural Organization of the United Nations), Rome, Italy. 225 pp.
- Guérin H, Friot D, Mbaye N, Fall S T and Richard D. 1988. L'ingestion des fourrages des parcours naturels en zone sahélienne: mesures en stabulation et au pâturage. *Reproduction Nutrition Développement* 27:197–198.
- Langlands J P. 1966. Studies on the nutritive value of the diet selected by grazing sheep. I. Differences in composition between herbage consumed and material collected from oesophageal fistulae. *Animal Production* 8:253–259.
- Le Houérou H N, Bingham R L and Skerbek W. 1988. Relationship between the variability of primary production and the variability of annual precipitation in world arid lands. *Journal of Arid Environments* 15:1–18.
- Little D A. 1972. Studies on cattle with oesophageal fistulae: the relation of chemical composition of feed to that of extruded bolus. *Australian Journal of Experimental Agricultural Animal Husbandry* 12:126–130.
- Mahler F C. 1991. *Natürliche Weiden und Nebenprodukte des Ackerbaus als Ernährungsgrundlage für die Rinderhaltung am semiariden Standort Westafrikas*. PhD thesis, University of Hohenheim, Stuttgart, Germany. 136 pp.
- Marshall B, Torrell D T and Bredon R M. 1967. Comparison of tropical forages of known composition with samples of these forages collected by esophageal fistulated animals. *Journal of Range Management* 20:310–313.
- Menke K H and Huss W. 1987. *Tierernährung und futtermittelkunde*. Verlag Eugen Ulmer, Stuttgart, Germany. 424 pp.
- Menke K H, Raab L, Salewski A, Steingass H, Fritz D and Schneider W. 1979. The estimation of the digestibility and metabolizable energy content of ruminant feeding stuffs from gas production when they are incubated with rumen liquor *in vitro*. *Journal of Agricultural Science (Cambridge)* 93:217–222.
- Naumann K, Bassler R, Seibold R and Barth K. 1983. *Methodenbuch Band III. Die chemische Untersuchung von Futtermitteln*. Verlag J. Neumann, Neudamm, Germany.
- Neel J P, Kieslig H E, Donart G B, Holechek J L, Goodman T D and Manzanares D. 1985. Nutritive value of forage collected by esophageal fistulated cows in riparian and upland areas of forest land. *Proceedings of the American Society for Animal Science* 36:304–306.
- Oyenuga V A and Olubajo F O. 1975. Pasture productivity in Nigeria. II. Voluntary intake and herbage digestibility. *Journal of Agricultural Science (Cambridge)* 85:337–343.
- Penning De Vries F W T and Djitéye M A. 1982. *La productivité des pâturages sahéliens, une étude des sols, des végétations et de l'exploitation de cette ressource naturelle*. PUDOC, Wageningen, The Netherlands. 525 pp.
- Powell J M and Williams T O. 1993. *Livestock, nutrient cycling and sustainable agriculture in the West African Sahel*. Gatekeeper Series SA 37. IIED (International Institute for Environment and Development), London, UK. 12 pp.
- Preston T R. 1994. Towards sustainable agriculture: Conflict, conscience, commitment and challenges. In: Huisman E A, Osse J W M, van der Heide S, Tamminga S, Tolcamp B J, Schouten W G P, Hollingworth C E and van Winkel G L (eds), *Biological basis of sustainable animal production*. Proceedings of the Fourth ZODIAC Symposium, Wageningen, The Netherlands, 13–15 April 1993. EAAP Publication 67. Wageningen Pers, Wageningen, The Netherlands. pp. 18–28.
- Rohr K, Lebzién P, Schafft H and Schulz E. 1986. Prediction of duodenal flow of non-ammonia nitrogen and amino acid nitrogen in dairy cows. *Livestock Production Science* 14:29–40.

- SAS (Statistical Analysis System). 1987. *SAS/STAT™ guide for personal computers*. Sixth edition. SAS Institute, Inc., Cary, North Carolina, USA. 1028 pp.
- Scales G H, Streeter C L, Denham H and Ward G M. 1974. Effect of mastication, salivary contamination and leaching on the chemical composition of forage samples collected via oesophageal fistulae. *Journal of Animal Science* 38:1278–1283.
- Sinclair A R E and Fryxell J M. 1985. The Sahel of Africa: Ecology of a disaster. *Canadian Journal of Zoology* 63:987–994.
- Tielkes E, Yossi D and Cissé B. 1992. Dual purpose use of pearl-millet in mixed farming systems in Mali. In: De Jong R, Nolan T and Van Bruchem J (eds), *Natural resource development and utilization*. Proceedings of the Commission of European Communities Coordination Workshop, Wageningen, The Netherlands, 29 June–2 July 1992. Agricultural University, Wageningen, The Netherlands. pp. 120–123.
- Till A R. 1981. Cycling of plant nutrients in pastures. In: Morley F H W (ed), *Grazing animals*. World Animal Science B 1. Elsevier Scientific Publishing Company, Amsterdam, The Netherlands. pp. 33–51.

# Foraging behaviour of cattle grazing semi-arid rangelands in the Sahel of Mali

L. Diarra,<sup>1</sup> P. Hiernaux<sup>2</sup> and P.N. de Leeuw<sup>3</sup>

1. Centre International pour l'élevage en Afrique (CIPEA), BP 60 Bamako, Mali
2. Centre international pour l'élevage en Afrique (CIPEA), Centre Sahélien ICRISAT BP 12404, Niamey, Niger
3. International Livestock Centre for Africa (ILCA), P O Box 46847, Nairobi, Kenya

## Abstract

Cattle nutrition studies in the Sahel have shown inter-seasonal differences in feed intake and markedly higher nitrogen concentrations in selected feed than in forage on offer, indicating efficient grazing selectivity. In this study, seasonal changes in feeding behaviour by cattle were related to the standing mass, nutrient concentrations and floristic composition of the herbage. Cattle preferences for landscape units were first inferred from differences between the relative extent of units along grazing routes and in the area accessible to the herd. Cattle preferences were further rated using a chi-square test of the relative frequency of the bites recorded in one landscape unit with the relative extent of that unit along the daily grazing route of the herd. Similar preference ratings were calculated for classes of herbage standing mass within landscape units. The relative frequency of plant species recorded as dominant in randomly sampled bites provided an estimate of cattle seasonal preferences for plant species. Early in the wet season, high selectivity was observed between landscape units with herbage mass ranging from 200 to 1500 kg DM/ha, but there were no significant differences in selectivity between mass classes. Later in the wet season, the selectivity was more influenced by herbage mass than by landscape unit. Cattle avoided patches of low and high mass and selected less common species, including forbs and some browses. Early in the dry season, no clear trend was detected in selectivity for landscape unit or herbage mass. As the dry season progressed, herbage mass and quality decreased, the few remaining high-mass patches became increasingly selected and the diet included an increased number of species and a higher proportion of browses. Seasonal changes in foraging, therefore, do not depend only on the standing mass and protein content of the herbage on offer, but are also influenced by the spatial distribution of the vegetation organised in a hierarchy of scales from plant communities down to patches and individual plants. The impact of such foraging behaviour on vegetation and nutrient cycling is discussed.

## Comportement alimentaire de bovins au pâturage dans la zone semi-aride du Sahel au Mali

L. Diarra,<sup>1</sup> P. Hiernaux<sup>2</sup> et P.N. de Leeuw<sup>3</sup>

1. Centre international pour l'élevage en Afrique (CIPEA), B.P. 60, Bamako (Mali)
2. Centre international pour l'élevage en Afrique (CIPEA), Centre sahélien ICRISAT, B.P. 12404, Niamey (Niger)
3. Centre international pour l'élevage en Afrique (CIPEA), B.P. 46847, Nairobi (Kenya)

## Résumé

*Des études effectuées sur l'alimentation des animaux dans le Sahel ont mis en évidence des variations saisonnières de l'ingestion. Elles ont en outre montré que les teneurs en azote des parties des plantes choisies par les animaux étaient nettement supérieures à celles de l'ensemble du fourrage*

*offert, ce qui atteste l'efficacité de la sélection opérée par les animaux au pâturage. La présente étude met en parallèle les changements saisonniers du comportement alimentaire des bovins et la biomasse fourragère sur pied, sa teneur en éléments nutritifs et sa composition floristique. La préférence des bovins pour certaines unités de paysage a d'abord été déduite des différences entre les étendues relatives de chaque unité de paysage le long des itinéraires de pâturage et dans la zone accessible au bétail. Ces préférences ont en outre été évaluées en testant, par la méthode du khi-carré, l'écart entre la fréquence relative des coups de dents relevés dans une unité de paysage et l'étendue relative de cette unité le long de l'itinéraire quotidien de pâturage du troupeau. Des préférences similaires ont été déterminées pour les diverses classes de végétaux rencontrées dans chaque unité de paysage. La fréquence relative des espèces dominantes dans un échantillon aléatoire de coups de dents fournit une indication des préférences saisonnières du bétail pour certaines espèces végétales. Au début de la saison des pluies, il y avait une forte sélectivité entre les unités de paysage dont la biomasse sur pied allait de 200 à 1 500 kg de MS/ha, mais il n'y avait pas de différence significative de sélectivité entre les classes de végétaux. Au cours de la saison des pluies, la sélection dépendait plus de la biomasse que de la nature de l'unité de paysage: les bovins évitaient les zones à forte ou faible biomasse et choisissaient les espèces moins fréquentes, y compris les dicotylédones et certains ligneux fourragers. Au début de la saison sèche, aucune tendance nette ne se dégageait dans le choix des unités de paysage et des biomasses végétales. Plus avant dans cette saison, la quantité et la qualité de l'herbe diminuaient, les quelques hautes plages restantes étaient de plus en plus sélectionnées et le nombre d'espèces et la proportion de ligneux augmentaient dans la ration. Les changements saisonniers du comportement alimentaire des animaux au pâturage ne dépendent donc pas seulement de la biomasse sur pied et de la teneur en protéines du fourrage disponible; ils dépendent également de la distribution spatiale de la végétation, allant de communautés végétales aux plantes individuelles entières en passant par les plages herbacées. Enfin, l'impact d'un tel comportement sur la végétation et le recyclage des éléments nutritifs a été examiné.*

## Introduction

Removal of primary production by herbivores contributes to nutrient cycling in natural ecosystems. In this process, part of the nutrients ingested along the daily grazing route are transferred to water points and encampments, where livestock rest. Within grazing areas, removal rates can be estimated from stocking density provided there is sufficient knowledge of appropriate forage consumption (Boudet, 1984; Dicko and Sangaré, 1986; Richard et al, 1989). Intake of grazing cattle has been recently measured in the semi-arid areas of Mali, thus improving the possibilities of assessing the removal of herbage mass and nutrients by individual animals (Mahler, 1990; Maïga, 1992; Rath, 1993; Schlecht et al, this volume). Nutrient intake by ruminant livestock can also be predicted from the requirements for maintenance, growth and lactation (Diarra and Coulibaly, 1990; Reynolds and de Leeuw, this volume). In both approaches, stocking densities expressed in tropical livestock units (TLU/ha) are usually derived from estimates of livestock population within administrative areas (de Leeuw and Tothill, 1991). Indirect estimates of herbage removal can also be derived from the seasonal dynamics of range feed resources after adjusting for wastage caused by trampling, consumption by other herbivores and burning (Hiernaux, 1989a; de Leeuw et al, 1991). These approaches provide overall averages, but do not take into account the selective foraging behaviour of livestock and the resulting differences in nutrient removal in a spatial context (Coughenour et al, 1990).

It is therefore of interest to investigate to what extent grazing pressure varies across the landscape in space and time, and to ascertain whether preferential grazing by livestock is significant enough to create large differences in nutrient cycling and in the impact of grazing on the environment. The foraging behaviour of cattle subject to passive herding was studied at four levels: the choice of a grazing orbit<sup>1</sup> in the land potentially accessible to the livestock; choice of landscape units along the daily route<sup>2</sup>

1. Defined as the area falling within the boundary that encircles all daily routes of the monitored herd during a given period of time (a year if not specified).
2. Defined as the strip of land that comprises the area covered by all individual treks of animals within the monitored herd during 24 hours.

within the grazing orbit; the selection of patch habitats as feeding stations within each landscape unit; and the selection for particular plant species in cattle bites.

## **Materials and methods**

### **Location of study site**

The research was conducted at Niono (14°17'N; 05°08'W), in the research station of the Institut d'Economie Rurale (IER) of Mali. The climate at Niono is semi-arid tropical, with a single rainy season from June to September and average annual rainfall of 487 mm ( $\pm$  134). In 1991 and 1992, rainfall was 659 and 350 mm, respectively, with an exceptional 69 mm during January 1992. Mean temperatures vary from 31°C in May to 23°C in January.

### **Vegetation in the grazing orbit**

The grazing orbit of the monitored herd crossed several vegetation types associated with three major landscapes: undulating and flattened fixed sand dunes, fossil alluvial deposits of the Niger flood plain covered with a sandy mantle of various thickness, and shallow depressions that act as drainage lines (Boudet and Leclercq, 1970; Hiernaux et al, 1983; Djitèye, 1984; Breman and de Ridder, 1991). Soil profiles of sand overlying heavier soils (loamy clays) predominate, varying from well to poorly drained. Species composition is influenced by soil texture, drainage, soil surface characteristics (including soil crusting) and the likelihood of temporary flooding in the rainy season. Further heterogeneity is caused by the history of cropping, grazing and firewood extraction. In general, species diversity is poor and a large proportion of the species are found in several vegetation types.

Species composition of the herbaceous layer is subject to large changes from year to year (Breman and Cissé, 1977; Hiernaux, 1985; Grouzis, 1988; Guerin et al, 1988). The structure and floristic composition of the woody plants were therefore used to classify and map vegetation types (Hiernaux and Haywood, 1978). The species composition of the herbaceous layer of these vegetation types was then characterised by repeated sampling over nine years (1976–84). For this study, the vegetation types encountered in the grazing orbit were grouped into five broad landscape units (Table 1).

Each month, four classes of herbage standing mass (bare soil, low, medium and high) were identified in each landscape unit by visual estimates of the herbage density over one square metre plots (Hiernaux, 1989b). The relative area covered by each class was estimated by repeating this stratification, every metre, over a 500 m long linear transect within the landscape unit. Out of 500, twelve plots were sampled using random stratification to measure standing herbage mass. The average mass per class was weighted by the relative extent of each class in the landscape unit, and by the relative extent of that landscape unit along the daily route of cattle to assess average forage mass on offer.

### **Herd management**

The monitored herd consisted of 30 zebu bulls with an average weight of 209 kg ( $\pm$ 19). Animal performance and nutrition were simultaneously studied (Schlecht et al, this volume). The cattle were corralled at night and released to graze around 0800 hours. They returned to the paddock site around 1300 to rest for about one hour and grazed again in the late afternoon before returning to the paddock around 1800 hours. Herding practices consisted solely of orienting the herd in one direction to start the daily route, and sometimes watching over the herd from a distance. In the wet season, cattle watered freely at small ponds along the grazing route. As these temporary ponds dried off, the herd had access to water once a day, around noon, from a permanent pond located 2 km from the paddock. Despite this seasonal constraint, the grazing orbit changed little from month to month, although the grazing route was shorter during the wet season (7–10 km/d) than the dry season (12–17 km/d).

**Table 1.** Dominant species in major landscape units, Niono ranch, Mali.

Landscape and vegetation types	Dominant woody plants	Dominant grasses	Dominant dicotyledons
Undulating fixed dunes	<i>Sclerocarya birrea</i> <i>Terminalia avicenioides</i> <i>Combretum aculeatum</i> <i>Guiera senegalensis</i> <sup>1</sup> <i>Balanites aegyptiaca</i> <sup>2</sup>	<i>Aristida mutabilis</i> <i>Schoenefeldia gracilis</i> <i>Brachiaria xantholeuca</i> <sup>2</sup> <i>Cenchrus biflorus</i> <sup>1</sup> <i>Eragrostis tremula</i> <sup>1</sup>	<i>Borreria radiata</i> <i>Indigofera aspera</i> <i>Ipomoea coccinosperma</i> <i>Alysicarpus ovalifolius</i> <sup>2</sup> <i>Zornia glochidiata</i> <sup>2</sup>
Flattened fixed dunes	<i>Combretum ghazalense</i> <i>Sclerocarya birrea</i> <i>Ziziphus mauritiana</i> <i>Guiera senegalensis</i> <sup>1</sup> <i>Acacia senegal</i> <sup>1</sup>	<i>Schoenefeldia gracilis</i> <i>Aristida adsensionis</i> <i>Schizachyrium exile</i> <i>Dactyloctenium aegyptiacum</i> <sup>2</sup> <i>Chloris prieurii</i> <sup>2</sup>	<i>Borreria chaetocephala</i> <i>Blepharis linearifolia</i> <i>Cassia mimosoides</i> <sup>1</sup> <i>Tribulus terrestris</i> <sup>2</sup> <i>Zornia glochidiata</i> <sup>2</sup>
Alluvial plains covered with sands	<i>Bombax costatum</i> <i>Grewia bicolor</i> <i>Combretum nigricans</i> <i>Ximenia americana</i> <sup>1</sup> <i>Acacia seyal</i> <sup>2</sup>	<i>Diheteropogon hagerupii</i> <i>Schoenefeldia gracilis</i> <i>Elionurus elegans</i> <i>Andropogon gayanus</i> <i>Setaria anceps</i> <sup>1</sup>	<i>Borreria stachydea</i> <i>Indigofera priureana</i> <i>Indigofera astragalina</i> <i>Ipomoea vagans</i> <sup>2</sup> <i>Zornia glochidiata</i> <sup>2</sup>
Alluvial plains loamy flats	<i>Pterocarpus lucens</i> <i>Feretia apodanthera</i> <i>Combretum micranthum</i> <i>Boscia senegalensis</i> <sup>2</sup> <i>Acacia seyal</i> <sup>2</sup>	<i>Loudetia togoensis</i> <i>Diheteropogon hagerupii</i> <i>Diectomis fastigiata</i> <i>Andropogon pseudapricus</i> <i>Pennisetum pedicellatum</i> <sup>1</sup>	<i>Borreria scabra</i> <i>Indigofera senegalensis</i> <i>Sida alba</i> <i>Monechma ciliatum</i> <sup>2</sup> <i>Cassia tora</i> <sup>1,2</sup>
Alluvial plains clayed depressions	<i>Anogeissus leiocarpus</i> <i>Mitragyna inermis</i> <i>Acacia seyal</i> <i>Acacia nilotica</i> <sup>2</sup> <i>Piliostigma reticulata</i> <sup>1,2</sup>	<i>Panicum laetum</i> <i>Panicum anabaptistum</i> <i>Echinochloa colona</i> <i>Setaria pallide-fusca</i> <sup>1,2</sup> <i>Eragrostis pilosa</i> <sup>1</sup>	<i>Borreria filifolia</i> <i>Aeschynomene sensitiva</i> <i>Ipomoea aquatica</i> <i>Alternanthera nodiflora</i> <sup>2</sup> <i>Cassia tora</i> <sup>1,2</sup>

1. Species indicator of past cropping.

2. Species indicator of heavy grazing by livestock.

## Livestock behaviour observations

From August 1991 to July 1992, livestock behaviour was observed over five consecutive days at approximately six-week intervals. During the course of the day, a different animal was selected at random every hour, and its activity (grazing, walking, watering and resting-ruminating) was recorded every 10 minutes (i.e. six observations per hour). Thus, about 250 spot-observations were recorded each month. Whenever the animal was found grazing, the grazed landscape unit and the class of herbage mass within this unit were recorded. Five subsequent bites were timed to determine bite rate, registering the main consumed species.

## Foraging behaviour measurements

Foraging behaviour was studied at four spatial levels of forage selection (Coleman et al, 1989).

## Selection of daily route

The relative area covered by each landscape unit along the daily grazing route was determined from a vegetation map of Niono Ranch (Hiernaux, 1985) on which the route was plotted. The composition



in landscape units of the annual grazing orbit was estimated by averaging the composition of the route observed each month. The orbit composition was compared with the distribution of the landscape units in the area potentially accessible to the herd, defined as the non-cropped area falling within a 2-km radius from the central point between the corral and the pond (Table 2).

**Table 2.** Monthly and yearly average of the proportions of the daily livestock route on landscape units, compared with the relative extent of these units in the area accessible to the herd.

Landscape units	August 1991	September/ November 1991	February 1992	April 1992	May 1992	June 1992	July 1992	Weighted mean	Area %
Undulating fixed dunes	2	2	13	17	(30)	(32)	(49)	15.1	22
Flattened fixed dunes	(32)	(40)	(34)	26	12	13	15	29.7	25
Alluvial plains sandy	(31)	(34)	(38)	(37)	26	22	24	(32.4)	23
Alluvial plains loamy flats	(21)	14	12	3	(24)	(28)	7	14.2	15
Alluvial plains depressions	7	10	3	17	8	5	5	8.2	15
Whole daily route	100	100	100	100	100	100	100	99.6	100

\* Underlined figures indicate when route proportion is inferior to area by at least 20%; figures in parentheses indicate when proportion is superior to area by at least 20%.

### Selection of landscape units

Every month, the relative frequency of cattle bites recorded in one landscape unit was compared with the relative extent of the same unit in the grazing route, indicating whether the vegetation type was preferred or avoided. The statistical significance of this comparison was determined by a chi-square test for proportions (Dagnelie, 1975).

### Selection of forage mass patches

Cattle preference for patches of different forage mass were rated by recording the frequency of cattle bites per class of forage mass within landscape units and comparing these to the relative extent of that class in the route. The statistical significance of this comparison was determined by the same chi-square test used for landscape units.

### Selection of species

Data on the species contribution to the standing herbage mass offered each month per landscape unit were insufficient as a reference to which the composition of diet selected by cattle could be compared. However, the relative frequency of plant species recorded as dominant in five consecutive bites provided an indication of cattle preferences for plant species. The species contributions to diet were averaged per month and grouped by plant type: grasses, dicotyledons and woody species.

## Results

### Seasonal variation in feed supply

The quantity of forage offered was highly seasonal (Table 3). The development of herbaceous vegetation across all landscape units showed high overall above-ground mass from August to November. Highest yields were observed in the drained areas where taller late maturing grasses (*Diheteropogon hagerupii*, *Andropogon pseudapricus* and *Andropogon gayanus*) were dominant.

Despite low grazing pressure in the ranch, herbage mass decreased rapidly after it reached a maximum at flowering. The rapid decrease was in part due to the dispersion of the grass seeds and to the shedding of dicotyledon leaves (Diarra, 1983). In November, the mean of herbage standing mass over the grazing orbit was 0.9 t/ha with nitrogen (N) concentration ranging between 1.2 and 0.6%. The degradation of the standing mass usually slows during the first half of the dry season, but exceptional rains in January 1992 (69 mm in two days) modified the normal evolution. The organic decomposition of the straw increased while rains triggered the germination of some annual dicotyledons such as *Tribulus terrestris* and *Zornia glochidiata*, and grasses such as *Schoenefeldia gracilis* and *Brachiaria xantholeuca*. Thus, in February, herbage consisted of a mix of young green plants and leached straws with 0.5 t/ha average mass and a wide range in N concentration (from 2.5 to 0.6%). Low herbage mass prevailed everywhere from the late dry season (April–May) to the early wet season (June–July).

### Selection of the annual grazing orbit in accessible land

About 15% of the annual grazing orbit was located on undulating dunes, 30% on flattened dunes, 32% on sandy plains, 14% on loamy plains and only 8% on clay depressions (Table 2). These proportions differ little from the relative area covered by the same landscape units in land potentially accessible to the herd (i.e. 22, 25, 22, 15 and 15%, respectively). However, clay depressions were less common in the grazing orbit than in the area, reflecting livestock avoidance of this unit during the year except during the late dry season. Sandy plains were more frequent in the orbit than in the area, but this could be a result of the corral being located within a sandy plain and may not reflect a special preference.

### Selection of the daily route in the grazing orbit

Although the grazing orbit was confined to a restricted area of the Niono ranch, slight changes in daily route resulted in significant month to month shifts in the vegetation composition (Table 2). Early in the wet season, large fractions of the route were devoted to sandy upland and to loamy flats where cattle found dense patches of young green grass (Table 3). When upland grass headed this choice shifted to sandy plains and flattened dunes where cattle found more dicotyledons and long cycle grasses which had not yet headed. As the dry season progressed the route included more lowlands but this shift was most likely less than normal due to the exceptional rains in January.

**Table 3.** Monthly weighted averages of green (g) or dry (d) herbage standing mass (kg DM/ha) of major landscape units from August 1991 to July 1992, Niono ranch, Mali.

Landscape units	August g	September g+d	November d	February d/g	April d	May d	June d/g	July g
Undulating fixed dunes	928	691	542	354/26	386	305	192/48	179
Flattened fixed dunes	691	860	798	594/34	599	295	323/12	192
Alluvial plains sandy	388	1183	810	323/142	476	404	0/39	610
Alluvial plains loamy flats	998	1301	1285	285/40	528	286	100/44	731
Alluvial plains depressions	1579	2448	1344	452/58	531	127	0/0	715
Whole daily route	751	1187	920	418/75	465	311	131/38	350

### Selection of landscape units along daily route

Cattle selection among the landscape units along the route was generally weak but reinforced the selection of vegetation units made in the choice of an route. In the wet season, cattle significantly preferred the vegetation of the sandy uplands which comprised 51% of the bites counts for 42% of the daily route (Table 4). Preference for dunes generalised to all upper lying sandy ranges in the early dry

season with 64% of bites counts for 42% of the route in November. The pattern of preferences reversed later in the dry season with a distinct preference for lowlands. For instance, in April 29% of the bites took place in the lowlands although they extended only over 17% of the route.

**Table 4.** *Examples of seasonal selection of landscape units and herbage mass in per cent of bite counts (bite %), compared to their spatial extent along the grazing itinerary (ext. %).*

Landscape units	Classes of herbage standing mass	Late wet season (September)			Early dry season (November)			Late dry season (April)		
		Ext. (%)	Bite (%)	Test <sup>1</sup>	Ext. (%)	Bite (%)	Test <sup>1</sup>	Ext. (%)	Bite (%)	Test <sup>1</sup>
Undulating fixed dunes	Bare soil	0.4	0		0.2	0		8.5	0	
	low	0.8	3	*	0.7	3	+	3.9	0	‡
	medium	0.5	3	*	1.0	4	+	4.2	13	+++
	high	0.3	3	*	0.1	2	*	0.4	2	*
	total	2.0	9	+++	2.0	9	+++	17.0	15	*
Flattened fixed dunes	Bare soil	10.5	0		13.9	0		12.5	0	
	low	12.5	8	*	8.7	30	+++	5.0	3	*
	medium	10.6	22	+	9.5	16	+	5.6	8	*
	high	6.4	12	*	7.9	9	*	2.9	18	+++
	total	40.0	42	*	40.0	55	+	26.0	29	*
Alluvial plain covered with sands	Bare soil	2.6	0		9.0	0		16.4	0	
	low	7.2	12	+++	5.6	12	+	6.9	5	*
	medium	16.5	8	‡‡	14.0	5	‡‡	11.1	9	*
	high	7.7	6	*	5.4	2	*	2.6	10	+++
	total	34.0	26	*	34.0	19	‡‡	37.0	24	*
Alluvial plain loamy flats	Bare soil	1.7	0		3.5	0		1.7	0	
	low	4.3	5	*	4.2	5	*	0.3	0	*
	medium	3.9	8	+++	4.8	3	*	0.8	2	*
	high	4.1	5	*	1.5	8	+++	0.2	0	*
	total	14.0	18	+	14.0	16	*	3.0	2	*
Alluvial plain clay depression	Bare soil	0.8	0		3.1	0		8.0	0	
	low	1.3	0	*	1.2	0	*	2.1	6	+
	medium	3.5	0	‡	4.2	0	‡	4.8	3	*
	high	4.4	6	*	1.5	2	*	2.1	20	+++
	total	10.0	6	*	10.0	2	‡‡	17.0	29	+++
All grazing	Bare soil	15.9	0	test	29.7	0	test	47.1	0	test
	low	26.1	28	does	20.4	50	does	18.2	14	does
	medium	35.1	41	not	33.5	28	not	26.5	35	not
	high	22.9	32	apply	16.4	23	apply	128.2	50	apply
	total	100	101		100	101		100	100	

1. Chi-square test of the differences between proportions in bites and along itinerary.

+, ++, +++ significantly preferred by cattle at 0.05, 0.01 and 0.001, respectively.

‡, ‡‡, ‡‡‡ significantly avoided at 0.5, 0.1 and 0.001, respectively.

\* not significantly different at 0.05.

## Selection of herbage mass patches within landscape units

In September, the bare ground fraction was low (16%) and average standing herbage mass for the entire orbit was 1.2 t/ha. High standing mass patches were circumvented by cattle, which preferred to graze medium standing mass patches on the dune and on the loamy flats (Table 4). The animals also selected low-yielding patches on the sandy plains where the herbaceous layer was dominated by the short cycle dicotyledon, *Tribulus terrestris*, associated with a small annual grass, *Dactyloctenium aegyptiacum*. Both species were well adapted to heavy grazing pressure. Early in the dry season, low standing mass patches became the first choice across all landscape units, accounting for 50% of bite counts while covering only 20% of the route. Meanwhile, bare ground patches increased to 30% of the grazing orbit; further increases were recorded (50%) later in the dry season (April). Herbage standing mass became more uniform across landscape units and declined from 0.5 t/ha in April to less than 0.2 t/ha when the first rains occurred in June. As herbage standing mass and quality declined the selection of the cattle for feed stations reversed. Patches with relative high standing mass were increasingly selected, comprising 50% of the bite counts for only 13% of the route in May.

## Selection of species

Grasses were recorded as the dominant species in 60 to 86% of the sampled bites from the early dry to the mid-wet seasons. The grass fraction decreased to 50% of bites counts at grass flowering late in the wet season (Table 5). *Schoenefeldia gracilis*, the dominant grass in Niono Ranch, was the most frequent species in the bites throughout the year. Among the other grasses, only *Brachiaria* species, that grows in small patches either under the crown of a tree or a shrub (*B. deflexa*, *B. ramosa* and *B. lata*) or around ancient termite mounds and ant nests (*B. xantholeuca*), were significantly present in the cattle diet. Grazing of tall and longer cycle grasses such as *Pennisetum pedicellatum*, *Diheteropogon hagerupii*, *Andropogon pseudapricus* was not recorded. In the dry season, however, the relatively high contribution of grasses to the diet was possibly due to the unusual rain in late January that brought about a temporary greening of the herbaceous layer.

**Table 5.** Monthly average of the relative frequency of plant species recorded as dominant in cattle bites.

Species	August	September	November	February	April	May	June	July
<i>Schoenefeldia gracilis</i>	60	50	65	30	88	80	50	72
<i>Brachiaria lata</i>	10			20		2	1	2
<i>Brachiaria xantholeuca</i>	1			10		2	1	4
<i>Cenchrus biflorus</i>							10	
<i>Eragrostis tremula</i>						2		
<i>Dactyloctenium aegyptiacum</i>	3							1
All grasses	74	50	65	60	88	86	62	79
<i>Zornia glochidiata</i>	20	5	20	15	2		2	15
<i>Tribulus terrestris</i>	1			20	3	12	20	6
<i>Ipomoea</i> spp	2	25	5	3		2		
Other dicotyledons	3	17	8	2	7		5	
All dicotyledons (herb)	26	47	33	40	12	14	27	21
Woody plants (browses)	0	3	2	0	0	0	11	0

*Zornia glochidiata*, a short-cycle legume, promoted by heavy grazing during the wet season (Cissé, 1986), ranked first among the dicotyledons consumed. In addition, the new growth of *Tribulus*

*terrestris*, another short-cycle dicotyledon adapted to heavy grazing and which is abundant in the range that surrounds the corral, attracted stock from February onwards.

The importance in the diet of four *Ipomoea* species was striking. *I. eriocarpa*, *I. coccinosperma*, *I. pestigridis* and *I. vagans* dominated in 25% of the bites in September. Although *Ipomoea* species occurred in most of the landscape units they accounted for a small fraction of the herbage mass, certainly far less than 1%. A few browse species such as *Pterocarpus lucens* and *Commiphora africana* were browsed early and late in the dry season. This contribution could have been larger if not for the unusual greening of the herbaceous layer in February which rendered herbs more attractive than browses.

## Discussion

### Forage selection

The choice of the daily route was only constrained by the location of the corral site during the rainy season. During the dry season, the permanent water site became a second constraint. The orientation given to the herd by the herders in the morning varied little from north-east to north-west and did not significantly influence the route.

### Seasonal changes in forage selection

The overall similarity between the relative extent of each landscape unit in the annual grazing orbit, and their extent in the area that was accessible to the herd, suggests a weak forage selection. However, there were significant seasonal shifts in the landscape units visited by cattle (Table 2) and in the frequency of bites per landscape unit (Table 4), indicating some foraging selectivity at the landscape level. Cattle significantly targeted upper dune and loamy flats during the wet season. They selected dunes and avoided depressions early in the dry season while at the end of the dry season they preferred the depressions and avoided the loamy plains. These choices could in part be explained by cattle avoiding muddy and flooded places during the wet season. These seasonal differences in foraging selection were not as marked as the one reported for communal grazing areas in Zimbabwe (Cousins, 1987; Scoones, 1989).

Several factors may have weakened the contrasts between seasons. Low grazing pressure in the Niono ranch, giving unrestricted access to forage all year round probably limited the scope of adaptive behaviour. The usual contrast between foraging behaviour during the wet and the dry season may have been attenuated by the relatively high feeding quality of the herbaceous layer during the 1991–92 dry season. For instance, cattle shifted back to sandy areas in February following grass germination triggered by the January rains (Table 2). The very light herding practices and exclusion of night grazing, may also have reduced seasonal contrast in foraging behaviour especially since the observed animals, bred on the research station, had little experience of free grazing.

### Selection of landscape units

Differences in soil and vegetation attributes between landscape units may affect forage selection. It is difficult, however, to disentangle the role of different attributes such as soil moisture and texture, density of woody plants, apparent density and patchiness of the herb layer and floristic composition. For some attributes the range of variation between landscape units was not wide enough to strongly influence cattle choice. This could apply to woody plant cover which varies from very open (1–5% cover) to rather dense (25–30% cover); this is not dense enough, however, to hamper cattle movements like the dense thickets in the arid rangelands of southern Ethiopia (Coppock, 1993). There is no evidence for the relative attractiveness of a vegetation type being influenced by the density, size and species composition of woody plants perceived at a distance. Other factors may have contributed to weaken cattle selection between vegetation units. The fine-textured spatial arrangement of the vegetation units in relation to the flatness and alluvial history of the landscape, forced livestock to mix

landscape units on their route, crossing less desired rangelands to move from one desired rangeland to the next. For vegetation attributes such as herbage standing mass, the variation within a landscape unit is greater than inter-type variation. Thus, choices between landscape units are better explained by choices made at the level of the grazing station patches.

### **Selection of grazing station patches**

The herbaceous layer is very heterogenous at a micro-scale and consists of an arrangement of patches varying in size from a few square metres to a few hundred square metres (Grouzis, 1988). Patches differ by the density and standing mass of the herbaceous layer, and sometimes also by their species composition (Vetaas, 1992). As a consequence, they show differences in nutrient concentration at the end of the growing season. As standing mass increases for a given species, N concentration decreases because of higher dilution (Penning de Vries and Djitéye, 1982). Differences in species composition are often due to edaphic factors that are reflected by differences in soil surface features (Casenave and Valentin, 1989). Differences in plant species composition entail differences in nutrient concentration such as higher N concentration in legumes than in grass (Turner, 1992).

Selection of feeding stations by cattle on the basis of herbage mass within landscape units was not very clear and changed with seasons (Table 3). Early in the wet season, the choice is limited as standing mass is low and nutritive quality ubiquitously high (Rath, 1993). As the growth progresses, contrasts between patches develop and, in September, cattle targeted low or medium mass patches depending on the vegetation type. Optimisation of energy intake would be favoured by grazing medium mass patches especially when grass is at the heading stage because of the negative impact of large stem/leaf ratios on bite size (Forbes, 1988). Optimisation of protein intake would be favoured by grazing lower mass patches either dominated by dicotyledons such as *Zornia glochidiata* and *Tribulus terrestris* or grasses that are regrowing from grazing earlier in the season (McNaughton et al, 1983). Such regrowth grazing is frequent in *Brachiaria* dominated patches located on higher fertility spots such as under trees or on termite mounds.

Low and medium standing mass patches were also targeted by cattle early in the dry season. This preference may be because cattle search for more palatable forage and avoid tall mature grass which most often dominates in the high standing mass patches. The exceptional rains in January were followed by a temporary greening of the herbaceous layer. The cattle adapted to this unusual situation by targeting patches where the young green plants were more dense and accessible, first visiting patches dominated by the fast growing dicotyledons and then these dominated by slower growing grasses. As the dry season progressed, patches with forage on offer became fewer. In May, more than 40% of the grazing orbit did not have any herbaceous cover. Hence, all areas with litter or standing grass attracted cattle although there was a significant bias towards higher yielding patches.

### **Selection of plant species**

The markedly higher digestibility and N concentration in selected feed than in forage on offer, whatever the season, demonstrates the high degree of dietary selectivity by livestock (Diallo, 1978; Schlecht et al, this volume). This selection of individual plants and plant organs involves different prehensive mechanisms specific to the animal species (Owen-Smith and Cooper, 1987) and is guided by the experience of the animal (Provenza and Balph, 1988). Palatability and plant material mass largely determine bite size and bite rate (Marten, 1978; Rath, 1993). Since only the dominant species in the bites were recorded, the estimations of the relative frequency of plant species in the diet are somewhat biased towards the more common and larger plant species. This could have contributed to shorten the list of species found in the diet (30); only three species (*Schoenefeldia gracilis*, *Zornia glochidiata* and *Tribulus terrestris*) made up 75% of all bites recorded (Table 5).

The species composition of the diet was not compared with the composition of forage offered each month, and a precise classification of the species into palatability classes such as 'preferred',

'secondarily preferred', 'proportionally selected' and 'avoided' (Stuth, nd) was not performed. Conclusions on the palatability status of some species have been drawn, however, from their frequency as dominant in bite counts. *Schoenefeldia gracilis*, an annual grass adapted to grazing because of its profuse tillering enhanced by defoliation (Hiernaux et al, 1994), was the most selected species (dominant in 56% of bites). Being the dominant species on sandy soils that cover 77% of the grazing orbit, *S. gracilis* should have contributed about half of the total herbaceous mass. The comparison of the frequency of the species in the bites with its contribution to forage mass would categorise *S. gracilis* as a 'proportionally selected' species. On average over the year, this categorisation could also apply to *Zornia glochidiata*, a small legume that dominated in 10.3% of total bite counts. However, *Z. glochidiata* distribution in the landscape is patchy, and its availability is highly seasonal. *Z. glochidiata* is probably 'preferred' at seedling stage, as indicated by its high scores in the diet following the unusual January rains (Table 5), and again after senescence despite the low standing mass offered by its defoliated stems (Guerin et al, 1988). *Tribulus terrestris*, *Ipomoea* spp and *Brachiaria* spp could all be classified among the 'preferred' species as their score in the bite counts was significantly higher than their possible contribution to forage mass. Most of the other forbs found in the diet, including plants often rated as unpalatable (*Borreria* spp, *Cassia tora*, *Achyranthes argentea*) could be categorised as 'secondarily preferred' species, although their small score in bite counts could be due to either incidental consumption of generally 'avoided' species, or a reflection of selection done at plant organ level such as for inflorescences of *Borreria* spp. The same categorisation would also apply to the five species of browse that occur in the diet. The interruption of browsing that followed the greening of the herbaceous layer in February confirms the 'secondary preference' of browse by cattle. Other species that contributed very little, or not at all, to the diet could be classified as 'avoided' species. Among the most commonly selected species are annual grasses such as *Diheteropogon hagerupii*, *Elionurus elegans*, *Andropogon pseudapricus*, *Loudetia togoensis* and *Pennisetum pedicellatum*. Legumes such as *Indigofera* and *Crotalaria* spp and other dicotyledons such as *Heliotropium* spp and *Monechma ciliatum* are also included. Among the avoided species only two, *Cienfuegosia digitata* and *Pancratium trianthum*, are known to be toxic to cattle. Both tend to spread in areas subject to heavy grazing during the wet season but they never dominate in the herb layer.

### Impact of cattle foraging on vegetation

In spite of the overall low selectivity by cattle for feeding stations among landscape units, local overgrazing remains a concern in a vegetation largely composed of annual plants whose production is directly affected by wet season grazing. Herbage production falls rapidly when the annual plants are repetitively defoliated during active growth. During the wet season, cattle tend to graze a few preferred species (Table 5) and lower mass herbage found in patches grazed earlier in the season. When grazing pressure is maintained throughout the season flowering and production of seeds by preferred species are impeded. This leads to rapid changes in the floristic composition of the range. These changes, however, are not systematically detrimental to forage production.

Decreasing preferred species are often replaced by shorter cycle annuals better adapted to frequent defoliation such as *Zornia glochidiata*, *Tribulus terrestris* and *Dactyloctenium aegyptiacum* (Djitéye, 1981; Turner, 1992). These annuals produce less herbage but it is of good nutritional quality and palatability although it remains green for a shorter period than longer cycle grasses. Less palatable and more productive species such as *Cassia tora*, *Acanthospermum hispidum* and *Chloris prierii*, may also be promoted when heavy grazing is associated with high manure deposition or more fertile soils. The encroachment of such plants entails a loss of fodder resources, but it only occurs in restricted areas where it is difficult to alleviate pressure such as proximity to water points, corral sites and transhumance paths. High production of less palatable forage could help in protecting the soil against erosion and replenishing soil organic matter in spots subjected to high stress. Seasonal changes in the preference for landscape unit, herbage mass and species distributes and diversifies the impact that livestock have on the vegetation and soil across the landscape (Hiernaux, 1992).

## Rangelands N and P harvesting by livestock

The second concern is the mining of nutrients from rangelands through grazing and its potential consequences on the long-term range productivity (Breman and Cissé, 1977). This concern is supported by the selection for high protein feed by livestock (Ketelaars and Tolkamp, 1991). Although N content in the forage on offer was not determined in this study, data for the same rangelands from Diallo (1978), Traoré (1978), Penning de Vries and Djitéye (1983) and Breman and de Ridder (1991), show average N concentrations in grasses of 2.0% in July/August, decreasing to 1.2% in September/October, and to 0.6% in May/June. Parallel to this decline, is a decrease in organic matter (OM) digestibility from 0.65% to 0.55%.

The diet of the monitored cattle ranged from 4.2% N (in OM) in July to 1.3% in May, averaging 3.37% N from August through October, and 1.72% from November through May (Schlecht et al, this volume, pp. ). The same authors measured N removal using monthly intake data of non-supplemented bulls. N removal rates were highest in August (2.91 g N/kg/W<sup>0.75</sup> per day and lowest in May (0.88 g N/kg/W<sup>0.75</sup> per day. From P to N ratios measured in grab samples, the correspondant extremes in P removal were 0.37 g in August and 0.11 g P/kgW<sup>0.75</sup> per day in May. From these intake data, it can be estimated that over the 100 days of the wet season grazing cattle ingested 15.8 kg of N and 2.3 kg P per TLU. During the dry season, grazing livestock may remove an additional 19.1 kg of N and 2.7 kg of P per TLU. Hence, annual removal of N and P are 34.9 and 5.0 kg per TLU, respectively. Given an average biomass yield of 1.2 t DM/ha containing 1.5% N and 0.125% P or 18 kg N and 1.5 kg P/ha, and maximum possible stocking density of 37.5 kg W/ha (15 TLU/km), maximum removal amounts to 5.2 kg N/ha (30% of N yield) and 0.75 kg P/ha (50% of P yield). Assuming a net annual weight gain of 30 kg per bull N and P retained by the animal could be estimated at 0.75 kg N and 0.24 kg P per bull and per year (ARC, 1980). This corresponds to retention in the animal of 134 g N/ha and 43 g P/ha per year.

Nutrient retention by cattle are larger in a reproductive herd when milk and offspring production are taken into account. Assuming 60% mature females in the herd, an average animal live weight of 180 kg and average annual weight gain of 15 kg per animal, calving rates of 0.75, calf weight of 20 kg and milk production of 750 kg per lactation (200 days), and considering concentrations of 25 g N/kg and 8 g P/kg adult body mass, 30 g N/kg and 8 g P/kg calf body mass, 6 g N/kg and 1 g P/kg milk mass (ARC, 1980), the nutrient retention in livestock amounts to 0.55 kg N/ha (about 10% of N removed) and 0.11 kg P/ha (about 15% of P removed). Moreover, assuming that 50% of the urine and faeces are deposited away from the range (corral and around water points) and, of the N returned to the range, 50% is lost to volatilisation, nutrient exports in situations of intense grazing amount to nearly 4 kg N/ha and 0.4 kg P/ha.

It appears that even in situations of intense grazing pressure, N and P exports remain lower or equivalent to the nutrient inputs through rainfall and dust deposit (about 3 kg N and 1 kg P/ha, Pieri, 1989; Herrmann et al, 1993), and nitrogen fixation by bacteria, rhizobia and algae (order of magnitude 1 to 3 kg N/ha, Penning de Vries and Djitéye, 1982). Even under heavy grazing, at least a third of the vegetal mass produced returns to the soil and decomposes, returning quantities of N and P that are comparable to maximum possible exports by livestock. This could explain why even a long history of high grazing pressure had no measurable impact on soil and plant uptake of N and only marginally increased soil and plant uptake of P (Turner, 1992).

These calculations suggest that the harvesting of nutrients by livestock grazing Sahelian rangelands has a limited impact on N and P cycling in rangeland. These processes might be more affected indirectly through the effects that grazing might have on soil and on vegetation structure and floristic composition than through direct consumption.



## Acknowledgements

This research was supported by the International Livestock Centre for Africa (ILCA) and implemented in Mali in collaboration with the Institut d'économie rurale (IER) and a research project of the University of Hohenheim. The authors wish to thank M. Touré and M.H. Maïga who contributed to the field work and M. D. Turner and S. Fernández-Rivera who kindly reviewed the manuscript.

## References

- ARC (Agriculture Research Council). 1980. *The nutrient requirements of ruminant livestock*. Commonwealth Agricultural Bureaux, Farnham Royal, Slough, UK. 351 pp.
- Boudet G. 1984. *Manuel sur les pâturages tropicaux et les cultures fourragères*. 4<sup>e</sup> ed. IEMVT (Institut d'élevage et de médecine vétérinaire des pays tropicaux), Maisons-Alfort, France. 266 pp.
- Boudet G and Leclercq P. 1970. *Etude agrostologique pour la création d'une station d'embouche dans la région de Niono*. Etude agrostologique 29. IEMVT (Institut d'élevage et de médecine vétérinaire des pays tropicaux), Maisons-Alfort, France. 268 pp.
- Breman H and Cissé A M. 1977. Dynamics of Sahelian pastures in relation to drought and grazing. *Oecologia* 28:301–315.
- Breman H and de Ridder N. 1991. *Manuel sur les pâturages des pays sahéliens*. Karthala/ACCT/CTA, Wageningen, The Netherlands. 485 pp.
- Casenave A and Valentin C. 1989. *Les états de surface de la zone sahélienne. Influence sur l'infiltration*. ORSTOM (Office de la recherche scientifique et technique d'outre-mer), Paris, France. 229 pp.
- Cissé A M. 1986. *Dynamique de la strate herbacée des pâturages de la zone sud-sahélienne*. CABO, Wageningen, The Netherlands. 211 pp.
- Coleman S W, Forbes T D A and Stuth J W. 1989. Measurement of the plant-animal interface in grazing research. In: Marten G C (ed), *Grazing research: Design, methodology and analysis*. Crop Science Society of America, Madison, Wisconsin, USA. pp. 37–49.
- Coppock D L. 1993. Vegetation and pastoral dynamics in the southern Ethiopian rangelands: Implication for theory and management. In: Behnke R H, Scoones I and Kerven C (eds), *Range ecology at disequilibrium: New models of natural variability and pastoral adaptation in African savannas*. ODI (Overseas Development Institute), London, UK. pp. 42–61.
- Coughenour M B, Coppock D L and Ellis J E. 1990. Herbaceous forage variability in an arid pastoral region of Kenya: Importance of topographic and rainfall gradients. *Journal of Arid Environments* 19:147–159.
- Cousins B. 1987. *A survey of current grazing schemes in the communal lands of Zimbabwe*. Center for Applied Social Sciences, University of Zimbabwe, Harare, Zimbabwe. 96 pp.
- Dagnelie P. 1975. *Théorie et méthodes statistiques: Applications agronomiques*. Second edition. Vol 2. Les presses agronomiques de Gembloux, Belgique. 463 pp.
- Diallo A. 1978. *Transhumance, comportement productivité d'un troupeau zébu de Diafarabé*. Thèse, CPS, Bamako, Mali. 75 pp.
- Diarra L. 1983. *Production et gestion des parcours sahéliens: synthèse de cinq années de recherches au ranch de Niono*. DP AZ 94. CIPEA (Centre international pour l'élevage en Afrique), Bamako, Mali. 83 pp.
- Diarra L and Coulibaly Y. 1990. *Quantification de l'environnement nutritionnel des troupeaux dans différents terroirs de la zone péri-urbaine de Bamako d'octobre 1988 à octobre 1989*. Document de travail. CIPEA (Centre international pour l'élevage en Afrique), Bamako, Mali. 35 pp.
- Dicko M S and Sangaré M. 1986 Feeding behaviour of domestic ruminants in Sahelian zone. In: Joss P J (ed), *Rangeland: A resource under siege*. Proceedings of the 2<sup>nd</sup> International Rangeland Congress, Adelaïde. Australian Academy of Science, Canberra, Australia. pp. 388–390.
- Djitèye M A. 1981. *Influence de l'exploitation sur un pâturage sahélien à Annuelles (Niono, Mali)* 4. Mémoire de D.E.A. Ecol. vég., Univ. Paris-sud, Orsay, France. 49 pp.

- Djitéye M A. 1984. *Composition, structure et production des communautés végétales sahéliennes: Application à la zone de Niono (Mali)*. Thèse doc., Université Paris-sud, Orsay, France. 150 pp.
- Forbes T D A. 1988. Researching the plant-animal interface: The investigation of ingestive behavior in grazing animals. *Journal of Animal Science* 66:2369–2379.
- Grouzis M. 1988. *Structure, productivité et dynamique des systèmes écologiques sahéliens (Mare d'Oursi, Burkina Faso)*. Coll Etudes et Thèses. ORSTOM (Office de la recherche scientifique et technique d'outre-mer), Paris, France. 336 pp.
- Guerin H, Friot D, Mbaye N, Richard D and Dieng A. 1988. Régime alimentaire de ruminants domestiques (bovins, ovins, caprins) exploitant des parcours naturels sahéliens et soudano-sahéliens. II. Essai de description du comportement alimentaire. Facteurs de variation des choix alimentaires et conséquences nutritionnelles. *Revue d'élevage et de médecine vétérinaire des pays tropicaux* 41(4):427–440.
- Herrmann L, Bleich K E and Stahr K. 1993. Influence des dépôts éoliens sur la restauration de la fertilité des sols sous végétation en friche au Niger, Afrique de l'Ouest. *Bulletin Réseau Erosion* 14. Orstom/Cnrs, Montpellier.
- Hiernaux P. 1985. *Encore une saison des pluies très déficitaire sur le ranch de Niono (sud Sahel, Mali)*. *Evolution de la végétation d'une cinquantaine de sites suivi depuis 1976*. DP AZ 141. CIPEA (Centre international pour l'élevage en Afrique), Bamako, Mali. 74 pp.
- Hiernaux P. 1989a. *Note sur l'évolution de la biomasse des pailles au cours de la saison sèche*. ILCA, Document Trav. 2/89, Bamako, Mali. 12 pp.
- Hiernaux P. 1989b. Le suivi des ressources pastorales et de leur gestion en regard des productions animales qu'elles engendrent au Sahel. Approche méthodologique. (Atelier sur le suivi des ressources pastorales au Sahel, Niamey), CIPEA (Centre international pour l'élevage en Afrique), Bamako, Mali. 50 pp.
- Hiernaux P. 1992. Sustainability of Sahelian pastoralism: The quantification of the impact of livestock production on the Sahelian range resources renewal. (Presented at the conference on Ecology-economy interactions in Sahel, SUM, Oslo University).
- Hiernaux P and Haywood M. 1978. *La carte de végétation et des pâturages du ranch de Niono au 1/25000*. CIPEA (Centre international pour l'élevage en Afrique), Bamako, Mali. 11 pp.
- Hiernaux P, Diarra L and Cissé M I. 1983. Les ressources végétales et leur productivité. In: Wilson R T, de Leeuw P N and de Haan C (eds), *Recherches sur les systèmes des zones arides du Mali: résultats préliminaires*. CIPEA Rapport de recherche 5. CIPEA (Centre international pour l'élevage en Afrique), Addis Ababa, Ethiopia. pp. 28–46.
- Hiernaux P, Diarra L and de Leeuw P N. 1994. Modelling tillering of annual grasses as a function of plant density: Application to Sahelian rangelands productivity and dynamics. *Agricultural Systems* 46:121–139.
- Ketelaars J J M H and Tolkamp B J. 1991. *Toward a new theory of feed intake regulation in ruminants*. PhD thesis, Landbouw Universiteit, Wageningen, The Netherlands. 254 pp.
- de Leeuw P N and Tohill J C. 1991. The concept of rangeland carrying capacity in sub-Saharan Africa — Myth or reality? In: Behnke R H (ed), *Range ecology at disequilibrium*. IIED (International Institute for Environment and Development), London, UK. pp. 77–88.
- de Leeuw P N, Diarra L and Hiernaux P. 1991. An analysis of feed demand and supply for pastoral livestock: The Gourma region of Mali. In: Behnke R H (ed), *Range ecology at disequilibrium*. IIED (International Institute for Environment and Development), London, UK. pp. 136–152.
- Mahler F. 1990. Potential of natural pasture and locally available supplements in ruminant nutrition in a semi-arid location in West Africa. In: von Oppen M (ed), *Standortgemeasse landwirtschaft in westafrika*. Universitaet Hohenheim, arbeits und ergebnisbericht 1988–90: 159–182.
- Maïga M H. 1992. Evaluation fourragère et étude du comportement du bétail à la pâture au Mali. Parcours naturels de Bancoumana, Falan et Niono. Mem. DEA, ISFRA, Bamako, Mali. 40 pp.
- Marten G C. 1978. The animal–plant complex in forage palatability phenomena. *Journal of Animal Science* 46(5):1470–1477.
- McNaughton S J, Wallace L and Coughenour M B. 1983. Plant adaptation in an ecosystem context: Effect of defoliation, nitrogen, and water on growth of an African C4 sedge. *Ecology* 64(2):307–318.

- Owen-Smith N and Cooper S. 1987. Palatability of woody plants to browsing ruminants in a South African savanna. *Ecology* 68:319–331.
- Penning de Vries F W T and Djitéye M A. 1982. *La productivité des pâturages sahéliens*. Pudoc, Wageningen, The Netherlands. 525 pp.
- Pieri C. 1989. *Fertilité des terres de savanes*. Bilan de trente an de recherche et de développement agricoles au sud du Sahara. CIRAD-IRAT, Montpellier, France. 444 pp.
- Provenza F D and Balph D F. 1988. Development of dietary choice in livestock on rangelands and its implications for management. *Journal of Animal Science* 66:2356–2368.
- Rath T. 1993. Estimation de l'ingestion fourragère par les bovins sur un pâturage en site semi-aride. Comparaison des méthodes. Univ. Hohenheim, Inst. Prod. Anim. Pays Trop. et Subtrop., Stuttgart, Germany. 24 pp.
- Richard D, Guerin H, Roberge G and Friot D. 1989. La consommation de matière sèche de fourrages disponibles en zone tropicale. Proc. 16<sup>e</sup> Cong. Int. des Herbages, Nice, France. 11 pp.
- Scoones I. 1989. *Patch use by cattle in dryland Zimbabwe: Farmer knowledge and ecological theory*. Pastoral Development Network Paper 28b. ODI (Overseas Development Institute), London, UK.
- Stuth J W. nd. *Foraging behavior*. 36 pp. (draft).
- Traoré G. 1978. Evolution de la disponibilité et de la qualité de fourrage au cours de la transhumance de Diafarabé. Thèse doc., CPS, Bamako, Mali. 87 pp.
- Turner M D. 1992. *Life on the margin: Fulbé herding practices and the relationship between economy and ecology in the inland delta of Mali*. PhD thesis, University of California, Berkeley, California, USA. 469 pp.
- Vetaas O R. 1992. *The interaction between biotic and abiotic factors controlling temporal and spatial dynamics of arid vegetation in Erkowit, north-eastern Sudan*. PhD thesis, Bergen University, Norway. 30 pp.

# Feeding livestock for compost production: A strategy for sustainable upland agriculture on Java

*J.C. Tanner,<sup>1</sup> S.J. Holden,<sup>2</sup> M. Winugroho,<sup>2</sup> E. Owen<sup>3</sup> and M. Gill<sup>4</sup>*

1. Cwm Mawr, Hyssington, Montgomery, Powys SY15 6DZ, UK

2. ODA Animal Health Project, c/o FCO (Jakarta), King Charles Street, London SW1A 2AH, UK

3. Department of Agriculture, University of Reading, Earley Gate, P O Box 236, Reading RG6 2AT, UK

4. Livestock Section, Natural Resources Institute, Chatham Maritime, Chatham, Kent ME4 4TB, UK

## Abstract

Ruminant livestock are an integral part of smallholder farming systems in Indonesia. However, the extent and continuous nature of cropping on densely populated islands such as Java leaves very little land suitable for grazing. The majority of livestock are therefore permanently housed in backyards and fed indigenous forages cut from field margins and roadsides. Cut-and-carry feeding is labour-intensive and the supply of forage is often the most expensive input to ruminant production. Surprisingly, farmers collect quantities of forage greatly in excess of the requirements of their livestock. In an experiment, indigenous forage dominated by *Axonopus compressus*, was fed to sheep at increasing rates: 25, 50 or 75 g DM/kg live weight (W) per day. The results showed that although DM intake and liveweight gain rose with increasing offer rate, the incremental improvements from 50 to 75 were non-significant ( $P < 0.05$ ) and less than from 25 to 50. It is unlikely that farmers justify their excess-feeding strategies on the basis of these marginal gains in animal productivity alone. The rationale for excess feeding may lie in manure-compost production. Farmers collect uneaten feed in pits beneath their animal barns. The uneaten feed combines with faeces and urine falling through the slatted floors to produce manure-compost. In the above experiment, the quantity of manure-compost made from refused forage mixed with sheep excreta increased markedly as the forage offer rate rose. It is possible that farmers adjust their feeding rates to optimise total output, i.e. including manure-compost, as opposed to animal production *per se*. Manure-compost is ranked by farmers as one of the most important outputs from livestock production. In the upland regions of Java, 90% of the fertiliser used on smallholdings is manure-compost. It is hypothesised that livestock are used to produce high-quality compost and that their integration into Javanese agriculture is essential to the sustainability of some of the most intensive cropping cycles in the world.

## Alimentation du bétail en vue de la production de compost: une stratégie destinée à promouvoir une agriculture viable en altitude à Java

*J.C. Tanner<sup>1</sup>, S.J. Holden<sup>2</sup>, M. Winugroho<sup>2</sup>, E. Owen<sup>3</sup> et M. Gill<sup>4</sup>*

1. Cwm Mawr, Hyssington, Montgomery, Powys SY15 6DZ (R.-U.)

2. ODA Animal Health Project, c/o FCO (Jakarta), King Charles Street, Londres SW1A 2AH (R.-U.)

3. Department of Agriculture, University of Reading, Earley Gate  
P.O. Box 236, Reading RG6 2AT (R.-U.)

4. Livestock Section, Natural Resources Institute, Chatham Maritime  
Chatham, Kent ME4 4TB (R.-U.)

## Résumé

*L'élevage de ruminants fait partie intégrante du système de la petite exploitation agricole en Indonésie. Toutefois, compte tenu de l'importance et du caractère continu de l'agriculture à Java, une île à très forte densité de population, il ne reste que très peu de terres adaptées aux pâturages. La plupart des animaux sont en permanence parqués derrière les cases et alimentés avec du fourrage provenant des bordures des champs et des routes. L'alimentation à l'auge étant une opération à forte intensité de travail, l'affouragement est généralement l'intrant le plus coûteux de la production animale dans cette région. Et pourtant, les éleveurs amassent d'importantes quantités de fourrage, excédant de loin les besoins de leurs animaux. Au cours d'un essai, des quantités croissantes (25, 50 ou 75 g de MS/kg de PV/j) de fourrage local constitué principalement d'*Axonopus compressus* ont été distribuées à des moutons. Les résultats montrent que bien que la consommation de MS et les gains de poids augmentent avec les quantités de fourrage ingérées, ces augmentations n'étaient pas significatives entre 50 et 75 g de MS/kg de PV/j ( $P < 0,05$ ) et étaient plus faibles que celles obtenues entre 25 et 50 g de MS/kg de PV/j. Il est peu probable que ces améliorations marginales de productivité justifient la stratégie d'alimentation excédentaire adoptée par les éleveurs. Celle-ci pourrait par contre s'expliquer par la production de fumier-compost. En effet, les paysans recueillent les refus dans des fosses situées sous les étables. Ces refus, mélangés aux fèces et à l'urine passant entre les lattes du plancher, produisent du fumier-compost. Dans cette expérience, la quantité de fumier-compost obtenue à partir des refus et des déjections des moutons augmentait sensiblement avec l'accroissement de la quantité de fourrage proposée. Il est possible que les éleveurs ajustent les quantités de fourrage pour optimiser la production totale, c'est-à-dire fumier-compost inclus, et pas seulement la production des animaux. Celui-ci est considéré comme l'un des produits les plus importants de l'élevage. Dans les régions montagneuses de Java, le fumier-compost représente 90% des engrais utilisés dans les petites exploitations. Il semble donc que les animaux d'élevage sont utilisés pour produire du compost de qualité. Leur intégration dans l'agriculture javanaise est vitale pour la durabilité de certains des systèmes agricoles les plus intensifs du monde.*

## Introduction

Although Java represents only 7% of the total land area of Indonesia it supports 60% of the country's population (180 million people). Half of Java's population are farmers (Biro Pusat Statistik, 1991) who cultivate small plots of land up to 0.5 ha in size (Booth, 1988). Cropping is continuous. Java is thus not only one of the most densely populated areas of the world with 814 persons/km<sup>2</sup>, but also one of the most intensively cultivated.

Ruminant livestock are an integral part of the farming system. However, intensive cultivation on Java leaves little land for grazing. The majority of animals are therefore permanently housed in backyards and fed indigenous grasses and sedges. Fodder is hand-cut each day from roadsides and field margins by the farmer and carried back to the homestead. Forage collection is labour intensive. For example, it has been estimated that sheep farmers spend between 0.8 (Amir et al, 1985) and 2.3 (Thahar and Petheram, 1983) hours/head per day just to supply their animals with fodder. The high labour inputs that are required to supply forage makes it the most expensive cost to small ruminant production.

Surprisingly, farmers collect large quantities of grass, often greatly in excess of the appetites of their livestock (Mathius and van Eys, 1983; Ludgate, 1989; Lowry et al, 1992; Wahyuni et al, 1993). Offer rates for sheep and goats have been estimated at between 50 and 60 g dry matter (DM)/kg live weight (W).day (d) (van Eys et al, 1984; Johnson and Djajanegara, 1989). A large proportion of the grass on offer is rejected by the animals. Some studies suggest that as much as 400 g/kg DM offered may be refused (Little et al, 1988; Subagio, 1991).

Despite high levels of feeding, the productivity of small ruminants under village conditions is considered low (Johnson and Djajanegara, 1989). This would imply that there were limited advantages

to high levels of feeding under these village conditions. However, several authors have observed that the refused feeds associated with 'excess feeding' are composted with animal manure for subsequent use on surrounding fields (Palte, 1989; Sabrani et al, 1989). Manure-composts are an important output of the livestock system (van Eys et al, 1984; Ludgate, 1989; Levine, 1990). High levels of feeding might thus be employed to optimise both manure-compost production and animal productivity as opposed to animal production *per se*.

This paper covers two trials. The first was a feeding trial that quantified the relationship between forage offer rate, intake and animal growth, forage refusal rate and manure-compost production. The second experiment evaluated the quality of the manure-composts produced as fertiliser for maize. The economic optimum level of feeding was determined for this system in which manure-compost and animal production are both valued as outputs.

## Experiment I: Effect of quantity of forage offered to sheep on intake and growth, and on compost made from uneaten feed and excreta

### Materials and methods

Both trials were conducted at the Research Institute for Animal Production, Ciawi, West Java (6°40'S 106°55'E). The institute is located in an upland site at an altitude of 500 m. The daily range in ambient temperature is 20–31°C with little seasonal variation. The climate is wet monsoonal with an annual rainfall of about 3600 mm. Only three months of the year receive less than 200 mm of rain.

Thirty Javanese thin-tailed rams (aged 18 months, mean initial live weight 29.1 kg, s.e. 0.3) were blocked according to initial live weight (W) and then randomly allocated to one of three forage offer rates: 25, 50 or 75 g dry matter (DM)/kg W.d. The forage offer rates were selected to cover the range measured on-farm by van Eys et al (1984).

Indigenous forage was hand-cut each morning in the vicinity of the animal house where the trial was conducted. A 2.5 kg sample of the forage on offer was taken each day to determine species composition. Table 1 shows the average proportions of forage species on offer over the last 34 days of the trial. These forage species were similar to those identified as being fed to stock on farms in the area (Little et al, 1988). The forage offered had concentrations of 185 g DM/kg, s.e. 26; 155 g ash/kg DM, s.e. 8.5 and 20.4 g N/kg DM, s.e. 1.4.

**Table 1.** Average species composition of the forage offered each day during the feeding trial ( $n = 34$  days).

Forage genus/species	Mean % in daily forage ration (fresh-weight basis)	
	%	sd
Grasses: <i>Axonopus compressus</i> / <i>Paspalum conjugatum</i>	28.8	17.92
<i>Eleusine indica</i>	7.1	10.16
<i>Digitaria</i> spp	8.3	9.20
<i>Brachiaria</i> spp	5.2	7.03
<i>Setaria palmifolia</i>	2.9	6.33
<i>Paspalum scrobiculatum</i>	2.7	5.92
<i>Cynodon dactylon</i>	2.4	6.01
<i>Ischaemum timorense</i>	2.4	8.01
<i>Sporobolus</i> spp	0.4	1.34
Other grass species	3.8	4.84
Sedges: <i>Kyllinga monocephala</i> / <i>Cyperus</i> spp	5.8	8.99
Broad-leaved plants	15.5	7.94
Grass fragments	7.2	6.97
Dead plant material	7.6	3.23

The rams were individually penned and fed half of their daily forage ration at 0800 and the remaining half at 1200. Refused forage was collected and weighed each morning at 0700. Intake was recorded on a daily basis and representative samples of forage offered and refused were taken for DM, ash and N analysis. The trial lasted a total of 70 days. From day 5 to 25, faeces were collected from three rams per treatment to measure digestibility. Rams were weighed each week following a 12-hour fast. Water and salt (NaCl) blocks were available throughout the experiment.

Refused forage, faeces and urine were collected each morning from three rams per treatment penned individually in metabolism crates. The crates were fitted with excreta separators which directed faeces and urine into different containers positioned under each crate. Immediately after weighing, the uneaten forage was bulked by treatment, mixed with the faeces and urine voided by each treatment group over the previous 24-hour period and then placed in slat-sided bins measuring 1.5 m x 1.5 m x 1.0 m. Uneaten forage and excreta were collected in this manner over 50 days and composted in the bins for a further 50 days. The compost was turned every three days to assist aeration. Following the composting period the compost was sacked-up for weighing and samples were taken for analysis of N, phosphorus (P), potassium (K) and organic carbon (C).

## Results

Table 2 shows that DM intake of forage and growth rate of sheep increased with offer rate but the incremental improvement for 50 to 75 g/kg W.d was not significant ( $P>0.05$ ) and less than that observed from 25 to 50 g DM/ kg W.d. The quantity of grass refused increased from 109 g DM/kg DM offered at the lower feeding rate to 526 g DM/kg DM offered at the highest feeding rate. Forage digestible organic-matter contents improved with increasing offer rates and the forage refused contained less nitrogen and more ash than the forage offered. It was calculated that the N content of the forage actually consumed (i.e. selected) improved from 21.2 to 22.5 and 23.8 g/kg DM as offer rate increased.

**Table 2.** *Cut-and-carry feeding for Javanese Thin-tailed sheep: Effect of increasing forage offer rate on intake, diet selection, animal growth and manure-compost yield.*

Quantity of forage offered (g DM/kg W.d)	25	50	75	s.e.d.
Number of rams	10	10	10	
Initial live weight (W) (kg)	29.2	29.1	28.9	0.33
Growth rate (g/d)	-16.5	25.8	28.5	4.73
<b>Intake</b>				
Forage offered (g/d)	3627	7772	11616	
Forage offered (g DM/d)	671	1438	2149	
Forage refused (g DM/kg DM offered)	109	359	526	
Forage intake (g DM/d)	598	922	1019	
Forage intake (g DM/kg W.d)	22.1	31.7	34.9	1.16
Estimated intake of digestible forage organic matter (g DOM/kg W.d)	11.8	19.0	21.7	
Forage quality	<u>Forage offered</u>		<u>Forage refused</u>	
	Mean	s.e.		
DM (g/kg)	185	26	375	8.9
Nitrogen (g/kg DM)	20.4	1.4	14.0	0.5
Ash (g/kg DM)	155	8.5	257	11.4
Manure-compost yield (g/sheep/day)	540	1620	2320	

As expected, compost yield increased with increasing forage offer rate. Table 3 shows that the contents of N, P, K and organic C also showed slight improvements with increasing offer rate. After composting for 50 days the compost produced from the lowest offer rate contained faecal material still in pelleted form, however, composts produced from the higher offer rates were structureless and more humus-like in appearance.

**Table 3.** Estimated costs of production (Rp<sup>1</sup>/sheep/day), value of outputs (Rp/sheep/day) and returns to labour (Rp/hour) when feeding indigenous forage to rams at 25, 50 or 75 g DM/kg W.d.

Offer rate	Costs <sup>2</sup>		Outputs		Returns to labour	
	Labour <sup>2</sup> (hrs)	Other <sup>3</sup> (Rp/day)	Compost <sup>4</sup> (Rp/day)	Weight <sup>5</sup> (Rp/day)	Including compost (Rp/hour)	Excluding compost (Rp/hour)
(25g)	0.42	18.6	18	-50	-120	-163
(50g)	0.83	18.6	54	77	135	70
(75g)	1.20	18.6	77	86	120	56

1. 1 US\$ = Indonesian Rupiah (Rp) 2110.

2. The lowest cost of forage input corresponds to the lowest forage offer rate (25 g DM/kg W. d) and the highest forage offer rate (75 g DM/kg W.d), assuming it takes 5.9 minutes to cut 1 kg of grass (derived from van Eys et al, 1984 and Amir et al, 1985).

3. Non-labour costs, in decreasing order of magnitude, include depreciation on the sheep barn, minerals, anthelmintic treatments and miscellaneous expenses on ropes etc.

4. On average, a 30-kg sack of manure-compost fetches Rp 1000 (Holden et al, 1993), equivalent to Rp 0.033/g.

5. Assuming a sale price of Rp 3000 per kg live weight (or Rp 3/g) (Biro Pusat Statistik, 1991).

### Determining the economic optimum offer rate

Liveweight gain and manure-compost production were greatest at the highest feeding rates (Figure 1). However, these gains must be offset against the extra time required to supply the feed. The most profitable ration would be that which yields the highest returns to labour inputs. In this instance 'returns' are defined as the difference between the value of outputs namely, liveweight gain and manure-compost, and the value of non-labour inputs such as drugs, mineral supplements, depreciation on the animal barn and miscellaneous expenses on items like buckets and ropes. This can be expressed in the following equation:

$$\text{Returns to labour} = \frac{(\text{Value of outputs}) - (\text{Non labour costs})}{\text{Hours labour}}$$

Returns to labour can be thought of as the 'wage' family labour 'earns' from the sheep enterprise.

Data from studies elsewhere in Indonesia (Kartamulia et al, 1993) are used to estimate the costs associated with fattening rams (Table 3). These costs are derived from farms that treat their sheep regularly with anthelmintics and thus best mimic on-station experimental conditions. Labour inputs include a component for watering the animals and cleaning the barn. Manure-compost and the liveweight gain associated with each level of feeding are valued using farm gate prices. The purchase and sale price of rams on a per kg liveweight basis is assumed to remain constant. Returns to labour are calculated for (i) the combined value of manure-compost and liveweight gain and (ii) the value of liveweight gain only. The effect of manure-compost production on returns to family labour can thus be examined.

Table 4 shows that the most profitable offer rate, i.e. the one that yields the highest returns to family labour was 50 g DM/kg W.d irrespective of whether manure-compost is included as an output. The lowest level of feeding would appear to be unprofitable: the costs of production alone (excluding labour inputs) outweigh the value of growth and compost-manure production. Although feeding at the highest offer-rate yielded a positive return to labour invested in animal production, the computed

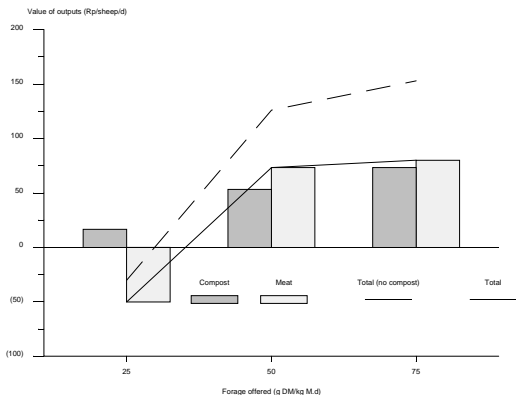

**Figure 1.** Relationship between forage offer rate and value of compost and live weight.

'hourly wage rate' was 11% less than that obtained from feeding at 50 g DM/kg W.d where compost is included in the output value, and 25% less where compost is excluded from outputs.

Returns to labour are lower if compost production is excluded from the value of outputs. At 25, 50 and 75 g DM/kg W.d offer-rates, returns to labour are, respectively, 36%, 40% and 53% less than returns to labour if manure-compost is included as an output. At the most profitable offer-rate of the three levels studied, i.e. 50 g DM/kg W.d, the production of manure-compost increased the returns to labour by 93% from Rupiah (Rp) 70/hour (without manure-compost) to Rp 135/hour (with manure-compost).

**Table 4.** The chemical properties of the manure-composts produced from the feeding trial and a compost made from plant material only (vegetable-compost).

Type of compost	Manure-compost			Vegetable-compost
	25 <sup>1</sup>	50	75	
Nitrogen (g/kg DM)	17.6 <sup>2</sup>	18.2	19.4	14.8
Organic carbon (g/kg DM)	240.6	245.7	255.7	213.5
P <sub>2</sub> O <sub>5</sub> (g/kg DM)	6.2	6.7	7.2	3.9
K <sub>2</sub> O (g/kg DM)	32.4	36.8	42.3	0.5

1. Manure-composts 25, 50 and 75 were produced by composting faeces, urine and uneaten forage from sheep offered forage at either 25, 50 or 75 g DM/kg W.d, respectively.

2. All results produced from the analysis of one sample per compost type only.

The results of the mineral contents of the manure-composts are based on a small sample taken from each compost. An agronomic trial was therefore conducted to evaluate the effect of offer rate on the

overall quality of the manure-composts. The composts were used to fertilise maize grown on an upland soil and compared with similar application of inorganic fertiliser and compost made from plant material only (vegetable-compost).

## Experiment II: Inorganic fertiliser, manure-composts and compost made from plant material only as fertiliser for maize grown on upland soil

### Materials and methods

The trial featured five fertiliser treatments: three manure-composts, a vegetable-compost and inorganic fertiliser (NPK). The three manure-composts were produced from the feeding trial described above. Manure-compost 25, manure-compost 50 and manure-compost 75 were produced as a result of mixing excreta and refused forage from sheep offered indigenous forage at 25, 50 or 75 g DM/kg W.d. The vegetable-compost was produced by composting plant material only. Although containing grasses similar to those fed to the sheep during the trial, the vegetable-compost also contained other plant material such as rice straw.

The composts and local upland topsoil, Andosol, (Horne, 1988) were sieved individually through a 1 cm x 1 cm screen. The four types of compost were then added to the soil at the rate of 0 (control), 20 or 50% by volume. After mixing thoroughly, the compost-soil mixtures were placed in free-draining plastic pots (total volume 7.7 litres, top diameter 0.3 m). The chemical properties of the soil were as follows: pH 4.8, 18.1 g organic C/kg DM, 1.9 g N/kg DM, 0.2 g K<sub>2</sub>O/kg DM, P<sub>2</sub>O<sub>5</sub> 1.4 ppm (Bray-1) and cation exchange capacity 4.66 meq/100 g.

The 20% and 50% compost application rates were estimated to provide, on average, 3.56 g N/pot (sd 0.79 g N) and 9.20 g N/pot (sd 2.65 g N), respectively. The inorganic fertiliser doses were calculated so that the urea provided equivalent quantities of N. Thus, urea (containing 46% N) was applied at 7.74 g or 20.0 g/pot. In accordance with the seed producers' recommendation, the total urea dose was split into three application times; at planting, 21 days and 42 days post-emergence. Therefore, at each of these times either 2.58 g or 6.66 g urea was added to the pots. Triple super phosphate (TSP) and potassium chloride (KCl) were applied to the NPK pots at planting time only in the ratio 2:2:1 (urea : TSP : KCl). In order to relate to the upper and lower compost application rates the equivalent inorganic fertiliser rates will be referred to as "NPK 50" and "NPK 20" treatments, respectively.

The maize used in the trial was a hybrid of varieties F 3228 and M 3228. Three seeds were planted per pot and the pots placed in a greenhouse. The seedlings were visually assessed at three days after emergence and the two weakest were removed. Two litres of water were provided per pot each day of the trial and the pots were allowed to drain freely.

A randomised block design was used with five fertiliser treatments (compost 25, compost 50, compost 75, vegetable compost and NPK), three fertiliser application rates (0% [control], 20% or 50% compost by volume [or calculated NPK equivalent]) and three blocks in which each fertiliser treatment was replicated five times (total of 225 pots).

Thirty-two days after emergence two plants per treatment in each block were destructively sampled. The height of the plant from soil level to the top node was measured and then the plant was cut at soil level, oven-dried at 85°C for 48 hours and then weighed. The remaining plants (three plants/treatment/block) were harvested at 60 days post-emergence when the same measurements were made.

### Results

At the time of writing, statistical analysis had not been carried out. However, Table 5 and Figure 2 reveal some clear trends. Maize plants fertilised with manure-composts out-performed those receiving vegetable-compost or NPK at both levels of application and throughout growth. The most noticeable response was the dramatic improvement in plant height and dry weight caused by increasing the application rate of all three manure-composts from 0 to 20%. Increasing manure-compost application

from 20% to 50% showed marginal improvements in plant height but there were large gains in plant dry-weight at 60 days. Application of NPK or vegetable-compost produced small improvements in plant growth and the response to increasing application rate was minimal at both stages of growth.

**Table 5.** *The effect of fertiliser type and application rate on the mean dry weight and mean height of maize plants after 32 and 60 days of growth.*

Compost type	Application rate (%)	Growth period			
		32 days		60 days	
		Dry weight g [n=6]	Height cm [n=6]	Dry weight g [n=9]	Height cm [n=9]
Compost 25	0	0.7 (0.29)*	10.8 (3.71)	2.0 (1.30)	15.7
	20	14.6 (1.80)	40.7 (5.85)	73.6 (7.59)	192.7
	50	15.8 (2.23)	46.3 (4.23)	153.3 (46.7)	199.9 (14.98)
Compost 50	0	0.5 (0.26)	8.6 (2.57)	2.9 (3.12)	18.3 (8.44)
	20	10.3 (1.84)	37.3 (3.32)	57.5 (10.97)	172.0 (11.94)
	50	12.8 (2.11)	38.9 (6.71)	132.2 (56.26)	199.4 (10.50)
Compost 75	0	0.5 (0.12)	8.7 (0.99)	1.7 (0.29)	15.1 (3.73)
	20	10.8 (1.28)	34.6 (2.92)	62.4 (21.1)	174.9 (12.73)
	50	12.4 (1.98)	39.5 (3.10)	101.5 (35.82)	183.0 (20.52)
Vegetable compost	0	0.5 (0.28)	9.0 (3.13)	4.5 (5.54)	18.6 (10.27)
	20	1.05 (0.4)	14.3 (4.5)	10.0 (1.97)	37.6 (9.22)
	50	2.3 (0.18)	20.5 (1.14)	28.3 (3.93)	77.3 (14.75)
NPK	0	0.5 (0.12)	8.4 (1.59)	2.1 (0.59)	17.4 (4.6)
	20	1.5 (1.91)	11.9 (5.19)	29.1 (23.18)	82.2 (55.9)
	50	4.8 (3.62)	20.5 (9.0)	34.0 (27.2)	78.1 (52.52)

\* Means followed by standard deviations in brackets.

After 32 days' growth maize plants receiving manure-compost 25 at both the 20% and 50% application rates were heavier and taller than those fertilised with manure-composts 50 and 75. At this early stage of growth manure-composts 50 and 75 produced similar plant response.

At 60 days the plants fertilised at the 20% rate with manure-compost 25 were slightly taller than those receiving manure-composts 50 or 75. Increasing the application rate to 50% resulted in very little further response in plant height. Plants fertilised with manure-compost 25 at the 20% application rate had lost some of their dry-weight advantage observed over the other manure-composts at 32 days' growth. Raising the application rate to 50% did, however, give a pronounced increase in plant dry weight for all manure-compost treatments.

The control plants remained stunted throughout the trial although no plant parasites or symptoms of disease were observed. Whatever adverse soil conditions existed these were not ameliorated by application of NPK or vegetable-compost. The NPK application rates used in this experiment exceed those advised by the local supplier of maize seed and therefore it might be suggested that a deficiency in these macro-nutrients was not the main reason for the stunted growth. Application of the vegetable-compost, whilst possibly improving the physical condition of the soil, lacked the nutrient content of the manure-composts (Table 3).

**Figure 2.** The effect of fertiliser type and application rate on dry weight and height of maize plants after 32 and 60 days of growth.

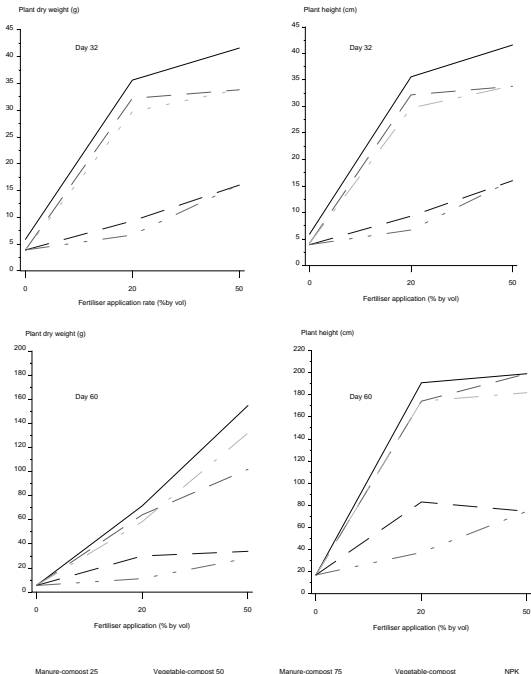

## Discussion

Historically, Java has been one of the most populous areas of the world. However, Raffles (1817) noted that settlements were concentrated only on the fertile lowlands whereas the uplands remained unpopulated. The uplands contain the Ultisol and Oxisol soil orders (Perkins et al, 1986) which are generally of low fertility, exhibit deficiencies in plant nutrients and have poor physical structure (KEPAS, 1985). Furthermore, the topography and heavy rainfall in the uplands can lead to serious erosion problems once these soils are cleared for agricultural use. Cultivators have thus traditionally avoided these areas. However, during the early 19th century, rapidly growing population pressure on Java forced farmers to move into more marginal regions (Palte, 1989).

In the 1870's, the colonial government predicted widespread soil erosion, declining crop yields and eventual degradation (Pelzer, 1945). Despite such gloomy prophecies, over 100 years later, upland areas represent 42% of the land used for annual crop production (RePPProT, 1990) and support an average population density of around 600 persons/km<sup>2</sup> (Palte, 1989). Farmers seem therefore to have mitigated some of the worst consequences of continuous cropping on these marginal soils.

Palte (1989) suggests a key factor that contributed to the successful colonisation of the uplands was the attention to soil fertility which enabled sequential planting of dry-land crops. It has only been acknowledged comparatively recently that Javanese farmers have well-defined soil management strategies for dry-land cultivation (Colfer, 1991). Farmers produce large quantities of organic fertiliser, in particular manure-based composts, which are incorporated into the soil: around 90% (by weight) of the fertiliser used on these farms is in the form of organic fertiliser (Palte, 1989; Sabrani et al, 1989). A variety of manure-composts are produced to suit particular soil and crop types, and manure-compost applications are often integrated into an overall soil nutrient management strategy that includes application of inorganic fertilisers (Holden et al, 1993).

Figure 2 and Table 5 suggest that manure-composts support higher crop production compared to inorganic fertilisers when applied to maize grown in an upland soil. Manure-composts are not only rich in organic matter but may also represent a balanced source of readily available plant nutrients (Parnes, 1990). The improved response of the maize plants to manure-compost application was possibly a direct result of higher organic matter. However, the quality of organic fertiliser is also important. The addition of vegetable-compost gave poor plant response perhaps because this compost had a lower nutrient content compared to the manure-composts (Table 3). Livestock excreta would thus appear to be a vital ingredient of organic fertilisers used on poor quality soils.

Livestock ownership in these areas is argued by Palte (1989) to be a reflection of the significance of manure-compost to the sustainability of crop production. Yet livestock do not usually readily co-exist with continuous cropping: the lack of grazing and risk to crops typically necessitates housing and manual feeding of animals (Grigg, 1974; Spedding, 1979). Such systems can have higher costs compared to grazing and are not usually economically viable (Jahnke, 1982). However, in the uplands of Java there exists a somewhat unusual situation where ruminant livestock production has effectively integrated into intensive cropping. We would argue that this is possible because farmers have devised a system for rearing livestock that not only effectively recycles nutrients but is also economically efficient.

### Economic efficiency of cut-and-carry feeding systems

A feature of upland small ruminant production is high forage offer rates. Survey data show that forage feeding rates in Javanese villages allow livestock to refuse as much as 400 g/kg DM offered (Little et al, 1988; Subagio, 1991). Excess feeding can result in higher rates of growth. Table 2 shows that growth rates improved when the quantity of forage on offer increased from 25 to 75 g DM/kg W.d. Similar responses have been observed elsewhere by Zemelink (1980) and Wahed et al (1990). It was suggested by these authors that the responses occurred because higher offer rates provided the animals with greater opportunity for selective feeding which in turn led to improvements in the quality of the

diet ingested. Under experimental conditions, offer rates of 50 g DM/kg W.d are more profitable compared to offer rates of 25 and 75 g DM/kg W.d. This finding is consistent with village offer-rates that reportedly range between 50 and 60 g DM/kg W.d (Johnson and Djajanegara, 1989).

However, farmers do not excess-feed to secure high growth rates alone. The larger quantity of feed refusals associated with higher offer rates are mixed with faeces and urine to produce compost. Increased offer rates not only improve the quality of intake but also result in larger quantities of manure-compost. Significantly, when farmers feed at 50 g DM/kg W.d manure-compost comprises 41% of total output from the production system and the conversion of the high uneaten forage levels into compost increases the returns to labour by 93% at this offer rate (Table 4). Production of high value manure-composts thus enables farmers to offset some of the extra costs associated with rearing livestock in intensively cultivated areas.

### Efficiency of nutrient cycling in cut-and-carry feeding

Several authors point out that under stall-feeding conditions, only faeces can be conserved and transported to cropland, whilst urine is usually lost from the system (Catchpoole, 1988; Powell and Ikpe, 1992). Powell and Ikpe (1992) stated that 40–60% of N excreted by animals is contained in urine and demonstrated that fields fertilised by grazing cattle produced 2.3 times more millet grain than those to which cattle faeces alone were added by hand. They attributed this finding to the fact that the grazed fields gained the added benefit of receiving urine.

To maximise the efficiency of nutrient cycling it is therefore important to conserve livestock urine. The Javanese stall-feeding system for small ruminants may go some way to achieving this aim. Sheep and goats are housed in small barns with slatted floors built over pits one to two metres deep. Rejected forage is thrown into the pit and absorbs some of the urine falling through the slats. It might be hypothesised that the proportion of urine captured in this way increases with rising quantities of refused forage.

The daily accumulation of layers of faeces and uneaten forage in the pit may also help to limit N loss by reducing the volatilisation of ammonia. Watson and Lapins (1969) estimated that around 50% of N contained in urine voided on to pasture by sheep in south-western Australia was lost through ammonia volatilisation, whilst Gillard (1967, cited by Henzell, 1973) calculated that up to 80% of N contained in faeces dropped on pasture was lost through a similar route. It is therefore important to minimise the exposure of livestock excreta destined for fertiliser from the damaging effects of the climate. The practice of excess feeding would lead to a more rapid formation of these "protective" layers of uneaten feed in the pit whilst the roof of a Javanese small-ruminant barn shelters the pit from sun and rain and the depth of the pit reduces exposure to wind.

The direct application of fresh faeces and urine on to pasture by grazing animals can lead to significant losses of N not only via ammonia volatilisation but also through denitrification and leaching. An advantage of the Javanese stall-feeding system is that it allows animal excreta and plant material to be composted. If carbon-rich materials, i.e. uneaten forage are mixed and composted with excreta they can intercept and stabilise N (Parnes, 1990). Composting may therefore represent a means of reducing the loss of vital plant nutrients. Also, this stabilising effect on nutrients might allow composted material to be stored without a significant drop in fertiliser quality thus allowing farmers to accumulate compost for more timely application to the growing crop.

The experimental data suggest that the quality of manure-composts increased as the proportion made up by rejected forage declined. However, although manure-compost 25 supported better plant growth at day 32 its superiority was diminished at 60 days. Holden et al (1993) found that farmers considered manure-compost with a higher proportion of excreta to be superior to manure-compost with a high content of vegetable matter. Farmers, aware of the trade-off between quantity and quality, prefer to maximise the quantity of manure-compost produced and so opt for high feeding rates which produce grass-rich manure-composts.

## Conclusions

Despite poor growing conditions, the uplands of Java are continually cropped and support dense human populations. It is argued that the use of manure-composts is the key to sustaining soil productivity (Adiningsih et al, 1991). The intensity of cropping in these areas precludes grazing and farmers house their animals instead. Housing facilitates manure-compost production and farmers are probably able to offset at least some of the extra costs associated with cut-and-carry feeding against the value of manure-composts.

Farmers reportedly feed between 50 and 60 g DM/kg W.d (Johnson and Djajanegara, 1989) and under experimental conditions offer rates of 50 g DM/kg W.d yielded greater returns to labour compared to offer rates of 25 g or 75 g DM/kg W.d. Excess feeding increased returns to labour by 200% at the highest offer rate (Rp 120/hour at 75 g DM/kg W.d versus Rp -120/hour at 25 g DM/kg W.d). Raising offer rates from 25 to 75 g DM/kg W.d increases returns to labour because:

- the N content of the forage selected and intake of DOM increased by 12.3% and 83.9%, respectively, at the highest offer rate, and growth rates were thus enhanced
- uneaten feed is used to produce manure-composts. Under experimental conditions, manure-compost production is increased by 330% at the highest offer rate.

## Acknowledgements

The authors would like to express their gratitude to the Directors of the Research Institute for Animal Production, Dr K Diwyanto and Dr M Sabrani (retired) for their support of the project. Thanks also to Dr P Hadley, School of Plant Sciences, University of Reading, for help with the design of the crop trial. The study was jointly funded by the Natural Resources Institute (ODA) and the ODA Animal Health Project, Indonesia.

## References

- Adiningsih J S, Semali A, Effendi S and Hadiwigeno S. 1991. Resources and problems associated with the development of upland areas of Java. In: Blair G and Lefroy R (eds), *Technologies for sustainable agriculture on marginal uplands of southeast asia*. Proceedings of a workshop, Ternate, Cavite, Philippines, 10–14 December 1990. ACIAR Proceedings 33. ACIAR (Australian Centre for International Agricultural Research), Canberra, Australia. 128 pp.
- Amir P, Soedjana T D and Knipscheer H C. 1985. *Labour use for small ruminants in three Indonesian villages*. Small Ruminant – Collaborative Research Support Programme (SR–CRSP) Working Paper 62. Winrock International, Morrilton, Arkansas, USA. 6 pp.
- Biro Pusat Statistik. 1991. *Statistik Indonesia, 1991*. Jakarta, Republic of Indonesia.
- Booth A. 1988. *Agricultural development in Indonesia*. Asian studies association of Australia. Southeast Asia Publications Series 16. Allen and Unwin, Sydney, Australia. 295 pp.
- Catchpole D W. 1988. *The contribution of tree legumes to the nitrogen economy and forage production in the humid tropics*. PhD thesis, University of New England, Australia. 190 pp.
- Colfer C J P. 1991. *Towards sustainable agriculture in the humid tropics. Building on the TropSoils experience in Indonesia*. TropSoils Bulletin 91–02. Soil Management – Collaborative Research Support Program. North Carolina State University, Raleigh, North Carolina, USA. 86 pp.
- Grigg D B. 1974. *The agricultural systems of the world. An evolutionary approach*. Cambridge University Press, Cambridge, UK. 358 pp.
- Henzel E F. 1973. The nitrogen cycle of pasture ecosystems. In: Butler G W and Bailey R W (eds), *Chemistry and biochemistry of herbage*. Volume 2. pp. 227–246.
- Holden S J, Kusumaningsih A and Martindah E. 1993. *A participative assessment of the production and role of manure-composts in upland agriculture in west Java* (unpubl.) ODA Animal Health Project, c/o FCO (Jakarta), King Charles Street, London, UK.

- Horne P M. 1988. *Tree legume/grass mixtures for forage production in the wet tropics*. PhD thesis, University of New England, Australia. 192 pp.
- Jahnke H E. 1982. *Livestock production systems and livestock development in tropical Africa*. Kieler Wissenschaftsverlag Vauk, Kiel, Germany. 253 pp.
- Johnson W L and Djajanegara A. 1989. A pragmatic approach to improving small ruminant diets in the Indonesian humid tropics. *Journal of Animal Science* 67:3068–3079.
- Kartamulia I, Karokaro S and de Boer J. 1993. *Economic analysis of sheep grazing in rubber plantations: A case study of OPMM Membang Muda*. Small Ruminant–Collaborative Research Support Programme (SR-CRSP) Working Paper 145. Winrock International, Morrilton, Arkansas, USA. 12 pp.
- KEPAS (Kelompok Penelitian Agro-Ekosistem) 1985. *The critical uplands of eastern Java: An agro-ecosystems analysis*. Agency for Agricultural Research and Development, Republic of Indonesia. 213 pp.
- Levine J. 1990. Small ruminants in the uplands of central and east Java. *Indonesian Small Ruminant Newsletter* 1(1):2–3.
- Little D A, Petheram R J and Boer M. 1988. Observations on the mineral content and nutritive value of diets fed to village ruminants in the Indonesian districts of Bogor (West Java) and Pamekasan (Madura, East Java). *Tropical Agriculture (Trinidad)* 65(3):213–218.
- Lowry J B, Petheram R J and Tangendjaja B (eds). 1992. *Plants fed to village ruminants in Indonesia. Notes on 136 species, their composition, and significance in village farming systems*. ACIAR Technical Reports 22. ACIAR (Australian Centre for International Agricultural Research), Canberra, Australia. 60 pp.
- Ludgate P J. 1989. *Overview of feeding constraints on upland production systems*. Small Ruminant–Collaborative Research Support Programme (SR-CRSP) Technology Information Files (TIF/N–15). (unpubl). Balai Penelitian Ternak, Ciawi, Bogor, West Java, Indonesia. 6 pp.
- Mathius I W and van Eys J E. 1983. *Feeds and feeding of sheep in Sukawargi village, West Java: A profile study*. Small Ruminant–Collaborative Research Support Programme (SR-CRSP) Working Paper 12. North Carolina State University, Raleigh, North Carolina, USA. 12 pp.
- Palte J G L. 1989. *Upland farming on Java, Indonesia. A socio-economic study of upland agriculture and subsistence under population pressure*. PhD thesis, Faculty of Geographical Sciences, University of Utrecht, The Netherlands. 251 pp.
- Parnes R. 1990. *Fertile soil: A grower's guide to organic and inorganic fertilisers*. agAccess, Davis, California, USA. 190 pp.
- Pelzer K L. 1945. *Pioneer settlement in the Asiatic tropics. Studies in land utilisation and agricultural colonisation in southern Asia*. American Geographical Society, New York, USA.
- Perkins J M, Semali A, Orchard P W and Rachman R. 1986. *An atlas of environmental and ruminant population characteristics of Java, A multivariate analysis approach*. Forage Research Project, Balai Penelitian Ternak, Ciawi-Bogor, Indonesia. 80 pp.
- Powell J M and Ikpe F. 1992. Nutrient recycling through livestock: "Fertiliser factories". *ILEIA Newsletter* 8(3):13–14.
- Raffles T S. 1817. *The history of Java*. Oxford University Press, Kuala Lumpur, Malaysia.
- RePPPProT (Regional Physical Planning Programme for Transmigration). 1990. *The land resources of Indonesia: A national overview 1990*. Land Resources Department, Natural Resources Institute (ODA) and Direktorat Bina Program, Departemen Transmigrasi, Jakarta, Indonesia. 282 pp.
- Sabrani M, Levine J and Kusnadi U. 1989. Crop–animal interaction and its implications for design of sustainable farming systems in Indonesia. In Sukmana S, Amir P and Mulyadi D M (eds), *Developments in procedures for farming systems research*. Proceedings of an international workshop held in Puncak, Bogor, Indonesia, 13–17 March 1989. Agency for Agricultural Research and Development, Ministry of Agriculture, Indonesia. pp. 221–235.
- Spedding C R W. 1979. *An introduction to agricultural systems*. Applied Science Publishers, London, UK. 169 pp.



- Subagio I. 1991. *Livestock and feed*. Animal Production Section, Interdisciplinary Research Project, Brawijaya University, Malang, East Java, Indonesia (unpubl.). 26 pp.
- Thahar A and Petheram R J. 1983. Systems of ruminant rearing during the dry season in West Java. In: Proceedings of the 5th World Conference on Animal Production. Volume 2:851–852.
- van Eys J E, Mathius I W, Pulungan H, Rangkuti M and Johnson W L. 1984. *Small ruminant production in West Java: Results of one year monitoring by the nutrition village monitoring program*. Small Ruminant – Collaborative Research Support Programme (SR–CRSP) Working Paper 34. North Carolina State University, Raleigh, North Carolina, USA. 46 pp.
- Wahed R A, Owen E, Naate M and Hosking B J. 1990. Feeding straw to small ruminants: Effect of amount offered on intake and selection of barley straw by goats and sheep. *Animal Production* 51:283–289.
- Wahyuni S, Suparyanto A, Isbandi and Gatenby R M. 1993. *Re-evaluation of outreach pilot project*. Small Ruminant – Collaborative Research Support Programme (SR–CRSP) Working Paper 143. Balai Penelitian Ternak, Pusat Penelitian dan Pengembangan Peternakan, Bogor, Indonesia. 15 pp.
- Watson E R and Lapins P. 1969. Losses of nitrogen from urine on soils from south-western Australia. *Australian Journal of Experimental Agriculture and Animal Husbandry* 9(36):85–91.
- Zemmelink G. 1980. *Effect of selective consumption on voluntary intake and digestibility of tropical forages*. Agricultural Research Report 896. Centre for Agricultural Publishing and Documentation, Wageningen, The Netherlands. 100 pp.

# **Interactions between animals and soils**

# Manure as a key resource in sustainable agriculture

*K.H. Murwira<sup>1</sup>, M.J. Swift<sup>2</sup> and P.G.H. Frost*

1. Chemistry and Soil Research Institute, Box 8100, Causeway, Harare, Zimbabwe
2. TSBF, c/o UNESCO-ROSTA, Box 30592, Gigiri, Nairobi, Kenya (corresponding author)
3. University of Zimbabwe, Department of Biological Sciences  
Box MP 167, Mt. Pleasant, Harare, Zimbabwe

## Abstract

Mixed arable-livestock farming systems are characteristic of large areas of Africa. In these systems manure from livestock is commonly used as a fertiliser in arable fields. In this paper the importance of manure from herbivores as a key ecosystem resource for agricultural intensification and change is evaluated. Two aspects are examined: first the value and utility of manure as a source of nutrients under current circumstances; and second the significance of manure as a fertiliser within the whole farming-system context. Manure has traditionally been an important source of nitrogen (N) and other nutrients. However, current trends in agricultural intensification tend towards a progressive decrease in the availability and quality of this resource suggesting that the continuing use of manure confers little benefit as a nutrient fertiliser. There are, however, a number of possibilities for manure utilisation which will maintain its management. Where possible, joint application of manure and inorganic fertilisers and manipulation of the relative amounts and times of application can synchronise N release and availability in the soil with demand for, and uptake by, crop plants. This is potentially the most productive approach, combining the short-term benefits of inorganic fertiliser with the long-term value of manure. This multiple-fertiliser approach can be extended. One of the major deficiencies in current research and extension is the failure to use indigenous knowledge and practice as a starting point for scientific intervention. Small-scale farmers in Zimbabwe commonly use four or five different fertilisers and apply them differentially across field types. The number of potential combinations and possible outcomes in terms of both long- and short-term effects on soil fertility provide the basis for a flexible and cost-effective soil nutrient management strategy. Additional increases in efficiency can be gained from modification of the storage stage of the system. With increasing pressure on land it is necessary to look beyond the traditional free range communal grazing systems to more intensive alternatives. In this respect moves towards cut-and-carry and zero-grazing practices such as are being adopted in Kenya and other countries in East Africa would seem to be a sensible option. It is nonetheless necessary to also consider the inclusion of alternative sources of fodder nutrients, such as those from N-fixing trees and other legumes.

## Le fumier, élément clé des systèmes agricoles durables

*K.H. Murwira<sup>1</sup>, M.J. Swift<sup>2</sup>, et P.G.H. Frost<sup>3</sup>*

1. Chemistry and Soil Research Institute, Box 8100, Causeway, Harare (Zimbabwe)
2. TSBF, c/o UNESCO-ROSTA, Box 30592, Gigiri, Nairobi (Kenya) (pour le courrier)
3. University of Zimbabwe, Department of Biological Sciences  
Box MP 167, Mt. Pleasant, Harare (Zimbabwe)

## Résumé

*Les systèmes mixtes de production sont caractéristiques de vastes régions d'Afrique. Dans ces systèmes, le fumier sert généralement à fertiliser les terres arables. Cet article évalue l'importance du fumier des herbivores en tant que ressource essentielle de l'écosystème dans l'intensification et la*

*dynamique de la production agricole. Deux aspects de ce phénomène ont été examinés, à savoir tout d'abord la valeur et l'utilité du fumier comme source d'éléments nutritifs dans les circonstances actuelles puis son importance en tant qu'engrais au sein du système agraire dans son ensemble. Le fumier est traditionnellement une importante source d'azote (N) et d'autres éléments nutritifs. Toutefois, les tendances actuelles de l'intensification agricole, caractérisées par une diminution progressive de la quantité et de la qualité du fumier, semblent indiquer que son utilisation comme engrais ne présente pas beaucoup d'avantages. Cependant, il existe un certain nombre de méthodes de gestion capables de promouvoir l'utilisation du fumier. Là où la chose est possible, le fumier doit être apporté en même temps que des engrais inorganiques et ce, en des quantités et à des moments spécialement choisis pour que l'azote soit libéré dans le sol au moment précis où les plantes en ont besoin et peuvent l'assimiler. Cette stratégie est la plus appropriée possible car elle permet de combiner les avantages à court terme des engrais inorganiques avec la valeur du fumier à long terme. Cette approche basée sur l'utilisation de plusieurs types d'engrais peut être généralisée. L'une des principales insuffisances des travaux de recherche et de vulgarisation actuels est qu'ils ignorent le rôle des connaissances et pratiques locales comme point de départ des interventions scientifiques. Au Zimbabwe, les petits paysans utilisent couramment quatre ou cinq différents engrais et les appliquent différemment selon le type de culture. Le nombre de combinaisons possibles et les résultats potentiels en ce qui concerne les effets à long et à court terme sur la fertilité doivent servir de base à des stratégies appropriées et coût-efficaces de gestion des éléments nutritifs des sols. On peut en accroître l'efficacité en jouant sur la phase de stockage du système. Compte tenu de la pression accrue que subissent les terres, les systèmes traditionnels de pâturage libre collectif doivent céder le pas à des modes de gestion plus intensifs. A cet égard, l'adoption de systèmes d'alimentation à l'auge et le zéro-pâturage comme ceux utilisés au Kenya et dans d'autres pays d'Afrique de l'Est semble constituer une option rationnelle. Il importe cependant d'examiner également la possibilité d'utiliser d'autres sources d'éléments nutritifs comme par exemple les ligneux et les légumineuses capables de fixer l'azote.*

## **Introduction**

Mixed arable–livestock farming systems are characteristic of large areas of Africa (Allan, 1964; UNESCO, 1979; Tothill and Mott, 1985). In many of these areas increased demand for food coupled with decreased availability of labour has resulted in more continuous cultivation of arable lands. Fallow periods that allowed regeneration after cultivation have become shorter, or the practice has been completely abandoned. Similar pressures are being felt on the availability of grazing land for livestock with consequent effects on the ownership of cattle and the quantity and quality of fodder.

Continuous cultivation of the land has resulted in accelerated soil nutrient depletion, decline in soil organic matter (SOM) content, loss of physical structure and reduced crop productivity. In many mixed agricultural systems manure from the cattle was traditionally used as a fertiliser to ameliorate many of these problems of soil fertility, either alone, or more recently in combination with inorganic inputs. Thus in nutrient-cycling models of mixed agricultural systems the excreta (manure and urine) of herbivorous mammals is often featured as a key ecosystem component (Frissle, 1978; Powell and Mohamed-Saleem, 1987; Swift et al, 1989) linking the livestock and arable components. However, the very factors that are causing the changes in sustainability and productivity of the system as a whole are also changing the availability and quality of the manure resource.

This paper evaluates the importance of manure from herbivores as a key ecosystem resource within this context of agricultural intensification and change. To do so the results of a case study on the use of manure in the communal area farming systems of Zimbabwe are used. Two general aspects are examined: first the value and utility of manure as a source of nutrients under current circumstances; and second the significance of manure as a fertiliser within the whole farming system context. Even though this paper concentrates on a particular case study, many of the issues raised are of relevance to other areas where mixed farming is predominant.

## Manure as a fertiliser

A variety of claims have been made about the potential benefits of manure application as a means of sustaining soil fertility (Olsen et al, 1970; McIntosh and Varney, 1972; 1973; Mathers and Stewart, 1981; 1984). The demonstrated benefits include increase in pH, water-holding capacity, hydraulic conductivity and infiltration rate, and decreased bulk density. Manure is also seen as a potentially important source of nutrients, especially nitrogen (N), phosphorus (P) and potassium (K). In the longer term the recalcitrant component of the manure forms a reserve pool of mineralisable nutrients that will be available for plant uptake in future seasons. Manure also has the long-term effect of raising soil organic matter levels with all the concomitant benefits to soil fertility. These benefits are not invariable, however, and excessive manure application has also been shown to lead to problems of ground water pollution through leaching of nitrate ( $\text{NO}_3\text{-N}$ ) from the soil (Pratt et al, 1976).

Manure fertilisation is a well-established practice in Zimbabwe, particularly as a source of nutrients for low fertility soils. The rational basis for its use has, however, not been fully developed. Most of the claims for its value are based on its use as a source of N and it is on this role that this discussion concentrates. Application rates for manure based on field trials have been recommended by several workers in the Department of Research and Specialist Services (Table 1). Unfortunately, it is difficult to compare the recommended rates because the chemical composition of the manures were not quoted (Mugwira, 1984a) and work carried out in Zimbabwe on manure quality (Tanner and Mugwira, 1984) and on the effectiveness of manure as a plant nutrient source (Mugwira, 1984b; Mugwira and Mukurumbira, 1986) has shown that manures from different Communal Areas are generally of low quality and vary widely in chemical composition, particularly in N and P. Information on decomposition rates and tests on nutrient availability are required for more precise recommendations and for the development of a predictive manure-N management model. The results of Mugwira and Mukurumbira (1986) indicate that the nutrient-supplying power of manure has not been adequately evaluated in this respect. Despite the realisation that manure has a beneficial residual effect (Cackett, 1960; Mugwira, 1984b; Mugwira and Mukurumbira, 1986) there is also a critical lack of quantitative information on the long-term effects of manure.

**Table 1.** Recommended rates of manure application for arable cropping in communal areas of Zimbabwe.

Author	Experimental area and type of soil	Recommendation
Alvord (undated)	*	40 t/ha every 4 years
Cackett (1960)	Matopos—granite sandveld	15–20 t/ha manure
Grant (1976; 1981)	Kwekwe communal area — granite sandveld	10 t/ha manure + 120 kg/ha N
Johnson (1962)	Chiweshe communal area — granite sandveld	5 t/ha manure + 191 kg/ha urea at 6 weeks after planting
Rodel et al (1980)	Henderson Research Station — granite sandveld	4.5 t/ha manure + 70 kg/ha $\text{P}_2\text{O}_5$ + 60 kg/ha $\text{K}_2\text{O}$

\* Original recommendation for the equivalent to communal areas in colonial times.

The effectiveness of manure as N fertiliser is influenced by its N content and its application rate. Cattle manures applied to fields in the communal areas have total N contents that range from 0.5 to 2% of dry matter but generally contain less than 1.2% N. Trounce et al (1985) reported that manure fertilisation of communal area vleis soils is inadequate due to the low P content making a supplementary P fertiliser necessary. Manure alone has also been shown to be an unsatisfactory fertiliser source of N

for high yielding maize crops because of its inability to supply continuously large amounts of readily available N (Grant, 1967a; Mugwira, 1985). In a greenhouse study high applications, equivalent to 80 t/ha of low quality manure, depressed plant growth in the first sampling period of four weeks because of immobilisation of N (Tanner and Mugwira, 1984). Better plant growth was observed in subsequent sampling periods. The immediate supply of nutrients to crops from manure may not be as high as from artificial fertilisers because of the organic nature of manure (Beauchamp, 1986). To maximise the benefit of manure to crops under dry-land conditions manure should be applied at the onset of the rains as its slow rate of nutrient release improves synchrony with plant intake and minimises losses through leaching (Singh et al, 1986). Because manures from communal areas are generally of low quality, Grant (1967b) has suggested that the benefits which accrue from fertilising with manure are due more to the amounts of bases released than to the supply of N and P.

### **Decomposition of manure in soil**

The beneficial effects of manure on soil fertility, and in particular its role as a source of nutrients, are dependent on the outcome of the biological processes of decomposition. These processes determine the rate of release of carbon and nutrients and the equilibrium between retention and loss from soil (Swift et al, 1979).

The majority of studies on manure decomposition have focused on N dynamics. The N-fertiliser value of manure depends on its initial nutrient content and on the rates of mineralisation of nutrients to the inorganic form. The initial content is strongly influenced by the conditions of storage before application. Studies of N mineralisation in soil are useful because efficient management of manure-N requires a knowledge of the time course of N transformation in order to predict availability to the plant. The quantitative contribution of manure to soil N and the interaction between manure N and soil N also need to be known so that any residual effects of the organic input can be quantified. The N from manure may be retained in soil in organic form or released in inorganic form to the soil whence it either accumulates, is taken up by plants, or lost through leaching and gaseous emission. Efficient use of N in a cropping system requires maximisation of uptake and retention in the soil. The former is promoted by synchrony between nutrient release and nutrient uptake. Lack of synchrony increases the potential for nutrient losses (Myers et al, 1994).

The decomposition pathways of manures into inorganic nutrients and carbon dioxide are relatively standard, though variations may exist due to the quality of manure. The term 'quality' embraces intrinsic factors that affect the ability to decompose such as lignin, nutrient content and particle size (Swift et al, 1979) which, together with physico-chemical and biological environmental factors, regulate the decomposition process. The rate of mineralisation of N is regulated by the same range of factors, i.e. temperature, moisture, pH, lignin and polyphenol content and C:N ratio. Rates and patterns of decomposition and mineralisation are also influenced by the soil type and interactions with fertilisers and other soil amendments.

### **Temperature and moisture**

Higher temperatures generally promote increased mineralisation rates and a rapid turnover of organic N (Sims, 1986). This response to temperature may be described by an Arrhenius' equation (Addiscot, 1983):

$$k = Ae^{-BT}$$

where:

- k is the mineralisation rate (per day)
- A and B are constants
- T the absolute temperature in Kelvins

The moisture content directly regulates the activity of decomposer micro-organisms, with the optimum for N mineralisation being -0.1 cm to -0.5 cm of soil moisture tension (Runge, 1983). Several other investigations have attempted to quantify the effect of moisture on N mineralisation of soil

(Myers et al, 1982; Clark and Gilmur, 1983) though little has been done on manure amended soils. Murwira (1993) found a quadratic response of N mineralisation to increase in moisture from 10% of water holding capacity to saturation. The equation had the form:

$$Y = 0.221 + 0.028X - 0.00025X^2$$

where:

Y is a moisture response factor

X is the water holding capacity

Prediction of the mineralisation pattern of organic N in the field is confounded by fluctuations of both inter- and intra-seasonal moisture levels. Intermittent wetting and drying is important in influencing N mineralisation, and can result in an increase in measured inorganic N on rewetting the soil following a period of drying (Birch, 1960). The cumulative effects of multiple drying and rewetting cycles on N release could be critically important to nutrient cycling in a savanna climate with highly erratic and unreliable rainfall.

### Quality of manure

The chemical composition of cattle manure is influenced by the diet of the cattle, and by the conditions under which the manure is stored and handled (van Fassen and van Dijk, 1987). These factors account for some of the variations in manure composition reported from different countries. In a review of the utilisation of N by grazing dairy cows Van Vuuren and Meijs (1987) indicated that intensification of grassland production, including N fertilisation, increased herbage N intake but decreased the efficiency of N utilisation by the animal. This resulted in higher N excretion in faeces and, especially, in urine. During aerobic decomposition organic materials with high stability and containing low amounts of inorganic N are formed (Kirchmann, 1985) reducing, in the short term, the value of the manure as a N fertiliser (Castellanos and Pratt, 1981; Kirchmann, 1989). In contrast, during anaerobic decomposition, compounds of low molecular weight such as volatile fatty acids are formed (Guenzi and Beard, 1981), and high concentrations of  $\text{NH}_4\text{-N}$  are found.

The decomposition rate of manure is known to be affected by its C:N ratio. Early hypotheses suggested that net mineralisation generally occurs at C:N ratios of less than 23 (Alexander, 1977; Swift et al, 1979). Subsequent studies by a number of authors have shown that the lignin content also controls decomposition and that the lignin:N ratio is often a better predictor of decay rates of litter than C:N (Fogel and Cromack, 1977; Mellilo et al, 1982).

The kinetics of C and N mineralisation in soils has generally been found to follow first order kinetics (Stojanovic and Broadbent, 1956; Sinha et al, 1977) where the first order equation is:

$$N_t = N_o [1 - \exp(-kt)]$$

where:

$N_t$  is amount mineralised after time t

$N_o$  is the potential amount that can be mineralised

k is the rate constant

The results from a study of decomposition of manures of different origins and qualities subjected to different storage treatments showed that there was no significant difference in the decomposition of aerobically treated manures regardless of whether they were derived from low or high input farming systems (Murwira, 1993). Carbon mineralisation values from composted manures were low and less than 20% of total carbon was released over a period of 60 days (Murwira, 1993). Differences in decomposability between aerobically treated manures probably reflect initial and short-term variations in the content of the readily decomposable fractions.

In the same study little or no N was mineralised from the fresh and the aerobically treated manures irrespective of their origin. Fresh, aerobically treated manures may thus be expected to have a low N fertiliser value in the short term. However, other beneficial effects such as supply of other nutrients in the short term (Grant, 1967b) and an increase in the water-holding capacity of the soil may be more important. In spite of partial immobilisation of N, inorganic N contents were highest in soil to which anaerobically treated manure had been added (Murwira, 1993). Of the three manure treatments investigated, only the anaerobically decomposed manure would have a positive N effect on crops in the short term. This is an interesting result and suggests that a different treatment, anaerobic storage, might improve the availability of N from manure by influencing its quality.

### **Soil type and soil amendments**

Soil type is also important in determining mineralisation rates. Generally, the rate of N mineralisation is lower in clay soils because clay particles shield organic matter from decomposition. Annual N mineralisation rates (mineralised N as a percentage of total organic N) of Zimbabwean soils have been found to be about 5% for sandy soils and 2–3% for clay soils (Saunders and Grant, 1962). Little is known about the influence of soil factors on manure decomposition although it may be hypothesised that the same relationship will hold.

Most soils found in communal areas in Zimbabwe can be classified as either Alfisols, Oxisols or Ultisols (Asumadu and Weil, 1988), and are typically acid in their reaction. Crops grown on these soils are relatively acid tolerant, but the soils need to be limed to a minimum pH of 5.5 to avoid micronutrient deficiencies or toxicities. The soil pH regulates microbial activity, and hence mineralisation of organic matter, such that the decomposition of organic matter is higher at neutral pH than in acid soils (Foy, 1984). The optimum pH for decomposition in the soil is 5–7, with the lower threshold being more favourable in tropical soils. Rates of N mineralisation have also been found to be increased by liming (Cornfield, 1952; Nyborg and Hoyt, 1978; Edmeads et al, 1981). Liming of manure-amended soil could thus be a means of hastening N release from manure, especially when N is limiting. For moderately acid soils the application of pig slurry or poultry manure was found to increase the soil pH temporarily, probably because of  $\text{NH}_4\text{-N}$  formation, which in turn promoted a temporarily rapid rate of nitrification (Cooper, 1975; Crane et al, 1981). In studies carried out in Zimbabwe, liming did not affect N mineralisation, but it increased carbon mineralisation relative to that occurring in unlimed soil. The stimulatory effect of liming on carbon mineralisation, however, lasted only for a few days after adding lime (Murwira, 1993).

Fertilisation with various forms of inorganic N is an increasing practice in some areas of communal area farming in Zimbabwe. Previous studies on the decomposition of cattle manures from communal areas showed that they mineralise less than 10% of the total N in the first season of application of manure (Murwira, 1993). This suggests that the high C:N ratio may be delaying the onset of N release. It could therefore be hypothesised that the addition of inorganic-N should promote a faster rate of decomposition by increasing the availability of N to microbes and hence hasten the rate of release of manure-N into inorganic form. In experiments with manure, addition of fertiliser N, however, did not increase the N mineralisation rates of the N-poor cattle manures and indeed depressed the mineralisation of manure carbon (Murwira, 1993).

### **Losses of manure N from soil**

Losses of N occur through denitrification,  $\text{NH}_3$  volatilisation, nitrate leaching and runoff. Denitrification occurs under anaerobic conditions and requires the presence of denitrifying micro-organisms,  $\text{NO}_3\text{-N}$  and an organic energy source. Ammonia volatilisation is pH dependent, occurring at pH values greater than seven. Nitrate formed from mineralisation of manure N is highly mobile and easily leached when there is excessive water movement through the soil profile. Loss of N through runoff can occur as dissolved salts or as components of particles washed away in suspension.



Gaseous N losses of 20–76% from soil mixed with manure have been reported under laboratory conditions (Olsen et al, 1970). The higher losses occurred under denitrifying conditions. Adriano et al (1974) found losses of up to 45% N from soil–manure systems. They reported an increase in N loss with increases in both temperature and moisture. Guenzi et al (1978) also reported losses of 8–10% of applied  $^{15}\text{N}$  fertiliser from a soil–plant system without manure. Higher losses, however, were found for soils amended with manure irrespective of whether inorganic fertilisers were also added. The larger losses of N in manure amended soil are thought to be due to denitrification losses occurring in localised sites of high biological oxygen demand in a predominantly aerobic soil (Guenzi et al, 1978). With manure-amended soil, the per cent N losses were lower in a cropped than in a fallow system. In Zimbabwe, denitrification is likely to be insignificant in dry upland areas, but may be an important loss pathway in vleis areas (wetlands). These wetlands constitute about 30% of the area of Zimbabwe and are regarded by farmers as resource areas of high value because of the persistence of moisture for crop and vegetable growth into the dry season. They are thus often primary target areas for application of both organic and inorganic manures (Carter et al, 1993; Campbell et al, 1994) although this practice is currently discouraged by the extension service.

Losses of N through  $\text{NH}_3$  volatilisation occur soon after dung and urine are excreted, during storage, and after application to the field. Despite the importance of potential  $\text{NH}_3$  losses in the N economy of communal farming systems,  $\text{NH}_3$  losses from decomposing animal residues have not been extensively measured in tropical cropping systems although there is considerable evidence from studies in temperate areas.

Ammonia volatilisation is affected by the physico-chemical environment in which manure is stored, such as pH, temperature and moisture, and the initial quality of the manure (Freney et al, 1981). Higher losses of N through volatilisation have generally been reported from manure alone than from soil–manure systems. Kirchmann (1985) found  $\text{NH}_3$  losses of up to 40% from manure alone, with a strong inverse correlation between  $\text{NH}_3$  losses and C:N ratio (i.e. losses increased with decrease in C:N ratio) in aerobic systems. Losses of  $\text{NH}_3$  from slurries spread on the soil surface at rates of 34–200 t/ha were reported to be as high as 99% of applied  $\text{NH}_4\text{-N}$  after 5–25 days but incorporation of manure into soil reduced the loss by as much as 50% (Giddens and Rao, 1975) and in some cases, to less than 1% of added  $\text{NH}_4\text{-N}$  (Adamsen and Sabey, 1987).

In a study of losses of N through  $\text{NH}_3$  volatilisation from manure before and after application to soil in Zimbabwe, total ammonia losses from the cattle manures during storage and after application to soil were found to be low, amounting to a maximum of 6% of the total N content. Losses of up to 6% of total N were measured from fresh dung and decomposing manure, but little (less than 1%) or no losses occurred after application of the manure to soil (Table 2). Emissions of  $\text{NH}_3$  from the surface of crop fields amended with manure were also negligible (Murwira, 1993). This suggests that losses due to ammonia volatilisation in the field may be insignificant, perhaps because the N content of communal area manure is so low by the time of application. The more significant losses are those that occur during the pre-application period.

**Table 2.** Ammonia loss from soils with or without manure and incubated at different moisture contents (% WHC).

Moisture content (WHC) %	Ammonia loss					
	Soil		Communal area manure		Feedlot manure	
	%	sd	%	sd	%	sd
25	0		0.08	0.03	0.16	0.04
35	0		0.11	0.06	0.16	0.05
50	0		0.20	0.10	0.18	0.04
65	0		0.07	0.04	0.22	0.01
75	0		0.17	0.06	0.29	0.07

## Nitrogen use efficiency

Although many communal-area farmers have to rely on organic inputs, especially cattle manure, to fertilise the soil, manure alone is not adequate to sustain yields and additions of inorganic fertiliser are required (Grant, 1981). Several studies (Table 1) have been conducted to determine the optimum manure and fertiliser combinations for maximising crop yields (Mugwira, 1985; Trounce et al, 1985). For the resource-poor communal-area farmers, who lack the capital to purchase substantial quantities of fertiliser, it is crucial to determine the minimum amount of inorganic N that needs to be added to obtain the optimum amount and timing of N release from manure. In this regard, a number of insights can be gained from nutrient cycling and decomposition studies in non-agricultural ecosystems especially forest ecosystems, where productivity and sustained yields can be maintained without substantial fertiliser inputs (Aber et al, 1979; Swift, 1984; Woomer and Swift, 1994).

Though it has not been well established, the N use efficiency by plants in sandy soils appears to be low. This could be due to high  $\text{NO}_3\text{-N}$  leaching (Swift et al, 1989). In general, recovery of N from fertilisers is about 30–70% of the applied N in the year following application (Bock, 1984). Nitrogen recovery from manure in the classic Broadbalk experiment at Rothamsted was calculated at 40 to 60% (Jenkinson, 1982). Using an *in situ* incubation technique (Raison et al, 1987; Anderson and Ingram, 1989) Murwira (1993) made simultaneous measurements of N mineralisation, uptake and leaching from arable soils to determine N use efficiency (Debosz and Vinther, 1989) at a site at Grasslands Research Station, Marondera, Zimbabwe in the 1990/91 season. Treatments used were a control, manure applied before planting, manure+Nf (N-fertiliser) at planting, manure+Nf (six weeks after planting), Nf at planting and Nf(6WAP). The manure was applied at an equivalent rate of 10 t/ha and the N at 100 kg/ha.

The apparent N recovery by the plants as estimated by the difference method were: less than 0% (manure only), 42% (manure + Nf applied pre-planting), 34% (manure + Nf applied six weeks after planting), 64% (Nf applied pre-planting), and 69% (Nf applied six weeks after planting). The low recoveries in the manure treatments were due to N immobilisation when the plant N demand was high. This shows that availability of N to crops in manure is lower throughout than from inorganic N because of the slow release of organically bound N, and the lack of synchrony between crop demand and mineralisation. Release from manure is spread out through time, hence there is never a sharp peak in mineralisation that can be synchronised with plant demand.

Total losses through nitrate leaching from the plough layer were between 4% and 42% of applied N. The highest losses were measured in unamended soil, in soil treated with manure only, and in soil receiving an early application of N. The high leaching losses measured in these treatments were due to asynchrony between N release and uptake. Synchrony between N release and uptake was highest in treatments receiving combinations of manure and fertiliser N, especially N applied after planting. Therefore fertilisers are not only a necessary adjunct to manure application in maintaining crop yields, but they also help in coupling N release and uptake.

## Manure as a system resource: The case of the communal area farming systems of Zimbabwe

The manure currently available to farmers in the communal areas of Zimbabwe is of low value as a source of N. Despite the deficiencies of available manure as a fertiliser, however, it is likely to remain a key resource for soil fertility management in the mixed livestock–arable farming systems which are such an important component of the agriculture sector in Africa. The challenge for the researcher is thus to increase the efficiency of utilisation of this resource. Most research has been focussed on manure as a source of nutrients in relation to its impact on crop growth and on soil properties. The efficiency of use, however, is influenced by many other factors that can only be appreciated by viewing manure within a system framework. This framework is discussed with reference to the small-scale low-input agropastoral farming that is predominant in large areas of Zimbabwe.

Although there is a significant large-scale commercial sector for both arable and cash cropping and livestock production for beef and dairy, the small-scale sector occupies more than 80% of the farming population and is predominantly of a mixed livestock–arable structure. This practice is conducted in the communal areas of Zimbabwe and is therefore referred to as the Communal Area Farming System (CAFS) (Swift et al, 1989). Although there are many variations in farming practice across the country it is a profitable strategy to formulate some generalisations concerning the role of manure as a system resource in order to create the context within which proposals for improved use can be designed.

Communal farming areas in Zimbabwe have predominantly sandy soils that are derived from granite. The soils are recognised as inherently infertile and require fertilisation to sustain yields. Land use in the communal areas is dominated by a low input agropastoral farming system in which the croplands are fixed in location and are typically adjacent to areas of savannah that are used communally for grazing livestock. Fertilisation practices are varied (Table 3). Since independence small-scale farmers have had considerably improved access to inorganic fertilisers, through favourable government credit and subsidy policies, so that in some areas the practice of inorganic fertilisation has become almost universal (Table 3). There is evidence that this situation may now be declining, however, since government policies have been altered under the Structural Adjustment Programme. The amount of inorganic fertiliser used is generally small and significantly below the levels recommended for the agro-ecological region. Farmers thus continue to use a whole range of locally derived fertilisers (Table 3; Campbell et al, 1994).

**Table 3.** Fraction (%) of households using different fertilisers in communal areas in Zimbabwe.

Reference	Area	Inorganic (purchased)	Manure	Leaf litter	Termite soil	Stover collection
1	National CAs	25–48	40–80	*	–	–
2	Mutoko CA	98	86	36	23	77
3	Mangwende CA	93–97	32	–	–	–
4	Shurugwi CA	40	65	44	49	–
5	Mutanda RA	–	–	32	–	–
6	Chivi South CA	–	–	38	57	–
7	Mangwende, Chivi and Shurugwi CAs	–	–	68	–	–
8	Mazvihwa CA	–	60	–	–	83

\* (–) = no record; CA = communal area; RA = resettlement area.

1. Ashworth (1990).
2. Campbell et al (1994).
3. Shumba (1986a); (1986b).
4. McGregor (1991).
5. Grundy et al (1993).
6. Balderrama et al (1988).
7. Campbell et al (1991).
8. Scoones (1990).

### Importance of manure in communal area farming systems

Manure is the most commonly used locally derived fertiliser. Cattle owners graze their livestock in communal grazing areas derived from the local savannah. The cattle are confined overnight in a cattle pen (kraal) close to the household. In most farming practices in Zimbabwe, manure which accumulates throughout the year in the kraal is spread on the fields during the dry season. Cattle are also driven into the fields to feed on remains of harvested crops, and in the process their droppings fertilise the

soil. In Côte d'Ivoire, West Africa, cattle farmers of the Fulani tribe set up kraals in the fields. The position of the kraal is rotated throughout the field at regular intervals (Schleich, 1986). Direct manuring of fields through rotation of kraals is not practised widely in Zimbabwe but has been reported in some parts of the country such as Mutoko (Carter et al, 1993). In a small percentage of households manure may be collected from the grazing area and applied directly to the fields. The crop residues, particularly maize, are collected from the crop fields and fed to cattle in the pens and the nutrients returned to the soil through excreta rather than by direct mulching (Figure 1). This practice is very frequent (Table 3). Though the nutritive value of maize stover which is fed to cattle during the dry season is low (Topps and Manson, 1967), the cattle excrete 80–90% of the N, phosphorus (P) and potassium (K) they consume (Mentis, 1981). Thus, nutrient return through excreta from farm animals represents a potentially important pathway in the N cycle of the farming system.

**Figure 1.** Utilisation of locally derived fertilisers by farm households in Mutoko Communal Area, Zimbabwe. Data are amounts in kg/ha transferred between different sources and sinks (from Campbell et al, 1994). For clarity some minor transfers have been omitted.

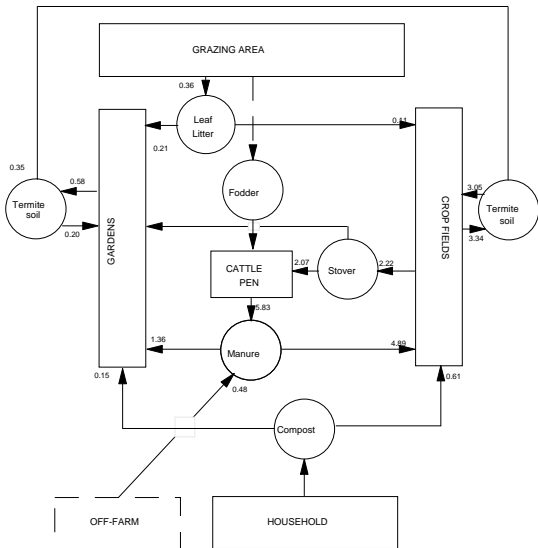

As the data in Table 3 indicate, manure is only one of a range of nutrient sources used by farmers in what amounts to a complex and sophisticated strategy of soil nutrient management. Figure 1 illustrates the major transfers of materials in a sample of farm households in the Mutoko Communal Area of Zimbabwe (Campbell et al, 1994). These farmers almost invariably use inorganic fertiliser (not shown in the diagram) but manure accounts for 57% of the mass and 87% of the N in the local fertiliser used on the crop (predominantly maize) fields. When the total N budget is taken into consideration inorganic fertiliser supplies 64% and manure 32% of the total N used by the farmers. Thus manure makes a significant contribution to the overall N budget even in farms with a high access to inorganic fertilisers. When these fertilisers are not available then it is the only significant source of N. Farmers without access to inorganic fertiliser who do not own cattle have no means of maintaining soil fertility.

### **Factors influencing manure use**

The amount of usable manure that can be obtained from cattle depends upon factors such as the amount of feed, the method of feeding (pen rearing, kraaling the animals at night, or free range) and the efficiency of collection of the manure. It is estimated that one livestock unit (1 LU = 500 kg live mass) produces about 7 t of recoverable manure per year when stabled all day. This declines to 2–3 t per year of usable manure (i.e. 30–40% recovery), if the animals are stabled only overnight (Schleich, 1986). To produce enough manure requires an extensive land resource base. Swift et al (1989) estimated that for the system to be sustainable, between 14 and 42 ha of grazing land is required to produce enough manure to achieve a yield of 2 t/ha of maize. This is clearly unattainable given the increasing population pressures and the consequent diminishing of the area under grazing.

The distribution and return of cattle excreta to the arable subsystem also depends on the movement of cattle within and outside the subsystem when they are left free to graze the stover in the field. The 60–70% of manure which is not recovered in the kraal is not necessarily lost from the arable subsystem as some of the droppings may fall in the fields, although studies in Nigeria (Powell and Mohoamed-Saleem, 1987) indicated that the amount of manure deposited by cattle while grazing in the croplands is negligible; most of the manure is deposited in the pastures. This, however, is an important return to this system (Mentis, 1981; Swift et al, 1989).

The nutrient content of the manure obtained from stabling is affected by several factors such as quality of feed, storage and handling conditions in the kraal, ambient temperature and moisture levels, and the length of exposure to the environment. The dung may be contaminated with sand, the initial sand content depending on the amount of soil ingested by cattle during grazing. This initial sand content varies considerably depending on soil type, stocking rate and the season, but is generally less than 10% of dry matter (Healy, 1968). The trampling of manure in the kraal by cattle is more important, however, and can result in exceptionally high sand contents of over 50% through mixing of manure and soil (Mugwira, 1984). The conditions in the kraal under which the manure is stored allow for aeration and result in an aerobically decomposed and dried manure, thence the potential for  $\text{NH}_3$  losses is high. The return of N through precipitation, estimated to vary between 2 and 5 kg N/ha per year in Zimbabwe, may offset these losses (Weinmann, 1955). When cattle are pen-fed with crop residues in the kraal, dung and urine may be mixed with stover. This produces manure with a high C:N ratio which may be a way of conserving nutrients. Poor grazing, storage, and handling conditions thus combine to produce a manure with low N content, often less than 1.2% total N in dry matter (Tanner and Mugwira, 1984).

### **Decomposition of manure during storage**

Three decomposition pathways of manures in storage have been identified, namely anaerobic fermentation, anaerobic-aerobic fermentation and aerobic decomposition (Kirchmann, 1985). The pathways occur under anaerobic, low oxygen supply, and aerobic conditions, respectively. Anaerobic decomposition results in a higher content of humic substances being formed than in aerobically

decomposed manures (Siegel, 1936, cited in Kirchmann, 1985) and can decompose up to 40% of the organic carbon which is also higher than for anaerobic-aerobic fermentation (Coker et al, 1987). In Zimbabwe, manures are mostly stored under aerobic conditions.

The type of decomposition pathway affects the concentration of mineral N in the manure. During anaerobic fermentation, up to 70% of the organic-N can be converted to the ammoniacal form resulting in concentrations of 800–1800 mg NH<sub>4</sub>/litre in the liquid phase (Coker et al, 1987). Undigested sewage sludge has only about 5–15% of total N present as ammoniacal-N in the liquid phase. In contrast, little or no ammoniacal-N is formed in aerobic and aerobic-anaerobic fermentation.

Studies of the seasonal temperature effect on manure decomposition in Europe have shown that low temperatures during winter (<0°C) retarded decomposition thereby resulting in little loss of dry matter (Kirchmann, 1985). In contrast, dry-matter losses of about 50% were measured in compost stored for five months in summer, when temperatures were higher. These high dry-matter losses resulted in a decrease in C:N ratio as much of the loss represented mineralisation of carbon (Kirchmann, 1985). The latter conditions are much closer to those that prevail throughout the year in Africa.

Nitrate levels are generally low in digested sludge or slurries and therefore substantial denitrification is not expected during storage (Loynachan et al, 1976). Generally N losses are lower from anaerobically stored manures than from aerated manures as there is less NH<sub>3</sub> volatilisation during anaerobic decomposition. In comparison, ammonia losses from aerated manures can range from 1–60% of total N, with the amount increasing with storage time (Much and Steenhuis, 1982; Dewes et al, 1990).

### **Nitrogen cycling in the arable subsystem of the communal area farming system**

From measurements made to quantify the different processes and assess the relationship between inputs and outputs, a unified picture of N cycling in the arable subsystem can be derived. The findings on pool size and flows over a range of input conditions are presented in Figure 2. This figure depicts a relatively static situation; it is a first step towards developing a general predictive understanding of the functioning of the system as a means to identifying priorities for improving the efficiency of manure use in mixed farming systems.

The main losses of N from the system are from ammonia volatilisation in the kraal, and nitrate leaching in the field. From an input of 100 kg/ha of manure N or fertiliser N into soil, NH<sub>3</sub>-N leaching losses of less than 1% were recorded; NO<sub>3</sub>-N leaching losses varied between 4 and 42%. The amount of manure N mineralised per year (in the year of application) was about 6% although it could be higher (46%) due to later mineralisation of residual manure N from earlier applications. Less than 1% of total N in maize roots was mineralised in the first season. Nitrogen uptake by maize from manures and fertilisers ranged between 0 and 69%. The partitioning of N within the plant was as follows: 8–10% in roots, 48–66% in above ground stover, and 26–42% in grain.

### **Animal/soil interactions and sustainable agriculture**

Manure has been, and continues to be, an important source of N and other nutrients in agro-ecosystems throughout the savannah zones of Africa. However, current trends in agricultural intensification are leading to a progressive decrease in the availability and quality of this resource. Cattle ownership is becoming less frequent within the community; the area of land for grazing is decreasing; the quality of fodder is declining and the nutrient stocks of agricultural soils are being depleted. Increase in rural populations coupled with emigration of the young labour intensifies the problem.

As reviewed above, the continued use of manure under these conditions confers little benefit as a nutrient fertiliser. Does this mean that the concept of manure as a key resource in African agriculture should be abandoned? In effect this conclusion means the abolition of the mixed farming system, a

**Figure 2.** Efficiency of N flux in an animal–plant–soil system of a communal area farm in Zimbabwe. The data are ranges of measured variables detected in applications of zero to 100 kg N of fertiliser as manure, inorganic N or as a mixture.

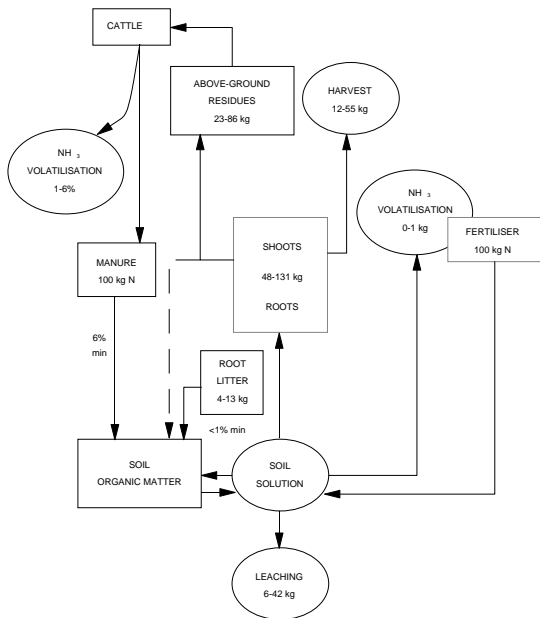

development with profound social and cultural implications. This paper argues that this conclusion is not justified. There are a number of pathways for intensification of agriculture in which manure may continue to be a resource of significant value in soil management. The main point that underlies this recommendation is one that is not dealt with in any detail in this review — that the long-term benefits of manure, in terms of both chemical and physical properties of soil, probably far outweigh the short-term gains from nutrient supply. This nonetheless only serves to emphasise the need to improve the nutrient use efficiency in the first instance. In view of the low quality of current manures as nutrient

sources it is important to examine the optimum strategies for maximising the efficient use of manure N. One strategy that has already been advocated for circumstances where there is some limited access to inorganic fertilisers is joint application of the two sources and manipulation of the relative timing of application to synchronise N release and availability in the soil with demand for, and uptake by, crop plants. While manure is mostly applied before planting, there is some degree of flexibility in the time a farmer can apply fertiliser N. Manure can be supplemented with fertiliser N at pre-planting, or a few weeks after planting. Supplementary fertiliser N has generally been found to produce the best response 4–6 weeks after planting (Rodel et al, 1980). This is already a common practice (Table 3) that farmers are probably experimenting more intensively than scientists.

This is only a limited example of the potential that exists for increasing nutrient use efficiency by application of mixed sources of nutrients. The 'average farmer' of Mutoko defined in the study by Campbell et al (1994) utilises four or five different fertilisers and applies them differentially across field types (Table 3; Figure 1). The number of potential combinations and possible outcomes in terms of both long- and short-term effects on soil fertility are sufficient to engage the attention of soil scientists for a considerable period of time. One of the major deficiencies in current research, and more particularly in the recommendations made for fertiliser use is the failure to use indigenous knowledge and practice as a starting point for scientific intervention.

Additional increases in efficiency can be gained from modification of the storage stage of the system. Although losses by such pathways as volatilisation from the kraal may seem low, they may be quite significant within the context of low external input agriculture. Losses during storage should be reduced, and the manure should be incorporated into the soil early in the season before planting. One possible way of reducing losses before incorporation into the soil is to protect the manure from adverse weather both inside and outside the kraal. Using crop residues as bedding materials in the kraal may further reduce ammonia losses and conserve nutrients in the manure by absorbing urine and through immobilisation of N. The quality of manure may be improved if the anaerobic pathways are encouraged. This further points to the need to focus more research attention on the conditions of cattle penning.

Ultimately, however, no improvements in fertiliser quality can be made if fodder availability for the livestock is insufficient. With increasing pressure on land it is necessary to look beyond the traditional free range communal grazing systems to more intensive alternatives. In this respect moves towards cut-and-carry and zero-grazing practices such as are being adopted in Kenya and other countries in East Africa would seem to be a sensible option. It is nonetheless necessary to also consider the inclusion of alternative sources of fodder nutrients, such as those from N-fixing trees and other legumes (Shepherd et al, this volume) to supplement the savanna vegetation. As pointed out before in relation to sustainable development of mixed farming systems, 'the maintenance of a stable and self-renewable nutrient reservoir in the grazing subsystem' is as important a focus for research for arable crop productivity as is the efficiency of fertiliser use on the arable fields (Swift et al, 1989). The significance of that recommendation lies in the continuing importance of herbivore manure as a resource for soil improvement.

## References

- Aber J D, Botkin D B and Mellilo J M. 1979. Predicting the effects of different harvesting regimes on productivity and yield in northern hardwoods. *Canadian Journal of Forest Research* 9:10–14.
- Adamsen F J and Sabey B R. 1987. Ammonia volatilisation from liquid digested sewage sludge as affected by placement in soil. *Soil Science Society of America Journal* 51:1080–1082.
- Addiscot T M. 1983. Kinetics and temperature relationships of mineralisation and nitrification in Rothamsted soils with differing histories. *Journal of Soil Science* 34:343–353.
- Adriano D C, Chang A C and Sharpless R. 1974. Nitrogen loss from manure as influenced by moisture and temperature. *Journal of Environmental Quality* 3:258–261.



- Alexander M. 1977. *Introduction to soil microbiology*. John Wiley & Sons, New York, USA. 467 pp.
- Allan W. 1964. *The African husbandman*. Oliver & Boyd, Edinburgh, UK.
- Anderson J M and Ingram J S I. 1989. *Tropical soil biology and fertility: A handbook of methods*. CAB (Commonwealth Agricultural Bureaux) International, Wallingford, UK.
- Ashworth V A. 1990. *Agricultural technology and the communal farm sector. Main report*. Background paper prepared for Zimbabwe Agricultural Sector Memorandum. Agriculture Division, Southern Africa Department, The World Bank, Washington, DC, USA.
- Asumadu K and Weil R R. 1988. A comparison of the USDA Soil Taxonomy and the Zimbabwe soil classification system with reference to some red soils of Zimbabwe. In: Nyamapfene K, Hussein J and Asumadu K (eds), *The red soils of east and southern Africa*. Proceedings of an International Symposium, Harare, Zimbabwe, 24–27 February 1986. IDRC (International Development Research Centre), Ottawa, Canada. pp. 413–443.
- Balderrama S, Fenta T, Hussein A, Jackson C, Midré M, Scott C, Vasquez C and de Vos J. 1988. *Farming system dynamics and risk in a low potential area: Chivi South, Masvingo Province, Zimbabwe*. ICRA Bulletin 27. ICRA (International Course for Development Oriented Research in Agriculture), Wageningen, The Netherlands. 81 pp.
- Beauchamp E G. 1986. Availability of nitrogen from three manures to corn in the field. *Canadian Journal of Soil Science* 66:713–720.
- Birch H F. 1960. Nitrification in soils after different periods of dryness. *Plant and Soil* 12:81–96.
- Bock B R. 1984. Efficient use of nitrogen in cropping systems. In: Hauck R D (ed), *Nitrogen in crop production*. American Society of Agronomy, Crop Science Society of America, Soil Science Society of America, Madison, Wisconsin, USA. pp. 273–294.
- Cackett K E. 1960. A manurial trial on granite sand at Matopos Research Station. *Rhodesia Agricultural Journal* 57:111–115.
- Campbell B M, Vermeulen S J and Lynam T. 1991. *Value of trees in small-scale farming sector of Zimbabwe*. IDRC (International Development Research Centre), Ottawa, Canada. 72 pp.
- Campbell B M, Frost P G H, Kirchmann H and Swift M J. 1994. Nitrogen cycling and management of soil fertility in small-scale farming systems in north-eastern Zimbabwe. *Agricultural Systems* (in press).
- Carter S E, Chidiambamba A, Jeranyama P, Mafukidze B, Malekala G P, Mvena Z, Mudhara M, Nabane N, Van Oosterhout S, Price L, Sithole N and Dhalimi R. 1993. *Soil fertility management in Mutoko Communal Area, Zimbabwe*. Tropical Soil Biology and Fertility Programme, Nairobi, Kenya. 78 pp.
- Castellanos J Z and Pratt P F. 1981. Mineralisation of manure nitrogen — correlation with laboratory indexes. *Soil Science Society of America Journal* 45:354–357.
- Clark M D and Gilmour J T. 1983. The effect of temperature on decomposition at optimum and saturated soil water content. *Soil Science Society of America Journal* 47:927–929.
- Coker E G, Hall J E, Carlton-Smith C H and Davies D D. 1987. Field investigations into the manurial value of lagoon-matured digested sewage sludge. *Journal of Agricultural Science (Cambridge)* 109:467–478.
- Cooper J E. 1975. Nitrification in soils incubated with pig slurry. *Soil Biology and Biochemistry* 7:119–124.
- Cornfield A H. 1952. The mineralisation of the nitrogen of soils during incubation: Influence of pH, total nitrogen, and organic matter. *Journal of the Science of Food and Agriculture* 3:343–349.
- Crane S R, Westerman P W and Overcash M R. 1981. Short-term chemical transformations following land application of poultry manure. *Transactions of the ASAE* 24:382–390.
- Debosz K S and Vinther F P. 1989. An *in situ* technique for simultaneous measurements of mineralisation, leaching, and plant uptake of nitrogen applied to agricultural soils. In: Hansen J A and Henriksen K (eds), *Nitrogen in organic wastes applied to soils*. Academic Press, London, UK. pp. 3–10.
- Dewes T, Schmitt L, Valentin U and Ahrens E. 1990. Nitrogen losses during the storage of liquid livestock manures. *Biological Wastes* 31:241–250.
- Edmeads D C, Judd M and Saarahchandra S U. 1981. The effect of lime on nitrogen mineralisation as measured by grass growth. *Plant and Soil* 60:177–186.

- Fogel R and Cromack K. 1977. Effects of habitat and substrate quality on Douglas-fir litter decomposition in Western Oregon. *Canadian Journal of Botany* 55:1632–1640.
- Foy C.D. 1984. Physiological effects of hydrogen, aluminium, and manganese toxicities in acid soil. In: Adams F (ed), *Soil acidity and liming*. American Society of Agronomy, Madison, USA. pp. 57–97.
- Freney J R, Simpson J R and Denmead O T. 1981. Ammonia volatilisation. In: Clark F E and Rosswall T (eds), *Terrestrial nitrogen cycles*. *Ecological Bulletins* 33:291–302.
- Frissel M J (ed). 1978. *Cycling of mineral nutrients in agricultural ecosystems* Elsevier, Amsterdam, The Netherlands. 356 pp.
- Giddens J and Rao A M. 1975. Effect of incubation and contact with soil on microbial and nitrogen changes in poultry manure. *Journal of Environmental Quality* 4:275–278.
- Grant P M. 1967a. The fertility of sandveld soil under continuous cultivation. I. The effect of manure and nitrogen on the nitrogen status of soil. *Rhodesia Zambia Malawi Journal of Agricultural Research* 5:71–79.
- Grant P M. 1967b. The fertility of sandveld soil under continuous cultivation. II. The effect of manure and nitrogen on the base status of the soil. *Rhodesia Zambia Malawi Journal of Agricultural Research* 5:117–128.
- Grant P M. 1981. The fertilisation of sandy soils in peasant agriculture. *Zimbabwe Agricultural Journal* 78:168–175.
- Grundy I M, Campbell B M, Balebereho S, Cunliffe R, Tafangenyasha C, Fergusson R and Parry D. 1993. Availability and use of trees in Mutanda Resettlement Area, Zimbabwe. *Forest Ecology and Management* 56:243–266.
- Guenzi W D and Beard W F. 1981. Volatile fatty acids in a redox-controlled cattle manure slurry. *Journal of Environmental Quality* 10:479–482.
- Guenzi W D, Bearde W E, Watanabe F S, Olsen S R and Porter L K. 1978. Nitrification and denitrification in cattle manure amended soil. *Journal of Environmental Quality* 7:196–202.
- Healy W B. 1968. Ingestion of soil by dairy cows. *New Zealand Journal of Agricultural Research* 11:487–499.
- Jenkinson D S. 1982. The nitrogen cycle in long term field experiments. *Philosophical Transactions of the Royal Society* 13:563–571.
- Kirchmann H. 1985. Losses, plant uptake and utilisation of manure nitrogen during a production cycle. *Acta Agriculturae Scandinavica Supplementum* 24. 77 pp.
- Kirchmann H. 1989. A 3-year N balance study with aerobic, anaerobic and fresh <sup>15</sup>N-labelled poultry manure. In: Hansen J A and Henriksen K (eds), *Nitrogen in organic wastes applied to soils*. Academic Press, London, UK. pp. 113–125.
- Loyanchan T E, Bartholomew W V and Wollum I I A G. 1976. Nitrogen transformations in aerated swine manure slurries. *Journal of Environmental Quality* 5:293–297.
- Mathers A C and Stewart B A. 1981. The effect of feedlot manure on soil physical and chemical properties. In: *Livestock waste: A renewable resource*. Proceedings of the 4th International Symposium on Livestock Wastes – 1980 held at the Amarillo Civic Center, Amarillo, Texas, 15–17 April 1980. ASAE (American Association of Agricultural Engineers), St. Joseph, Michigan, USA. pp. 159–162.
- Mathers A C and Stewart B A. 1984. Manure effects on crop yields and soil properties. *Transactions of the ASAE* 27:1022–1026.
- McGregor J. 1991. *Woodland resources: Ecology, policy and ideology*. PhD thesis, University of Loughborough, Loughborough, UK.
- McIntosh J L and Varney K E. 1972. Accumulative effects of manure and nitrogen on continuous corn and clay soil. I. Growth, yield and nutrient uptake of corn. *Agronomy Journal* 64:374–379.
- McIntosh J L and Varney K E. 1973. Accumulative effects of manure and nitrogen in continuous corn and clay soil. II. Chemical changes in soil. *Agronomy Journal* 65:629–633.
- Melillo J M, Aber J D and Muratore J M. 1982. Nitrogen and lignin control of hardwood and leaf litter decomposition dynamics. *Ecology* 63:621–626.

- Mentis M T. 1981. Direct effects of animals on pasture and veld. In: Tainton N M (ed), *Veld and pasture management in South Africa*. Shutter and Shooter, University of Natal, Natal, South Africa. pp. 299–321.
- Much R E and Steenhuis T S. 1982. Nitrogen losses from manure storage. *Agricultural Wastes* 4:41–54.
- Mugwira L M. 1984a. A review of manure fertilisation of sandveld soils in Zimbabwe. In: Avila M (ed), *Crop and livestock production research for communal areas: review of relevant research*. *Zimbabwe Agricultural Journal Special Report* 1. pp. 7–18.
- Mugwira L M. 1984b. Relative effectiveness of fertiliser and communal area manures as plant nutrient sources. *Zimbabwe Agricultural Journal* 81:85–89.
- Mugwira L M. 1985. Effects of supplementing communal area manure with lime and fertilisers on plant growth and nutrient uptake. *Zimbabwe Agricultural Journal* 81:241–250.
- Mugwira L M and Mukurumbira L M. 1986. Nutrient supplying power of different groups of manure from communal areas and commercial feedlots. *Zimbabwe Agricultural Journal* 83:25–29.
- Murwira H K. 1993. *Nitrogen dynamics in a Zimbabwean granite derived sandy soil under manure fertilisation*. PhD thesis, University of Zimbabwe, Harare, Zimbabwe. (unpublished)
- Myers R J K, Campbell C A and Weier K L. 1982. Quantitative relationship between net nitrogen mineralisation and moisture content of soils. *Canadian Journal of Soil Science* 62:111–124.
- Myers R J K, Palm C A, Cuevas E, Gunatilleke I U N and Brossard M. 1994. The synchronisation of nutrient mineralisation and plant nutrient demand. In: Woomer P L and Swift M J (eds), *The management of tropical soil biology and fertility*. Wiley-Sayce, Chichester, UK.
- Nyborg M and Hoyt P B. 1978. Effects of soil acidity and liming on mineralisation of soil nitrogen. *Canadian Journal of Soil Science* 58:331–338.
- Olsen P J, Hensler R J and Attoe O J. 1970. Effect of manure application, aeration and soil pH on soil nitrogen transformations and on certain soil test values. *Soil Science Society of America Proceedings* 34:222–225.
- Powell J M and Mohamed-Saleem M A. 1987. Nitrogen and phosphorus transfers in a crop–livestock system in West Africa. *Agricultural Systems* 25:261–277.
- Pratt P F S, Davies S and Sharpless R G. 1976. A four year field trial with animal manures. I. Nitrogen balances and yields. II. Mineralisation of nitrogen. *Hilgardia* 44:99–125.
- Raison R J, Connell M J and Khanna P K. 1987. Methodology for studying fluxes of soil mineral-N in situ. *Soil Biology and Biochemistry* 19:521–530.
- Rodel M G W, Hopley J D H and Boultonwood J N. 1980. Effects of applied nitrogen, kraal compost and maize stover on the yields of maize grown on a poor granite soil. *Zimbabwe Agricultural Journal* 77:229–232.
- Runge M. 1983. Physiology and ecology of nitrogen nutrition. In: Lange O L, Nobel P S, Osmond C B and Ziegler H (eds), *Encyclopedia of plant physiology. Vol 12C. Physiological plant ecology. III: Responses to the chemical and biological environment*. Springer-Verlag, Berlin, Germany. pp. 163–200.
- Saunders D H and Grant P M. 1962. Rate of mineralisation of organic matter in cultivated Rhodesian soils. *Transactions and Communications IV and V International Soil Science Society* 235–239.
- Schleich K. 1986. The use of cattle dung in agriculture. *Natural Resources and Resource Development* 23:53–87.
- Scoones I C. 1990. *Livestock populations and the household economy: A case study from southern Zimbabwe*. PhD thesis, University of London, London, UK.
- Shumba E M. 1986a. A comparison of maize and groundnut husbandry practices under communal area production. *Zimbabwe Agricultural Journal* 83:137–140.
- Shumba E M. 1986b. Farmer maize production practices in a high potential communal area environment: implications for research. *Zimbabwe Agricultural Journal* 83:175–179.
- Sims J T. 1986. Nitrogen transformations in a poultry manure amended soil: Temperature and moisture effects. *Journal of Environmental Quality* 15:59–63.
- Singh R K, De R and Turkhedde B B. 1986. Time of application of farmyard manure, and fertiliser nitrogen on the growth, yield and nutrient uptake of dryland wheat. *Journal of Agricultural Science (Cambridge)* 106:7–15.

- Sinha M K, Sinha D P and Sinha H. 1977. Organic matter transformations in soils. V. Kinetics of carbon and nitrogen mineralisation in soils amended with different organic materials. *Plant and Soil* 46:579–590.
- Stojanovic B J and Broadbent F E. 1956. Immobilisation and mineralisation rates of nitrogen during decomposition of plant residues in soil. *Soil Science Society of America Proceedings* 20:213–218.
- Swift M J. 1984. Biological processes and tropical soil fertility: A proposal for a collaborative programme of research (TSBF 1). *Biology International*. Special Issue 5.
- Swift M J, Heal O W and Anderson J M. 1979. *Decomposition in terrestrial ecosystems*. Studies in Ecology Vol. 5. Blackwell Scientific Publications, Oxford, UK.
- Swift M J, Frost P G H, Campbell B M, Hatton J C and Wilson K B. 1989. Nitrogen cycling in farming systems derived from savanna. In: Clarholm M and Bergstrom L (eds), Ecology of arable land. *Development in Plant and Soil Sciences* 39:63–67. Kluwer Academic Publishers, Dordrecht, The Netherlands.
- Tanner P D and Mugwira L M. 1984. Effectiveness of communal area manures as sources of nutrients for young maize plants. *Zimbabwe Agricultural Journal* 81:31–35.
- Topps J J and Manson J L. 1967. The value of maize stover after early harvesting of grain. *Rhodesia Zambia Malawi Journal of Agricultural Research* 5:191–192.
- Tothill J C and Mott J J. 1985. *Ecology and management of the world's savannas*. Australian Academy of Sciences, Canberra, Australia and CABI (Commonwealth Agricultural Bureaux International), Farnham Royal, UK. 384 pp.
- Trounce J M, Tanner P D and Mandiringana O T. 1985. The effect of compound fertiliser, manure and nitrogen top-dressing on maize grown on communal area vleis soils. *Zimbabwe Agricultural Journal* 82:199–203.
- UNESCO (United Nations Educational, Scientific and Cultural Organization). 1979. *Tropical grazing land ecosystems*. UNESCO, Paris, France. 655 pp.
- van Fassen H G and van Dijk H. 1987. Manure as a source of nitrogen and phosphorus in soils. In: van der Meer H G, Unwen R J, van Dijk T A and Ennik G C (eds), Animal manure on grassland and fodder crops: Fertiliser or waste? *Development in Plant and Soil Sciences* 30:27–45. Martinus Nijhoff Publishers, Dordrecht, The Netherlands.
- van Fassen H G and van Dijk H. 1987. Manure as a source of nitrogen and phosphorus in soils. In: van der Meer H G, Unwen R J, van Dijk T A and Ennik G C (eds), *Animal manure on grassland and fodder crops: Fertiliser or waste?* Development in Plant and Soil Sciences Vol. 30. Martinus Nijhoff Publishers, Dordrecht, The Netherlands. pp. 27–45.
- van Vuuren A M and Meijs J A C. 1987. Effects of herbage composition and supplement feeding on the excretion of nitrogen in dung and urine by grazing dairy cows. In: van der Meer H G, Unwen R J, van Dijk T A and Ennik G C (eds), Animal manure on grassland and fodder crops: Fertiliser or waste? *Development in Plant and Soil Sciences* 30:17–25. Martinus Nijhoff Publishers, Dordrecht, The Netherlands.
- Weinmann H. 1955. The nitrogen content of rainwater in Southern Rhodesia. *South African Journal of Science* 51:82–84.
- Woomer P L and Swift M J (eds). 1994. *The biological management of tropical soil fertility*. Wiley-Sayce, UK.

# Faecal excretion by ruminants and manure availability for crop production in semi-arid West Africa

*S. Fernández-Rivera,<sup>1</sup> T.O. Williams,<sup>1</sup> P. Hiernaux<sup>1</sup> and J.M. Powell<sup>2</sup>*

1. International Livestock Centre for Africa (ILCA), Semi-arid Zone Programme  
ICRISAT-SC, BP 12404, Niamey, Niger
2. 458 Glenway Street, Madison WI 53711, USA (formerly with ILCA)

## Abstract

Livestock manure is an important source of nutrients for crop production in semi-arid West Africa. An assessment of the potential of manure to sustain crop production calls for an estimation of the amounts of manure that could be produced and captured and the feed resources required to maintain livestock used for manuring. This paper presents estimates of the amounts of manure produced by cattle, goats and sheep fed *ad libitum* under confinement. A model is presented to predict the yearly faecal output by grazing ruminants under fluctuating feed supplies. Statistics on livestock population and cultivated areas are used to evaluate the effects of livestock to cropped area ratios and the spatial location of livestock at manuring time, on the potential amounts of manure available for crop production. The number of cattle, sheep and goats needed to manure different proportions of a 10-ha farm and the amounts of feed required for herds used for manuring are estimated. Model results indicate that the potential of manure to continuously sustain crop production in semi-arid West Africa is limited by livestock population, spatial location of livestock at manuring time, manure excretion per animal, efficiency of manure collection, and the amounts of feed and land resources available. Since the relative importance of these limiting factors and the possibilities for realising this potential vary both spatially and temporally, it is suggested that these technical factors should be taken into consideration when evaluating the potential of manure to support crop production at national, regional, or farm level.

## Les matières fécales des ruminants et le fumier dans la production agricole dans la zone semi-aride de l'Afrique de l'Ouest

*S. Fernández-Rivera,<sup>1</sup> T.O. Williams<sup>1</sup>, P. Hiernaux<sup>1</sup> et J.M. Powell<sup>2</sup>*

1. Centre international pour l'élevage en Afrique (CIPEA), Programme de la zone semi-aride  
ICRISAT-SC, B.P. 12404, Niamey (Niger)
2. 458 Glenway Street, Madison WI 53711 (E.-U.) (précédemment en service au CIPEA)

## Résumé

*Le fumier est une source importante d'éléments nutritifs dans la production agricole dans la zone semi-aride de l'Afrique de l'Ouest. Pour évaluer son potentiel à promouvoir la durabilité de la production agricole, il faut en connaître les quantités qui peuvent être produites et récupérées ainsi que celles du fourrage requis pour nourrir le bétail nécessaire à la production dudit fumier. Cet article présente des estimations des quantités de fumier produites par les bovins, ovins et caprins alimentés ad libitum à l'étable. Un modèle a été utilisé pour prévoir les quantités de fèces éliminées par un ruminant élevé sur des pâturages à disponible fourrage variable. Les effectifs animaux et les superficies cultivées ont été utilisés pour évaluer l'effet du rapport population animale/superficies cultivées et de la distribution spatiale des animaux pendant la fumure, sur les quantités potentielles de fumier utiles à la production agricole. Les effectifs de bovins, d'ovins et de caprins nécessaires à la fumure de diverses proportions d'une exploitation de 10 ha et les quantités de fourrage requises*

pour leur alimentation ont été estimés. Il ressort des résultats de l'application du modèle que la capacité du fumier à assurer la durabilité de la production agricole dans la zone semi-aride de l'Afrique de l'Ouest dépend de la densité de la population animale, de la distribution spatiale des animaux pendant la fumure, de la quantité de matières fécales éliminées par animal, de l'efficacité de la collecte du fumier, du volume d'aliments du bétail et de la superficie des terres disponibles. Etant donné que l'importance relative de ces facteurs limitants et la possibilité de réaliser le potentiel de fumure varient à la fois dans l'espace et dans le temps, il est proposé de tenir compte de ces paramètres techniques dans l'évaluation du potentiel du fumier à promouvoir la production agricole à l'échelle d'un pays, d'une région ou d'une exploitation.

## Introduction

The importance of livestock faeces as sources of soil nutrients for crop production in semi-arid West Africa (SAWA) has been widely recognised (Sandford, 1989; McIntire et al, 1992; Powell and Williams, 1993). However, much controversy still exists about whether sufficient livestock, manure and feed resources are available in SAWA to continuously sustain crop production. An assessment of the potential of manure to support crop production in the long term demands an estimation of the amounts of faeces excreted by ruminants as well as those that could be collected. Since the use of manure to maintain soil fertility is based on transferring plant nutrients from rangelands to croplands (Sandford, 1989), estimating the feed and land resources required to maintain livestock used for manuring is also in order.

This paper reviews the amounts of manure (faeces) excreted by cattle, goats and sheep fed *ad libitum*. With the use of a simulation model faecal outputs by ruminants grazing under fluctuating feed supplies and the amounts of manure that could be captured by farmers are predicted. The number of animals and the amount of feed and rangeland needed to manure different proportions of a 10-ha farm are estimated for a wide range of animal and land productivity scenarios.

## Faecal output by confined ruminants fed *ad libitum*

Most published data on faecal excretion by ruminants have been obtained with animals fed *ad libitum* under confinement. Several authors have assumed that under free access to feed, ruminants excrete a constant amount of faeces per unit of live (W) or metabolic ( $W^{0.75}$ ) weight. Conrad et al (1964) found that dairy cows excreted 10.7 g DM faeces/kg W and indicated that this output was constant over a wide range of digestibilities. In the model developed by Kahn and Spedding (1984) a constant faecal output of 10.7 g DM/kg W was assumed. Konandreas and Anderson (1982) estimated that the potential faecal dry-matter (DM) output (F, g/day) of cattle could be predicted by the equation:

$$F = f W^{0.75}$$

where:

$f$  (g DM/kg  $W^{0.75}$ ) is a constant that depends on the physiological stage of the animals.

The same authors estimated values for  $f$  of 42, 45 and 49 for dry, pregnant and lactating cows, respectively, and suggested that these estimates could be used for feeds in a range of digestibilities from 42 to 65%. However, some experimental evidence suggests that  $f$  decreases as feed digestibility increases (Katelaars, 1986).

Since there is a mathematical relationship between apparent digestibility, feed intake and faecal output, the faecal excretion can be estimated from digestion trials data published in the literature. In this study literature data including 251 diets given to cattle, 247 diets given to sheep and 139 diets given to goats were analysed. Feeds used in the studies were primarily crop residues and tropical grasses, with no or low levels of supplementary concentrates or legume hays. A small proportion of feeds were leaves and fruits of fodder trees. Animal breeds from tropical and temperate climates were

included in the survey, and in the case of small ruminants, dwarf breeds were also included. Although this literature survey was far from being exhaustive, it included a considerable number of diets with a wide range of digestibilities (Table 1).

**Table 1.** Faecal excretion by cattle, sheep and goats given ad libitum access to feed.

	Cattle	Sheep	Goats
No of diets <sup>1</sup>	251	247	139
Live weight, kg			
Minimum	81	10	6
Maximum	665	83	68
Mean	300	37	22
DM digestibility, g/kg			
Minimum	345	243	312
Maximum	841	813	830
Mean	579	549	578
Faeces, g DM/day			
Minimum	764	39	32
Maximum	7222	898	560
Mean	2383	345	197
sd	966	140	100
Faeces, g DM/kg W			
Minimum	3.7	1.8	2.1
Maximum	16.2	22.0	20.2
Mean	8.5	9.7	10.1
sd	2.6	3.3	3.9
Faeces, g DM/kg W <sup>0.75</sup>			
Minimum	17.2	4.3	5.2
Maximum	64.0	50.5	43.9
Mean	34.1	23.3	20.7
sd	9.4	7.7	7.2

1. Each diet given to four to eight animals.

sd = standard deviation.

A great variation in faecal outputs was observed (Table 1). To allow for comparisons with literature data, faecal excretion is expressed in relation to W and W<sup>0.75</sup>. Mean faecal excretion was 8.5, 9.7 and 10.1 g DM per kg W and 34.1, 23.3 and 20.7 g DM/kg W<sup>0.75</sup> for cattle, sheep and goats, respectively. However, a regression analysis of faecal excretion (F, g DM/day) on W (kg), using log transformed data of both F and W, revealed that for a wide range of sizes the amount of faeces is related non-linearly

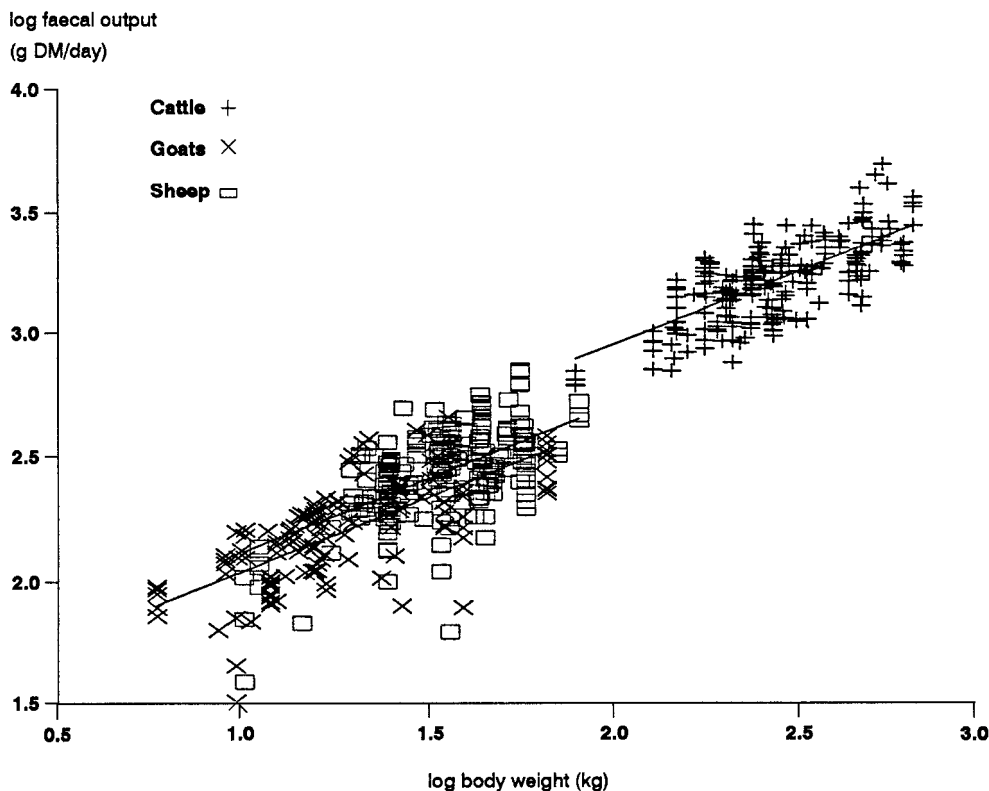
**Figure 1.** Relationship between body weight and daily faecal excretion by cattle, sheep and goats.

to  $W$ . Since no differences in slope across species were detected, these results suggest that this relationship is similar in the three species. The estimated regression equation (Figure 1) was:

$$\begin{aligned}
 &1.773 (\pm 0.069) \text{ for cattle} \\
 &\log F = 1.423 (\pm 0.038) \text{ for goats} + 0.645 (\pm 0.028) \log W \\
 &1.505 (\pm 0.044) \text{ for sheep} \\
 &(P < 0.01, r^2 = 0.92)
 \end{aligned}$$

The estimates of faecal excretion coefficients as a function of  $W$  would therefore be  $59.2 \pm 1.2$  g DM/kg  $W^{0.645}$  for cattle,  $32.0 \pm 1.1$  g DM/kg  $W^{0.645}$  for sheep and  $26.5 \pm 1.1$  g DM/kg  $W^{0.645}$  for goats. The inclusion of dry-matter digestibility (DMD, g/kg) in the model changed slightly the slope and indicated that the faecal output per unit weight decreases as digestibility increases. According to this analysis, the effect of DMD on faecal output is lowest in cattle, intermediate in sheep and highest in goats. The estimated regression equation was:

$$\begin{aligned}
 &2.000 (\pm 0.082) \text{ for cattle} - 0.0003 (\pm 0.00009) \text{ DMD for cattle} \\
 &\log F = 1.857 (\pm 0.071) \text{ for goats} + -0.0007 (\pm 0.00010) \text{ DMD for goats} \\
 &1.825 (\pm 0.065) \text{ for sheep} - 0.0005 (\pm 0.00009) \text{ DMD for sheep} \\
 &+ 0.623 (\pm 0.027) \log W, (P < 0.01, r^2 = 0.93)
 \end{aligned}$$

The excretion of faeces per kg  $W^{0.645}$  across digestibilities was highly variable (Figure 2). Similar trends were observed for cattle by Mertens (1973, cited in Katelaars, 1986) and for sheep by Katelaars and Tolcamp (1991). Feed DMD appeared to determine the maximum amount of faeces excreted per kg  $W^{0.645}$  (Figure 2). When no other terms were included in the model, the linear and quadratic effects

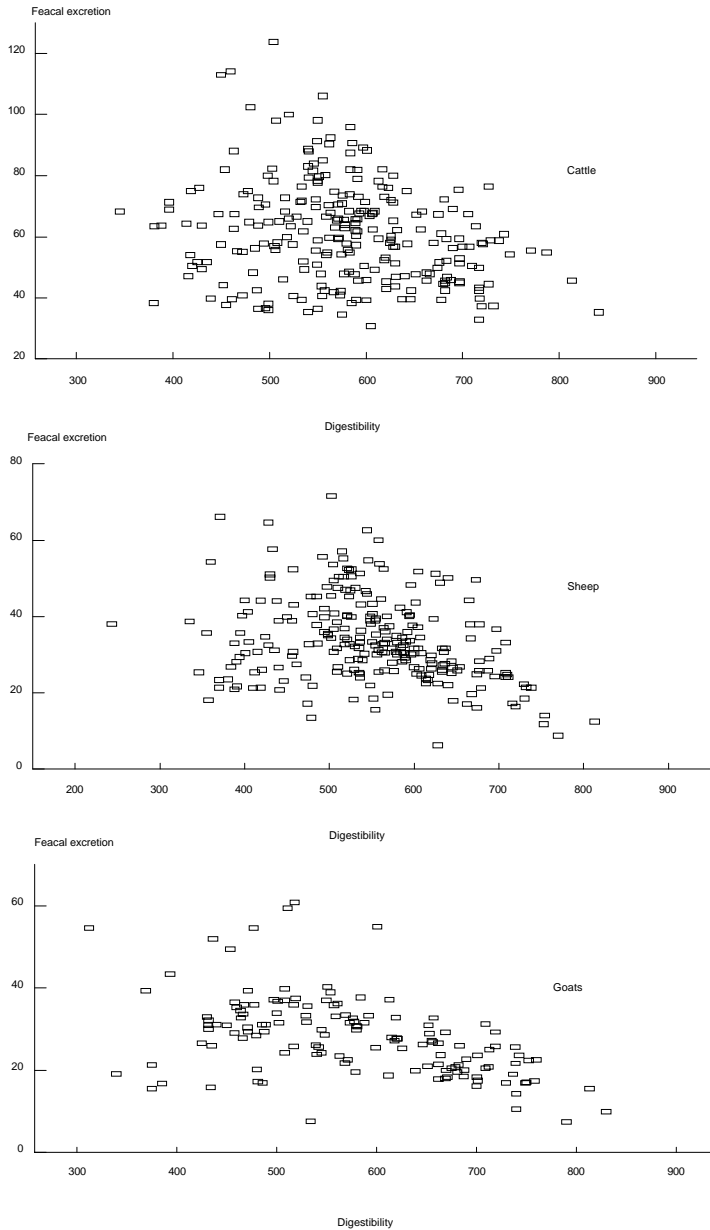

**Figure 2.** Relationship between digestibility and daily faecal excretion by cattle, sheep and goats.

of DMD explained only 0.09 of the variation in faecal output per kg  $W^{0.645}$  in cattle, 0.18 in sheep and 0.30 in goats. Further analysis showed a significant decrease in faeces excreted per kg  $W^{0.645}$  in the three species as DMD increased above 55%.

Intake (linear effect) explained 46% of the variation of faecal output in cattle, 63% in sheep and 37% in goats. In the three animal species, daily faecal output ( $F'$ , g DM per kg  $W^{0.645}$ ) increased linearly as daily DM intake (DMI, g per kg  $W^{0.75}$ ) increased (Figure 3) according to the equations:

$$F' = 21.3(\pm 2.9) + 0.479(\pm 0.033) \text{ DMI}, (P < 0.01, r^2 = 0.46) \text{ for cattle}$$

$$F' = 8.1(\pm 2.3) + 0.397(\pm 0.044) \text{ DMI}, (P < 0.01, r^2 = 0.37) \text{ for goats}$$

$$F' = 5.6(\pm 1.4) + 0.534(\pm 0.026) \text{ DMI}, (P < 0.01, r^2 = 0.63) \text{ for sheep}$$

**Figure 3.** Relationship between daily feed intake ( $\text{g DM/kg } W^{0.75}$ ) and daily faecal excretion ( $\text{g DM/kg } W^{0.645}$ ) by cattle, sheep and goats.

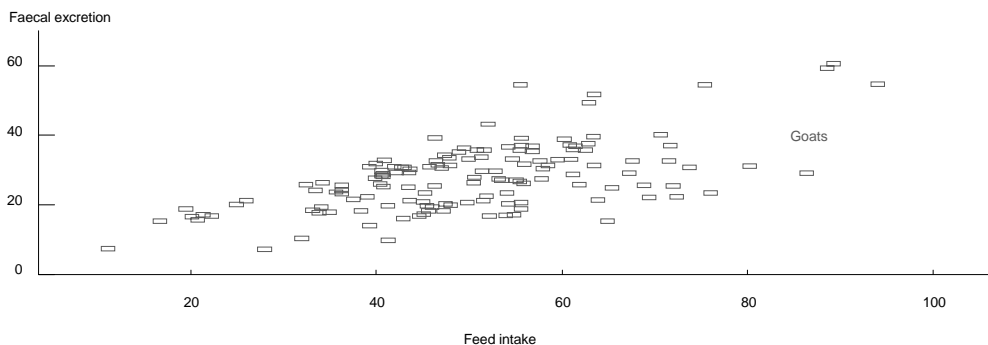
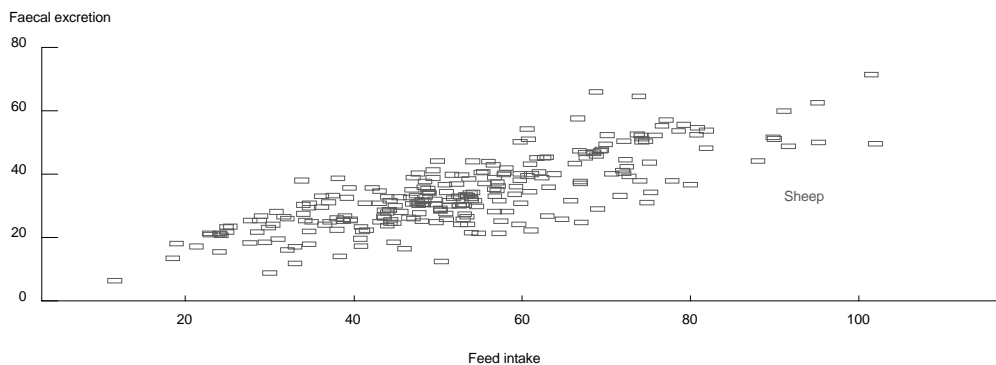
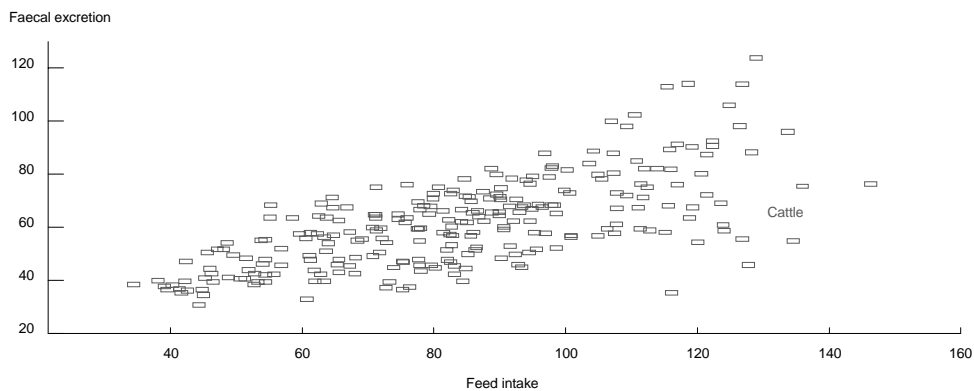

The relationship between intake and faecal output supports the hypothesis that within the range of intakes considered, the capacity of the digestive tract to handle the undigested feed residues does not limit feed intake (Van Soest, 1982).

Predicting faecal output of confined livestock becomes relevant since stall feeding is expected to increase as demographic pressure causes more land to be cultivated and reduces natural grazing land in SAWA (Winrock International, 1992). The relationships presented above could be used, with varying levels of precision, to predict the faecal excretion of confined ruminants fed *ad libitum*, when feed intake, digestibility or both are unknown. However, intake and digestion studies are usually

conducted with males in good body condition. Caution should be exercised when predicting the faecal output of animals in extreme body condition or females in gestation or lactation. In cattle, faecal output per unit of live weight was found to be affected by body condition (Barlow et al, 1990), physiological status (Konandreas and Anderson, 1982) and genotype (Lambourne et al, 1986; Barlow et al, 1990). The influence of anti-nutritional factors, e.g. tannins, on feed intake and digestibility should also not be ignored. In the set of data analysed, intake of and faecal output from diets known to contain such compounds were extremely low.

## A model of faecal output by grazing ruminants

Under traditional practices in SAWA animals used for manuring graze during the day and are corralled overnight for manure collection. Although some authors (e.g. Ellis, 1978) have considered that the maximum faecal output by grazing cattle is constant and similar to that of confined animals, several studies in SAWA have shown that during the wet season the amount of faeces excreted by cattle can be as high as 18 g DM/kg W (Dicko and Sangaré, 1985; Diarra et al, 1993). The discrepancies could be due to the differences in feed digestibility and/or in the body condition of the animals, which would lead to large differences in feed intake per unit weight. Grazing animals in SAWA are also subject to extreme seasonal variations in feed supplies and quality. Although grazing animals have free access to feed, often feed availability may limit intake. For this reason the faecal excretion by grazing ruminants is likely to differ from that of animals fed *ad libitum* under confinement.

Digestibility and amounts of feed consumed by grazing ruminants in SAWA have been reported by Dicko and Sangaré (1985), Guerin (1987), Mahler (1990), Diarra et al (1993) and Schlecht et al (this volume), but the information available on these variables is still very limited.

For the objectives of this study, a model was developed to predict the amounts of faeces produced by cattle, sheep and goats grazing under fluctuating feed supplies. The basic model assumes that growth rates reflect feed availability and digestibility. Inputs for the model are W, average daily gain (ADG, g) and feed DMD. In the model, metabolisable energy (ME) required for maintenance (ME<sub>m</sub>) and growth (ME<sub>g</sub>) are predicted for cattle and sheep from MAFF (1984) and for goats from NRC (1981). ME<sub>m</sub> is adjusted to account for ME needs for walking and grazing. Consumption of digestible organic matter (DOMI) is estimated from ME and that of digestible DM (DDMI) from DOMI and concentration of OM. Faecal output and DM intake are then predicted from DMD and DDMI.

The sensitivity of the model to variations in ADG and DMD for 300-kg cattle, a 35-kg sheep and a 25-kg goat, when ME<sub>m</sub> were increased 50% due to grazing is shown in Figure 4. As in the case of animals fed *ad libitum* (Table 1), for a given DMD value, the predicted amount of faeces per kg W at maintenance was highest in goats and lowest in cattle. Faecal output increased as ADG increased and/or as DMD decreased. Differences among species in their response in faecal excretion to changing ADG and DMD reflect differences in the assumptions made in the prediction of nutrient requirements (NRC, 1981; ARC, 1984). Although lack of experimental data does not allow for proper validation of these model results, in general the predicted faecal outputs are in the range of values observed in grazing studies (Dicko and Sangaré, 1985; Diarra et al, 1993; Schlecht et al, this volume) in SAWA.

The model was run under three different scenarios (A, B, and C). In each scenario a yearly cycle was divided into three seasons (wet, from July to September; post-harvest, from October to January; and dry, from February to June). For the three scenarios the initial W was considered to be 175 kg for cattle, 25 kg for sheep, and 20 kg for goats. In scenario A, which emulates a low productivity level, the ADG's were considered to be 400, 50 and -300 g/d for cattle, 50, 25 and -50 g/day for sheep and 30, 20 and -20 g/d for goats, in the wet, post-harvest and dry seasons, respectively. In scenario B, which emulated an average level of productivity, the corresponding weight changes during the three seasons were assumed to be 500, 200, and -250 g/d for cattle, 70, 40, and -30 g/d for sheep, and 50, 30, and -15 g/d for goats. In scenario C, which represented a high level of animal productivity, the assumed weight changes were 600, 225, and -150 g/d for cattle, 80, 50 and -20 g/d for sheep, and 60,

**Figure 4.** Simulated daily faecal excretion (g DM/kg W) by cattle, sheep and goats at varying weight change rate (g/day) and feed DM digestibility (g/kg).

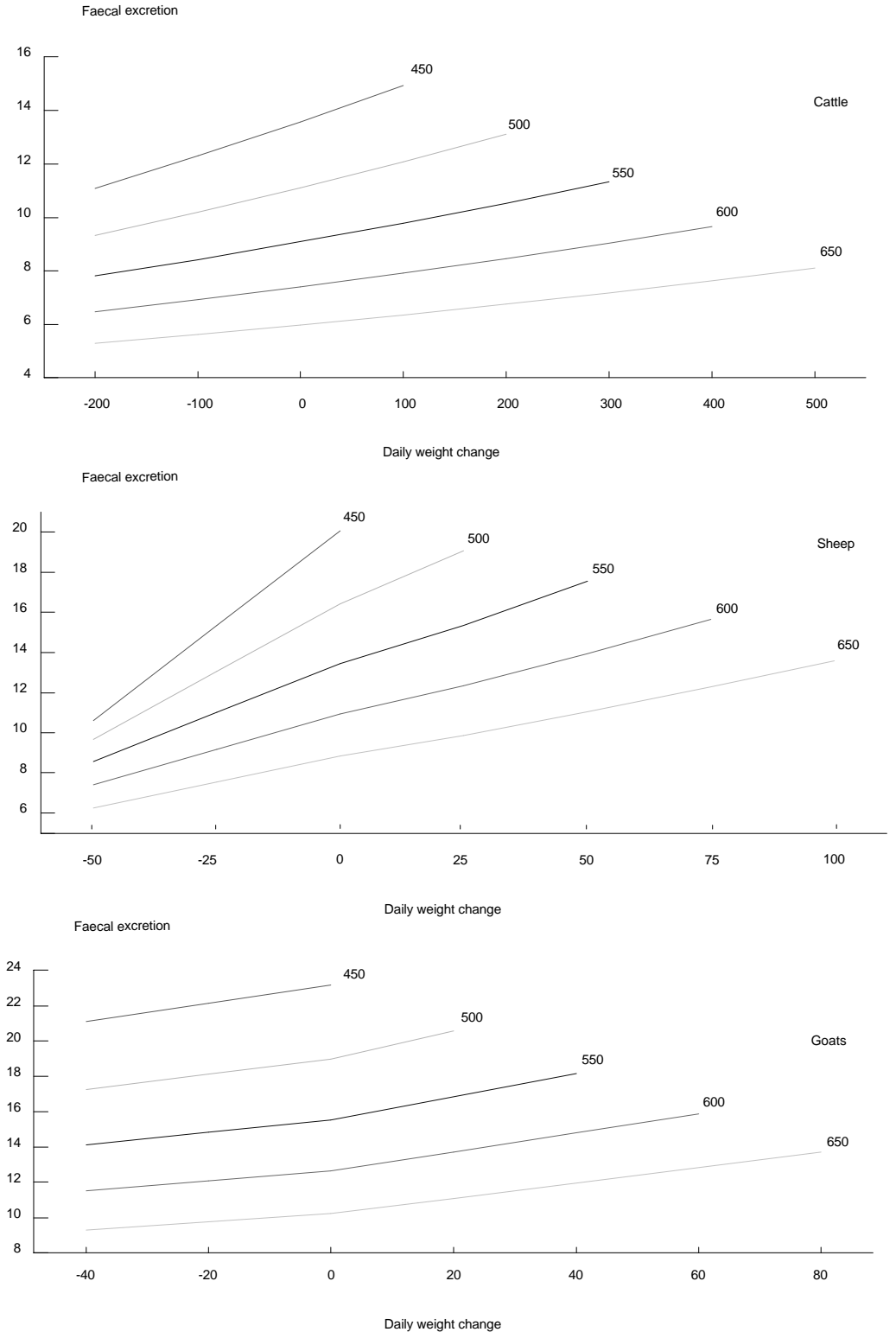

40, and 0 g/d for goats, in the wet, post-harvest and dry season, respectively. With these rates of weight change, in a one-year cycle cattle would gain -2, 33 and 60 kg, sheep would gain 0, 7, and 10 kg, and goats would gain 2.5, 6 and 10.5 kg in scenarios A, B, and C, respectively. These rates of weight change are comparable to those reported in the literature (Wilson, 1986; Mahler, 1990; Schlecht et al, this volume). The seasonal changes in DMD and extra ME required for grazing were also set arbitrarily. Extra ME used for grazing was assumed to be 50, 45 and 40% of MEM for scenarios A, B, and C, respectively. Feed DMD used as input decreased from 60 to 50% from the wet to the dry season in cattle and sheep, but that for goats was kept constant at 58%.

The simulated yearly and seasonal amounts of faeces excreted by the reference animals of the three species is given in Table 2. As the level of animal production increased, only small increases in faecal output were predicted. This is explained by the lower digestibility and higher amounts of feed used for maintenance in the lower levels of animal productivity. In scenario B the predicted amount of manure produced by individual animals during the dry season was only about 10% higher than that predicted for scenario A. Similarly, dry season faecal outputs in scenario C were only about 7% higher than those estimated for scenario B.

**Table 2.** Simulated faecal excretion by cattle, sheep and goats grazing under fluctuating feed supplies (kg DM).

	Total per year	Season		
		Wet (July–Sep)	Post-harvest (Oct–Jan)	Dry (Feb–Jun)
Scenario A				
Cattle	793	201	274	319
Sheep	155	38	56	61
Goats	124	32	45	47
Scenario B				
Cattle	884	214	317	353
Sheep	175	42	62	71
Goats	134	35	48	51
Scenario C				
Cattle	931	228	323	379
Sheep	184	44	66	75
Goats	141	36	50	56

For the three scenarios the predicted daily faecal excretion during the dry season was similar or only slightly lower than that of the wet season. In the model, the higher amount of feed used for growth in the wet season is compensated by the lower feed digestibility in the dry season. Only limited data on seasonal variations in faecal excretion were found in the literature. In Senegal, Guerin (1987) observed a higher faecal excretion by cattle in the dry season than in the wet season. Similar differences were observed in sheep in Ethiopia (Ameha, 1993). However, Dicko and Sangaré (1985) and Diarra et al (1993) observed higher faecal excretions by cattle in the wet season. Model results (Figure 4) suggest that daily faecal output during the dry season would be higher than in the wet season only if feed available in the dry season does not limit intake and is less digestible than the feed available in the wet season. Otherwise, lack of feed in the dry season would lead to decreased faecal outputs.

The seasonal variation in daily faecal output predicted by the model was much lower than that reported in the literature. For instance, in scenario B, daily faecal output through the year varied between 10.2 and 12.1 g DM/kg W, whereas Diarra et al (1993) observed variations between 8 and 18 g DM/kg W and Dicko and Sangaré (1985) between 8 and 15 g DM/kg W. The difference could be due to discrepancies between the actual extra ME (feed) needed for grazing and the one used as

input in the simulations. In spite of these differences, for the purpose of this study the predicted faecal outputs were used on the basis that the simulated values are within the range of and are similar to experimental data reported in the literature.

### Amounts of manure that could be collected from grazing ruminants

For reasons inherent in the ways animals are managed in the production systems of SAWA, farmers are unable to collect all the manure excreted by livestock. The manuring season usually extends from October to May, when manure is deposited in fields scheduled for cultivation the following year. The most common way of manure deposition is by corralling or tethering livestock during the night. During the day the animals are allowed to graze rangelands, fallows or crop residue fields.

Because of the spatial separation of manured croplands from the areas used for grazing, there is a trade-off between the time used for grazing and the time used for manuring. As animals are tethered longer in the fields for manure deposition, the time available for grazing, the amount of forage consumed and the amount of faeces excreted are expected to decrease. How long livestock can be kept on the cropping fields for manuring, without compromising feed intake, depends primarily on the distance between the fields being manured and the areas used for grazing, and on the consumption rate while grazing. Consumption rate depends, to a large extent, on the amount of forage mass per unit area (SCA, 1991). Under most common situations, it is unlikely that livestock could be used for manuring for more than 12 h/day without adversely affecting forage intake.

A second factor that influences the efficiency of manure collection is the variation in the rate of faecal excretion during the day. The rate of defecation (g of faecal DM excreted per hour) during manuring time appears to be lower than the faecal excretion rate while grazing. In a study conducted by ILCA in Niger (unpublished data) faeces were collected from sheep in metabolism crates every four hours for seven days. The rate of excretion was lowest during the night and highest during the day (Table 3). This pattern of lower faecal excretion rate during the night, i.e. when animals are resting and manuring, has also been observed in studies at ILCA-Niger (unpublished data) with grazing small ruminants early in the dry season (November) and with working and non-working oxen (A. Fall, personal communication). In Mali, Schlecht et al (this volume) observed that grazing cattle excreted 43% of the daily faecal output during the night.

**Table 3.** Faecal excretion rates (g DM/h) by sheep fed ad libitum.

Day time	Faecal excretion rate (g DM/h)	sem
0600–1000	9.9	1.6
1000–1400	13.0	0.5
1400–1800	14.4	1.8
1800–2200	8.5	1.4
2200–0200	8.2	0.5
0200–0600	10.9	2.1

sem = standard error of the mean.

Source: unpublished data (ILCA-Niger).

Since defecation by grazing animals is commonly associated with certain physical activities (e.g. getting up after having laid down, walking, watering), manure concentrates in resting sites, traveling routes and watering points.

In the model described above, it was conservatively assumed that 50% of the manure excreted between October and May could be captured during night corralling. The predicted amounts of manure that could be collected per animal are shown in Table 4. Model predictions indicated that under scenario B, 301 kg DM of manure could be collected from a reference cow, 60 kg from a reference sheep and 45 kg from a reference goat. Again, no experimental data are available for validating these predictions. However, the predicted amounts of manure collected from cattle are in the range of the very limited published data on manure collected per animal. For instance, Bosma and Jager (1992) reported that when cattle were used for manuring 14 h/day during four months only between 80 and 190 kg of manure per tropical livestock unit (TLU) were collected. In another study, Khombe et al (1992) reported that 424 kg of manure (with 41% sand) were collected annually from 170-kg steers when they were penned for 14 h/day. In manuring studies at ILCA Niger, less than 1 kg of faecal DM was collected daily from cattle (Powell, unpublished data) during night corralling. Schlecht et al (this volume) found also that less than 1 kg of faecal OM was excreted daily during the night by grazing cattle. Higher estimates of manure collected per animal were given by Berger et al (1987), who assumed levels of collection of 600 kg manure per year for 400-kg cattle, and Landais and Lhoste (1993), who reported the same levels of manure deposition per tropical livestock unit (TLU) per year. The values of manure collected per sheep predicted by the model are also similar to the values of manure excreted per night by rams and ewes (220 to 330 g DM) observed by Ameha (1993) in Ethiopia.

**Table 4.** Simulated amounts of manure collected from grazing animals (kg DM/animal).<sup>1</sup>

	Cattle	Sheep	Goats
Scenario A	267	53	41
Scenario B	301	60	45
Scenario C	314	63	47

1. Fifty per cent of faecal excretion between October and May.

## Amounts of manure available for crop production in SAWA

The amounts of manure available for crop production in a given region depend on the number of animals, the proportion of animals used for manuring, the amount of faeces excreted per animal and the ability of the farmers to collect it. In addition to the inefficiency in collecting the manure produced by an individual animal, several management practices decrease the number of animals that could be used for manuring. Variable proportions of livestock are taken on short or long transhumance during the dry season (Bourn et al, 1986). Whereas the farmer's livestock may not be available for manuring his/her own fields, he/she may collect manure from transhumant herds. The spatial location of livestock during the manuring season is thus an important factor that influences the amount of manure available for cropping. This is also determined to a large extent by the distance between the cropping fields and the non-cropped areas used for grazing during the dry season. To illustrate this, model results were used with statistics on cultivated areas and livestock population in SAWA countries.

Tables 5 and 6 show the cultivated areas, livestock population and livestock to cropped area ratios for Sahelian countries. According to FAO (1990) and ILCA (1993), a high number of animals per cultivated hectare is found only in Mauritania. However, as explained above, if livestock are not located near the cropping fields during the dry season, not all animals are available for manuring. According to these statistics, Burkina Faso, Senegal, and especially Niger have the lowest numbers of livestock per hectare of cultivated land.

If all animals were used for manuring, the model predicts that Chad, The Gambia and Mali would have between 1200 and 1600 kg of manure/ha, Senegal and Burkina Faso between 450 and 650 kg/ha,

and Niger about 300 kg/ha (Table 6). The weighted mean for all countries would be less than 700 kg of manure/ha. These figures are mean values, i.e. they assume that all cultivated areas are manured every year at a constant rate. In addition, livestock movements across countries occur (Bourn et al, 1986) and validity checks of statistics on cultivated areas and livestock population are not readily available. For these reasons these figures can only be considered as gross aggregated estimates of potential manure availability. Powell and Williams (1993) indicated that farmers in western Niger manure about one third of their fields every year. On the other hand, on-farm trials evidence suggests that between three and seven tonnes of manure are needed per hectare every other year to replenish the nutrients taken up through grain and stover removal (Williams et al, this volume). At a rate of manure application of three tonnes/ha, and with 80% of the livestock population used for manuring, the amounts of manure available would be sufficient for manuring every year 33 to 42% of the cultivated area in Mali, Chad, and The Gambia, 12 to 18% in Burkina Faso and Senegal, and only 8% in Niger. The aggregated value for all countries would be 18%. These estimates decrease as the proportion of livestock taken on transhumance during the dry season, that would not be available for manuring, increases (Figure 5).

**Table 5.** *Cultivated areas and livestock population of Sahelian countries.*

Country	1000 ha <sup>1</sup>		1000 animals <sup>2</sup>		
	Millet	Sorghum	Cattle	Sheep	Goats
Burkina Faso	1278	1362	2754	2885	5047
Chad	400	500	4002	2175	2175
The Gambia	59	14	300	195	200
Mali	980	600	4589	5300	5200
Mauritania	15	149	1200	4000	3150
Niger	3385	1566	3400	3500	7500
Senegal	977	127	1543	3700	1130
Total	7094	4318	17788	21755	24402

1. 1989.

2. 1987.

Sources: FAO (1989) and ILCA (1993).

**Table 6.** *Tropical livestock units (TLU) per cultivated hectare and potential amount of manure collected in Sahelian countries.*

Country	TLU/ha	Manure
Burkina Faso	1.03	465
Chad	3.60	1593
The Gambia	3.42	1521
Mali	2.70	1223
Mauritania	9.48	4524
Niger	0.70	317
Senegal	1.42	668
Weighted mean	1.50	679

1. Estimated considering that all animals are used for manuring and the amounts of manure collected per animal as in scenario B.



**Figure 5.** Simulated percentages of the cultivated land that could be manured under different livestock: cropland ratios and proportions of livestock on transhumance during the dry season.

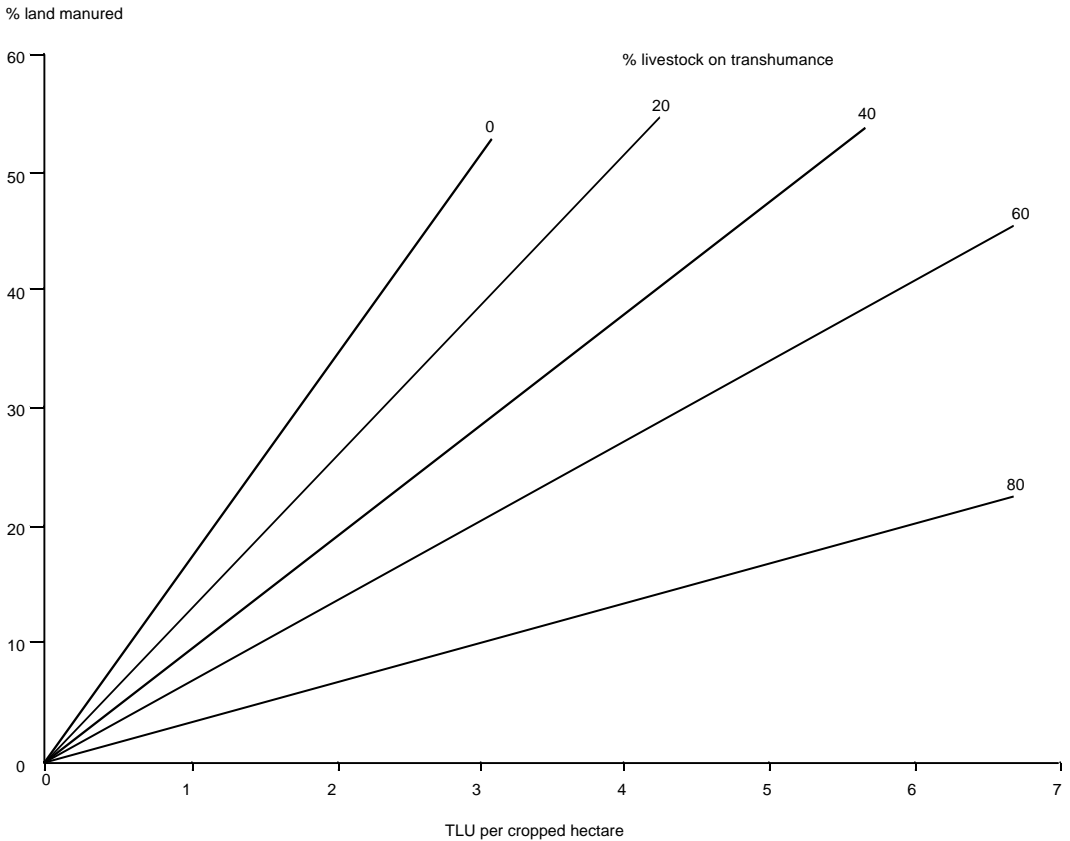

### Feed consumed by livestock used for manuring

Livestock holders of SAWA do not keep animals only for manuring, but for a variety of purposes. Thus the amounts of feed consumed by animals used for manuring cannot be charged solely against manure production. However, since most of the manure nutrients are of feed origin, the amounts of feed consumed during both manuring and non-manuring seasons need to be considered in the nutrient balance. As indicated above, the information on feed consumption by grazing animals in SAWA is quite limited. In the present study, the model used to predict the excretion of faeces by livestock was also used to estimate the amounts of feed consumed in the three scenarios of animal productivity (A, B and C) as described above. The simulated amounts of feed consumed per animal are shown in Table 7. Since as the level of productivity increased, feed digestibility was assumed to be higher and the metabolisable energy needed for grazing was assumed to decrease due to higher feed availability, the amounts of feed consumed per animal increased only slightly as the simulated scenario changed from A to B and from B to C.

Assuming a cattle:goat:sheep ratio of 1:2:1 (approximately the ratio in Niger), the amounts of feed consumed by livestock needed to manure one hectare at a rate of 3000 kg/ha were estimated (Table 8). Regardless of the level of animal productivity, the model predicted that about 20 tonnes of feed DM will be consumed by livestock in order to capture three tonnes of manure. The low efficiency is due to the feed consumed during the non-manuring season (June to September) and the inefficiency (50%) of manure collection during the manuring season (October to May).

**Table 7.** Simulated amounts of feed consumed by cattle, sheep and goats (kg DM per animal).

	Total per year	Season		
		Wet Jul–Sep	Post–harvest Oct–Jan	Dry Feb–Jun
Scenario A				
Cattle	1747	501	608	630
Sheep	352	95	129	120
Goats	295	77	106	112
Scenario B				
Cattle	1944	534	704	706
Sheep	398	105	145	148
Goats	319	83	114	122
Scenario C				
Cattle	2047	570	719	758
Sheep	418	109	153	156
Goats	337	85	119	133

**Table 8.** Number of animals and feed needed for manuring one hectare at 3000 kg DM/ha assuming a cattle: goats: sheep ratio of 1:2:1.<sup>1</sup>

	Scenario A	Scenario B	Scenario C
Animals			
Cattle	7.5	6.7	6.4
Sheep	7.5	6.7	6.4
Goats	14.9	13.3	12.7
Feed, kg DM/year			
Cattle	13032	12946	13007
Sheep	2629	2650	2656
Goats	4400	4248	4278
Total	20061	19844	19940

1. Manuring season extends from October to May.

## Land resources required for feed production

Experimental data have shown that only small amounts of manure are deposited in croplands during *in-situ* grazing after grain harvest (ICRISAT, 1993) and that most of the nutrients captured through manuring are transferred from rangelands (Sandford, 1989). Therefore the question of how many hectares of rangeland are needed to sustain one hectare of cultivated land through manuring arises. Because livestock and rangelands are not exploited only for the purpose of manuring, estimating rangeland to cropland ratios (RCR) needed to produce a given amount of manure is only meaningful in the sense that it provides an approach for evaluating the potential of manure to sustain crop production without other external sources of soil nutrients. On this basis, the number of hectares of rangeland needed to manure one hectare of cultivated land were estimated in this study.

The RCR required to sustain the long-term productivity of crops has been estimated by several researchers. For instance, Sandford (1989) found that between 16 and 47 ha of grazing are required to sustain maize production at a yield of 1 to 3 tonnes/ha if grazing animals are used and between 2 and 17 if confined animals are used. The large variation in RCR required is not surprising, given the number of factors that influence the RCR required (Turner, this volume). It can be expected that the RCR needed to ensure the long-term productivity of crops vary from region to region, from village to village and from farm to farm. This paper contends that productivity of croplands and rangelands is the single most important factor that influences the RCR needed to sustain crop productivity using manure. Since there is also a large inter-annual variation in primary production of rangelands (Hiernaux, 1993), RCR need to take into account the long-term mean productivity of rangelands. Furthermore, the RCR needed would depend on the amount (kg/ha) of plant mass actually consumed by livestock in the rangelands rather than on the levels of primary production.

To illustrate the influence of land productivity on RCR, the model was run under three scenarios (X, Y and Z) covering a wide range of primary production of cultivated and uncultivated land. The levels of land productivity and feed consumed per ha assumed in each scenario are shown in Table 9.

**Table 9.** Feed production assumed in simulations (kg DM/ha).

	Land productivity scenarios		
	Scenario X	Scenario Y	Scenario Z
Feed yield from crops			
Unmanured fields	500	1500	2000
Manured fields	1200	2000	3000
Feed in rangeland at end of wet season	500	1500	3000
Consummable feed			
Manured cropland	400	1050	1200
Unmanured cropland	960	1400	1800
Rangeland, dry season	200	500	800

The wide range of primary production considered (500, 1500 and 3000 kg DM/ha per year for scenarios X, Y and Z, respectively) is justified by the large spatial and temporal variations observed in the annual production of Sahelian rangelands (Grouzis, 1988; Hiernaux, 1993). During the dry season, standing hay (primarily from annual plants) and litter constitute most of the fodder on offer. However, only a fraction of the standing mass is available to livestock grazing during the dry season because of microbial decomposition, consumption by insects (termites and ants), and other losses. High proportions of the vegetative mass may disappear over the season due to higher rates of degradation early and late in the season (Hiernaux, 1989). When grazing is spread equally over the season, only about 2/3 of the initial vegetation mass may be available to the animals. In addition, there are losses of forage mass due to trampling, which speeds up the decomposition of organic matter and soil erosion. Since these losses increase as the above-ground vegetation mass increases, it was assumed that 0.4, 0.5 and 0.6 of the forage available to the animals would be lost to trampling in the scenarios X, Y and Z, respectively. Thus from initial standing masses of 500, 1500 and 3000 kg D/ha per year, only 200, 500 and 800 kg DM/ha were assumed to be consumed by livestock in the scenarios X, Y and Z, respectively.

When livestock graze during the growing season, forage growth is affected. The response of plants to defoliation through grazing is a function of the intensity and the frequency of the defoliation (Hiernaux and Turner, unpublished data). The higher the grazing pressure, the more the subsequent

growth is affected. The response is also influenced by time of defoliation. For instance, grasses are more sensitive if defoliated at heading time (Oosterheld and McNaughton, 1991).

In the model, the impact of wet-season grazing was accounted for by adding to total feed intake a fraction of the potential production (Grazef) of the range calculated with the following function:

$$\text{Grazef} = \text{maxef} * (1 + (\text{maxef}/2) * e^{(-6 * (\text{TLU} * 500 / \text{PPP}))})$$

where:

maxef = maximum rate of reduction of the production

TLU = stocking rate (TLU/ha) during the rainy season

PPP = potential primary production in kg DM/ha.

In the model, maxef varies with the level of primary production and is equal to:

0.4 at PPP = 500 kg DM/ha per year

0.5 at PPP = 1500 kg DM/ha per year

0.6 at PPP = 3000 kg DM/ha per year

The impact of wet-season grazing is assessed in terms of feed production, which is then converted to area of rangeland on the basis of the potential production. This area is added to the area required to provide the dry season feed. In the model, feed resources for the dry season include rangeland and crop residues produced by both manured and non-manured fields (Table 9).

The model was run for a 10-ha farm varying the proportion of cultivated land manured. The number of hectares of rangeland required by this farm for dry season grazing, in the three levels of land productivity (X, Y and Z) is shown in Figure 6. As expected the estimated RCR needed by the 10-ha farm are highly variable. However, because of the small differences in the total amount of feed needed under the three scenarios of animal productivity (A, B and C) for manuring one hectare, the estimated RCR for these scenarios are very similar.

Clearly, the number of hectares of rangeland required by the 10-ha farm for capturing a given amount of manure depends largely on the productivity of the land and are less affected by livestock productivity. The model also predicted that, relative to the low levels of animal productivity, the same amount of manure could be obtained with a lower number of more productive animals grazing at lower stocking rates.

The rangeland areas shown in Figure 6 would provide, with the crop residues (Table 9), the feed needs in the 10-ha farm during the manuring (October to May) season. These areas should be located near the farm, i.e. within walking distance from the cropping land.

Additional rangeland areas would be required to sustain livestock during the non-manuring (June to September) season. However, these areas could be located either near the farm, if manuring animals are sedentary, or in other areas, if they leave the farm during the wet season. Animals used for manuring can be owned either by the farmers or by pastoralists. Livestock owned by farmers can be sedentary or leave on short transhumance during the wet season if wet season grazing is not available. Pastoralists' livestock usually return to the dry non-cultivated zones early in the wet season.

The estimated rangeland areas needed for wet season grazing are shown in Figure 7. These areas are smaller than those required for the manuring season. As the level of animal productivity decreases (scenario A) more animals would be needed for manuring (Table 8). This would lead to a slightly higher feed demand during the wet season and a higher grazing impact on forage growth. Therefore, in scenario A, more land is needed for wet season grazing than in scenarios B and C. As in the case of rangeland needs for dry season grazing, the higher the land productivity the lower the need for rangeland.

**Figure 6.** Rangeland required for dry-season grazing (October–May) by a 10-ha farm for manuring different areas of cropland under different scenarios of animal (A, B, C) and land (X, Y, Z) productivity.

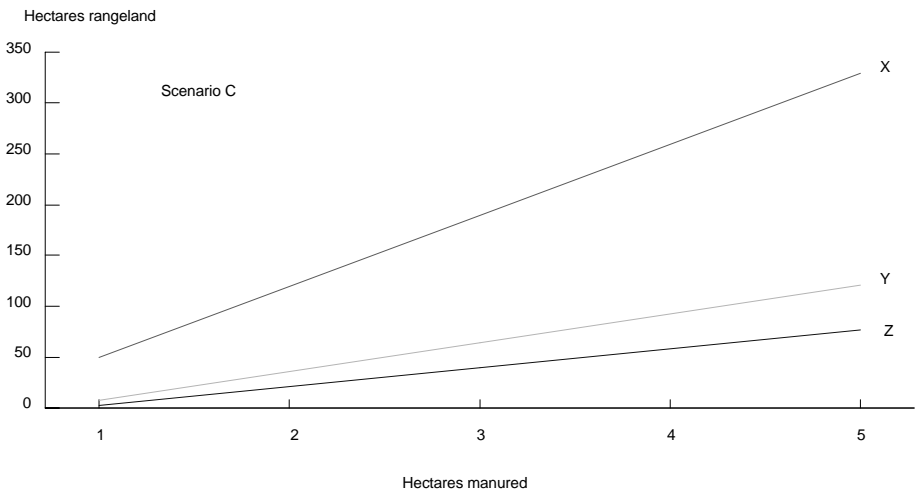
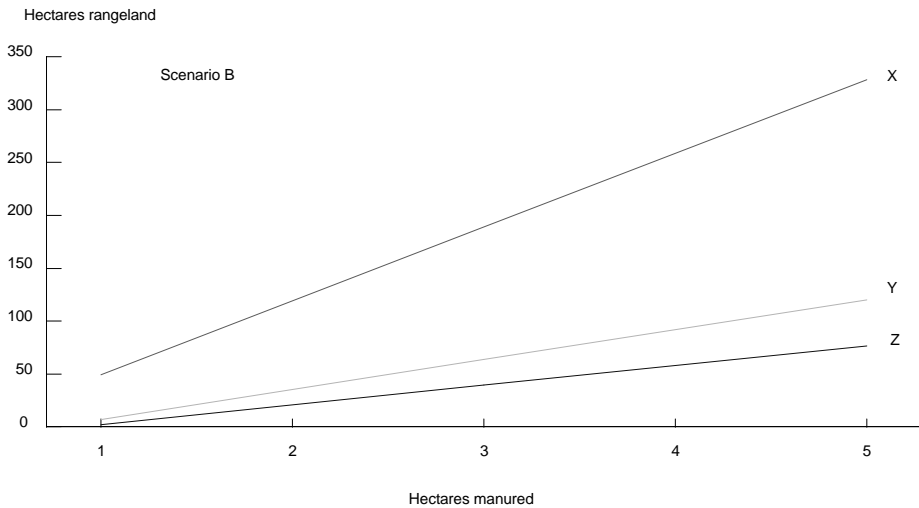
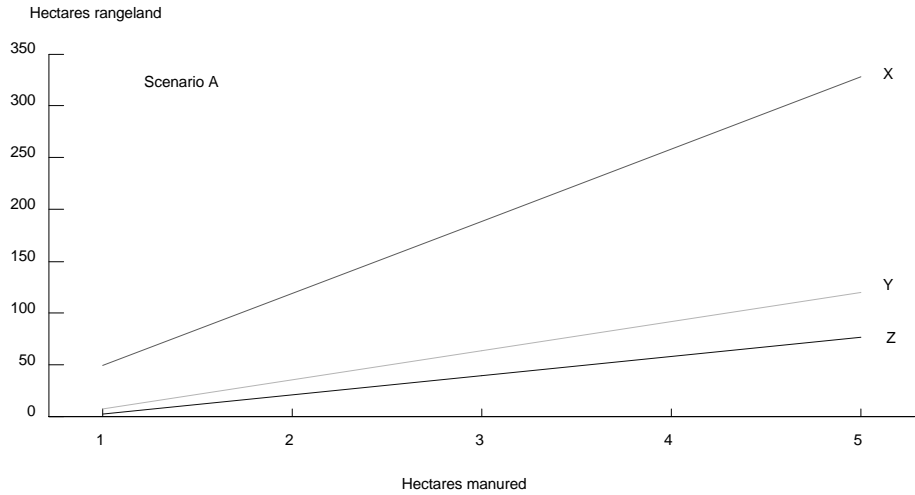

**Figure 7.** Rangeland required for wet-season grazing (June–September) by a 10-ha farm for manuring different areas of cropland under different scenarios of animal (A, B, C) and land (X, Y Z) productivity.

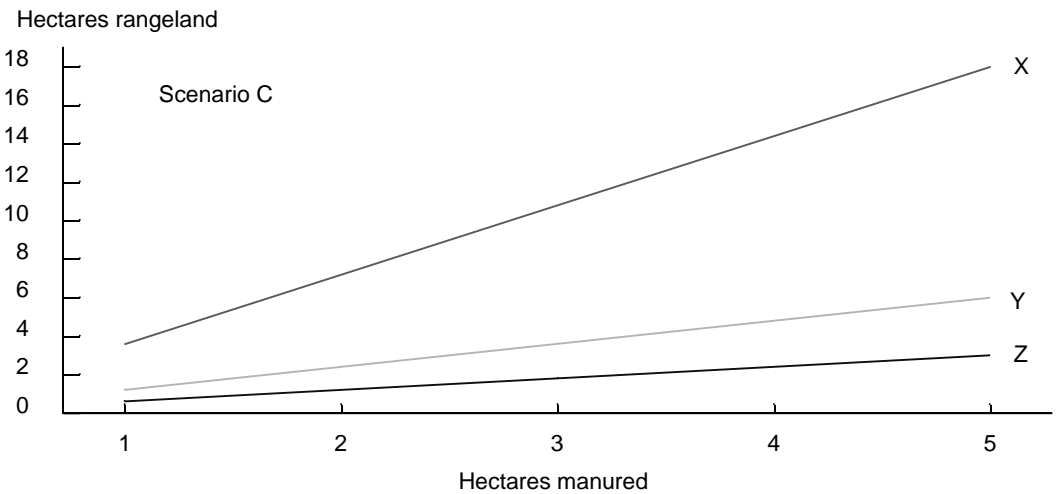
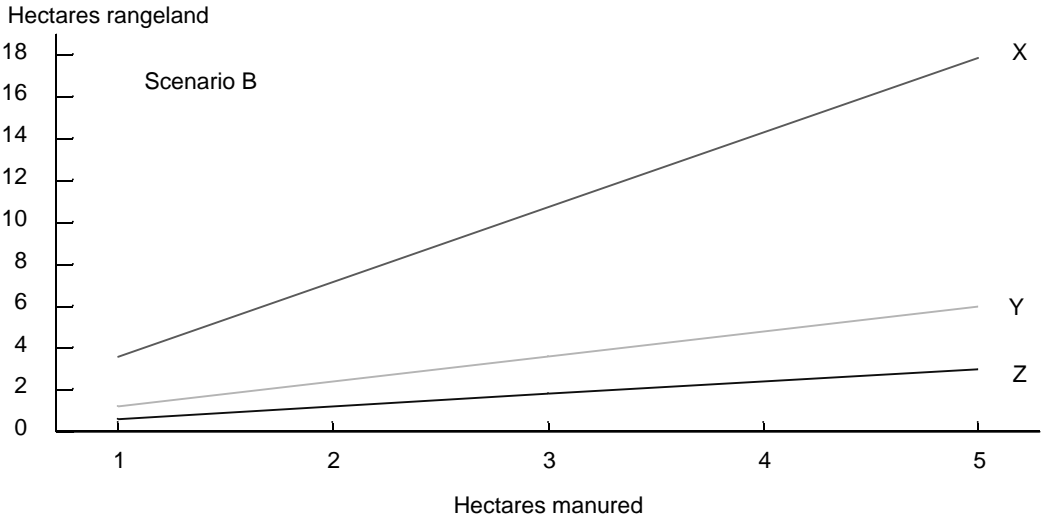

## Model limitations

In addition to manure, substantial amounts of nutrients are excreted through urine. Gans and Mercer (1977, cited in Church, 1975) indicated that cattle excrete 17 to 45 ml of urine per kg live weight daily and that normal excretion rates for sheep and goats are 10 to 40 ml/kg live weight. Senft et al (1987) measured the urine excretion by grazing cattle during a yearly grazing cycle on rangelands. Unfortunately these values are of little applicability for predictive purposes, since the amount of urine produced by animals is highly variable depending on water, salt and nitrogen intake, environmental and body temperature and exercise, among other factors (Church, 1975). The amounts of nutrients excreted through urine seem to be more important and are more amenable for prediction than the amounts or volumes of urine (Thorne, this volume).

The nutrients excreted through urine were ignored in the model. This limitation would be of no consequence if phosphorus is the most limiting nutrient for crop production, since phosphorus excretion through urine is negligible. Ignoring the excretion of nitrogen in urine may have only a small effect on estimates of RCR, since most urinary nitrogen appears to volatilise soon after urination. Furthermore, in experiments conducted to evaluate the response of crops to manure, part or all of the urine effect is included in the faecal effect, depending on the way manure was applied. It appears that the positive effect of urine is related more to its influence on soil pH and availability of phosphorus than on its contribution to the nitrogen balance (Powell et al, 1992; Zomda and Powell, unpublished data).

## Conclusion

Manure is often considered a key element of mixed crop–livestock systems due to its positive influence on crop productivity. The practice of manuring is widespread in SAWA and will most likely continue in the future. This paper shows that the potential of manure to continuously sustain crop production in SAWA is limited by livestock population, spatial location of livestock at manuring time, manure excretion per animal, efficiency of manure collection, and the amounts of feed and land resources available. The relative importance of these limiting factors and the possibilities for realising this potential, vary both spatially and temporally. It is suggested that these technical factors should be taken into consideration when evaluating the potential of manure to support crop production at national, regional, or farm level.

## References

- Ameha Sebsile. 1993. Overnight manure production from sheep in Ethiopia (short communication). *Small Ruminant Research Network Newsletter* 26. ILCA (International Livestock Centre for Africa), Addis Ababa, Ethiopia. pp. 18-20.
- Barlow R, Ellis K J, Williamson P J, Costigan P, Stephenson P D, Rose G and Mears P T. 1990. Dry-matter intake of Hereford and first-cross cows measured by controlled release of chromic oxide on three pasture systems. *Journal of Agricultural Science (Cambridge)* 110:217–231.
- Berger M, Belem P C, Dakouo D and Hien V. 1987. Le maintien de la fertilité des sols et la nécessité de l'association agriculture–élevage. *Cot. Fib. Trop. XLII, fasc. 3*:201–210.
- Bosma R and B Jager. 1992. *Le fumier, la production dans les parcs et valeur*. Ministère du développement rural et de l'environnement, Intitut d'économie rurale, Département de recherches sur les systèmes de production rurale, Sikasso, Mali.
- Bourn D, Milligan K and Wint W. 1986. Tsetse, trypanosomiasis and cattle in a changing environment. In: von Kaufmann R, Chater S and Blench R (eds), *Livestock systems research in Nigeria's subhumid zone*. Proceedings of the Second ILCA/NAPRI Symposium held in Kaduna, Nigeria, 29 October–2 November 1984. ILCA (International Livestock Centre for Africa), Addis Ababa, Ethiopia. pp. 85–109.
- Church D C. 1975. *Digestive physiology and digestion of ruminants. Vol 1 — Digestive physiology*. Second edition. O & B Books, Corvallis, Oregon, USA. pp. 115–132.

- Conrad H R, Pratt A D and Hibbs J W. 1964. Regulation of feed intake in dairy cows. 1. Change in importance of physical and physiological factors with increasing digestibility. *Journal of Dairy Science* 47:54–62.
- Diarra L, Ouloguem B and Haidara A K. 1993. *Forage intake by free ranging cattle in smallholder farms in peri-urban Bamako*. ILCA (International Livestock Centre for Africa), Addis Ababa, Ethiopia and Centre de Recherches Zootechniques de Sotuba, Bamako, Mali.
- Dicko M and Sangaré M. 1985. *La nutrition du bétail du système agro-pastoral du mil et du riz au Mali*. ILCA (International Livestock Centre for Africa), Bamako, Mali.
- Ellis W C. 1978. Factors determining grazed forage and digestibility. *Journal of Dairy Science* 61:1828–1840.
- FAO (Food and Agriculture Organization of the United Nations). 1990. *Production Yearbook 1989*. FAO Statistics Series 94. FAO, Rome, Italy. 346 pp.
- Grouzis M. 1988. *Structure, productivité et dynamique des systèmes écologiques sahéliens (Mare d'Oursi, Burkina Faso)*. Collection études et thèses. Editions de l'ORSTOM. ORSTOM (Office de la recherche scientifique et technique d'outre-mer), Paris, France. 336 pp.
- Guerin H. 1987. *Alimentation des ruminants domestiques sur pâturages naturels sahéliens et sahélo-soudaniens: étude méthodologique dans la région du Ferlo au Sénégal*. Thèse doctorale, Ecole nationale supérieure agronomique de Rennes.
- Hiernaux P. 1989. *Note sur l'évolution de la biomasse des pailles en cours de saison sèche*. ILCA Working Document 002/89. ILCA (International Livestock Centre for Africa), Bamako, Mali.
- Hiernaux P. 1993. *The crisis of Sahelian pastoralism: Ecological or economic?* ILCA (International Livestock Centre for Africa), Addis Ababa, Ethiopia. 15 pp.
- ICRISAT (International Crops Research Institute for the Semi-Arid Tropics). 1993. *West African Programs Annual Report 1992*. ICRISAT, Patancheru, India. 39 pp.
- ILCA (International Livestock Centre for Africa). 1993. *Handbook of African livestock statistics*. ILCA, Addis Ababa, Ethiopia. 66 pp.
- Kahn H E and Spedding C R W. 1984. A dynamic model for the simulation of cattle herd production systems. II. An investigation of various factors influencing the voluntary intake of dry matter and the use of the model in their validation. *Agricultural Systems* 13:63–82.
- Katelaars J J M H. 1986. Prediction of feed intake in ruminants. In: de Ridder N, van Keulen H, Seligman N G and Neate P J H (eds), *Modelling of extensive livestock production systems*. Proceedings of the ILCA/ARO/CABO workshop held at Aro, Bet Dagan, Israel, 5–9 February 1985. ILCA (International Livestock Centre for Africa), Addis Ababa, Ethiopia. pp. 108–156.
- Katelaars J and Tolcamp B. 1991. *Toward a new theory of feed intake regulation in ruminants*. PhD thesis, Agricultural University of Wageningen, Wageningen, The Netherlands. 254 pp.
- Khombe C T, Dube I A and Nyathi P. 1992. The effects of kraaling and stover supplementation during the dry season and body weights and manure production of Mashona steers in Zimbabwe. *African Livestock Research* 1:18–23.
- Konandreas P A and Anderson F M. 1982. *Cattle herd dynamics: An integer and stochastic model for evaluating production alternatives*. ILCA Research Report 2. ILCA (International Livestock Centre for Africa), Addis Ababa, Ethiopia. 95 pp.
- Lambourne L J, Mosi A K and Butterworth M H. 1986. Relationships between chemical composition and voluntary intake of feeds by sheep and cattle. In: de Ridder N, van Keulen H, Seligman N G and Neate P J H (eds), *Modelling of extensive livestock production systems*. Proceedings of the ILCA/ARO/CABO workshop held at Aro, Bet Dagan, Israel, 5–9 February 1985. ILCA (International Livestock Centre for Africa), Addis Ababa, Ethiopia. pp. 162–174.
- Landais E and Lhoste P. 1993. Systèmes d'élevage et transfert de fertilité dans la zone des savannes africaines. II. Les systèmes de gestion de la fumure animale et leur insertion dans les relations entre l'élevage et l'agriculture. *Cahiers Agricultures* 2:9–25.
- MAFF (Ministry of Agriculture, Fisheries and Food). 1984. *Energy allowances and feeding systems for ruminants*. Reference book 433. Her Majesty's Stationery Office, London, UK. 85 pp.



- Mahler F. 1990. Potential of natural pastures and locally available supplements in ruminant nutrition in a semi-arid location in West Africa. In: Universitaet Hohenheim, *Standortgemaesse Landwirtschaft in West Africa*. pp. 160–182.
- McIntire J, Bourzat D and Pingali P. 1992. *Crop–livestock interaction in sub-Saharan Africa*. The World Bank, Washington DC, USA. 246 pp.
- NRC (National Research Council). 1981. *Nutrient requirements of goats: Angora, dairy, and meat goats in temperate and tropical countries*. Nutrient Requirements of Domestic Animals 15. National Academy Press, Washington, DC, USA. 91 pp.
- Oosterheld M and McNaughton S J. 1991. Effect of stress and time for recovery on the amount of compensatory growth after grazing. *Oecologia* 85:305–313.
- Powell J M and Williams T O. 1993. *Livestock, nutrient cycling and sustainable agriculture in the West African Sahel*. Gatekeeper Series 37. IIED (International Institute for Environment and Development) Sustainable Agriculture Programme, London, UK. 13 pp.
- Powell J M, Ikpe F N and Somda Z. 1992. Nutrient cycling in millet-based mixed farming systems of west Africa. *Agronomy Abstracts* 1992. ASA (American Society of Agronomy), Madison, Wisconsin, USA. 70 pp.
- Sandford S G. 1989. Crop residue/livestock interactions. In: ICRISAT (International Crops Research Institute for the Semi-Arid Tropics), *Soil, crop and water management systems for rainfed agriculture in the Soudano-Sahelian zone*. Proceedings of an International Workshop. ICRISAT Sahelian Center, Niamey, Niger. pp. 169–182.
- SCA (Standing Committee on Agriculture, Ruminant Subcommittee). 1991. *Feeding standards for Australian livestock: Ruminants*. CSIRO (Commonwealth Scientific and Industrial Research Organization), Melbourne, Australia. 266 pp.
- Senft R L, Stillwell M A and Rittenhouse R L. 1987. Nitrogen and energy budgets of free-roaming cattle. *Journal of Range Management* 40:421–424.
- Van Soest P J. 1982. *Nutritional ecology of the ruminant*. O & B Books, Corvallis, Oregon, USA. 374 pp.
- Wilson R T. 1986. *Livestock production in central Mali: Long-term studies on cattle and small ruminants in the agro-pastoral system*. ILCA Research Report 14. ILCA (International Livestock Centre for Africa), Addis Ababa, Ethiopia. 111 pp.
- Winrock International. 1992. *Assessment of animal agriculture in sub-Saharan Africa*. Winrock International Institute for Agricultural Development, Morrilton, Arkansas, USA. 125 pp.

# **Pour un système durable de production au Mali-Sud: accroître le rôle des ruminants dans le maintien de la matière organique des sols**

*R. Bosma, M. Bengaly et T. Defoer*

Département de recherches sur les systèmes de production rurale (DRSPR)/Sikasso  
B.P. 186, Sikasso (Mali)

## **Résumé**

Le maintien de la matière organique dans les sols agricoles est un problème majeur pour la durabilité du système de production agricole au Mali-Sud, notamment lorsque les jachères se raccourcissent. La croissance démographique, l'extension des superficies emblavées, la fréquence des feux de brousse et l'accroissement des effectifs animaux sont les principaux facteurs responsables de l'inefficacité des jachères naturelles. En fonction des zones, la proportion de terres cultivées varie de 20 à 45%, tandis que le taux de terres arables ne dépasse guère 60% et que la charge animale peut aller de 19 à 30 UBT/km<sup>2</sup>. Dans une modélisation avec les données de trois zones d'études du DRSPR/Sikasso, deux possibilités de maintien du taux de matière organique du sol ont été évaluées. L'intensification de la production de fumier par l'utilisation de la litière pendant toute l'année s'est révélée plus efficace que la mise en jachère améliorée protégée pendant la saison des pluies. Cependant, avec les proportions actuelles de terres cultivées, aucun système de production durable ne semble envisageable sans une augmentation des effectifs de ruminants. Ceux-ci permettront en effet de rentabiliser les investissements dans les jachères améliorées, lesquelles, pâturées pendant la saison sèche, permettront de promouvoir la durabilité du système de production. La mise en stabulation du bétail pendant la saison sèche et chaude et le début de la saison des pluies permet de promouvoir le recyclage des résidus, de valoriser la main-d'oeuvre pendant la saison sèche, de favoriser le démarrage de la végétation naturelle et d'augmenter la charge au-delà de 30 UBT/km<sup>2</sup>. Des mesures socio-économiques aussi bien au niveau de l'exploitation, du terroir que de la région devront être prises pour favoriser un changement radical du système de conduite des animaux.

## **Increasing the role of ruminant livestock in the maintenance of soil organic matter for sustainable production systems in southern Mali**

*R. Bosma, M. Bengaly and T. Defoer*

Département de recherches sur les systèmes de production (DRSPR)/Sikasso  
BP 186, Sikasso, Mali

## **Abstract**

*The maintenance of soil organic matter (SOM) in cultivated soils is a major constraint to sustainable crop production in southern Mali, especially with reduced fallow periods. Population growth, increasing cultivated areas and livestock numbers, and frequent bush fires are the major factors contributing to inefficient natural fallows. In some areas, 20 to 45% of the land is cultivated, about 60% is arable, and stocking rates range from 19 to 30 TLU/km<sup>2</sup>. Two methods for maintaining SOM have been evaluated using a model and data from three studies conducted by DRSPR/Sikasso. Intensification of manure production all year round while using litter was more effective than improved fallows ungrazed during the rainy season. However, given the present land use rate, no sustainable*

production can be achieved without increasing ruminant livestock numbers. More cattle increase the profitability of improved fallows. These provide dry-season feed and hence improve the sustainability of the production system. Stall-feeding cattle in the hot dry and early wet seasons helps optimise the cycling of crop residues and the use of dry-season labour. It also improves the early growth of vegetation and makes it possible to increase carrying capacity over 30 TLU/km<sup>2</sup>. Socio-economic measures should be considered at farm, village and regional levels to drastically change the livestock management system.

## Introduction

La zone d'étude du DRSPR/Sikasso au Mali-Sud comprend trois entités agro-écologiques (tableau 1), avec différents systèmes de culture en fonction de la pluviométrie et de la longueur de la saison végétative. Dans le système traditionnel de culture de cette région, les exploitations agricoles se répartissent en champs de case autour des villages et en champs de brousse, plus éloignés des villages. Généralement, les champs de case sont cultivés en permanence grâce à un apport de nutriments par l'homme, les animaux, les arbres, etc. Quant aux champs de brousse, ils sont, après une période de culture (3 à 7 ans), mis en jachère, de préférence pendant des périodes très longues, allant de 15 à 30 ans. Ce système itinérant est viable, à condition que moins de 33% des terres cultivables soient effectivement cultivés et que les jachères remplissent effectivement leur fonction de restauration de la fertilité (Hoefsloot *et al.*, 1993).

**Tableau 1.** Principales caractéristiques du climat des zones agro-écologiques

Zone d'étude	Climat	Pluviométrie (mm)	Période des pluies saison	Température (°C)	
				max. (mois)	min. (mois)
Tominian	Semi-aride	550–800	juill.–oct.	35 (mai)	22 (janv.)
Koutiala	Subhumide	800–1000	juin–oct.	33 (mai)	22 (janv.)
Fonsébougou	Humide	1000–1200	mai–nov.	31 (avril)	25 (déc.)

L'introduction de la culture commerciale du coton, de pair avec la traction animale, a entraîné une modification des plans de culture et une extension des superficies cultivées. Le coton, culture principale, a bénéficié d'un paquet technologique introduit et entretenu par la Compagnie malienne pour le développement des textiles (CMDT), le principal organisme de développement de la zone. Les autres cultures (maïs, sorgho, mil, etc.) bénéficient directement ou indirectement de ce même paquet technologique (techniques culturales et effet résiduel de fertilisation surtout).

C'est ainsi qu'on rencontre couramment des rotations culturales de type coton/céréales et coton/céréales/céréales dans les zones humides et subhumides, et céréales/céréales/arachides dans la zone semi-aride. Le système de culture reste principalement extensif en intrants et intensif en main-d'oeuvre, en raison du faible coût-opportunité de la main-d'oeuvre, de la libre disponibilité de la terre, et du faible rapport "prix produit/prix engrais" (Berckmoes *et al.*, 1990). Cela est moins prononcé pour le coton que pour les céréales, dont la fertilisation directe ne se justifie pas pour la plupart des paysans. Par conséquent au moins 40% des revenus des paysans sont acquis grâce à l'épuisement des sols au niveau des parcelles agricoles (Pol, 1991).

La culture de rente dégage des revenus monétaires et le rôle des bovins a évolué de la fonction de prestige vers un rôle d'épargne, de production de fumier et de force de travail. Cela a entraîné une généralisation de la possession des bovins, et une utilisation extensive des bovins par manque d'investissements alternatifs. Qui plus est, une démographie galopante et l'installation quasi permanente d'importants troupeaux transhumants venant du Nord, ont provoqué une surcharge des parcours dans le Mali-Sud (Leloup et Traoré, 1989 et 1991; tableau 2).

**Tableau 2.** Données de base pour la modélisation

Paramètre	Unités	Tominian	Koutiala	Fonsébougou
Sup. cultivée/cultivable	%/%	20/50	45/60	20/50
Sup. céréale/disp.chaumes	%/t	70/2,8	60/4,0	50/5,0
Sup. coton/disp. tiges	%/t	0/–	30/2,0	30/2,0
Sup. arach.+niéb/disp. fanes	%/t	30/0,4	10/0,6	20/0,6
Besoins four. saison sèche	t/UBT	0,8	0,7	0,5
Productivité stylo	t/ha	2,0	2,5	3,0
Productivité maïs/dolique	t/ha	–	5,0	6,0
Prod. cult. four. pure	t/ha	1,0	1,5	2,0
Cap. de charge parcours <sup>1/</sup>	UBT/km <sup>2</sup>	16,7	16,7*	16,7*
Charge animale <sup>1/</sup>	UBT/km <sup>2</sup>	19	35	25
Longueur saison humide	mois	4	5	6
Longueur s. sèche fraîche	mois	3	3	3
Longueur s. sèche chaude	mois	4	3	2
Longueur s. préhumide	mois	1	1	1

1/ Moyennes pour les zones entières. \* équivalent à 6 ha/UBT

Sup. = superficie; disp. = quantité effectivement disponible pour stockage (total – 1 t/ha). four. = fourrage; prod. = productivité; cult. = culture; cap. = capacité; s. = saison; arach. = arachide

Source: rapports divers DRSPR/Sikasso.

Par conséquent, dans de nombreuses régions du Mali-Sud, les jachères naturelles n'ont qu'une faible capacité naturelle de restauration de la fertilité; ainsi les bilans d'azote (N) et de potassium (K) sont négatifs et sont respectivement de –5 kg/ha/an et de –7 kg/ha/an au coeur de la zone cotonnière du Mali-Sud (Pol, 1992). Le taux de matière organique, crucial pour l'utilisation efficace des éléments nutritifs (Ridder et Keulen, 1990) est menacé par la fréquence des feux de brousse, qui peuvent réduire l'accumulation annuelle de la masse racinaire de 1,9 à 1,2 t/ha/an (UNESCO/PNUE/FAO, 1981).

La dégradation des terres cultivées se manifeste à trois niveaux, à savoir le bilan des éléments nutritifs, le pH, et le taux de matière organique. Sous les différents systèmes de culture à base de coton, le bilan des éléments nutritifs est déficitaire pour N et K et s'établit respectivement à 25 et 20 kg/ha/an (Pol, 1992).

Ce déficit est encore plus élevé sous les systèmes céréales qui ne bénéficient que rarement de fumure. Des pH compris entre 5 et 4 ont été observés (DRSPR, 1991). Cette acidification des sols semble due à l'utilisation courante des engrais ammoniacaux tels que l'urée (Pieri, 1989). Pour sa neutralisation, l'apport régulier de fumier est aussi efficace que le chaulage (DRSPR, 1993). En ce qui concerne la capacité d'échange des cations (CEC), facteur fortement lié au taux de carbone organique du sol (Ridder et Keulen, 1990), des valeurs proches de 2,4 meq/100 g ont été observées en zone semi-aride et subhumide (Diarra *et al.*, 1992). Ce taux médiocre augmente avec la jachère améliorée, sans toutefois atteindre les valeurs considérées comme acceptables (6 meq/100 g; SRCVO, 1978).

Il ne fait aujourd'hui plus aucun doute que seule la mécanisation de l'agriculture peut permettre de produire suffisamment pour subvenir aux besoins d'une population sans cesse plus nombreuse. La motorisation intermédiaire ou même la motorisation tout court ne semble pas une réalité pour les paysans du Mali-Sud compte tenu de son impact sur l'environnement et de sa faible rentabilité. Dans

ces conditions, la seule forme de mécanisation possible de l'agriculture est la traction animale. Par conséquent, le recyclage efficace des résidus de récolte par l'enfouissement n'est pas applicable au Mali-Sud, et entraînerait par ailleurs une diminution temporaire de la disponibilité des éléments nutritifs (Ganry *et al.*, 1974).

Les principales options pour maintenir un taux de matière organique acceptable sont par conséquent l'intensification de la production de fumier et l'amélioration de la jachère. La rentabilité de la jachère améliorée est fortement liée à son exploitation par le bétail (Fomba et Bosma, 1992; Hoefsloot *et al.*, 1993). Cependant, quelles sont les possibilités et les limites de l'utilisation du bétail par rapport au maintien du taux de matière organique? On tentera, à partir d'un modèle, de répondre à cette question par zone agro-écologique. La description dudit modèle sera suivie d'une évaluation des perspectives d'intégration agropastorale.

## Description du modèle

Les données disponibles de DRPSR/Sikasso (tableau 2) ont été utilisées pour une modélisation destinée à apporter des éléments de réponse à la question principale. Cette modélisation exclut la préparation du compost qui est pourtant une option possible dans les exploitations disposant de peu de bétail. On a également supposé que de nouveaux défrichages ne sont autorisés que pour les seules jachères améliorées. Exécutée avec un fichier de calcul lotus 1-2-3, cette modélisation empirique n'est pas dynamique.

La première condition du modèle (figure 1) est la restitution suffisante de matière organique en vue d'en maintenir le taux dans les terres cultivées. Du point de vue système, les besoins en matière organique dépendent de la proportion de terres cultivées et peuvent être satisfaits par la jachère et la fumure organique. Dans le modèle (voir annexe A pour le fichier de calcul), le nombre d'UBT nécessaire pour produire suffisamment de fumure organique dépend du niveau de production de fumier, et du pourcentage des terres en culture et en jachère améliorée. Pour vérifier la faisabilité du système, on calcule un bilan de litière, un bilan fourrager ainsi que le taux du fourrage fourni par la pâture. La modélisation est effectuée pour les proportions de terres actuellement cultivées en fonction de quatre taux de jachère améliorée et six niveaux de production de fumier.

Pour la restitution de la matière organique, la quantité de fumure organique recommandée, soit 7,5 t/ha/3 ans (Pol, 1991) a été retenue. Selon Ridder et Keulen (1990), cette quantité devrait suffire pour maintenir à niveau acceptable le taux de matière organique dans les sols. Pour le calcul des besoins en fumier, on déduit la quantité fournie par la jachère et le fumier déposé au champ par le bétail. La partie du fumier déposée au champ pendant la vaine pâture (200 kg/UBT/an) est déduite, en supposant une charge animale de 2 UBT/ha de terre cultivée. Conformément aux données publiées (Hoefsloot *et al.*, 1993; UNESCO/PNUE/FAO, 1979) et aux résultats préliminaires obtenus par le projet Production soudano-sahélienne (PSS) (Groot, communication orale), il est considéré que l'apport de matière organique de la jachère améliorée est au moins équivalent à celui de 7,5 t/ha/3 ans de fumier. La jachère améliorée considérée est une sole de *Stylosanthes hamata* fertilisée au semis et protégée pendant trois saisons végétatives consécutives (Diarra *et al.*, 1992). Le taux de jachère améliorée est fonction du schéma de rotation, dans lequel trois années de jachère suivies de trois années de culture sont alternées avec plusieurs cycles de trois ans de culture avec à chaque fois application de fumure organique au cours de la première année. Ainsi, quatre taux de mise en jachère améliorée, à savoir 0, 17, 25, et 33% des terres cultivées ont été considérés. Le dernier taux a été utilisé uniquement pour la zone de Koutiala, car un tel taux semble peu réaliste au Mali-Sud.

Le niveau de production de fumier est fortement lié aux types de conduite, dont six ont été considérés (tableau 3). Les types A et B sont des types traditionnels, tandis que les types C, D et E sont actuellement en cours de vulgarisation. En ce qui concerne le type F, c'est-à-dire la stabulation saisonnière, il ne cesse de gagner du terrain dans la région de Tominian (Bosma, 1992).

**Figure 1.** Présentation schématique du modèle permettant de calculer les possibilités de restauration de la matière organique au sol.

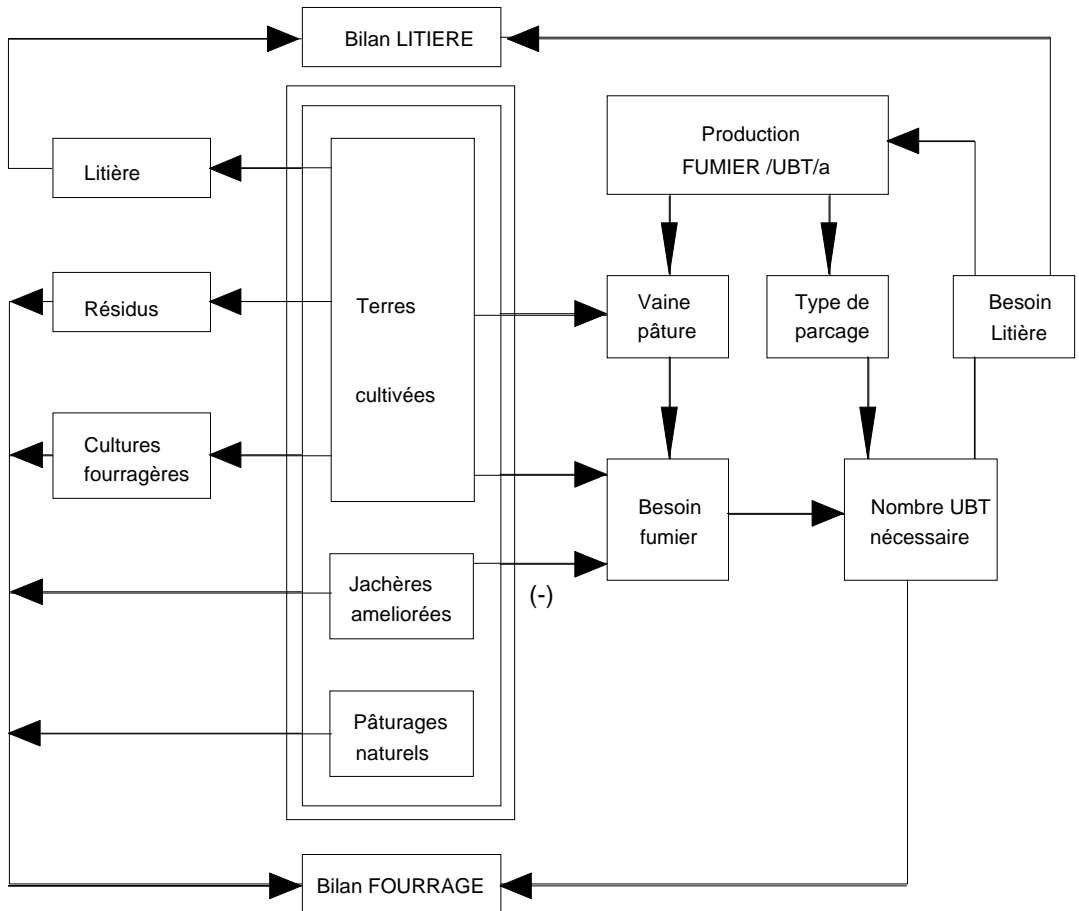

**Tableau 3.** *Types de conduite des ruminants au Mali-Sud selon la saison*

Type de conduite	Saison humide <sup>1/</sup>	Saison sèche (SS)	
		SS fraîche	! SS chaude + SPH
		DIVAGATION <sup>2/</sup>	
		Parcage nocturne sans litière	
A	Parcage sans litière	DIVAGATION <sup>2/</sup>	
B	Parcage sans litière	Parcage nocturne sans litière	
C	Parcage avec litière	Parcage nocturne avec litière	
D	Parcage avec litière	Parcage nocturne	! Stabulation
E	Parcage avec litière	avec litière	! permanente
F	Parcage avec litière		! avec litière

SPH = saison préhumide

1/ Le parcage en saison humide est uniquement nocturne; pendant la journée les animaux sont conduits sur le parcours.

2/ Compte tenu de la généralisation de la possession des bovins, de l'éclatement des exploitations composées et du coût d'opportunité élevé du gardiennage, la divagation est difficilement maîtrisable.

Le bilan de litière est déterminé comme la différence entre les besoins et la disponibilité. Le nombre d'UBT, le niveau de production de fumier, et les caractéristiques climatologiques de la zone sont déterminants pour les besoins en litière (tableau 4). La disponibilité est l'ensemble des tiges de coton et des chaumes de céréales non utilisées comme fourrage et restant après le passage du bétail dans les champs (vaine pâture).

**Tableau 4.** *Production estimée du fumier et besoins en litière dans les parcs, selon les types de conduite (kg/UBT/an)*

Type de conduite	Tominian Fumier/litière	Koutiala Fumier/litière	Fonsébougou Fumier/litière
A 1/	130/0	150/0	170/0
B 1/	310/0	310/0	310/0
C	400/300	500/500	750/750
D 2/	580/300	660/500	890/750
E	820/465	875/650	1085/885
F	1000/540	1015/710	1185/930

1/ Le fumier sans litière n'est pas de même qualité que celui avec litière, et les quantités ne peuvent alors être comparées.

2/ le bétail est parqué sans que la litière soit renouvelée.

Source: Bosma et Jager, 1992.

Le bilan fourrager est la différence entre le nombre d'UBT qu'on peut alimenter et le nombre d'UBT nécessaire; il est calculé à partir de l'utilisation du fourrage par stockage et de la capacité de charge des pâturages naturels. La disponibilité de ces pâturages est déterminée par le pourcentage d'occupation des terres par les cultures, les jachères améliorées et les infrastructures. En ce qui concerne l'occupation par les infrastructures, le chiffre de 10% par rapport aux terres cultivées a été retenu. En tenant compte des possibilités et des opinions des paysans, on considère quatre options pour le stockage du fourrage, à savoir par ordre de préférence; les fanes et chaumes, le foin de la jachère améliorée, le dolique et les chaumes de maïs cultivés en association, et les cultures pures de fourrages. Comme option alternative, actuellement non vulgarisée, la pâture de la jachère améliorée a été considérée. Celle-ci est difficile à éviter pendant la saison sèche. Une pression de pâture élevée et

sélective est conseillée pendant la saison humide pour favoriser le développement végétatif de la jachère améliorée.

Le taux de fourrage fourni par la pâture a été évalué pour une capacité de charge de pâturages naturels de 6 ha/UBT. Cette charge pourrait augmenter si les animaux sont conduits rationnellement sur le parcours (Lühl, 1992) ou si les parcours ne sont exploités, ni en saison sèche et chaude, ni au début de la saison des pluies (Behnke, 1992; Bosma, 1992). Cependant, pour la faisabilité du système de conduite du troupeau, une quantité importante du fourrage doit être fournie par les parcours (pâturages naturels, vaine pâture ou jachère améliorée pâturée). Cela est dû au fait que pendant la saison des pluies, le temps de travail disponible est limité et que le stockage du fourrage serait trop coûteux dans le cas d'une stabulation durant toute l'année.

Dans la zone semi-aride, la limite du système de conduite est atteinte lorsque les animaux passent moins de 60% du temps sur les parcours communs (tableau 5). Dans les zones plus humides, ce taux est de 65 à 70% selon la région. En plus, la charge animale pendant la vaine pâture ne peut être trop élevée en raison du faible taux d'utilisation des chaumes sur pied (Bosma, 1993). La limite de charge pendant cette période varie entre 2 et 3 UBT/ha, en fonction de la différence de productivité des chaumes entre les zones semi-aride et humide. Pour diminuer l'apport des parcours communs, il faut stocker du fourrage ou faire pâturer les jachères améliorées pendant la saison sèche.

**Tableau 5.** Proportion minimum de fourrage fourni par la pâture, en fonction des ressources fourragères saisonnières (%)

Source fourragère *	Zone		
	Semi-aride	Subhumide	Humide
Pâturages naturels	35	40	40
Vaine pâture	25	25	25
Fourrage stocké	40	35	30
Proportion fourrage-pâture	60	65	70

\* En fonction de l'utilisation par période, avec des recoupes; par exemple le pâturage naturel est aussi utilisé pendant la période de vaine pâture en fonction du type de conduite, lorsqu'il n'est pas fortement dégradé comme à Koutiala.

## Résultats et discussion

D'une manière générale, le nombre d'UBT nécessaire pour maintenir le taux de matière organique est très élevé lorsque le fumier est produit de manière extensive et lorsqu'il n'y a pas de jachère (tableau 6, colonne 1). Aussi le taux de jachère de 17% est-il généralement insuffisant, pour restaurer la matière organique avec un nombre acceptable d'UBT. Il ressort de la comparaison des systèmes (tableau 6) que l'intensification de la production de fumier dans les parcs est plus efficace que la jachère améliorée. Cela concorde avec la pratique paysanne à Fonsébougou où les paysans adoptent rarement la jachère améliorée et mettent plutôt l'accent sur l'utilisation de la litière. La quantité de litière disponible est toujours suffisante. Lorsqu'on utilise uniquement et en grande quantité des chaumes et des fanes, le système de conduite est impraticable, car la quantité de fourrage disponible pour la pâture est insuffisante, bien que le bilan fourrager soit positif (tableau 6, colonne 6).

Le système actuel de production de fumier le plus intensif, à savoir la stabulation saisonnière, a été comparé avec le parcage nocturne sur litière pendant toute l'année pour le cas de Tominian (tableau 7). Avec les taux de jachère améliorée appliqués, les besoins en UBT sont toujours supérieurs à la charge actuelle de 19 UBT/km<sup>2</sup>. La disponibilité de la litière peut être problématique lorsqu'il n'y a pas de jachère améliorée et que les besoins en UBT sont très élevés (tableau 7). A Tominian une exploitation durable de 20% des terres nécessite 5% de terres en plus en jachère améliorée et une charge animale de 30 UBT/km<sup>2</sup>. L'introduction de ce type de jachère non seulement améliore le bilan



fourrager et le bilan litière, mais également et surtout permet de rendre le système de production faisable car la pâture de la jachère améliorée en saison sèche réduit les besoins de stockage et facilite la conduite de l'élevage. Dans la situation actuelle caractérisée par les difficultés d'installation de la jachère améliorée et les coûts élevés de la protection contre les animaux en divagation (Diarra *et al.*, 1992; Fomba et Bosma, 1992), on comprend que les paysans adoptent massivement la stabulation saisonnière dans la zone semi-aride.

**Tableau 6.** Comparaison de la jachère améliorée et de l'intensification de la production de fumier, cas de Fonsébougou

Paramètre	Type de conduite					
	B		D		E	
Taux de TC (%)	20	20	20	20	20	20
Taux en JA (%)	0	5*	0	5	0	5
Besoins UBT (UBT/km <sup>2</sup> )	136	95	47	33	39	27
Bilan fourrage-1 (UBT)	-82	-50	-10	-1	-4	4
Fourrage-pâture-1 (%)	9	14	35	49	44	61
Bilan litière (t)	3	18	3	19	7	22

TC = Terres cultivées; JA = Jachères améliorées.

Fourrage-pâture-1 = Part du fourrage fourni par le parcours.

Bilan fourrage-1 = Pâture des parcours et stockage des fanes et chaumes.

\* 5% de la superficie totale = 25% des terres cultivées.

**Tableau 7.** Influence de la stabulation saisonnière; cas de Tominian

Paramètre	Type de conduite					
	D		E		F	
Taux de TC (%)	20	20	20	20	20	20
Taux en JA (%)	5	0	5	0	5	5
Besoins UBT (UBT/km <sup>2</sup> )	51	51	36	42	30	30
Bilan fourrage-1 (UBT)	2	4	12	10	16	16
Fourrage-pâture-1 (%)	27	29	42	37	53	53
Bilan fourrage-5 (UBT)	7	4	17	10	21	21
Fourrage-pâture-5 (%)	37	29	56	37	70	70
Bilan litière (t)	-2	-10	6	-3	11	11

Bilan fourrage-1 = Pâture des parcours et stockage des fanes et chaumes.

Bilan fourrage-5 = Pâture des parcours et de la jachère améliorée pendant la saison sèche et stockage des fanes et chaumes.

Le cas de Koutiala (tableau 8) montre bien les limites du taux de terres cultivées. L'intensification de la production de fumier et l'introduction de la jachère améliorée à un taux raisonnable ne suffisent pas pour maintenir la fertilité. L'accent mis par l'organisme de vulgarisation sur l'introduction de la jachère améliorée dans la zone semble tout à fait justifié. Il faut plus de 100 UBT/km<sup>2</sup> pour produire le fumier lorsque 25% des superficies cultivées sont en jachère améliorée (tableau 8). Avec un taux de 33%, on ne pourrait maintenir le taux actuel des terres en culture qu'avec une charge de 56 UBT/km<sup>2</sup>. Dans ce cas, 60% des terres seront exploités, soit la totalité de la superficie cultivable. Bien que le système de conduite ne puisse permettre de maintenir une charge de 56 UBT/km<sup>2</sup>, il est

absolument indispensable d'augmenter le nombre d'UBT au-delà de la charge actuelle. La faisabilité du système passe nécessairement par l'exploitation de la jachère améliorée par la pâture.

**Tableau 8.** *Importance de l'augmentation du nombre d'UBT et de la pâture des jachères améliorées pour la faisabilité du système; cas de Koutiala, avec 10p. 100 des TC sous maïs/dolique*

Paramètres	Type de conduite				
	D	E		F	
Taux de TC (%)	45	35	35	35	45
Taux en JA (%)	11	9	12	12	15
UBT (UBT/km <sup>2</sup> )	101	59	51	44	56
Bilan fourrage-3/5 (UBT)	-49	-10	0	7	-2
Fourrage-pâture-3 (%)	17	28	32	37	29
Fourrage-pâture-5 (%)	30	47	60	70	62

Fourrage-pâture-3 = Pâture des parcours et stockage des fanes, chaumes/dolique et du fourrage de la jachère améliorée.

Fourrage-Pâture-5 = Pâture des parcours et de la jachère améliorée, et stockage des fanes et chaumes/dolique.

Le système permettant l'exploitation de telles superficies semble très fragile et il est préférable de mettre l'accent sur l'élevage. A cet effet, la superficie totale cultivée pourra être limitée aux taux actuels (45%) et au fur et à mesure une partie de ces terres sera mise en jachère améliorée. Cela sera possible lorsque l'élevage constituera pour les paysans une source de revenus réguliers et sûrs. La réduction de la superficie cultivée à 35% et la mise en jachère améliorée de 12% des terres en plus, permettront d'alimenter plus de 40 UBT/km<sup>2</sup>.

Malgré les efforts actuels de vulgarisation des cultures fourragères pures, le taux d'adoption reste faible pour des raisons diverses. L'association de cultures, telle que celle du dolique (*Dolichos niger*) et du maïs, a l'avantage de favoriser l'économie de superficie et de travail, le dolique profitant par exemple de la fertilisation du maïs (DRSPR, 1993). La comparaison entre les deux types de culture fourragère, du point de vue bilan fourrager, permet de mieux comprendre l'intérêt des paysans pour l'association dolique/maïs (tableau 9). En effet, la culture fourragère pure fait concurrence du point de vue superficie et doit être fertilisée pour ne pas aggraver le bilan nutritif.

**Tableau 9** *Efficacité de la culture fourragère associée (dolique/maïs) par rapport aux cultures pures de fourrage; cas de koutiala, pour les types de conduite E, et 35% des terres cultivées*

Paramètres	Fourrage pur		Dolique/maïs	
	Taux en JA (%)	9	12	9
Besoins UBT (UBT/km <sup>2</sup> )	59	51	59	51
Bilan fourrage (UBT)	-14	-4	-10	0

Les 10 % de superficie en culture pure du fourrage remplacent le coton et l'association maïs/dolique; 10 p. 100 des terres cultivées.

Etant donné la charge actuelle à Tominian et à Fonsébougou, la fertilité pourra être maintenue en augmentant le taux de jachère améliorée au-delà des valeurs acceptables tout en produisant le fumier de façon optimale. Avec un taux de terre cultivée supérieur à 20%, comme autour de Koutiala, il importe absolument d'augmenter le nombre d'UBT pour satisfaire les besoins de fumier. Cela permettra de bien recycler les résidus, de rentabiliser les jachères améliorées et de maintenir le taux élevé de terres cultivées. Comme l'ont souligné Preston et Murgueitio (1992), le système de conduite

des animaux au Mali-Sud doit radicalement changer et les chaumes des céréales constitueront la base de l'alimentation des ruminants en saison sèche.

L'adoption de la stabulation saisonnière pendant la saison sèche et le début de la saison des pluies a le double avantage d'augmenter la production de fumier et de diminuer temporairement la charge sur les parcours, permettant ainsi une charge plus élevée pendant la saison des pluies. En outre, certaines exploitations de la région de Tominian ont déjà diminué leur superficie cultivée après l'intensification de la production de fumier. Qui plus est, la stabulation saisonnière des animaux permet de valoriser la main-d'oeuvre disponible, de maximiser le recyclage des résidus et d'augmenter la charge animale au-delà de 30 UBT/km<sup>2</sup>. Avec une telle charge, il est évident que les jachères naturelles ne pourront remplir leur fonction.

Dans la partie septentrionale du Mali-Sud, le type de conduite des ruminants domestiques (divagation en saison sèche) est en train de changer car les paysans, compte tenu de la situation fourragère, se voient obligés de stocker, de cultiver ou d'acheter des fourrages. La situation actuelle caractérisée par la dégradation accélérée des pâturages naturels est à cet effet un facteur favorable. Le recyclage efficace de résidus passe cependant par l'existence de moyens de transport et de stockage et la disponibilité de la main-d'oeuvre. Qui plus est, 70% des bovins appartiennent à moins de 20% des paysans et sont concentrés dans des troupeaux de plus de 20 têtes, qu'ils soient des troupeaux collectifs ou individuels. Bien que ce système de conduite réduise l'investissement en main-d'oeuvre au minimum, il ne permet d'optimiser ni la production de fumier (Bosma *et al.*, 1993) ni l'utilisation des résidus (Bosma 1993).

L'adoption généralisée du type d'élevage intensif est fonction des conditions socio-économiques. D'abord, cet élevage doit être économiquement plus intéressant pour que les paysans lui accordent la priorité au détriment du coton compte tenu du calendrier agricole (Penelope, 1992). L'adoption de l'intensification sera favorisée par des filières de commercialisation stimulatrices et un système diversifié de droits de pâture (Bosma, 1993). Par ailleurs, la maîtrise de tous les aspects de cet élevage et de son intégration à l'agriculture mérite une attention particulière. Des programmes de formation technique en saison sèche, et la formation agricole au niveau des écoles primaires prépareront les paysans.

Le hachage des chaumes de céréales permet de diminuer les refus par les animaux, mais n'est pas toujours nécessaire pour augmenter le disponible fourrager. Cette technique facilite le transport et le stockage du fourrage, permettant aux paysans de maintenir plus de bétail en stabulation pendant la saison sèche (Bosma, 1992). La disponibilité des compléments à base de sous-produits agro-industriels, lesquels stimulent l'utilisation digestive des chaumes, est nécessaire à court terme. A moyen terme, le fourrage des jachères améliorées prendra partiellement la relève. Par ailleurs, l'accent doit être mis sur l'utilisation et la recherche des chaumes de bonne qualité fourragère (Reed *et al.*, 1988) et des systèmes intégrés avec des ligneux fourragers (Kang et Reynolds, 1980). Cela diminuera la dépendance des paysans vis-à-vis des compléments industriels et permettra de disposer de ces derniers pour d'autres secteurs.

## Conclusion

Etant donné les taux actuels de terres cultivées, aucun système de production durable ne semble envisageable sans une forte production de fumier et la mise en jachère améliorée d'une partie des terres. Pour maintenir le taux de matière organique des sols, il faudrait augmenter les effectifs de ruminants, pour d'une part valoriser la jachère améliorée et d'autre part produire le fumier par transformation des résidus de récolte. Les ruminants constitueront donc la clef de voûte de la durabilité des systèmes de culture et pourront en plus permettre d'offrir aux paysans les autres avantages associés à leur intégration au système de production.

Contrairement à la thèse répandue, pour arrêter la dégradation, il faut augmenter et non diminuer les effectifs animaux, et changer radicalement le système de conduite. La stabulation saisonnière des

ruminants permettra de maintenir une charge animale supérieure à 30 UBT/km<sup>2</sup>. L'alimentation du bétail pourra être garantie par le hachage des chaumes et une complémentation stimulant leur utilisation digestive. Les organismes de développement doivent accorder toute l'attention nécessaire à la production de fumier de bonne qualité et mettre l'accent sur les techniques optimales. La vulgarisation devra faire une place de choix à l'introduction de jachères améliorées et promouvoir l'exploitation sélective de ces jachères par la pâture. En revanche, l'introduction de cultures fourragères pures est déconseillée. Lorsque le taux des terres cultivées est élevé, des associations de cultures telles que le maïs et le dolique amélioreront le bilan fourrager.

## Références

- Behnke R.H. 1992. *New directions in African range management Policy*. Results of a workshop held from 13 to 17 January 1992 in Maputo, Zimbabwe. ODI (Overseas Development Institute)–Network Paper 32c, Londres (R.-U.). 15 p.
- Berckmoes W.M.L., Jager E.J. et Koné Y. 1990. *L'intensification agricole au Mali-Sud. Souhait ou réalité ?* DRSPR (Département de recherches sur les systèmes de production rurale)/Sikasso (Mali), IER (Institut d'économie rurale)/Bamako (Mali). Bulletin 318, KIT/Amsterdam (Pays-Bas). 40 p.
- Bosma R.H. 1992. *La stabulation saisonnière des bovins dans la zone de Tominian*. Doc. Int. DRSPR (Département de recherches sur les systèmes de production rurale)/Sikasso (Mali).
- Bosma R.H. et Jager B. 1992. *Fumier, la production dans les parcs et la valeur*. Doc. Int. DRSPR (Département de recherches sur les systèmes de production rurale)/Sikasso (Mali).
- Bosma R.H. 1993. *Elevage du bétail dans la zone SIWAA. Stratégies pour une exploitation équilibrée des ressources fourragères*. DRSPR (Département de recherches sur les systèmes de production rurale)/Sikasso (Mali). 23 p.
- Bosma R.H., Kamara A. et Sanogo B. 1993. Parcs améliorés. *Expériences du DRSPR/Sikasso et faisabilité au Mali-Sud*. DRSPR (Département de recherches sur les systèmes de production rurale /Sikasso, IER (Institut d'économie rurale), Mali.
- Diarra S., Poel P. van der et Kaya B.D. 1992. Les tests d'introduction des soles fourragères dans les exploitations agricoles au Mali-Sud. Les expériences du DRSPR/Sikasso. Article présenté lors de l'atelier *Stylosanthes as feed and fallow*, tenu à Kaduna (Nigéria) du 26 au 31 octobre 1992.
- DRSPR (Département de recherches sur les systèmes de production rurale/Sikasso. 1991. *Résultats campagne 90/91*, CTS/SPR, IER/MAEE, Bamako (Mali).
- DRSPR (Département de recherches sur les systèmes de production rurale /Sikasso. 1993. *Résultats campagne 92/93*, CTR/Sikasso, IER/MAEE (Mali).
- Fomba B. et Bosma R.H. 1992. Introduction des soles fourragères de *Stylosanthes hamata* dans les exploitations agricoles au Mali-Sud. Article présenté lors de l'atelier *Stylosanthes as feed and fallow*, tenu à Kaduna (Nigéria) du 26 au 31 octobre 1992.
- Ganry F., Bideau J. et Nicoli J. 1974. Action de la fertilisation azotée et de l'amendement organique sur le rendement et la valeur nutritionnelle d'un mil Souna III. *Agronomie Tropicale* 24:1006–1015.
- Hoefslot H., Roeleveld A. et Pol F. van der. 1993. *Jachères Améliorées*. KIT (Institut royal pour les régions tropicales), Amsterdam (Pays-Bas).
- Kang B.T. et Reynolds L. (sous la direction de). *La culture en couloirs dans les tropiques humides et subhumides*. CRDI (Centre de recherches pour le développement international), Ottawa (Canada).
- Leloup S. et Traoré M. 1989. *La situation fourragère dans le Sud-Est du Mali*. Tome I: Régions CMDT de Sikasso et de Koutiala. KIT (Institut royal pour les régions tropicales)/Amsterdam (Pays-Bas).
- Leloup S. et Traoré M. 1991. *La situation fourragère dans le Sud-Est du Mali*. Tome II: Région CMDT de San. DRSPR (Département de recherches sur les systèmes de production rurale)/Sikasso, IER (Institut d'économie rurale)/Bamako, KIT (Institut royal pour les régions tropicales)/Amsterdam (Pays-Bas).
- Lühl H. 1992. Holistic Resource Management: Can it beat desertification? *ILEA Newsletter*, vol. 8, N° 3.

- Penelope A. 1992. Place de l'élevage dans un cas de gestion de terroir: SIWAA. Mémoire de fin d'études EITARC, Montpellier (France).
- Pieri C. 1989. *Fertilité des terres de savanes*. Bilan de trente ans de recherche et de développement agricoles au sud du Sahara. CIRAD (Centre de coopération internationale en recherche agronomique pour le développement)–IRAT (Institut de recherches agronomiques tropicales et des cultures vivrières/Ministère de la coopération et du développement, Paris (France). 444 p.
- Pol F. van der. 1991. L'épuisement des terres, une source de revenus pour les paysans au Mali-Sud. Actes des rencontres internationales: *Savanes d'Afrique, terres fertiles?* Montpellier, 10–14 décembre 1990: p. 403 à 418.
- Pol F. van der. 1992. *Soil Mining. An Unseen Contributor to Farm. Income in Southern Mali*. KIT (Institut royal pour les régions tropicales), Bulletin 325, Amsterdam (Pays-Bas).
- Preston T.R. et Murgueitio E. 1992. Strategy for sustainable livestock production in the tropics. Consultorias para el Desarrollo in en Tropicico, et da, Cali (Colombie). 89 p.
- Reed J.D., Yilma Kebede et Fussell L.K. 1988. Factors affecting the nutritive value of sorghum and millet crop residues. In: *Plant breeding and the nutritive value of crop residues*. Publié sous la direction de J.D. Reed, B.S. Copper et P.J.H. Neate. Actes d'un séminaire tenu au CIPEA en Ethiopie du 7 au 10 décembre 1987. p. 233 à 251
- Ridder N. de et Keulen H. van. 1990. Some aspects of the role of organic matter in sustainable intensified arable farming systems in the West-African semi-arid-tropics (SAT). *Fertilizer Research* 26: 299–310.
- SRCVO. 1978. *Aperçu sur le laboratoire des sols SRCVO, Sotuba*. IER (Institut d'économie rurale), Bamako (Mali).
- UNESCO (Organisation des Nations Unies pour l'éducation, la science et la culture)/PNUE (Programme des Nations Unies pour l'environnement)/FAO (Organisation des Nations Unies pour l'alimentation et l'agriculture). 1981. Ecosystèmes tropicaux. Dans la collection: *Recherche sur les ressources naturelles*. n° XVI; p. 126 à 135.

# Nitrogen intake and losses by sheep on *Medicago* spp and barley pastures in northern Syria

*P. White, A.V. Goodchild, T.T. Treacher and J. Ryan*

International Center for Agricultural Research in the Dry Areas (ICARDA)  
P O Box 5466, Aleppo, Syria

## Abstract

Farming systems of the semi-arid rainfed West Asia and North Africa regions are characterised by cereal cropping, mainly barley, integrated with sheep and goats. Recent emphasis on sustainability and the environmental implications of losses of nitrogenous gases to the atmosphere underscore the need to quantify the role of the grazing animal in nutrient cycling. While the nitrogen (N) and phosphorus (P) contents vary between faeces and urine, they are modified by stage of plant growth and by the physiological status of the animals. In field trials using total faecal collection from lactating ewes at ICARDA (International Center for Agricultural Research in the Dry Areas) in northern Syria (mean annual rainfall 330 mm), total daily N excretion on annual *Medicago* spp pastures fell from April to September (40 to 13 g/d) while the equivalent drop in intake from barley pastures was from 25 to 8 g/d. A large proportion of that N appeared in the urine (about 70% falling to 50% on *Medicago* and 50% falling to 10% on barley). The largest nitrogen output in milk was 8 g/d, on the medic pasture in April. Soil samples were held in controlled laboratory environments to examine the influence of soil type, temperature, moisture and organic debris on volatile loss of ammonia from urine.

## Ingestion et élimination d'azote chez des ovins élevés sur pâturage de luzerne et d'orge en Syrie du Nord

*P. White, A.V. Goodchild, T.T. Treacher et J. Ryan*

Centre international de recherche agricole dans les zones arides (ICARDA)  
P.O.Box 5466, Alep (Syrie)

## Résumé

*Les systèmes de production des régions non irriguées d'Asie de l'Ouest et d'Afrique du Nord sont caractérisés par des cultures céréalières, principalement l'orge, associées à l'élevage ovin et caprin. Compte tenu de l'importance actuelle de la durabilité des systèmes de production et des implications écologiques de l'élimination de gaz azotés dans l'atmosphère, il est impératif de quantifier le rôle des animaux au pâturage dans le recyclage des éléments nutritifs. Les teneurs en azote (N) et en phosphore (P) des fèces sont différentes de celles de l'urine et dépendent en outre du stade de croissance des plantes fourragères ainsi que de l'état physiologique des animaux. Dans des essais en milieu réel effectués à l'ICARDA en Syrie du Nord (pluviométrie annuelle moyenne de 330 mm) sur la quantité totale de fèces éliminée par des brebis en lactation, l'excrétion journalière d'azote total avec les pâturages à *Medicago* sp. annuels diminuait d'avril à septembre (40 à 13 g/j) tandis que l'ingestion équivalente à partir de pâturages d'orge diminuait de 25 à 8 g/j. Une bonne partie de cet azote se retrouvait dans les urines (de 70 à 50% avec la luzerne et de 60 à 10% avec l'orge). L'exportation la plus importante d'azote dans le lait était de 8 g/j sur les pâturages de luzerne en avril. Des échantillons de sol avaient été conservés en laboratoire afin de déterminer l'influence du type de sol, de la température, de l'humidité et des débris organiques sur les pertes d'ammonium volatil contenu dans les urines.*

## Introduction

The climate of developing countries in the Mediterranean region, which comprise countries of North Africa and West Asia, is essentially semi-arid to arid. While irrigation may be important locally in some countries, the region's agriculture is predominantly rainfed; the rain generally ranges from 200 to 600 mm/year and usually falls from November until May, the cropping season. The typical Mediterranean climate is essentially a cool moist season (late autumn, winter and early spring) alternating with a hot dry season. Invariably, the principal constraint to cropping is the limited and inadequately distributed rainfall.

Dryland mediterranean farming is characterised by cereals, i.e. bread wheat (*Triticum aestivum* L.), durum wheat (*T. durum* L.) and barley (*Hordeum vulgare* L.). While the relative proportions of each cereal grown varies from country to country, in general, barley tends to dominate the drier areas and wheat the higher rainfall areas. As farm sizes are smaller than in Europe, virtually all farmers raise livestock, in particular sheep and goats. Fallowing is a common but diminishing feature of the region's farming. Animals are grazed on "weedy" fallow and/or range in the cropping season and on cereal stubble later in the dry season; in very dry years, the barley crop is grazed. In some areas dual-purpose barley commonly provides a source of grazing, grain and straw. Recently, continuous barley cultivation by farmers whose holdings have been reduced by population pressure has become a cause for concern. However, growing self-regenerating *Medicago* species as an alternative to fallowing is seen as having potential benefits for increasing animal feed and reducing the need for fertiliser nitrogen through biological nitrogen (N) fixation.

Grazing systems in the region are complex, often with considerable movement of sheep to seek pastures or crop residues. As farmland is unfenced and farm holdings are fragmented, sheep are generally grazed by day under the supervision of a shepherd and driven to an enclosure for the night. The accumulated manure is periodically spread in adjacent fields or sold. An important linkage in the N cycle is the removal and return of nitrogen in the urine and faeces of ruminants. Does the system maintain or deplete soil N and how does it affect the cereal crop? The study reported here is the first attempt at ICARDA (the International Center for Agricultural Research in the Dry Areas) to address aspects of N in animal excreta.

Specific objectives included measuring (1) the amount of N returned to the fields, the form (urine or faeces) it was returned in and how the relative amounts of faecal and urinary N varied with seasonal changes of pasture intake and quantity; (2) the proportion of N which was not returned to the field in night-time urine and faeces, and in milk; and (3) the order of magnitude of volatile losses from urinary urea.

## Materials and methods

### Nitrogen excreted

To quantify nitrogen flows between pasture and sheep, an experiment was conducted in the 1990/91 season at Tel Hadya, Aleppo, Syria. The area has a mean annual rainfall of 330 mm falling largely in November–April, and an altitude of 300 m. Six plots (0.77 ha each) were fenced on a deep calcareous clay soil (Calcixerollic Xerochrept). Three of the plots were sown to barley while the other three were managed so as to allow regeneration of an annual *Medicago* spp pasture dominated by *Medicago rigidula*. Six lactating Awassi ewes per plot grazed the area during the day (0700–1730 hours) and were removed at night and housed, following the local practice.

Faecal collection bags, lined with polythene bags which contained 500 g of commercial cat litter (Sanicat<sup>TM</sup>), were fitted to the animals to collect the total faeces and urine produced; this mixture was termed "slops". The bags were changed when the animals left the field each evening and again when they were put out to graze in the morning. A grab sample of faeces was taken directly from the rectum of each sheep every time the bags were changed.

The quantities of N in the urine and faeces were calculated from the total N in the slops, the quantity of acid-detergent fibre (ADF) in the cat litter and slops, and the ADF:N ratio in the grab sample. Each collection period lasted seven days and was repeated monthly, beginning in early April until early July, and once again at the beginning of September. At that time, all plant material in the *Medicago* spp plots was grazed. After 1 July, energy and N intake were increased to around maintenance levels by feeding sheep a supplement of 200 g/day barley grain on *Medicago* spp grazing or 100 g/day cottonseed cake on barley grazing.

### Nitrogen volatilisation

It is assumed that in temperate conditions at least, a large part of the urea deposited on the soil in urine will be converted to ammonia and volatilised before plants can take it up. ICARDA plans to study the fate of N deposited as urine on soil in semi-arid conditions. Soil samples will be kept in natural and controlled environments on which urea solutions or urea will be added in the same manner as female sheep urinate to study retention of ammonia and nitrate N in the soil and the volatile loss of ammonia into the air above. Variables such as soil type, surface crust and organic debris, air and soil temperature, soil moisture, and volume and urea concentration of urine are considered relevant.

In the hot, dry summers in the barley zone of Syria, sheep graze cereal stubble and produce 100–400 ml/day of urine containing about 1000 mg N per litre. The concentration of urea in the urine of sheep fed N-limiting diets is less than 100 mg/litre (Cocimano and Leng, 1967). The volume of a single urination by a ewe grazing cereal stubble, measured by digging up wetted soil and comparing its water content with blank soil, is in the order of 50–100 ml. Soil wetted by a urination cohered together, and was shaped like an inverted dome 8–10 cm in diameter and 4–5 cm in depth.

A pilot trial on the fate of dilute urea solutions was carried out at Tel Hadya, north-west Syria, on a calcareous clay soil that had been lightly fertilised with urea. The results are presented here as an illustration of the technique and an indication of the kind of results that one may expect, rather than as a conclusive report. A cylindrical stainless steel box 40 cm in diameter and 30 cm tall that could be forced in the soil to a depth of 5 cm was made. It was covered with a perspex lid with a rubber sealing gasket.

During the trial of this technique, the air temperature ranged between 18°C at night and 36°C during the day. At 0800 hours a 100-ml dose of water, ammonium or urea solution was poured in a manner imitating a single urination by a ewe. The temperature inside the steel box approached 60°C at mid-day and condensation formed. An aquarium pump, powered by a single lead-acid cell (nominal 2.0 volts), pulled air from the steel box through two conical flasks containing 50 ml of 6% saturated boric acid solution at the rate of one litre/minute. The second boric acid flask was used to detect any escape of ammonia from the first flask. Both flasks were changed at intervals and were electronically titrated with 0.01 N sulphuric acid to pH 5.0 to show the time-course of release of gaseous ammonia from the soil. After 72 hours, the soil wetted by the solution and some surrounding soil was dug up, mixed, weighed and sampled for concentrations of N fractions. Ammonia, nitrate and urea were analyzed using magnesium oxide (MgO), Devarda's alloy, and phosphate-buffered urease/MgO, respectively. Soil was taken from a neighbouring dry area to the same depth (approx 5 cm) to allow an estimate of background N.

### Results and discussion

Herbage N concentration, calculated nutrient intakes and faecal outputs are shown in Table 1. The measured N concentration of *Medicago* pasture in June was inexplicably low and nitrogen intake appeared to surpass animal nitrogen requirements (ARC, 1980). Faecal output remained relatively constant within pastures at about 700 g/day on *Medicago* pasture and 500 g/day on barley pasture.

The distribution of nutrient output between day (10.5 hours) and night (13.5 hours) is shown in Table 2. Between 47% and 54% of the total urine and faeces was deposited on the field ("daytime")



in any period and treatment (Table 2). The sheep spent 44% of their day on the field, implying that the hourly rate of N excretion was 1.3 times as high on the field as it was in the night housing. The quantity of N returned in urine and faeces to the paddocks during the daytime was less than the intake of N except when cottonseed cake was fed as a supplement (barley pasture, last two periods). In the first two periods the 24-hour excretion of N was less than N intake. The N in milk, wool and body weight change sets a limit to the quantity of N that can be returned to the pasture.

**Table 1.** Faecal dry matter output, herbage N concentration and *in vitro* dry matter digestibility, dry matter intake and nitrogen intake, for five periods and two pastures.

Period/ pasture	Faecal output (kg DM/d)	Herbage N concentration (g/kg DM)	Dietary IVDMD <sup>1</sup> (g/g)	Dry matter intake <sup>2</sup> (kg/day)	Nitrogen intake (g/d)
April 4–10					
<i>Medicago</i> spp	0.68	33	0.76	2.83	94
Forage barley	0.45	18	0.74	1.74	31
May 3–9					
<i>Medicago</i> spp	0.54	27	0.71	1.88	53
Forage barley	0.44	14	0.74	1.77	25
June 7–13					
<i>Medicago</i> spp	0.67	11	0.50	1.37	15
Forage barley	0.46	9	0.60	1.21	11
July 5–11					
<i>Medicago</i> spp	0.82	22, (25) <sup>3</sup>	0.32, (0.87)	1.28, (0.18)	28, (5)
Forage barley	0.57	6, (48)	0.57, (0.56)	1.26, (0.09)	7, (4)
September 1–7					
<i>Medicago</i> spp	0.58	15, (23)	0.27, (0.87)	0.71, (0.18)	11, (4)
Forage barley	0.59	4, (55)	0.51, (0.60)	1.15, (0.09)	5, (5)

1. IVDMD = *in vitro* dry matter digestibility.

2. Calculated from faecal DM output and IVDMD.

3. Figures in parentheses refer to the hand-fed supplement (barley grain or cottonseed cake) for the respective pastures.

Even so, the N in milk never exceeded 14% of N intake, N in wool was probably about 1 g/day (ARC, 1980) or 4% of average N intake, and body weight change was unlikely to contain more than 10% of N intake (calculated on the assumption that body weight change was 200, 100, 0, 0 and 0 g/day in the five periods, respectively (ARC, 1980). The largest absolute daily removal of N from the field occurred during the growing season (April and May) when the diet had a higher N concentration and the herbage intake was high. Calculations of N retention (N intake minus N lost in faeces, urine and milk) give figures not significantly different from the N in body weight change, except on *Medicago* spp pasture in the first period, when the retention appeared to exceed 46 g/day. In that case, urine was voluminous and loss of urine from the bags had been observed.

The proportion of the excreted N contained in the urine changed during the experiment. On *Medicago* spp pasture it decreased from at least 70% in the first two months to just under 50%; on barley grazing it fell from 50% to 10%. The N intake from the supplementary feed in the last two periods was about 5 g/day; for sheep eating low-N barley stubble grazing this represented 50% of the total N consumed. As sheep were not producing anything but wool, urinary and faecal N was presumably increased by an amount almost equal to that fed as supplement. Where diets contain significant amounts of supplementary feed, the nutrients contained in the supplement would have an important role in increasing soil nutrients including N, P and potassium.

**Table 2.** Output of nitrogen<sup>1</sup> in faeces and urine of sheep grazing *Medicago* spp or barley pastures.

Period/ pasture	Faecal N		Urinary N		Total N in excreta		
	Daytime	Night	Daytime	Night	Daytime	Night	Urine% <sup>2</sup>
----- g/d -----							
April 4-10							
<i>Medicago</i> spp	11.8	8.1	7.9	12.1	19.7	20.3	50
Forage barley	7.4	5.1	5.1	7.1	12.5	12.2	50
May 3-9							
<i>Medicago</i> spp	5.0	5.4	11.9	12.5	16.9	17.9	70
Forage barley	3.4	4.2	4.0	3.7	7.4	7.8	50
June 7-13							
<i>Medicago</i> spp	5.4	5.6	4.5	4.0	9.9	9.6	43
Forage barley	4.7	3.5	1.6	3.2	6.3	6.7	37
July 5-11							
<i>Medicago</i> spp	5.0	6.4	5.4	4.3	10.4	10.7	46
Forage barley	4.4	4.8	2.5	3.2	6.9	7.9	38
September 1-7							
<i>Medicago</i> spp	4.1	2.7	2.7	3.6	6.8	6.3	48
Forage barley	4.2	3.4	0.4	0.5	4.5	3.9	10

1. Nitrogen output in milk in the first three periods was 7.4, 4.4 and 0.6 g/day on *Medicago* spp pasture and 4.3, 2.5 and 1.2 g/day on forage barley.

2. As a proportion of the total excreta.

Less than one-tenth of applied urea N could be detected in volatilised ammonia in the first 72 hours of application (Table 3). The rate of volatilisation of urea varied between runs and was greatest during the first day. In the soil, about half of the applied urea was recovered as urea, half as ammonium and 0-10% as nitrate (Table 4). Volatilisation was low despite the high calcium carbonate content of soils. One may hypothesise that hot, dry, virtually sterilising conditions reduce the rate of ureolysis, and that the water in the dilute urea solution distributes the urea through a relatively large volume of soil. When ammonia is released, it is already in close contact with clay-rich soil particles, which have a cation exchange capacity exceeding 50 meq/100 g soil. The cohesive surface layer of damp clay which formed may have helped to trap ammonia in the soil.

**Table 3.** Cumulative percentage volatile losses of ammonia from two sources.<sup>1</sup>

Nitrogen source	Time period (hours)				
	0–3	3–8	8–24	24–48	48–72
Ammonium sulphate	4.9	–	5.2	–	5.9
Urea, run 1	0.8	–	1.2	1.5	1.6
Urea, run 2	0.5	3.6	3.8	4.2	4.7

1. Applied as 10 mg N in 100 mg deionised water.

**Table 4.** Net recovery of nitrogen<sup>1</sup> after 72 hours.

Nitrogen source	Nitrogen fraction				
	Volatile losses	Soil ammonium	Soil nitrate	Soil urea	Total
Ammonium sulphate	5.9	45.8	10.1	–	61.8
Urea, run 1	1.6	48.9	–3.3	56.6	103.8

1. Applied as 10 mg N in 100 mg deionised water.

The findings will be relevant to sheep grazing cereal stubble and probably also to sheep grazing saltbushes (e.g. *Atriplex* spp). They consume a large proportion of non-protein N which is not all available to the rumen microflora because of a fermentable energy shortage (ARC, 1980), and they need to excrete quantities of water in their urine to dispose of the salt load. The sheep excrete a large volume of urine containing significant quantities of urea at a relatively low concentration; if the results of the pilot trial are valid, one may expect good retention of nitrogen in the soil from this urine.

## Conclusions

Given the current urgency in dryland agricultural research to address issues of sustainability, it is of crucial importance that all phases in the complicated N cycle be quantified. Thus, it may be possible for researchers to pinpoint ways in which the farmer can optimise N use. Clearly, what happens to N deposited as faeces and urine in the field is a "grey" area in our knowledge of livestock-cereal systems in Mediterranean environments. The grazing trial described here at least sets the tone for future work in that area. Although volatile losses from urea solutions were not severe, the range of conditions in the field were not fully simulated.

In typical sheep management systems in Syria, urine contains a significant part of nitrogen excreted, and about half of the nitrogen in the urine and faeces of sheep is not deposited on the grazing land. Nitrogen in urine produced whilst grazing alkaline soils in summer, in particular urea N, may be better conserved than is generally thought, and work on that topic should be expanded. New studies need to commence on the fate of nutrients in urine and faeces excreted at night. Although the efficient use of the manure (which crops? what time to apply?) are questions likely to be asked by crop producers, the fertiliser value of the manure used is largely the responsibility of the livestock keeper. Prevention of nutrient loss during storage, and treatments needed to ensure adequate mineralisation of nutrients in the manure such as composting are, in our opinion, topics which should be tackled by broad-sense livestock farming systems research which is within the mandate of ICARDA and other CGIAR centres.

## **References**

- ARC (Agricultural Research Council). 1980. *The nutrient requirements of ruminant livestock*. Commonwealth Agricultural Bureaux, Farnham Royal, Slough, UK. 351 pp.
- Cocimano M R and Leng R A. 1967. Metabolism of urea in sheep. *British Journal of Nutrition* 21:353–371.

# Carbon and potassium dynamics in grass/legume grazing systems in the Amazon

C.E. Castilla,<sup>1</sup> M.A. Ayarza<sup>2</sup> and P.A. Sanchez<sup>3</sup>

1. ICRAF/CPAF-RO, C. Postal 406, Porto Velho, Rondonia, Brazil. CEP 78900-000
2. CIAT/CPAC, C.P. 08.223, 73.301/970 Planaltina, Brasil
3. International Centre for Research in Agroforestry (ICRAF), P O Box 30677, Nairobi, Kenya

## Abstract

Pastures in the Amazon are mismanaged. Adapted low-input pastures can, however, be sustainable, productive and ecologically sound. Two separate trials were undertaken to study the effects of grazing on potassium (K) and carbon (C) dynamics on a *Brachiaria humidicola* x *Desmodium ovalifolium* mixture in the Amazon region. For K, despite high rainfall conditions, losses (below 100-cm depth) in bare plots were detected only at high application rates of K (300 kg/ha). Losses were minimised by K retention in specific absorption sites in small quantities of 2:1 minerals. Retention mechanisms included high dry-matter production and K luxury consumption; residues were also an efficient recycling mechanism. Without animals K losses appeared to be negligible. The animals modified the amount and composition of returned K, especially in urine. They therefore disrupt rather than enhance K cycling. Uneven and localised spots of high K return (465 kg K/ha) occurred and annual leaching losses of 30 to 94 kg K/ha may occur. For C, under a wide range of grazing conditions, maximum faecal C inputs were 3.9 t/ha per year and compared to leaf litter, were the main source of C above ground. Stocking rates did not affect root-distribution patterns with depth, grazing stage and rainfall patterns. Grazing, however, increased the amount of dead roots which increased the estimate of root productivity (2.4 t/ha per year). Soil physical and biological properties were affected by stocking rate but soil chemical properties were not. Bulk density increased with increasing stocking rates but decreased when the animals were removed, suggesting that trampling is a reversible and temporary effect. Increasing stocking rates did not affect root biomass, suggesting that trampling *per se* is not detrimental to plant production. However, earthworm biomass dropped precipitously when the pasture was overgrazed. Earthworms may be better indicators of soil damage or degradation than soil physical or chemical properties.

## Dynamique du carbone et du potassium dans les systèmes de pâturage à graminées et légumineuses en Amazonie

C.E. Castilla,<sup>1</sup> M.A. Ayarza<sup>2</sup> et P.A. Sanchez<sup>3</sup>

1. ICRAF/CPAF-RO, C. Postal 406, Porto Velho, Rondonia (Brésil) CEP 78900-000
2. CIAT/CPAC, C.P. 08.223, 73.301/970 Planaltina (Brésil)
3. Centre international pour la recherche en agroforesterie (ICRAF), P.O. Box 30677, Nairobi (Kenya)

## Résumé

Les pâturages d'Amazonie sont mal gérés, alors que les pâturages à faible niveau d'intrants mais adaptés peuvent être viables, productifs et écologiquement durables. Deux études distinctes ont été effectuées afin d'observer l'effet de la pâture sur la dynamique du potassium (K) et du carbone (C) dans un pâturage mixte à *Brachiaria humidicola* et *Desmodium ovalifolium* en Amazonie. En ce qui concerne le potassium, malgré une forte pluviométrie, des pertes (au-delà de 100 cm de profondeur) n'ont été décelées dans des parcelles nues qu'à des doses d'application élevées (300 kg de K/ha). Ces

*pertes étaient réduites par la fixation du potassium dans des sites d'absorption spécifiques en faible quantité et ce, dans des proportions d'éléments minéraux de 2 contre 1. Les mécanismes de rétention comprenaient une forte production de matière sèche et une consommation de luxe de potassium. Les résidus contribuaient également de manière efficace à ce recyclage. Les pertes étaient négligeables en l'absence des animaux. Ceux-ci modifiaient la quantité et la composition du phosphore recyclé, notamment dans l'urine. Par conséquent, les animaux perturbaient plutôt qu'ils n'amélioraient le processus de recyclage. De temps à autre, les teneurs en potassium étaient très élevées (465 kg/ha). Les pertes par lessivage pouvaient atteindre 30 à 94 kg de K/ha/an. En ce qui concerne le carbone, les apports maximum des matières fécales dans des conditions de pâturage très diverses étaient de 3,9 t de C/ha/an et, par rapport aux litières de feuilles, constituaient les principales sources de carbone aérien. Les taux de charge, la profondeur, le stade de pâturage et la distribution des pluies n'avaient aucun effet sur la répartition des racines. La pâture augmentait la quantité de racines mortes, ce qui accroissait l'estimation de la productivité des racines (2,4 t de C/ha/an). Le taux de charge influençait les propriétés physiques et biologiques du sol mais pas ses propriétés chimiques. La densité globale augmentait avec la charge mais diminuait en l'absence des animaux, ce qui signifie que le piétinement avait probablement un effet réversible et temporaire. L'augmentation de la charge n'influençait pas la biomasse racinaire, ce qui signifie que le piétinement en soi n'était peut-être pas nuisible à la production végétale. Toutefois, la biomasse des vers de terre chutait rapidement en condition de surpâturage. Ces derniers pourraient constituer un meilleur indicateur de la dégradation que les propriétés physiques ou chimiques du sol.*

## Introduction

Of the 630 million hectares originally under forest in Latin America over 50% are still intact, but a 34% reduction in forest cover has already occurred (Myers, 1989). Much of this has been converted into pastures (INPE, 1989), the traditional agricultural system, because the widespread acid soils were not attractive for agriculture (Meirelles de Miranda, 1974). There are 250 million head of cattle in tropical America — 10 times as many as in South-East Asia and twice those in Africa (CIAT, 1987). Despite research efforts to broaden agricultural alternatives, the agronomic failure of the traditional pasture species (CIAT, 1987; Hecht et al, 1988; Serro and Toledo, 1990) and the resulting degradation (Uhl et al, 1988), deforestation and pasture development continue because of a host of social, political and agricultural factors that make pastures attractive (Janzen, 1986; Hecht, 1989).

Once a forest is cleared, the preservation of the soil resource for eventual forest regeneration or other agricultural activity becomes the main concern. The improvement of degraded pastures with low input pasture systems can have an ecologically acceptable role in the reclamation of degraded landscapes through significant increases in their productivity and thus by reducing the pressure for further deforestation (Sanchez and Salinas, 1981; CIAT, 1990). Fertile lands have already been released to crop production, especially in Brazil and Colombia (CIAT, 1987); Brazil has restored an estimated one million hectares of degraded pasture (Serro, 1990). With the right incentives, there is hope that in the 1990s adoption of technology for improved pastures will be massive, in pastures alone or in combination as agropastoral or silvopastoral systems (CIAT, 1990; Serro and Toledo, 1990).

Our research aimed to provide process-oriented data to evaluate the potential effects of improved pastures on soil parameters, specifically under the hot humid conditions of udic isohyperthermic soil moisture and temperature regimes. The results of a long-term grazing experiment under semi-commercial conditions in Yurimaguas, Peru, where, with judicious use of fertilisers and a simple animal rotation, three legume–grass associations, produced satisfactory animal production without additional N application (Ayarza et al, 1989; Castilla et al, 1991) encouraged this study. The general hypothesis that despite the significant increases in the stocking rate, low-input pastures allow long-term sustainable production without deterioration of the soil resource was tested.

Two independent processes were studied in detail: 1) potassium dynamics, because of the potential for leaching under high rainfall conditions and acid soils with low cation exchange capacity dominated

by 1:1 clays and 2) carbon dynamics, focusing on soil organic matter (SOM) dynamics as a predictor of the system stability. The long-term effects of trampling on the chemical, physical and biological properties of the soil were also monitored because of their importance in pasture productivity.

## Materials and methods

### Site description

The study was conducted on a 20-year-old abandoned pasture at the Yurimaguas Experiment Station, Peru ( $5^{\circ}46'S$  latitude, 182 m altitude and  $26^{\circ}C$  mean annual temperature). Annual rainfall (2200 mm) is well distributed through the year, with a drier season from June to September (Figure 1). The soil was classified as a fine loamy siliceous, isohyperthermic Typic Paleudult. The clay fraction consists of 65% kaolinite, 10% interstratified mica, 10% iron and aluminium oxides, 10% interlayered smectites and 5% vermiculite. Less than 10% weatherable minerals are present in the sand fraction. Initial soil characterisation is shown in Table 1.

**Figure 1.** *Precipitation in Yurimaguas.*

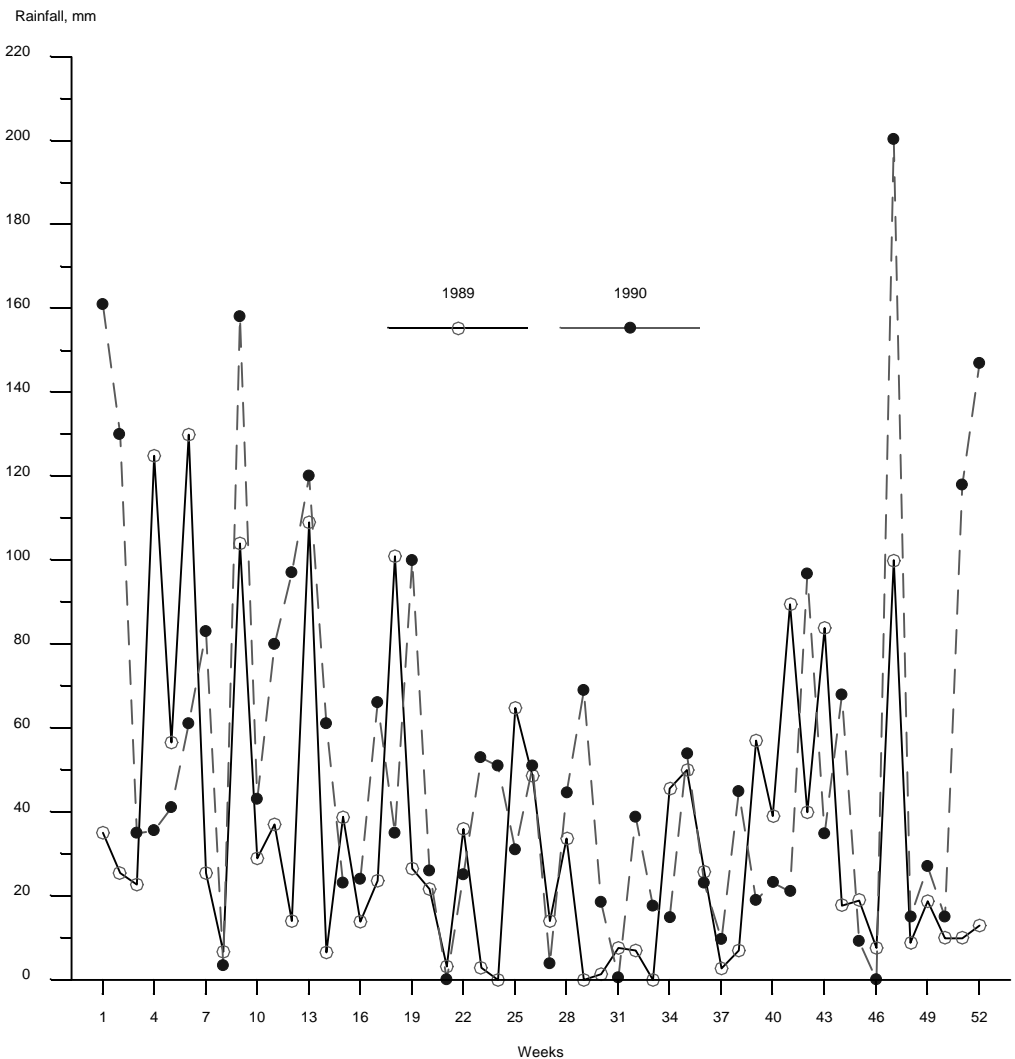

**Table 1.** Selected chemical and physical characteristics of the Ultisol used in the experiment (mean of three replications).

Depth (cm)	Sand	Clay	OM	pH	Exchangeable				ECEC	ECEC of clay	Al sat (%)
					Al	Ca	Mg	K			
-----%-----			-----cmol/litre-----								
0–5	48	17	2.64	4.7	2.13	0.65	0.17	0.13	3.08	17.6	69
5–20	46	20	1.34	4.8	3.17	0.38	0.08	0.06	3.69	18.6	85
20–40	42	24	–	4.8	4.30	0.24	0.03	0.05	4.47	19.2	92
40–60	40	27	–	4.7	5.27	0.23	0.03	0.05	5.57	20.8	93
60–100	38	33	–	4.5	6.50	0.23	0.03	0.06	6.83	20.7	95

## Experimental procedures and design

Before the pasture was planted in December 1984 the vegetation was burned and residues incorporated to 15 cm. The improved pasture was a *Brachiaria humidicola*–*Desmodium ovalifolium* (BH x DO) mixture. Basal fertilisation was 22 kg/ha of P, 100 kg/ha of Ca, 20 kg/ha of Mg and 20 kg/ha of S, broadcasted and incorporated to 15 cm. Maintenance fertilisation was applied 17 months after planting, with the same levels of nutrients except Ca.

For the initial grazing trial (K study) treatments were two stocking rates (the main plot: 3.3 and 6.6 animals/ha) and three K rates applied once (0, 50 and 100 kg K/ha) in a split-plot design, with three replications (plot size was approximately 40 x 50 m). For bare plots and clipping trials, an adjacent area (40 x 47 m) was established using a split-plot design with three replications. Main plots were: 1) bare soil, 2) plots with clippings removed and 3) plots with clippings returned. There were seven sub-plots with single K rates of 0, 25, 50, 75, 100, 150 and 300 kg K/ha as KCl, in a randomised complete block.

For the second trial (C study) the experiment was modified in 1989. The legume (DO) had declined to less than 5% of total above-ground biomass but the grass (BH) biomass productivity was still adequate. Of the initial treatments, only the four plots fertilised with K were used. To eliminate previous K treatment differences, a blanket application of 50 kg K/ha was applied and was expected to have only minor effects on biomass production. The new stocking rate treatments were four contrasting stocking rates: 0, 3.3, 6.6 and 8.3 animals/ha, equivalent to 0, 2, 4 and 5 animals/plot and referred to as NG (no grazing), LG (low grazing pressure, unchanged from initial trial), AG (adequate grazing pressure, previously the high stocking rate and also unchanged from the initial trial) and OG (overgrazing). Treatments were arranged in a randomised complete block design with three replications.

## Animal management

For six years the experiment was managed with a cycle of two weeks of grazing and four to five weeks of rest. During a cycle, animals rotated through the three replications of a treatment. Live weights were taken at the beginning of each grazing cycle after overnight fasting and were not replicated. Animals were

One to two-year-old, Cebú-Brown Swiss steers weighing initially 150–200 kg and replaced after approximately seven to eight grazing cycles.



## Herbage characterisation

Forage biomass was exclusively from BH or DO. For all treatments that included animals total above-ground biomass (TAB) was estimated only in 1989–90, before and after grazing, within 10 random 0.25 x 0.25 m quadrants cut at ground level. Available biomass (AB), the proportion of TAB available for animal intake, was estimated before and after grazing for the K study (before grazing only for the C study) with 10 random 1 m<sup>2</sup> samples. For the K trial, cutting height was 15 cm; for the C trial a differential height was used: 15, 7, 4 cm, above ground for the LG, AG and OG treatments, respectively.

Samples were separated into live or dead and grass or legume components. Detached plant parts were collected only for TAB and leaf-litter estimates. Plant parts were dried to constant weights and the results expressed as dry matter per hectare. All plant parts were ground to pass through a 1-mm mesh screen, and analysed for C and N in a Perking-Elmer PE CHN analyser.<sup>1</sup> Lignin (ash-free basis) was indirectly determined by permanganate extraction (Goering and Van Soest, 1970). *In vitro* dry-matter digestibility (IVDMD) for AB was determined by a modified Tilley and Terry procedure (Burns and Cope, 1974).

Faecal output (FO) was calculated with an intraruminal device (IRD),<sup>2</sup> which constantly releases Cr<sub>2</sub>O<sub>3</sub>. Faecal output was estimated in groups of four animals weighing on the average 200, 240 and 280 kg and grazing at 6.6 animals/ha. At different weights, IRD's were not given to the same animals because dosed animals gained weight at different rates. For periods of 20 days after IRD dose, a single faeces collection from each animal was made between 0700 and 0900 hours each day. Faecal Cr<sub>2</sub>O<sub>3</sub> content was determined in 2 g of dry faecal matter by the perchloric acid method (Kimura and Miller, 1957). Internal standards using ground IRD were run to correct for recovery losses.

## Root sampling

At each sampling date, 15 random subsamples were taken per plot with a 41 mm internal diameter corer. Soil separation was done in a root elutriator the same day (Smucker et al, 1982). Roots were washed for five minutes, trapped in a 500 µm mesh and frozen before separation. Root sampling followed three sampling schemes:

- 1) Intensive (short-term) root sampling: samples every seven days over a 42-day grazing cycle during periods of maximum and minimum rainfall in 1989 and 1990 (a total of 5040 samples).
- 2) Extensive (long-term) root sampling: samples were taken every 42-days beginning March 1989 for 14 cycles. This includes the first and last samples of the intensive sampling for an additional 1800 samples.
- 3) Root distribution with depth: additional cores at 10–30 and 30–50 cm were taken at the beginning of each of the intensive sampling periods. A complete characterisation of the root system was done only in the initial sampling. Roots were divided into live and dead, grass and legume, and fine (<1 mm in diameter) and coarse (<2 mm >1 mm in diameter) fractions.

## Leaf and root decomposition

Decomposition trials were done in an adjacent BH x DO grazed paddock during peak periods of minimum and maximum precipitation, using plastic 1 mm mesh bags containing 1.5 g of fresh live roots. Roots classes were fine (<0.5 mm diameter) and coarse (<2 mm >0.5 mm diameter) intended to represent differences in lignin content. Bags were buried just below the surface. Sampling times were 0, 4, 7, 14, 28, 60, 120, and 180 days. At all sampling times, half of the replicates (four replications) of each treatment were used to correct for ash content and the rest pooled and ground to

1. Perking Elmer Corp., 761 Main Ave., Norwalk. CT 06859–0012. USA

2. Captec Pty Ltd, Nufarm Limited, Manu St., P.O. Box 22–407 Otahuhu, Auckland, New Zealand.

pass through a 1 mm mesh screen and analysed for lignin, C and N. All results are expressed on an ash-free basis as per cent of initial mass.

Decomposition constants,  $k_d$ , were calculated by the NLIN procedure (SAS, 1986) using the log form of the single exponential model  $Y = e^{-kt}$ , where  $Y$  is the proportion of initial mass remaining at each time  $t$  in years (Wieder and Lang, 1982). Decomposition constants ( $k$ , slopes) were compared statistically by pairwise comparisons.

## **Soil chemical properties**

For the K study soil samples were taken on two fixed 50 m transects (five samples per transects) to minimise spatial variability at 2, 12, 32 and 64 weeks after fertiliser application. For the C study samples were taken at random during two periods of maximum and minimum precipitation starting February 1989. Four composite samples were taken at 0–5, 5–20, 20–40, 40–60 and 60–100 cm depth. Samples were extracted with 1M  $\text{NH}_4\text{OAC}$  buffered solution at pH 7 for exchangeable K, and for the C trial analysed for C and N as described before. Available P and exchangeable K were extracted by the modified Olsen extractant (Hunter, 1974). Phosphorus was determined colorimetrically by the molybdenum blue method. Potassium was determined by atomic absorption. Exchangeable Ca, Mg and Al were extracted with 1 M/kg KCl (Hunter, 1974) and determined by atomic absorption. Aluminium saturation was obtained as  $\text{Al}/(\text{Sum of exchangeable Al, Ca, Mg, and K})$ .

## **Soil physical properties**

Soil moisture tension (SMT) was monitored during 1989 with a custom made "miniature" tensiometer. Surface soil bulk densities (DB) were evaluated in each plot with 10 random, 7.6 cm high by 7.6 cm diameter undisturbed soil cores (Uhland, 1950) during two periods of maximum and minimum precipitation starting February 1989. Texture, determined by the hydrometer method (Gee and Bauder, 1986) was the mean of five subsamples per plot. Sand fractionation was done on a nest of sieves of 1000, 500, 250, 106 and 53  $\mu\text{m}$  (Gee and Bauder, 1986).

## **Biological parameters**

Earthworms were sampled during the peak of the 1990 and 1991 rainy seasons (Lavelle, 1988; Anderson and Ingram, 1989). In each plot, five 25 x 25 x 10 cm blocks of soil were randomly excavated, earthworms were hand-sorted and collected in 4% formalin. Eggs were not included in the biomass.

Estimates of microbial biomass C and N were obtained by the fumigation–extraction procedure after Jenkinson and Powlson (1976) as the difference in C or N extracted between a 10-day chloroform-fumigated sample and a control (Vance et al, 1987). Microbial N was estimated as ninhydrin-reactive N from 2M KCl extracts with a ninhydrin reagent and absorbance reading at 570 nm (Amato and Ladd, 1988).

## **Results and discussion**

### **Potassium cycling in a humid tropical pasture**

Potassium dynamics are a special case because well-drained acid soils with a predominance of low-activity clays and low cation retention capacity, under Udic isohyperthermic soil conditions, are considered highly susceptible to leaching. Despite this little quantification has been done on the rate of movement and the magnitude of leaching under field conditions. This study focussed on the evaluation of changes in the soil and plant component of the K cycle as influenced by grazing management and K fertilisation. Further detailed information on the K study is found in Ayarza (1988) and for the C study in Castilla (1992).

## Potassium movement in the soil

When K was added to bare uncultivated soils (small plots), it moved from the surface (0–5 cm) and accumulated in the 5–60 cm depth (Figure 2), where clay content was higher (Table 1). This was explained as a function of the K rate applied and the accumulated rainfall. Leaching losses (below 100 cm) were only detected when 300 kg K/ha was applied, suggesting that the leaching potential in these soils was not as high as expected given the soil properties and the rainfall regime.

To explain the apparent retention of added K, soil samples collected from check plots were incubated with K rates from 0–300 kg/ha and extracted with either  $\text{NH}_4\text{OAC}$  or  $\text{Mg}(\text{OAC})_2$ . Most of the added K was recovered with  $\text{NH}_4\text{OAC}$  suggesting the absence of K fixation mechanisms (Table 2).

**Figure 2.** Potassium balance in bare uncultivated soils.

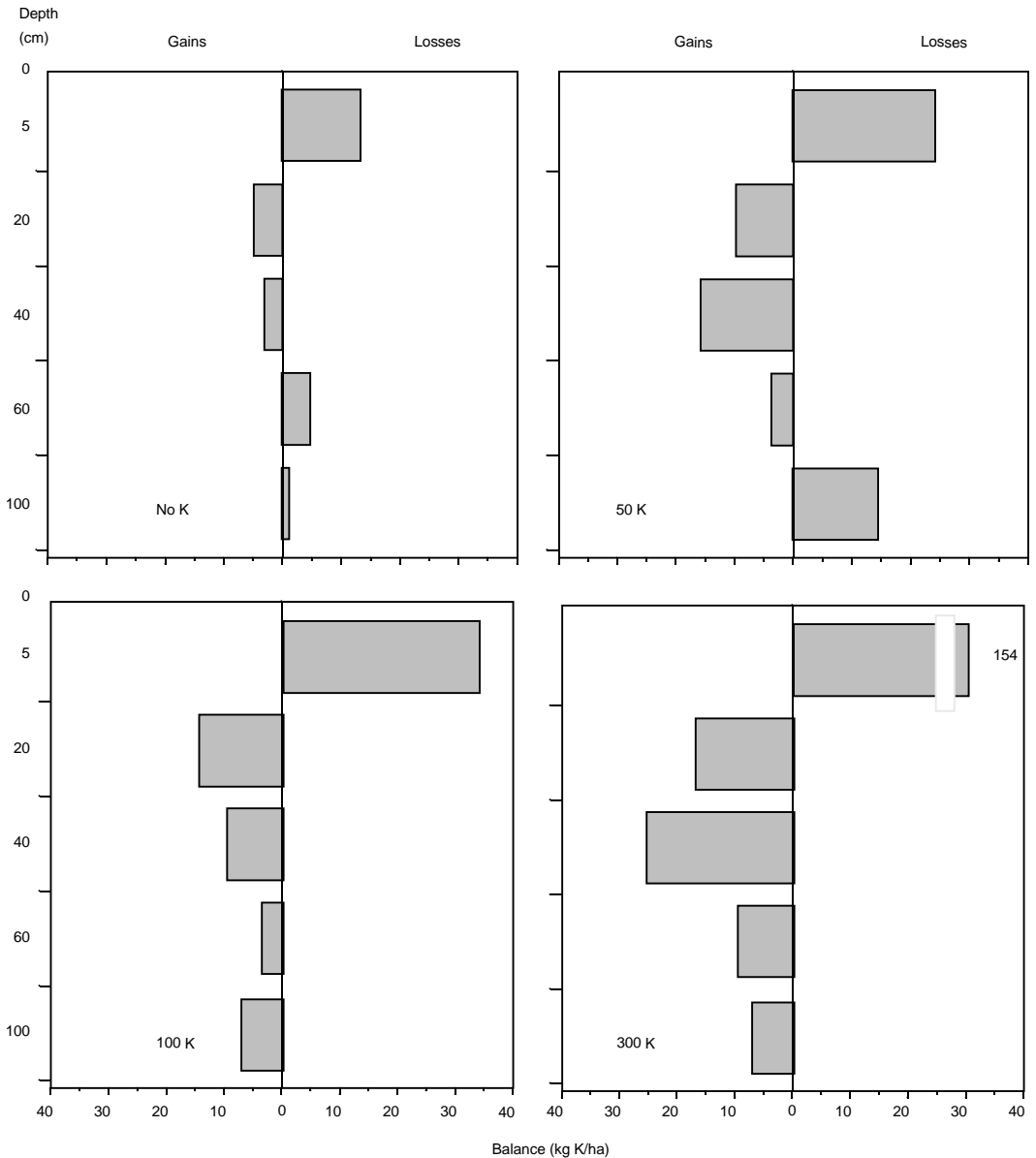

In contrast, one-third of the applied K was retained against extraction with  $Mg(OAc)_2$ . This implied the presence of preferential absorption sites in the exchange complex where K can be exchanged with cations of similar ionic size, like  $H^+$  and  $NH_4^+$ . Because the K retained against  $Mg(OAc)_2$  was easily recovered with  $NH_4OAc$  further confirmation of the existence of preferential absorption sites was obtained. Although the dominant clay is kaolinite (66% of the clay fraction) in these soils, there are also small amounts of partially interlayered smectites and micas where K adsorption can take place.

**Table 2.** Amounts of K removed by a sequential extraction with  $Mg(OAc)_2$  and  $NH_4OAc$  as compared to a single extraction with  $NH_4OAc$ .

Depth (cm)	K added	Sequential extraction			Single extraction $NH_4OAc$
		$Mg(OAc)_2$	$NH_4OAc$	Total	
-----mg/kg-----					
0-05	50	41.1	6.9	48.0	51.4
	100	83.1	9.9	93.0	102.2
	150	132.4	13.5	146.0	151.2
5-20	50	36.0	6.1	42.1	47.8
	100	79.3	11.0	90.3	100.3
	150	129.9	14.1	144.0	152.0
20-40	50	33.8	8.6	42.4	49.4
	100	74.1	17.4	91.5	100.7
	150	117.0	20.8	137.8	150.8
40-60	50	28.3	10.3	38.6	47.8
	100	69.4	20.3	89.7	95.5
	150	111.8	23.7	135.5	146.5
60-100	50	25.3	11.9	37.2	47.8
	100	64.3	20.0	84.3	93.9
	150	106.7	24.1	130.8	148.5

### Plant effects on K dynamics

When plants and plant residues are added to soil they modify K dynamics by further diminishing the amounts of K susceptible to leaching via root interception and plant uptake. In the presence of plants, exchangeable K levels were consistently lower than in bare plots. After 15 months and 2700 mm of rainfall all of the K added as fertiliser at rates below 150 kg/ha was recovered by the pasture (Table 3) because of a high root and above-ground biomass and a high luxury consumption. When plants were harvested and the clippings removed, K exchangeable levels, plant growth and K uptake decreased over time. Nonetheless, plants were able to recover K quantities higher than those disappearing from the soil. When clippings were returned, plants benefitted from the K in the residues and were able to produce higher biomass. However, the efficiency of added K via residues decreased with the increasing K rates.

**Table 3.** Potassium balance in the 0–100 cm soil under a pasture subjected to clipping and removal of plant biomass.

	Potassium added (kg K/ha)						
	0	25	50	75	100	150	300
Disappearance from soil (kg K/ha)	24.7	64.0	93.5	107.2	129.6	174.4	241.5
Total plant uptake (kg K/ha)	96.5	133.4	143.6	191.9	220.0	223.8	324.7
Efficiency of recovery (%):	–	147.0	94.0	126.0	123.0	84.0	76.0
Leaching losses	–	–	2.9	–	–	22.7	71.8

### The effect of animals on K dynamics

Cattle play an important role in nutrient cycling because they modify the amount, composition and distribution of plant and animal residues. Despite the high stocking rate used (3.3 and 6.6 animals/ha) available forage was always in excess, due to the high growth rates of the grass and its low quality which resulted in low animal gains. Nonetheless, above- and below-ground litter biomass decreased with increasing stocking rates. The levels of exchangeable K in the 0–5 cm soil layer increased with higher K rates; this effect tended to disappear with time. No significant changes were detected below this layer indicating little if any downward K movement and suggesting, as in the small plots, that plants reduce K losses.

Animal excretions had a significant effect on exchangeable K in the surface 0–5 cm. An individual urination added the equivalent of 637 mg K to an average area of 0.12 m<sup>2</sup>. Considering the changes in the exchangeable K in the soil and the area affected by each urination, it was estimated that about 53 kg K/ha was returned through the urine. However, urinations were concentrated (63%) near fences and water sources. Faeces (0.65 + 0.15% K) contributed an estimated 38–75 kg K/ha per year and 86% of the K was released one month after deposition.

Potassium pools, fluxes, inputs and outputs calculated for one treatment combination are shown in Figure 3. Potassium inputs were by rain, dust and as fertiliser, while K was removed in animal products and lost via leaching. Measured pools were exchangeable K (0–100 cm), available biomass before and after grazing, above-ground litter (1.1 for low and 1.3 t/ha for high stocking rates with a 2.6% turnover rate), and below-ground litter (1.1 for low and 0.74 t/ha for high stocking rate with a 1.13% turnover rate). Fluxes were decomposition of above- and below-ground litter, urine and faeces. Soil pools are exchangeable K and specifically adsorbed K and did not change with stocking rate fertiliser K addition.

Potassium uptake corresponded closely to the amounts returned through the above- and below-ground litter + faeces + effective urine + rain and fertiliser (Figure 3). The standing residual forage constituted the largest sink for K. The major discrepancy was observed in urine spots. Only 40% of the calculated urine flux was accounted for. Due to high K concentrations in the urine spot, as high as 465 kg K/ha, it is plausible to assume that leaching is a major pathway of K loss from the system under study. Leaching losses can be as high as 94 kg K/ha per year. The budget showed that plant K recycling is extraordinarily efficient. However, animals, via urine redistribution, disrupt rather than enhance K recycling. This results in a net K extraction from most of the grazed area.

### Carbon inputs in a low input pasture

Above-ground C inputs are faecal output (FO) and leaf and stem litter (LL), largely the results of animal management. Below-ground inputs are root exudates and dead roots, and their C contribution is largely unknown. This study concentrated on estimates of root production because this is often

**Figure 3.** Potassium cycle in the treatment with 100 kg K/ha and 6.6 animals/ha stocking rate (numbers are kg K/ha per year).

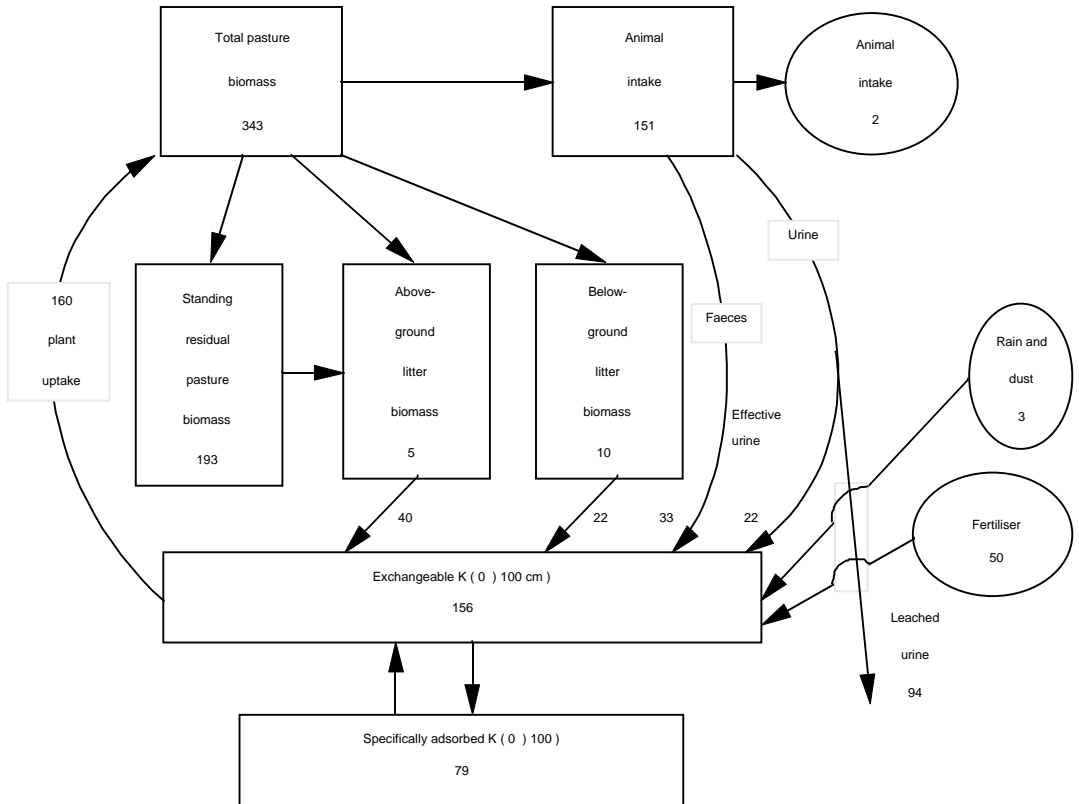

reported to contribute more total organic material than above-ground inputs (Coleman, 1976). However, root biomass is difficult to measure and inherently variable (Böhm, 1979). Furthermore, under Udic isohyperthermic soil conditions there are often small or no changes in live and dead biomass, and fluxes cannot be calculated. Thus, with management (stocking rates treatments) the authors expected to create widely different above-ground conditions thereby reducing further uncertainties caused by root variability. The study tests the hypothesis that changes in above-ground C, as a result of management, should have an effect on below-ground C inputs. The effect of stocking rates on C inputs in a pasture assumed to be at or near equilibrium, which had been grazed for four years and did not show signs of degradation was studied.

### Above-ground herbage characterisation and C inputs

Increasing stocking rate decreased total above-ground biomass (TAB) (Figure 4). This reduction in TAB (95% BH) was due to the animals selecting live biomass. However, there was no difference in the amount of total dead biomass before and after grazing. This result was unexpected as it was thought that differential grazing and trampling would result in differential patterns of leaf litter production. Proportions of live and dead biomass were split fairly even during the experimental period. Available biomass or forage, AB, showed tendencies similar to TAB and closely followed rainfall patterns.

The trends in animal liveweight gain varied according to the grazing treatment (Figure 5) and were similar to those obtained earlier (Ayarza, 1988; Ayarza et al, 1989; Castilla et al, 1991). Daily gains

**Figure 4.** The effect of stocking rate on total above-ground biomass in *B. humidicola* x *D. ovalifolium* pasture.

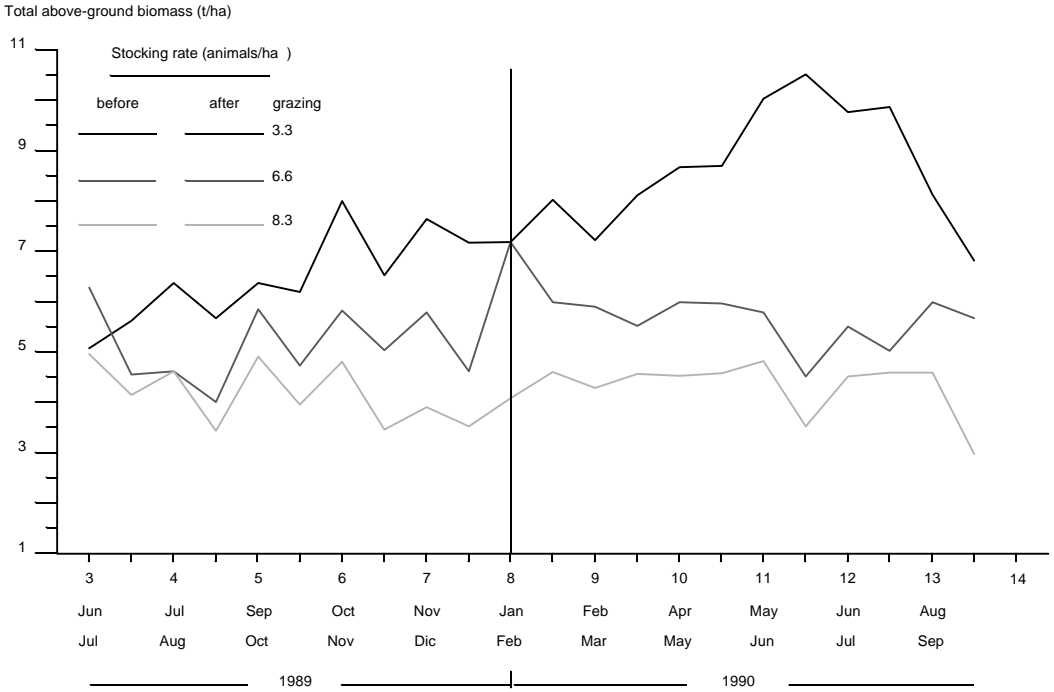

**Figure 5.** The effect of stocking rate on liveweight gain in a 4-year-old *B. humidicola* x *D. Ovalifolium* pasture at Yurimaguas, Peru, during 1989 (animals are 2-year-old Brown swiss x Cebú steers).

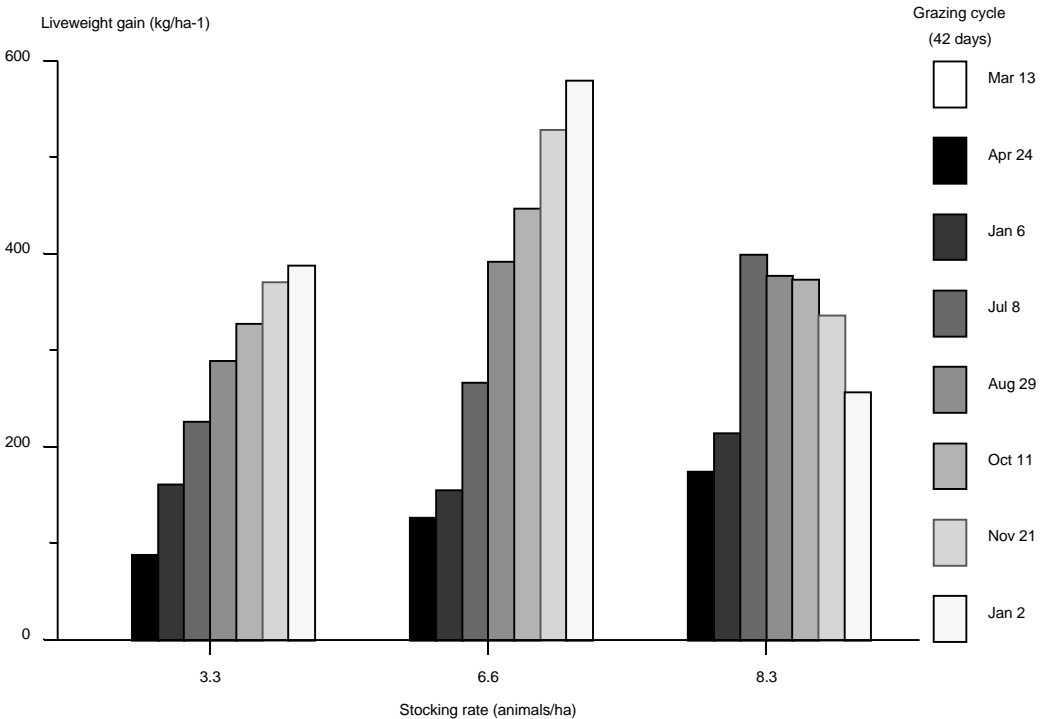

were low and tended to decrease as the grazing season progressed. Animals only lost weight in the overgrazed treatment (8.3 animals/ha). Liveweight gains per hectare were highest with adequate grazing (600 kg/ha) because of the higher number of animals per hectare. On the overgrazed treatment the net gains were attributed to forage carried over from the second trial initiation and will not be repeated in the following years.

According to the algorithm of Fairley and Alexander (1985), estimated net pasture production decreased with increasing stocking rates from 13.9 in the LG to 11.2, and 8.5 t/ha per year in the AG and OG, respectively. Similar results have been reported for grasslands and pastures in other tropical locations (Pearson and Ison, 1987).

Faecal output for animals between 200 and 280 kg live weight was estimated to be between 3.11 and 4.09 kg DM per animal/day ( $FO = 0.52 + 0.01235 * \text{body weight}$ ,  $r = 0.84$ ,  $n = 20$ ). For an average FO of 3.5 kg per animal/day, the estimated yearly faecal output is between 4.2 and 8.4 t/ha for LG and AG treatments and contains approximately 48% C.

Estimates of voluntary forage intake (VI) were made from faecal output (Pond et al, 1987) and *in vitro* dry-matter digestibility (IVDMD) from AB (Burns and Cope, 1974). Estimates were low, not affected by stocking rate, followed rainfall patterns, decreased over time and tended to underestimate true IVDMD because they did not account for animal selection (CIAT, 1986; 1987). Assuming that the true IVDMD of *B. humidicola* is at least 50% (Minson and McDonald, 1987), voluntary intake was twice faecal output, or near 3% of body weight. Similar results have been obtained with low digestibility tropical forages in Colombia (CIAT, 1983) and during summer grazing in North Carolina (Burns et al, 1985).

Both estimates of net pasture production are questionable because of the inherent methodological problems. However, to achieve the measured faecal output, pasture productivity would have had to be at least 16 t/ha per year, not including the contribution of leaf litter. Pasture productivity estimated from total above-ground biomass (Fairley and Alexander, 1985) was only 11 t/ha per year and probably an underestimate since it did not take into account growth and decomposition during grazing. For well-managed pastures under humid tropical conditions faecal output was therefore the best estimate of pasture productivity and is the major pathway for C inputs. Faecal output can be estimated at 1.5% of animal body weight per day. Animals use well-managed pastures efficiently, so for modelling purposes faecal output may contribute 3–4 times as much C as leaf litter. Litter dynamics require more research.

## Root dynamics

This study concentrated on obtaining baseline data on the effect of several contrasting stocking rates on root dynamics. The objectives of the root study were to determine: 1) the effect of stocking rate on root distribution; 2) the effects of stocking rate on root dynamics during a grazing cycle in periods of maximum and minimum rainfall; and 3) long-term seasonal trends. The test grass (BH) is particularly well suited since it is well adapted to acid soils, has a high stolon density and the highest root biomass of several introduced grasses planted in the Amazon basin (Cuesta, 1982).

For roots, there seems to be a lack of consensus on the best way to estimate productivity, but over- and underestimates can be diminished if root samples are taken at sufficiently small intervals to determine "true" biomass peaks, and sorted into live and dead fractions (Fairley and Alexander, 1985; Vogt et al, 1986; Long et al, 1989). These factors, as well as the animal effects, were carefully considered when developing sampling patterns.

## Root distribution with depth

The initial sample (March 1988), taken four years after the trial initiation, showed no significant effects of previous treatments (Ayarza, 1988) on root distribution with depth and remained unchanged during the following two years of this study. Overall, after four years under grazing, total root biomass to 50



cm averaged 5.6 t/ha. Roots were concentrated in the top 10 cm (58%) and decreased with depth. Most of the roots were of BH and only 3% of DO, a similar proportion of above-ground biomass. Dead roots were less than 20% of total biomass in the top 10 cm, but its proportion increased to 25–30% with depth. Fine roots accounted for 90% of the total biomass. These parameters are similar to those reported earlier (Ayarza, 1988).

### The effect of stocking rate

Widely different stocking rates did not appear to affect live root biomass during a grazing cycle (14-day grazing, 28-day rest) during maximum and minimum precipitation. However, the observed trend for increasing dead roots with stocking rate in 1989 became significant in 1990 and was the only consistent response during the two years sampled. Similar tendencies were found for the longer term, 42-day sampling intervals (Figure 6). An earlier root survey using a variable sampling interval found a clear difference between the low and high stocking rates (Ayarza, 1988).

The lack of a constant pattern from year to year, and between periods of maximum and minimum precipitation, makes further interpretation of the data difficult. Only during the second sampling period in 1989 (Figure 6) was there a peak in live-root biomass which could not be related to climate or animal effects. In 1989, a dry year, there was a tendency for lower root biomass during the dry period, but this trend was not as evident in the wet year of 1990 suggesting that if a cyclical pattern is present, it can be detected only in dry years (Persson, 1983).

Despite extreme stocking rates that had a significant impact on above-ground productivity, the lack of changes in root biomass is the primary observation of this study. These results are surprising; it is not known whether two years are enough to detect changes. For low nutrient content soils, Crick and Grime (1987) suggest that "long-lived extensive root systems which remain functional throughout

Figure 6. The effect of stocking rate on long-term root dynamics, Yurimaguas, Peru (sampling interval = 42 days).

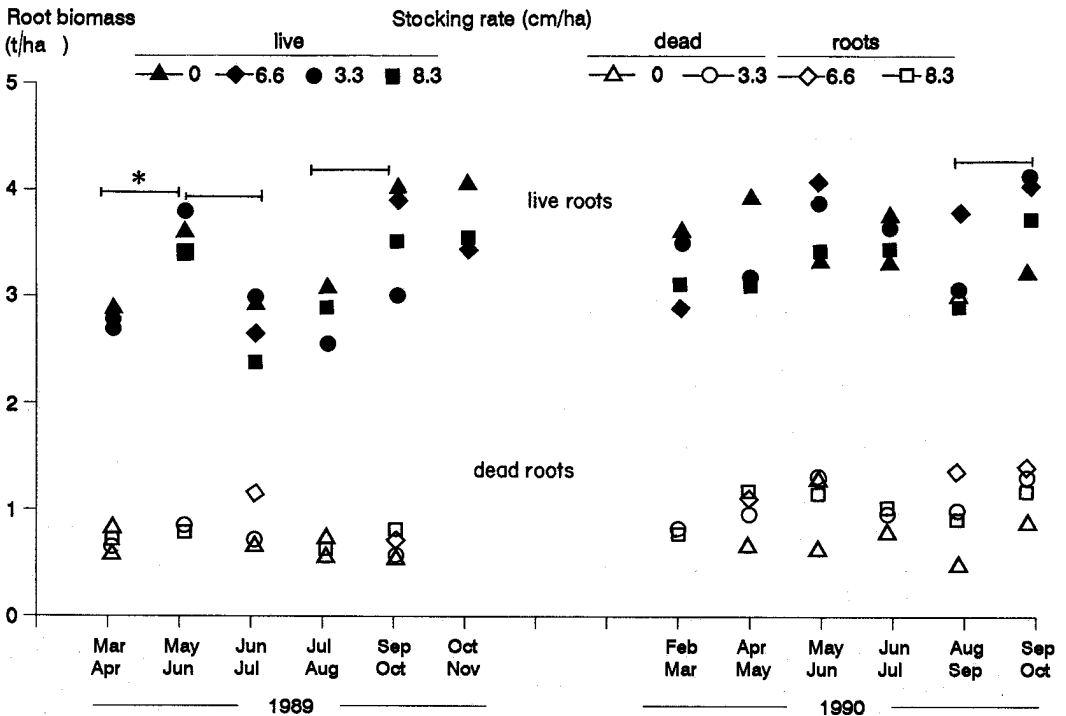

\* Sampling periods joined by a line are significantly different at the 0.05 probability level.

the year but have relatively undynamic patterns of development" are to be expected, and plants may not be able to afford the energy cost of a root system whose biomass actively changes with time. An alternate, but not exclusive explanation is that roots can grow independently of shoot growth because the carbohydrate supply does not normally limit root growth (Persson, 1983).

In the absence of distinct peaks in root biomass and with a stable but different proportion of dead and live roots modified by grazing (Figure 6), average yearly root productivity was calculated as a function of the decomposition rates (Table 4) assuming that at steady state production, mortality and decomposition must be equal. As a result of grazing, the effect of an increased dead root biomass was to increase average yearly root productivity, ranging from 1.1 t/ha per year in a dry year, to 2.4 t/ha per year in a wet one.

**Table 4.** Relative decomposition rate constants,  $k_d$ , of leaves and roots of *B. humidicola* and *D. ovalifolium* (BH and DO) during periods of minimum and maximum precipitation determined by the litter bag method (Figure 7).

Precipitation	Leaves		Roots			
	BH	DO	BH		DO	
			Fine	Coarse	Fine	Coarse
	----- per year -----					
Maximum	8.41a (0.004) a	2.91db (0.001) a	2.91a (0.013) a	2.02 b (0.006) a	4.92 a (0.011) a	3.36 b (0.011) a
Minimum	9.61a (0.005) a	2.91b (0.011) a	2.00a (0.008) b	1.74a (0.005) a	5.52a (0.015) a	2.31b (0.007) b

Comparison for maximum and minimum precipitation period is based on equal periods of up to 56 days of incubation, but  $k_d$  values are reported for 120 days.

Letters besides numbers are pairwise comparisons of species above ground and root diameters within species below ground. Letters below numbers are for comparison between periods of maximum and minimum precipitation.

Numbers in parenthesis are residual mean square errors.

Root-decomposition rates and productivity estimates of this study were lower than those (4.4 to 5.5 t/ha per year) reported earlier (Ayarza, 1988), and those (4.2 t/ha per year) reported for other tropical natural grasslands (Long et al, 1989). For tissues of high lignin content, the maximum decomposition rate (per year) in the Century model was 4.88 (Parton et al, 1987). Root productivity based on decomposition rates is probably an underestimate, because estimates are based on the decomposition rates of arbitrary root diameter classes (Table 4). However, it is not known whether these low decomposition rates were artifacts of the mesh bag itself or due to the chemical or physical properties of the root (Palm and Sanchez, 1990).

When compared to above-ground productivity, the root data suggest that the contribution of roots to SOM is overestimated in the literature. For modelling SOM dynamics in managed pastures in a udic isohyperthermic soil moisture regime, therefore, estimates of root productivity should not be higher than those above ground, and can be partitioned uniformly throughout the year.

## The effect of stocking rates on soil properties

The hypothesis that the increase in stocking rates should not have a detrimental effect on soil properties was tested. This was done because the low-input pasture option targets the recovery of degraded sites, and the increases in productivity are achieved with stocking rates up to five times higher those of the traditional system (CIAT, 1982). Soil moisture conditions at Yurimaguas are ideal for compaction because of near saturated conditions at the surface during most of the year (Figure 1). The soil moisture tension patterns clearly indicated that even in a dry year, as was 1989, there should be enough moisture in the subsoil for plant growth, and adapted plant roots were able to utilise it (Castilla, 1992).

## Soil chemical properties

After six years of grazing, the soil's chemical characteristics reflected the low rates of fertiliser applications and soil amendments used in this study. Soil pH values did not change greatly with time or depth. Exchangeable cations, total C, and available P were concentrated mainly in the 0–5 cm layer. Only at this soil depth was the soil supplied with enough nutrients to produce the high amounts of biomass. Below this layer the dominant cation is Al, with at least 90% Al saturation.

The concentration of nutrients at the surface may be an advantage when the soils are well supplied with water, but not when the soils are dry even for short periods of time (Davies and Zhang, 1991). The combination of moisture deficiency at the surface and high Al contents in the subsoil (where water was available) resulted in a decrease in forage biomass during the dry season (data not shown).

## Soil physical properties

Starting with a four-year-old pasture, the effect of increasing the stocking rate was to increase bulk density (DB) and conversely, when the animals were eliminated, to decrease DB to levels found in forested soils (Cassel et al, 1980) (Figure 7). This suggests that the effect of trampling is reversible in relatively short periods of time.

**Figure 7.** The effect of stocking rate on soil bulk density (0–10 cm) in a four-year-old *B. humidicola* x *D. ovalifolium* pasture, Yurimaguas, Peru.

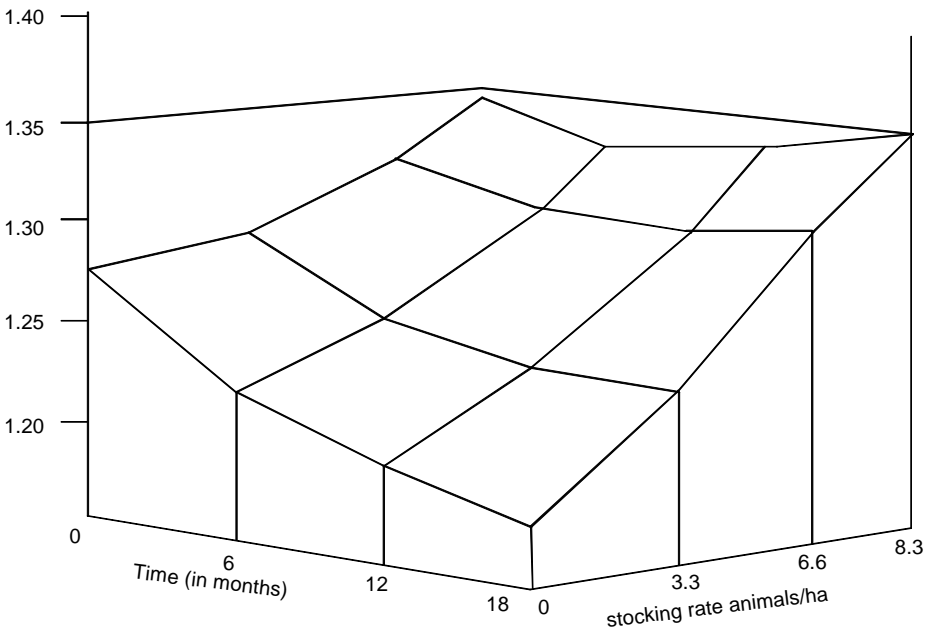

Time 0 = 4 years after pasture establishment.

Despite the significant increases in bulk density, the higher field values, when corrected for texture (Vepraskas, 1988), are close to the root-limiting DB isolines suggested by Daddow and Warrington (1983) for that texture, but still not high enough to limit root growth. This suggests that after two years of severe overgrazing, under ideal conditions for compaction, the increases in bulk density are still not high enough to restrict root penetration, and, therefore, root biomass. Similar conclusions are reported in the Brazilian Amazon (Correa, 1989).

The effect of increasing stocking rate was to decrease total soil-water retention and total porosity. However, effects were significant only from 0 to -10 Kpa, suggesting that only the macropores seem to have been affected by the increased trampling. This suggests that the overall effect of animal trampling was probably of a superficial nature (Cassel et al, 1990).

### Soil biological parameters

Earthworms and microbial biomass are important features of pastures. Both parameters are closely related to nutrient dynamics and soil physical properties, and, therefore of great importance to soil fertility. At Yurimaguas, earthworm biomass in pastures is higher than any other agricultural system including the forest (Lavelle and Pashanasi, 1989).

Extraction estimates of microbial C and N contents were significantly affected by stocking rates during the sampling period (Figure 8). The tendency for extractable microbial C and N was to increase with increasing stocking rates, although there were wide variations from week to week. It is possible that microbial populations were more affected by climatic conditions than by grazing. The increase in extractable C and N with increases in the stocking rate can be explained by the increase in dead roots due to grazing. However, because these changes occurred within a narrow range they may not be enough to have biological significance. This is specially true for microbial N, since the variation over time was greater than the variation due to treatment (Figure 8).

**Figure 8.** The effect of stocking rate on microbial C and N in five-year-old *B. humidicola* x *D. ovalifolium* pasture, Yurimaguas, Peru, 1990.

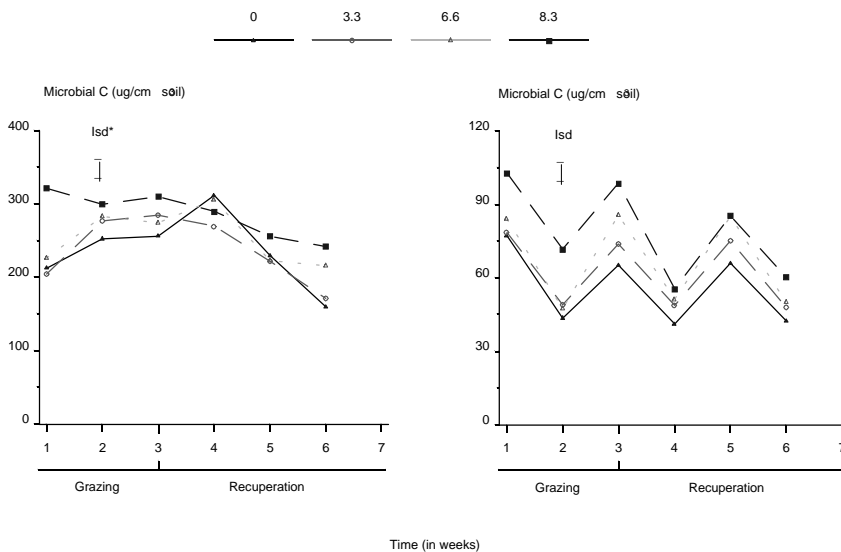

\* Lsd bars are for comparisons of stocking rates over time.

\* Lsd bars are for comparisons of stocking rates over time.

**Figure 9.** The effect of stocking rate on earthworms in a five-year-old *B. humidicola* x *D. ovalifolium* pasture during periods of maximum precipitation, Yurimaguas, Peru.

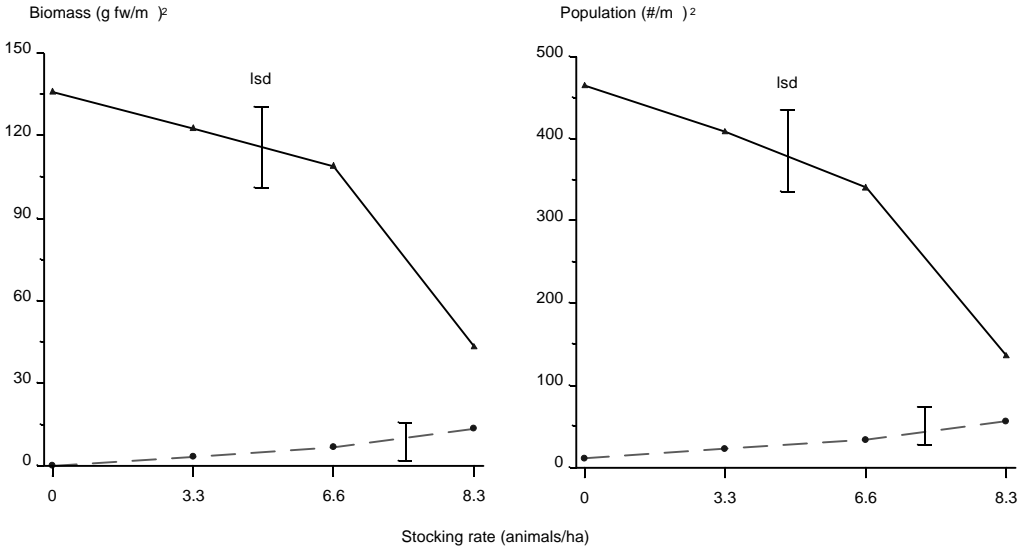

The effect of grazing on earthworms is of particular significance. Earthworm population and biomass were high and similar to those reported earlier by Lavelle and Pashanasi (1989) in the same trial. Overall, the effect of increasing stocking rate was to gradually reduce earthworm populations and biomass. However, it was only in the overgrazed treatment that trampling was severe enough to cause a major decrease in earthworm population suggesting that the beneficial effects of earthworms could no longer counteract the negative effects of trampling (Figure 9). With increases in stocking rate, there was also a gradual species replacement from the abundant, soil-dwelling endogeic species, *Pontoscolex corethrurus*, to the less abundant, surface-dwelling epigeic species, possibly *Dichaeta xepe*.

In the absence of clear differences in soil microbial and chemical parameters, the significant changes in DB can be attributed to the effect of earthworm activity. Earthworms are known to consume significant amounts of soil and can be valuable in assessing "soil damage" and in pasture and land reclamation. As an indicator of soil damage, earthworms may be a far more sensitive parameter than the chemical or physical properties studied. This is because earthworms do not respond to increases in DB alone but to the compound effects of such factors as reduced porosity, increased resistance to penetration, lower oxygen diffusion etc.

## Conclusions

Sustainable livestock production with low-input pastures in humid tropical environments can be achieved with judicious animal management and the eventual use of fertilisers. Nitrogen is supplied by the legume. The changes in soil physical, chemical and biological properties due to increased trampling, even though significant, should not have a negative effect on long-term pasture and animal productivity. A well managed low-input pasture has a very efficient recycling system concentrated in the surface 0–5 cm where most of the roots are. This system allows high biomass production and thus high animal productivity. The effects of earthworms are paramount to effectively neutralise the negative effects of trampling which seem to be of a superficial and reversible nature. It is the uneven distribution of the animal excreta, especially the urine, that makes the system susceptible to nutrient losses.

Low-input pastures are very productive: beef production was about 600 kg of live weight per hectare in 300 grazing days. Net pasture productivity was as high as 16 t DM/ha per year (when estimated from faecal output) and the animal returned half of it to the soil as faecal matter. The results indicate that for forages of low digestibility an animal eats nearly 3% of their body weight as available dry matter per day. The contribution of faeces to SOM processes is around 3.9 t C/ha per year. The contribution of leaf litter to SOM is expected to be much smaller, because when pastures are well managed the animals make good use of pasture regrowth.

Surprisingly, root distribution patterns did not change with stocking rate, grazing period, or rainfall pattern. Despite high root biomass, the only significant effect of grazing was an increase in the amount of dead roots. Assuming steady state, root productivity estimated from relative decomposition rates was 2.4 DM t/ha per year (48% C) and is low compared to published rates. Better estimates of root decomposition rates are clearly needed.

These conclusions do not differ from those found for temperate pastures (Pearson and Ison, 1987). Mismanagement, rather than the pasture option *per se*, should be blamed for soil degradation. Improved low-input pastures can contribute to a reduction in deforestation pressure by reducing the area required for beef and milk production. In addition, these pastures may release excess land to forest regrowth or for other agricultural systems. Furthermore, well managed pastures may be successfully combined with other agricultural alternatives, either as a pasture-crop rotation or as an intimately mixed silvo-pastoral system. Planners and policy makers in conjunction with farmers must now identify the necessary incentives to assure that low input pastures and good pasture management is implemented.

## References

- Amato M and Ladd J N. 1988. Assay for microbial biomass based on ninhydrin-reactive nitrogen in extracts of fumigated soils. *Soil Biology and Biochemistry* 20:107–114.
- Anderson J M and Ingram J (eds). 1989. *Tropical soil biology and fertility programme: Methods handbook*. CABI (Commonwealth Agricultural Bureaux International), Oxford, UK. 171 pp.
- Ayarza M A. 1988. *Potassium dynamics in a humid tropical pasture in the Peruvian Amazon*. Doctoral dissertation, North Carolina State University, Raleigh, North Carolina, USA. 156 pp.
- Ayarza M A, Dextre R and Sanchez P A. 1989. Persistence of grass-legume pastures under grazing. In: Caudle N (ed), *Tropsoils Technical Report, 1986–1987*. North Carolina State University, Raleigh, North Carolina, USA. pp. 21–28.
- Böhm W. 1979. *Methods of studying root systems*. Springer-Verlag, Berlin, Germany. 188 pp.
- Burns J C and Cope W A. 1974. Nutritive value of crown vetch as influenced by structured constituents and phenolic and tannin compounds. *Agronomy Journal* 66:195–202.
- Burns J C, Mochrie R D and Timothy D H. 1985. Intake and digestibility of dry matter and fiber of flaccidgrass and switchgrass. *Agronomy Journal* 77:933–936.
- Cassel D K, Bandy D E and Alegre J. 1980. Effect of clearing and continuous cultivation on soil physical properties. In: *Agronomic-economic research on soils of the tropics, 1978–1979 report*. North Carolina State University, Raleigh, North Carolina, USA. pp. 159–163.
- Castilla C E. 1992. *Carbon dynamics in managed tropical pastures: The effect of stocking rate on soil properties and on above- and below-ground carbon inputs*. Doctoral dissertation, North Carolina State University, Raleigh, North Carolina, USA. 175 pp.
- Castilla C E, Ayarza M A, Lara D and Sanchez P A. 1991. Persistence of grass-legume mixtures under grazing. In: Caudle N (ed), *Tropsoil Technical Report, 1988–1989*. North Carolina State University, North Carolina, USA. pp. 149–152.
- CIAT (Centro Internacional de Agricultura Tropical). 1982. *Annual Report 1981*. Tropical Pastures Program, CIAT, Cali, Colombia. pp. 3–10.

- CIAT (Centro Internacional de Agricultura Tropical). 1983. *Annual Report 1983*. Tropical Pastures Program, CIAT, Cali, Colombia. pp. 247–267.
- CIAT (Centro Internacional de Agricultura Tropical). 1986. *Annual Report 1985*. Tropical Pastures Program, CIAT, Cali, Colombia. pp. 5–12.
- CIAT (Centro Internacional de Agricultura Tropical). 1987. *Annual Report 1986*. Tropical Pastures Program, CIAT, Cali, Colombia. pp. 5–9.
- CIAT (Centro Internacional de Agricultura Tropical). 1990. *Annual Report 1989*. Tropical Pastures Program, CIAT, Cali, Colombia. pp. 1–26.
- Coleman D C. 1976. A review of root production processes and their influence in soil biota in terrestrial ecosystems. In: Anderson J M and MacFayden A (eds), *The role of terrestrial and aquatic organisms in decomposition processes*. Blackwell, Oxford, England.
- Correa J C. 1989. *Avaliação da degradação de pasto em um latossolo amarelo da amazona central*. Doctoral Dissertation, Escola Superior de Agricultura "Luiz de Queiroz". Piracicaba, Sao Paulo, Brasil. 111 pp.
- Crick J C and Grime J P. 1987. Morphological plasticity and mineral nutrients capture in two herbaceous species of contrasted ecology. *New Phytology* 1017:403–414.
- Cuesta P A. 1982. *Above-ground production and rooting patterns of six tropical grasses in association with two legumes with or without nitrogen fertilization*. MSc thesis, New Mexico State University, Las Cruces, New Mexico, USA. 136 pp.
- Daddow R L and Warrington G E. 1983. *Growth-limiting soil bulk densities as influenced by soil texture*. USDA-FS, Watershed Systems Development Group Report WSDG–TN-00005. USDA–FS (United States Department of Agriculture-Forest Service), Fort Collins, Colorado, USA.
- Davies W J and Zhang J. 1991. Root signals and the regulation of growth and development of plants in drying soil. *Annual Review of Plant Molecular Biology* 42:55–76.
- Fairley R I and Alexander I J. 1985. Methods of calculating fine root production in forests. In: Fitter A H (ed), *Ecological interaction in the soil*. Blackwell Scientific Publications, Oxford, UK. pp. 37–42.
- Gee G E and Bauder J W. 1986. Particle-size analysis. In: Klute A (ed), *Methods of soil analysis*. Part 1. Second edition. Agronomy Monographs 9. pp. 383–411.
- Goering H K and Van Soest P J. 1970. *Forage fiber analysis*. USDA-ARS Agriculture Handbook 379. US Government Printing Office, Washington, DC, USA. 20 pp.
- Hecht S B. 1989. The sacred cow in the green hell: Livestock and forest conversion in the Brazilian Amazon. *The Ecologist* 19:229–234.
- Hecht S B, Norgaard R B and Possio G. 1988. The economics of cattle ranching in eastern Amazona. *Intersciencia* 13:233–241.
- Hunter A H. 1974. *International soil fertility evaluation and improvement laboratory procedures*. Department of Soil Science, North Carolina State University, Raleigh, North Carolina, USA.
- INPE (Instituto Nacional do Pesquisas Espaciais). 1989. *Avaliação da floresta amazônica: Avaliação da alteração da cobertura florestal na Amazona Legal utilizando sensoramento remoto orbital*. INPE. Sao José dos Campos. p. 54.
- Janzen D H. 1986. The future of tropical ecology. *Annual Review of Ecology Systematics* 17:305–324.
- Jenkinson D S and Powelson D S. 1976. The effects of biocidal treatments on metabolism in soils. V. A method for measuring soil biomass. *Soil Biology and Biochemistry* 8:209–213.
- Kimura F T and Miller V L. 1957. Improved determination of chromic oxide in cow feed and feces. *Journal of Agricultural and Food Chemistry* 5:216.
- Lavelle P. 1988. Assessing the abundance and role of invertebrate communities in tropical soils: Aims and methods. *Journal of African Zoology* 102.
- Lavelle P and Pashanasi B. 1989. Soil macrofauna and land management in Peruvian Amazonia (Yurimaguas, Loreto). *Pedobiologia* 33:283–291.

- Long S P, Garcia Moya E, Imbamba S K, Kamnalrut A, Piedade M T F, Scurlock J M O, Shen Y K and Hall D O. 1989. Primary productivity of natural grass ecosystems of the tropics: A reappraisal. *Plant and Soil* 115:155–166.
- Meirelles de Miranda R. 1974. The role of beef cattle in the development of Latin America. In: *Potential to increase beef production*. CIAT (Centro Internacional de Agricultura Tropical), Cali, Colombia. pp. 123.
- Minson D J and McDonald C K. 1987. Estimating forage intake from the growth of beef cattle. *Tropical Grasslands* 21:116–122.
- Myers N. 1989. *Deforestation rates in tropical forest and their climatic implications*. Friends of the Earth, London, UK. 116 pp.
- Palm C A and Sanchez P A. 1990. Decomposition and nutrient release patterns of the leaves of three tropical legumes. *Biotropica* 22:330–338.
- Parton W J, Schimel S S, Cole C W and Ojima D J. 1987. Analysis of factors controlling soil organic matter in the Great Plains. *Soil Science Society of America Journal* 51:1173–1179.
- Pearson C J and Ison R L. 1987. *Agronomy of grassland systems*. Cambridge University Press, Cambridge, UK. 169 pp.
- Persson H A. 1983. The distribution and productivity of fine roots in boreal forests. *Plant and Soil* 71:87–101
- Pond K R, Burns J C and Fisher D S. 1987. External markers – Use and methodology in grazing studies. Proc. Grazing Livestock Nutrition Conf., Jackson, Wyoming, USA.
- Sanchez P A and Salinas J G. 1981. Low-input technology for managing Oxisols and Ultisols in Tropical America. *Advances in Agronomy* 34:279–406.
- SAS (Statistical Analysis System). 1986. *SAS user's guide*. SAS Institute, Cary, North Carolina, USA.
- Serro E A S. 1990. *Pecuária na Amazona: A evacuação da sustentabilidade das pastagens substituindo florestas*. Centro de Pesquisa Agropecuária do Trópico Umido, EMBRAPA. Belem, Para, Brasil (in press).
- Serro E A S and Toledo J M. 1990. The search for sustainability in amazonian pastures. In: Anderson A B (ed), *Alternatives to deforestation: Steps toward sustainable use of the Amazonian rainforest*. Colombia University Press, New York, USA. pp. 195–214.
- Smucker A J M, McBurney S L and Srivastava A K. 1982. Quantitative separation of roots from compacted soil profiles by the hydropneumatic elutriation system. *Agronomy Journal* 74:500–503.
- Uhl C, Buschbacher R and Serrao E A S. 1988. Abandoned pastures in Eastern Amazona. I. Patterns of plant succession. *Journal of Ecology* 76:663–681.
- Uhland R E. 1950. Physical properties of soils modified by crops and management. *Soil Science Society of America Proceedings* 14:361–366.
- Vance E D, P C Brookes and Jenkinson D S. 1987. An extraction method for measuring soil microbial biomass C. *Soil Biology & Biochemistry* 19:703–707.
- Vepraskas M J. 1988. Bulk densities values diagnostic of restricted root growth in coarse-textured soils. *Soil Science Society of America Journal* 52:1117–1121.
- Vogt K A, Grier C C, Gower S T, Sprugel D G and Vogt D J. 1986. Overestimation of net root production: A real or imaginary problem. *Ecology* 67:577–579.
- Wieder R K and Lang G E. 1982. A critique of the analytical methods used in examining decomposition data obtained from litter bags. *Ecology* 63:1636–1642.



# Soil aspects of nutrient cycling in a manure application experiment in Niger

*J. Brouwer<sup>1</sup> and J.M. Powell<sup>2</sup>*

1. ICRISAT Sahelian Center, BP 12404, Niamey, Niger; and Department of Soil Science and Geology, Agricultural University, P O Box 37, 6700 AA Wageningen, The Netherlands
2. 458 Glenway Street, Madison WI 53711, USA (formerly with ILCA)

## Abstract

Lack of nutrients is one of the main factors limiting crop production in the Sahel. Livestock play an important role in the transfer of nutrients from grazing land to cropping land through deposition of manure and urine. In 1990, a six-year study was initiated in semi-arid Niger, West Africa, to study the effects of application of various amounts of cattle and sheep manure, with and without urine, every one, two or three years, on the efficiency of nutrient use in the production of pearl millet. Intensive soil sampling was only possible during the first 12 months because of the plot size. There were a number of indications from the results of this intensive sampling. Regular sampling of soil, instead of the more usual regular sampling of soil water, can be useful in quantifying components of the soil nutrient balance. Pre-experiment sampling on a plot basis, to determine the spatial variability of soil characteristics, should help reduce the effects of spatial variability on experimental results. Since soil chemical parameters can show seasonal, cyclical fluctuations, temporal comparisons of soil properties should be done over (multiples of) 12-month periods, preferably at the start of the cropping season. Incorporation of organic matter by termites, decomposition in deeper soil layers, and leaching of nutrients continued during the dry season. Application of manure increased crop growth, may have accelerated decomposition of organic matter, increased termite activity, and possibly increased fixation of nitrogen. However, the results also showed that application of high rates of manure can give rise to leaching of organic carbon (C), nitrogen (N) and phosphorus (P). Within 12 months of application of the equivalent of 13 000 kg/ha of cattle manure, the equivalent of 1070 kg/ha of C, 91 kg/ha of N and 19 kg/ha of P had been translocated to beyond a depth of 1.5 m. It may therefore be more efficient to apply small amounts of manure frequently, than to apply a lot of manure less frequently.

## Aspects pédologiques du recyclage des éléments nutritifs dans un essai de fumure au Niger

*J. Brouwer<sup>1</sup> et J.M. Powell<sup>2</sup>*

1. Centre sahélien de l'ICRISAT, B.P. 12404, Niamey (Niger) et Department of Soil Science and Geology, Agricultural University, P.O. Box 37, 6700 AA Wageningen (Pays-Bas)
2. 458 Glenway Street, Madison WI 53711 (E.-U.) (précédemment en service au CIPEA)

## Résumé

*La carence d'éléments minéraux est un des facteurs principaux qui limitent la production agricole dans le Sahel. L'élevage joue un rôle critique dans le transfert par le fumier et l'urine d'éléments minéraux des pâturages aux terres cultivées. En 1990, une étude a été mise en place pour six ans dans le Niger semi-aride, en Afrique de l'Ouest, qui examine l'influence de l'application de différentes quantités de fumier de bovins et d'ovins, avec et sans urine, chaque 1, 2 ou 3 ans, sur l'efficacité de l'emploi d'éléments minéraux par une culture de mil. Au cours des 12 premiers mois, les aspects*

*pédologiques du bilan en éléments minéraux montrent que: échantillonner le sol plutôt que l'eau du sol peut aider à quantifier les composants du bilan des éléments minéraux dans le sol; prélever avant l'expérience des échantillons de sol sur chaque parcelle peut aider à réduire l'influence de la variabilité spatiale sur les résultats expérimentaux; les paramètres chimiques du sol ont des fluctuations saisonnières ou cycliques, les comparaisons de propriétés du sol dans le temps devraient donc être effectuées périodiquement tous les 12 (ou multiples de 12) mois, de préférence au début de la saison de culture; l'enfouissement de matière organique par les termites, la décomposition dans les couches plus profondes du sol et le lessivage des éléments minéraux continuent pendant la saison sèche; l'application de fumier améliore la croissance des cultures, peut accélérer la décomposition de la matière organique, augmenter l'activité des termites et probablement améliorer la fixation de N; l'application de taux élevés de fumure peut occasionner un lessivage des matières organiques C, N et P: en 12 mois d'application de 13 000 kg de fumier de bovins, 1 070 kg de C, 91 kg de N et 19 kg/ha de P ont été entraînés au-delà de 1,5 m de profondeur; donc, il est peut-être préférable d'appliquer de petites quantités de fumure régulièrement plutôt que des quantités plus importantes moins fréquemment.*

## Introduction

Lack of nutrients is one of the main factors limiting crop production in the Sahel (Bationo and Mokwunye, 1991). As nutrients are removed in harvested grain and by livestock grazing crop residues, crop production can only be maintained using external sources of nutrients. Livestock play an important role in the nutrient cycles of mixed farming systems (Powell and Williams, 1993). The animals transfer nutrients by grazing fallow and bush areas by day, and depositing their manure and urine when camped in cropping areas by night. Alternatively, some animals spend their nights in stalls; manure, minus much of the urine, is then carried from the stalls and spread on the fields. A six-year field experiment was started in 1990 in Niger to evaluate how various methods of manure application affect the efficiency of nitrogen (N) and phosphorus (P) use in the production of pearl millet (*Pennisetum glaucum* [L.] R.Br.). This paper examines soil aspects of the nutrient balance during the first 12 months of this long-term manuring trial. Emphasis is placed on observed seasonal fluctuations in various soil chemical parameters, and on observed effects of addition of manure on these seasonal fluctuations, including on leaching of nutrients.

## Materials and methods

### Site description

The study was conducted at the ICRISAT (International Crops Research Institute for the Semi-Arid Tropics) Sahelian Center (ISC) located 40 km south of Niamey, Niger (13°N, 2°E). Annual rainfall in Niamey has averaged 562 mm over the past 80 years (Sivakumar, 1986); the rainy season is from May to September. The soils at ISC are deep, red to orange Psammentic Paleustalfs (Soil Survey Staff, 1975). Textural composition is 850–900 g/kg sand, and 50–100 g/kg clay size particles. The clay particles are made up of roughly equal proportions of very fine quartz and kaolinitic minerals (West et al, 1984). The sands are very poor chemically; small absolute differences in fertility cause large differences in plant growth. Surface (0–0.2 m) soil chemical properties at the onset of the experiment were: pH in water  $5.6 \pm 0.37$ ; organic carbon  $1.6 \pm 0.4$  g/kg; total-N  $135 \pm 27$  t/kg; total-P  $79 \pm 5.6$  t/kg; and Bray1-P  $11.3 \pm 1.9$  t/kg (determined from two separate samples from each of four pits).

### Experimental design

The original treatments consisted of a factorial combination of cattle or sheep manure application, the equivalent of one, two or three nights of manure production, with or without urine, every one or two years. These 24 treatments plus the control were arranged in a randomised block design, with 6 lines of 25 plots. Plots measured 4 x 4 m with a 1 m space between plots within a block and 4 m spacing

between blocks. After one year it was decided to add a three-year application interval. This necessitated a re-allocation of treatments and a reduction from six to four repetitions.

For the application of manure, cattle and sheep grazed natural fallow pastures 10–12 hours daily. At night, 6 cattle or 23 sheep were put into one of two 4 x 4 m portable corrals until all the plots had been manured (+ urine) for the designated number of nights. Manure was hand-gathered daily, weighed, and subsampled for dry matter (DM) and N and P determinations. As soon as all the + urine plots in a block had been treated, the equivalent amounts of manure from animals that had spent their nights in stalls rather than on the plots was spread on the -urine plots in that block.

In 1990 millet was sown in late May in pockets 1.0 x 1.0 m apart. Thinning and weeding were carried out according to local practices. Millet grain and stover were harvested mid-September from the central 3 x 3 m of each plot, and analysed for DM, and for N and P contents. For the purpose of carbon (C) balances, an average C content of 40% C derived from various literature sources was used for manure and millet grain and stover.

### Monitoring nutrient changes in the soil

Due to limited plot size, changes in nutrient status in the soil could be monitored intensively only during the first 12 months of the experiment. To assess background levels of soil nutrient contents, soil samples were taken from four pits within the experimental area on 30 May 1990, just after millet was sown. Separate samples were taken from two sides of each pit. Sampling depths (standard for the whole experiment) were 0–0.2, 0.2–0.4, 0.7–0.9, 1.2–1.4 and 1.7–1.9 m. Samples were analysed for pH in water and in KCl (electrometrically); exchangeable  $H^+$  and  $Al^{+++}$  (potassium chloride method); organic carbon (Walkley and Black); available P (Bray1); total P (perchloric acid method);  $NH_4^+-N$  and  $NO_3^- - N$  (2M KCl method); and total Kjeldahl N (methods as described in Page et al, 1982). Four to six samples were taken per depth in each pit to determine bulk densities and soil water contents. The morphology of the soil profiles in the four pits was also described.

On 24 July, 30 August and 10 October 1990, and 10 May 1991 (before the start of the next rainy season), soil samples were taken from 4 repetitions of 5 treatments: cattle, 1 or 3 nights, + urine (C1+ and C3+); sheep, 1 or 3 nights, + urine (S1+ 1 and S3+ 1); and the control. The samples were taken by auger (70 mm diameter), at the depths mentioned above. The plots were divided into four quadrants, and on each date five holes were augered in one of the quadrants and the samples bulked for each depth. The resulting 100 samples from each sampling date were analysed for the chemical parameters mentioned above, except that  $H^+$  and  $Al^{+++}$  were only analysed for in October and May. In July and August samples for determination of gravimetric soil water content were taken as well.

## Results and discussion

Bulk density of the dry soil was high: for depths 0–0.4 and 0.4–2.0 m, respective values of 1570 and 1620 kg/m were subsequently used to convert soil nutrient concentrations in t/kg to soil nutrient storage in kg/ha. Samples from 0.7–0.9 m depth were taken to represent the 0.4–1.05 m layer; those from 1.2–1.4 m the 1.05–1.55 m layer; and those from 1.7–1.9 m the 1.55–2.0 m layer.

### Changes in nutrient concentrations with depth and time

Differences in nutrient concentrations between treatments and between sampling dates are often not significant because of soil spatial variability (cf Table 1). Trends in nutrient concentrations with time are discussed, as well as trends that are likely to be due to treatments. Relatively little can be said about trends from May to July 1990 because background concentrations at the start of the experiment in May 1990 were not taken on a per-plot basis.

**Table 1.** Averages and standard deviations of (changes in) nutrient storage in the soil (0–2.0 m depth, kg/ha), and probability levels of treatment effects.

Date	May 30	May 30 –Jul 24	Jul 24 –Aug 30	Aug 30 –Oct 10	Oct 10 –May 10	May 10	May 30 –May 10
Organic carbon							
Treatment							
C1+	18942 ±1861	+2480 ±1486	+3415 ±1748	–1858 ±4217	–353 ±1287	22625 ±2326	+3684 ±2326
C3+	18942 ±1861	+3148 ±718	+3476 ±2810	–513 ±2795	+48 ±3541	25100 ±1808	+6158 ±1808
S1+	18942 ±1861	+2144 ±1662	+5170 ±3023	–3371 ±3649	+961 ±1134	22142 ±2060	+3200 ±2060
S3+	18942 ±1861	+2181 ±2460	+5233 ±3548	–2305 ±3190	–1036 ±4179	23015 ±1705	+4073 ±1705
control	18942 ±1861	+918 ±2923	+3942 ±4059	–562 ±2518	–4086 ±2718	19153 ±1795	+212 ±1795
F prob.		0.67	0.73	0.61	0.17	0.03	0.03
Total nitrogen (no values for August 30)							
C1+	2486 ±261	+243 ±180	–218 ±170		+316 ±251	2827 ±126	+342 ±126
C3+	2486 ±261	+287 ±141	–265 ±81		+498 ±332	3004 ±274	+519 ±274
S1+	2486 ±261	+264 ±330	–92 ±76		+211 ±149	2807 ±195	+321 ±195
S3+	2486 ±261	+153 ±142	–26 ±435		+250 ±443	2863 ±157	+377 ±157
control	2486 ±261	+90 ±54	–65 ±166		+76 ±131	2587 ±172	+101 ±172
F prob.		0.47			0.36	0.14	0.14
Total phosphorus (no values for August 30)							
C1+	2008 ±5	0 ±82	–10 ±706		–114 ±75	1885 ±141	–124 ±141
C3+	2008 ±5	+152 ±107	–88 ±235		–15 ±173	2056 ±139	+48 ±139
S1+	2008 ±5	+17 ±123	–2 ±19		–182 ±116	1838 ±117	–171 ±117
S3+	2008 ±5	+50 ±65	–85 ±117		–35 ±99	1939 ±99	–70 ±99
control	2008 ±5	+2 ±103	+147 ±142		–345 ±84	1813 ±46	–196 ±46
F prob.		0.22			0.02	0.09	0.09

In explaining trends in nutrient concentrations, those factors that may have had a major influence on the direction of change are focused on, even though other factors may at the same time have had an opposite effect. At ISC, factors that may contribute to a positive change in nutrient concentrations in a particular form include:

- deposition of atmospheric dust and of surface-transported materials (minor in comparison to direct and indirect inputs from manure)
- incorporation and/or partial decomposition by termites and micro-organisms of millet stumps, of other residues left on the surface or brought from elsewhere, and of roots left in the soil from previous millet crops
- assimilation and transport to the root hairs of atmospheric C, and of N and P taken up elsewhere in the soil
- fixation of N and assimilation of C by micro-organisms
- direct deposition of manure and incorporation thereof by termites
- possible spillover effects of manure transported from adjacent plots by the wind or termites
- conversion of total N to mineral N and vice versa
- slow conversion of P not detected with the perchloric acid method to P included in 'total' P; conversion of total to available P and vice versa
- leaching of decomposition products from overlying soil layers.

Factors that may contribute to a negative change in nutrient content include:

- plant uptake of N and P
- decomposition of finer organic matter followed by leaching to deeper soil layers
- decomposition of finer organic matter to C- or N-containing gases that escape to the atmosphere
- conversion of total N to mineral N and vice versa
- slow conversion of total P to P not detected with the perchloric acid method; conversion from total P to Bray1 P and vice versa.

## Carbon

In the control plots, SOC contents in the top 0.4 m peaked in August (Figure 1). This peak is most likely related to development and subsequent decomposition and leaching of the millet root system; many millet root hairs are necessarily included in soil samples. Incorporation of organic matter from above the soil (by termites) and decomposition within the soil of the coarser millet roots from the previous year may have also played a role in these accumulations of SOC. During the dry season there is not much change in carbon content at these depths, indicating little activity, or a balance between carbon inputs (incorporation of organic matter) and outputs (leaching and escape to the atmosphere).

The peak in organic C concentration at 0.7–0.9 m depth in October, relative to late August, is only partly a variability-related artifact. It is most likely caused by net translocation (by leaching and/or decomposition in situ) of fine organic matter from above. The trend in organic carbon during the dry season is clearly negative. At this depth, decomposition of organic matter, followed by leaching or escape to the atmosphere, seem to predominate during the dry season. The trends at 1.2–1.4 and 1.7–1.9 m depth in the control plots are similar to those at 0.7–0.9 m.

The manured plots show the same underlying patterns as the control plots. The August peaks in organic C contents near the surface are higher, however, as manure has been applied at the surface, and as plant growth (and thus root development) was much more vigorous (cf C export in crop in Table 2). The early peak at 0.0–0.2 m in treatment C3+ where manure input averaged 13 t/ha is worth noting. Cattle manure decomposes readily, and much of what was incorporated before late July must have decomposed and been leached or escaped in gaseous form during August and September. That

**Figure 1.** Soil organic carbon content changes following manure application.

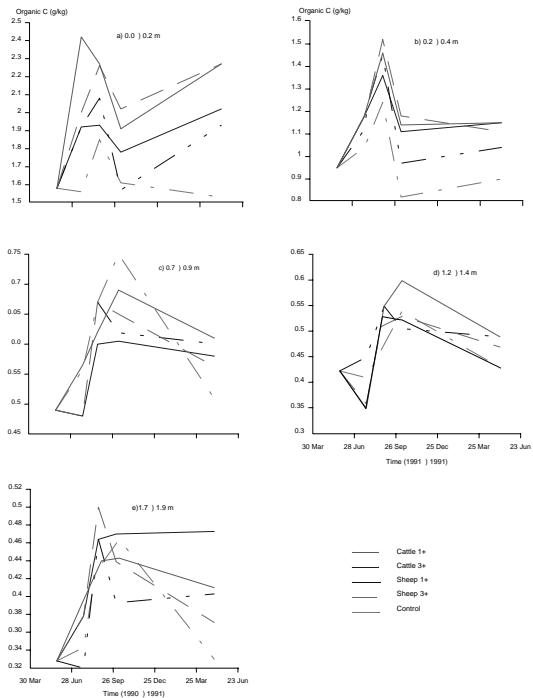

**Table 2.** Averages and standard deviations of nutrient balance components for top 2.0 m of soil (kg/ha), and probability levels of treatment effects.

	Soil May '90	Manure + urine in	Crop out	Soil May '91	Net balance
Organic carbon					
Treatment					
C1+	18942 ±1861	1539 ±549	1523 ±710	22625 ±2326	+3667 ±2700
C3+	18942 ±1861	5228 ±957	1847 ±247	25100 ±1808	+2777 ±963
S1+	18942 ±1861	619 ±142	1519 ±481	22142 ±2060	+4100 ±2455
S3+	18942 ±1861	1949 ±457	1861 ±112	23015 ±1705	+3984 ±1624
control	18942 ±1861	0	574 ±188	19153 ±1795	+785 ±1982
F prob.			0.005	0.025	0.215
Total nitrogen					
Treatment					
C1+	2486 ±261	80.6 ±30.2	50.7 ±27.4	2827 ±126	+311 ±120
C3+	2486 ±261	271.0 ±54.0	52.2 ±7.7	3004 ±274	+286 ±222
S1+	2486 ±261	48.5 ±20.9	37.0 ±14.1	2807 ±195	+309 ±185
S3+	2486 ±261	147.5 ±56.0	51.4 ±10.1	2863 ±157	+281 ±182
control	2486 ±261	0	13.0 ±3.6	2587 ±172	+114 ±174
F prob.		0.01	0.14	0.60,	
Total phosphorus					
Treatment					
C1+	2008 ±5	5.0 ±1.8	7.8 ±2.8	1885 ±141	-120 ±141
C3+	2008 ±5	16.7 ±3.2	13.6 ±4.0	2056 ±139	+42 ±140
S1+	2008 ±5	3.0 ±1.3	5.3 ±1.8	1838 ±117	-168 ±116
S3+	2008 ±5	9.2 ±3.4	8.0 ±3.0	1939 ±99	-71 ±95
control	2008 ±5	0 ±0.5	1.5 ±46	1813 ±46,	-194
F prob.				0.09	0.10

leaching was important is also supported by relatively late peaks in organic C at greater depth, and by the lack of a decrease during the dry season at 1.7–1.9 m under C3+ and S3+. In the latter treatments leaching additions from above probably compensated leaching losses to lower depths. Treatments S3+ and C1+ received roughly equal amounts of manure (4870 and 3850 kg/ha). That S3+ did, and C1+ did not, maintain carbon levels at 1.7–1.9 m during the dry season, may be related to the fact that sheep manure pellets may decompose more slowly than less dense cattle manure.

At 0.0–0.2 m depth in all four manured treatments, carbon contents increased during the dry season. This could be due to a relatively high level of termite activity during the dry season, triggered by the relatively large amounts of millet roots and stumps and undecomposed manure still present there.

### Nitrogen

The total N and mineral N data are presented in Figures 2 and 3. Trends in total N contents under the control plots resemble those for organic C, with a peak at the surface during the middle of the cropping season. There appears to be some increases in total N near the surface during the dry season, probably related to termite activity. At depth (1.2 m) total N levels seem relatively stable during the cropping season (inputs = outputs), with possibly some net leaching and/or escape in gaseous form during the dry season. Transport of N to lower depths (by leaching or via decomposition of roots) is supported by the early peak in mineral N concentration near the surface and the later peaks at depth.

Total N data under the manured plots also showed a peak near the surface during the cropping season (the high value for S3+ in October is mostly due to one observation of 265 t/kg, and an increase during the dry season probably related to termite activity). At greater depths there were varying trends during the cropping season. During the dry season total-N concentrations at greater depths generally increased, most likely due to translocation from above, particularly under the high input (C3+) and medium input–slow release (S3+) treatments. Mineral N trends support the conclusions of translocation of N to greater depths during a large part of the year and termite activity near the soil surface during the dry season.

### Phosphorus

Total-P and Bray1-P concentrations are presented in Figures 4 and 5. Under the control plots, total-P at 0.0–0.2 m depth did not change much during the entire year, perhaps reducing slightly during the dry season. At 0.2–0.4 m the decreasing trend in total-P is striking. At greater depths there are peaks in October, and downward trends during the dry season. The peaks may be related to leaching of P made more soluble by the addition of organic matter in the form of manure (cf Stevenson, 1986: 275). The downward trends may be due in part to slowly reversible conversion, as the soil dries out, of total-P to P not caught by the perchloric acid method. It is also possible that the downward trends are related to leaching of total-P. However, that would make the leaching losses of P so large that corroborating evidence is required.

Bray1-P trends near the surface of the control plots are more or less neutral. Below 0.7 m, however, there seem to be increases, however small, from May (July) until October, and decreases or neutral trends during the dry season. It is not clear to what extent the increases are due to decomposition of old organic matter *in situ*, conversion from total P, transfer from above (via the root system or by leaching), or measurement error including spatial variability aspects.

Leaching of P is definitely a possibility, as mentioned by Stevenson (1986: 236) and confirmed by data from Bationo and colleagues at ISC (IFDC, 1993: 30). The soils are quite coarse, and leaching of entire organic molecules, containing P, is no doubt easily achieved. In addition, the P-retention capacity of these soils is very low (0–4%, Blakemore et al, 1987); even orthophosphate is leached when supply exceeds retention capacity.

Like SOC trends, total P trends near the surface of the manured plots showed peaks during the height of crop development (July), and a slight increase during the dry season. The peaks are due to



Figure 2. Soil total nitrogen content changes following manure application.

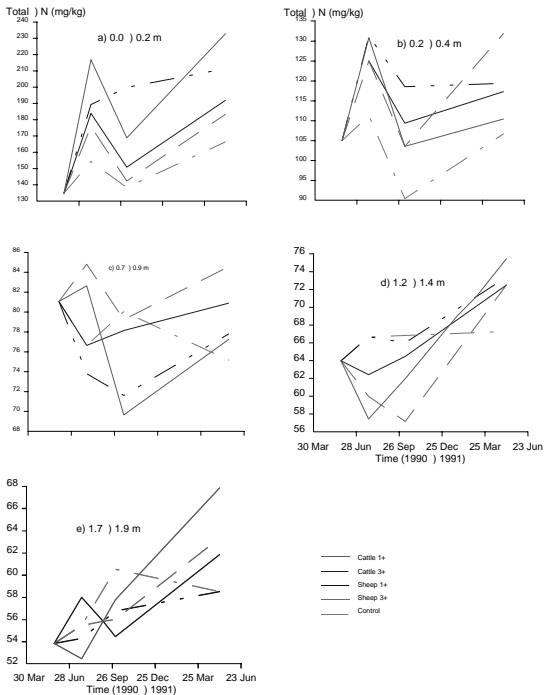

**Figure 3.** Soil mineral nitrogen content changes following manure application.

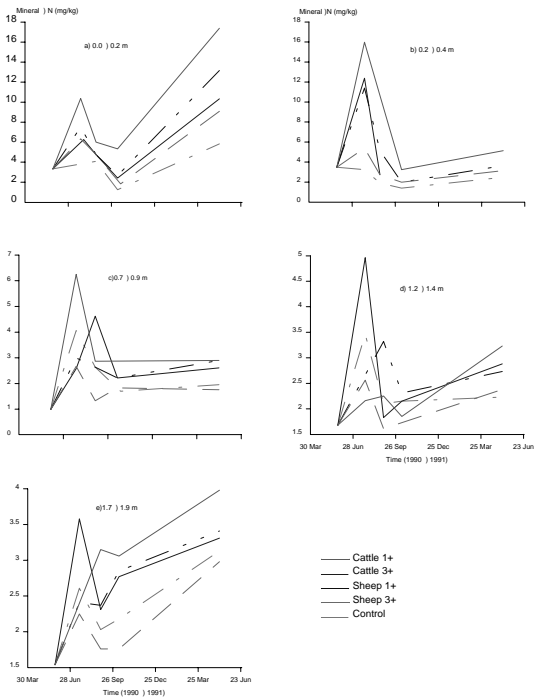

the input of P via the manure, and possibly also related to the effect of urine on availability of P. Table 2 shows that, for the lower input treatments (C1+ and S1+), the amount of P applied in the manure is less than the amount of P removed in the crop. A companion study during the 1990 cropping season on adjacent plots examined the effects of urine on soil chemical properties (Powell, unpublished data). Average sheep urine voidings (64 g) applied an equivalent of 202 kg/N ha. This increased surface soil pH (0–0.15 m) from 5.5 to 8.5, and Bray1-P from 11 to 18 t/kg, one week after application. These values remained elevated throughout most of the 120-day millet growth cycle. Very little P is excreted in urine, and the positive effect of urine on Bray1-P must have been due to the elevated pH, which decreased P-fixation and made more P available.

The increases in total P near the surface during the dry season become more important when compared to the negative trends lower down in the soils. They are, again, probably related to dry season termite activity (incorporation and partial breakdown of organic matter from the surface). Fluctuations in total P were strongest for the highest manure input treatment (C3+). Below 0.2 m, the trends from July to October varied. During the dry season, particularly for C3+ and to a lesser degree for S3+, total P decreased at 0.2–0.4 and 0.7–0.9 m depth, and remained unchanged at 1.2–1.4 and 1.7–1.9 m depth. These trends, too, point to the translocation of P from shallower to deeper layers of soil.

### Translocation of nutrients to below the root zone

Translocation of nutrients to deeper soil layers mainly takes place in two ways. The first is direct leaching. The second is transfer via the root system to deeper roots, followed by decomposition of those roots and leaching of the decomposition products. A calculation involving root length densities and specific root lengths (S R Gaze, unpublished data), shows that the amounts of P needed to form new roots at depth are too small to explain the maximum increases in total P concentrations found at the 1.7–1.9 m depth (Figure 4). Leaching must play a significant role in the translocation of P to greater depths, and most likely in the translocation of C and N as well.

Brouwer et al (1993) found that soil drainage at ISC, and therefore leaching, continue well after the end of the rainy season and that dry season water losses from the top 2.0 m of soil can be as great as 70–100 mm. As long as there is water and organic matter, microbial activity is also likely to continue on these well-aerated soils.

The magnitude of translocation of nutrients to greater depths can be estimated in several ways. Firstly, one can look at the change in storage in the 1.5–2.0 m deep soil layer between May 1990 and May 1991 (Figures 1–5). Using a soil dry bulk density of 1.57 t/ha, these increases on a hectare basis are up to 1070 kg for organic C, 91 kg for total N, 11 kg for mineral N, 19 kg for total P and 9 kg for Bray1 P under treatment C3+. This is approximately 20% of the manure C input into C3+, and 34% of the N input. As C and N can be fixed from the atmosphere, these percentages may be somewhat misleading. For total P, the translocation was more than the input of P in the manure. This may be related to the fact that the field had received a considerable amount of P fertiliser in the years before this experiment. After the application of P fertiliser stopped, the soil may have been returning to total-P levels in equilibrium with no input of P fertiliser.

A rough water balance and nutrient flux calculation can also be done based on increases in concentrations of nutrients in the soil water due to the addition of manure, and on displacement of that soil water through drainage. Nutrient translocations to below 2.0 m depth thus calculated on a hectare basis were up to 1540 kg for organic C, 55 kg for total N, 19 kg for mineral N, 44 kg for total-P and 6.3 kg for Bray1 P under treatment C3+. This is based on the assumption of 70 mm of drainage during the dry season. As total drainage during the whole cropping season was more like 200 mm (Klaij and Vachaud, 1992) these last figures may still be underestimates.

**Figure 4.** Soil total phosphorus content changes following manure application.

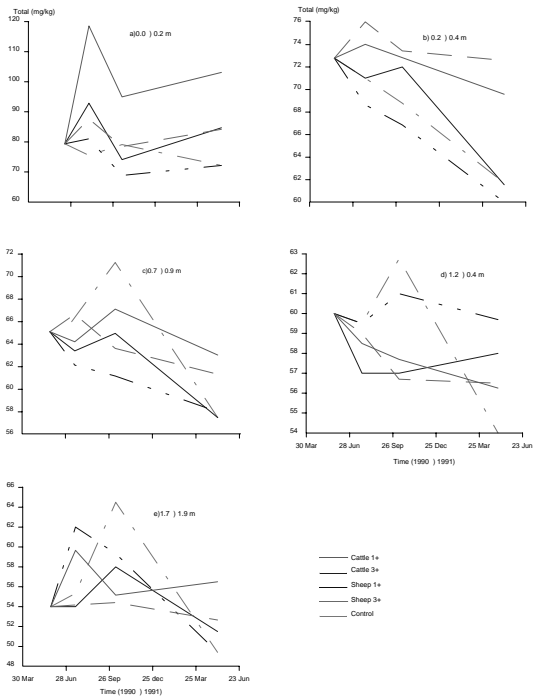

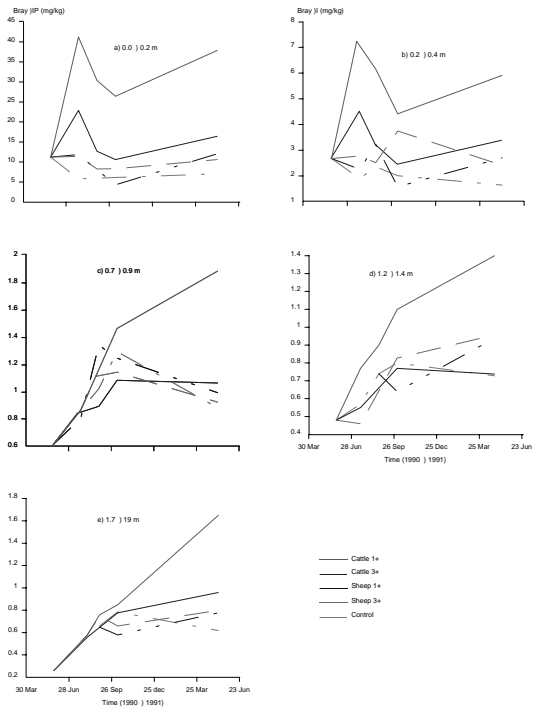
**Figure 5.** Soil Bray-1 phosphorus content changes following manure application.

## **Nutrient balances**

Changes in nutrient storage from May 1990 to May 1991 in the top 2.0 m of soil are given in Table 1. Measurements of various components of the nutrient balance are presented in Table 2. For a layer of soil 2.0 m thick, with an average bulk density of about 1.6 t/ha, 1 t/kg equals 32 kg/ha. The net balances are equal to the soil storage in May 1991, minus the storage in May 1990, minus the input as manure, plus the export via harvesting of the crop.

## **Carbon**

At the beginning of the experiment, the top 2.0 m of soil contained about 19 000 kg C/ha. Under the control plots, the net change in stored SOC over 12 months was negligible. For the manured plots, changes measured between two consecutive sampling dates went as high as 5000 kg/ha, but were generally not significant (Table 1). However, changes in SOC over the 12-month study period showed a clear treatment effect: C3+ plots showed clearly the largest increase in SOC storage (6200 kg/ha), while the other manure treatments did not differ much from each other and showed smaller increases (3200–4100 kg/ha) (Table 1).

Table 2 shows that the net carbon balance over 12 months was about zero for the control plots, but highly positive for the manured plots (2800–4100 kg/ha). The probability of a significant treatment effect is, however, only 80%. Some inaccuracy in C (and N and P) balances may be due to incomplete recovery of the manure applied to plots by animals during night-time coralling. Total hand collection of sheep faeces from the soil surface was very difficult, and perhaps incomplete during the first year of study. In subsequent years all animals were fitted with manure collection bags. However, no account is taken of leaching and decomposition losses of C, inclusion of which would make the net carbon balance even more positive.

Overall, it appears that the addition of sheep and cattle manure greatly increased millet yields. Above-ground biomass production increased by a factor of 3 (cf treatment effects on C, N and P exported in the crop) (Table 2); below-ground biomass probably increased by a similar factor (not measured). A root:shoot ratio of 2: 2.5, necessary to explain the increase in SOC storage on the basis of formation of new roots alone is much too high to be realistic. Published data for the local millet variety and the most commonly used cultivar CIVT indicate root: shoot ratios of only 0.2: 0.3 (ISC, 1992: 69) while actual ratios are probably about twice that (S R Gaze, ICRISAT Sahelian Centre, personal communication).

It appears likely that the addition of manure accelerated the breakdown of coarser organic matter already in the soil from previous crops, thus causing an increase in SOC contents (Stevenson, 1986: 276). It is unlikely that the manure application stimulated the importation by termites of organic matter from elsewhere to such a degree. As there is also evidence of leaching of organic matter below the root zone of the millet, it is unlikely that these increases in SOC will be maintained over the long term.

## **Nitrogen**

At the start of the experiment, the top 2.0 m of soil contained about 2500 kg N/ha. Under the control plots, there was no significant change in storage of N during the period of observation (Table 2). Any positive effect could only be attributed to accidental external inputs such as spill-over of manure or increased termite activity from neighbouring plots. The probability of a treatment effect over 12 months on storage of N is about 86%. A 320 to 520 kg/ha increase in N storage was measured for the four manured treatments, with C3+ again showing clearly the highest increase and the other three manure treatments being approximately equal. For the manured treatments, N export by millet was less than the N applied via the manure in all cases.

As with SOC, the increase in N storage may have been caused by accelerated breakdown of organic matter already present in the soil, triggered by the application of manure. Ignoring losses due to leaching and gaseous losses, the ratios between the net C balances and the net N balances vary from 10–14, roughly what one would expect in well mineralised soil organic matter. It is also possible that the application of manure caused an increase in nitrogen fixation by micro-organisms, including those that live in the guts of certain termite species.

## Phosphorus

At the start of the experiment, the top 2.0 m of soil contained about 2000 kg/ha of total P. Total P initially increased then decreased for most treatments (Figures 4 and 5). The net change over 12 months in stored total P under the control plots was  $-194$  kg/ha (Table 2). Negative changes in total P were also observed for manure treatments C1+, S1+ and S3+. Only the C3+ treatment had a positive P balance. There was a 90% probability that these changes in total P were due to treatment effects.

The net negative changes in total P were more or less proportional to the amounts of organic matter added. It is possible that some of the fertiliser P applied during the years before this experiment was undetectable with the perchloric acid method used to determine initial total P in May 1990. When the soil became moist in June and July some of this P was released causing the temporary increase in total and Bray1 P values. As organic matter from the manure was washed into the soil, P complexed with it and was leached. Leaching was probably more or less in proportion to the amount of organic carbon added and greatest under the C3+ treatment.

The P input in manure differed very little from P export via the crop (Table 2). The net total P balances therefore showed virtually the same pattern as the changes in storage of total P in the soil from May 1990 to May 1991.

## Conclusions

First-year results from this manuring trial showed that:

1. Frequent sampling of soil can be a useful tool in quantifying soil nutrient balance components.
2. Where soil variability may be a problem, pre-experiment background sampling should be done on a plot basis, not a block or treatment basis.
3. A number of soil chemical parameters showed marked cyclical fluctuations over the 12-month period. These fluctuations were probably related to rainfall, crop development, soil biological activity and downward movement of water. This should be kept in mind when evaluating the effects of agronomic treatments on soil parameters and yield sustainability. Comparisons in time should probably only be made over periods of (multiples of) 12 months, with sampling perhaps best done just before the rainy season (including the rainy season after the last harvest in an experiment).
4. The dry season was by no means static in terms of soil nutrient cycles. Processes important during this season include incorporation of organic matter by termites, decomposition of organic matter (including recent roots) in soil layers that are still moist and leaching of nutrients to beyond the millet root zone.
5. Application of manure may give rise to faster decomposition of organic matter already present in the soil; to increased assimilation of C by the millet crop; to increased activity of termites (in particular during the dry season); and possibly to increased fixation of nitrogen by bacteria in the soil (and possibly in the guts of certain termite species).
6. Application of high rates of (cattle) manure can give rise to leaching of organic C, N and P. The leaching can be direct; or it can follow downward transport via the root system.

- Increases in nutrient storage in the 1.55–2.0 m soil layer, within a year of application of more than 13 000 kg/ha of cattle manure dry matter, were 1070 kg/ha of organic C, 91 kg/ha of total N (11 kg mineral N), and 19 kg/ha of total P (9 kg Bray-I P). Actual downward losses of nutrients from the millet root zone may have been larger still.
- Nutrient balances indicated that for the deep sandy soils under study it may be more efficient in terms of nutrient usage to apply small amounts of manure frequently, rather than large amounts at longer intervals.
- Sheep manure appears to decompose more slowly than cattle manure, and as such may constitute a more efficient form of manure application.

## Acknowledgements

Thanks are due to Diarafou Amadou (soil sampling and data entry); Ilyassou Oumarou and his staff (laboratory analyses); Emilie Bär; Stephen Gaze (root growth and water balance data); Roger Stern (statistical analyses); Andreas Bürkert; and a second internal referee at ISC. The financial support of J. Brouwer's position by the Netherlands Ministry for Development Cooperation (DGIS) is also gratefully acknowledged.

## References

- Bationo A and Mowkunyie A U. 1991. Alleviating soil fertility constraints to increased crop production in West Africa: The experience in the Sahel. In: Mokwunye A U (ed), *Alleviating soil fertility constraints to increased crop production in West Africa*. Kluwer, Dordrecht, The Netherlands. pp. 195–215.
- Blakemore L C, Searle P L and Daly B K. 1987. *Methods for chemical analysis of soils*. New Zealand Soil Bureau Scientific Report 80. Soil Bureau, Lower Hutt, New Zealand. 103 pp.
- Brouwer J, Bürkert A C, Stern R D, Vandenbeldt R J and Powell J M. 1993. Soil and crop growth micro-variability in the Sahel: Boon or bane for farmers and agronomists? In: Kronen M (ed), *Proceedings of the Third Annual Conference of the SADC-Land and Water Management Programme, Harare, Zimbabwe, 5–7 October 1992*. SADC-Land and Water Management Research Programme, Gabarone, Botswana. pp. 167–176.
- IFDC (International Fertiliser Development Center). 1993. *Annual Report 1992*. IFDC, Mussle Shoals, Alabama, USA.
- ISC (ICRISAT Sahelian Center). 1992. *ICRISAT West African Programs Annual Report 1991*. ISC, Niamey, Niger.
- Klaij M C and Vachaud G. 1992. Seasonal water balance of a sandy soil in Niger cropped with pearl millet, based on profile moisture measurements. *Agricultural Water Management* 21:313–330.
- Page A L, Miller R H and Keeney D R (eds). 1982. *Methods of soil analysis. Part 2 — Chemical and microbiological properties*. Agronomy Series 9(2). ASA (American Society of Agronomy), CSSA (Crop Science Society of America) and SSSA (Soil Science Society of America), Madison, Wisconsin, USA. 1159 pp.
- Powell J M and Williams T O. 1993. *Livestock, nutrient cycling and sustainable agriculture in the West African Sahel*. Gatekeeper Series 37. IIED (International Institute for Environment and Development), London, UK. 13 pp.
- Sivakumar M V K. 1986. *Climate of Niamey*. Progress Report 1. ICRISAT Sahelian Center, Niamey, Niger. 36 pp.
- Soil Survey Staff. 1975. *Soil taxonomy: A basic system of soil classification for making and interpreting soil surveys*. Soil Science Information Report 1. Soil Conservation Service, United States Department of Agriculture. US Government Printing Office, Washington, DC, USA. 754 pp.
- Stevenson F J. 1986. *Cycles of soil C, N, P, S and micronutrients*. John Wiley and Sons, New York, USA. 380 pp.
- West L T, Wilding L P, Landeck J K and Calhoun F G. 1984. *Soil Survey of the ICRISAT Sahelian Centre, Niger, West Africa*. Soil and Crop Sciences Department/TropSoils, Texas A&M University System, College Station, Texas, USA, in cooperation with ICRISAT. 66 pp.



# Feed factors affecting nutrient excretion by ruminants and the fate of nutrients when applied to soil

Z.C. Somda,<sup>1</sup> J.M. Powell,<sup>2</sup> S. Fernández-Rivera<sup>1</sup> and J. Reed<sup>3</sup>

1. International Livestock Centre for Africa (ILCA), Semi-arid Zone Programme  
ICRISAT Sahelian Center, BP 12404, Niamey, Niger
2. 458 Glenway Street, Madison WI 53711, USA (formerly with ILCA)
3. Department of Animal Sciences, University of Wisconsin, Madison, WI, USA

## Abstract

Mixed farming systems in semi-arid West Africa rely on recycling organically bound nutrients to maintain soil productivity. The passage of plant biomass through ruminant livestock plays a major role in the nutrient cycles of this region. The feeding value of crop residues and browses and their impact on nutrient excretion by sheep, and the decomposition of and nutrient mineralisation from crop residues, browse leaves and manure derived from these feeds were studied during the dry, wet and cool seasons in the Sahel of West Africa. The total amount and proportion of nutrients excreted in faeces and urine varied with the lignin:neutral-detergent fibre (NDF), lignin:nitrogen (N) and polyphenol:N ratios of the diets. Feeding browse shifted N excretion from urine to faeces, and from faecal microbial- to undigested feed-N. Initial organic-matter decomposition was more rapid and greater in manure than in browse leaves. Manure decomposition was fastest during the dry and cool seasons. Mineralisation and immobilisation patterns of N and phosphorus (P) in leaves and manure varied considerably. Whereas N and P were released more quickly from manure, browse leaves initially immobilised N and P, particularly during the cool season. Mineralisation of N and P from manure varied seasonally and was highly influenced by the sheep diet. This study showed that the passage of feed through ruminants can be an important regulator of nutrient cycling in this semi-arid region.

## Facteurs alimentaires affectant l'élimination d'éléments nutritifs par les ruminants et devenir de ces éléments dans le sol

Z.C. Somda<sup>1</sup>, J.M. Powell<sup>2</sup>, S. Fernández-Rivera<sup>1</sup> et J. Reed<sup>3</sup>

1. Centre international pour l'élevage en Afrique (CIPEA), Programme de la zone semi-aride  
Centre sahélien de l'ICRISAT, B.P. 12404, Niamey (Niger)
2. 458 Glenway Street, Madison WI 53711 (E.-U.) (précédemment en service au CIPEA)
3. Department of Animal Sciences, University of Wisconsin, Madison, WI (E.-U.)

## Résumé

*Les systèmes mixtes de production des zones semi-arides de l'Afrique de l'Ouest sont basés sur le recyclage des éléments nutritifs à support organique en vue du maintien de la productivité des sols. Le passage de la biomasse végétale à travers l'appareil digestif des ruminants joue un rôle primordial dans les cycles d'éléments nutritifs dans cette région. La valeur bromatologique des résidus de cultures et des ligneux fourragers, leur influence sur l'excrétion chez les ovins ainsi que la décomposition et la minéralisation de ces résidus, des feuilles de ligneux et du fumier obtenu à partir de ces aliments*

*ont été étudiées au cours de la saison des pluies et des saisons sèche, chaude et fraîche dans la région du Sahel en Afrique de l'Ouest. La quantité totale et la proportion d'éléments minéraux éliminés dans les fèces et les urines dépendaient des rapports lignine/NDF, lignine/N et polyphénols/N dans les différents régimes alimentaires. La consommation de feuilles de ligneux augmentait la proportion d'azote éliminée dans les fèces au détriment de celle des urines, ainsi que celle d'azote alimentaire non digestible au détriment de l'azote fécale d'origine microbienne. La décomposition initiale de matière organique était plus rapide et plus importante dans le fumier que dans les feuilles de ligneux fourragers. Celle du fumier était plus rapide pendant les saisons sèche et fraîche. Les modes de minéralisation et de fixation de l'azote et du phosphore dans les feuilles et le fumier étaient très différents. Ainsi, alors que les deux éléments étaient plus rapidement libérés dans le fumier, ils étaient d'abord fixés dans les feuilles des ligneux, surtout pendant la saison fraîche. La minéralisation de l'azote et du phosphore à partir du fumier dépendait de la saison et plus encore du régime alimentaire des ovins. Cette étude montre que le passage des aliments par le système digestif des ruminants peut être un régulateur important du processus de recyclage des éléments nutritifs dans cette région semi-aride.*

## Introduction

The main constraints to cereal production in semi-arid West Africa are low soil fertility and periodic drought. Soils generally are very low in organic matter (OM), nitrogen (N) and phosphorus (P) contents (Kowal and Kassam, 1978; Breman and de Witt, 1983). Although crop residues left in the field can greatly improve the physical and chemical properties of these soils (Bationo and Mokwunye, 1991), they are most always fed to livestock.

Sandford (1989) reported that during the dry season livestock spend 50 to 80% of their grazing time on cereal stovers. When crop residues and natural pastures are in short supply, browse leaves can constitute up to 50% of cattle diet and 70 to 80% of sheep and goats diet (Le Houérou, 1980; Otsyina and McKell, 1984). Many browses are high in tannins and related polyphenolic compounds which affect ruminant livestock nutrition (Reed, 1986; Reed et al, 1990) and the process of nutrient cycling in soils (Palm and Sanchez, 1991). The most common type of tannins found in browse are flavanoid polymers which are more correctly referred to as proanthocyanidins (PAs) (Bate-Smith, 1973; Reed, 1986; Haslan, 1989; Stafford, 1990).

Proper management of crop residues, animal feeds, and manure can have a positive impact on the nutrient dynamics of low-input farming systems derived from savanna (Swift et al, 1989). For mixed farming systems in the Sahel of West Africa, an important issue is how to allocate limited amounts of biomass to the various production needs of crops and livestock. Crop residues and other feeds need to satisfy animal nutritional needs during the six- to eight-month dry season and sufficient organic material has to be returned to fields for soil conservation. The timely application of organic amendments to soil is necessary so that their decomposition and nutrient release is synchronous with crop nutrient demands.

The decomposition of, and nutrient release from organic residues applied to soils are greatly influenced by an array of abiotic and biotic factors (Parr and Papendrick, 1978). Reports of significant correlations between initial chemical composition of organic soil amendments and mineralisation rates have been published extensively (Knapp et al, 1983; Fox et al, 1990; Palm and Sanchez, 1991; Oglesby and Fownes, 1992). However, comparative data for a wide range of forages and animal manure are unavailable under the semi-arid conditions of the Sahel. The objectives of this paper are to review the relationships between the chemical composition of forages and nutrient excretion by small ruminants, to compare the rates of forage and faeces decomposition in soil and evaluate the tradeoffs in applying plant material directly to soil versus feeding it to animals and applying their excreta to soil.

## Nutrient excretion through manure and urine

A large proportion of the nutrients ingested by ruminants are excreted through faeces and urine. The amount and nutrient content of faeces are highly variable and depend on feed intake and apparent digestibility. According to their origin, faecal components can be classified into two fractions: metabolic (i.e. microbial and endogenous) and undigested feed (Mason, 1969; Orskov, 1982; Van Soest, 1982). The metabolic faecal OM is the fraction soluble in neutral detergent. This fraction is higher in cattle than sheep faeces, and increases as feed quality decreases and fermentation in the lower tract increases (Orskov, 1982; Van Soest, 1982). The undigested feed fraction is insoluble in neutral detergent and increases as the digestibility of the feed decreases. When faeces are applied to soil, the undigested feed fraction would mineralise at a slower rate than the metabolic fraction.

Using relationships established by ARC (1984), the amount of soluble (FSN) and insoluble (FIN) nitrogen in animal faeces can be predicted by the equations:

$$\text{FSN} = [\text{DOMR} \times Y_m \times P_m \times (1 - d_m)] / F_m$$

where:

DOMR is the amount (kg/d) of OM apparently fermented in the rumen

$Y_m$  is the amount of microbial N synthesised in the rumen (23 to 32 g/kg DOMR)

$P_m$  is the fraction of microbial N that is protein-N (0.8)

$d_m$  is the true digestibility of microbial N (0.85)

$F_m$  is the fraction of microbial N (0.86) in the metabolic faecal-N (Mason and Frederiksen, 1979)

$$\text{FIN} = \text{ADIN} * I$$

where:

ADIN represents the N in the acid detergent insoluble fraction (g/kg) of the feed (Goering et al, 1972)

I is feed intake (kg/d)

In addition to manure, substantial amounts of nutrients are excreted through urine. The amount of urine voided is highly influenced by intake of water, salt and N, and environmental conditions (Church, 1975). Cattle excrete 17 to 45 ml of urine per kg live weight daily whereas normal urine excretion rates for sheep and goats are 10 to 40 ml/kg live weight.

Urinary-N compounds are urea, ammonia, allantoin, hippuric and uric acids (Van Soest, 1982). Nitrogen compounds digested in the rumen and absorbed as ammonia are metabolised and converted to urea in the liver. Variable proportions of urea are recycled to the rumen or excreted through urine. Thus, the consumption of N compounds that are ruminally degradable is associated with losses of urinary urea N. When applied to soils, most urine N can be lost by volatilisation and leaching (Russelle, 1992) whereas faecal-N is less susceptible to losses (Ryden et al, 1987).

Animal faeces also contain variable amounts of endogenous and unabsorbed feed P depending on the concentration and availability of P in the feed (Little, 1980). Whereas N is voided in both faeces and urine, P is excreted almost exclusively in faeces (Ternouth, 1989). In general, P is not subject to volatile losses.

The proportion of N and P excreted in faeces and urine is relevant to nutrient cycling and crop production in the Sahel. When animals are corralled overnight on cropland (Powell and Williams, 1993) both faeces and urine are returned to the soil whereas faeces collected from stall-fed animals and handspread on cropland are mostly devoid of urine. Although most urine-N may be lost when applied to soils, urine increases soil pH and available P levels of the sandy acid soils (Powell et al, 1992).

## Effects of diet quality on nutrient excretion

Animal management and feeds highly influence nutrient excretion by ruminant livestock. Under stall-feeding conditions, the greatest faecal-N content was for sheep fed browse leaves followed by sheep fed cowpea and then millet leaves (Table 1). Goats browsing *Bauhinia rufescens* excreted more faecal insoluble N than goats browsing *Ziziphus mauritiana* and *Combretum aculeatum*. However, grazing under low or high stocking rates, sheep and goats excreted similar amounts of faecal N and P.

**Table 1.** Animal management and diet effects on nitrogen (N) and phosphorus (P) excreted in faeces of goats and sheep.

Animal species	Management and feed	Faecal N		Total faecal P
		Total	Insoluble % DM	
Goats <sup>1</sup>	Browsing			
	<i>Ziziphus mauritiana</i>	2.25	1.82	0.41
	<i>Combretum aculeatum</i>	2.03	1.48	0.72
	<i>Bauhinia rufescens</i>	2.29	2.14	0.62
Goats <sup>1</sup>	Grazing			
	Low stocking rate	1.90	1.25, 0.50	
	High stocking rate	1.83	1.19	0.50
Sheep <sup>1</sup>	Grazing			
	Low stocking rate	1.77	1.17	0.39
	High stocking rate	1.92	1.33	0.46
Sheep	Stall-fed			
	<i>Guiera senegalensis</i> <sup>2</sup>	2.73	2.06	1.11
	<i>Acacia leiocarpus</i> <sup>2</sup>	2.78	2.25	1.01
	<i>Ficus gnaphalocarpa</i> <sup>2</sup>	2.44	2.00	0.74
	<i>Mitragyna inermis</i> <sup>2</sup>	3.05	2.12	0.87
	<i>V. unguiculata</i> leaves <sup>1</sup>	2.74	1.24	0.78
	<i>V. unguiculata</i> stems <sup>1</sup>	1.73	0.96	0.85
	<i>V. unguiculata</i> straws <sup>1</sup>	2.13	0.82	0.92
	<i>Pennisetum glaucum</i> <sup>2,3</sup>	1.55	0.91	0.61
	<i>Pennisetum glaucum</i> <sup>2,4</sup>	1.76	1.24	0.78
SEM <sup>5</sup>		0.113	0.122	0.054

1. No supplements given.

2. Supplements given at 10 g/kg W<sup>0.75</sup>.

3. Digestibility of dry matter = 41%.

4. Digestibility of dry matter = 49%.

5. SEM = standard error of the mean.

Tannins and related phenolic compounds appear to have a major effect on the amount and pathway of N excretion. A feeding trial with sheep in which four tree species (*Acacia cyanophylla*, *A. sieberiana*, *A. Seyal* and *Sesbania sesban*) were used as protein supplements to teff (*Eragrostis abyssinica*) straw was conducted by Reed et al (1990). *Acacia cyanophylla* had the highest content of proanthocyanidins whereas *S. sesban* had the lowest (Table 2). Proanthocyanidins (PAs) in browse

plants are associated with higher amounts of neutral-detergent fibre, acid-detergent fibre, acid-detergent lignin and N that is insoluble in neutral detergent (Reed, 1986). The high content of PAs in *A. cyanophylla* was associated with high levels of neutral-detergent fibre and acid-detergent lignin. The content of lignin and PAs in *A. sieberiana* and *A. seyal* were intermediate between *A. cyanophylla* and *S. sesban*. The three acacia species had similar contents of soluble phenolics and were much higher than *S. sesban*. In addition to PAs, soluble phenolics may include low molecular weight compounds which may not complex with protein and carbohydrate (Reed et al, 1985).

**Table 2.** Chemical composition of forage from four trees species used as supplements to a straw diet, and composition of faeces from sheep (n=4) fed the same diet.

	<i>Acacia cyanophylla</i>	<i>Acacia sieberiana</i>	<i>Acacia seyal</i>	<i>Sesbania sesban</i>
Feed composition				
NDF (%OM)	45.5	34.4	22.8	24.4
ADL (%OM)	16.9	8.9	6.9	4.3
Total N (%OM)	2.3	2.1	3.3	4.5
Soluble phenolics (%OM)	38.9	41.8	40.0	17.9
Proanthocyanidins (A <sub>550</sub> )	0.45	0.12	0.14	0.06
Faeces composition				
NDF (%OM)	77.43	78.45	64.53	72.99
ADL (%OM)	33.07	23.76	13.25	9.85
Total N (%OM)	2.26	2.10	2.56	1.61
NDF-N (%OM)	1.21	0.79	0.59	0.34
NDS-N (%OM)	1.04	1.31	1.98	1.27

NDF = neutral-detergent fibre; ADL = acid-detergent lignin; NDF-N = neutral-detergent-insoluble nitrogen; NDS-N = neutral-detergent-soluble nitrogen.

Source: Reed et al (1990).

The concentrations of lignin and N in faeces from sheep fed *Acacia* spp were higher than faeces from *S. sesban* (Table 2). There were also species differences in the solubility of faecal-N in neutral detergent. Sheep fed *A. cyanophylla* had the highest concentration of neutral-detergent insoluble-N and sheep fed *S. sesban* had the lowest. There is a high correlation between the concentration of lignin and PAs in browse and the concentration of neutral-detergent insoluble-N in faeces ( $r^2 = 0.971$  for lignin and  $r^2 = 0.852$  for PAs). The increase in N and lignin in the fibre fraction of faeces may result from the formation of insoluble and indigestible complexes of PAs with protein and carbohydrates that originate from the feed, rumen microorganisms or endogenous excretions of the digestive tract. PAs also shift the route of N excretion from urine to faeces. The percentage type of intake N excreted in faeces and urine, respectively, was 89 and 14% for sheep fed *A. cyanophylla* leaves, 70 and 18% for those fed *A. sieberiana*, 2 and 14% for *A. seyal*, and 50 and 36% for sheep fed *Sesbania sesban*.

A feeding trial conducted in Niger (Powell et al, 1994) indicated that feeding browse leaves reduced urine-N excretion and caused a general shift from faecal soluble- to faecal insoluble-N (Table 3). Faeces of sheep fed *Acacia trachycarpa* (AT) and *Guiera senegalensis* (GS) had higher insoluble-N content than faeces of sheep fed *Combretum glutinosum* (CG) and *Vigna unguiculata* (VU) leaves. Sheep fed CG and GS leaves actually excreted more P than the amounts they consumed. Ternouth (1989) attributed this negative P balance to the excretion of endogenous-P by the sheep.

Nitrogen excretion by sheep was better correlated to lignin:N and polyphenol:N ratios in the feed than to either lignin or polyphenol content alone (Table 4). Sheep that consumed diets (AT and GS leaves) having wide lignin:N ratios excreted the highest amounts of total- and faecal insoluble-N (Figure 1) whereas sheep fed diets with wide polyphenol:N ratios (AT, CG, and GS) excreted the

lowest amounts of urine- and faecal soluble-N (Figure 2). Feeds with high insoluble PAs contents (AT and GS leaves) also caused a shift from urine- to faecal-N, and from faecal soluble- to insoluble-N. Results from this and other feeding trials (Woodward and Reed, 1989; Reed et al, 1990) show that lignin, tannins and related phenolic compounds shift excretion of N from urine to the faeces, and increase the amount of N associated with the undigested feed component of faeces. Such shifts from urine- to faecal- and from faecal soluble- to insoluble-N may allow more N to be recycled in mixed farming systems.

**Table 3.** Daily nitrogen (N) and phosphorus (P) intakes and voiding by sheep (n = 4) fed leaves of *Pennisetum glaucum* (PG), *Vigna unguiculata* (VU), *Acacia trachycarpa* (AT), *Guiera senegalensis* (GS), and *Combretum glutinosum* (CG).

	Diet				
	PG	VU	AT	GS	CG
Total N intake (g/animal)	6.7 bc	13.2 a	7.9 b	5.2 cd	4.8 d
Total N voided (g/animal)	6.3 b	9.2 a	7.0 b	4.3 c	3.7 c
Urine-N (g/kg N intake)	254 a	228 a	105 b	74 c	189 b
Faecal-N (g/kg N intake)	684 a	457 b	769 a	778 c	610 a
Faecal soluble-N (g/kg DM)	NR	21.8 a	14.3 b	13.3 b	18.9 ab
Faecal-insoluble-N (g/kg DM)	NR	12.7 b	25.9 a	23.7 a	13.2 b
Total P intake (g/animal)	0.58 b	1.10 a	0.58 b	0.32 c	0.28 c
Total P voided (g/animal)	NR	0.72 a	0.58 b	0.54 b	0.48 b
Faecal-P (g/kg DM)	NR	4.1 ab	3.8 b	5.1 ab	5.6 a

Means within rows with similar letters are not significantly different ( $P > 0.05$ ).

1. NR indicates value not recorded.

Source: Powell et al (1994).

**Table 4.** Coefficients of correlation ( $P > 0.05$ ) for linear regression relationships between quality and nitrogen (N) voidings by sheep.

Composition of feed intake (g/kg)	Faecal-N				% faecal of total-N	% insoluble of faecal-N
	Urine-N	Total		insoluble		
		g/animal/day				
Total-N	0.39	NS	0.97	NS	NS	NS
Soluble-N	0.41	0.48	0.92	NS	NS	NS
NDF	NS	NS	-0.95	NS	NS	0.48
Lignin	-0.47	NS	NS	0.88	0.72	0.90
Lignin:N	-0.79	NS	-0.74	0.55	0.80	0.93
Lignin:NDF	NS	NS	NS	0.94	0.59	0.78
Polyphenol	-0.73	NS	-0.83	NS	0.77	0.78
Polyphenol:N	-0.83	NS	-0.91	NS	0.79	0.71
IPAC ( $A_{500}/g$ DM)	-0.59	NS	NS	0.82	0.78	0.93

NS signifies non-significant relationship.

Source: Powell et al (1994).

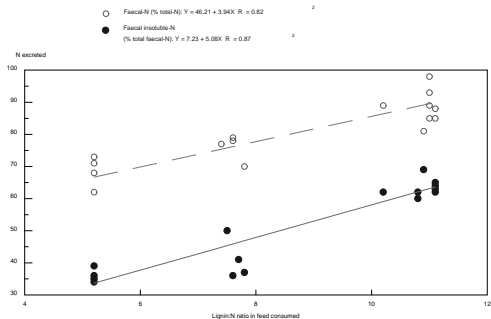
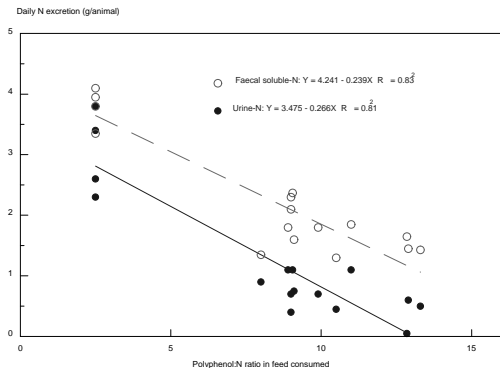
**Figure 1.** Relationship between lignin:N ratio in feeds and forms of faecal-N excreted by sheep.**Figure 2.** Relationship between polyphenol:N ratio in feeds and forms of nitrogen excreted by sheep.

## Decomposition of leaves and manure in soil

Lignin and polyphenol also affect the decomposition of organic amendments added to soils. The wider the lignin:N and polyphenol:N ratios in organic materials, the slower organic N is mineralised in soil (Fox et al, 1990; Palm and Sanchez, 1991; Oglesby and Fownes, 1992). To evaluate the relative trade-off in applying organic materials directly to soil versus feeding them to animals and applying faeces to soil, a series of trials was carried out to compare organic matter and N and P losses from crop residues and browse leaves to those of sheep faeces derived from diets containing the same crop residue and browse leaves. Leaves and faeces were collected from feeding trials in which seven browse species (*Acacia nilotica* (AN), *Anogeisus leiocarpus* (AL), *Ficus gnaphalocarpa* (FG), *Mitragyna inermis* (MI), *Pterocarpus erinaceus* (PE), and *Combretum glutinosum* (CG), *Guiera senegalensis* (GS)) and leaves from grain legume *Vigna unguiculata* (VU) were used as protein supplement to *Pennisetum glaucum* (PG) straw (Powell et al, 1994). The leaves fed to sheep were higher in organic matter (OM), generally lower in N, and much lower in P and lignin contents than corresponding manure (Table 5). Decomposition and nutrient release were evaluated using litter bags buried in a prominent acid sandy soil in western Niger.

**Table 5.** Initial chemical composition of leaves and manure used for the decomposition study.

Plant species	Organic matter		Nitrogen		Phosphorus		Lignin	
	Leaves	Manure	Leaves	Manure	Leaves	Manure	Leaves	Manure
	-----g/kg DM-----							
PG	833	682	10.0	15.7	1.0	2.5	89.7	133.7
VU	919	831	20.0	18.9	1.7	2.8	66.9	144.1
GS	941	897	15.4	21.1	0.6	3.4	228.1	324.0
CG	923	887	13.8	17.6	0.6	3.3	176.3	208.4
AN	944	900	15.9	23.5	0.8	2.8	245.0	325.5
PE	935	893	23.3	16.7	0.8	2.2	216.6	251.6
FG	813	778	14.8	17.7	1.2	2.1	181.5	206.8
AL	935	897	18.6	16.9	0.8	3.5	210.5	218.5
MI	920	881	16.0	19.2	1.0	3.4	132.8	249.2
t-Test	0.07		0.17		0.01		0.08	

PG = *Pennisetum glaucum*

VU = *Vigna unguiculata*

GS = *Guiera senegalensis*

CG = *Combretum glutinosum*

AN = *Acacia nilotica*

PE = *Pterocarpus erinaceus*

FG = *Ficus gnaphalocarpa*

AL = *Anogeisus leiocarpus*

MI = *Mitragyna inermis*

Source: Somda and Powell (unpublished).

## Changes in organic matter content in soil

For browse leaves, OM decomposition was more rapid and there were greater OM losses during the wet than the dry and cool seasons (Figure 3). Leaves of VU buried in March (dry season) lost 50% of their initial OM during the first two weeks of decomposition as compared to 15% OM loss for other



leaf materials. Based on the percentage of initial OM remaining after 112 days however, the difference between the most resistant (i.e. GS) and the least resistant (i.e. FG) browse leaves to decomposition was about 28%. For FG and PE leaves buried in July (wet season), more than 50% of OM had been lost within 14 days. From the 14<sup>th</sup> day onward AL, AN, CG and GS leaves decomposed faster than other browse leaves. Decomposition of browse leaves buried in October (cool season) was strikingly low. Total losses of OM during this period amounted to only 30–40% for browse leaves and 60% for crop residues (PG and VU leaves) 112 days after placement in the field.

The amounts of OM lost from manure varied according to the sheep diet and was relatively greater during the dry than the wet and cool seasons. Manure from diets of VU, PE, AL or FG lost about 30% of their initial OM within 14 days after burial in March (Figure 3). Decomposition slowed thereafter, especially for FG manure. After 112 days the OM content of FG manure was greater than that of any other manure type. However, sheep diet had less influence on manure decomposition during the wet season. Sheep manure buried in July lost between 25–60% of their initial OM content during the first 14 days, the largest amount being for PE and the smallest amounts for AN and GS manure. In contrast, decomposition during the cool season was markedly slower for AN and CG manure than for other manure types.

These observed OM losses from leaves and manure were consistent with results of studies on the decomposition of plant residues in West Africa (Schroth et al, 1992). Seasonal differences in decomposition appeared to be affected by soil temperature and rainfall, or moisture availability. The drier conditions and lower soil temperatures at the beginning of the dry season appeared to hinder, whereas the moist conditions and high soil temperature during the beginning of the wet season perhaps enhanced leaf and manure decomposition.

Crop residue and browse leaves and manures derived from these feeds had distinctly different decomposition patterns in soil (Figure 3). The fairly uniform decomposition and nutrient release patterns of manure versus leaves can be attributed to (1) the narrow ranges of nutrient contents between manure, (2) the presence of endogenous micro-organisms from the digestive tract, (3) and the size of the faecal undigested lignified particles, which remains fairly constant (0.5 to 1 mm) regardless of the forage (Landais and Guerin, 1992). The agronomic implication is that feeding plant materials to animal and applying manure to soil can accelerate the humification processes and nutrient turnover rates.

The decomposition of most browse leaves, crop residues and sheep manure exhibited typical decay curves that were best described using a two pool exponential model:

$$\text{Remaining OM/initial OM} = P_1e^{-k_1t} + P_2e^{-k_2t}$$

High decay rates ( $K_1$ ) in the first pool were indicative of the rapid decomposition of soluble, non-structural carbohydrates and other low C/N ratios compounds. Decay rates ( $K_2$ ) for the second pool can be related to the more recalcitrant structural carbohydrates and other lignified compounds which were more resistant to degradation. During the dry season, nearly all OM in CG leaves and GS, AN and AL manure was in the easily decomposable form compared to 70% for AN and GS leaves and less than 45% for the other leaves (Table 6). Decomposition rates (daily % OM disappeared) of the structural components of OM varied according to manure type and season, ranging from 0.6–2.4%, 0.7–1.8%, and 1.3–2.3% during the dry, wet and cool seasons, respectively.

The time required to reach 95% OM decomposition ranged from a low of 198 days for VU to a high of 508 days for GS leaves during the dry season and from 81 days for VU to 370 days for AL leaves during the wet seasons. For manure, these times ranged from 91 days for AL to 336 days for FG manure during the dry season, 157 days for CG to 359 days for FG during the wet season and from 109 days for PE to 218 days for CG during the cool seasons.

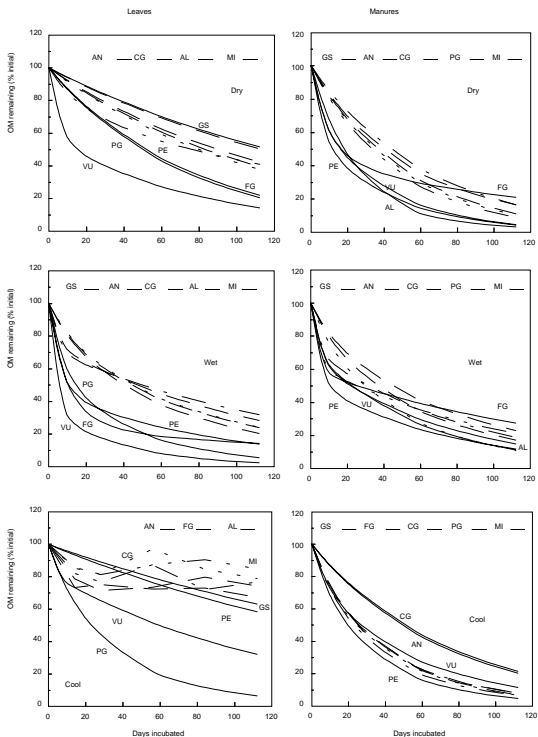
**Figure 3.** Decomposition of leaf and manure OM during the dry, wet, and cool seasons in Niger.

**Table 6.** Parameters of the equation  $[P_1e^{-k_1t} + (1-P_1)e^{-k_2t}]$  fitted to the percentage of initial organic matter (OM) remaining in leaves and manure during the dry, wet and cool seasons in Niger.

Plant types	Leaves			Manure		
	P <sub>1</sub> (%)	K <sub>1</sub> ----- (g/day) -----	K <sub>2</sub>	P <sub>1</sub> (%)	K <sub>1</sub> ----- (g/day) -----	K <sub>2</sub>
<i>Pennisetum glaucum</i>	33.5	0.014	0.014	–	–	–
<i>Vigna unguiculata</i>	43.1	0.205	0.012	30.3	0.178	0.024
<i>Guiera senegalensis</i>	66.9	0.006	0.006	98.3	0.019	0.019
<i>Combretum glutinosum</i>	95.8	0.009	0.009	57.5	0.020	0.020
<i>Acacia nilotica</i>	72.6	0.008	0.008	82.4	0.021	0.006
<i>Pterocarpus erinaceus</i>	24.1	0.064	0.005	43.5	0.175	0.023
<i>Ficus gnaphalocarpa</i>	37.9	0.013	0.013	57.0	0.108	0.006
<i>Anogeisus leiocarpus</i>	30.6	0.011	0.006	94.0	0.042	0.008
<i>Mitragyna inermis</i>	–	–	–	33.9	0.022	0.022
SE	8.08	0.0218	0.0011	9.39	0.0248	0.0028
Wet season						
<i>Pennisetum glaucum</i>	44.4	0.012	0.020	26.9	0.381	0.012
<i>Vigna unguiculata</i>	66.8	0.305	0.023	27.6	0.349	0.017
<i>Guiera senegalensis</i>	24.8	0.246	0.009	27.1	0.054	0.013
<i>Combretum glutinosum</i>	25.2	0.058	0.010	21.4	0.076	0.018
<i>Acacia nilotica</i>	26.0	0.060	0.011	21.2	0.064	0.011
<i>Pterocarpus erinaceus</i>	54.4	0.182	0.011	47.8	0.246	0.013
<i>Ficus gnaphalocarpa</i>	75.4	0.106	0.005	40.5	0.343	0.007
<i>Anogeisus leiocarpus</i>	28.5	0.261	0.007	34.4	0.231	0.013
<i>Mitragyna inermis</i>	25.6	0.061	0.010	36.1	0.356	0.010
SE	6.64	0.0319	0.0020	3.32	0.0469	0.0012
Cool season						
<i>Pennisetum glaucum</i>	62.6	0.048	0.002	43.0	0.054	0.019
<i>Vigna unguiculata</i>	17.5	1.292	0.008	26.5	0.100	0.017
<i>Guiera senegalensis</i>	–	–	–	30.9	0.057	0.019
<i>Combretum glutinosum</i>	–	–	–	30.5	0.014	0.014
<i>Acacia nilotica</i>	–	–	–	86.8	0.014	0.013
<i>Pterocarpus erinaceus</i>	–	–	–	39.1	0.069	0.023
<i>Ficus gnaphalocarpa</i>	–	–	–	20.4	0.075	0.022
<i>Anogeisus leiocarpus</i>	–	–	–	17.6	0.113	0.022
<i>Mitragyna inermis</i>	–	–	–	28.7	0.061	0.020
SE	–	–	–	9.49	0.0314	0.0034

(–) Indicates convergence problems or model not appropriate.

### Mineralisation/immobilisation of N and P in soil

There were seasonal differences in the patterns of nutrient release from leaves and manure. Mineralisation/immobilisation patterns varied considerably among the various leaves and manure. When applied to soil, N and P release was faster and greater from manure than from browse leaves

(Figures 4 and 5). Whereas browse leaves immobilised nutrients, between 10 and 50% of N and P in manure from sheep fed the same leaves was mineralised within the first four weeks after application to soil. Net N and P mineralisation in manure exhibited decay patterns similar to OM loss (Table 7). The rapid nutrient release from manure may be related to the relative large amounts of soluble-N applied. A second, more recalcitrant pool of nutrient, which is probably composed primarily of insoluble lignoproteins, is represented by the second mineralisation constant of the two-pool exponential model. In comparing the decomposition constants ( $K_1$  and  $K_2$ ) of leaves and manure, it is clear that leaf passage through livestock enhances the rate of N and P mineralisation in soil.

**Table 7.** Parameters of the model  $[P_1e^{-k_1t} + (1-P_1)e^{-k_2t}]$  fitted to nitrogen (N) and phosphorus (P) mineralisation from sheep manure in soil during the dry, wet and cool seasons in Niger.

Plant types	N remaining (% initial)			P remaining (% initial)		
	P <sub>1</sub>	K <sub>1</sub>	K <sub>2</sub>	P <sub>1</sub>	K <sub>1</sub>	K <sub>2</sub>
Dry season						
<i>Pennisetum glaucum</i>	35.1	0.067	0.017	–	–	–
<i>Vigna unguiculata</i>	29.8	0.138	0.035	27.5	0.176	0.034
<i>Guiera senegalensis</i>	–	–	–	21.4	0.020	0.020
<i>Combretum glutinosum</i>	82.3	0.030	0.020	71.0	0.026	0.026
<i>Acacia nilotica</i>	93.5	0.017	0.017	–	–	–
<i>Pterocarpus erinaceus</i>	22.5	0.224	0.032	43.2	0.040	0.039
<i>Ficus gnaphalocarpa</i>	33.2	0.091	0.015	88.9	0.033	-0.012
<i>Anogeisus leiocarpus</i>	73.5	0.033	0.033	51.2	0.047	0.047
<i>Mitragyna inermis</i>	37.3	0.021	0.021	37.8	0.212	0.022
SE	9.74	0.0255	0.0029	8.68	0.0301	0.0072
Wet season						
<i>Pennisetum glaucum</i>	39.7	0.010	0.012	54.3	0.463	0.013
<i>Vigna unguiculata</i>	64.6	0.225	0.011	–	–	–
<i>Guiera senegalensis</i>	40.7	2.381	0.008	30.9	0.216	0.021
<i>Combretum glutinosum</i>	52.5	0.271	0.008	–	–	–
<i>Acacia nilotica</i>	45.8	0.068	0.010	80.1	0.042	0.003
<i>Pterocarpus erinaceus</i>	62.2	0.225	0.011	53.1	0.063	0.016
<i>Ficus gnaphalocarpa</i>	50.4	0.396	0.006	47.8	0.090	0.006
<i>Anogeisus leiocarpus</i>	42.0	0.382	0.011	36.4	0.141	0.021
<i>Mitragyna inermis</i>	49.8	0.277	0.008	84.7	0.437	0.0001
SE	2.97	0.0480	0.0007	7.71	0.0663	0.0032
Cool season						
<i>Pennisetum glaucum</i>	17.3	0.046	0.017	94.4	0.061	-0.012
<i>Vigna unguiculata</i>	75.5	0.076	0.008	86.1	0.098	-0.008
<i>Guiera senegalensis</i>	77.9	0.021	0.045	98.2	0.054	-0.026
<i>Combretum glutinosum</i>	–	–	–	66.0	0.053	-0.001
<i>Acacia nilotica</i>	44.6	0.015	0.015	37.0	0.114	0.0066
<i>Pterocarpus erinaceus</i>	89.3	0.037	0.006	57.9	0.094	0.0172
<i>Ficus gnaphalocarpa</i>	–	–	–	82.3	0.040	-0.005
<i>Anogeisus leiocarpus</i>	29.5	0.086	0.019	38.8	0.142	0.0309
<i>Mitragyna inermis</i>	24.9	0.055	0.015	37.8	0.199	0.0181
SE	11.03	0.0100	0.0049	8.29	0.0171	0.0059

(–) Indicates convergence problems or model not appropriate.

**Figure 4.** Cumulative amount (means and  $LSD_{0.05}$ ) of N mineralised from leaves and manure during the dry, wet and cool seasons in Niger.

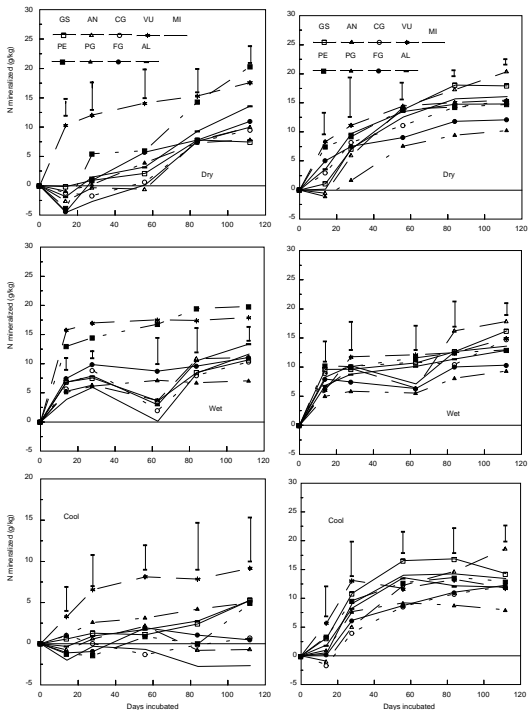

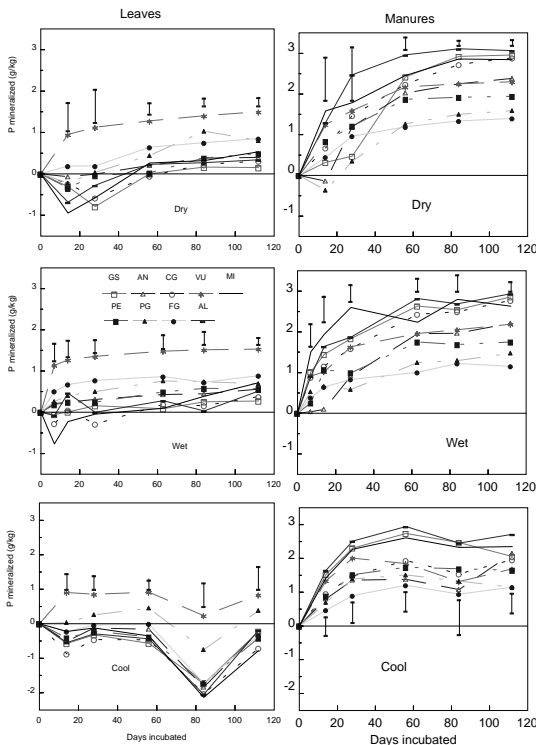
**Figure 5.** Cumulative amount (means and  $LSD_{0.05}$ ) of P mineralised from leaves and manure during the dry, wet and cool seasons in Niger.

Browse and PG leaves immobilised soil N and P during the early part of the dry season followed by a gradual nutrient release during the remainder of this study period (Figures 4 and 5). In contrast, VU leaves and most manure (except for AN and PG) immediately mineralised N and P during all three seasons. After two weeks of immobilisation, AN and PG manure released N and P. These patterns of mineralisation/immobilisation changed during the wet season when large amounts of N from leaves, and especially manure, were rapidly mineralised. Except for AL, AN and MI leaves which immobilised P briefly, leaves and manure immediately released P throughout the wet season incubation period. Patterns of nutrient release from manure were similar during the dry and cool seasons, but were different for browse leaves. For example, immobilisation of P by all browse leaves occurred up to day 56 during the dry season and day 112 during the cool season. All browse leaves immobilised similar amounts of P throughout the cool season.

The estimated average application rate of small ruminant manure by farmers in Niger is 1.5 t/ha (Powell and Williams, 1993). Using the double exponential models (Table 7) it is possible to predict the amount of N and P released from 1.5 t/ha of sheep manure incorporated into cropland before the wet season in March. The greatest potential for N release (kg/ha) before millet planting in June would be from AN (34.0), followed by GS (30.0), MI and VU (27.5) and lastly PG (22.5) manure. Since many soils of this region are more P than N deficient (Breman and de Witt, 1983), the 2.1 to 4.6 kg P/ha released from manure would likely provide an important contribution of the total 6.1 kg P/ha required by millet. More than half of the total faecal-N (14.3 to 21.2 kg/ha) and faecal-P (1.3 to 3.1 kg/ha) would be released within the first four weeks after manure application during the early cropping season. The portion of N and P released that would be available for uptake by millet would depend, however, on the rate and magnitude of microbial and chemical immobilisation, losses by volatilisation, leaching and termite removal.

## Conclusion

Improved management of plant materials for animal feed and soil amendments is necessary in the semi-arid region of West Africa where inorganic fertilisers are largely unavailable and farmers rely on organic matter recycling to sustain cropland productivity. This study showed that there are distinct tradeoffs in feeding crop residues and browse first to sheep and applying manure, versus applying the plant materials directly to soil. The tannins and related polyphenolics in browse appear to enhance nutrient cycling. When fed to sheep browse cause a shift from the excretion of urine-N, which is subject to large volatile losses, to faecal-N, especially recalcitrant-N forms, which can be recycled through soil. Feeding crop residues and browse to animals enhances nutrient cycling: manure-bound N and P mineralised much faster than plant-bound N and P. Seasonal differences in the mineralisation/immobilisation patterns of leaves and manure highlighted the importance of timing organic residue application so that mineralisation coincides with crop nutrient demand.

## References

- ARC (Agricultural Research Council). 1984. *The nutrient requirements of ruminant livestock. Supplement 1*. Report of protein group of the Agricultural Research Council Working Party on the nutrient requirements of ruminants. Commonwealth Agricultural Bureaux, Slough, UK. 45 pp.
- Bate-Smith E C. 1973. Tannins in herbaceous leguminosae. *Phytochemistry* 12:1809–1812.
- Bationo A and Mokwunye A V. 1991. Roles of manures and crop residues in alleviating soil fertility constraints to crop production: With special reference to the Sahelian and Sudanian zones of West Africa. *Fertilizer Research* 29:117–125.
- Breman H and de Witt C T. 1983. Rangeland productivity and exploitation in the Sahel. *Science* 221:1341–1347.
- Church D C. 1975. *Digestive physiology and digestion of ruminants. Volume 1. Digestive physiology*. Second edition. O & B Books, Corvallis, Oregon, USA. pp. 115–132.

- Fox R H, Myers R J K and Vallis I. 1990. The nitrogen mineralization rate of legume residues in soil as influenced by their polyphenol, lignin, and nitrogen contents. *Plant and Soil* 129:251–259.
- Goering H K, Gordon C H, Hemken R W, Waldo D R, Van Soest P J and Smith L W. 1972. Analytical estimates of nitrogen digestibility in heat damaged forages. *Journal of Dairy Science* 55:1275.
- Haslan E. 1989. *Plant polyphenols—Vegetable tannins revisited*. Cambridge University Press, Cambridge, UK. 230 pp.
- Knapp E B, Elliot L F and Campbell S G. 1983. Carbon, nitrogen and microbial biomass interrelationships during the decomposition of wheat straw: A mechanistic simulation model. *Soil Biology and Biochemistry* 14:455–461.
- Kowal J M and Kassam A H. 1978. *Agricultural ecology of savanna: A study of West Africa*. Clarendon Press, Oxford, UK. 403 pp.
- Landais E and Guerin H. 1992. Systèmes d'élevage et transferts de fertilité dans la zone des savanes africaines. *Cahiers Agricultures* 1:225–238.
- Le Houérou H N. 1980. Browse in Northern Africa. In: Le Houérou H N (ed), *Browse in Africa: The current state of knowledge*. International Symposium on Browse in Africa, Addis Ababa, April 8–12, 1980. ILCA (International Livestock Centre for Africa), Addis Ababa, Ethiopia. pp. 55–82.
- Little D A. 1980. Utilization of minerals. In: Hacker J B (ed), *Nutritional limits to animal production from pastures*. Proceedings of an International Symposium, St. Lucia, Queensland, Australia. Commonwealth Agricultural Bureaux, Slough, UK.
- Mason V C. 1969. Some observations on the distribution and origin of nitrogen in sheep feces. *Journal of Agricultural Science (Cambridge)* 73:99–111.
- Mason V C and Frederiksen W. 1979. Partition of nitrogen in sheep faeces with detergent solutions, and its application to the estimation of the true digestibility of dietary nitrogen and the excretion of non dietary fecal nitrogen. *Zeitschrift für tierphysiologie, tierernahrung und futtermittelkunde* 41:121–131.
- Oglesby K A and Fownes J H. 1992. Effects of chemical composition on nitrogen mineralization from green manures of seven tropical leguminous trees. *Plant and Soil* 143:127–132.
- Orskov R E. 1982. *Protein nutrition in ruminants*. Academic Press, London, UK. pp. 80–81.
- Otsyina R M and McKell C M. 1984. Africa: Browse in the nutrition of livestock: A review. *World Animal Review* 53:33–39.
- Palm C A and Sanchez P A. 1991. Nitrogen release from the leaves of some tropical legumes as affected by their lignin and polyphenolic contents. *Soil Biology and Biochemistry* 23:83–88.
- Parr J F and Papendrick R I. 1978. Factors affecting the decomposition of crop residues by microorganisms. In: Oschwald W R (ed), *Crop residue management systems*. American Society of Agronomy, Madison, Wisconsin, USA. pp. 101–129.
- Powell J M and Williams T O. 1993. *Livestock, nutrient cycling and sustainable agriculture in the West African Sahel*. Gatekeeper Series SA37. IIED (International Institute for Environment and Development), London, UK. 15 pp.
- Powell J M, Ikpe F N and Somda Z C. 1992. Nutrient cycling in low external input millet-based mixed farming systems of West Africa. *Agronomy Abstracts*. American Society of Agronomy, Madison, Wisconsin, USA. p. 70.
- Powell J M, Fernandez-Rivera S and Höfs S. 1994. Effects of sheep diet on nutrient cycling in mixed farming systems of semi-arid West Africa. *Agriculture Ecosystems & Environment* 48:263–271.
- Reed J D. 1986. Relationship among soluble phenolics, insoluble proanthocyanidins and fiber in East African browse species. *Journal of Rangeland Management* 39:5–7.
- Reed J D, Horvath P J, Allen M S and Van Soest P J. 1985. Gravimetric determination of soluble phenolics including tannins from leaves by precipitation with trivalent ytterbium. *Journal of the Science of Food and Agriculture* 36:255–261.
- Reed J D, Soller H and Woodward A. 1990. Fodder tree and straw diets for sheep: Intake, growth, digestibility and the effects of phenolics on nitrogen utilization. *Animal Feed Science and Technology* 30:39–50.



- Russelle M P. 1992. Nitrogen cycling in pasture and range. *Journal of Production Agriculture* 5:13–25.
- Ryden J C, Whitehead D C, Lockyer D R, Thompson R B, Skinner J H and Garwood E A. 1987. Ammonia emission from grassland and livestock production in the U.K. *Environmental Pollution* 48:173–184.
- Sanford S. 1989. Integrated cropping–livestock systems for dryland farming in Africa, In: Unger P W, Sneed T V, Jordan W R and Jensen R (eds), *Challenges in dryland agriculture — A global perspective*. Proceedings of the International Conference on Dryland Farming. Texas Experiment Station, College Station, Texas, USA. pp. 861–872.
- Schroth G, Zech W, and Heimann G. 1992. Mulch decomposition under agroforestry conditions in a sub-humid tropical savanna processes and influence of perennial plants. *Plant and Soil* 147:1–11.
- Stafford H A. 1990. *Flavonoid metabolism*. CRC Press Inc., Boca Raton, Florida, USA. 298 pp.
- Swift M J, Frost P G H, Campbell B M, Hatton J C and Wilson K. 1989. Nutrient cycling in farming systems derived from Savanna: Perspectives and challenges. In: Clarholm M and Berstrom B (eds), *Ecology of arid lands*. Kluwer Academic Publisher, Dordrecht, Germany. pp. 63–76.
- Ternouth J H. 1989. Endogenous losses of phosphorus by sheep. *Journal of Agricultural Science (Cambridge)* 113:291–297.
- Van Soest P J. 1982. *Nutritional ecology of the ruminant*. O & B Books, Corvallis, Oregon, USA. 374 pp.
- Woodward A and Reed J D. 1989. The influence of polyphenolics on the nutritive value of browse: A summary of research conducted at ILCA. *ILCA Bulletin* 35:2–11. ILCA (International Livestock Centre for Africa), Addis Ababa, Ethiopia.

# **Interactions between plants and soils**

# Nutrient recycling in pastures, rangeland, fallow and cut-and-carry systems in sub-Saharan Africa

A. A. Agboola and A. A. Kintomo

Department of Agronomy, University of Ibadan, Ibadan, Nigeria

## Abstract

Sustainable agriculture is viewed as a long-term goal that seeks to overcome problems and constraints confronting the economic viability, environmental soundness and social acceptance of agriculture production systems. Improved nutrient cycling is one of the soil conservation practices that may increase soil productivity in sub-Saharan Africa (SSA). Six agricultural models with different nutrient recycling mechanisms are identified for the ecological zones of SSA. These models are for distant farms, compound farms, crop, livestock, crop–livestock, and urban production systems. Nutrient recycling efficiency is highest in compound farms, followed by crop–livestock, crop, livestock, and urban farms. It is estimated that 102 million tonnes of refuse are generated annually, and 27 million tonnes of human waste dry matter from the urban centres are not utilised. Higher nutrient recycling efficiency could be attained by integrating human–crop–livestock segments in each respective model for sustainable agricultural development in SSA. Such an objective can be achieved by educating the populace on the advantages of nutrient recycling. Short- and long-term research should be planned and executed to accomplish such goals.

## Le recyclage des éléments nutritifs dans les pâturages, les terres de parcours et les jachères et l'alimentation à l'auge en Afrique subsaharienne

A. A. Agboola et A.A. Kintomo

Department of Agronomy, University of Ibadan, Ibadan (Nigéria)

## Résumé

*La durabilité agricole est considérée comme un objectif à long terme destiné à surmonter les obstacles à l'amélioration de la rentabilité économique et de la qualité de l'environnement ainsi qu'à l'acceptation sociale des systèmes de production. L'amélioration du recyclage des éléments nutritifs est une technique de conservation des sols capable d'accroître la productivité des sols en Afrique subsaharienne. Six modèles agricoles avec différents mécanismes de recyclage des éléments nutritifs ont été identifiés pour les différentes zones écologiques de la région. Ces modèles portent sur les champs éloignés, les champs de case, et les systèmes agricoles, pastoraux, agropastoraux ou urbains. L'efficacité du recyclage des éléments nutritifs était maximum dans les champs de case, suivis des systèmes agropastoraux, agricoles, pastoraux et urbains. On estime que 102 millions de tonnes de déchets sont produits chaque année et que 27 millions de tonnes de matière sèche des déchets ménagers provenant des centres urbains ne sont pas utilisés. Le recyclage des éléments nutritifs serait plus efficace si on intégrait le paramètre humain, les cultures et le bétail dans chaque modèle en vue de promouvoir un développement durable dans cette région. Cela n'est possible que si l'on amène les populations à prendre conscience des avantages du recyclage des éléments nutritifs. Des recherches à court et à long terme devraient être planifiées et exécutées pour faire de cet objectif une réalité.*

## Introduction

Nutrient cycling in plant/soil systems can be described as the functioning of biological components within a prescribed area, at a given cost and with acceptable risk that ensures the transformation of solar energy into animal and vegetable biomass to supply the needs of the population (Pierre, 1992). Fertilisers, particularly those containing nitrogen, require much fossil energy in their manufacture; this energy is increasingly expensive and, moreover, is a diminishing resource. The raw materials used to make fertilisers have to be mined, and although supplies are expected to last many decades, the reserves in economically workable concentrations do not have an infinite life. These considerations, plus a greater awareness of the need to protect the environment from the polluting effects of excess fertilisers and to avoid damage to the physical environment and landscape of the planet, emphasise the need to quantify the movement of nutrients from soil to plant to animals and back to the soil. The transfer of minerals among different types of living matter and parts of the physical environment may be described as nutrient cycling.

Nutrients which are essential for the growth of plants and animals are recycled continuously in the plant-animal-soil continuum. Nutrient transfers through a series of compartments constitute one of the simplest representations of a nutrient cycle. In most practical situations, whether concerned with natural or man-controlled systems, the sequence is more complex.

Many cycles are polycyclic in that an element may cycle through several processes within a compartment (e.g. soil) before being passed to the next compartment (e.g. plant). The time taken for a nutrient to complete a cycle varies from minutes in transfers involving micro-organisms, to months for uptake by, and growth of annual crops, to years for intake and growth of animals and to thousands and million of years for transfers involving the physical environments, e.g. from atmosphere to land and sea and the formation of rocks. Thus, the time scale of any nutrient cycle under study must be carefully defined; any measurement at an instant of time usually neglects some other aspects of the dynamic nature of nutrient cycling.

To understand and quantify the cycling of any element it is necessary to design a conceptual model to represent the predominant agricultural systems in each ecological zone in sub-Saharan Africa (SSA). Such a model would be extremely complex since it would be composed of human (rural and urban populations with their own organisations and dynamics), physical (climate and soils) and technical (farm management) components which interact within variable socio-economic conditions. Nutrient cycling in plant-livestock-soil systems cannot, therefore, be fully understood if the soil and plants and livestock systems are considered in isolation. In this paper agricultural practices in SSA are classified into relatively simple units, a single farm, that are situated in a given agro-ecosystem. It was assumed that an agricultural ecosystem is an organisation of resources, managed to a greater or lesser extent by man with production of human food as one of its main objectives.

Pierre (1992) defined an agro-ecosystem as a recognisable part of the biosphere affected or determined to a certain degree by agricultural practices, and deriving its properties and features from those of its structural components, and most typically, from interactions between those components. The main characteristic of an agro-ecosystem is that it is a system which produces food or fibre which is passed through the boundaries of the system *per se*, and as such, conflicts with the established definition of an ecosystem. The main objectives of this paper are to identify the major agricultural systems in SSA in relation to their nutrient recycling potential and develop models to understand the processes involved in nutrient recycling for each ecological zone.

## Inventory of nutrient recycling potentials in sub-Saharan Africa

Approximately 54% of the total arable land is already cultivated in SSA (Table 1) and 92 million ha are in fallow. At the onset of cropping when the fallow is opened up, there are varying amounts of nutrients stored in the soil and vegetation for subsequent crop use. The amount of nutrients stored

depends on the vegetation which varies by ecosystem and land use (Table 2). If the fallow is burnt, all the nitrogen will be lost. During the cropping period, considerable amounts of nutrients may be harvested from the soil in the form of food and crop residues. Crop residues are usually burnt but some may be incorporated into the soil.

The estimated human population in SSA is 640 million; it generates about 102 million tonnes of refuse annually. The human waste potential is about 27 million tonnes per annum. Over 80% of the populace uses firewood for cooking thereby removing vegetation. The ashes are not returned to the source. There are also large amounts of animal waste that can be recycled in SSA (Alexandratos, 1988).

**Table 1.** Assessment of arable land in sub-Saharan Africa.

	Total	LR	UR	GR	PR	FL	IR
Harvested land (10 <sup>6</sup> ha)	109	19	22	34	29	3	3
Cropping intensity (%)	54	45	53	61	52	67	84
Arable land (10 <sup>6</sup> ha)	201	42	41	55	55	5	4

Estimated fallow land is 92.46 million ha.

LR = low rainfall; UR = uncertain rainfall; GR = good rainfall; PR = problem soils; FL = flooded land; IR = irrigated land.

Source: Adapted from FAO (1988).

**Table 2.** Plant nutrients stored in different classes of fallow vegetation.

	I	II	III	IV	V
	Forest	<i>Acioa barteri</i>	Savannah woodland	<i>Andropogon gayanus</i>	<i>Imperata cylindrica</i>
	----- kg/ha -----				
N	1634	277	251	113	15
P	112	24	25	20	5
K	731	155	248	171	31
Ca	2254	205	394	241	6
Mg	309	131	93	79	12
Rainfall (mm)	1625	1800	1000	1475	1475

I 40 years mature secondary forest, Ghana.

II 6-year old fallow, Benin, Nigeria.

III 10-year old fallow, Ghana.

IV Undisturbed savannah for over 20 years, Ghana.

V 3-4 year old fallow, Ghana.

Source: Nye and Greenland (1960).

African agriculture must be productive, competitive and profitable, conserve natural resources, protect the environment, enhance public health, food quality and health. Under the low input technology common to SSA, there must be skilled management in order to achieve these goals (Figure 1). Improved nutrient recycling is one of the soil conservation practices necessary to achieve such goals and also increase soil productivity.

**Figure 1.** Idealised model for sustainable agriculture in sub-Saharan Africa.

## SUSTAINABLE AGRICULTURE

An agriculture that is...

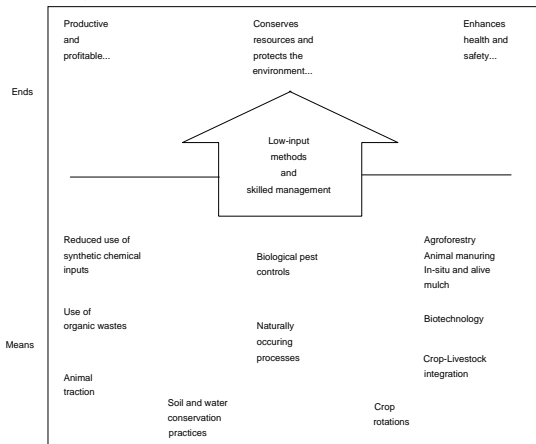
**Methods of assessing the present potentials for nutrient recycling**

In assessing the potentials of nutrient cycling in SSA, four models will be used: (1) Livestock; (2) crops consisting of distant and compound farms; (3) crop/livestock or mixed farming; and (4) urban centres. The models are discussed in context of rangeland, improved pasture, cut-and-carry and fallow systems (Table 3) according to the ecological zones in SSA (Table 4).

**Table 3.** Relationship between the models and some agricultural systems in sub-Saharan Africa.

Agricultural system	Livestock	Crop			Urban
		Distant farms	Compound farms	Mixed farms	
Rangeland	X	X		X	
Improved pasture	X			X	
Cut-and-carry	X	X	X	X	X
Fallow		X		X	

**Table 4.** Estimated distribution of models across ecological zones in sub-Saharan Africa.

	Ecozone			
	Semi-arid	Subhumid	Humid	Highlands
	----- % occurrence -----			
Livestock	50	5	5	20
Crop				
Distant farm	5	35	30	30
Compound farm	10	30	30	30
Mixed farms	20	25	5	50
Urban	10	40	40	10

### The extensive livestock model

For the purpose of this paper, rangeland is referred to as natural unsown pastures. Rangelands are most common in the semi-arid and subhumid zones which contain approximately 80% of the ruminant livestock of SSA. The free ranging of ruminant livestock is the predominant production practice of the extensive livestock model. Rangelands and crop residues provide most sources of feed. However, crop residue grazing results in a removal of organic matter and macro nutrients from cropping systems that largely rely on organic matter recycling to maintain soil productivity. Although the ideal, perhaps, would be to return crop residues to cropland, the current practice is to burn ungrazed residues to facilitate manual cultivation. Burning results in almost total loss of N, however, the additional labour involved in gathering, storing, respreading and incorporating crop residues into the soil exceeds the capabilities of farmers. Grazing by animals appears to be a viable alternative to burning but requires a more widespread use of chemical fertilisers and organic manures if the soils are to remain productive.

In the humid zone, small ruminants are not integrated into the farming system except in some locations like south-eastern Nigeria where they are confined to compound farms. The bulk of nutrient losses are from distant farms, where crops are harvested, and the grains processed by women in compound farms. Crop residues are also occasionally used for cooking and may be burnt *in situ* at the beginning of the planting season during land preparation.

An advantage of extensive livestock production is that it requires little in terms of inputs and management. The tedious work of searching for consumable plants is carried out by the animals. The system also offers the possibility of converting rangelands vegetation and crop residues, that are not suitable for human consumption, into products which are consumable by man. Rangelands that contain legumes can convert atmospheric N into products for human consumption. A disadvantage is that some of the fixed N will be lost via volatilisation of ammonia from animal excrements. In addition to these volatile N losses, N is also lost through annual bush burning, especially in the savannah.

Nitrogen (N), phosphorus (P) and potassium (K) are the essential elements withdrawn from the extensive livestock model. For P and K the system is very efficient since most of these nutrients are returned to the soil in the form of animal faeces; only the P and K present in meat and milk are withdrawn from the system.

Although animals deposit manure on the fields during grazing, this recycles negligible amounts of dry matter and nutrients back to cropland. In northern Nigeria, the Fulani herdsmen keep their herds overnight on cropland during the dry season. This practice provides large amounts of manure with minimal labour. Preliminary trials conducted in central Nigeria showed that annual manure

applications of 3 t/ha was needed to maintain grain yields (Watson and Goldsworthy, 1964). The Fulani practice of manuring their own fields every other year at 5 to 6 t/ha appears to be a rational strategy (Powell and Mohamed-Saleem, 1987).

Nutrient cycling in extensive livestock grazing systems involves nutrient flows among various plant, animal and soil components (Table 5). Nutrient losses in the system are due mostly to burning. Livestock productivity is low because they are not fully integrated into the cropping systems. Livestock can have a negative effect on system productivity by trampling, when herdsmen loop trees excessively for feed, and by overgrazing which can lead to soil degradation.

**Table 5.** *Nutrient flows under extensive livestock grazing.*

Changes in plant nutrient component	
Supplies	Input by seed or seedling
	Transfer by net uptake from soil
Removals	Input by uptake from atmosphere
	Transfer by grazing of forage
	Output by primary products
	Transfer by plant production remaining on field
	Transfer by seed for sowing
	Burning of plant material
Changes in animal nutrient component	
Supplies	Transfer by consumption of harvested crops
	Transfer by grazing of forage
Removals	Output by animal products
	Transfer by droppings on grazed areas
Changes in soil nutrient component	
Supplies	Transfer by application of manure/wastes
	Transfer by grazing
	Input by N fixation
	Transfer by plants remaining on the field
Removals	Output by annual burning
	Output by denitrification
	Output by volatilization of ammonia
	Output by leaching
	Output by runoff
	Transfer by net uptake by plants

Increasing population pressure is putting a strain on the ecological balance in both semi-arid and subhumid environments. Although land for grazing and cropping is relatively abundant in the subhumid zone a point will come when cattle and cropping will compete for diminishing land resources. When cultivation density reaches 40% in the subhumid zone of Nigeria, it has been projected that cattle numbers will decrease (Bourn and Milligan, 1983). Innovations such as fodder banks which benefit both crop and livestock production have been suggested as a viable alternative to traditional methods of production in the subhumid zone (Mohamed-Saleem, 1986). In the humid zone alley farming has been advocated.



## The arable crop model

The arable crop farm model operates mostly at the distant farm but also at the compound farm. Distant farms, located far from farmers' immediate homesteads, are quite distinct from the compound farms. In humid environments plantation crops such as cocoa, rubber, oil palm and arable crops are cultivated in the distant farms. Animals may or may not be well integrated into these systems. Food crops are harvested and carried to the compound or homestead by the farmers where they are processed and used for food while crop residues may be used for livestock feed. Similarly, cut-and-carry systems may operate in the arable crop model. Forage legumes are harvested for livestock within the vicinity of the distant farm both from cultivated and fallow fields — a practice that represents a loss of nutrients from the system. Farmers rely on organic matter recycling, mainly crop residues, inorganic nutrient sources and fallow to maintain soil productivity.

At the end of the fallow the cropping phase starts with the slash and burn system. Most of the vegetation on the soil surface is turned to ashes; nitrogen and sulphur are lost during burning. The nutrients that are stored in fallow depend on the predominant type of fallowland vegetation which varies with agroclimatic zone (Table 2). Although most of the nutrients left in the ashes will be recycled during cropping, some will be blown away by the wind.

During cropping nutrients are removed in the form of food (Table 6) and feed. For legumes which fix atmospheric-N, much of the N can be replaced naturally but other nutrients such as P, K Ca and Mg are not returned to the distant farm. The amount of nutrients removed from the farm can be particularly striking. Stangel (1991) estimated that the net annual removal of nutrients in SSA is 49 kg/ha (or a total of 9.3 million t/yr) and that these are projected to increase to 60 kg/ha (or total 13.2 million t/yr) by the year 2000 (Table 7) unless some major shifts in nutrient management occur soon and/or off-farm demand is curtailed.

**Table 6.** *Nutrient removal by the major food crops cultivated in sub-Saharan Africa.*

Crop	Nutrient removal (kg/ha)		
	N	P	K
Sorghum	30.0	5.4	19.0
Millet	28.0	5.2	21.5
Wheat	28.0	5.2	21.5
Rice	16.0	3.6	22.1
Maize	20.0	3.6	16.6
Potatoes	4.4	0.9	6.5
Sweet potatoes	4.0	0.4	5.0
Cassava	4.0	0.7	7.2
Beans	60.0	3.5	33.1
Peas	60.0	3.5	24.8
Groundnuts	70.0	4.4	32.1
Soybeans	10.4	7.8	32.8
Bananas	2.0	0.2	5.5
Colocasia	4.4	0.9	6.4
Yam	4.4	0.9	6.4
Cotton	22.6	3.5	9.1

**Table 7.** *Nutrient mining in sub-Saharan Africa.*

Year	Nutrient removal (kg/ha)		
	N	P <sub>2</sub> O <sub>5</sub>	K <sub>2</sub> O
1983	23	7	19
2000	27	8	25
Year	Nutrient removal (10 <sup>6</sup> t/year)		
	N	P <sub>2</sub> O <sub>5</sub>	K <sub>2</sub> O
1983	4.4	1.2	3.7
2000	6.1	1.7	5.5

Source: Stangel (1991).

In terms of nutrient recycling, the arable crop model has low productivity. Nutrients are wasted due to the slash and burn which is carried out at the onset of cropping phase. Presently about 201.3 thousand hectares of land are still under slash and burn in humid central Africa. Based on the nutrient content of typical fallow land the humid central zone of Africa loses about 2341 million tonnes of N a year to annual burning.

Another area of nutrient loss in the arable system is via leaching. Leaching of nutrients can be one of the most serious problems in nutrient recycling and can lead to rapid deterioration of land during the cropping phase. It is known that nitrate adsorption commonly occurs in acid soils throughout the tropics. Therefore, in soils where nitrate adsorption occurs an increase in soil pH can lead to a competition between nitrate and other anions such as chloride, sulphate, phosphate and organic anions, and increase the rate of nitrate leaching.

In the forest ecosystem large leaching losses of N and other nutrients have been recorded by Wong (1991) who calculated from crop uptake that only 1.9% of the total soil N content was mineralised over two years, of which 42% was lost by leaching. Furthermore, 65% of labeled <sup>15</sup>N was leached from a field cropped to maize during the first year and uncropped in second year.

In both the forest and savannah zones of SSA large amounts of nutrients are removed from the system. Nutrient losses from arable land occur mostly from the plant pool through the removal of grain, roots, tubers etc (Table 8). Another major source of nutrient loss within this system is through the removal of crop residues from the field after each cropping season (Figure 2). There is also heavy soil loss in hilly areas and heavily populated regions.

### Distant farms

The distant farm model consists of a fallow phase and a cropping phase. This model is prevalent in the humid zone. The total nutrient pool of the fallows include soil nutrients and those locked up in the vegetation. Together these two pools constitute the nutrient capital available for possible use by crops and animals. The role of the fallow phase is to increase this total nutrient capital for the benefit of succeeding crops. The ability of the fallow vegetation to absorb and store nutrients in the "closed cycle of nutrition" is a function of the plant species, their ability to grow and develop extensive root systems and to produce large amounts of biomass. The regrowth vegetation consists of the species best able to build up fertility in the shortest possible time. At the onset of the fallow phase the early plant colonies consist of ephemeral and annual weeds. These are followed by perennial weeds, herbaceous shrub and leguminous trees. A long fallow in a humid climate may result in secondary forest which has the ability to accumulate relatively large amounts of nutrients. However, as the vegetation deteriorates due to short fallows and drier climates, its ability to absorb and store nutrients decreases sharply.

**Table 8.** *Nutrient flows under arable crop model.*

Changes in plant nutrient component	
Supplies	Transfer by net uptake from soil (root and above-ground biomass)
Removals	Transfer by consumption of harvested crops Transfer by plant products remaining on field
Changes in total soil nutrient component	
Supplies	Transfer by application of manure/wastes Transfer by droppings on grazed lands Input by N fixation Input by fertilisers Input by application of litter, sludge and waste Transfer by plants products remaining on the field
Removals	Output by leaching Output by runoff Transfer by net uptake by plants
Changes in available soil nutrient component	
Supplies	Input by fertilisers Transfer by plants products remaining on the field
Removals	Output by leaching Transfer by net uptake by plants

The establishment of woody perennials in fallow lands usually results in an increase in the number of plant roots in the soil. The roots of trees usually penetrate beyond the rooting zones of annual crops and absorb nutrients that were leached into the subsoil during cropping. Such nutrients are immobilised in plant tissues and are eventually recycled to the topsoil through litterfall and mineralisation of leaf and twig litter (Aweto, 1981). In fact, nutrients are usually transferred from the subsoil to the topsoil during the fallow period (Nye and Greenland, 1960). The woody perennials produce much litter which is converted into soil organic matter upon decomposition. Organic matter increases soil cation-exchange capacity and is mineralised to give a very wide range of nutrients, including N, P and S. The improved top soil thus contains greater qualities of total and available nutrients than it did before being left in fallow (Aweto, 1981).

The nutrients that build up in fallow soils are derived from different sources. Nitrogen is of atmospheric origin, having been fixed and incorporated into the soil by nitrogen-fixing micro-organisms. Most other nutrients are derived from the mineralisation of organic matter. Since plants are incapable of synthesising mineral nutrients, the nutrients in organic matter must have been absorbed from the soil by plant roots and later incorporated into plant tissues. Thus, the nutrients that build up in fallow soils are those originally present in the natural ecosystem. Such nutrients are derived mainly from the weathering of rock materials from which the soils are formed. In the final analysis, the extent to which nutrients accumulate in fallow soil would depend on the abundance of minerals in the soil parent material. Nutrients are also derived from atmospheric dust (Kellogg, 1963). In highly weathered soils, reserves of minerals that can be weathered for replenishing soil nutrients are small. Furthermore, since the rate of rock weathering is relatively slow, the chemical decomposition of rock minerals is not likely to make any immediate significant contributions to nutrient accretion in fallow soil. The regeneration of nutrient status under fallow would thus largely depend on recycling nutrients originally present in the soil or those immobilised in the vegetation.

Before clearing, the soil and forest have an efficient nutrient cycle in which most nutrients are stored in the biomass and topsoil, and transferred from one to the other via rainwash, litterfall, root decomposition and plant uptake (Figure 3). Losses from this system are usually negligible. When the closed soil-forest nutrient cycle is destroyed by clearing and burning, a series of detrimental changes affects the properties of the exposed soil and nutrients are rapidly lost from the system. During the dry

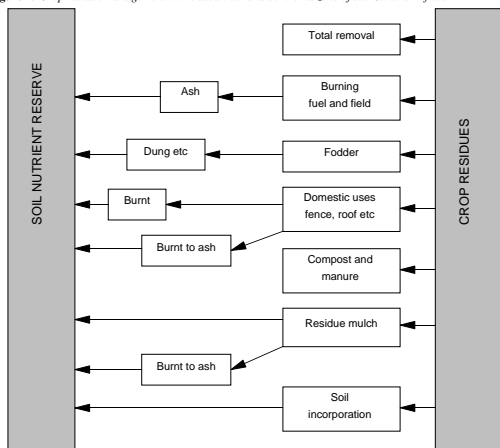
**Figure 2.** Crop residue management in the savannah and semi-arid zone of sub-Saharan Africa.

season some animals graze on fallow land. At times farmers harvest browse plants for their animals. Animals also graze and defecate at the edges of old fallow during the raining season.

Because of the heavy labour requirement and low productivity of the bush-fallow system, farmers have little scope or incentive to cultivate more land than is absolutely necessary to provide sufficient food for the household. Within its obvious constraints, bush fallow is an efficient system but one that is highly dependent on the availability of sufficient amounts of land to ensure adequate restoration of soil fertility through fallows. Although land in general is still abundant in many parts of SSA, this is no longer the case in a number of areas, including south-east Nigeria and many parts of East and southern Africa. The traditional means of increasing production by simply expanding the area under cultivation is rapidly ceasing to be an option. Rapid rates of population growth during recent decades have increased the demand for food and, therefore, the competition for land. In studies on the effect of population pressure on shifting cultivation in eastern Nigeria, Langemann (1977) found that the land-use factor (which is a ratio of the sum of cultivation and fallow periods to the cultivation period) went from 6 to 2, as population rose from 100 to more than 500 people per square kilometre. Moreover, average farm size decreased, and the role of the compound farm increased in terms of its share of total farm area and contribution to the value of farm production.

In general the consequences of increased population pressure have been a decline in the production of perennial crops and more intensive production of food crops, accompanied by a shortening of fallow periods and rapid deforestation. Even where population density is only moderate, the tree component of traditional farming systems has diminished in the humid zone.

Figure 3. Nutrient recycling under forest fallow in West Africa.

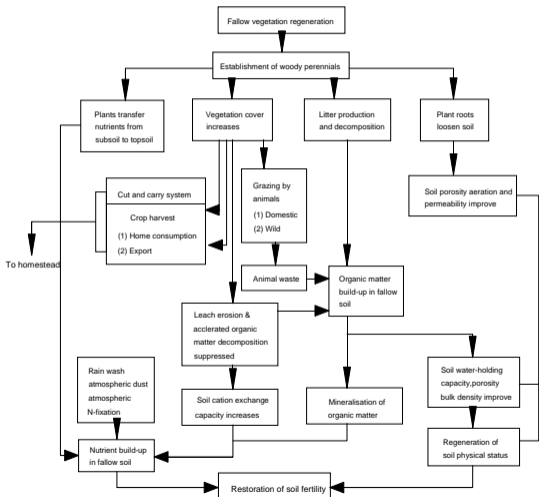

## **Compound farms**

Compound farms are located within the immediate vicinity of the living area of farmers. A wide variety of trees, shrubs and vegetables are grown on land around the compound. The farmer normally makes maximum use of the land and cultivates numerous crop combinations. Animals are reared, but are tied to stakes during the growing season. They are not fully integrated into the farming system, are often fed with left over foods and precautions are taken to keep them off the cultivated areas. Compound farms are intensively managed and it has been reported that they protect the soil better than distant farms; the occurrence of erosion is rare and leaching of nutrient ions is also much reduced. Farmyard manure is recycled to maintain soil fertility under continuous cropping.

Compound farms are common to all areas and are cropped every year. The tree species and the crop types in the forested area are different from those of semi-arid zones. Shrubs and medicinal plants that are needed for daily consumption or frequent use by the farmer and his household may be found within the compound farm. Nutrient removal by the plant and animal pools is minimal in the compound farm model.

## **Mixed farming**

Mixed farming, or the production of both crops and livestock in the same production unit, is practised extensively in the southern and northern Guinea savannah of West Africa. The major animals reared are cattle, sheep and goats, and the crop component includes millet, sorghum, cowpea, groundnut etc. Major losses of nutrients occur through crop removal. Most plant materials remaining in the field are consumed by cattle, sheep and goats, especially during the dry season. Since the fields are extensively grazed, little manure is returned to the field. Fodder banks are being advocated as a promising intervention for mixed farming in the southern and northern Guinea savannah of Nigeria.

In many parts of SSA, free ranging ruminant livestock production is practised especially in the subhumid zone. In this system small and large ruminants graze indigenous pastures during the rainy season and on crop residues during the dry season. Since animals are not intensively managed, the animal stocking rate is not controlled and overgrazing occurs in some locations. This often results in land degradation and pollution of rivers. Furthermore, since nomadic herdsman often set fire to native pastures during the dry season to stimulate regrowth of grasses, large quantities of nutrients especially N and S are lost in the process. Similarly, crop residue grazing results in the removal of organic matter N and P from the cropping system.

## **Nutrient recycling in urban areas**

Significant quantities of nutrients are transferred from rural to urban areas in the form of farm produce. Urban centres can, therefore, be major drains of on-farm nutrients. Nutrient cycling in urban areas is very inefficient. Virtually nothing is recycled except in some compound farms and home gardens in the lower density areas of urban centres where domestic animals such as sheep, goats, donkeys, horses and poultry are kept.

Food such as grains, root and tuber crops, and fruits and forages are brought from farms in semi- and fully processed forms for urban dwellers. Animals that have been raised on farms in rural areas are slaughtered and consumed daily in urban areas.

Major nutrient losses in urban areas are from: human wastes which consist of garbage, night soil, sludge; animal waste such as manure, litter and spoiled fodder, blood, hoofs and horns etc; wastes from forestry and fishery industries; and crop residues such as weeds, sugar-cane trash, water hyacinth etc.

It has been estimated that SSA produces about 28.12 million tonnes of N, 10.25 million tonnes of P and 23.05 million tonnes of K as wastes (Alexandratos, 1988). Whereas the consumption figures for N, P and K for the period 1985/86 was about 6.2 million tonnes (Agboola and Akinnifesi, 1991) this means that only 10% of the nutrients available for recycling are actually recycled. If the potential human and animal waste in the urban areas of SSA were managed more efficiently, there should be

little shortage of nutrients. Figure 4 is an idealised urban waste recycling plant. African urban areas should be encouraged to venture into such nutrient recycling enterprises.

Figure 4. Idealised organic matter recycling for urban areas in sub-Saharan Africa.

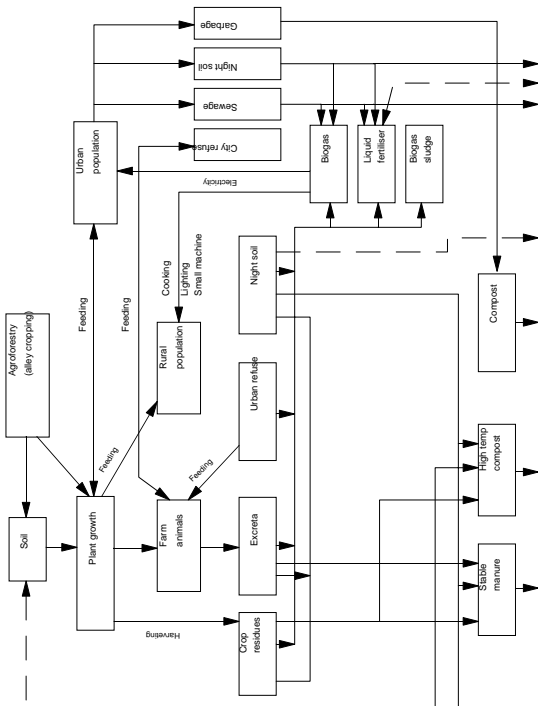

## Conclusions

There is considerable scope to improve the exploitation of crop residues, animal manures and organic wastes from other sources for the maintenance of soil fertility. Research needs to focus on developing practical methods of nutrient recycling on-farm. For the cattle-rich regions, quantitative information is needed on the availability of farmyard manure and on the methods and economics of using it on a large scale in crop production. Presently, compost and farmyard manure are not being used widely and effectively. There are also problems of collection and transport of farmyard manure because of its bulk. Little information is available on the methods and best time to apply organic amendments to soils. The inadequacies of research and extension in providing information to farmers regarding the collection, storage, processing, transportation, utilisation and related economics of organic material recycling are largely due to a lack of sufficient and well-trained personnel to deal with the special needs of organic residue recycling, and lack of extension programmes.

A concerted effort is needed to improve nutrient cycling in rural and urban areas of SSA. Agencies need to popularise the production and use of organic manures and biogas among farming communities. There is a need to develop improved methods of preparing and conserving compost, especially of household refuse and other vegetative wastes. Methods are also needed to enrich compost through the application of lime, superphosphate etc.

Governments throughout SSA should also evaluate the long-term economic benefits of incorporating organic materials in soils to determine whether government policies that promote organic fertiliser use are justified. Furthermore, governments should identify and survey the availability and nutrient composition of different sources of organic materials such as crop residues, animal droppings, urban wastes and/or factory by-products with a view to exploiting these resources to their maximum for agricultural production.

Research should: (i) determine the level of organic matter to be maintained in soils for securing high yields; (ii) evaluate the comparative efficiency of different kinds of organic material on soil health and crop yields; (iii) carry out studies on the recycling of plant nutrients in soils from different sources of organic materials, especially in connection with the balance of N and P; and (iv) characterise humus dynamics in the course of transformation of crop residues, green manuring, cattle manure and of products from urban wastes during the growing season. In the short term, studies should be carried out on the compatibility of different wastes on different soils and the management of crop residues without burning. Expert consultation on the current status of nutrient recycling in sub-Saharan Africa should be organised by international organisations such as the FAO.

## Acknowledgements

We gratefully acknowledge the useful contributions of M Jabbar, J Smith and A Larbi of ILCA (International Livestock Centre for Africa), Humid Zone Programme, Ibadan, Nigeria.

## References

- Agboola A A and Akinfesi P K. 1991. Soil fertility management for the humid tropics of Africa. In: *Soil and water management for sustainable productivity*. 2nd African Soil Science Society Conference Proceedings. Cairo, Egypt. pp. 107–126.
- Alexandratos N (ed). 1988. *World agriculture: Toward 2000*. An FAO study. FAO (Food and Agriculture Organization of the United Nations), Rome, Italy.
- Aweto A O. 1981. Following and soil fertility restoration in southwestern Nigeria. *The Malaysian Journal of Tropical Geography* 3:1–7.
- Bourn D and Milligan K. 1983. *The dynamics of cattle distribution in the Nigerian subhumid zone*. Report of ILCA's Subhumid Programme. ILCA (International Livestock Centre for Africa), Kaduna, Nigeria.
- Kellogg C E. 1963. Shifting cultivation. *Soil Science* 95:221–230



- Langemann J. 1977. *Traditional African farming systems in eastern Nigeria*. Weltforum Verlag, Munich, West Germany.
- Mohamed-Saleem M A. 1986. The establishment and management of fodder banks. In: von Kaufmann R, Chater S and Blench R (eds), *Livestock systems research in Nigeria's subhumid zone*. Proceedings of the Second ILCA/NAPRI Symposium held in Kaduna, Nigeria, 29 October – 2 November 1984. ILCA (International Livestock Centre for Africa), Addis Ababa, Ethiopia. pp. 326–350.
- Nye P H and Greenland D J. 1960. *The soil under shifting cultivation*. Technical Communication 51. Commonwealth Bureau of Soils, Harpenden, UK. 156 pp.
- Pierre C J M G. 1992. *Fertility of soils. A future for farming in the West African savannah*. Springer Verlag, Berlin, Germany. 348 pp.
- Powell J M and Mohamed-Saleem M A. 1987. Nitrogen and phosphorus transfers in a crop livestock system in West Africa. *Agricultural Systems* 25:261–277
- Stangel J P. 1991. Plant nutrients in a sustainable land management system. In: Dumanski J, Pushparajah E, Latham M, Myers R and Elliot C R (eds), *Evaluation for sustainable land management in the developing world*. IBSRAM proceedings 12. Vol. II. IBSRAM (International Board for Soil Research and Management), Bangkok, Thailand. pp. 327–355.
- Watson K A and Goldsworthy P R. 1964. Soil fertility investigation in the middle belt of Nigeria. *Empirical Journal of Experimental Agriculture* 32:290–302
- Wong M T F. 1991. Effect of leaching on the fertility status of an Ultisol in South eastern Nigeria. In: *Soil and water management for sustainable productivity*. 2nd African Soil Science Society Conference Proceedings. Cairo, Egypt. pp. 101–105.

# The role of forage legume fallows in supplying improved feed and recycling nitrogen in subhumid Nigeria

G. Tarawali<sup>1</sup> and M.A. Mohamed-Saleem<sup>2</sup>

1. International Livestock Centre for Africa (ILCA), PMB 2248, Kaduna, Nigeria

2. International Livestock Centre for Africa (ILCA), P O Box 5689, Addis Ababa, Ethiopia

## Abstract

Sub-Saharan Africa is experiencing substantial land degradation and declining soil fertility. This has led to decreasing total agricultural productivity. Introducing forage legume rotations into crop-livestock systems can stabilise agricultural productivity. In addition to providing high-quality forage for animals, legumes can improve soil characteristics for crop production. Research conducted to test the impact of forage legumes on livestock productivity in the subhumid zone of Nigeria showed that cattle grazing *Stylosanthes*-based pastures in the dry season produced more milk, lost less weight, had shorter calving intervals and there was greater calf survival when compared with natural pastures. Leguminous pasture grazing by goats significantly reduced weight losses in the wet season. Both observations were attributed to the greater nutritive value of the forage legume relative to the natural pasture. The nitrogen (N) recycled by legume leys to subsequent crops was assessed in bioassays. Results showed that N supplied by *Stylosanthes* to subsequent crops varied from 30–80 kg N/ha. Grain yields from areas preceded by the legume were always higher and in some cases were double those from natural pasture. The superior performance of crops following *Stylosanthes* was associated with improvement in soil physical and chemical properties caused by the legume. The incorporation of forage legumes into cropping systems shows great potential for the maintenance of sustainable farming systems.

## Rôle des jachères de légumineuses fourragères dans l'alimentation du bétail et le recyclage de l'azote dans la zone subhumide du Nigéria

G. Tarawali<sup>1</sup> et M.A. Mohamed-Saleem<sup>2</sup>

1. Centre international pour l'élevage en Afrique (CIPEA), P.M.B. 2248, Kaduna (Nigéria)

2. Centre international pour l'élevage en Afrique (CIPEA), P.O. Box 5689, Addis-Abeba (Ethiopie)

## Résumé

En Afrique subsaharienne, les terres se dégradent rapidement et la fertilité des sols diminue, ce qui se traduit par une forte baisse de la productivité agricole totale. L'introduction de rotations à légumineuses fourragères dans les systèmes mixtes agriculture-élevage peut permettre de stabiliser la productivité agricole. Non seulement les légumineuses pourront fournir du fourrage de qualité pour l'alimentation des animaux, mais également ils peuvent améliorer les caractéristiques des sols pour la production agricole. Il ressort de recherches effectuées sur l'effet des légumineuses fourragères sur la productivité du bétail dans la zone subhumide du Nigéria, que les bovins élevés en saison sèche sur des pâturages à base de *Stylosanthes* produisaient plus de lait, perdaient moins de poids, avaient un intervalle plus court et un taux de survie des veaux plus élevé par rapport à ceux élevés sur parcours naturels. Par ailleurs, les pertes de poids étaient réduites chez les caprins élevés sur pâturages de légumineuses au cours de la saison des pluies. Ces résultats sont attribués à la valeur nutritive plus élevée des légumineuses fourragères par rapport aux pâturages naturels. Le recyclage de l'azote par les légumineuses en vue des cultures suivantes a été évalué. Il ressort des résultats que la quantité d'azote recyclé par *Stylosanthes* variait entre 30 et 80 kg de N/ha. Les rendements en grains

*des cultures précédées par les légumineuses étaient toujours plus élevés, parfois même doubles, de ceux obtenus sur pâturages naturels. Les rendements plus élevés des cultures après Stylosanthes sont la conséquence de l'amélioration des propriétés physiques et chimiques du sol due aux légumineuses. L'intégration de légumineuses fourragères dans les systèmes culturaux offre d'intéressantes perspectives en ce qui concerne la durabilité des systèmes de production agricole.*

## Introduction

Sub-Saharan Africa is experiencing substantial land degradation and declining soil fertility leading to decreasing total agricultural productivity (Okigbo, 1985; Lal, 1989). Inherently less fertile soils are increasing due to land pressure resulting from rapid population growth. Traditional grazing lands are acquired for arable cultivation and long fallow periods, crucial for soil fertility regeneration have become unfeasible (Ruthenberg, 1980; Gichuru, 1991). Recycling of materials through grazing and crops etc could contribute to soil amelioration if suitable techniques are developed.

The subhumid zone (SHZ) of Nigeria is characterised by 1000 to 1500 mm rainfall and a crop growing period of 180 to 270 days (ILCA, 1979). The low protein content of the natural pasture and crop residue in this zone is a serious constraint to livestock nutrition for up to six months of the year (ILCA, 1979; Mohamed-Saleem, 1986). Animals lose weight, milk production is low, calf mortality is high and conception rates are low (Otchere, 1986; Ockerman and Agboola, 1991). Poor soil fertility limits pasture productivity, quality and crop yields (Jones and Wild, 1975). The integration of grain and forage legumes into cropping systems is considered a promising option for developing economically viable agricultural systems (McCown et al, 1986; Buresh et al, 1993; Mohamed-Saleem and Fisher, 1993). By fixing nitrogen (N), legumes can enhance soil fertility, boost subsequent crop yields (Mohamed-Saleem, 1986; MacColl, 1990; Tarawali, 1991) and provide high quality feed for livestock (Tohill, 1986; Otsyina et al, 1987; Tripathi and Gill, 1991; Kouamé et al, 1992). Legumes also increase soil organic matter, cation exchange capacity (CEC), soil water-holding capacity, microbial activity, and reduce soil surface temperature, disease and pests and manual labour requirement for tilling the soil after growing the legume (Vallis and Gardener, 1984; Mohamed-Saleem et al, 1986; Mulongoy and Kang, 1986; Tarawali et al, 1987).

This paper reviews 10 years of research conducted by the International Livestock Centre for Africa (ILCA) in the subhumid zone of Nigeria with respect to quantifying the benefits of legume (ley) fallows to livestock production; the contribution of grazed legume leys to soil N supply for subsequent crops; the changes in soil physical and chemical properties associated with legume leys; and feasible methods of integrating forage legumes into cropping systems.

## Benefits of legume (ley) fallows to livestock production

### Large ruminants

On-farm trials with agropastoral herds demonstrated that cattle with access to *Stylosanthes* fallow in the dry season produced more milk, lost less weight, had shorter calving intervals and better calf survival (Table 1; Bayer, 1986) than those in the non-supplemented herds. The average forage production of the 4-ha leguminous fallows recorded at the beginning of the dry season (before grazing) ranged from 4700–6800 kg DM/ha of which about 62% was stylo (Mohamed-Saleem et al, 1986).

### Small ruminants

Feed shortages for goats occur during the wet season in intensively cultivated areas of the subhumid zone. Goats grazing *Stylosanthes* fallows showed reduced ( $P<0.05$ ) weight losses of non-pregnant does compared with those on natural pasture (Figure 1). The kids' survival also improved ( $P<0.05$ ) due to legume supplementation (Ikwegbu and Ofodile, 1992). During grazing in August (mid-wet season), the legume fallows had produced an average of  $2.6\pm 0.1$  t/ha dry matter while the natural

vegetation produced  $2.4 \pm 0.3$  t/ha dry matter. The leguminous pasture had 30–50% stylo and 40–60% grasses while the rest were forbs. The legume component of this pasture was fairly good (Otsyina et al, 1987) but grasses tend to dominate in leguminous pastures after three years if not well managed. The better animal performance in legume pasture was attributed to the higher quality (in terms of crude protein) of the *Stylosanthes fallows* (about 12% crude protein, CP) compared to the natural pasture (about 5% CP) at the beginning of the dry season (Tohill, 1986).

**Table 1.** Effect of *Stylosanthes* supplementation on cow and calf survival, calf weight at one year, milk yield per lactation and productivity index per year.

	Non-supplemented	Supplemented
Cow survival (%)	92.2	96.0
Cows calving (%)	53.8	58.1
Calf survival (%)	71.8	86.3
Calf weight at one year (kg)	98.1	103.4
Lactation, milked out-yield (kg)	300.2	312.5
Productivity index <sup>1</sup>	51.5	69.1

1. Productivity index as calculated by Trail and Gregory (1981).

Source: Tarawali and Pamo (1992).

**Figure 1.** Liveweight changes of West African Dwarf goats grazing *Stylosanthes* and natural fallows during the wet season in central Nigeria.

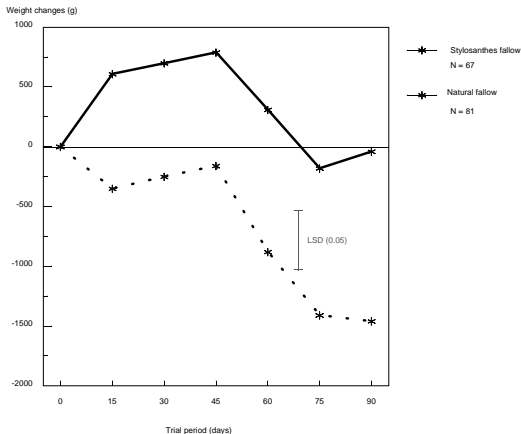

Source: Ikwuegbu and Ofodile (1992).

## Contribution of grazed legume leys to the soil nitrogen supply for subsequent crops

The main factor limiting crop production in the African savannahs is low soil nitrogen (N) (Nnadi and Arora, 1985). Legume leys can reduce this deficiency by the N released or recycled from the residue and the N of the manure from the animals that feed on them (MacColl, 1990).

To quantify the N recycled by legume leys to subsequent crops, a bioassay technique was adopted which involved applying various levels of N fertiliser to the cereal crops grown in areas previously fallowed with *Stylosanthes* or native pasture. The test crops were maize (*Zea mays*), sorghum (*Sorghum bicolor*), millet (*Pennisetum typhoides*), acha (*Digitaria exilis*) and soya bean (*Glycine max*), all of which are extensively grown in the SHZ (Powell, 1984; Okigbo, 1985; Jansen, 1993) for grain, leaving stovers for dry season livestock feed (Bayer and Waters-Bayer, 1989).

### Maize

Earlier evaluations in central Nigeria on the effect of length of fallow period on maize grain yield showed that the N contribution of *Stylosanthes* pasture to a succeeding maize crop varied (Table 2), depending on the species and the length of time the land had been under the legume. For instance, three years fallow of *S. guianensis* provided 80 kg/ha more N and produced 1400 kg/ha more grain than the natural fallow. Areas planted with *S. hamata* cv Verano for three years contributed 60 kg N/ha more than the natural fallow.

**Table 2.** Contribution of stylo-N to succeeding maize yields.

Previous land use	Maize grain yield (kg/ha)	N-contribution <sup>1</sup> (kg/ha)
Cropped 3 years	460	—
Fallow	1270	30
<i>S. hamata</i> , 2 years	1330	32
<i>S. hamata</i> , 3 years	2510	90
<i>S. guianensis</i> , 1 year	1640	44
<i>S. guianensis</i> , 2 years	2700	110

1. The amount of N required by the three-year cropped area to attain similar maize grain yields as those obtained by the other land uses.

Source: Mohamed-Saleem and Otsyina (1986).

Subsequently, similar bioassays were extended to other locations to quantify N benefits from legume fallows on different soil types and lengths of growing period. Maize grain yields planted after *Stylosanthes* fallows were greater than yields on natural fallow at each level of applied N (Figure 2). Without fertiliser N additions, the average grain yields were 1700 kg/ha in the legume fallow and 800 kg/ha in the natural fallow. In the first year of cropping 45 kg N/ha had to be applied to maize grown in the natural fallow to produce the same grain yield as unfertilised maize following a good *Stylosanthes* pasture (Figure 2). In the second year of cropping the yields were much lower but the proportional increase in yield due to *Stylosanthes* was similar to that in the first year. This suggests that there was still some positive residual effects of the legumes but it was insufficient for the optimum growth of maize.

**Figure 2.** First year and one year residual effects of nitrogen on grain yield of maize inside and outside fodder banks, 1986/87.

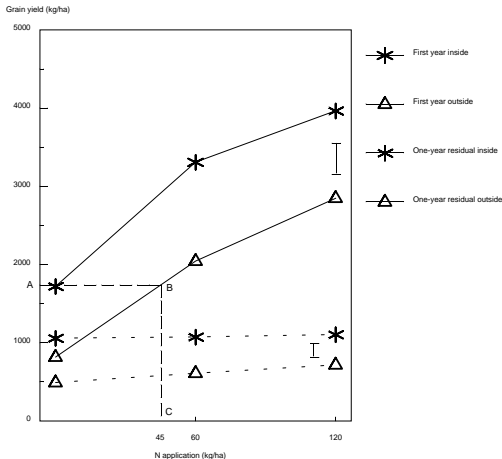

Source: Tarawali (1991).

Further application of legume fallows through the Nigerian extension service ascertained that maize grown outside *Stylosanthes hamata* pastures was chlorotic and stunted, especially in the plots not treated with N (Adeoye, 1989). At similar fertiliser rates, maize grain yields were greater inside (1809 kg/ha) than outside (1260 kg/ha) the legume fallows. The N-free plots inside the improved fallow produced higher grain yields (849 kg/ha) than those that received 30 kg N/ha (677 kg/ha) on the natural fallow. This suggests that the legume must have supplied at least a minimum of 30 kg N/ha to the maize crop.

In most of the above studies the benefits of the legume to subsequent crops was a function of the legume in the fallow. As N accrues in the soil, grass invades the legume plots (Mohamed Saleem and Otsyina, 1986; Tarawali, 1991). A four-year investigation (1985–1989) was conducted to determine the effect of grass infestation on N supplied by a three-year old *Stylosanthes* pasture. Plots with no or minimum grass infestation (<25% of total DM) contributed the equivalent of about 40–50 kg/ha N to the maize crop (Table 3). As the grass density increased to 75% of total DM the N contribution declined to about 30 kg/ha. These findings compared favourably with estimated N accruals from other multi-locational on-farm trials in Nigeria reported by Tarawali (1991; Figure 2), and elsewhere by McCown et al (1986).

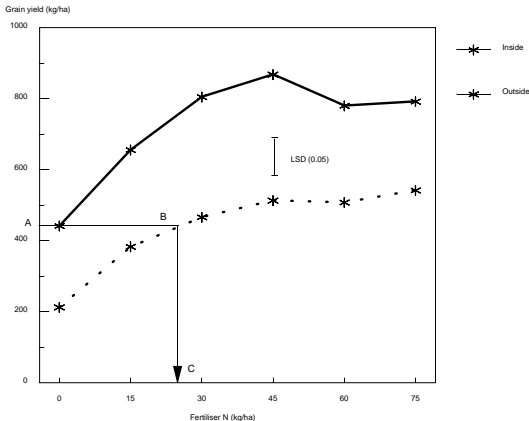
**Figure 3.** Response of millet to fertiliser-N inside and outside *Stylosanthes* fallows at four locations in central Nigeria, 1990.

Source: (ILCA, 1991).

**Table 3.** Effect of grass density in *Stylosanthes* pasture on nitrogen contribution to succeeding maize crop.

Grass density (% of total DM)	N-contribution (kg/ha)	Grain yield of maize (kg/ha)
0	45.6a	1387a
25	39.2ab	1058b
50	32.3bc	775bc
75	28.6c	661c
100	9.7d	220d

Within columns, means followed by the same letter do not differ significantly ( $P < 0.05$ ).

Source: Tarawali and Mohamed-Saleem (1994).

## Millet

A study was conducted whereby millet seedlings were sown in the nursery for six weeks and then transplanted into *Stylosanthes* fallows of at least three years old. Millet yields in four locations were greater in the improved fallow than in the natural pasture. Millet yield was 420 kg/ha without applying fertiliser N from the leguminous area (Figure 3). Averaged across all sites, approximately 20 to 30

**Figure 4.** Second year and one year residual effects of N on grain yield of millet inside and outside *Stylosanthes* fallows, 1991.

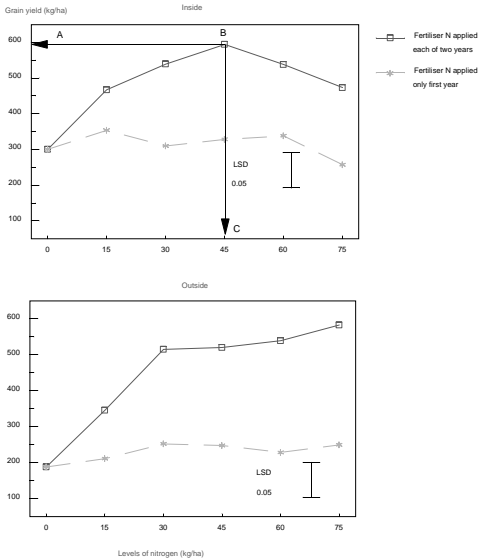

Source: Tarawali (unpublished data).

kg/ha of fertiliser N had to be applied to millet grown outside leguminous fodder banks to raise its yield to that of millet planted on unfertilised plots inside the stylo pasture (Figure 3). Maximum millet yield in both leguminous and natural pastures was achieved at 45 kg N/ha.

In the following year (1991), each of the experimental plots were split into two; fertiliser N was applied on one half only. As in the previous year, the millet yield within the *Stylosanthes* fallow was greater than yield on natural fallow (Figure 4). There was a great difference in grain yield between millet plots that received additional N fertilisation in 1991 and those that only received N in 1990 (Figure 3). About 45 kg N/ha was required to obtain maximum yields from the *Stylosanthes* pasture in the second year. This suggests that fertiliser N is necessary in the second year to produce a good millet crop within *Stylosanthes hamata* cv Verano fallow. About 30–60 kg N/ha were required to

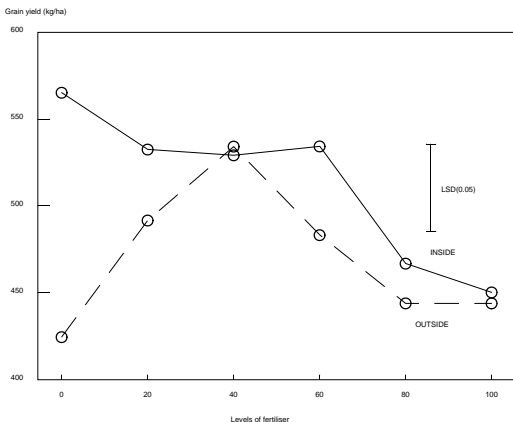

**Figure 5.** Response of *acha* inside and outside *Stylosanthes fallows* in central Nigeria, 1987.

Source: Tarawali and Pamo (1992).

sustain yields on natural fallow. Mohamed and Clegg (1993) reported pearl millet grain yield increases of 730 (1st year) and 1480 (2nd year) kg/ha when grown after soya bean, a yield increase equivalent to that with 45 kg/ha of applied N.

### **Acha**

*Acha* is an important staple grain, localised to the plateau area in the middle belt of Nigeria. It is grown in rotation with the more nutrient demanding cereals. *Acha* did not respond to supplementary fertiliser N when grown after the *Stylosanthes* fallow. The highest *acha* grain yield (560 kg/ha) was obtained inside the improved fallow with no N application whereas about 40 kg N/ha was required on plots after natural fallow (Figure 5). This shows that maximum *acha* yield could be obtained if planted after a stylo fallow with no N fertiliser. A decline in *acha* grain yield with fertiliser N indicated that stylo provided enough N to attain maximum yields; any other fertiliser N addition caused yield to decrease.

Intercropping is the most common farming system in northern Nigeria since it reduces the risk of crop failure, maximises production per unit land area and labour utilisation (Okigbo and Greenland, 1976). Three main crops (maize, sorghum and soya bean) were tested inside and outside *Stylosanthes* fallow in various combinations at different levels of nitrogen.

Intercrops sown after the legume fallow outyielded those on the natural fallow (Figure 6). Maize depressed soya bean growth far more than sorghum indicating that soya bean/sorghum is a more

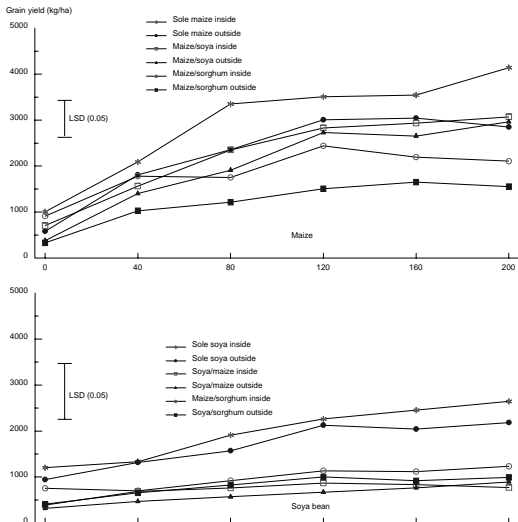
**Figure 6.** Grain yield of mono and mixed crops grown inside and outside *Stylosanthes fallows*, 1988.

Source: ILCA (1989).

compatible mixture for intercropping. In the maize/sorghum combination, the individual crop yield was reduced, mainly due to a reduction in total plant population and competition between the two plant types. This effect was, however moderate in the crops planted inside the *Stylosanthes fallows*. Maize was the most responsive crop to the previous legume fallow.

In 1989, the experimental plots were split into two parts. The amount of fertiliser applied in 1988 was again applied to one half of each plot; the other half received no nitrogen. Results from fertilised plots were similar to those obtained in 1988. Crops planted within the *Stylosanthes fallow* produced higher grain yields than those sown on the natural fallow (Figure 7). Yield on unfertilised plots were low, and there was no evidence of a residual effect on the N applied in 1988. However, plants inside fodder banks again yielded more than those outside. The poor yields of the crops that received no fertiliser in 1989 emphasised the need to apply some nitrogenous fertiliser into all soils during each cropping season. However, less fertiliser needs to be applied to soils that have been under stylo (60 kg N/ha compared to 120 kg N/ha recommended for maize).

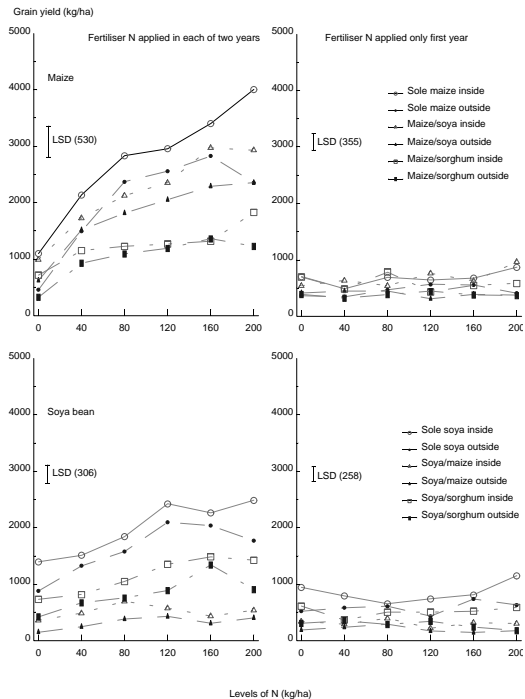
**Figure 7.** Second year residual effects of nitrogen on crop yields, 1989.

## Changes in soil physical and chemical properties associated with legume fallows

The higher crop yields in the *Stylosanthes* fallow were probably due to the positive effects of the forage legume on soil properties. For instance, results of a series of soil measurements showed that *Stylosanthes* fallows improve soil bulk density, soil moisture retention capacity, CEC, organic carbon and soil N (Table 4). The fact that crop yields within the improved fallow are greater than those outside even at very high levels of N, confirmed that the *Stylosanthes* fallow contribute more than just N to succeeding crops. An improvement in soil physical properties could be the additional contribution of legume to subsequent cereal crops.

**Table 4.** Soil physical and chemical properties of legume and natural fallows in central Nigeria.

Property	Three years <i>Stylosanthes</i> fallow	>3 years natural fallow
N content (g/kg)	1.14	0.87
CEC (cmol/kg)	3.24	2.22
Organic carbon (g/kg)	4.31	2.70
Bulk density	1.51	1.66
Total porosity (%)	43.1	37.4
Macro-porosity (%)	42.1	36.4
Micro-organisms (No/g)	34 X 10 <sup>7</sup>	12 X 10 <sup>7</sup>

Source: Tarawali and Ikwuegbu (1993).

## Methods of integrating forage legumes into cropping systems

Inclusion of a legume into cereal/fallow rotations can lead to more sustainable agricultural systems. Among the methods developed, the undersowing technique has been the most widely used in establishing legume leys in crop rotations (Mohamed-Saleem and Otsyina, 1986). In 4-ha *Stylosanthes* fallows established by agropastoralists for the dry season diet supplementation of cattle it is recommended that 3 ha of the area be used for forage production and the remaining 1 ha planted with a responsive cereal such as maize. In this way, maize would be rotated into a three-year stylo fallow each year. In a cereal-based enterprise where continuous cropping is practised, it is recommended that a portion of the land (0.1 ha of the usual 2–3 ha used for farming) be devoted to improved forage production and the rest for crop production.

## Conclusions

Integration of forage legumes into cropping and fallow systems is considered an attractive option for arresting environmental degradation which is a pre-requisite for sustainable food production. The N contribution of forage legumes to subsequent crops varies from 30–80 kg/ha. Legume fallows also improve soil chemical, physical and biological properties. Since maize appeared to be the most responsive to accrued legume N, it is recommended that this crop is used as the first crop after *Stylosanthes* fallow in crop rotations. In the second cropping season, a less responsive cereal such as sorghum, millet or *acha* is suggested. Such recommendations need to be confirmed through on-farm trials. Some of the problems in introducing legume ley technology into cropping systems included:

1. The technology requires fencing for efficient pasture management but the cost is too high for some farmers; local and cheaper materials are proposed by scientists.

2. In intensively cultivated areas, farmers could not leave land on fallow for even a year. Doubling of yield in some of the crops should encourage fallowing and identification of more productive legumes with high biological nitrogen fixing capacity and other cropping practices (intercropping, sequential cropping etc.) should minimise the fallow period.
3. Competition between the desired legume, nitrophilous grasses and associated crops tends to reduce benefits. Future research needs to quantify nutrient losses from these legume–livestock–crop systems via crops, weeds, soil erosion and other pathways. Additionally, techniques for safely introducing legumes into crops so as to optimise the performance of subsequent fallows in promoting livestock and crop production need to be sought.
4. Legumes which are susceptible to diseases and are potential hosts to diseases could pose problems in the farming system. Future studies should include the identification of adaptable and disease resistant materials at the farm level. Also, the contribution of forage legumes to pest and disease control to boost total farm productivity should be of interest to farmers and scientists.

Understanding the biological processes involved in these crop–livestock production systems should facilitate appropriate management practices that will allow the benefits/advantages of nutrient cycling to be better exploited.

## References

- Adeoye K B. 1989. *Adoption of rotational cropping within fodder banks in Nigeria*. Research report submitted to Nigerian National Livestock Projects Department (NLPD) and ILCA (unpublished). 10 pp.
- Bayer W. 1986. Utilization of fodder banks. In: von Kaufmann R, Chater S and Blench R (eds), *Livestock systems research in Nigeria's subhumid zone*. Proceedings of the Second ILCA/NAPRI Symposium held in Kaduna, Nigeria, 29 October–2 November 1984. ILCA (International Livestock Centre for Africa), Addis Ababa, Ethiopia. pp. 351–364.
- Bayer W and Waters-Bayer A. 1989. Adapting tropical pasture research to the production system: From Australian ranching to African pastoralism. *Experimental Agriculture* 25:277–289.
- Buresh R J, Garish D P, Castillo E G and Chua T T. 1993. Fallow and *Sesbania* effect on response of transplanted lowland rice to urea. *Agronomy Journal* 85:801–808.
- Gichuru M P. 1991. Residual effects of natural bush, *Cajanus cajan* and *Tephrosia candida* on the productivity of an acid soil in southeastern Nigeria. *Plant and Soil* 134:31–36.
- Ikwuegbu O A and Ofofiele S. 1992. Wet season supplementation of West African Dwarf goats raised under traditional management in the subhumid zone of Nigeria. In: Ayeni A O and Bosman H G (eds), *Goat production systems in the humid tropics*. Proceedings of an international workshop, Ile-Ife, Nigeria, July 1992. pp. 195–201.
- ILCA (International Livestock Centre for Africa). 1979. *Livestock production in the subhumid zone of West Africa: A regional review*. ILCA Systems Study 2. ILCA, Addis Ababa, Ethiopia. 184 pp.
- ILCA (International Livestock Centre for Africa). 1989. *ILCA Annual Report 1988*. ILCA, Addis Ababa, Ethiopia. 156 pp.
- ILCA (International Livestock Centre for Africa). 1990. *ILCA Annual Report 1989*. ILCA, Addis Ababa, Ethiopia. 144 pp.
- ILCA (International Livestock Centre for Africa). 1991. *ILCA Annual Report 1990*. ILCA, Addis Ababa, Ethiopia. 207 pp.
- Jansen H G P. 1993. Ex-ante profitability of animal traction investments in semi-arid sub-Saharan Africa: Evidence from Niger and Nigeria. *Agricultural Systems* 43:323–349.
- Jones M J and Wild A. 1975. Soils of the West African Savanna. *The maintenance of their fertility*. Technical Communication 55. CABI (Commonwealth Agriculture Bureau International), Harpenden, UK. 87 pp.
- Kouamé C, Hoefs S, Powell J M, Roxas D and Renard C. 1992. Intercropped *Stylosanthes* effects on millet yields and animal performance in the Sahel. In: Stares J E S, Said A N and Kategile J A (eds), *The complementarity*

- of feed resources for animal production in Africa. Proceedings of the joint feed resources networks workshop held in Gaborone, Botswana, 4–8 March 1991. African Feeds Research Network. ILCA (International Livestock Centre for Africa), Addis Ababa, Ethiopia. pp. 137–146.
- Lal R. 1989. Agroforestry systems and soil surface management of a tropical Alfisols. III. Changes in soil chemical properties. *Agroforestry Systems* 8:113–132.
- MacColl D. 1990. Studies on maize (*Zea mays*) at Bunda, Malawi. III. Yield in rotation with pasture legumes. *Experimental Agriculture* 26:263–271.
- McCown R L, Winter W H, Andrew M H, Jones R K and the late Peake D C I. 1986. A preliminary evaluation of legume ley farming in the Australian semi-arid tropics. In: Haque I, Jutzi S and Neate P J H (eds), *Potentials of forage legumes in farming systems of sub-Saharan Africa*. Proceedings of a workshop held at ILCA, Addis Ababa, Ethiopia. ILCA (International Livestock Centre for Africa), Addis Ababa, Ethiopia. pp. 397–419.
- Mohammed M S and Clegg M D. 1993. Pearl millet-soybean rotation and nitrogen fertilizer effects on millet productivity. *Agronomy Journal* 85:1009–1013.
- Mohamed-Saleem M A. 1986. The ecology, vegetation and land use of Subhumid Nigeria. In: von Kaufmann R, Chater S and Blench R (eds), *Livestock systems research in Nigeria's subhumid zone*. Proceedings of the Second ILCA/NAPRI Symposium held in Kaduna, Nigeria, 29 October–2 November 1984. ILCA (International Livestock Centre for Africa), Addis Ababa, Ethiopia. pp. 59–84.
- Mohamed-Saleem M A and Fisher M J. 1993. Role of ley farming in crop rotations in the tropics. In: *Proceedings of the XVII International Grassland Congress held in Rockhampton, Australia, 18–21 February 1993*. Vol. III. New Zealand Grassland Association, New Zealand. pp. 2179–2187.
- Mohamed-Saleem M A and Otsyina R M. 1986. Grain yields of maize and the nitrogen contribution following *Stylosanthes* pastures in the Nigerian subhumid zone. *Experimental Agriculture* 22:207–214.
- Mohamed-Saleem M A, Suleiman H and Otsyina R M. 1986. Fodder banks: For pastoralists or farmers. In: Haque I, Jutzi S and Neate P J H (eds), *Potentials of forage legumes in farming systems of sub-Saharan Africa*. Proceedings of a workshop held at ILCA, Addis Ababa, Ethiopia, 16–19 September 1985. ILCA (International Livestock Centre for Africa), Addis Ababa, Ethiopia. pp. 420–437.
- Mulongoy K and Kang B T. 1986. The role and potential of forage legumes in alley cropping, live mulch and rotation systems in humid and subhumid tropical Africa. In: Haque I, Jutzi S and Neate P J H (eds), *Potentials of forage legumes in farming systems of sub-Saharan Africa*. Proceedings of a workshop held at ILCA, Addis Ababa, Ethiopia, 16–19 September 1985. ILCA (International Livestock Centre for Africa), Addis Ababa, Ethiopia. pp. 212–231.
- Nnadi L A and Arora Y. 1985. Effect of nitrogen sources and soil properties on crop yield in the savanna. In: Kang B T and van der Heide J (eds), *Nitrogen management in farming systems in humid and subhumid tropics*. Institute for Soil Fertility (I. B.) and IITA (International Institute of Tropical Agriculture), Haren (G.R.), The Netherlands. pp. 223–233.
- Ockerman H W and Agboola H A. 1991. A review of Nigerian livestock production with a particular reference to the meat processing and utilization common among the Yorubas of south-western states. *World Review of Animal Production* 26(2):69–79.
- Okigbo B N. 1985. Land use and productive potentials of African savannas. In: Tothill J C and Mott J J (eds), *Ecology and management of the world's savannas*. Australian Academy of Science, Canberra, Australia/CAB (Commonwealth Agricultural Bureaux), Farnham Royal, Bucks, UK. pp. 95–106.
- Okigbo B N and Greenland D J. 1976. Intercropping systems in tropical Africa. In: Papendick R I, Sanchez P A and Triplett G B (eds), *Multiple cropping*. American Society of Agronomy, Wisconsin, USA. pp. 63–101.
- Otchere E O. 1986. Traditional cattle production in the subhumid zone of Nigeria. In: von Kaufmann R, Chater S and Blench R (eds), *Livestock systems research in Nigeria's subhumid zone*. Proceedings of the Second ILCA/NAPRI Symposium held in Kaduna, Nigeria, 29 October–2 November 1984. ILCA (International Livestock Centre for Africa), Addis Ababa, Ethiopia. pp. 110–140.
- Otsyina R M, von Kaufmann R, Mohamed-Saleem M A and Suleiman H. 1987. *Manual on fodder bank establishment and management*. ILCA (International Livestock Centre for Africa), Addis Ababa, Ethiopia. 27 pp.

- Powell J M 1984. Assessment of dry matter yield from grain yield in the West African Savanna Zone. *Journal of Agricultural Science (Cambridge)* 103:695–698.
- Ruthenberg H. 1980. Farming systems in the tropics. Third edition. Oxford University Press, London, UK. 424 pp.
- Tarawali G. 1991. Residual effect of *Stylosanthes* fodder banks on grain yield of maize. *Tropical Grasslands* 25:26–31.
- Tarawali G and Ikwuegbu O A. 1993. *The potential of forage legumes in soil management for sustainable livestock and crop production in the subhumid zone of central Nigeria*. Paper presented at the Third Wye International Conference on Sustainable Agriculture held at Wye College, UK, 31 August–4 September 1993. 20 pp.
- Tarawali G and Mohamed-Saleem M A. 1994. Effect of grass density on productivity and crude protein concentration of *Stylosanthes*, soil nitrogen and grain yield of subsequent crops. *Tropical Grasslands* (under review).
- Tarawali G and Pamo E T. 1992. A case for on-farm trials of fodder banks on the Adamawa plateau in Cameroon. *Experimental Agriculture* 28:229–235.
- Tarawali G, Mohamed-Saleem M A and von Kaufmann R. 1987. Comparison of labour requirements for cropping maize on land previously used for *Stylosanthes* fodder banks and on adjacent fallows in the sub-humid zone of Nigeria. *ILCA Bulletin* 26:36–39. ILCA (International Livestock Centre for Africa), Addis Ababa, Ethiopia.
- Tohill J C. 1986. The role of legumes in farming systems of sub-Saharan Africa. In: Haque I, Jutzi S and Neate P J H (eds), *Potentials of forage legumes in farming systems of sub-Saharan Africa*. Proceedings of a workshop held at ILCA, Addis Ababa, Ethiopia, 16–19 September 1985. ILCA (International Livestock Centre for Africa), Addis Ababa, Ethiopia. pp. 162–185.
- Trail J C M and Gregory K E. 1981. *Sahiwal cattle. An evaluation of their potential contribution to milk and beef production in Africa*. ILCA Monograph 3. ILCA (International Livestock Centre for Africa), Addis Ababa, Ethiopia. 128 pp.
- Tripathi S N and Gill A S. 1991. Inter-cropping of oats with forage legumes. *Indian Journal of Agricultural Research* 25:227–230.
- Vallis I and Gardener C J. 1984. Nitrogen inputs into agricultural systems by *Stylosanthes*. In: Stace H M and Edye L A (eds), *The biology and agronomy of Stylosanthes*. Academic Press, Australia. pp. 359–380.

# The benefits of forage legumes for livestock production and nutrient cycling in pasture and agropastoral systems of acid-soil savannahs of Latin America

R.J. Thomas and C.E. Lascano

Centro Internacional de Agricultura Tropical (CIAT), Apartado Aereo 6713, Cali, Colombia

## Abstract

Agricultural production must increase to match population growth in Latin America. However, the region is already witnessing a decline in productivity due to soil loss, compaction, overgrazing and inappropriate cropping systems. The vast savannah areas of infertile acid soils offer some hope for sustainable increases in agricultural production. Animal liveweight gains have doubled per head and increased tenfold per hectare with improved grass/legume pastures when compared with managed native savannahs. Similarly, milk production and calving performances can be improved with legumes. Grass/legume pastures combined with acid-soil tolerant upland rice are examples of input-efficient sustainable systems. Inputs of N from different forage legumes via biological nitrogen (N) fixation were quantified using  $^{15}\text{N}$  isotope dilution techniques. The proportion of legume-N derived from fixation was greater than 85%. Thus the amounts of  $\text{N}_2$  fixed may be calculated from simple estimates of legume biomass. A legume content of at least 20% of the above-ground dry matter was estimated to be sufficient to maintain the N balance in these tropical pastures. Decomposition of legume residues is a key route for the cycling of N and other nutrients in under-utilised tropical pastures. Litter bag studies demonstrated wide variation in rates of nutrient release among forage legumes and grasses (litter half-lives ranging from 26–173 days during the wet season). Apparent transfer of legume-N to a companion grass was rapid during the first year of grass/legume pasture establishment on a sandy Oxisol, and depended on legume persistence under grazing. The ability of forage legumes to improve soil quality was investigated using  $^{13}\text{C}$  measurements of soil organic matter, potential N mineralisation rates, soil physical measurements and yields of upland rice crops after a grass/legume pasture, a grass only pasture, or native savannah.

## Utilité des légumineuses fourragères pour l'élevage et le recyclage des éléments nutritifs dans les pâturages et les systèmes agropastoraux des savanes à sol acide en Amérique latine

R.J. Thomas et C.E. Lascano

Centro internacional de Agricultura Tropical (CIAT), Apartado Aereo 6713, Cali (Colombie)

## Résumé

*La production agricole en Amérique latine doit augmenter pour contrebalancer la croissance démographique dans cette région. Or, celle-ci connaît aujourd'hui une baisse de la productivité due à la perte et au compactage des sols, au surpâturage et à des systèmes agricoles mal adaptés. Cependant, les vastes régions de savane aux sols acides et pauvres laissent entrevoir des espoirs d'améliorations durables de la production agricole. En effet, les gains de poids des animaux ont doublé par tête et décuplé par hectare sur des pâturages améliorés de graminées/légumineuses par rapport aux parcours naturels. De même, la production de lait et les performances de parturition peuvent s'améliorer avec les légumineuses. Les pâturages de graminées/légumineuses et le riz de montagne adapté aux sols acides constituent des exemples de systèmes viables utilisant efficacement des intrants. Les apports d'azote par fixation biologique de différentes légumineuses fourragères ont été quantifiés*



*par des techniques de dilution à l'isotope  $^{15}\text{N}$ . La proportion d'azote des légumineuses obtenue par fixation était supérieure à 85%. Par conséquent, les quantités d'azote fixées peuvent être déterminées à partir de simples estimations de la biomasse des légumineuses. Il a été calculé qu'une proportion d'au moins 20% de légumineuses dans la matière sèche de la biomasse aérienne pouvait suffire à maintenir le bilan d'azote dans ces pâturages tropicaux. En outre, la décomposition des résidus des légumineuses est un moyen important de recyclage de l'azote et d'autres éléments nutritifs dans les pâturages tropicaux sous-exploités. Des études de décomposition en sac ont mis en évidence d'importantes variations des taux de libération des éléments nutritifs des graminées et légumineuses fourragères (la moitié de la minéralisation s'effectuait en 26 à 173 jours pendant la saison humide). Le transfert apparent de l'azote des légumineuses aux graminées se faisait rapidement au cours de la première année d'installation des pâturages graminées/légumineuses sur un oxisol sablonneux et dépendait de la résistance des légumineuses à la pâture. La capacité des légumineuses fourragères à améliorer la qualité des sols a été étudiée avec des mesures de la matière organique du sol au  $^{13}\text{C}$ , les taux de minéralisation potentiels de l'azote, des mesures des caractéristiques physiques du sol et les rendements de cultures de riz de montagne après un pâturage de graminées/légumineuses, un pâturage de graminées uniquement ou la végétation naturelle de la savane.*

## Introduction

In Latin America where the majority of the land is used for extensive grazing, beef and milk are staples in the diet of the region's people and account for around 25% of the disposable income (CIAT, 1990a). Contrary to popular belief there is a continuing trend for decreasing self-sufficiency in these food commodities for tropical Latin America (CIAT, 1990a). Thus production levels need to be increased to meet the growing population.

In terms of nutrient acquisition and cycling, grazing can be considered to be a process whereby nutrients, which are physically widely dispersed and which are generally at low concentrations, particularly in tropical herbage, are harvested by grazing animals and converted into beef and milk (Hodgson, 1990).

The offtake of nutrients via grazing is low compared with cropping mainly as a result of the small amounts of nutrients retained by animals which range from 10–20% (Henzell and Ross, 1973; Wetselaar and Ganry, 1982). Most of the ingested nutrients are returned to the soil via excreta. However, in tropical pastures, which are generally underutilised, the return of nutrients via plant litter can be quantitatively greater than that via excreta (Thomas, 1992). Notwithstanding which route of nutrient return predominates in a particular pasture system, the low levels of nutrient offtake associated with beef and milk production when combined with an input of nitrogen (N) via legume biological fixation have long been exploited in ley farming systems as a means to restore soil organic matter and nutrients which are often depleted by cropping (Tivy, 1990). Such integrated crop–livestock systems are seen to be of increasing importance not only in developing countries where access to credit for purchased inputs is beyond the means of most farmers, but also in developed countries where environmental problems from the excessive use of fertilisers are of increasing concern (Tivy, 1990).

The feasibility of the adoption of grass/legume ley farming systems by farmers in the tropics has been discussed by Mohamed-Saleem and Fisher (1993). This paper presents the results of research conducted at CIAT on the beneficial role of tropical forage legumes in production systems of the savannahs of Latin America.

## Pastures in Latin American savannahs

Together with the tropical forests savannahs dominate the land in Latin America. Savannahs, or land with a permanent ground cover of mainly herbaceous plants or small shrubs (Eiten, 1982), cover about 45% of the land or 243 million ha in Latin America. They represent some of the last underutilised land suitable for agricultural production on the planet (Thomas et al, 1993a; Vera et al, 1993a). Traditionally

the savannahs have been used for extensive grazing and ranching, utilising the unimproved native grasses. Burning has been the only management option ubiquitously used on these vast areas. The inherent low levels of soil fertility result in poor-quality forage and hence low stocking rates of 5–10 ha/animal, low productivity levels of 50–70 kg liveweight gain/animal per year and calving rates of 50% (Lascano, 1991). The main soil constraints are low nutrient reserves, soil acidity and phosphorus fixation (Sanchez and Logan, 1992).

## Crop production in agropastoral systems

There is substantial annual crop production in Latin America mainly of maize, soybean and rice (Thomas et al, 1993a). The major production regions occur in Brazil where integrated crop–pasture systems exist. Pastoralists have been using upland rice as a pioneer crop to establish or recuperate degraded grass-only pastures in Brazil since the mid-1980s (Kluthouski et al, 1991). Similar systems with a forage legume component are currently under test and adoption in Colombia and Brazil (Zeigler et al, 1993). Generally, however, the savannahs have little true agropastoral systems.

## The contribution from forage legumes

Legumes are known to improve pastures by increasing fodder quality (protein) via biological nitrogen fixation (Whiteman, 1980; Crowder and Chheda, 1982). The N input helps alleviate the frequently limiting supplies of mineral nitrogen in tropical soils. The amounts of minerals in fodder can also be greater with a legume component in the pasture (Whiteman, 1980). This can be particularly important in environments such as the Colombian savannahs or *llanos* where minerals can limit animal performance (Lascano, 1991).

Other benefits from legumes include improved nutrient cycling via increased litter quality and greater amounts of nutrients passing through the animal (Floate, 1981; Vallis et al, 1983). Soil biological activity is also thought to be enhanced by legume residues and exudates, and pests and weeds can be influenced by the presence of legumes in pastures e.g. the control of ticks with *Stylosanthes* (Sutherst et al, 1982).

## Disadvantages of the use of forage legumes

The major disadvantage of legume use has been the lack of persistence under grazing which, depending on the legume species and its acceptability to animals, can result in the legume being grazed out of the pasture within a few years. Conversely some tropical forage legumes, e.g. *Desmodium ovalifolium* also contain high amounts of anti-quality factors such as tannins which reduce their acceptability to animals resulting in legume dominance (Orrego, 1990).

## Amounts of N fixed by forage legumes

Estimates of the amounts of N fixed by eight different forage legumes grown in fertilised strips in the savannah ecosystem of Latin America ranged from 51–237 kg N/ha for a 35-week growing season. This range decreased to 23–101 kg N/ha over the same period with the same legumes receiving no P or K fertiliser (Table 1). In a field trial where three legumes were grown in separate mixtures with the grass *Brachiaria dictyoneura* with either a fertility level used for pasture establishment (kg/ha; 20 P, 20 K, 50 Ca, 20 Mg, 12 S, micronutrients and no N) or a level more appropriate for a crop/pasture system (three times the amounts above), percentage of the plant's N derived from fixation (% Ndfa) did not vary greatly with fertiliser treatment or among legume species (Table 2). Low levels of rates of fixation in kg N/ha shown are mainly the result of the low legume presence in the pastures (Thomas and Asakawa, 1993a).

**Table 1.** Amounts of nitrogen (N) fixed by tropical forage legumes at Carimagua, Colombia.

Legume	kg N/ha per year <sup>1</sup>
<i>Pueraria phaseoloides</i>	237
<i>Centrosema acutifolium</i>	89
<i>Zornia glabra</i>	126
<i>Stylosanthes guianensis</i>	97
<i>Centrosema macrocarpum</i>	84
<i>Stylosanthes macrocephala</i>	146
<i>Stylosanthes capitata</i>	78
<i>Desmodium ovalifolium</i>	51
Range	51–237 (23–101)

1. Data based on shoot-N only of plants receiving 80 kg and 70 kg/ha and a 35-week growth period per year. Range in brackets are values from plants receiving no P or K fertiliser. Fixation was estimated by <sup>15</sup>N isotope dilution.

Source: Cadisch et al (1989).

**Table 2.** Amount of nitrogen (N) fixed by three forage legumes grown at two fertility levels.

	<i>Arachis pintoi</i>		<i>Centrosema acutifolium</i>		<i>Stylosanthes capitata</i>	
	Low fertility	High fertility	Low fertility	High fertility	Low fertility	High fertility
kg N fixed/t DM	15.6±0.8	20.3±2.3	21.1±0.7	27.6±2.2	22.6±1.9	25.9±0.8
kg N fixed/ha	1.4±0.3	12.3±2.6	2.9±0.4	4.1±1.3	35.0±4.2	66.7±2.6
% legume in pasture	4.0±0.9	17.7±1.5	5.0±0.5	4.5±1.0	46.3±4.4	44.2±3.4
% Ndfa	84.9±2.5	89.2±0.1	91.3±1.1	92.8±1.2	88.8±1.9	91.0±1.9

Nitrogen fixation measured over two 8-week periods during the wet season using <sup>15</sup>N isotope dilution techniques. % Ndfa = % plant-N derived from fixation. ±SD, n = 6.

Low fertility = kg/ha; 20 P, 20 K, 50 Ca, 20 Mg, 12 S, micronutrients and no N. High fertility was three times the above.

Source: Thomas and Asakawa (1993a).

Under pasture conditions where the root biomass of grasses is much greater than that of the legume and hence where competition for mineral N is much stronger, the percentage of the legume's N derived from fixation (% Ndfa) is generally greater than 85% (Table 2). These results agree with those of Vallis et al (1983) and imply that measurements of legume biomass in pastures will produce reasonable estimates of the amounts of N fixed. However, there is some evidence that where severe deficiencies of P and K occur, the percentage of the legume's N derived from fixation may decline below 70% (Cadisch et al, 1989). Field data indicated that P supply had a greater effect on % Ndfa than K supply (Table 3).

**Table 3.** Effect of different levels of P and K fertiliser on the per cent (%) of legume-nitrogen (N) derived from fixation in field-grown *Centrosema acutifolium* and *Centrosema macrocarpum*.

Fertiliser (kg/ha)		% legume shoot-N derived from fixation	
P	K	<i>C. acutifolium</i>	<i>C. macrocarpum</i>
5	60	84.9	79.2
40	60	94.6	91.6
75	60	94.5	94.0
75	30	94.8	93.0
75	0	94.3	92.9
LSD <sub>0.05</sub>			3.1

Nitrogen fixation measured by <sup>15</sup>N isotope dilution, plants harvested 14 weeks after sowing.

Source: Cadisch et al (1993).

### Amounts of N fixation needed to sustain the system

Using a simple modelling approach it has been estimated that a range of N fixation of 15–158 kg N/ha per year could maintain the N balance in the soil of tropical pastures (Thomas, 1992). The amounts vary with the rate of pasture utilisation and rates of recovery of N via the main recycling processes of litter return and decomposition, plant internal recycling and animal excretion. For example, at 10% pasture utilisation a variation in the recovery of excreta-N by pasture plants of between 20 and 60% will have little effect on the requirement for fixed N to balance the N cycle. The amount required would be between 32–35% of the total herbage N. At 40% utilisation, however, the fixed N requirement would be equivalent to 36–51% of the total herbage N depending on the percentage recoveries from excreta (Thomas, 1992).

When the rates of N fixation of 15–158 kg N/ha per year are converted into a range of legume dry matter in the pasture, the model estimates that for tropical pastures, which are underutilised (10–40% utilisation), the legume content in the pasture should be between 20–31%. For higher rates of utilisation a legume content of between 35–45% is required (Thomas, 1992). These ranges of legume contents are similar to the range of 20–40% reported for optimal animal production (Simpson and Stobbs, 1981; Crowder and Chheda, 1982). Thus within the range of pasture utilisation (10–40%) thought to be typical of tropical pastures (Wetselaar and Ganry, 1982), there appears to be little or no trade-off between legume consumption for animal production and legume returns to the soil in terms of balancing the N cycle. Such trade-offs will become important at higher rates of utilisation, i.e. >40%.

Table 1 shows that tropical forage legumes have the potential to fix sufficient N to maintain the N balance in a pasture. The emphasis therefore needs to be placed on maintaining a legume content of at least 20% in the pasture (Thomas, 1992).

### Effect of forage legumes on animal production

In the Colombian savannahs grass–legume pastures have more than doubled animal liveweight gain per head and increased production on an area basis by tenfold compared with a managed native savannah grassland (Figure 1). The grass/legume pastures increased liveweight gain per head by 50% and per hectare by 20–30% compared with the pure grass pasture. Increases of a similar order were obtained with grass/legume pastures on degraded rainforest lands (Thomas et al, 1992). Recent results obtained with the forage legume *Arachis pintoi* associated with *Brachiaria* spp indicate that animal liveweight gains as high as 500 kg/ha per year are possible on infertile Oxisols (Lascano, 1993).

Reproductive performance has also been improved with grass/legume pastures compared with a native savannah. The dates of first calving occurred 30% earlier and calving intervals were shortened

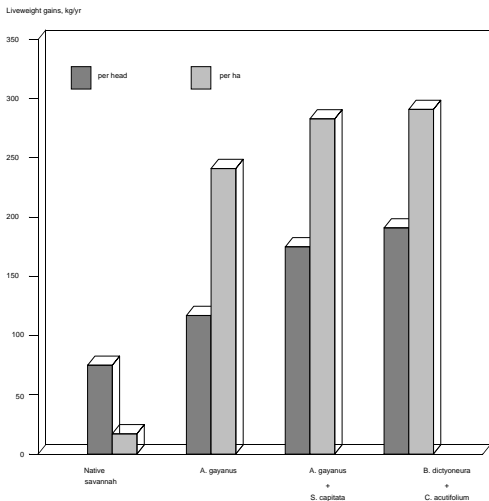
**Figure 1.** Animal liveweight gains from native savannah and improved grass/legume pastures.

Source: CIAT (1990b).

by 22% in cows grazing an *Andropogon gayanus*/*Stylosanthes capitata* pasture compared with those grazing native grassland (Table 4). Significant increases in milk production in the order of 20% have been obtained on grass/legume pastures compared with improved grass-only pastures (Table 5). These benefits, which can be attributed to the presence of a forage legume in the pasture, have been observed with a range of pastures with different legumes in different ecosystems of the region (CIAT, 1992).

**Table 4.** Reproductive performance of animals grazing grass/legume pastures compared with native savannah.

	Calving intervals (months)	Age at first calving (months)
Native savannah	22.6 a	53.4 a
<i>A. gayanus</i> + <i>S. capitata</i>	17.6 b	37.9 b

Numbers in columns followed by same letter are not significantly different,  $P < 0.05$ .

Source: Thomas et al (1992).

**Table 5.** Fat-corrected (4%) milk yields of cows grazing pastures of *Brachiaria dictyoneura* with and without legumes.

Pasture	Study 1 Holstein	Study 2	
		Crosses	Holstein
-----kg/cow/day-----			
<i>Brachiaria dictyoneura</i>	8.1 b	5.7 b	9.1 b
<i>B. dictyoneura</i> + <i>Centrosema acutifolium</i>	9.5 a	6.5 a	10.9 a
<i>B. dictyoneura</i> + <i>C. macrocarpum</i>	10.0 a	6.4 a	10.4 a

Numbers in columns followed by the same letter are not significantly different,  $P < 0.05$ .

Source: Lascano and Avila (1991).

Benefits from the legume have been observed within the first year of grazing in a recent experiment comparing a grass-only pasture of *Brachiaria dictyoneura* and two grass/legume associations, *B. dictyoneura* with either *C. acutifolium* or *S. capitata* (Fisher et al, 1993). The presence of either legume more than doubled the animal liveweight gains on a sandy Oxisol compared with the grass-only pasture (Table 6). The legume contents of these pastures were 29% for *C. acutifolium* and 31% for *S. capitata*.

**Table 6.** Animal live weights from newly established grass or grass/legume pastures.

	Cycle	LWG g/animal per day
<i>Brachiaria dictyoneura</i>	1	226
	2	171
	3	175
<i>B. dictyoneura</i> + <i>C. acutifolium</i>	1	571
	2	524
	3	273
<i>B. dictyoneura</i> + <i>S. capitata</i>	1	528
	2	495
	3	314

1st cycle 140 days wet season.

2nd cycle 140 days dry season.

3rd cycle 105 days wet season.

Stocking rate was 1.5 animals/ha. Animals rotated through four paddocks on a 7-day on/21-day rest cycle.

All pastures received 20 P, 20 K, 50 Ca, 20 Mg and 125 kg/ha and micronutrients at sowing (Fisher et al, 1993).

### Effects of forage legumes on soil fertility and nutrient cycling

Potential rates of N mineralisation were greater in soils under 5- or 14-year-old pastures containing legumes compared with similar grass-only pastures (Table 7). Soil organic-matter levels were greater under a long-term improved grass or grass/legume pasture compared with the grazed native savannah but there were no differences between the improved pasture with or without the legume (Thomas et al, 1993a).

**Table 7.** Potential nitrogen (N) mineralisation rates of soils under grass or grass/legume pastures.

Pasture	Age (years)	Depth (cm)	µg N mineralised/g soil per day
<i>Brachiaria humidicola</i> (Bh)	5	0–20	5.58 ± 0.16
<i>B. humidicola</i> (Bh) + <i>Arachis pintoi</i> (Ap)	5	0–20	6.98 ± 0.71
<i>B. decumbens</i> (Bd)	14	0–2	9.09 ± 1.45
		2–4	6.05 ± 0.38
		4–6	5.05 ± 0.42
<i>B. decumbens</i> (Pd)/ <i>Pueraria phaseoloides</i> (Pp)	14	0–2	13.66 ± 0.75
		2–4	6.59 ± 0.21
		4–6	6.17 ± 0.11

Mineralisation potential measured by anaerobic incubation at 40°C for 7 days.

± SE, n = 5 Bh, Bh/Ap; n = 10 Bd, Bd/Pp.

In the latter long-term pastures the effect of the legume was seen via the increased rates of potential N mineralisation (Table 7), an increased contribution of legume C in the surface soil layers as measured by <sup>13</sup>C isotope analyses (Rao et al, 1992; Thomas et al, 1993a) and also increased yields of a subsequent upland rice crop planted after the long-term pasture (Thomas et al, 1993a). For the first rice crop an extra 1.7 t/ha of rice was obtained after the grass/legume pasture compared with the grass-only pasture when no N fertiliser was applied (Figure 2). A further yield advantage of 0.8 t/ha of rice was obtained with a second successive rice crop (Thomas et al, 1993a).

### Effects on nutrient cycling

In an experiment on a sandy Oxisol in Colombia the total above-ground biomass-N/m<sup>2</sup> was between 3–3.6 times greater in grass/legume pastures than in a grass-only pasture during the establishment year (Table 8). In addition there was a 14–22% increase in the per cent N concentration of the grass *Brachiaria dictyoneura* when grown with either *Stylosanthes capitata* or *Centrosema acutifolium* (Table 8). The data suggest a rapid transfer of N from the legume to the grass although when root biomass-N was estimated there was little or no difference between the grass or grass/legume pastures in total biomass-N/m<sup>2</sup>. This was a result of a much greater root biomass in the grass-only pasture compared with the grass/legume pastures (Rao et al, 1992). In the same experiment animal liveweight gains were between 1.8 and 2.7 times greater in grass/legume pastures than in grass-only pastures during the first year of grazing (Table 6, wet and dry seasons combined).

**Table 8.** Initial plant biomass–nitrogen (N) before grazing.

Pasture	% N (w/w)	g N/m
<i>Brachiaria dictyoneura</i>	0.71 ± 0.02	1.41
<i>B. dictyoneura</i> /	0.87 ± 0.03	2.43
<i>Centrosema acutifolium</i>	3.07 ± 0.05	1.89
Total	–	4.32
<i>B. dictyoneura</i> /	0.81 ± 0.03	2.12
<i>Stylosanthes capitata</i>	1.88 ± 0.05	2.97
Total	–	5.09

Pastures established on a sandy loam soil with 20 P, 20 K, 50 Ca, 20 Mg, 12 S kg/ha, micronutrients and no N.

± SE, n = 10.

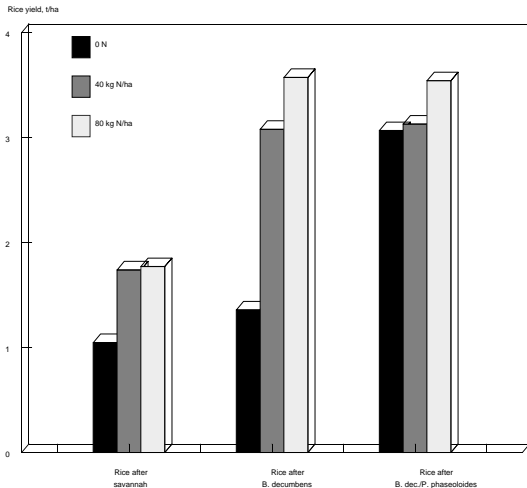
**Figure 2.** Yields of paddy rice obtained after 10-year-old grass, grass/legume pastures of native savannah.

Source: Vera et al (1993b).

In addition to the above observations the amounts of surface plant litter were initially 13–20 times greater in the grass/legume pastures than in the grass-only pasture before grazing (Table 9). Presumably, because the litter in the grass/legume pastures was of a better quality than that of the grass-only pasture in terms of nutrients and lower lignin:N ratios, the rates of litter decomposition and hence recycling, would be greater in the presence of a legume (Thomas et al, 1993b).

**Table 9.** Amount of litter in grass and grass–legume pastures during establishment.

Pasture	g litter DM/m <sup>2</sup>
<i>Brachiaria dictyoneura</i>	3.88 ± 1.28
<i>B. dictyoneura/C. acutifolium</i>	49.32 ± 3.76
<i>B. dictyoneura/S. capitata</i>	76.44 ± 6.12

± SE, n = 10.



Data from litter-bag studies confirmed the higher rates of litter decomposition of legumes compared with grasses and also higher rates of decomposition when the per cent N concentration was higher and when lignin:N ratios were lower (Thomas and Asakawa, 1993b). Of the six legumes studied *Arachis pintoi* and *Stylosanthes capitata* decomposed the fastest, *Desmodium ovalifolium* the slowest, while the other legumes and grasses formed an intermediate group with similar rates of decomposition (Table 10).

**Table 10.** Litter decomposition, rate constants and half-lives for forage grasses and legumes.

Species	Decomposition rate constant (per day)	Half-life (days)
Grasses		
<i>Andropogon gayanus</i>	0.0023	95
<i>Brachiaria decumbens</i>	0.0025	109
<i>B. dictyoneura</i>	0.0019	120
<i>B. humidicola</i>	0.0020	132
Legumes		
<i>Arachis pintoi</i>	0.0037	47
<i>Centrosema acutifolium</i>	0.0014	121
<i>Desmodium ovalifolium</i>	0.0015	153
<i>Pueraria phaseoloides</i>	0.0018	115
<i>Stylosanthes capitata</i>	0.0039	48
<i>S. guianensis</i>	0.0021	92

Data obtained from litter-bag incubations in the field during the wet season.

Source: Thomas and Asakawa (1993b).

### Patterns of nutrient release

In general the pattern of "apparent" release of nutrients (disappearance from litter) was similar for all forage species with a rapid release of K followed by slower releases of N, P and Ca (e.g. Figure 3). Quantitatively, however, the release of N, K and Ca was generally greater from legume litter than from grasses mainly as a result of higher initial nutrient concentrations in legume litter (Thomas and Asakawa, 1993b).

Rates of decomposition were best correlated with the initial lignin:N ratios of the litter. The decomposition data obtained in the field were compared with those predicted by the CENTURY model which utilises per cent lignin and lignin:N as modifiers of plant litter decomposition (Parton et al, 1987). In general, agreement between predicted patterns of decomposition and observed were good ( $r^2 = 0.92$ ) and examples are shown in Figure 4. Such data are encouraging for the widespread applicability of the CENTURY model for tropical ecosystems.

### Root decomposition

The pattern of root decomposition has rarely been studied in tropical forage species. An initial study comparing the decomposition of root material of grasses and legumes in litter bags demonstrated greater rates of decomposition with legumes than with grasses for above-ground material. Roots of *A. pintoi* decomposed fastest (Table 11). The initial per cent lignin content and/or the lignin:N ratio were correlated with rates of decomposition (Celis and Thomas, unpublished data).

Surprisingly coarse roots of grasses (>2 mm diameter) decomposed at faster rates than fine roots (<2 mm diameter) but the opposite was noted for legume material.

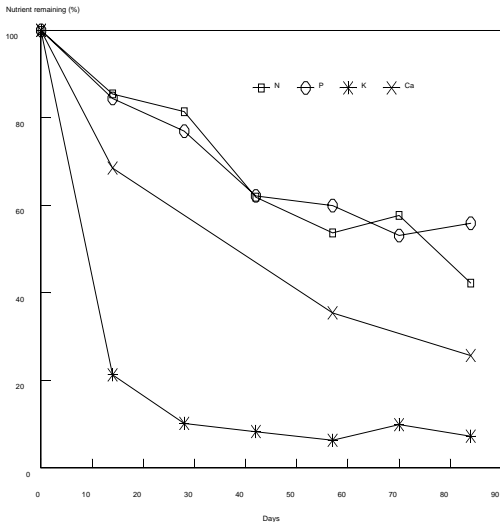
**Figure 3.** Pattern of nutrient release from *Arachis pintoi* leaf litter .

Source: Thomas (1993).

### Potential for synchrony of nutrient release with plant demand

The differences in decomposition and nutrient-release patterns among species noted above indicate some potential for the selection of fast or slow nutrient release from forage litter (e.g. legumes versus grasses). However, Thomas and Asakawa (1993b) estimated that the amounts of nutrients released from the litter of forage species would generally only contribute around 15% of the N requirements of a pasture. Similarly Dudal and Deckers (1993) concluded that in terms of crop production, returns of organic residues generally cannot replace the nutrients removed by harvest and therefore additional external nutrient inputs would be required to match demands. This is particularly true in the large areas of acid soils in developing countries where production increases will override environmental issues at least in the short term, i.e. fertiliser use should increase especially where there is little option for collecting and concentrating animal manures from extensive grazing systems.

**Figure 4.** Observed and predicted pattern of leaf litter decomposition.

## Decomposition of leaf litter

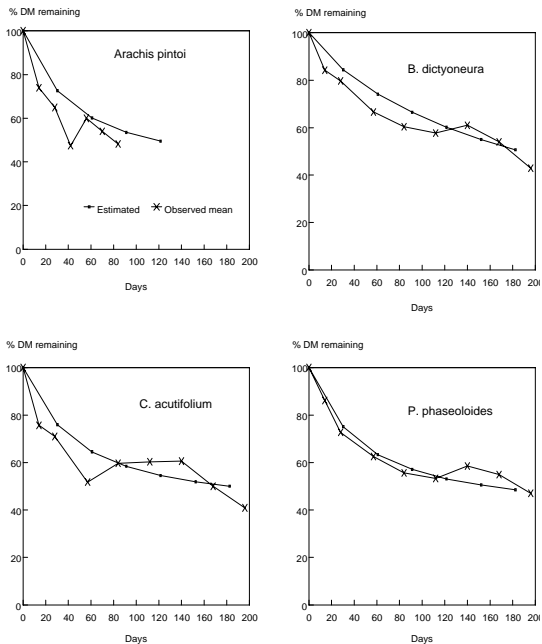

Observed data are means of three measurement periods during the wet and dry season.

Source: Thomas and Asakawa (1993b).

## Integrated crop–grass/legume pasture systems as examples of sustainable production systems

The rice–pasture system currently under trial in Colombia and Brazil (Thomas et al, 1993a; Vera et al, 1993b; Zeigler et al, 1993) is an example of an improved input-efficient system needed in regions where removal of government subsidies has resulted in less input use. In this system acid-soil tolerant upland rice is undersown with a grass/legume mixture in previously unopened savannahs or savannahs with degrading sown pastures. The system is more efficient in land preparation and, because a ground cover is established more completely and quickly than either the separate establishment of pasture or rice alone, soil erosion and nutrient losses via leaching are reduced.

**Table 11.** Decomposition half-lives of root material from forage grasses and legumes.

	Litter half-life (days)	
	Coarse roots >2 mm diameter	Fine roots <2 mm diameter
Grasses		
<i>Brachiaria brizantha</i>	73	115
<i>B. dictyoneura</i>	78	74
<i>B. humidicola</i>	81	98
Legumes		
<i>Arachis pintoii</i>	30	25
<i>Centrosema acutifolium</i>	109	47
<i>Stylosanthes capitata</i>	89	70

Data from an experiment with litter bags containing soil incubated under glasshouse conditions.

Source: Celis and Thomas (unpublished).

Improved nutrient availability via the legume component has been demonstrated by the additional rice yields obtained when rice was monocropped for two successive years after a long-term grass/legume pasture compared with a grass-only pasture (Thomas et al, 1993a). Further research is needed to determine the length of the grass/legume pasture phase required to obtain economically worthwhile increases in yields of a subsequent cereal crop.

The system can also contribute to the problem of legume persistence since by having the option to renovate the pasture every three to five years with the original or a different legume, the necessity for a persistent legume is diminished.

## Conclusions

Forage grasses and legumes selected for tolerance to the acid soils of Latin America have been shown to markedly increase animal performance in terms of liveweight gain, milk production and reproduction.

Forage legumes can fix the amounts of N needed to sustain the N economy of pastures provided the legume component constitutes at least 20% of the above-ground dry matter. Transfer of fixed N to grass can occur rapidly and, although the exact routes of transfer have not been elucidated in tropical pastures, cycling via plant litter (shoot and root residues) is likely to be important.

Litter decomposition data have been used to validate the use of the CENTURY ecosystem model for predicting decomposition rates and this information together with a knowledge of the nutrient release patterns can be used to match nutrient supplies from residues and other inputs such as manures and fertilisers with plant demand.

The possibility of integrating the use of grass/legume pastures into crop-pasture systems on infertile acid soils holds great promise for the achievement of highly productive systems which can maintain or improve the quality of the soil.

## References

- Cadisch G, Sylvester-Bradley R and Nosberger J. 1989.  $^{15}\text{N}$ -based estimation of nitrogen fixation by eight tropical forage-legumes at two levels of P:K supply. *Field Crops Research* 22:181-194.
- Cadisch G, Sylvester-Bradley R, Boller B C and Nosberger J. 1993. Effects of phosphorus and potassium on  $\text{N}_2$  fixation ( $^{15}\text{N}$ -dilution) of field-grown *Centrosema acutifolium* and *C. macrocarpum*. *Field Crops Research* 31:329-340.
- CIAT (Centro Internacional de Agricultura Tropical). 1990a. *Trends in CIAT commodities, 1990*. Working Document 74. CIAT, Cali, Colombia. 228 pp.
- CIAT (Centro Internacional de Agricultura Tropical). 1990b. *Tropical Pastures Annual Report 1989*. Working document 70. CIAT, Cali, Colombia. pp. 1-26.
- CIAT (Centro Internacional de Agricultura Tropical). 1992. *Pastures for the tropical lowlands: CIAT's contribution*. CIAT, Cali, Colombia. 238 pp.
- Crowder L V and Chhedda H R. 1982. The role of legumes. In: Crowder L V and Chhedda H R (eds), *Tropical grassland husbandry*. Longman, New York, USA. pp. 423-456.
- Dudal E and Deckers J. 1993. Concluding remarks. Soil organic matter in relation to soil productivity. In: Mulongoy K and Merckx R (eds), *Soil organic matter dynamics and sustainability of tropical agriculture*. John Wiley & Sons, Chichester, UK. pp. 377-380.
- Eiten G. 1982. Brazilian "savannas". In: Huntley B J and Walker B H (eds), *Ecology of tropical savannas*. Springer-Verlag, Berlin, Germany. pp. 25-47.
- Fisher M J, Lascano C E, Thomas R J, Ayarza M A, Rao I M, Rippstein G and Thornley J H M. 1993. An integrated approach to soil-plant-animal interactions on grazed legume-based pastures on tropical acid soils. In: *Proceedings of the XVII International Grassland Congress held in Rockhampton, Australia, 18-21 February 1993*. Vol. III. New Zealand Grassland Association, New Zealand. pp. 1903-1904.
- Floate M J S. 1981. Effects of grazing by large herbivores on nitrogen cycling in agricultural ecosystems. In: Clark F E and Rosswall T (eds), *Terrestrial nitrogen cycles*. Ecology Bulletin 33. Stockholm, Sweden. pp. 585-601.
- Henzell E F and Ross P J. 1973. The nitrogen cycle of pasture ecosystems. In: Butler G W and Bailer R W (eds), *Chemistry and biochemistry of herbage*. Academic Press, London, UK. pp. 227-245.
- Hodgson J. 1990. *Grazing management*. Longman Handbooks in Agriculture. UK. 203 pp.
- Kluthcouski J, Pacheco A R, Teixeira S M and de Oliveira E T. 1991. *Renovacion de pastagens de cerrado com arroz I. Sistema Barreira*. Documento 33. EMBRAPA-CNPAP, Goiania, Go., Brasil. 20 pp.
- Lascano C E. 1991. Managing the grazing resource for animal production in savannas of tropical America. *Tropical Grasslands* 25:66-72.
- Lascano C E. 1993. The biology and agronomy of forage *Arachis*: nutritive value and animal production. In: *The biology and agronomy of forage Arachis*. CIAT (Centro Internacional de Agricultura Tropical), Cali, Colombia (in press).
- Lascano C E and Avila P. 1991. Potencial de produccion de leche en pasturas solas y asociadas con leguminosas adaptadas a suelos acidos. *Pasturas Tropicales* 13:2-10. CIAT (Centro Internacional de Agricultura Tropical), Cali, Colombia.
- Mohamed-Saleem M A and Fisher M J. 1993. Role of ley farming in crop rotations in the tropics. In: *Proceedings of the XVII International Grassland Congress held in Rockhampton, Australia, 18-21 February 1993*. Vol. III. New Zealand Grassland Association, New Zealand. pp. 2179-2187.
- Orrego M N T. 1990. *Productividad animal en pasturas de Brachiaria humidicola (CIAT 679) solo y en asociacion con Desmodium ovalifolium (CIAT 13089) baja un sistema de manejo flexible del pastoreo*. MSc thesis, CATIE, Turrialba, Costa Rica.

- Parton W J, Schimel D S, Cole C V and Ojima D S. 1987. Analysis of factors controlling soil organic matter levels in Great Plains grasslands. *Soil Science Society of America Journal* 51:1173–1179.
- Rao I M, Ayarza M A, Thomas R J, Fisher M J, Sanz J I, Spain J M and Lascano C E. 1992. Soil–plant factors and processes affecting productivity in ley farming. In: *Pastures for the tropical lowlands: CIAT's contribution*. CIAT (Centro Internacional de Agricultura Tropical), Cali, Colombia. pp. 145–175.
- Sanchez P A and Logan T J. 1992. Myths and science about the chemistry and fertility of soils in the tropics. In: Lal R and Sanchez P A (eds), *Myths and science of soils of the tropics*. SSSA Special Publication 29. SSSA (Soil Science Society of America), Madison, Wisconsin, USA. pp. 35–46.
- Simpson J R and Stobbs T H. 1981. Nitrogen supply and animal production from pastures. In: Morley F H W (ed), *Grazing animals*. World Animal Science B1. Elsevier, Amsterdam, The Netherlands. pp. 261–287.
- Sutherst R W, Jones R J and Schnitzerling H J. 1982. Tropical legumes of the genus *Stylosanthes* immobilize and kill cattle ticks. *Nature* 295:320–321.
- Thomas R J. 1992. The role of the legume in the nitrogen cycle of productive and sustainable pastures. *Grass and Forage Science* 47:133–142.
- Thomas R J. 1993. Rhizobium requirements, nitrogen fixation and nutrient cycling in forage *Arachis*. In: Kerridge P C and Hardy B (eds), *Biology and agronomy of Arachis*. CIAT (Centro Internacional de Agricultura Tropical), Cali, Colombia. pp. 121–144.
- Thomas R J and Asakawa N M. 1993a. Nitrogen fixation by three tropical forage legumes in an acid-soil savanna of Latin America. In: Palacios R, Mora J and Newton W E (eds), *New horizons in nitrogen fixation*. Kluwer Academic Publishers, Dordrecht, The Netherlands. 750 pp.
- Thomas R J and Asakawa N M. 1993b. Decomposition of leaf litter from tropical forage grasses and legumes. *Soil biology and biochemistry* (in press).
- Thomas R J, Lascano C E, Sanz J I, Ara M A, Spain J M, Vera R R and Fisher M J. 1992. The role of pastures in production systems. In: *Pastures for the tropical lowlands: CIAT's contribution*. CIAT (Centro Internacional de Agricultura Tropical), Cali, Colombia. pp. 121–144.
- Thomas R J, Fisher M J, Ayarza M A and Sanz J I. 1993a. The role of forage grasses and legumes in maintaining the productivity of acid soils in Latin America. *Advances in Soil Science* (in press).
- Thomas R J, Fisher M, Lascano C, Rao I M, Ayarza M and Asakawa N. 1993b. Nutrient cycling via forage litter in tropical grass-legume pastures. In: *Proceedings of the XVII International Grassland Congress held in Palmerston North, New Zealand/Hamilton, New Zealand/Lincoln, New Zealand and Rockhampton, Australia, 8–21 February 1993*. Vol. I. New Zealand Grassland Association, New Zealand. pp. 508–509.
- Tivy J. 1990. *Agricultural ecology*. Longman Scientific & Technical Publications, New York, USA. 288 pp.
- Vallis I, Fergus I F and Henzell E F. 1983. Role of legumes in soil improvement. In: Burt R L, Botar P P, Walker J L and Silvey M W (eds), *The role of Centrosema, Desmodium and Stylosanthes in improving pastures*. Westview Press, Boulder, Colorado, USA. pp. 231–246.
- Vera R R, Sanz J I, Hoyos P, Molina D L, Rivera M and Moya M C. 1993a. Pasture establishment and recuperation with undersown rice on the acid soil savannas of South America. In: *Biological basis of sustainable animal production*. Zodiac Symposium, Wageningen, The Netherlands, 13–15 April 1993 (in press).
- Vera R R, Thomas R J, Sanint L R and Sanz J I. 1993b. Development of sustainable ley-farming systems for the acid-soil savannas of tropical America. In: *Symposium on the ecology and sustainable agriculture in tropical biomes*. Anais da Academia Brasileira de Ciencias (in press).
- Wetselaar R and Ganry F. 1982. Nitrogen balance in tropical agrosystems. In: Dommergues Y R and Diem H G (eds), *Microbiology of tropical soils and plant productivity*. Martinus Nijhoff/Dr. Junk, The Netherlands. pp. 1–36.
- Whiteman P C. 1980. *Tropical pasture science*. Oxford University Press, UK. 392 pp.
- Zeigler R S, Toledo J M and Sanz J I. 1993. Developing sustainable agricultural production systems for the acid soil savannas of Latin America. In: *International symposium on agroecology and conservation in temperate and tropical regions*. Dept. 26–29, Padova, Italy (in press).

# Millet and cowpea in mixed farming systems of the Sahel: A review of strategies for increased productivity and sustainability

S.V.R. Shetty,<sup>1</sup> B.R. Ntare,<sup>1</sup> A. Batiano<sup>1</sup> and C. Renard<sup>2</sup>

1. International Crops Research Institute for the Semi-Arid Tropics (ICRISAT)  
BP 12404, Niamey, Niger
2. International Crops Research Institute for the Semi-Arid Tropics (ICRISAT)  
Patancheru, A P 502 324, India

## Abstract

In the Sahel, pearl millet (*Pennisetum glaucum* (L) R. Br.) and cowpea (*Vigna unguiculata* (L.) Walp.) are an integral part of the farming systems and contribute to both human food and livestock feed. The traditional production system relies on the arrangement of these crops in time and space with both having implications for crop and livestock productivity, and sustainability. This paper reviews agronomic research and suggests ways and means of improving the productivity and sustainability of this system. The effects of different agronomic factors and cropping systems on grain and fodder yields and their implications on nutrient cycling and soil productivity are emphasised. Research at the ICRISAT (International Crops Research Institute for the Semi-Arid Tropics) Sahelian Center on such factors as cultivar choice, soil fertility and water management, crop management and cropping patterns is highlighted. Components of millet production systems found to be promising include application of small amounts of phosphorus (P), improved varieties of pearl millet and cowpea, sowing at higher densities, use of animal traction for ridging and weeding and rotation of millet and cowpea. The role of cowpea and forage legumes such as *Stylosanthes* in the improvement of soil fertility and the key link of crop residues as a source of livestock feed and soil amendment are stressed. Future research priorities on the integration of livestock into millet/land legume-based production systems are proposed.

## Le mil et le niébé dans les systèmes de production mixtes du Sahel: un aperçu des stratégies d'amélioration de la productivité et de la durabilité

S.V.R. Shetty,<sup>1</sup> B.R. Ntare,<sup>1</sup> A. Batiano<sup>1</sup> et C. Renard<sup>2</sup>

1. Institut international de recherche sur les cultures des zones tropicales semi-arides (ICRISAT)  
B.P. 12404, Niamey (Niger)
2. Institut international de recherche sur les cultures des zones tropicales semi-arides (ICRISAT)  
Patancheru, A P 502 324 (Inde)

## Résumé

Dans le Sahel, le mil (*Pennisetum glaucum* (L) R.Br.) et le niébé (*Vigna unguiculata* (L) Walp.) font partie intégrante des systèmes de production et entrent dans l'alimentation humaine et animale. Le système traditionnel de production est basé sur l'association de ces deux cultures dans le temps et dans l'espace, étant entendu qu'elles ont un impact sur la productivité et la durabilité de l'agriculture et de l'élevage. Cet article passe en revue divers travaux de recherche agronomique et propose différents moyens pour améliorer la productivité et la durabilité de ce système. L'accent est mis sur l'influence de différents facteurs agronomiques et de systèmes culturels sur la production de grains et de fourrages et leurs conséquences sur le recyclage des éléments nutritifs et la productivité des sols.

*Les recherches effectuées au Centre sahélien de l'ICRISAT sur le choix des cultivars, la fertilité du sol et la gestion de l'eau, la gestion et les modes de cultures ont été présentées. Les composantes des systèmes de production du mil identifiées comme les plus importantes sont l'application de faibles quantités de phosphore, les variétés améliorées de mil et de niébé, de fortes densités de semis, l'utilisation de la traction animale pour le billonnage et le désherbage et la rotation du mil et du niébé. Le rôle du niébé et des légumineuses fourragères comme Stylosanthes dans l'amélioration de la fertilité du sol et l'importance des résidus de récolte comme aliments du bétail et engrais vert ont été soulignés. Des priorités de recherches futures ont été proposées sur l'intégration de l'élevage dans les systèmes de production à base de mil et de légumineuses.*

## Introduction

Farming systems in the Sahel are predominantly cereal-based and are practised essentially for domestic consumption. Pearl millet (*Pennisetum glaucum*) and cowpea (*Vigna unguiculata*) are the major crops; their grains are used for human food and the residues for livestock feed. In the Sudano-Sahelian zone of West Africa (SSZWA) pearl millet occupies about 13 million ha of arable land. About 6 million ha of cowpea is grown in this zone, mostly intercropped with millet (Ntare et al, 1989). The traditional production system relies on the arrangement of these crops in time and space with both having implications on crop and livestock productivity and sustainability.

Livestock are a vital and often necessary part of crop production systems in the SSZWA. They are a key source of protein, fertiliser and financial security and play an important role in crop farming. Crop residues provide an important source of feed for animals during the dry season (Powell and Waters-Bayer, 1985).

In the SSZWA, the traditional agricultural systems were mainly based on a delicate balance between annual millet/cowpea production and long-term recycling of nutrients through fallowing, animal manure and crop residues, with very little use of purchased inputs. The rapid increase in human population, however, has disturbed this balance by shortening fallow periods and more rangelands are being cultivated resulting in ecological degradation. Production gains must come from an intensification of crop production on land already under cultivation. There is an urgent need to improve the productivity of the traditional millet/cowpea systems while maintaining or enhancing the quality of the resource base. This paper reviews research conducted at the ICRISAT (International Crops Research Institute for the Semi-Arid Tropics) Sahelian Center (ISC) to improve the productivity of millet/cowpea systems, and highlights implications on nutrient cycling, livestock and soil productivity.

## Resource base

Crop production in the SSZWA is limited by edaphic factors. Most soils have low inherent production potential: they are low in organic matter content, available phosphorus (P), total nitrogen (N) and cation exchange capacity (CEC). The risk of soil degradation by erosion and nutrient mining is common to all soil types in the region.

Rainfall in the region is monomodal, the wet season often ends abruptly followed by a 7- to 8-month dry season, and there is strong inter- and intra-annual variability in rainfall resulting in frequent drought spells during the crop cycle (Sivakumar, 1992). The type of cropping system practised by farmers depends on the rainfall gradient. The range of cultivated crop species becomes broader going from the fringes of the Sahara desert in the north to the humid south. Cereal/legume intercropping plays a major role in maintaining soil productivity, providing income to farmers and facilitating crop-livestock integration.

The socio-economic conditions of the production systems are variable and complex. There are some common characteristics among production units, such as reliance on family labour in agriculture, the importance of non-agricultural activities on income and lack of monetary income to envisage investments in agriculture.



## Improving millet/cowpea systems

The major yield limiting factors for millet/cowpea production are low crop density, competition for water and nutrients among crops, shading by the cereal, pests and diseases, drought stress and low soil fertility. Research at ISC has been addressing these factors in an effort to develop sustainable improvements in the productivity of these cropping systems.

### Cultivar choice

Traditional millet and cowpea cultivars start grain filling during September–October, the end of the rainy season. Both crops can be adversely affected by drought during years of erratic rainfall. With the increasing development of new cultivars with different morphological characteristics and maturity cycles shorter than those of traditional cultivars, more productive and stable cropping systems can be developed. Efforts to improve millet/cowpea cropping systems have been reviewed by Ntare et al (1989) and Fussell et al (1992). Stable intercropping systems through genetic improvement depend on compatible genotypes that produce not only grain for human consumption but also fodder for livestock.

### Agronomic management

Pearl millet is traditionally sown with the first rainfall and cowpea is intercropped from 15 to 30 days later, depending on the evolution of the rains. Cowpea is often dominated by millet. There is potential for increased production in intercrop combinations through modification of the sowing date and spatial arrangement of crops. Research findings at ISC have demonstrated that millet/cowpea cropping systems can be intensified and made more productive by an appropriate choice of cultivars, manipulation of agronomic factors such as row arrangements, dates of sowing, densities of component crops and use of fertilisers (Fussell et al, 1992). Planting and harvest scheduling can also optimise intercrop productivity.

It is possible to improve cowpea yields, without negatively affecting the performance of millet, by planting the legume with, or very shortly after the cereal. Planting forage type cowpeas at the same time as millet, and harvesting it before the millet flowers can reduce the negative effects of aggressive high density cowpeas on the cereal yield. This practice can improve the quality of crop residue for livestock feed.

### Soil fertility and water use

Many agronomic trials in the Sahel have clearly shown that the principal factor limiting the productivity of millet-based production systems is soil fertility. Research by the Institut de recherches agronomiques tropicales et des cultures vivrières (IRAT), many national research programmes, and more recently by the International Fertilizer Development Center (IFDC) and ICRISAT have shown that P is the most limiting soil nutrient. Applications of even small amounts of P could improve the fertiliser/grain yield ratio to 1:5 (Bationo and Mokwunye, 1991). At the farm level, 13 kg P/ha increased millet yields threefold compared to no P additions (Bationo and Mokwunye, 1991). Klaij and Vachaud (1992) found that during a season of average rainfall, 13 kg P/ha and 40 kg N/ha increased seasonal evapotranspiration of a millet crop from 211 mm to 268 mm while crop dry matter increased from 1.14 t/ha to 3.85 t/ha.

Using legumes in rotation and as intercrops with cereals provides N and is therefore important in SSZWA. In Niger, Senegal and Mali millet–legume rotations increase millet yield (Pieri, 1985). These yield increases were attributed to a combined residual effect of N from the legume and P not used by the legume (Fussell et al, 1987). Strategic management of legumes in the rotation (applying P to the legume) or intercrop (for example, early harvesting) can also increase millet yield. Use of leguminous pastures, such as *Stylosanthes* (Renard and Garba, 1989) and improved agroforestry systems can provide organic N-sources for millet-based systems (Charreau and Vidal, 1965). Leguminous trees planted in rows can reduce wind erosion and increase millet yields.

Recycling crop residues as compost, mulch or manures helps replenish soil nutrients and maintain crop yields. The combined use of fertiliser and organic amendments can increase millet yields (Figure 1). Research to improve the use of crop residues and manure can improve the stability and sustainability of cereal/legume systems in SSZWA.

**Figure 1.** Pearl millet total biomass as affected by different soil amendments (crop residues: 4 t/ha; manure: 20 t/ha for every three years; fertiliser: 30-30-0 per ha) at the ICRISAT Sahelian Center, Niger.

Pearl millet dry biomass (t/ha)

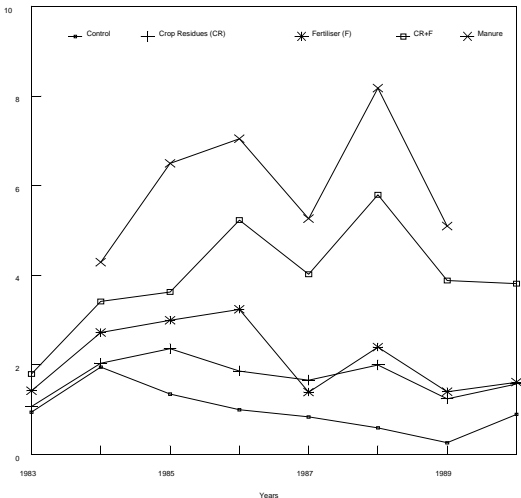

Source: ICRISAT (1992).

## Tillage

Soils in SSZWA are characterised by low surface porosity, poor structure, and low water-holding capacity. Tillage and soil surface configuration not only enhance the beneficial effects of fertilisers but also moisture conservation (Nicou and Charreau, 1985). Tillage incorporates organic matter, improves weed control, improves moisture conservation, enhances root proliferation and thereby

increases fertiliser and water-use efficiency. When tillage is accompanied by other inputs such as added fertiliser, synergistic effects were observed (Table 1). Nicou and Charreau (1985) reported an average yield increase of 22% with tillage from 38 different experiments. Increased rooting and improved crop moisture use due to tillage resulted in a 76% yield increase at ISC (Fussell et al, 1987).

**Table 1.** Effect of fertiliser, crop residues and primary tillage on total pearl millet yield (t/ha) averaged over the 1985–87 rainy season.

Treatment	Unfertilised		Fertilised (a)		Mean
	(b) – residue	(c) + residue	– residue	+ residue	
Plowing	2.29	3.79	5.14	5.39	4.15
Ridging	1.84	2.61	4.42	5.43	3.58
Zero - till	2.01	2.96	4.39	5.20	3.64
SE		0.23			
Mean	2.05	3.12	4.65	5.34	
SE		0.18			0.09

(a) 17 kg/ha of P and 40 kg/ha of N/ha.

(b) Crop residue removed at the end of the season.

(c) Crop residue not removed at the end of the season.

Source: Fussell et al (1989).

Among the land-forming methods, ridging as traditionally practised in Nigeria, Mali, Senegal and Niger and hilling or mounding as practised in the Seno plains in Mali are common in the SSZWA. At the ISC, ridging helps control wind erosion, and improves crop establishment by about 50% (Klajj and Hoogmoed, 1993). Where infiltration rates are low, tied ridging is known to reduce surface water runoff and encourage infiltration (Nicou and Charreau, 1985). Ridging also reduces the bulk density, concentrates fertility and organic matter near the seed row and helps improve seedling growth and establishment (Fussell et al, 1987).

Presently, the majority of millet farmers perform tillage, planting and weeding by hand. Large-scale adoption of mechanised primary and secondary tillage methods may only be realised through the acceptance of animal traction. Though there are some inherent socio-economic constraints, the use of animal traction is the only practical means to increase the farmers' efficiency.

### Alternative cropping systems

With more grazing land being used for crop production in the southern Sahelian zone, ruminant livestock are becoming more and more dependent on crop residues for dry-season feed. The poor quality of millet stover has prompted a need to improve feeding systems that benefit both the farmer and his livestock. Introducing forage legumes other than cowpea could provide an important protein source for livestock and contribute to the improvement of soil fertility through their nitrogen fixing ability.

Studies conducted at ISC indicated that among various perennial forage legumes, *Stylosanthes hamata* (L.) Taub and *S. fruticosa* (Retz) Alston are well adapted to the short rainy season (Garba and Renard, 1991). *Stylosanthes* sown in between millet rows at the seed rate of 4 kg/ha establishes and sets seed before millet is harvested. After harvest, animals are allowed to graze stylo and millet stover. In an average rainfall year, production of 1.7 t/ha of dry matter (DM) can be obtained from well established stylo, and in a year with above average rainfall up to 5 t/ha of dry forage could be harvested.

In a millet/stylo association, the water-use efficiency was much higher than in the millet/cowpea system (Garba and Renard, 1991). In a three-year experiment conducted at ISC, different millet/stylo cropping patterns showed that when properly managed, the stylo contributes significantly to total biomass production and increased total crude protein yield (Table 2). Lower crop density resulted in less millet grain production than in pure millet stand. In dry years, the competition for water by *Stylosanthes* at critical stages adversely affects grain production (Kouamé et al, 1993). Sheep grazing millet stover and supplemented with stylo and cowpea hay gained more weight than sheep grazing millet stover only. Average daily gains at the end of the trial were 12, 48 and 53 g for the unsupplemented, stylo and cowpea-supplemented sheep, respectively (Kouamé et al, 1992).

**Table 2.** Grain, total dry matter (DM) of millet stover and stylo, and crude-protein (CP) yields and concentrations of millet and stylo in two-year intercrop.

Cropping pattern <sup>1</sup>	1989				1990			
	Grain	DM	CP		Grain	DM	CP	
	----- kg/ha -----							
Pure millet	640	2660	158	(60) <sup>2</sup>	830	3200	94	(29)
Intercrop MSf1R	310	3240	296	(94)	430	3750	273	(73)
Intercrop MSf3R	110	3120	349	(111)	610	3000	188	(64)
Intercrop MSh1R	270	5700	616	(107)	220	4350	413	(95)
Intercrop MSh3R	140	4940	555	(113)	440	3580	304	(85)
CV %	39	17	19	10	14	12	11	10
Contrast <sup>3</sup>								
Millet vs intercrop	0.01	0.01	0.01	0.01	0.01	0.07	0.01	0.01
Intercrop 1R vs 3R	0.01	0.27	0.91	0.22	0.01	0.01	0.01	0.04
Intercrop MSf vs MSh	0.44	0.01	0.01	0.09	0.01	0.01	0.01	0.01

1. Cropping pattern abbreviations: M = millet; Sf = *Stylosanthes fruticosa*; Sh = *S. hamata*; 1R = alternate single-row planting arrangement; and 3R = alternate triple-row planting arrangement.

2. Number in parentheses is crude protein concentration of dry matter (g/kg).

3. Probability levels (F-test) for single-degree-of-freedom orthogonal contrast.

Source: Kouamé et al (1993).

At ISC the component technologies which showed promising results include: application of a small quantity of P (13 kg/ha), improved varieties of pearl millet and cowpea, sowing at higher densities, ridging and weeding using animal traction and crop rotation. A long-term multidisciplinary cropping systems trial combining these individual components was initiated in 1986. Results so far show a significant positive effect of crop rotation, P-fertilisation and ridging (Renard et al, 1987; Fussell et al, 1992; Shetty et al, 1992). Millet yields (stover and grain) were three to four times as high following cowpea as in the continuous millet cropping systems (Figure 2). Similarly the effects of P-fertility and ridging were highly significant in all the years. Animal traction resulted in 40 to 50% reduction in weeding time compared to manual cultivation. Some soil indicators of sustainability of this system are presented in Table 3.

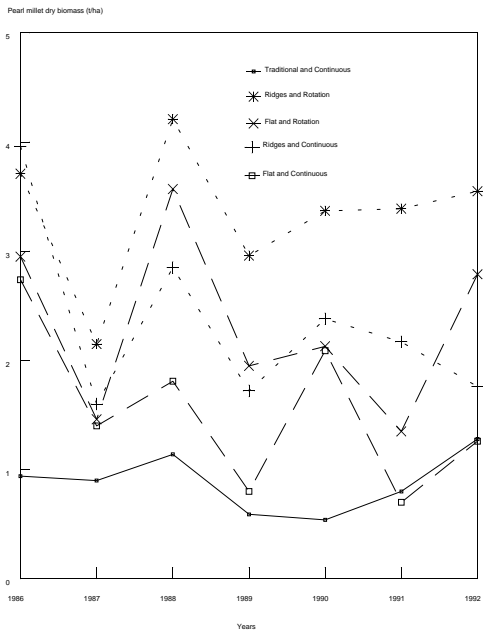
**Figure 2.** Pearl millet total biomass from alternative cropping systems at the ICRISAT Sahelian Center, Niger.

Source: Shetty (unpublished).

## Implications and research needs

Agronomic research on millet/cowpea systems has clearly demonstrated that it is possible to improve the productivity of this traditional system in a sustainable manner. Although most of the past research focused on grain production the results have significant relevance to livestock production. The constraints to improving crop and animal systems are low soil moisture availability, soil nutrients and

poor feed quality. Research to alleviate these constraints contribute directly or indirectly to total productivity and sustainability of the mixed crop–livestock systems. Contributions of legumes to soil and forage N, crop residues as fodder and soil amendments, and animal manuring are some common elements which need to be considered in aiming at improving the mixed farming systems of the Sahel.

**Table 3.** Some soil indicators of sustainability of alternative millet-based systems being evaluated at ISC, Sadoré, 1986–92.

System	pH		Total OM (%)		N (ppm)		Available P (ppm)	
	1986	1992	1986	1992	1986	1992	1986	1992
Traditional	5.45	5.41	0.31	0.22	197	117	3.8	4.6
Improved flat, continuous	5.30	5.52	0.30	0.22	193	120	5.2	18.1
Improved ridge, continuous	5.16	5.60	0.28	0.22	154	116	5.5	24.5
Improved flat, rotation	5.35	5.67	0.36	0.26	197	142	6.6	12.6
Improved ridge, rotation	5.18	5.59	0.35	0.24	169	126	5.5	24.5
SE $\pm$	0.14	0.08	0.02	0.02	33	8.0	1.2	2.05

Source: Shetty (unpublished).

### Greater use of legumes

The use of legumes in millet-based cropping systems has been found to be beneficial in supplying both N to soil and higher quality feed to animals. Rotating millet with cowpea and other legumes is highly beneficial in terms of soil fertility. However, the processes contributing to the positive effects of rotation have not yet been clearly understood. In addition to their N contribution, legumes may also improve soil biological and physical properties, solubilise occluded P by root exudate, improve soil conservation through organic matter restoration, and control pests and diseases.

Farmers in the Sahel rarely grow sole forage crops. Residues from their food crops are their main source of livestock feed during the long dry seasons. Crop genotypes and appropriate production systems that will meet the dual purpose grain/forage requirements of small-scale farmers need to be developed. Identification and development of dual purpose leguminous varieties which can produce high quality food and fodder are important.

Research on introducing alternative forage legumes into the traditional mixed farming system may improve the quality of feed available and promote sustainable improvements in crop yields. At present, studies on forage legumes introduction into crop–livestock production systems are limited to the subhumid zone. These concepts need to be tested under Sahelian conditions. For example, scientists at ISC have demonstrated the positive effects of *Stylosanthes* on millet yields, forage quality and beneficial effects on the growth rate of livestock.

The significance of biological N-fixation by legumes is well known. However, serious consideration has not been given towards the improvement of the nitrogen fixing capacity through selection and breeding. The possible contribution of certain cowpea cultivars to P uptake under low soil P conditions, and improving the utilisation of local rock phosphate also need detailed investigation.

## **Improved food and feed quantity and quality**

Agronomic research to improve millet-based systems has demonstrated that both grain and fodder yields and quality could be increased. Improvement in grain yields need not result in less stover and thus less fodder. The improved and adopted millet varieties in the region are similar to traditional cultivars and plant breeding programmes seek not only to increase grain but also the value of fodder and crop residues. Soil and crop management techniques must improve both food and feed availability. Further, the availability of early maturing, less competitive and shorter statured varieties may provide opportunity for increasing crop intensity thereby producing more total biomass per year.

Improved millet residues quality could lead to more sustainable production of both crops and livestock. Studies at ISC have shown that there exists small or no differences in leaf digestibility among varieties (Fernandez, personal communication). However, studies by Powell and Fussell (1993) showed that the fertiliser N increased and fertiliser P decreased the N concentrations of millet stover. The authors concluded that although fertiliser N and P can raise food and feed production, the maintenance of appropriate balances between agricultural supply and human and livestock demands remains a critical factor in the long-term sustainability of mixed farming systems in SSSZA.

Preliminary studies by ILCA at ISC have suggested that there are prospects for genetically improving the feeding value of millet stover. It is appropriate to evaluate in detail the quality of a large number of germplasm to determine the effect of variety on the feeding value of cowpea hay and millet stover.

The role of improved agroforestry systems in sustainable food production is gaining importance. Windbreaks using multi-purpose perennial grasses and leguminous browse can control erosion, improve soil productivity and provide food, fodder and fuel. Studies conducted at ISC have shown the selective preferences of sheep and goats. Dietary preferences also change depending upon season. Studies related to the protection of young trees against animal damage, management of tree-crop competition, and further understanding positive interaction of trees, livestock and crops are needed. Selection and genetic improvement of multi-purpose tree species that help meet the needs of poor farmers must also be considered. Optimum management of fallow land and fodder banks (planted to leguminous species) can supplement feed during the dry season and also help improve soil productivity.

## **Crop residue management**

The soils of SSSZA are extremely fragile and poor soil management can lead to serious environmental degradation. Continuous cultivation without external inputs leads to a decrease in organic matter, leaching of bases and subsequent soil acidification (ICRISAT, 1992). Crop residues are used in traditional farming systems as soil amendment although their alternative uses, including animal feed during the long dry season and for construction purposes, fuel etc, have been a constraint for large-scale adoption.

A series of long-term experiments at ISC have demonstrated the large positive effects of using millet residue as soil amendment (Bationo et al, 1994, this volume, pp. ). The application of organic amendments had beneficial effects not only on millet yields but also on nutrients cycling due to the intense activity of termites, microbial decomposition and the early root development. The role of soil micro-organisms and termites in decomposing residues and manure needs to be understood. The competitive use of crop residues for soil management, household uses and livestock feed are being addressed by ILCA/ISC. Studies to identify constraints to balanced use of crop residues and the processes involved in crop residue management for optimum crop and livestock productivity need emphasis.

Animal manuring is an important management practice for sustainable improvement of crop productivity. It is beyond the scope of this paper to focus on soil-animal-plant interactions in terms of the role of animals and manuring on crop and animal production. Studies to quantify nutrient transfer

from range and croplands and on overcoming constraints to more efficient use of animal manure in millet-based cropping systems while conserving natural resource base are being addressed by ILCA at ISC.

In parts of the millet growing area of West Africa, animal traction has been promoted for improving soil management, increasing cultivated areas and alleviating labour shortages. Feed supplies during the dry season is a major constraint to the adoption of animal traction in the drier areas. It is appropriate to quantify the tradeoff of crop residues in supporting animals during the dry season and in soil productivity maintenance.

Finally, the results reported in this paper substantiate that millet- and cowpea-based systems of the Sahel can be made more productive by better resource management techniques. Improvement of the soil resource base is a prerequisite to meet the food and feed demands of the future. Efforts to improve the biomass production through better agronomic management techniques should lead to both soil fertility restoration and the improvement of the pearl millet-based production system. Research on improving production systems that meet short-term food and feed needs while maintaining or enhancing the ability to maintain or increase long-term productivity should be accompanied by socio-economic and policy studies that will make improved systems more acceptable to producers.

## References

- Bationo A and Mokwunye U A. 1991. Alleviating soil fertility constraints to increased crop production in West Africa. The experience in the Sahel. *Fertilizer Research* 29:95–115.
- Charreau C and Vidal P. 1965. Influence de l'*Acacia albida* Del. sur le sol, nutrition minérale et rendement des mils *Pennisetum* au Sénégal. *Agronomie Tropicale* 20:600–626.
- Fussell L K, Serafini P G, Bationo A and Klajj M C. 1987. Management practices to increase yield and yield stability of millet in Africa. In: ICRISAT (International Crops Research Institute for the Semi-Arid Tropics), *Proceedings of the International Pearl Millet Workshop*. ICRISAT Center, India, 7–11 April 1986. ICRISAT, Patancheru, India. pp. 255–268.
- Fussell L K, Klajj M C, Renard C and Ntare B R. 1992. Millet-based cropping systems for improving food production in the southern Sahelian Zone. In: *Proceedings of the Workshop on Appropriate Technologies for Developing Sustainable Food Production Systems in the Semi-arid Regions of Sub-Saharan Africa, Ouagadougou, Burkina Faso, 11–14 April 1989*. Purdue University Press, West Lafayette, Indiana, USA. pp. 109–127.
- Garba M and Renard C. 1991. Biomass production, yields and water use efficiency in some pearl millet/legume cropping systems at Sadoré, Niger. In: Sivakumar M V K, Wallace J S, Renard C and Giroux C (eds), *Soil water balance in the Sudano-Sahelian Zone*. Proceedings of the International Workshop, Niamey, Niger, February 1991. IAHS Publication 199. IAHS Press, Institute of Hydrology, Wallingford, UK. pp. 431–439.
- ICRISAT (International Crops Research Institute for the Semi-Arid Tropics). 1992. *West African Programs Annual Report 1991*. ICRISAT Sahelian Center, Niamey, Niger.
- Klajj M C and Hoogmoed W B. 1993. Soil management for crop production in the West African Sahel. Emergence establishment, and yield of pearl millet. *Soil & Tillage Research* 25:301–315.
- Klajj M C and Vachaud G. 1992. Seasonal water balance of a sandy soil in Niger cropped with pearl millet, based on profile moisture measurements. *Agricultural Water Management* 21:313–330.
- Kouamé C, Hoefs S, Powell J M, Roxas D and Renard C. 1992. Intercrop *Stylosanthes* effects on millet yields and animal performance in the Sahel. In: Stares J E S, Said A N and Kategile J A (eds), *The complementarity of feed resources for animal production in Africa*. Proceedings of the joint feed resources networks workshop held in Gaborone, Botswana, 4–8 March 1991. African Feeds Research Network. ILCA (International Livestock Centre for Africa), Addis Ababa, Ethiopia. pp. 137–146.
- Kouamé C, Powell J M, Renard C and Quesenberry K H. 1993. Plant yields and fodder quality related characteristics of millet–stylo intercropping systems in the Sahel. *Agronomy Journal* 85:601–605.



- Nicou R and Charreau C. 1985. Travail du sol et économie de l'eau en Afrique de l'Ouest. In: Ohm H W and Naggy J G (eds), *Technologie appropriée pour les paysans des zones semi-arides de l'Afrique de l'Ouest*. Purdue University, West Lafayette, Indiana, USA. pp. 9–37.
- Ntare B R, Serafini P G, and Fussell L K. 1989. Recent developments in millet/cowpea cropping systems for low rainfall areas of the Sudano-Sahelian Zone of West Africa. In: ICRISAT (International Crops Research Institute for the Semi-Arid Tropics), *Soil, crop and water management systems for rainfed agriculture in the Sudano-Sahelian Zone*. Proceedings of an international workshop held at the ICRISAT Sahelian Center, Niamey, Niger, 11–16 January 1987. ICRISAT, Patancheru, India. pp. 277–289.
- Pieri C. 1985. Fertilisation des cultures vivrières et fertilité des sols en agriculture paysanne subsaharienne: l'expérience de l'IRAT. In: Ohm H W and Naggy J G (eds), *Technologies appropriées pour les paysans des zones semi-arides de l'Afrique de l'Ouest*. Purdue University, West Lafayette, Indiana, USA. pp. 254–278.
- Powell J M and Fussell L K. 1993. Nutrient and structural carbohydrate partitioning in pearl millet. *Agronomy Journal* 85:862–866.
- Powell J M and Waters-Bayer A. 1985. Interactions between livestock husbandry and cropping in a West African savanna. In: Tohill J C and Mott J J (eds), *Ecology and management of the world's savannas*. Australian Academy of Science, Canberra, Australia. pp. 252–255.
- Renard C and Garba M. 1989. Millet-based cropping systems with forage legumes for improving value of crop residues in the Sahelian zone. In: *Proceedings of the XVI International Grassland Congress, Nice, France, October 4–11, 1989*. Association Française pour la Production Fourragère, Versailles, France. pp. 837–838.
- Renard C, Ntare B R and Fussell L K. 1987. Progrès de la recherche sur les systèmes culturaux. In: *Les cultures associées au Mali*. Proceedings of seminar held in Bamako, Mali, 15–17 September 1987. ICRISAT (International Crops Research Institute for the Semi-Arid Tropics)/IER (Institut d'économie rurale), Mali. pp. 91–104.
- Shetty S V R, Sivakumar M V K and Renard C. 1992. *Millet-based cropping systems in the West African semi-arid tropics: Status and research needs*. Paper presented at the ROCAFREMI Regional Workshop, ICRISAT Sahelian Center, Niamey, Niger, 14–16 September 1992.
- Sivakumar M V K. 1992. Empirical analysis of dry spells for agricultural applications in West Africa. *Journal of Climate* 5(5):532–539.

# A critical review of crop-residue use as soil amendment in the West African semi-arid tropics

A. Bationo,<sup>1</sup> A. Buerkert,<sup>2</sup> M.P. Sedogo,<sup>3</sup> B.C. Christianson<sup>4</sup> and A.U. Mokwunye<sup>5</sup>

1. International Fertilizer Development Center (IFDC)/ICRISAT  
BP 12404, Niamey, Niger
2. Institute of Plant Nutrition – University of Hohenheim, Stuttgart, Germany
3. Centre national de recherche scientifique et technique (CNRST)  
BP 7192, Ouagadougou, Burkina Faso
4. International Fertilizer Development Center (IFDC), Muscle Shoals, AL, USA
5. International Fertilizer Development Center (IFDC), Lomé, Togo

## Abstract

Poor soil fertility and low use of organic and inorganic fertilisers are the greatest constraints to increasing agricultural productivity of farming systems in the West African semi-arid tropics (WASAT). Results from long-term field experiments showed that the use of mineral fertilisers alone in the long-run leads to decreasing base saturation, decreasing pH and increasing aluminium (Al) toxicity in soils which might be limiting crop yields. The soil fertility in intensified farming in the WASAT can only be maintained through efficient recycling of organic material such as millet crop residues (CR) or manure in combination with mineral fertilisers and using rotations with legumes such as groundnut and cowpea or *Stylosanthes*. The mechanisms responsible for the positive effects of CR on crop yields are multiple. They include local conditions such as rainfall, wind speed, soil type, and temperature regime. Thus, at some sites an increase in available phosphorus (P) or potassium (K) may be the most important mechanism while at other sites, the protection against sand coverage and water erosion, a loosening of the upper soil layers, soil microbiological effects or a decrease of soil surface temperature and soil resistance may be dominant. In mixed crop–livestock systems, the issue of competing uses for CR needs to be addressed to understand the current mechanisms of resource allocation by farmers and to design economically and ecologically sound alternatives which ensure the sustainability of current farming systems at a higher output level. The complementary effects between livestock and crop production in the Sahel also suggests that research efforts should not only take into account ways to increase crop biomass at the farm level, but also how to increase the quantity and quality of fodder.

## Evaluation critique des recherches sur l'utilisation des résidus de récolte pour la fertilisation dans la zone tropicale semi-aride de l'Afrique de l'Ouest

A. Bationo,<sup>1</sup> A. Buerkert,<sup>2</sup> M.P. Sedogo,<sup>3</sup> B.C. Christianson<sup>4</sup> et A.U. Mokwunye<sup>5</sup>

1. Centre international pour le développement des engrais (IFDC)/ICRISAT  
B.P. 12404, Niamey (Niger)
2. Institut de nutrition des plantes – Université de Hohenheim, Stuttgart (Allemagne)

3. Centre national de recherche scientifique et technique (CNRST)  
B.P. 7192, Ouagadougou (Burkina Faso)

4. Centre international pour le développement des engrais (IFDC) Muscle Shoals, AL (E.-U.)

5. Centre international pour le développement des engrais (IFDC), Lomé (Togo)

## Résumé

*Les faibles niveaux de fertilité des sols et d'utilisation des engrais organiques et inorganiques constituent les principaux obstacles à l'accroissement de la productivité des systèmes de production agricole dans la zone semi-aride de l'Afrique de l'Ouest. Il ressort des résultats d'essais de longue durée effectués en milieu paysan que l'utilisation d'engrais minéraux uniquement entraîne à terme dans les sols une diminution de la saturation des bases, une baisse du pH et un accroissement de la toxicité par l'aluminium, autant de facteurs capables de réduire les rendements. La fertilité des sols ne peut se maintenir dans les systèmes intensifs de cette région qu'avec un recyclage efficace de la matière organique comme par exemple les résidus de la culture du mil ou le fumier en combinaison avec des engrais minéraux et les rotations avec des cultures telles que l'arachide et le niébé ou Stylosanthes. L'effet des résidus de cultures sur les rendements dépend de plusieurs paramètres, y compris des facteurs géographiques tels que la pluviosité, la vitesse des vents, les types de sol, et le régime des températures. Par conséquent, alors que dans certains endroits le paramètre le plus important peut être la diminution du taux de phosphore (P) ou de potassium (K) assimilables, ailleurs, il peut s'agir de la protection contre les sables et l'érosion hydrique, de l'ameublissement du sol dans les horizons superficiels, des caractéristiques microbiologiques des sols ou d'une baisse de la température superficielle et de la résistance des sols. Dans les systèmes mixtes agriculture-élevage, il convient de bien cerner le problème des diverses utilisations concurrentielles des résidus de récolte pour pouvoir comprendre les mécanismes actuels d'allocation des ressources au niveau paysan et élaborer des options économiquement et écologiquement viables capables de garantir la durabilité des systèmes actuels à un niveau de production plus élevé. Compte tenu de la complémentarité entre l'élevage et l'agriculture dans le Sahel, les activités de recherche ne devraient pas seulement viser à accroître la production des cultures au niveau de l'exploitation, mais également à accroître la quantité et la qualité du fourrage.*

## Introduction

Research results from long-term field experiments in the West African semi-arid tropics (WASAT) showed that the use of mineral fertilisers without recycling of organic materials resulted in higher yields, but this increase was not sustainable (Jones, 1976; Bationo and Mokwunye, 1991). With mineral fertiliser application alone, soil organic matter declined. Pichot et al (1981) reported from a ferruginous soil in Burkina Faso that with mineral fertiliser application, 25 to 50% of the indigenous organic matter disappeared during the first two years of cultivation. Bache and Heathcote (1969), Mokwunye (1981) and Pichot et al (1981) observed that continuous cultivation using mineral fertilisers increased nutrient leaching, lowered the base saturation and aggravated soil acidification. Also exchangeable aluminium was increased and crop yields declined.

Traditionally, agricultural production in WASAT has been based on shifting cultivation systems. Bush-fallow periods of between 7 and 15 years alternated with 3 to 5 years of continuous cropping. Little research has been done to systematically investigate the mechanisms involved in soil fertility restoration during the fallow period. The main factors involved seem to be the accumulation of nitrogen (N) from natural atmospheric sources and biological N<sub>2</sub>-fixation and the entrapment of nutrients, mainly potassium (K), by plant biomass in the dust from Harmattan winds. Some deep-rooted trees may additionally pump nutrients from the subsoil to the soil surface and deposit them through litter fall.

In recent years, rapid human population growth rates (>3% per annum) and animals have surpassed the carrying capacity of the land in the WASAT. This has resulted in shorter fallow periods and increased environmental degradation thereby undermining the long-term stability of the production systems (Vierich and Stoop, 1990). In Niger for example, grain yields of pearl millet (*Pennisetum glaucum* L.) declined from 480 to approximately 300 kg/ha between 1960 and 1985 (Bationo et al, 1989). In attempts to meet the increasing food demands farmers are cultivating more land permanently and abandoning the traditional fallow system. Overgrazing due to droughts, the construction of deep wells and increasing herd sizes has led to increased ecological degradation.

Crop residues (CR), mainly of millet, have various uses in the mixed farming systems of the WASAT. They are used as mulch to maintain soil organic matter and protect the soil surface from water and wind erosion, for animal feed and for construction purposes. The purpose of this paper is to review the latest information generated in the area of crop residues used as a soil amendment and to indicate the gaps in knowledge which call for additional research considering the inter-relationships between soil fertility, crop residues and livestock.

### The competing uses of crop residues and their availability at the farm level

Figure 1 gives a schematic representation of the different uses of crop residues in the WASAT. Traditionally, many farmers burn whatever is left of their CR once their needs for fuel, animal feed, or housing and fencing material have been fulfilled. Economic data collected recently show the rationality of this strategy as mulched millet stalks increase weed growth and subsequently labour requirements at weeding (Lamers, unpublished data). However, the same farmers may conscientiously apply CR at a rate of up to 6 t/ha to counteract erosion and build up soil fertility on selected spots of poor millet growth (Lamers and Feil, 1993).

In the WASAT grazing animals remove more biomass and nutrients from cropland than they return in the form of manure, an exception being reported from Burkina Faso (Table 1). Therefore, Breman and Traoré (1986) concluded that a sustainable nutrient supply in the southern Sahel based on a net transfer of nutrients from rangelands to croplands required between 4 and 40 ha of rangeland per hectare of cropland.

In an inventory of CR availability in the Sudanian zone of central Burkina Faso, Segda (1991) concluded that the production of cereal straw can meet the currently recommended optimum level of 5 t/ha every two years. However, the competition with other uses was not accounted for in this study. Lompo (1983) found that in that zone up to 90% of the CR is burned for cooking or in the fields. This practice results in considerable loss of carbon and nutrients such as nitrogen and sulfur. Charreau and Poulain (1964) reported that 20 to 40 kg N/ha and 5 to 10 kg S/ha are lost by burning crop residues. Other negative effects might be temporal changes in the population of soil micro-organisms in the upper soil layers, particularly rhizobia, by the intense heat (Charreau and Nicou, 1971). Increasing the availability of CR to maintain soil fertility in the WASAT will require enhanced fuel wood production to which agroforestry research might make a contribution by screening locally adapted fast-growing woody species. As early development of such species is often slow, research on the effects of placed application of small quantities of mineral fertilisers, mainly P, or manure is needed.

For the Sahelian zone, field experiments in millet showed that from a plant nutritional standpoint the optimum level of CR to be applied to the soil as mulch may be as high as 2 t/ha (Rebafka et al, 1994). However, McIntire and Fussell (1986) reported that on fields of unfertilised local cultivars, grain yields averaged only 236 kg/ha and mean residue barely yields reached 1300 kg/ha. These results imply that unless stover production is increased through the application of fertilisers and/or manure it is unlikely that the recommended levels of CR could be available for use as mulch.

In village-level studies on crop residues along a north-south transect in three different agro-ecological zones of Niger, surveys were conducted to assess farm-level stover production, household requirements and residual stover remaining on-farm. The results of these surveys showed

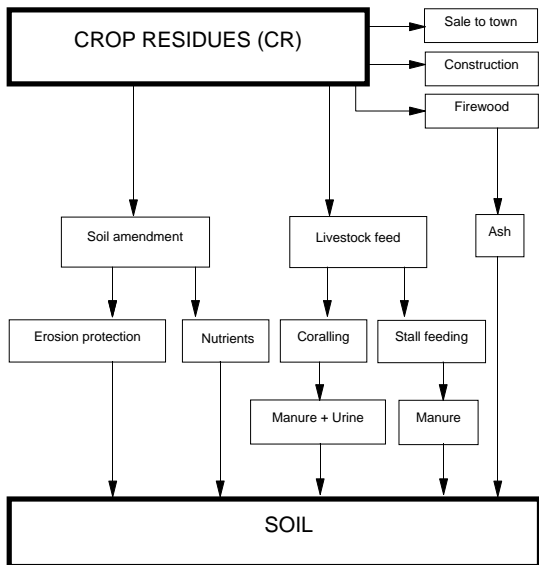
**Figure 1.** *The competing uses of crop residues in the WASAT.*

that the average amounts of stover removed from the field by a household represented only between 2 to 3.5% of the mean stover production (ICRISAT, 1993). At the onset of the rains the residual stover on-farm was only between 21 and 39% of the mean stover production at harvest time (Table 2). Even if no data have been collected on the amount of CR lost by microbial decomposition and termites, cattle-grazing is likely to be responsible for most of the disappearance of the crop residues. Similar losses were reported by Powell (1985) who found that up to 49% of sorghum and 57% of millet stover disappearance in the subhumid zone of Nigeria was due to livestock grazing. Sandford (1989) reported that in the mixed farming systems, cattle derive up to 45% of their total annual intake from crop residues and up to 80% during periods of fodder shortage. Up to 50% of the total amount of CR and up to 100% of the leaves are eaten by livestock (van Raay and de Leeuw, 1971). Most of the nutrients are voided in the animal excreta but when the animals are not stabled, the nutrients contained in the droppings cannot be effectively utilised in the arable areas (Balasubramanian and Nnadi, 1980; Table 1).

**Table 1.** Cereal stover removals and manure returns during crop-residue grazing in West Africa.

Location	Stover removals		
	Total dry matter (kg/ha)	Nitrogen (kg/ha)	Phosphorus (kg/ha)
Nigeria	2470	24.5	3.9
Burkina Faso	1570	14.8	4.0
Burkina Faso	1450	13.8	1.5
Niger	2135	16.8	1.8
Niger	3495	33.1	3.6
Niger	1298	13.5	1.5

Location	Manure returns		
	Total dry matter (kg/ha)	Nitrogen (kg/ha)	Phosphorus (kg/ha)
Nigeria	70–400	0.8–4.3	0.2–0.8
Nigeria	27–262	0.3–1.7	0.1–0.3
Burkina Faso	600–1600	7.5–20.0	1.5–4.0

Source: Powell and Williams (1993).

**Table 2.** Summary statistics of millet stover on farms in three districts in Niger.

Month and year	District	Number of farms sampled	Quantities of stover on farms (kg/ha)				
			Minimum	Median	Maximum	Mean	SD
April 1993	Hamdallaye	40	130	250	550	283	104
	Dantiandou	52	110	285	790	325	109
	Kirtachi	43	430	710	1190	755	209
October 1992	Hamdallaye	51	570	1020	2730	10901	3855
	Dantindou	61	340	1070	3790	98816	54
	Kirtachi	54	700	1505	3560	18000	636
March 1992	Hamdallaye	46	90	210	600	231	96
	Dantiandou	58	90	250	690	251	85
	Kirtachi	54	250	610	1520	631	249

Source: ICRISAT (1993).

In an on-farm evaluation of CR availability, Bationo et al (1991) showed that the use of fertilisers increased stover yields under on-farm conditions. Despite the many competing uses of CR (Figure 1) the increased production led to significantly more mulch in the subsequent rainy season (Table 3). The complementarity of livestock and crop production in the Sahel suggests the need for research on possibilities to increase nutrient use efficiency for higher CR production and to improve the production of alternative feed supplies. The aim of such research should be to increase both fodder quantity and quality thus conserving more CR for soil application.

**Table 3.** Effect of fertiliser sources and methods of fertiliser application on the amounts of residue left on the soil surface in farmers' fields, Gobery, Niger, 1988.

Treatments <sup>1</sup>	Stover remaining (t/ha)
Traditional — no fertiliser	0.686
SSP BI + N BI	1.682
SSP BI + N HP residual	0.858
SSP HP + N HP	1.669
SSP HP + N HP residual	0.986
SSP BI	1.297
SSP BI residual	1.081
PAPR BI + N BI	1.835
PAPR BI + N BI	1.098
SE	± 0.129
CV (%)	42.7

1. BI = Fertiliser broadcast and incorporated.

HP = Fertiliser placed on the millet hill.

SSP = Single superphosphate.

APR = Partially acidulated phosphate rock.

Fertilisers were applied at 13 kg P/ha and 30 kg N/ha.

Source: Bationo et al (1991).

## Effects of crop residues on crop productivity in the WASAT

Long-term experiments on the sustainability of crop production in the WASAT without fertilisers, with chemical fertilisers and/or organic materials under different rotations were initiated in the early 1960s by the Research Institute for Tropical Agriculture (IRAT). Results of these experiments have been summarised by Pieri (1986; 1989) and clearly showed that fertiliser application is an effective means of increasing yield in arable farming systems without fallow. However, Pieri also cautioned that, in the long-run, the use of chemical fertilisers alone may lead to decreasing base saturation, K deficiency, decreasing pH and occurrence of Al toxicity. Application of organic material such as green manures, crop residues, compost or animal manure can counteract the negative effects of chemical fertilisers (de Ridder and van Keulen, 1990). This led Pieri (1986) to conclude that soil fertility in intensive arable farming in the WASAT can only be maintained through efficient recycling of organic material in combination with rotations of N<sub>2</sub>-fixing leguminous species and chemical fertilisers.

In the Sahelian zone with a soil organic matter content of 0.2% in the 0 to 15 cm layer, Bationo et al (1993) reported a large positive and additive effect of CR and fertiliser application on pearl millet yields (Table 4). Over the duration of the study, grain yields in the control plots (no fertiliser nor CR) were low and steadily declined. This indicates that the potential for continuous millet production on these soils is very limited in the absence of soil amendments. Except for the drought year in 1984, fertiliser application resulted in an approximately tenfold yield increase compared to the control. Since the P fixation capacity of the sandy soils of the Sahel is low (Mokwunye et al, 1986) and residual effects of P-fertiliser application are evident even after three years, the use of P-fertilisers has important implications for sustainable soil management in the WASAT. The availability of cheap P fertilisers to small farmers may induce them to cultivate less land more intensively thereby leaving more area under fallow or pasture. This, in turn, would decrease the negative effects of wind and water erosion on the soil productivity.

**Table 4.** Effect of crop residue and fertiliser on pearl millet grain and stover yields at Sadoré, Niger.

Treatment	Grain yield (kg/ha)				Stover yield (kg/ha)			
	1983	1984	1985	1986	1983	1984	1985	1986
1. Control	280	215	160	75	NA	900	1100	1030
2. Crop residue (CR) (no fertiliser)	400	370	770	745	NA	1175	2950	2880
3. Fertiliser (no CR)	1040	460	1030	815	NA	1175	3540	3420
4. Crop residue plus fertiliser (CRF)	1210	390	1940	1530	NA	1300	6650	5690
LSD <sub>0.05</sub>	260	210	180	200		530	650	870

NA = Not available.

Source: Bationo et al (1993).

In a location in the Sudanian zone where soil organic matter content was 0.5%, the application of CR alone failed to increase millet yields (Table 5). For the same Sudanian zone, Sedogo (1981) reported negative effects of CR on pearl millet yield. He attributed this to N immobilisation by CR in the absence of mineral fertiliser application. When effects of mineral fertilisers and crop residues on stover-use efficiency and fertiliser-use efficiency of millet were computed it became clear that at Sadoré CR application increased fertiliser-use efficiency for the drought year 1984 whereas at Tara there was no effect. Effects of fertilisers on stover-use efficiency were similarly positive at both sites except for 1984 and 1986 at Sadoré (Table 6).

The contradictory results of yield reductions and increases due to CR indicate that much research needs to be done to investigate the mechanisms of CR effects on crop growth in different zones, and to monitor more closely the dynamics of organic matter in the different soils. A key issue is the C/N ratio of the applied organic material, which tends to be high in cereal straw leading to N immobilisation after initial application. In combination with strategic mapping techniques such as the Geographical Information System (GIS), it may be possible to delineate zones where CR could be applied as surface mulch and others where CR should be recycled through the animal or composted before soil application to avoid negative effects due to nutrient immobilisation. Such zonal differentiation is of practical importance as composting requires water during the dry season, high labour for processing and transport, and contributes to a redistribution of nutrients. Thus, it should only be done in areas where the payoff justifies such efforts. On the other hand even the management of crop residue recycling via manure needs particular attention. Powell et al (1991) reported that millet yields increased by 52% when urine was added to manure compared to manure alone. While corralling animals on croplands is a widespread practice in the farming systems of the Sahel and leads to complicated arrangements between crop farmers and pastoralists, high nutrient losses may occur at manure rates that exceed 10 t/ha (see Brouwer and Powell, this volume).



**Table 5.** Effect of mineral fertilisers and crop residue on pearl millet grain and total dry-matter yields at Tara, Niger.

Treatment	1990		1991		1992	
	Grain yield	Total dry matter	Grain yield	Total dry matter	Grain yield	Total dry matter
	----- kg/ha -----					
Control	235	1694	347	2154	102	1193
Crop residue	751	2633	490	2695	140	1673
Fertiliser (N + P)	1287	4608	1006	4794	625	3269
Crop residue plus fertiliser (N + P)	1369	4603	922	4823	616	3427
Crop residue plus fertilisers (N + P + K)	1426	4909	1009	5304	778	3937
SE	95	358	101	270	56	238
CV (%)	19	19	27	13	25	18

Source: Bationo (unpublished data).

## Effects of organic amendments on soil chemical properties

### Soil organic matter

In the Sahelian zone continuous cultivation can rapidly deplete soil organic matter (SOM) but the addition of CR with fertiliser or of manure alone can maintain SOM close to levels obtained under fallow (Figure 2A). Bationo et al (1991) reported that effective CEC (ECEC) is more related to organic matter than to clay in the WASAT, indicating that a decrease in organic matter will decrease the ECEC and then the nutrient-holding capacity of those soils. De Ridder and Van Keulen (1990) found that a difference of 1 g/kg in organic carbon results in a difference of 4.3 mmol/kg in CEC.

Berger et al (1987) reported for the Northern Guinea Zone that crop response to chemical fertilisers ceased below a SOM of 0.6%. In the Sahelian zone, however, even at 0.2% of SOM, a strong positive crop response to chemical fertilisers was found (Bationo et al, 1993). These apparently conflicting results suggest that future research should also study the critical levels of SOM for the different soil types, climate and cropping systems beyond which no further crop response to fertilisers can be expected.

Depending on the soil moisture regime and microbial and termite activity CR decomposition may be very rapid in the WASAT. The decomposition of crop residues in the Sahelian zone at Sadoré and the Sudanian zone at Tara is reported in Table 7. Because of the high termite and microbial activities observed (Bationo et al, unpublished data), irrespective of fertility treatment and amounts of crop residues applied, at Tara 99% of the CR was decomposed during the cropping season compared to between only 40 and 50% at Sadoré. Although the rate of decomposition of CR was much higher at Tara no crop response to CR was obtained (Table 5) nor did SOM increase at this more humid site (Bationo, unpublished data). The initial CR quality may play an important role in determining the rate of residue decomposition and nutrient mineralisation. However, at present it is not even clear what

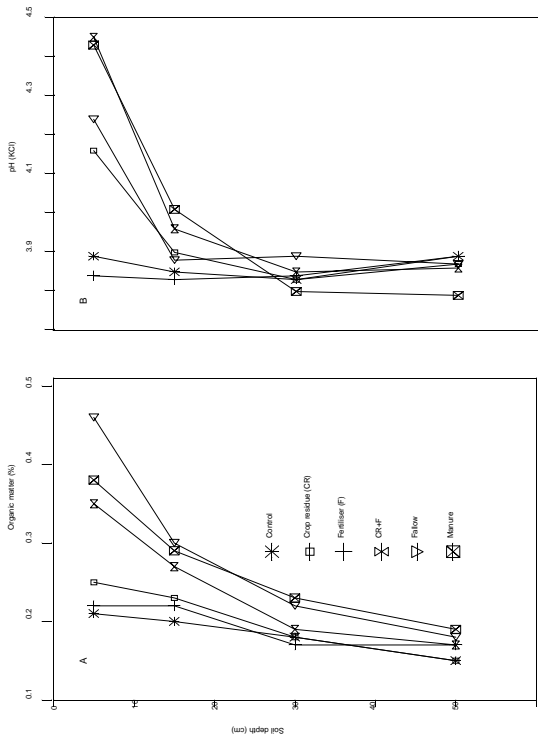
**Figure 2.** Effects of soil amendments on soil organic matter content (A) and pH (B) Sadoré, Niger, 1991.

physical and chemical characteristics are most important in governing the decomposition of organic amendments in the WASAT. Future research should aim to elucidate the influence of such factors as water soluble minerals, the lignin and polyphenol contents, as well as C/N and lignin/N ratios on the decomposition of organic amendments. Such data together with soil and climate characterisations may allow a better extrapolation of the research results obtained in one location to others in the WASAT.

**Table 6.** Incremental millet grain and stover yield increases due to crop residue (CR) and fertiliser application.

Zone	Year	Treatment <sup>1</sup>	CR effect		Fertiliser effect		
			Grain ----- kg/t stover -----	Stover	Grain ----- per kg P -----	Stover	
Sahel (Sadoré)	1983	CR	30 <sup>2</sup>	NA	–	–	
		Fertiliser	–	–	59 <sup>4</sup>	NA	
		CR+Fertiliser	233 <sup>3</sup>	NA	72 <sup>5</sup>	NA	
	1984	CR	78	138	–	–	
		Fertiliser	–	–	34	21	
		CR + Fertiliser	44	100	14	31	
	1985	CR	519	1575	–	–	
		Fertiliser	–	–	67	188	
		CR+Fertiliser	1370	4269	137	427	
	1986	CR	227	627	–	–	
		Fertiliser	–	–	57	184	
		CR+Fertiliser	219	701	112	359	
	Sudanian 1990 (Tara)		CR	129	13	–	–
			Fertiliser	–	–	81	103
			CR+Fertiliser	284	403	87	124
1991		CR	122	277	–	–	
		Fertiliser	–	–	51	108	
		CR+Fertiliser	210	548	44	115	
1992		CR	22	157	–	–	
		Fertiliser	–	–	40	83	
		CR+Fertiliser	182	416	40	90	

1. CR according to stover yields in previous year (Tables 4 and 5), P at 13 kg P/ha.

2. Calculated as (yield CR – yield control)/CR applied.

3. Calculated as (yield CR + fertiliser – yield control)/CR applied.

4. Calculated as (yield fertiliser – yield control)/P applied.

5. Calculated as (yield CR + fertiliser – yield control)/P applied.

NA = Not available.

Source: Bationo (unpublished data).

**Table 7.** Decomposition of surface applied millet stover with different soil amendments at two locations, Tara and Sadoré, Niger.

Treatment <sup>1</sup>	Crop residue applied at the beginning of season	Crop residue undecomposed at the end of season
	----- t/ha + -----	
Tara (800 mm rainfall)		
Control	4.0	0.05
Crop residue	4.0	0.04
Fertiliser (N, P, K)	4.0	0.06
Crop residue plus fertiliser	4.0	0.07
Sadoré (1) (400 mm rainfall)		
Control	4.0	2.3
Crop residue	4.0	2.3
Fertiliser (N, P, K)	4.0	2.5
Crop residue plus fertiliser plus micro-nutrients	4.0	2.5
Sadoré (2) (400 mm rainfall)		
No P	2.0	1.0
15 kg P <sub>2</sub> O <sub>5</sub> /ha	2.0	1.1
No P	4.0	1.9
15 kg P <sub>2</sub> O <sub>5</sub> /ha	4.0	1.9

1. The same treatments were applied to plots for the previous three years at Tara, for the previous four years at Sadoré (1), and for the last two years at Sadoré (2). The treatments, control, fertiliser, No P, and 15 kg P<sub>2</sub>O<sub>5</sub>/ha only during the year previous to this study. received

Source: Lee and Bationo (unpublished data).

## Soil pH

Soil acidification associated with continuous cultivation is a common phenomenon in the WASAT and numerous reports show that the application of organic residues is one way to increase pH thereby alleviating aluminium toxicity and molybdenum deficiency (Table 8; Figure 2B). However, the amounts of CR or manure needed to maintain soil pH at a level favourable to sustainable crop production are considerable and future research should investigate to what degree lime application alone or in combination with moderate amounts of organic material could help to achieve this goal.

**Table 8.** Organic carbon (C, g/kg), cation exchange capacity (CEC, mmol/kg), base saturation (fraction), exchangeable phosphorus (P), calcium (Ca), and magnesium (Mg) (mmol/kg), and pH (water) for soil experiments in Saria, Burkina Faso.

	C content	CEC	Base saturation	Exchangeable cations			pH
				K	Ca	Mg	
Control	2.5	26.5	0.63	1.6	11.5	3.5	5.2
Chemical fertiliser							
Low	2.4	26.5	0.37	0.9	6.6	2.2	4.6
High	2.4	25.0	0.38	1.5	6.0	2.1	4.4
Crop residues (5 t/ha)							
Fertiliser low	3.5	25.0	0.70	2.2	11.4	3.9	5.2
Fertiliser high	6.6	39.4	1.00	5.0	23.7	10.7	5.9

Source: Pichot et al (1981).

## Phosphorus

The addition of manure and CR either alone or in combination with inorganic fertilisers frequently resulted in a substantial decrease in the soils' capacity to fix P. The maximum sorption of phosphorus calculated by using the Langmuir equation (Langmuir, 1918) decreased with the application of organic material (Figure 3). This may at least partly explain the demonstrated increase of P-fertiliser use efficiency with CR application (Table 6). In laboratory experiments using the sandy Sahelian soils of the WASAT Kretzschmar et al (1991) found that the addition of CR resulted in an increased P availability which was attributed to the complexation of iron and aluminium by organic acids.

**Figure 3.** Effect of soil amendments on maximum phosphorus sorbed, Sadoré, Niger, 1991.

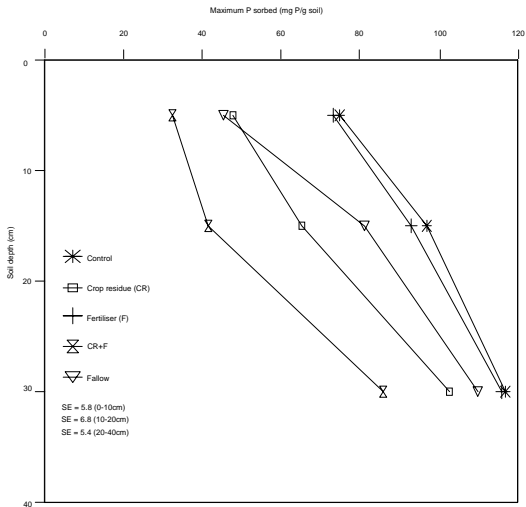

## Exchangeable bases

For the Sahelian zone Geiger et al (1992) reported that CR application increased the amount of exchangeable bases in the surface soil. CR application resulted in a two- to threefold increase in soil surface calcium (Ca) and magnesium (Mg) levels. Similar results for the positive effects of CR on SOM, pH, cation exchange capacity, pH, base saturation and exchangeable cations have been reported from the Sudanian zone (Pichot et al, 1981). In millet, up to 90% of the Ca, Mg and K uptake remains in the straw (Balasubramanian and Nnadi, 1980; Bationo et al, 1993). It is thus still unclear to what

degree increases in soil exchangeable bases come from minerals carried in dust particles and trapped by mulched residues, or are due to nutrient release from decomposing crop residues. Given the positive response of millet to K application (Rebafka et al, 1994) it is particularly interesting that 30 kg K/ha may be released during the decomposition of 2 t/ha of millet straw whereas up to 20 kg K/ha be deposited in micas and feldspars transported by Harmattan winds (Stahr et al, 1993).

Future basic research using labelling techniques should look in a systematic way at the nutrient turnover from organic amendments and mineral fertilisers in combination with the nutrient uptake of the growing crops. This could lead to a better understanding of nutrient cycling processes in natural and improved cropping systems. Such knowledge could help to improve the timing of soil amendment application so that nutrient release coincides with the nutrient demands of crops.

## Effects of organic amendments on soil biological properties

Several scientists have reported the beneficial effect of CR application on the activity of various micro-organisms and the first comprehensive survey has also been done in the Sahel (Table 9). However, little has been done to describe cause-effect relationships of CR application on soil micro-organisms in the Sahel. Hafner et al (1993a) showed that the application of CR increased the total number of bacteria and the N<sub>2</sub>-fixing bacteria in the bulk soil and rhizosphere soil of millet (Table 10). The N gain from long-term nitrogen balance was positively correlated to the increase in the total bacteria and N<sub>2</sub>-fixing (diazotrophic) bacteria (Table 11). These data suggest that the long-term gain of N was most likely due to biological nitrogen fixation (BNF).

**Table 9.** Microbial populations and pH units of soil samples given crop residue plus fertiliser, crop residue alone, fertiliser alone and no additions (control).

Microbial populations <sup>1</sup>	Method	Soil treatments				
		Crop residue + fertiliser	Crop residue	Fertiliser	Control	
Total micro-organisms	2	Soil	13 x 10 <sup>4</sup>	22 x 10 <sup>4</sup>	34 x 10 <sup>4</sup>	33 x 10 <sup>6</sup>
		Rhizosphere	14 x 10 <sup>5</sup>	29 x 10 <sup>5</sup>	31 x 10 <sup>2</sup>	88 x 10 <sup>3</sup>
Fungi		Soil	63 x 10 <sup>1</sup>	65 x 10 <sup>1</sup>	31 x 10 <sup>2</sup>	88 x 10 <sup>1</sup>
		Rhizosphere	36 x 10 <sup>5</sup>	75 x 10 <sup>3</sup>	64 x 10 <sup>3</sup>	84 x 10 <sup>1</sup>
Bacteria and actinomycetes		Soil	47 x 10 <sup>2</sup>	75 x 10 <sup>3</sup>	64 x 10 <sup>3</sup>	12 x 10 <sup>3</sup>
		Rhizosphere	36 x 10 <sup>5</sup>	87 x 10 <sup>4</sup>	70 x 10 <sup>4</sup>	80 x 10 <sup>3</sup>
<i>Azospirillum</i> species	3	Soil	10 <sup>3</sup>	10 <sup>3</sup>	10 <sup>4</sup>	10 <sup>3</sup>
		Rhizosphere	12.9 x 10 <sup>7</sup>	19.4 x 10 <sup>7</sup>	2.2 x 10 <sup>7</sup>	7.2 x 10 <sup>7</sup>
Endomycorrhizal spores	4	Soil	13	14	10	10
		Rhizosphere	14	16	15	17
	Relative dry weight	4.9	2.8	3.7	1	
	5	Root infection (%)	68	77	70	67
pH units		Soil	4.4	4.2	4.1	4.2
		Rhizosphere	4.6	4.5	4.1	4

1. Populations estimated from 1 gramme of natural soil. Samples taken in October 1983, Sadoré.

2. Bunt and Rovira (1955).

3. Dobereiner (1978).

4. Abd-El-Malek and Ishac (1968).

5. Wet sieving, Gerdeman and Nicolson (1963).

**Table 10.** "Most probable numbers" (MPN) of total bacteria and of  $N_2$ -fixing bacteria in bulk and rhizosphere soil.

Micro-organisms ( $\times 10^5$ /g soil)		Total bacteria	$N_2$ -fixing bacteria	$N_2$ -fixing (% of total)
Bulk soil	- CR+F	16	2	9
	+CR+F	43	11	26
Rhizosphere soil	- CR+F	929	418	45
	+CR+F	2300	872	38

Soils were sampled in the growing season 1989, 50 days (bulk soil) and 60 days (rhizosphere soil) after planting of millet.

CR = crop residues; F = fertiliser.

Source: Hafner et al (1993a).

**Table 11.** Nitrogen balance in a continuous millet cropping system (1983-88), Sadoré, Niger.

Fate of N	Treatment			
	-CR-F <sup>1</sup>	+CR-F	-CR+F	+CR+F
	(total kg N/ha)			
Removal				
Grain	22	86	114	200
Stover	47	-	140	-
Input				
Fertiliser	0	0	180	180
Rainfall	12	12	12	12
$N_2$ -fixation	?	?	?	?
Losses				
Volatilisation	0	65	65	65
Leaching	150	150	150	90
Total input	12	12	192	192
Total output	219	236	469	355
Soil internal				
change <sup>2</sup>	-265	-190	-235	-84
Balance	-58	+34	+42	+79

1. CR = crop residues; F = fertiliser.

2. Soil analysis total N 0-60 cm depth.

Source: Hafner et al (1993a).

Hafner et al (1993b) also reported an increase of root-length density with CR application which led to an increase in total P uptake from 3.4 to 10.6 kg P/ha. Tien et al (1979) showed for other crops that diazotrophic bacteria may produce phytohormones such as auxines or gibberellins which stimulate lateral root development and root hair formation of the host plant. However, whether better root growth due to increased microbial populations in the rhizosphere of millet plants is indeed a cause of better millet development with CR application remains unclear. Increased microbial populations might as well be the consequence of better shoot and root development with increased root exudation and better K and P nutrition, or improved soil physical conditions.

On the leached sandy soils of the Sahel any increase in root surface area improves P nutrition and enhances millet growth. Thus, root colonisation with Vesicular Arbuscular Mycorrhizae (VAM) leading to greater root surfaces may be important for crop development. However, little is known about the level of VAM infection and speed of root colonisation of field grown crops in the Sahel. Nevertheless, given the large rooting system of millet and its short growing cycle, a contribution from VAM to improved P nutrition may seem less likely in millet than in legumes with less extensive root systems or in trees with longer growing cycles.

Negative effects of CR on crop growth have also been observed. Populations of stem borers (*Coniesta ignefusalis*) may build up and adversely affect millet and sorghum yields. Several researchers also reported phytotoxicity problems due to CR application or continuous cereal cultivation (Burgos-Leon, 1979; Pichot et al, 1981; Pieri, 1986). However, it remains unclear to what degree organic acids, lactones, phenols, alkaloids, and turpenoid compounds isolated from the crop residues and produced during decomposition (Elliot et al, 1979) are responsible for yield depressions after CR application.

## Effects of applied organic material on soil physical properties and soil conservation

The application of CR on the stability of soil aggregates could affect soil structure, soil crusting, pore volume and pore size distribution and hence infiltration capacity and soil moisture retention characteristics. However, these parameters are difficult to quantify and few measurements have been done in the WASAT. Cissé and Vachaud (1987) in Senegal reported that soil hydraulic properties such as infiltration capacity and soil moisture retention curve were not affected by an increase of soil organic carbon from 0.15 to 0.30 g/kg. These results seem to be supported by a long-term CR management experiment on a sandy Sahelian soil (Bationo et al, 1993) where the addition of CR had no effect on soil water use or water-holding capacity.

The effectiveness of crop residues in reducing runoff, erosion, and transport of sediment to streams in temperate conditions has been summarised by Larson et al (1979). However, little work on this aspect of CR application has been done in the WASAT where rainfall intensities may exceed 150 mm/h. Field studies at the ICRISAT Sahelian Centre have shown that sand blasting and burial of young millet seedlings by sand storms may cause a reduction in millet yield by up to 51%. Michels et al (1993) measured a reduction in horizontal sand transport of 59% with the application of 2 t/ha of CR. Geiger et al (1992) reported that the increase in soil fertility following application of CR was due in part to the entrapment of eolian materials, which generally have better fertility characteristics, and to the protection of the more fertile surface soil from erosive effects of the strong winds common at the onset of the rainy season in the Sahel. Research at ICRISAT also shows that CR applied at a rate of 2 t/ha may lead to a decrease in peak surface soil temperatures (at 1 cm depth) from 48.5 to 39.3°C (Buerkert et al, unpublished) which is likely to reduce the temperature stress for seedlings especially after storms when young millet plants may be partially covered by sand. Also, resistance of the surface soil as determined by penetrometer readings just before the onset of the rainy season have been found to decrease with CR application from 27 to 9 N/cm at 0 cm to 2 cm and from 238 to 148 N/cm at 2 to 5 cm depth (Buerkert et al, unpublished). This may partly explain the higher root length density found by Hafner et al (1993b).

## Conclusions

In the WASAT, the increasing human and animal population pressure has put stress on the land resource base. Nutrient balances from many cropping systems are negative, with offtake being greater than input, indicating that farmers are mining their soils. Crop residues in the mixed crop-livestock farming systems of the WASAT have multiple competing and some complementary uses but are scarcely available for widespread direct application to soils. The high opportunity costs of CR need



to be taken into consideration when alternative management practices with increased use of CR for crop production are investigated and advocated. Future research must aim to quantify the tradeoffs between the different uses of CR and assess the effects of organic and inorganic fertiliser use on higher grain and CR production at the farm-level, on fallow management and fodder quality, and on nutrient cycling.

Long-term experiments have indicated that the use of mineral fertilisers leads to decreasing base saturation, decreasing pH, and increasing Al toxicity. Future basic research might focus on investigating the effects of CR application on soil biological and physical properties and on soil conservation with different soil types and cropping systems. This may lead to the development of adapted agricultural techniques for the WASAT with prospects for sustainable soil productivity at higher output levels.

## References

- Abd-El-Malek Y and Ishak Y Z. 1968. Evaluation of methods used in counting azotobacters. *Journal of Applied Bacteriology* 31:267–275.
- Bache B W and Heathcote R G. 1969. Long-term effects of fertiliser and manures on soil and leaves of cotton in Nigeria. *Experimental Agriculture* 5:241–247.
- Balasubramanian V and Nnadi C A. 1980. Crop residue management and soil productivity in savanna areas of Nigeria. In: *Organic recycling in Africa*. FAO Soils Bulletin 43. FAO (Food and Agriculture Organization of the United Nations), Rome, Italy. pp. 106–120.
- Bationo A and Mokwunye A U. 1991. Role of manures and crop residues in alleviating soil fertility constraints to crop production: With special reference to the Sahelian and Sudanian zones of West Africa. *Fertilizer Research* 29:117–125.
- Bationo A, Christianson C B and Mokwunye U. 1989. Soil fertility management of the pearl millet producing sandy soils of Sahelian West Africa: The Niger experience. In: Renard C, Van Den Beldt R J and Parr J F (eds), *Soil, crop, and water management systems in the Sudano-Sahelian zone*. Proceedings of an international workshop, ICRISAT Sahelian Center, Niamey, Niger, 11–16 January 1987. ICRISAT (International Crops Research Institute for the Semi-Arid Tropics), Patancheru, Andhra Pradesh, India. pp. 159–168.
- Bationo A, Baethgen W E, Christianson C B and Mokwunye A U. 1991. Comparison of five soil testing methods to establish phosphorus sufficiency levels in soil fertilized with water-soluble and sparingly soluble-P sources. *Fertilizer Research* 28:271–279.
- Bationo A, Christianson C B and Klajj M C. 1993. The effect of crop residues and fertilizer use on pearl millet yields in Niger. *Fertilizer Research* 34:251–258.
- Berger M, Belem P C, Dakoua D and Hien V. 1987. Le maintien de la fertilité des sols dans l'Ouest du Burkina Faso et la nécessité de l'association agriculture-élevage. *Cot. Fib. Trop.* Vol. XLII FASC. 3:210–211.
- Breman H and Traoré N (eds). 1986. Analyses des conditions de l'élevage et propositions de politiques et de programmes. République du Niger. Sahel D. (86) 284, Club du Sahel/CILSS/OCDE, Paris.
- Bunt J S and Rovira A O. 1955. Microbiological studies of some Antarctic Soils. *Journal of Soil Science* 6:119–128.
- Burgos-Leon, W. 1979. Allelopathie induite par la culture du sorgho, origine et détoxification microbienne du sol. Thèse doctorat des Sciences, Université de Nancy I. 120 pp.
- Charreau C and Nicou R. 1971. L'amélioration du profil cultural dans les sols sableux et sablo-argileux de la zone tropicale sèche ouest-africaine et ses incidences agronomiques. *Agronomie Tropicale* 26:903–978; 1184–1247.
- Charreau C and Poulain J. 1964. Manuring of millet and sorghum. *Agricultural Soils* 9:177–191.
- Cissé L and Vachaud G. 1987. Effet d'un amendement organique sur l'infiltration, les coefficients de transferts hydriques, et l'évaporation d'un sol sableux dégradé du Nord Sénégal. *Hydro. Continent* 2:14–28.
- Dobereiner J. 1978. Influence of environmental factors on the occurrence of *S. Lipoferum* in soil and roots. Environmental bacteria. *Ecological Bulletins (Stockholm)* 26:343–352.

- Elliot L F, McCalla T M and Waiss J R A. 1979. Phytotoxicity associated with residues management. In: Oschwald W R (ed), *Crop residues management systems*. ASA Special Publication 31. ASA (American Society of Agronomy), Madison, Wisconsin, USA.
- Geiger S C, Manu A and Bationo A. 1992. Changes in a sandy Sahelian soil following crop residues and fertilizer additions. *Soil Science Society of America Journal* 56:172–176.
- Gerdemann J W and Nicolson T H. 1963. Spores of mycorrhizal endogone species extracted from soil by wet sieving. *Transactions of the British Mycological Society* 46:234–235.
- Hafner H, Bley J, Bationo A, Martin P and Marschner H. 1993a. Long-term nitrogen balance for pearl millet (*Pennisetum glaucum* L.) in an acid sandy soil of Niger. *Zeitschrift fuer Pflanzenernaehrung und Bodenkunde* 156:164–176.
- Hafner H, George E, Bationo A and Marschner H. 1993b. Effect of crop residues on root growth and nutrient acquisition of pearl millet in an acid sandy soil in Niger. *Plant and Soil* 150:117–127.
- ICRISAT (International Crop Research Institute for the Semi-Arid Tropics). 1993. *Annual report 1992*. ICRISAT Sahelian Center, Niamey, Niger.
- Jones M J. 1976. The significance of crop residues to the maintenance of fertility under continuous cultivation at Samaru, Nigeria. *Journal of Agricultural Science (Cambridge)* 86:117–125.
- Kretschmar R M, Hafner H, Bationo A and Marschner H. 1991. Long and short-term of crop residues on aluminum toxicity, phosphorus availability and growth of pearl millet in an acid sandy soil. *Plant and Soil* 136:215–223.
- Lamers J P A and Feil P. 1993. The many uses of millet residues. *ILEIA Newsletter* 9(3):15. ILEIA (Information Centre for Low-External-Input and Sustainable Agriculture), Lensen, The Netherlands.
- Langmuir I. 1918. The absorption of gases on plain surface of glass, mic and platinum. *Journal of the American Chemistry Society* 40:1361–1403.
- Larson W E, Holt R F and Carlson C W. 1979. Residues for soil conservation in crop residues management systems. In: Oschwald W R (ed), *Crop residues management systems*. ASA Special publication 31. ASA (American Society of Agronomy), Madison, Wisconsin, USA.
- Lompo F. 1983. Problématique de la matière organique dans la zone du plateau Mossi. Etude de la disponibilité des résidus culturaux et de leur mode de transformation. Mémoire de fin d'études. ISP/Université de Ouagadougou, Burkina Faso. 108 pp.
- McIntire J and Fussell L K. 1986. *On-farm experiments with millet in Niger. III. Yields and economic analyses*. ISC (ICRISAT Sahelian Centre), Niamey, Niger. (limited distribution).
- Michels K, Sivakumar M V K and Allison B E. 1993. Wind erosion in the southern Sahelian zone and induced constraints to pearl millet production. *Agricultural and Forest Meteorology* 67:65–77.
- Mokwunye U A. 1981. Phosphorus fertilizers in Nigerian savannah soils. III. Effect of three phosphorus sources on available cations of a soil at Samaru. *Samaru Journal of Agricultural Research* 6:21–24.
- Mokwunye U A, Chien S H and Rhodes E. 1986. Phosphate reactions with tropical African soils. In: Mokwunye U A and Vlek P L G (eds), *Management of nitrogen and phosphorus fertilizers in sub-Saharan Africa*. Proceedings of a symposium held in Lomé, Togo, 25–28 March 1985. Kluwer Academic Publishers, Dordrecht, The Netherlands. pp. 253–281.
- Pichot J, Sedogo M P, Poulain J L and Arrirets J. 1981. Evolution de la fertilité d'un sol ferrugineux sous l'influence de fumures minérales et organiques. *Agronomie Tropicale* 36:122–133.
- Pieri C. 1986. Fertilisation des cultures vivrières et fertilité des sols en agriculture paysanne subsaharienne. *Agronomie Tropicale* 41:1–20.
- Pieri C. 1989. Fertilité des terres de savanes. Bilan de trente ans de recherche et de développement au sud du Sahara. Agri. doc. International, Paris, France.
- Powell J M. 1985. Yields of sorghum and millet and stover consumption of livestock in Nigeria. *Tropical Agriculture (Trinidad)* 62(1):77–81.

- Powell J M and Williams T O. 1993. *Livestock, nutrient cycling and sustainable agriculture in the West African Sahel*. Gatekeeper Series SA37. Sustainable Agriculture Programme, IIED (International Institute for Environment and Development), London, UK. 15 pp.
- Powell J M, Kouamé C and Brouwer J. 1991. Nutrient cycling in mixed farming systems in the Sahel of West Africa. In: *Proceedings of the workshop on Evaluation of Sustainable Land Management in the Developing World, Chaing Rai, Thailand, 15–21 September 1991*. IBSRAM (International Board for Soil Research and Management), Bangkok, Thailand.
- Rebafka F P, Hebel A, Bationo A, Stahr K and Marschner H. 1994. Short- and long-term effects of crop residue application on pearl millet (*Pennisetum glaucum* (L.) R. Br.) yield on an acid sandy soil in Niger, West Africa. *Field Crops Research* (in press).
- de Ridder N and Van Keulen H. 1990. Some aspects of the role of organic matter in sustainable intensified arable farming systems in the West African semi-arid tropics (SAT). *Fertilizer Research* 26:299–310.
- Sandford S G. 1989. Crop residue/livestock relationships. In: Renard C, Van Den Beldt R J and Parr J F (eds), *Soil, crop, and water management systems in the Sudano-Sahelian Zone*. Proceedings of an international workshop, ICRISAT Sahelian Center, Niamey, Niger, 11–16 January 1987. ICRISAT (International Crops Research Institute for the Semi-Arid Tropics), Patancheru, Andhra Pradesh, India.
- Sedogo M P. 1981. Contribution à l'étude de la valorisation des résidus culturaux en sol ferrugineux et sous climat tropical semi-aride. Matière organique du sol, nutrition azotée des cultures. Thèse Docteur-ingénieur, INPL Nancy, 135 pp.
- Segda Z. 1991. Contribution à la valorisation agricole des résidus de culture dans le plateau central du Burkina Faso. Inventaire des disponibilités en matière organique et étude des effets de l'inoculum, micro 110 IBF, Mémoire d'ingénieur des sciences appliquées, IPDR/Katibougou, 100 pp.
- Stahr K, Bleich K E, Hebel A and Herrmann L. 1993. The influence of organic matter and dust deposition on site characteristics and their microvariability. TP A1. Universität Hohenheim. In: University of Hohenheim (ed), *Standortgemäß e Landwirtschaft in Westafrika — SFB 308. Arbeits und Ergebnisbericht (Zwischenbericht 1991–1993)*. pp. 25–58).
- Tien T M, Gaskins M H and D H Hubbell. 1979. Plant growth substances produced by *Azospirillum brasiliense* and their effect on the growth of pearl millet (*Pennisetum americanum* L.). *Applied Environmental Microbiology* 37:1016–1024.
- Van Raay J G T and de Leeuw P N. 1971. *The importance of crop residues as fodder: A resource analysis in Katsina Province, Nigeria*. Samaru Research Bulletin 139. Ahmadu Bello University, Samaru, Zaria, Nigeria. 11 pp.
- Vierich H I D and Stoop W A. 1990. Changes in West African savannah agriculture in response to growing population and continuing low rainfall. *Agriculture, Ecosystems and Environment* 31:115–132.

# Nitrogen in dryland farming systems common in north-western Syria

H.C. Harris, J. Ryan, T.T. Treacher and A. Matar

International Center for Agricultural Research in the Dry Areas (ICARDA)  
P O Box 5466, Aleppo, Syria

## Abstract

Farming systems in West Asia–North Africa involve rotations of cereals with fallow or food/forage legume crops depending on location and rainfall. Barley (*Hordeum vulgare* L.) tends to dominate in the drier zones and bread (*Triticum aestivum* L.) and durum (*T. turgidum* L. var *durum*) wheat in the more favourable areas. Sheep and goats are integral parts of the systems, particularly those dominated by barley. The International Center for Agricultural Research in the Dry Areas (ICARDA) is developing improved cultivars and management practices, and needs to critically examine several systems in terms of efficiency, costs and sustainability. Therefore, a long-term trial was established in 1983/84 at ICARDA's main research station at Tel Hadya, near Aleppo in northern Syria, to evaluate the productivity of systems in which durum wheat is rotated with vetch (*Vicia sativa* L.), lentil (*Lens culinaris* Medik.), chickpea (*Cicer arietinum* L.), medic (*Medicago* spp) pasture, wheat, water-melon (*Citrullus vulgaris* L.), and fallow. Varying nitrogen (N) levels (0, 30, 60, 90 kg/ha) and intensities of grazing stubble (heavy, moderate, none) were imposed on the wheat phase. Both the wheat and the alternative phase were included each year. While seasonal rainfall, which ranged from 210 to 486 mm, and residual soil moisture after the alternate phase dictated the magnitude of wheat yields, N increased water-use efficiency. Soil N levels (mineral and total) varied with the system and were highest for medic and least for wheat and fallow. Similar differences were evident for organic matter (OM), which also tended to increase with increasing N level. The concentration of N in grain and straw as well as total N uptake varied with the rotation and crop yield. Though the trial needs to continue for several more years, the impact of some crops (i.e. medic) on soil quality is already apparent.

## L'azote dans les systèmes de cultures sèches fréquents dans le nord-est de la Syrie

H.C. Harris, J. Ryan, T.T. Treacher et A. Matar

Centre international de recherche agricole dans les zones arides (ICARDA)  
P.O. Box 5466, Alep (Syrie)

## Résumé

Les systèmes agricoles de l'Asie de l'Ouest et de l'Afrique du Nord pratiquent des rotations de céréales soit avec des jachères, soit avec des cultures de légumineuses vivrières/fourragères en fonction de la situation géographique et de la pluviosité. L'orge (*Hordeum vulgare* L.) domine généralement dans les régions sèches tandis que le blé ordinaire (*Triticum aestivum*) et le blé dur (*T. turgidum* L. var. *durum*) sont plus fréquents dans les zones à climat plus doux.

Les ovins et caprins font partie intégrante de ces systèmes, notamment ceux dominés par l'orge. Le Centre international de recherche agricole dans les zones arides (ICARDA) est actuellement en train de développer des cultivars et des méthodes de gestion améliorées et doit par conséquent procéder à une évaluation critique de plusieurs systèmes en termes d'efficacité, de coût et de viabilité. C'est ainsi qu'un essai de longue durée a été mis en place en 1983/84 à la station principale de recherche de l'ICARDA à Tel Hadya près d'Alep dans le nord de la Syrie. Cet essai a pour objectif d'évaluer la productivité de systèmes dans lesquels le blé dur est cultivé en rotation avec des vesces

(*Vicia sativa* L.), des lentilles (*Lens culinaris* Medik.), des pois chiches (*Cicer arietinum* L.), des pâturages de luzerne (*Medicago* sp.), du blé, des pastèques (*Citrullus vulgaris* L.) et des jachères. Diverses doses d'azote (0, 30, 60 et 90 kg/ha) et différentes intensités de pâturage du chaume (intensité élevée, moyenne et nulle) ont été utilisées pour le blé. La phase du blé et la phase alternative étaient exécutées chaque année. Bien que les rendements du blé dépendent de la pluviométrie, laquelle allait de 210 à 486 mm, et de l'humidité résiduelle du sol, l'azote augmentait l'efficacité de l'utilisation de l'eau. Les taux d'azote (azote minéral et total) dépendaient du système et étaient maximums avec la luzerne et minimums avec le blé et la jachère. Des différences similaires ont été observées pour la matière organique dont le niveau tendait à augmenter avec l'accroissement de la dose d'azote. La teneur en azote des graines et de la paille et les quantités totales d'azote exportées dépendaient du type de rotation et des rendements des cultures. Bien que ces essais doivent continuer encore plusieurs années, l'effet de certaines cultures (ex. la luzerne) sur la qualité du sol est d'ores et déjà apparent.

## Introduction

Concern about providing sufficient food for the world's burgeoning population is an ever-present one. The prospects for the Mediterranean area of West Asia and North Africa (WANA) being able to come close to self-sufficiency are gloomy indeed (Oram, 1988). This region is largely characterised by highly seasonal rainfall, which is low and often erratically distributed. While irrigation has increased in extent, opportunities for further expansion are very limited. The farming systems of the region are, and will remain, predominantly rainfed cropping in association with small ruminants, i.e. sheep and goats. Barley, bread wheat and durum wheat are the principal crops. These are grown in the "wet" period (October to May/June), in rotation with fallow and/or food or forage legumes (Cooper and Gregory, 1987) but are increasingly cropped continuously. As rainfall, and therefore soil moisture, is invariably the most limiting factor in crop production (Cooper et al, 1987), the greatest challenge is to improve water-use efficiency. Research in the region has shown that nitrogen (N) (Harmsen, 1984; Ryan and Matar, 1992) and, especially in drier areas, phosphorus (P) can contribute to increased yields and more efficient use of water (Cooper, 1983; Matar et al, 1992).

Livestock, principally sheep and goats, are an integral part of the systems, providing a buffer against income fluctuations due to the season-to-season variability in crop yields. They also provide a substantial proportion of the dietary protein of farm families in the form of milk, cheese and yoghurt (Mokbel, 1985). The barley-dominated systems of the drier areas are essentially livestock production systems in which barley, either as a green crop, or stubble, or stored straw and grain, constitutes the major feed source. In the wetter areas, sources of income and feed are more diverse, but wheat residues provide grazing for both resident and transhumant flocks of small ruminants.

The systems approach to agricultural research adopted by ICARDA has centred its attention on the potential benefits of integrating common rotations, N fertilisation, and grazing management. Detailed description of the various kinds of rotations in the Mediterranean area are found elsewhere (Harris et al, 1991). To evaluate new or adapted technologies within the farming systems that ICARDA deals with requires long-term trials. Such trials are costly, require relatively large land areas and expert and consistent management, and must be run for many years to detect meaningful differences in soil properties, or validly assess the economic benefits of the system being studied. Few regional institutions can meet such criteria. It is hoped that this long-term trial by the International Center for Agricultural Research in the Dry Areas (ICARDA) will provide some answers on issues of sustainability of relevance to north-west Syria, and serve as a model for the entire Mediterranean region.

## Materials and methods

A two-course rotation trial with seven crop sequences was established in 1983–84 in Tel Hadya on land that had been cropped in cereal-based rotations since 1978. The 23 ha-site is gently sloping, while

the depth of the soil, a Calcixerollic Xerochrept, ranges between 1 to 2 m, with a few shallower patches. The cropping sequences were durum wheat following: fallow (W/F), summer crop, i.e. water-melon (W/S), lentil (W/L), chickpea (W/C), vetch (W/V), medic (W/M), and wheat (W/W). These were replicated three times, and both phases of the rotations were included each year. The individual plot size was 0.54 ha; each rotation therefore covered 3.24 ha.

In the first two years no inputs were used, but from the 1985–86 season onwards fertiliser was added, weed, pest and disease control measures were applied, and improved cultivars introduced. Two ancillary treatments were superimposed in a split-strip plot design. Four N levels (0, 30, 60, and 90 kg N/ha) are applied to subplots in the wheat phase to assess the long-term reliability of N responses and to evaluate the capability of the legumes to supply N to the systems. The wheat stubble was subjected to three management treatments: heavy grazing, moderate grazing, and no grazing or stubble retention, which formed the sub-sub-plots.

## Trial management

### Tillage and planting

Since 1987–88, primary tillage in the wheat phase has been carried out with a tyned cultivator after the first rain of the season and followed by a pass with a spike-toothed harrow for seed-bed preparation. In the first two seasons (1985–86 and 1986–87), the traditional planting method of broadcasting seed on to ridged land and covering it by splitting the ridges was used. However, since 1987, seed has been drilled — wheat with a locally built seed drill at 17.5-cm row spacing following seed-bed preparation as above, and other crops (vetch, lentil, chickpea and wheat in the alternate phase) with a zero-till planter directly into wheat stubble at 30-cm row spacing. Medic seed was broadcast in 1983 and 1984, and now pastures regenerate annually. Water-melon is established as single plants on a 3 x 3 m grid according to local practice. Wheat and the legumes are normally planted in the second half of November and early December, respectively, following the initial rains. Water-melon is sown in mid-April on land that is fallowed to that time, providing the soil is wet to a depth of 1 m. Seed rates are: chickpea and vetch, 120 kg/ha; wheat and lentil, 100 kg/ha; and melon, 1.5 kg/ha.

### Cultivars

The improved durum wheat, Cham 1, has been used throughout the trial. A cold-tolerant chickpea cultivar, ILC 482, with tolerance for *Aschochyta* blight (*Aschochyta rabiei* (Pass.) Lab.), released in Syria as Ghab 1, was selected for early sowing. It was replaced in 1991–92 by Ghab 2. Syrian local small lentil, used for the first two years, was replaced by a newly released cultivar, Idleb, in 1987–88. The vetch and water-melon are both locally used strains. A mixture of medic seed (48 ecotypes of 12 species) was originally sown at 30 kg/ha, with the objective of studying the species population dynamics under grazing. The pastures are now dominated by local ecotypes of *M. polymorpha* (L.), *M. noeana* (L.) All., and *M. rigidula* Boiss., but most species have survived and are represented in the swards (Cocks, 1992).

### Fertiliser

Phosphate fertiliser was broadcast over the whole area in the first two years at 26 and 39 kg P/ha, respectively, to raise the fertility level. It is now drilled with the wheat at 22 kg P/ha. The N is hand-broadcast, half at planting and the remainder at the tillering stage of wheat growth.

### Crop protection

Weeds are controlled in the crops by the use of appropriate pre- or post-emergence herbicides, while fallows are maintained weed-free by a combination of cultivation and herbicides. Grazing normally

provides adequate weed control in the vetch and the medic pastures. Diseases, insects and rodents are controlled by routine seed dressing, and strategic use of chemicals when necessary.

### **Grazing management**

As is the practice in the farming systems of the region, the sheep graze from approximately 0700 to 1730 hours each day and are housed overnight. Medic pastures are grazed throughout the year for as long as they will support 8 to 10 ewes (and lambs) per hectare. Vetch is used as a high-quality feed source for weaner lambs in the spring and is grazed at 25–30 head/ha. Wheat stubble is grazed by temporarily fencing subplots and introducing a large flock (400 to 600 head/ha) for one or two days.

### **Yield determination**

Approximately 20% of the area of wheat and chickpea is harvested with a plot combine to determine grain yield, usually in early June. The harvest index is estimated from 5 x 1-m row samples per sub-sub-plot and total dry matter and residue yields are estimated from the grain yield and the harvest index. The same proportion of lentil plots is hand-harvested (late April/early May), dried and threshed, and seed and residue yields are measured. The 'yield' of the vetch and of medic pastures is estimated as grazing days per year (number of days x stocking rate) and as animal products, lamb liveweight gain and milk yield.

### **Seasonal conditions**

Total season rainfall in the first two years (1985–87) was close to the long-term average (330 mm), i.e. 326 and 333 mm, respectively. The following year, 1987–88, had the highest rainfall (486 mm) while both 1988–89 and 1989–90 were exceptionally dry with only 235 and 221 mm, respectively. The last two years, 1990–92, had 286 and 327 mm, respectively. These seasonal amounts cover a large part of the range shown in the historical record for the area. Most years were characterised by erratic rainfall distribution; 1991–92 was extremely cold with several snowfalls.

### **Soil and plant analysis**

The soil has been sampled more or less on a yearly basis since 1989. That year, five surface samples (0–20 cm) were taken from each sub-sub-plot, bulked and analysed for nitrate (NO<sub>3</sub>), mineral N, and total N (Black et al, 1965). In addition, selected plots were sampled in 20-cm increments to 1 m, i.e. heavily grazed plots with 0 and 90 kg N/ha applied in the wheat phase in the W/F, W/C and W/M rotations. Detailed soil moisture measurements were made on these plots; OM was also measured on the soil samples. After harvest, both grain and straw were analysed for N.

## **Results and discussion**

### **Crop production**

While this paper focuses on aspects of N and OM associated with the trial, a brief overview of the general trends for yield are pertinent. Details are presented in annual reports (ICARDA, 1990; 1991; 1993). A dominant feature has been the inter-annual variation in yields due to varying rainfall. For example, mean wheat grain yield ranged from 0.83 t/ha in a dry year (1988/89, 235 mm) to 3.62 t/ha in a wet year (1987/88, 486 mm). In 1987/88 potential yields of 4.5 to 5.0 t/ha were achieved by adequate N fertilisation.

Crop sequence has a strong and consistent effect on wheat total biomass and grain yields. The ranking, according to the preceding phase, is wheat ≤ medic = chickpea < vetch = lentil < melon = fallow, which largely reflects residual soil moisture after the preceding phase. This trend is illustrated

in Table 1 where grain yields are expressed as a proportion of those after fallow. There is little evidence that legumes contribute significant amounts of N to the cereal phase, except that wheat after medic shows no N deficiency at tillering, whereas deficiency symptoms are usually visible in all other sequences at zero and low N levels. With some exceptions, there is a response to 30 kg N/ha. The exceptions include a response to 90 kg N/ha in the wet year, 1987–88, and to 60 kg/ha in the rotations with fallow, both related to a greater availability of soil moisture, and no response in dry years. Another exception is that after the third cycle of medic pasture the wheat grain yield without N fertiliser has equalled that where 30 kg/ha N was applied.

**Table 1.** Grain yield of wheat in six rotations as a proportion of the yield after fallow.

Year	Crop rotation <sup>1</sup>					
	W/W	W/L	W/C	W/S	W/V	W/M
1986	0.54	0.79	0.78	1.05	0.83	0.51
1987	0.53	0.86	0.70	1.02	0.84	0.61
1988	0.21	0.95	0.71	0.88	0.96	0.79
1989	0.23	0.56	0.29	0.61	0.61	0.31
1990	0.58	0.69	0.70	1.12	0.70	0.76
1991	0.71	0.88	0.81	1.10	0.86	0.88
1992	0.81	0.89	0.81	0.93	0.83	0.83

1. W = wheat; F = fallow; L = lentil; C = chickpea; S = water-melon; V = vetch; M = medic.

The productivity of vetch as forage and medic pastures is measured as grazing days and livestock production (Table 2). Over the seven years vetch provided, on average, 1556 grazing days/ha per year (range 860 to 2212) and an average lamb liveweight gain of 293 kg/ha. Medic pastures supported 1230 (range 456 to 2850) ewe grazing days/ha per year plus, in five of the seven years, an average of 504/ha for lambs. Lamb liveweight gains were 143 kg/ha, and the ewes gave 119 kg/ha of milk after the lambs were weaned.

**Table 2.** Grazing days, lamb liveweight gain and milk yield from medic pastures and forage vetch.

Season	Grazing days			Liveweight gain of lambs		
	Medic		Vetch	Medic	Vetch	Milk yield
	Ewes	Lambs	Lambs	kg/ha		
days/ha						
1985–86	456	–	2212	–	292	–
1986–87	1410	–	2044	–	331	–
1987–88	2850	980	1510	258	261	200
1988–89	1650	448	1270	113	246	130
1989–90	776	352	860	109	219	296
1990–91	648	424	1320	112	231	60
1991–92	1470	770	1645	262	403	146
1992–93	603	556	1587	150	262	0



It is difficult to evaluate the role of the grazed systems. Most feed is provided in spring when animals normally graze common or open-access areas, which everywhere are heavily overstocked and degraded. Concentrates are often fed to supplement diets. In Syria, these are comprised of barley grain and subsidised by-products of industrial crops such as cottonseed cake, sugar-beet pulp and bran, but in other countries and economies neither the by-products nor subsidies are necessarily available. An analysis of the economics of rotations based on data from a different trial on Tel Hadya (Nordblom et al, 1992) concluded that, in Syria, it is only when farm size is large (64 ha in the example) and/or labour costs are high that medic pastures become economically viable. However, the pastures in the trial on which that analysis was based supported fewer grazing days than has been recorded in the current trial, so that conclusion may need to be modified. No economic evaluation of the grazed vetch system has yet been done, but this management was used in the current trial because local farmers involved in on-farm testing of barley-legume systems in the drier areas identified fattening of weaner lambs in spring as a potentially valuable innovation (Thomson and Oglah, 1988).

A further imponderable in the evaluation of both systems is the potential benefit of reduction of the grazing pressure on open-access areas provided by an alternative feed source. Degradation of vegetation in these areas is leading, we believe, to escalating soil erosion, with long-term consequences that need no emphasis. We see medic and vetch replacing fallow, or being used as break crops in systems where continuous cereal culture is creating serious insect and disease problems. If they can be introduced, they have the potential to provide benefits to the systems of the area to which it is not easy to attach monetary value.

### Soil water

It is of relevance to note that during the seven years the soil profile was only fully wetted in 1987/88, and in other years the maximum depth of the wetting front scarcely exceeded 1 m. A small amount of drainage took place from the fallow plots in the wet year, but otherwise no leaching of nutrients beyond the root zone would have occurred.

### Soil nitrogen

While the two-course, wheat-based rotation has been described in detail before (ICARDA, 1990; 1993), reporting of soil and crop N status has been limited to preliminary data obtained for the first time in 1989 (ICARDA, 1991). Since then we have had limited sampling of the plots in 1990 and a complete sampling in 1991. This included determination of mineral N ( $\text{NO}_3 + \text{NH}_4$ ), and total N, i.e. Kjeldahl-N, which accounts mainly for the soil organic N fraction, normally the largest one.

Mineral N concentration was consistently greatest in the medic rotation, while wheat after wheat or lentil tended to have the lowest values (Table 3). Few differences were apparent between the other rotations. The same trend was evident when measurements were made after each phase, i.e. wheat or alternative crops (Table 4). The impact of N fertilisation was consistent after the wheat phase, but less obvious after the unfertilised alternative phase (Table 5). The data reflect residual fertiliser N after the wheat phase, but this was apparently used by the alternative phase crops or, more likely, incorporated into soil organic forms.

**Table 3.** *Topsoil (0–20 cm) mineral nitrogen concentration with rotations.*

Year	Crop rotation <sup>1</sup>							SE	n
	W/F	W/W	W/L	W/C	W/S	W/V	W/M		
1989	10.2	9.9	9.7	9.8	11.1	11.9	15.8	0.69	48
1990	9.5			10.3			11.0	1.04	16
1991	10.6	7.9	8.3	10.4	10.4	10.3	14.9	0.88	48

1. W = wheat; F = fallow; L = lentil; C = chickpea; S = water-melon; V = vetch; M = medic.

**Table 4.** Topsoil (0–20 cm) mineral nitrogen concentration in two rotation phases.

Year	Phase	Crop rotation <sup>1</sup>							SE	n
		W/F	W/W	W/L	W/C	W/S	W/V	W/M		
1989	'Legumes'	10.6	7.4	7.6	7.0	11.8	10.2	12.4	0.977	24
	Wheat	9.8	12.4	11.7	12.6	10.4	13.5	19.2		
	SE	1.48								
1991	'Legumes'	12.7	6.6	7.2	7.3	12.1	10.1	13.7	1.249	24
	Wheat	8.6	9.2	9.4	13.4	8.8	10.4	16.0		
	SE	1.156								

1. W = wheat; F = fallow; L = lentil; C = chickpea; S = water-melon; V = vetch; M = medic.

**Table 5.** Topsoil (0–20 cm) mineral nitrogen concentration in two rotation phases.

Year	Phase	Fertiliser N applied (kg/ha)				SE	n
		0	30	60	90		
1989	'Legumes'	8.34	8.45	10.63	10.95	0.830	42
	Wheat	6.12	7.30	14.10	23.70		
	SE	1.378					
1990	'Legumes'	9.1			12.5	1.237	12
	Wheat	7.2			12.3		
	SE	0.935					
1991	'Legumes'	8.36	10.34	9.86	11.36	0.724	42
	Wheat	6.16	7.43	11.55	18.18		
	SE	0.627					

As organic-N is the dominant N fraction in soils, total soil N is an important observation. Again, the rotation with medics had significantly enriched soil N contents compared with wheat after either fallow, summer crop or wheat, none of which added to soil N (Table 6). Total N values for the other N-fixing crops, vetch, chickpea and lentil, exceeded those where no legume was present, but whether this represents N enrichment or N saving is not yet clear. When the rotation effect was separated into phases, soil N values were consistently higher after the alternative crops. Fertilisation at the 60 and 90 kg N/ha rates tended to increase total N values also. This can be explained in relation to crop yield. The initial increment of N produced a proportionally larger yield response and was completely taken up by the crop; additional increments had less effect on yield and the unused N remained in the soils as residual N. The low rainfall of 1988–89 and 1989–90 exaggerated the effect.

**Table 6.** *Topsoil (0–20 cm) total nitrogen concentration with rotations.*

Year	Crop rotation <sup>1</sup>							SE	n
	W/F	W/W	W/L	W/C	W/S	W/V	W/M		
1989	686	698	737	716	668	739	806	10.5	48
1990	697			737			812	26.6	16
1991	688	678	718	696	651	738	792	12.8	48

1. W = wheat; F = fallow; L = lentil; C = chickpea; S = water-melon; V = vetch; M = medic.

Data for mineral N from the first sampling (November 1989) indicated that the fertilised plots (90 kg N/ha) had the most residual N in the profile, while values after wheat were higher in the chickpea and medic plots. Wheat in the latter rotations was most severely affected by the prevailing drought and clearly was unable to use available N because of lack of water. In the alternate phase, there was little difference between the rotations, with fallow, as might be expected, having somewhat more than the rest. In all cases, the greatest mineral N concentration was in the top 0–20 cm and decreased with depth. As yet there has been no effect of intensity of stubble grazing on soil N.

### Organic matter

Top-soil OM contents are presented in Table 7 as a function of the overall effect of the differing rotations and in Table 8 as a function of the mean N effect over all rotations and phases. In theory, the process of inducing OM changes by varying management is relatively slow. However, there was evidence that some differences had arisen since the trial began. Notwithstanding the limited sampling in 1990, there was a general consistency in the available data for the three years under consideration.

**Table 7.** *Organic matter in the top 20 cm of soil with rotations.*

Year	Crop rotation <sup>1</sup>							SE	n
	W/F	W/W	W/L	W/C	W/S	W/V	W/M		
1989	1.03	1.05	1.12	1.09	1.02	1.13	1.26	0.019	48
1990	1.00			1.11			1.22	0.038	16
1991	1.03	1.05	1.09	1.07	1.02	1.14	1.21	0.022	48

1. W = wheat; F = fallow; L = lentil; C = chickpea; S = water-melon; V = vetch; M = medic.

When the crop rotations were considered, it was clear that the lowest values were associated with wheat after wheat, fallow or summer crop. Among rotations that include legumes, that with medics produced the highest OM content, followed by rotations with vetch, chickpea, and lentil which were similar. Reasons for this pattern are complex. More mineralisation of OM might be expected in the fallow and water-melon phases, due to greater availability of water. Accumulation with medic pasture could arise from inefficient use of dry matter due to trampling and soilage during grazing, deposition

of some 400 kg/ha per year of dung (calculated from Tables 1 and 2 in White et al (this volume), and the number of grazing days per year), and an extensive root system which measurements of soil water indicate is a characteristic of medic.

Nonetheless, these do not appear to satisfactorily explain the difference between the rotations with medic and the other legumes. The input during grazing of vetch could be expected to be much the same as that from medic, as total grazing days were similar in both rotations. Vetch does, however, have a sparser root system. Chickpea, on the other hand, has an extensive root system and all crop residues are returned during harvest. Lentil resembles vetch in having a small root system and all above-ground biomass is taken at harvest. In the other phase of the rotations, wheat after lentil and vetch produces more above-ground biomass, and thus presumably more roots, than wheat following medic or chickpea. The dynamics of the changes are obviously complex and basic studies of carbon and N cycling are needed to elucidate them. An interesting feature of the data (Table 8) was the apparent increase in OM content with increasing N application rate. This is probably attributable to enhanced root growth from the applied N, an hypothesis supported by data on water use which show greater drying of the soil profile by fertilised crops.

**Table 8.** Organic matter in the top 20 cm of soil with nitrogen fertilisation.

Year	Fertiliser N applied (kg/ha)				SE	n
	0	30	60	90		
1989	1.06	1.07	1.12	1.14	0.016	84
1990	1.06			1.16	0.012	24
1991	1.05	1.08	1.11	1.11	0.015	84

## Plant nitrogen

The soil N supply, whether from fertiliser or biological fixation, has an effect on both yield and the N content of the biomass of wheat (Tables 9 and 10). Higher N concentrations indicate higher grain protein contents and nutritional value, and improved straw quality. Inter-seasonal variation in the concentration arises from variations in the rainfall and, in 1989 and 1990 in particular, most crops, except those after fallow and water-melon, were severely drought-stressed. The N concentrations in wheat straw tended to be greatest in the medic and, to a lesser degree, the chickpea and vetch rotations; lower values tended to be associated with the fallow and summer crop rotations (Table 9). The trends were more evident with straw than with grain, which is in part due to moderate to severe drought in the first three of the four years. As the N supply in the soil is diluted in plant biomass, the N concentration and yield tend to be inversely related. The N supply is more clearly seen by an integration of concentration and yield, i.e. N uptake or export (Table 10).

If soil N dynamics were not influenced by crop rotation, N uptake values would be inversely proportional to yield. However, this was not the case; the discrepancy between yield and N uptake data indicates a contribution of the legumes in the rotation to the N supply. For example in the 1988–89 season, the highest yield from the fallow rotation exceeded that with medics more than threefold, while N uptake exceeded the value only twofold. Therefore, while N fixation by legumes contributed to N build-up in the soil, the overriding factor dictating crop yield was soil moisture.

**Table 9.** Nitrogen percentage in wheat grain and straw with rotations.

Year	Crop rotation <sup>1</sup>							SE	n
	W/F	W/W	W/L	W/C	W/S	W/V	W/M		
	----- % -----								
<b>Grain</b>									
1989	2.29	3.04	2.66	3.09	2.54	3.07	3.70	0.107	24
1990	2.13	2.63	2.58	2.55	1.95	2.57	3.10	0.083	36
1991	2.61	2.45	3.04	3.31	2.73	3.27	3.74	0.059	36
1992	1.91	1.85	2.04	1.89	1.82	2.09	2.48	0.058	36
<b>Straw</b>									
1989	0.39	0.83	0.63	0.77	0.47	0.71	1.45	0.050	24
1990	0.45	0.72	0.64	0.64	0.37	0.63	0.89	0.056	36
1991	0.49	0.45	0.63	0.82	0.51	0.72	0.94	0.029	36
1992	0.36	0.39	0.40	0.37	0.36	0.41	0.51	0.020	36

1. W = wheat; F = fallow; L = lentil; C = chickpea; S = water-melon; V = vetch; M = medic.

In terms of sustainability of the systems it is interesting to examine data from plots where no N was applied (Tables 11 and 12). In both grain and straw, the N concentration was consistently greater after medic, but the trend among the remaining rotations was less clear. In 1991 and 1992, when the total biomass was most similar amongst the rotations (Table 1), uptake of N was at least 25% more from the medic plots than from the other rotations, and was two or three times greater than from wheat monoculture (Table 12). The low input ley system thus appears to provide sufficient N to raise grain protein levels by several percentage points and to enhance straw protein levels, the latter being a significant factor in this environment where straw and stubble are major feed sources for chronically N-deficient livestock. The uncertainty, illustrated by data from the first two years, is whether there will be sufficient rainfall to allow the N provided by the legume to be harvested in the cereal phase.

**Table 10.** Nitrogen in above-ground biomass of wheat with rotations.

Year	Crop rotation <sup>1</sup>							SE	n
	W/F	W/W	W/L	W/C	W/S	W/V	W/M		
	----- kg/ha -----								
1989	58.5	15.6	38.0	19.7	39.6	41.6	26.7	3.82	24
1990	36.6	27.7	30.1	26.9	41.4	31.0	32.9	1.77	36
1991	60.8	37.7	60.3	55.4	68.4	63.8	71.5	3.39	36
1992	72.3	49.1	64.3	60.8	69.5	67.2	79.4	4.14	36

In the above tables, data for 1989 are based on two of three replicates.

1. W = wheat; F = fallow; L = lentil; C = chickpea; S = water-melon; V = vetch; M = medic.

## Animal grazing behaviour

An observation in 1989 that sheep grazing wheat stubble appeared to select stubble of wheat grown after medic in preference to the stubble of wheat following fallow, was tested by a small trial in 1990 to observe grazing behaviour (Treacher, 1994). Three plots were established: two in which sheep

(67/ha) were confined on either W/F or W/M stubble, and a third where choice of the stubbles was offered. The results, shown in Table 13 as percentages of time for various activities, verified the observation. In the morning grazing period, once the few heads remaining after harvest had been selected, sheep on the W/M plots apparently satisfied their appetites more quickly than those on W/F, while the latter attempted to graze through the fence to the W/M plot. Behaviour was similar in the afternoon period of grazing. Those given the choice of stubbles spent twice as much time grazing the W/M as the W/F area, and within two hours of the start of grazing in the morning all had moved to the W/M part of the plot. These behavioural patterns were expressed too quickly to be due to an influence of the N concentration of the stubbles (Table 8) on rumen activity, so the effect must be one of palatability. In these drought years, the wheat after medic was more severely water stressed than the W/F crop, and may have had elevated concentrations of soluble sugars in the residue.

**Table 11.** Nitrogen percentage in unfertilised wheat grain and straw with rotations.

Year	Crop rotation <sup>1</sup>							SE	n
	W/F	W/W	W/L	W/C	W/S	W/V	W/M		
Grain									
1989	1.95	2.62	2.18	2.72	2.21	2.70	3.52	0.148	6
1990	1.86	2.16	2.02	2.22	1.69	2.07	2.84	0.107	9
1991	2.11	2.28	2.18	2.79	1.97	2.60	3.54	0.160	9
1992	1.58	1.72	1.83	1.64	1.59	1.80	2.12	0.060	9
Straw									
1989	0.30	0.64	0.42	0.54	0.37	0.54	1.02	0.071	6
1990	0.36	0.48	0.41	0.48	0.32	0.42	0.72	0.056	9
1991	0.31	0.33	0.35	0.57	0.30	0.45	0.77	0.041	9
1992	0.30	0.33	0.33	0.32	0.28	0.33	0.39	0.018	9

1. W = wheat; F = fallow; L = lentil; C = chickpea; S = water-melon; V = vetch; M = medic.

**Table 12.** Nitrogen in above-ground biomass of unfertilised wheat with rotations.

Year	Crop rotation <sup>1</sup>							SE	n
	W/F	W/W	W/L	W/C	W/S	W/V	W/M		
1989	39.0	9.3	25.8	13.1	26.2	27.2	24.3	5.53	6
1990	24.2	18.9	19.7	23.4	31.6	20.6	28.7	3.08	9
1991	41.0	20.5	40.5	43.3	43.3	45.8	60.3	3.13	9
1992	45.6	30.0	48.9	40.5	44.6	48.5	65.5	4.59	9

In the above table, data for 1989 are based on two of three replicates.

1. W = wheat; F = fallow; L = lentil; C = chickpea; S = water-melon; V = vetch; M = medic.

**Table 13.** Percentage of time spent by ewes on different grazing activities in morning and afternoon grazing periods in one day when offered different stubbles.

Treatment <sup>1</sup>	0630–1030 hours			1500–1800 hours		
	Grazing	Ruminating	Idling	Grazing	Ruminating	Idling
W/M (confined)	82	18	0	83	13	4
W/F (confined)	92(+3) <sup>2</sup>	5	0	77(+5) <sup>2</sup>	14	4
Choice area W/M	39	32	8	56	0	5
area W/F	21	0	0	28	3	8
Total	60	32	8	84	3	13

1. W/M = wheat/medic; W/F = wheat/fallow.

2. Grazing through fence into plot W/M.

Flocks in WANA are generally mated while they are grazing stubble. Increased intake of stubble may improve the production of the whole system, as better nutrition before mating can increase the proportion of pregnant ewes and the lambing percentage.

## Conclusions

As yet, only the most tentative of generalisations can be made regarding the effect of rotations on soil N and OM. Notwithstanding the dominant effect of soil moisture and the positive influence of fallow and short-season crops on subsequent cereal yield, some effects were already evident after the first sampling. Organic matter appeared to have increased with the medic-cereal rotation. These differences were similar at the second sampling. Where there was no legume in the rotation, OM levels were always lower. The maximum or equilibrium level of OM that can be produced by these rotations in this type of environment and to what extent, if any, such levels influence properties such as aggregation and water-holding capacity will become apparent with time. Preliminary work indicates that this is beginning to happen. The increase in soil N from the medic rotation should benefit the companion cereal crop when moisture is not too limiting. Similarly, the increased cereal grain and straw N content after medic, and therefore improved food and feed nutritional quality, are additional factors, the value of which it is not easy to quantify.

## References

- Black C A, Evans D D, White J L, Ensminger L E and Clark F E. 1965. *Methods of soil analysis. Part 2. Chemical and microbiological properties*. Agronomy 9. American Society of Agronomy, Madison, Wisconsin, USA.
- Cocks P S. 1992. Plant attributes leading to persistence in grazed annual medics (*Medicago* spp.) growing in rotation with wheat. *Australian Journal of Agricultural Research* 43:1559–1570.
- Cooper P J M. 1983. Crop management in rainfed agriculture with special reference to water use efficiency. In: *Proceedings of the 17th Colloquium of the International Potash Institute, Rabat, Morocco, May 1983*. pp. 19–35.
- Cooper P J M and Gregory P J. 1987. Soil water management in the rainfed farming systems of the Mediterranean region. *Soil Use and Management* 3(2):57–62.
- Cooper P J M, Gregory P J, Tully D and Harris H C. 1987. Improving water use efficiency of annual crops in the rainfed farming systems of west Asia and north Africa. *Experimental Agriculture* 23:113–158.
- Harnsen K. 1984. Nitrogen fertilizer use in rainfed agriculture. *Fertilizer Research* 3:371–382.

- Harris H C, Osman A E, Cooper P J M and Jones M J. 1991. The management of crop rotations for greater WUE under rainfed conditions. In: Harris H C, Cooper P J M and Pala M (eds), *Soil and crop management for improved water use efficiency in rainfed areas*. Proceedings of an International Workshop, Ankara, Turkey, 15–19 May 1989. ICARDA (International Center for Agricultural Research in the Dry Areas), Aleppo, Syria. pp. 237–250.
- ICARDA (International Center for Agricultural Research in the Dry Areas). 1990. *Productivity of crop rotations*. Farm Resource Management Program, Annual Report for 1989. ICARDA, Aleppo, Syria. pp. 137–166.
- ICARDA (International Center for Agricultural Research in the Dry Areas). 1991. *Soil nitrogen status in two-course rotations: A preliminary assessment*. Farm Resource Management Program, Annual Report for 1990. ICARDA, Aleppo, Syria. pp. 126–133.
- ICARDA (International Center for Agricultural Research in the Dry Areas). 1993. *Productivity of crop rotations*. Farm Resource Management Program, Annual Report for 1992. ICARDA, Aleppo, Syria. pp. 137–166.
- Matar A, Torrent J and Ryan J. 1992. Soil and fertilizer phosphorus and crop responses in the dryland Mediterranean zone. *Advances in Soil Science* 18:81–146.
- Mokbel M G. 1985. *Evaluation of nutritionally relevant indicators in villages in Aleppo province, Syria, and their relation to agricultural development*. PhD thesis, University of Massachusetts, Amherst, Massachusetts, USA.
- Nordblom T, Christiansen S, Nersoyan N and Bahhady F. 1992. *A whole-farm model for economic analysis of medic pasture and other dryland crops in two-year rotations with wheat in northwest Syria*. ICARDA (International Center for Agricultural Research in the Dry Areas), Aleppo, Syria. 92 pp.
- Oram P. 1988. Agricultural production and food deficits in West Asia and North Africa: Future prospects and the role of high-elevation areas. In: Srivastava J P, Saxena M C, Varma S and Tahir M (eds), *Winter cereals and food legumes in mountainous areas*. Proceedings of an International Symposium, Ankara, Turkey, 6–10 July 1988. ICARDA (International Center for Agricultural Research in the Dry Areas), Aleppo, Syria. pp. 99–131.
- Ryan J and Matar A (eds). 1992. *Fertilizer use efficiency under rain-fed agriculture in West Asia and North Africa*. Proceedings of the Fourth Regional Workshop, Agadir, Morocco, 5–10 May 1991. ICARDA (International Center for Agricultural Research in the Dry Areas), Aleppo, Syria. 288 pp.
- Thomson E F and Oglah M. 1988. *On-farm experiments with forage legumes – six years of results from Breda*. Pasture, Forage and Livestock Program, Annual Report for 1987. ICARDA (International Center for Agricultural Research in the Dry Areas), Aleppo, Syria. pp. 74–82.
- Treacher T T. 1994. *The grazing behaviour of sheep grazing wheat stubble grown in rotations after medic or fallow*. Pasture, Forage and Livestock Program, Annual Report for 1993. ICARDA (International Center for Agricultural Research in the Dry Areas), Aleppo, Syria (in press).



# **The interactive effects of rainfall, nutrient supply and defoliation on the herbage yields of Sahelian rangelands in north-east Mali**

*P. Hiernaux,<sup>1</sup> P.N. de Leeuw<sup>2</sup> and L. Diarra<sup>3</sup>*

1. International Livestock Centre for Africa (ILCA)/ICRISAT  
BP 12404, Niamey, Niger
2. International Livestock Centre for Africa (ILCA)  
P O Box 46847, Nairobi, Kenya
3. Institut d'Economie Rurale (IER), BP 262, Bamako, Mali

## **Abstract**

In the Sahelian rangelands biomass production is constrained by soil moisture in the drier (100–250 mm) parts and by soil nutrients in the wetter parts. Similarly, for a given Sahelian range, nutrient deficiency would be more prominent in good than in poor rainfall years. To test this hypothesis, fertiliser trials were carried out at sites distributed along the bioclimatic gradient in the Gourma (Mali) over contrasting rainfall years between 1988 and 1992. In good rainfall years, adding 100 kg nitrogen (N) and 38 kg phosphorus (P)/ha increased herbage production by approximately 30%, whereas the response to fertiliser was inverted in poor years. Plant uptake of N and P increased with biomass yield, but at a lower rate. Fertiliser N and P increased biomass and nutrient yields but the nutrient content in biomass decreased due to nutrient dilution. In the pastoral context of the Sahel, grazing further influences the interactive effects of moisture and nutrient supply on herbage production and quality. To elucidate these interactions, cutting experiments were conducted with and without fertilisers. The effects of defoliation without fertilisers depended on rainfall and frequency of cuttings. In fair rainfall years early cuttings increased total yield whereas early cutting reduced yield in poor rainfall years. In good rainfall years total yield was reduced by 50 and 25% when repeated cuttings were at 15- and 30-day intervals, respectively. Reductions in yields were less severe in poor rainfall years. N and P uptakes changed little with repeated cuttings due to higher nutrient contents in regrowth. Adding fertilisers increased regrowth yields so that cumulative yields of repeated cuttings equalled or exceeded the control yield, depending on the rainfall conditions. Redistribution of rainfall in the landscape by run-off/run-on, and livestock grazing behaviour diversify the quantity and quality of range resources. Thus, recognising that soil nutrients provide a constraining ceiling for primary and secondary productivity on a regional scale, exploiting the quality gradient on a local scale through range management provides room for production improvement with little risk for this ecosystem.

## **Effets interactifs de la pluviosité, de l'apport d'éléments nutritifs et de la défoliation sur la production fourragère des pâturages sahéliens dans le nord-est du Mali**

*P. Hiernaux,<sup>1</sup> P.N. de Leeuw<sup>2</sup> et L. Diarra<sup>3</sup>*

1. Centre international pour l'élevage en Afrique (CIPEA)/ICRISAT  
B.P. 12404, Niamey (Niger)
2. Centre international pour l'élevage en Afrique (CIPEA)  
P.O. Box 46847, Nairobi (Kenya)
3. Institut d'économie rurale (IER), B.P. 262, Bamako (Mali)

## Résumé

*La production de biomasse des pâturages sahéliens est limitée par l'humidité du sol dans les zones les plus sèches (100–250 mm) et la teneur des sols en éléments nutritifs assimilables dans les zones plus humides. De même, la carence des parcours sahéliens en éléments nutritifs est plus accusée au cours d'une année humide que d'une année plus sèche. Pour tester cette hypothèse, des essais de fertilisation ont été effectués entre 1988 et 1992 sur des sites répartis le long du gradient bioclimatique dans le Gourma malien au cours d'une période caractérisée par des pluviosités extrêmement variées. Au cours des années de bonnes pluies, l'apport de 100 kg d'azote (N) et de 38 kg de phosphore (P) par hectare augmentait la production fourragère d'environ 30% alors que la réponse à ces engrais était inverse au cours des années sèches. Les exportations de N et de P par les plantes augmentaient avec la production de biomasse, mais à des taux plus faibles. Les engrais azotés et phosphorés augmentaient la production de biomasse et les teneurs en éléments nutritifs. Cependant, les concentrations de ceux-ci dans la biomasse diminuaient en raison de leur plus forte dilution. Dans le contexte pastoral du Sahel, la pâture modifiait en outre l'effet des interactions entre l'humidité et les éléments nutritifs assimilables sur la production et la qualité du fourrage. Pour mieux cerner ces interactions, des coupes ont été effectuées sur des parcours fertilisés ou non. L'effet de la défoliation sans apport d'engrais dépendait de la pluviosité et de la fréquence des coupes. Les coupes précoces augmentaient la production totale au cours des années de pluviosité moyenne et la réduisaient au cours des années sèches. Au cours des années de bonnes pluies, la production totale diminuait de 50% et de 25% avec des coupes effectuées respectivement à 15 et 30 jours d'intervalle. Les baisses de production étaient moins élevées au cours des années sèches. Les fauches répétées influençaient peu les exportations de N et de P en raison des teneurs plus élevées des repousses en éléments nutritifs. La fertilisation augmentait la production des repousses de telle sorte que selon les conditions de pluviosité, la production cumulée des coupes répétées était égale ou supérieure à celle du témoin non fauché. La redistribution de l'eau de pluie sur le terrain par écoulement/ruissellement et le comportement des animaux au pâturage influençaient la quantité et la qualité des ressources fourragères des parcours. Par conséquent, en tenant compte de la limite imposée dans cette région à la productivité primaire et secondaire par la teneur en éléments nutritifs des sols, il est possible, en exploitant à l'échelle locale le gradient de qualité par le biais de la gestion des parcours, d'améliorer la production avec peu de risques pour cet écosystème.*

## Introduction

In the Sahelian rangelands, along a gradient of rainfall from 100 to 600 mm, biomass output is constrained by soil moisture in the drier parts (100–300 mm) and by soil nutrients in the wetter parts (Bremen and de Ridder, 1991). It is argued that the boundary between moisture and nutrient deficiency constraints varies, and that nutrient deficiency is more prominent in good than in poor rainfall years. Nutrient removal through grazing further influences the interactive effects of nutrient and moisture supply on herbage productivity (Hiernaux and Turner, unpublished). In this paper, the impact of added nitrogen (N) and phosphorus (P) on herbage yields subjected to different defoliation regimes, and the role played by changes in nutrient uptake are investigated.

This research complements another study on the effects of defoliation on the yields and nutrient uptake of unfertilised swards (Hiernaux and Turner, unpublished). The objective of the present study was to elucidate the processes of herbaceous plant adaptation to resource scarcity and variability in the Sahel. Tillering annual grasses appears to be a major mechanism through which plants compensate for the low initial plant densities, caused by low seed stock, or to high seedling mortality during plant establishment (Cissé, 1986; Hiernaux et al, 1994). Together with plant self-thinning, tillering allows a flexible response to changing soil moisture and nutrient availability regimes. These compensatory processes are further elucidated in the controlled environment of pot trials. These trials show the remarkable versatility of Sahelian grasses to counteract set-backs due to defoliation and to exploit opportunities of better growing conditions (Hiernaux et al, unpublished). The implications for

livestock feed supply are highlighted within the larger context of the Sahelian plant–livestock ecosystem and plant resilience to drought and grazing.

## Material and methods

### Site description

Field trials were conducted at 10 sites in the Gourma region of northern Mali along a south–north longitudinal gradient from 14°30'N to 17°00'N. Four seasons during 1988 to 1990, and 1992 were covered providing a total of 22 site-years. Over sites and years, annual rainfall varied from 90 mm in 1990 to 350 mm in 1992. Changes in rainfall distribution patterns also contributed to variable lengths of growing period. Of the 22 site-years, four were located on clay soils (Vertisols and Fluvisols), with herbaceous vegetation dominated by *Panicum laetum* and *Echinochloa colona*. The remainder were situated on undulating or flattened dune landscapes with sandy soils (Arenosols), with a herbaceous layer mostly dominated by *Cenchrus biflorus* and *Tragus bertheronianus*. At each site a small enclosure (0.1–0.2 ha) was fenced in a homogeneous part of the predominating rangeland type. To avoid the residual effects from previous years' site disturbance, enclosures were moved each year. A description of site locations, soil and vegetation types, rainfall and yields are given in Table 1.

### Experiment design

In all trials, 100 kg N/ha as urea and 38 kg P/ha as triple superphosphate were spread on the soil surface at, or soon after, seedling emergence. Defoliation treatments fell into two groups: single and repeated cutting. In 1988 and 1989, uninterrupted growth curves were determined by cutting a protected sward at monthly intervals. Regrowth from each cut was also recorded at the end of the growing season and added to the cut yield to assess cumulative annual yield. Uninterrupted growth and cumulative yields, with and without fertiliser N and P inputs, were therefore compared for six site-years (Table 1). Similar procedures were followed for another seven site-years in 1990 and 1992. Fertilisers were applied to one half of each plot (3 x 5 m) that had been submitted to one of four different treatments during the dry season: grazing, burning, trampling and full protection as the control. Four replicates of the dry-season treatments were arranged in a randomised split-plot design.

During all four years in six different sites comprising nine site-years, a second set of defoliation treatment was performed. This involved repeated cuts at intervals of 15 and 30 days, with and without added N (100 kg N/ha) and P (38 kg P/ha). Cutting and fertiliser treatments, with unfertilised controls, were laid out in a complete randomised block with three replicates per site in 1988 and 1989, and four in 1990–92. Full plots were 3 x 2 m in size from which central 1 x 2 m were harvested for yield measurement. In 1988 and 1989, row irrigation was applied to investigate possible effects of moisture stress on plant yield and nutrient uptake. Adequate water was applied weekly to compensate 5 mm daily evapo-transpiration.

All harvested plant material was weighed immediately after removal, sun-dried, and thereafter kept in an oven (at 60°C) until constant weight was reached (24–48 hours). For a subset of the sites, total plant N and P concentrations were determined in composite samples for each treatment by date of cutting. Subsamples of plant material were ground to pass through a 1 mm sieve, acid digested (Nelson and Sommers, 1980), and analysed for N and P on a continuous-flow auto-analyser. Nitrogen and phosphorus uptake for each cut was calculated by multiplying the N and P concentrations by respective dry weights.

### Data analysis

Since plant responses to N and P were strongly influenced by soil moisture, a water balance model was used to classify rainfall conditions into 'good' and 'poor' groups. This model takes into account daily rainfall, run-off vs run-on and soil texture. The model estimates infiltrated rainfall and predicts the potential end-of-season herbage yields for each site-year (Hiernaux, 1984). Rainfall conditions were rated 'poor' when predicted potential dry-matter (DM) production was inferior to a threshold

that varied with the latitude of the sites equalling 875, 1250 and 1500 kg DM/ha, respectively, for the northern, central and southern sites (Table 1). These thresholds were based on potential infiltrated rainfall estimated from the long-term rainfall average at each latitude minus one standard error of the mean, which equalled 175, 250 and 300 mm for the northern, central and southern sites, respectively. The biomass thresholds were obtained by multiplying the potential infiltrated rainfall by a rainfall-use efficiency of 5 kg DM/mm (Le Houérou et al, 1988). Out of 22 site-years, only nine are classified as 'good'; they are mostly confined to 1988 on sandy sites and included four out of the five sites on clay soils.

**Table 1.** Description of defoliation treatments and characterisation of sites by year, soil texture, dominant species and rainfall conditions.

Year	Site location <sup>1</sup>	Soil texture	Dominant species <sup>2</sup>	Infiltrated rainfall <sup>3</sup> (mm)	Yield (kg DM/ha)	Early first cut	NP analysis
<b>Staggered cut</b>							
1988	N 1	Sand	Cb	<u>198</u>	68	x	
	N 5	Sand	Cb+Tb	<u>184</u>	157	x	
	S 17	Sand	Cb	<u>254</u>	188	x	
1989	N 1	Sand	Cb	134	61		x
	N 5	Sand	Cb+Tb	166	118		x
	S 20	Clay	Sg+Pl	<u>320</u>	162	x	x
<b>Staggered cut following dry season treatments</b>							
1990	N 4	Sand	Cb+Tb	137	944		x
	C 15	Clay	Pl	<u>536</u>	338	x	x
	S 20	Clay	Pl+Sb+Ec	257	63		x
	S31	Sand	Tb+Am+Cb	183	56		x
1992	S 17	Sand	Am+Bx+Cb	276	114		x
	S 20	Clay	Ec+Pl+Ep	350	95		x
	S 31	Sand	Cb+Ao+Am				
<b>Repeated cuttings</b>							
1988	C 12	Sand	Cb	<u>204</u> <sup>4</sup>	197	x	
	S 18	Sand	Cb	<u>265</u> <sup>4</sup>	167	x	
1989	C 12	Sand	Cb	194	83		x
	S 19	Sand	Cb+Tb	<u>230</u> <sup>4</sup>	86		x
1990	C 12	Sand	Cb	125	54	x	x
	S 17	Sand	Cb+Bx+Tb	206	80	x	x
1992	S 17	Sand	Am+Bx+Cb	276	114		x
	S 20	Clay	Ec+Pl+Ep	350	95		x
	S 31	Sand	Cb+Ao+Am	225	58		x

1. N = Northern sites (lat. >16°30'); C = Central sites (15°30' < lat. <16°30'); S = Southern sites (lat. <15°30').

2. Am = *Aristida mutabilis*

Ec = *Echinochloa colona*

Ao = *Alisicarpus ovalifolius*

Ep = *Eragrostis pilosa*

Bx = *Brachiaria xantholeuca*

Pl = *Panicum laetum*

Cb = *Cenchrus biflorus*

Sg = *Schoenefeldia gracilis*

Tb = *Tragus berteronianus*

3. Underlining indicates 'good' rainfall conditions based on estimates of infiltrated rainfall and predictions of potential biomass yields calculated with the "Anapluie" water balance model (Hiernaux, 1984).

4. Irrigation treatments.

**Figure 1 . Effect of fertiliser N and P on herbage yields of uncut (a) and 15-day cut (b) swards under good and poor rainfall conditions (Gourma region, northern Mali, 1988–92).**

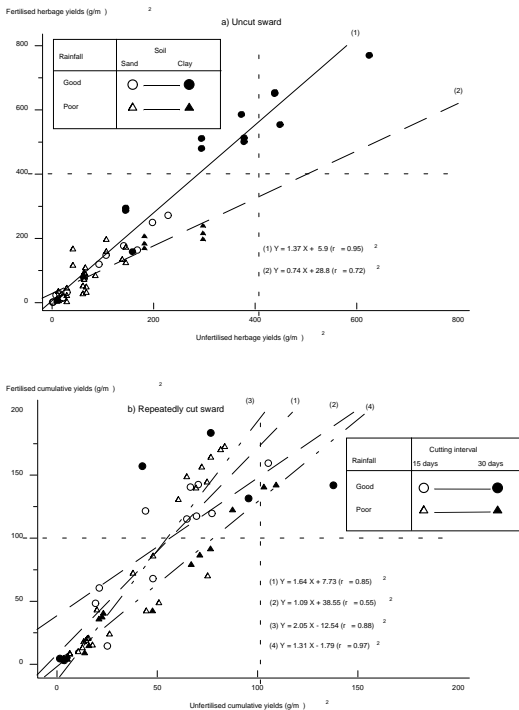

Stage of development at first cut were grouped as 'early', when cutting was performed before 15 August providing less than 25 g DM/m<sup>2</sup> was removed by the cut, or 'late'. Early cuts were infrequent occurring only in 9 out of 22 site-years and coincided largely with good rainfall years, when there was an early start of the growing season.

Analyses of variance were used to identify the treatment and environmental variables that determine plant yield and nutrient uptake, and linear regressions were used to quantify treatment effects on yields and nutrient uptakes.

## Results

### Uninterrupted growth

Responses to N and P inputs of monthly yields depended on rainfall distribution and vegetation type (Table 1). When the rains were good, N and P additions increased yields by about 30% (Figure 1a) whereas during poor rainfall seasons, yields were reduced by about 25%. The boundary between soil moisture and nutrient as leading constraints to the two contrasting trends appears to fall at a yield of about 50 g DM/m<sup>2</sup>, where the two regression lines intersect (Figure 1a). The yields on sandy soils were closely clustered below 100 g DM/m<sup>2</sup>, while higher yields were on the heavier clay soils found in topographic depressions.

### Single defoliation

Biomass removal during the growth cycle generally reduced total cumulative yield as compared to the maximum biomass of the uncut sward. When first cut was performed at an early stage of plant development total yields dropped by 20% as compared to 32% at a later stage (Table 2). Fertiliser application did not alleviate the yield losses but reduced the difference between early and late cuts (27% vs 31%).

**Table 2.** Coefficient of correlation and parameters of the linear regressions of cumulative yields: Cut + subsequent regrowth (Y), on yields of uncut control (X) with and without fertiliser (sandy soil sites in Gourma region, northern Mali, 1988–92).

Treatments	Stage of development at cutting	n	Intercept	Standard error of intercept	Slope	Standard error of Slope	r <sup>2</sup>	Significance of regression (P>F)
Without fertiliser	Early	64	-12.91	6.72	0.81	0.05	0.83	0.0001
	Late	34	3.42	8.92	0.68	0.09	0.64	0.0001
With fertilisers	Early	14	0.42	30.33	0.73	0.14	0.70	0.0002
	Late	26	-0.63	10.05	0.69	0.08	0.77	0.0001

### Repeated defoliation

The effects of cutting frequency on total cumulative yield was analysed using a three-way matrix which included cutting frequency, rainfall conditions and fertiliser application. Without fertiliser, repeated cutting reduced total cumulative yield compared to the maximum yield of uncut stands as indicated by the slopes of the linear regressions of cumulative yields on uncut stand yields (Figure 2). In good rainfall seasons, regrowth rates were impeded by soil nutrients, reducing yields by half in 15-day and by a quarter in 30-day cutting intervals. When rains were poor, cutting depressed cumulative yields less. Cumulative yields rarely exceeded 120 g/m<sup>2</sup> at 30-day and 100 g/m<sup>2</sup> at 15-day cutting intervals, which appears to indicate the maximum yield under intense defoliation and at natural levels of soil fertility.

**Figure 2.** Effect of cutting frequency and fertiliser (N and P) on cumulative herbage yields in two types of growing season (Gourma region, northern Mali, 1988–92).

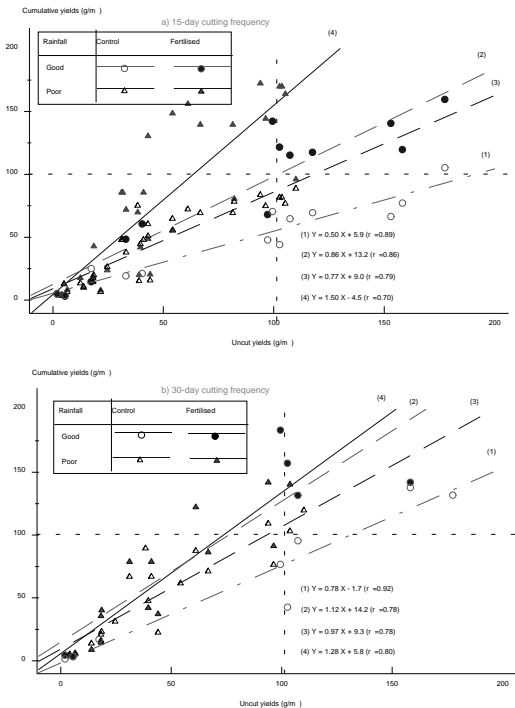

Applying fertilisers tended to raise yields above maximum uncut unfertilised yields. Yield increased by as much as 100% due to fertiliser application when 15-day interval cuttings were done under poor rainfall conditions (Figure 2a). However, when cutting at 15-day intervals with good rainfall, fertilisers just compensated for the reduction in yield due to repeated cutting. In 30-day interval cutting, added nutrients were less efficiently utilised giving lower increments above unfertilised cutting treatment (Figure 2b).

These trends were confirmed by a direct comparison of the cumulative yields obtained with and without fertilisers. In 15-day interval cuttings, fertilisation increased cumulative yields by about 60% under good rainfall whereas it doubled yields under poor rainfall conditions (Figure 1b). In 30-day interval cutting, the effects of fertiliser application were less with about 30% increase in yields regardless of rainfall conditions. Differences in fertiliser effects on yields were explained by the concentration of the response to fertilisers in the early stages of growth.

### Effects of fertiliser and irrigation

The effects of irrigation and added nutrients on cumulative yield and N and P uptake by *Cenchrus biflorus* rangeland are illustrated in Figure 3. Repeated cutting without supplementary irrigation decreased cumulative yield relative to the uncut control by about 20%. With supplementary irrigation repeated cutting resulted in cumulative yield about equal to control. Adding nutrients without irrigation increased yields by 50%; most of this increase was due to rapid plant growth during the first 25 days. Thereafter, soil moisture was probably deficient and little further growth ensued. When this water deficiency was partly remedied by row irrigation, growth continued, reaching a maximum yield of 250 g/m<sup>2</sup> at the end of the growing season.

### Nitrogen and phosphorus uptake

In general, uptake of N increases when stands are frequently defoliated. For seven sites during 1989–92 N uptake in the uncut controls averaged 1.1 g/m<sup>2</sup> with a range of 0.5–1.6 g/m<sup>2</sup>. In monthly cut swards N uptake increased to 1.5 g/m<sup>2</sup>, and to 1.6 g/m<sup>2</sup> in 15-day swards, i.e. a 30–40% increase. Adding fertilisers further increased N and P uptakes; in the 15-day cut swards N uptake doubled to 3.3 g/m<sup>2</sup>, but the rate of increase varied between site-years due to the influence of rainfall. In four sites with poor rainfall (three of which were in 1992) fertilisers had little effect on N uptake which only increased from 1.7 to 2.1 g/m<sup>2</sup>. In three sites with higher rainfall, N uptake in fertilised, frequently cut stands increased more than twofold from 1.5 g to 4.8 g N/m<sup>2</sup>. This converts to a fertilised N uptake efficiency of 33% which falls at the lower end of the range of efficiency measured in the Sahelian rangelands (Penning de Vries and Djiteye, 1982).

Adding both water and nutrients to a *Cenchrus biflorus* rangeland in 1989 increased N yield to 7.9 g/m<sup>2</sup> (3.1% N in the accumulated biomass) as compared to 1.6 g/m<sup>2</sup> (1.9% N) in the rainfed non-fertilised control, and to 4.7 g/m<sup>2</sup> (2.7% N) in the unfertilised repeatedly cut plots (Figure 3b). Thus, adding nutrients and irrigation increases N uptake, resulting in higher yields combined with higher N content in the herbage. Uptake of P in cumulative yield from 15 days cuts for rainfed, irrigated without and with N and P inputs were 0.19, 0.58 and 0.97 g/m<sup>2</sup>, respectively (Figure 3c). The ratio of P to N yields equalled 0.12 regardless of the treatments, a figure closer to the 0.15 maximum ratio than to the 0.04 minimum ratio found in Sahelian annuals (Penning de Vries and Djiteye, 1982). These rather high values of P/N ratio would indicate a higher N than P constraint to production in all treatments.

### Effect of herbage removal on N and P content

Herbage removal through patchy grazing by ruminants increases the spatial diversity of the standing biomass in terms of both quantity and quality. Removal can occur in previously (same growing season) grazed or in ungrazed stands. N and P concentrations in herbage from 18 Gourma site-years subjected



**Figure 3.** Effects of repeated cutting (RC), fertiliser (N+P) and irrigation (IR) on cumulative herbage yield, and on N and P uptakes of a *Cenchrus biflorus* rangeland (Gourma region, northern Mali, 1989).

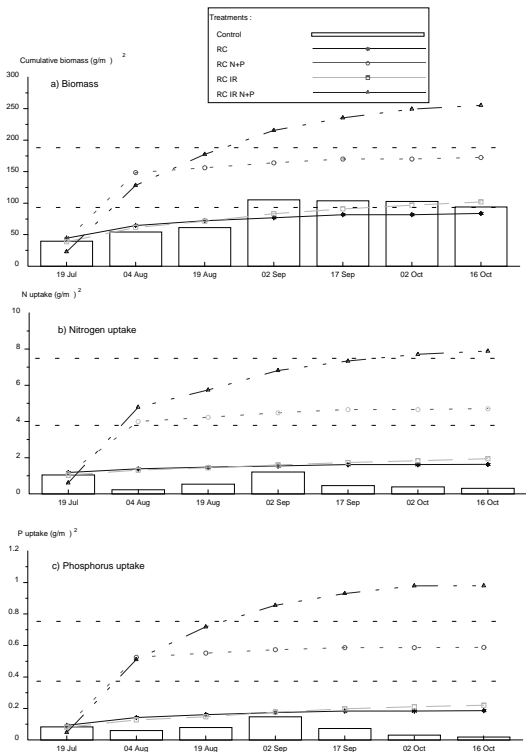

to 15- and 30-day repeated cuts to simulate moderate and heavy grazing were compared with concentrations in uncut control to quantify quality differences caused by defoliation. Early in the wet season, repeatedly cut swards contained mostly high quality herbage as 87–97% of total herbage mass had more than 2.4% N, as compared to only 33% in uncut swards. When the uncut swards were weighted for biomass, 60% contained less than 1.6% N (Table 3). Later in the season, the feed on offer appears to have a more diverse nutritive value. Yield-weighted N content of uncut, monthly and fortnightly defoliated herbage contained 0.9, 1.5 and 1.7% of N respectively. In uncut stands, almost 60% of the herbage was of low quality (<0.8% N), whereas high quality biomass (>1.6% N) comprised 54% of the 15-day and 37% of the 30-day cuts cumulative total, the remainder being of moderate quality (0.8–1.6% N).

**Table 3.** Effect of cutting and fertiliser application on the frequency distribution of biomass according to nitrogen (N) and phosphorus (P) concentrations, frequencies calculated for 18 site-years, Gourma 1989, 1990 and 1992.

Classes of nutrient concentration (%)	Early cuts (two first)				Late cuts (third on)			
	Unfertilised		N and P fertilised		Unfertilised		N and P fertilised	
	15-day cuts %*	Uncut control %	15-day cuts %	Uncut control %	15-day cuts %	Uncut control %	15-day cuts %	Uncut control %
<b>Nitrogen</b>								
<0.8	0.0	4.0	0.0	0.6	1.4	57.1	0.0	47.3
0.8–1.6	9.8	53.1	0.0	24.4	45.0	31.4	43.8	34.7
1.6–2.4	3.1	9.7	2.9	44.9	32.9	11.1	8.6	17.9
>2.4	87.0	33.2	97.1	30.0	20.7	0.4	47.6	0.0
<b>Phosphorus</b>								
<0.16	5.6	21.3	5.3	52.4	47.0	80.7	52.4	72.0
0.16–0.24	81.1	38.5	53.2	27.9	37.5	13.4	27.9	12.0
>0.24	13.3	40.1	41.5	19.8	15.5	1.9	19.8	16.0

\* % = per cent of herbage mass.

Early in the wet season, P concentration was over 0.16%, which should be sufficient for livestock maintenance (NRC, 1984), in 79% of the biomass, and the fraction increased to 95% when cut every 15 days. Defoliation had a larger impact later in the season, as the proportion of the herbage containing more than 0.16% P reached 50% in cut plots while it was 15% in the uncut plots.

Fertiliser application improved the forage quality somewhat. In the late-growing season, N content in uncut pasture increased by 11 to 20% (Table 3). While N content in the regrowth during the early season improved little, quality retention is pronounced later in the season; N content in the combined 15-days and 30-days cutting regrowth rose from 1.6 to 2.1%. In contrast, differences in P concentration between herbage classes were minor; as a consequence weighted P content changes little with fertilisation.

## Discussion

It is generally accepted that in the northern part of the Sahel zone, along the rainfall gradient of 100 to 300 mm, soil moisture exerts the greatest influence on primary productivity (Ellis and Swift, 1989; Wolff et al, 1991; Hiernaux and Turner, unpublished). Rainfall distribution together with seed stocks in soil at the start of the season determine germination rates and initial seedling densities (Carrière, 1989), and thereafter the soil water balance governs the length of the growing cycle (Rambal and Cornet, 1982; Mougin et al, 1993).

Across the rainfall gradient, herbage biomass at the end of the season varies considerably: from 15–110 g/m<sup>2</sup> in dry years to 75–200 g/m<sup>2</sup> in average years. On coarse-sand soils, yields were estimated at 15, 110 and 190 g/m<sup>2</sup> for 100, 200 and 300 mm of infiltrated rainfall, respectively, and at 25, 120 and 220 g/m<sup>2</sup> for the same infiltrated rains on loamy-sand soils (Breman and de Ridder, 1991).

Despite the strong influence of the soil moisture regime on primary output in the Sahel, soil nutrient supplies (in particular N and P) may limit yields as infiltrated rainfall increases (Penning de Vries and Djiteye, 1982). Nitrogen and possibly P availability may not, however, be independent of soil moisture. Not only do early rains supply about 0.65 kg N per 100 mm of rainfall (Krul et al, 1982), but N mineralisation increases with duration and depth of soil wetting in the rooting zone of the profile (Breman and de Ridder, 1991; Wolff et al, 1991).

Interactions between soil moisture and nutrient supply explained yields and uptake differences under various rainfall conditions in unfertilised and repeatedly defoliated swards (Hiernaux and Turner, unpublished). When rainfall was favourable, defoliation at 30- and 15-day intervals was found to reduce total cumulative yields by 30% and 52%, respectively. Yield loss was reduced as moisture stress became greater. These contrasting effects of soil moisture and nutrient limitations are confirmed in Figure 2. Although fertiliser additions resulted in yield loss of 23% under good rainfall, it increased yield by 50% when moisture stress was high due to poor rainfall.

In a pot trial (Hiernaux, unpublished) the provision of irrigation N and P produced over 700 g DM/m<sup>2</sup> during two months of *Cenchrus biflorus* and of *Schoenefeldia gracilis* planted at a density equivalent to 50 plants/m<sup>2</sup>. Planted one month earlier, *Cenchrus biflorus* adapted vigorously to a longer growing season producing up to 1400 g DM/m<sup>2</sup> in three months, doubling the density of tillers from 40 to 80 per plant. Rapid expansion of single plants by increasing tiller number and size allows plants to maintain yield at variable plant densities (Morris and Myerscough, 1991). Tradeoffs between exploitation of soil resources and inter-plant competition defined optimal ratios between plant and tiller densities (Hiernaux et al, 1993) and, for a given species, these optimal ratios were found to vary with moisture and nutrient availabilities.

The biomass production of the above pot-grown grasses cut at 15-day intervals was only half of the production of the uncut control. N and P uptakes were unaffected by cutting and tiller density increased due to cutting, allowing plants to set seed. These results are in agreement with observations of the present field study during good rainfall years. *Tragus berteronianus*, an annual grass morphologically smaller and of shorter life-cycle, produced seven times as little in the pot trial as did *C. biflorus* and *S. gracilis* (10 g DM/m<sup>2</sup> instead of 72 and 68 g DM/m<sup>2</sup>, respectively). However, *T. berteronianus* appeared, however, much less sensitive to intense defoliation; its DM production was reduced by only 3% when cut every 15 days, N and P uptakes increased slightly and cutting had no impact on seed production. These different responses to cutting of *C. biflorus*, *S. gracilis* and *T. berteronianus* confirm that sensitivity to defoliation increases with yield potential (Oesterheld and McNaughton, 1991). *T. berteronianus* and other short-cycle annuals such as *Dactyloctenium aegyptiacum*, *Zornia glochidiata*, *Tribulus terrestris* appear better adapted to heavy grazing during the growing season as they manage to set seed when frequently and severely defoliated. Such adaptation of flora to intense defoliation is restricted to areas where livestock concentrate during the wet season (e.g. night kraal, water points and transhumance tracks). This adaptation preserves vegetation cover stability and, although these short-cycled annuals have overall low biomass yield,

they are of relatively high N and P contents. Thus, local heavy grazing further diversifies the quantity and quality of feed on rangelands without endangering the vegetation cover (Hiernaux, 1993).

Although soil moisture is a primary constraint to biomass production on a large spatial scale in the Sahel, it may be less so when smaller-scale variability is taken into account. Run-off/run-on ratios create high-moisture niches where shortage of soil nutrients will limit yield. High-yield niches due to run-on are important in ensuring seed production during years of poor rainfall. On the other hand, run-off sites may provide low-yielding high-quality forage in good years, when dilution of nutrients turns most dry season forage into below maintenance feed. In the same manner, light and patchy grazing, as well as locally intense grazing, diversifies resources on offer.

## Conclusion

It was demonstrated that herbage removal can have a negative impact on cumulative biomass yields, especially in higher rainfall situations and in areas benefiting from large influxes of water run-on. However, since during good rainfall years feed supplies are more plentiful, yield reduction is of little consequence. High yields imply higher nutrient dilution and thus low quality feed that is carried over into the dry season. Patchy grazing is beneficial, therefore, since it improves the quality of the feed by providing higher protein concentrations in grazed patches throughout the season.

While soil moisture is extremely variable in time and space, and is further modified by run-on/run-off ratios at different spatial scales, soil nutrients provide a constraining ceiling above which primary and secondary productivity cannot rise. While in cropping systems external nutrient sources may raise this ceiling, for pastoral areas this avenue is technically disputable because the resulting increase in yield would be in part detrimental to forage quality. Moreover, adding fertilisers to Sahelian rangelands has no chance of becoming economically profitable because of the high cost of fertilisers and transportation to the region and also because of the common land tenure system (Breman and Traoré, 1987). Exploiting the quality gradient in feed on offer at the local scale provides some flexibility while preserving the ecosystem resilience.

## References

- Breman H and de Ridder N. 1991. *Manuel sur les pâturages des pays sahéliens*. Karthala, ACCT, CABO-DLO and CTA, Wageningen, The Netherlands. 485 pp.
- Breman H and Traoré N (eds). 1987. *Analyse des conditions de l'élevage et propositions de politiques et de programmes, Mali*. Sahel D (87)302, OCDE/CILSS/Club du Sahel, Paris, France. 243 pp.
- Carrière M. 1989. *Les communautés végétales sahéliennes en Mauritanie (région de Kaedi); analyse de la reconstitution annuelle du couvert herbacé*. CIRAD/IEMVT, Maisons Alfort, France. 238 pp.
- Cissé A M. 1986. *Dynamique de la strate herbacée des pâturages de la zone sud-sahélienne*. CABO, Wageningen, The Netherlands. 211 pp.
- Ellis J E and Swift D M. 1989. Stability of African pastoral ecosystems: Alternate paradigms and implications for development. *Journal of Range Management* 41:450-459.
- Hiernaux P. 1984. Distribution des pluies et production herbacée au Sahel: une méthode empirique pour caractériser la distribution des précipitations journalières et ses effets sur la production herbacée. Premiers résultats acquis dans le Sahel Malien. Prog. Doc. AZ 98, ILCA Bamako, Mali.
- Hiernaux P. 1993. *The crisis of Sahelian pastoralism: Ecological or economic?* ILCA (International Livestock Centre for Africa), Addis Ababa, Ethiopia. 15 pp.
- Hiernaux P, Diarra L and de Leeuw P N. 1994. Modelling the tillering of annual grasses as a function of the plant density, application to the Sahelian rangelands productivity and dynamics. *Agricultural Systems* 46:121-139.
- Krul J M, Penning de Vries F W T and Traoré K. 1982. Les processus du bilan d'azote. In: Penning de Vries and Djiteye M A (eds), *La productivité des pâturages sahéliens*. Pudoc, Wageningen, The Netherlands. pp. 226-246.

- Le Houérou H N, Bingham R L and Skerbek W. 1988. Relationship between the variability of primary production and the variability of annual precipitation in world arid lands. *Journal of Arid Environments* 15:1–18.
- Morris E C and Myerscough P J. 1991. Self thinning and competition intensity over a gradient of nutrient availability. *Journal of Ecology* 79:903–923.
- Mougin E, Lo Seen D, Rambal S, Gaston A and Hiernaux P. 1993. A regional Sahelian grassland model to be coupled with satellite multispectral data. I. Validation (submitted to *Remote Sensing of the Environment*).
- Nelson D W and Sommers L E. 1980. Total nitrogen analysis of soil and plant tissues. *Journal of the Association of Official Analytical Chemists* 63:770–778.
- NRC (National Research Council). 1984. *Nutrient requirements of beef cattle*. Sixth edition. National Academy Press, Washington, DC, USA. 90 pp.
- Oosterheld M and McNaughton S J. 1991. Effect of stress and time for recovery on the amount of compensatory growth after grazing. *Oecologia* 85:305–313.
- Penning de Vries F W T and Djiteye M A (eds). 1982. *La productivité des pâturages sahéliens. Une étude des sols, des végétations et de l'exploitation de cette ressource naturelle*. PUDOC, Wageningen, The Netherlands. 525 pp.
- Rambal S and Cornet A. 1982. Simulation de l'utilisation de l'eau et de la production végétale d'une phytocénose sahélienne du Sénégal. *Acta Oecologica/Oecologia Plantarum* 3:381–397.
- Wolff J, Breman H and Van Keulen H. 1991. *Bio-economic capability of West-African drylands*. Centre for Agrobiological Research Department of Land Resources Report 147. Wageningen, The Netherlands. 83 pp.

# **Nutrient cycling in mixed farming systems**

# Socio-economic dimensions of nutrient cycling in agropastoral systems in dryland Africa

*I. Scoones and C. Toulmin*

Drylands Programme, International Institute for Environment and Development (IIED)  
3 Endsleigh Street, London, WC1H 0DD, UK

## Abstract

Most research on nutrient cycling to date has focused on its biological dimensions. However, social and economic processes mediate the volume, pattern, and distribution of different nutrient flows. This paper presents a number of questions which need to be addressed, including: how sustainable are nutrient flows within agropastoral systems? and how can nutrient management be intensified as pressure on resources increases? Case studies are taken from five areas to provide details of how nutrients are managed in practise. These cover Burkina Faso and Senegal, Kenya, Mali, Nigeria and Zimbabwe. The case studies illustrate how important it is to understand the social and economic processes underlying the availability of nutrient sources and flows to different people. For example, access to manure depends on herd size, and the existence of manuring contracts whereby farmers can gain access to water and crop residues in exchange for the manure from visiting herds. Tenure relations will condition rights of access to grazing resources, while access to chemical fertiliser will depend on whether the farmer has market access and cash income. Rising human population density is likely to lead to increasing problems of soil fertility maintenance. However, in some areas, rising populations may provide both an incentive and the means to intensify land use. Political relations between herding and farming populations will determine the terms on which farmers can gain access to manure. Management skills and availability of farm labour will affect the care with which fertility inputs are applied in relation to crop growth in the rainy season. There are currently two basic policy alternatives for nutrient-cycle management within African agropastoral systems. The first involves the more effective management of resources internal to the agro-ecosystem (e.g. mulching, composting and intercropping with leguminous plants), while the second is based on the use of external inputs (e.g. chemical fertilisers). Future research needs to identify the costs and returns of each strategy, and the conditions are likely to include sufficient pressure on resources to prompt intensification, market conditions which bring reasonable returns to investment on-farm and assured access to land and other resources.

## Aspects socio-économiques du recyclage des éléments nutritifs dans les systèmes agropastoraux des régions sèches d'Afrique

*I. Scoones et C. Toulmin*

Drylands Programme, International Institute for Environment and Development (IIED)  
3 Endsleigh Street, Londres, WC1H 0DD (R.-U.)

## Résumé

*La plupart des travaux effectués jusqu'à présent sur le recyclage des éléments nutritifs ont essentiellement porté sur les aspects biologiques de ce phénomène. Et pourtant, ce sont les conditions sociales et économiques qui déterminent le volume, les caractéristiques et la répartition des flux des éléments nutritifs. Cet article présente un certain nombre de questions qui méritent d'être étudiées, notamment le problème de la durabilité des flux d'éléments nutritifs dans les systèmes agropastoraux et la manière d'intensifier la gestion desdits éléments compte tenu de la pression croissante que subissent les ressources. Cinq études de cas ont été exploitées pour présenter en détail le mode de*

*gestion des éléments nutritifs dans la pratique. Effectuées sur le Burkina Faso, le Sénégal, le Kenya, le Mali, le Nigéria et le Zimbabwe, elles font ressortir l'importance d'une connaissance adéquate des mécanismes sociaux et économiques qui déterminent les sources et les flux d'éléments nutritifs dont disposent différentes populations. Par exemple, la quantité de fumier disponible dépend de la taille des troupeaux et de la possibilité de contrats de fumure donnant aux éleveurs accès à l'eau et aux résidus de récolte en échange du fumier de leurs animaux. Le régime foncier détermine le droit d'accès aux pâturages tandis que l'utilisation d'engrais chimiques par le paysan dépendra de l'existence d'un débouché et du niveau de son revenu monétaire. Nombreux sont ceux qui pensent que l'accroissement de la densité de la population humaine pourrait aggraver le problème du maintien de la fertilité des sols. Dans certaines régions cependant, ce facteur pourrait jouer un rôle de catalyseur et entraîner l'intensification du mode d'occupation de la terre. Les relations politiques entre éleveurs et agriculteurs déterminent les conditions d'accès de ces derniers au fumier. Au cours de la saison des pluies, les aptitudes des agriculteurs en matière de gestion et le volume de la main-d'oeuvre agricole disponible déterminent le soin apporté à l'application des intrants fertilisants destinés à accélérer la croissance des plantes. On distingue aujourd'hui deux grandes stratégies de gestion des éléments nutritifs dans les systèmes agropastoraux en Afrique. La première préconise une gestion plus efficace des ressources internes des systèmes agro-écologiques (mulch, compost, association avec des légumineuses) alors que la seconde est basée sur l'utilisation d'intrants exogènes (ex. engrais chimiques). Des travaux devraient être entrepris pour déterminer les coûts et les avantages de chacune de ces stratégies ainsi que les conditions d'une gestion plus efficace des éléments nutritifs dans les régions sèches d'Afrique. Il est probable qu'une pression accrue sur les ressources avec comme conséquence l'intensification du mode de gestion, des conditions de marché appropriées pour rentabiliser les investissements agricoles et un accès assuré à la terre et aux autres ressources pourraient promouvoir une meilleure gestion des éléments nutritifs.*

## Introduction

Nutrient cycling in agropastoral systems has biological, economic and social dimensions. However, most research effort to date has been invested in the biological aspects. Such research has explored the flows of both micro-and macro-nutrients between different nutrient pools in both the crop and livestock components of agropastoral systems (e.g. TSBF, 1991; 1992). This biological research has focused on changes in soil chemical properties and contributed to the design of recommendations for more sustainable systems of agriculture, where the balance of nutrients is maintained either through the cycling and regeneration of internal resources, or through external subsidy. The biological processes involved in nutrient pools and flows from these are mediated by social and economic processes. Too often these are ignored in discussion of soil management and prescription of strategies for a more sustainable agriculture in dryland areas.

The debate about the future of dryland agropastoral systems offers two alternative, although not mutually exclusive, scenarios. One envisages future sustainability being based on mobilising resources largely internal to the farming system, through the more effective application of labour and skills to improve the efficiency of nutrient cycling, soil conservation and water harvesting. Interventions such as mulching, green manuring and recycling of biomass, kraal manure management and agroforestry options are envisaged in this low external input agriculture (Reijntjes et al, 1992). The other scenario argues that such alternatives are inadequate to keep up with the pace of population growth and environmental change. Instead, external resources, such as chemical fertilisers, mechanised farming and irrigation are required (Breman, 1990a; Borlaug, 1992).

A number of policy questions arise from these alternative scenarios which include:

- How sustainable are nutrient flows within agropastoral systems? Can the extraction of nutrients from grazing land and their transfer to arable areas be sustained over time?
- Which is the most viable option for dryland agropastoral systems: a high input of nutrients from external sources, or regenerative management of nutrients from within the agropastoral system?



- How can nutrient management be intensified under conditions of increasing pressure on resources?

Before answers can be found to these questions, the interactions between the biological, economic and social processes involved in nutrient cycling must be understood. This paper provides an overview of these processes by reviewing a range of literature from a variety of disciplines and from different parts of Africa. Using a series of case studies, the paper highlights some of the most important socio-economic dimensions of nutrient cycling in agropastoral systems of dryland Africa.

## Managing nutrient pools and flows

Figure 1 presents a simple diagram of nutrient pools (in square boxes) and flows (arrows and circles) in an African agropastoral system (adapted from Swift et al, 1989). This diagram illustrates, in a highly simplified fashion, how nutrients flow between different components of the system.

The connections between biological transfers and socio-economic factors can be demonstrated by examining the flow of manure from grazing to arable land via the digestive system of livestock. Grass and browse from grazing lands are consumed by livestock which in turn produce manure. This is deposited both within grazing areas and in livestock pens. The manure is then applied to arable land, either on dry fields (home or outfields) or within irrigated gardens. Application may be direct by placing livestock pens (or kraals) in the fields or through transportation from the pen to the field. In addition to manure derived in this way, some may also be collected directly from the grazing land for transport to the field.

Each component of this flow of nutrients, especially the volume and direction, is affected by socio-economic factors. For instance, access to manure will be affected by a range of factors such as size of herd and access to manure exchange contracts. The quantity of manure will depend on access to grazing land which will be affected by tenurial rights, as well as the availability of the fodder resource. Manure quality will depend on the type of fodder resource, the management inputs in the livestock pen and the season. The application of manure to arable areas will depend on its transport from livestock pens to the field or the existence of arrangements whereby herders pen their livestock on farmers' fields. Transport will be reliant on access to carts and transport animals, while access to herders' livestock manure will be dependent on establishing mutually acceptable exchange relationships between herders and farmers. Application of manure on the fields will in turn depend on labour availability, while ensuring the effective use of available nutrients for crop growth will be dependent on careful management and timing of manuring in relation to sowing and weeding the crop.

In sum, for any given farmer, access to each nutrient pool and flow is dependent on a range of socio-economic factors. The simple diagram presented in Figure 1 becomes much more complex once these dimensions are taken into account. Issues of resource quality and resource access affect the nutrient stocks within any one of the nutrient pools identified, while issues of labour availability, management skill, access to cash and availability of transportation influence the flows between nutrient pools. These issues are summarised below for five pools and five groups of flows.

### Nutrient pools: Issues of resource quality and access

- Market: access to cash income to pay for inorganic fertiliser; access to markets at which fertiliser is available; economic policy and price support for inputs.
- Livestock: access to livestock or exchange relationships with others (such as loaned animals, exchange of manure for grazing, or gifts of manure from relatives).
- Grazing land: quality of grazing land; tenure and access to grazing land; population pressure and availability of grazing land.
- Arable land: resource quality of arable land; access to garden or crop land.
- Household: household size influencing production of waste for composting; access to toilets affecting availability of human excreta for grazing land.

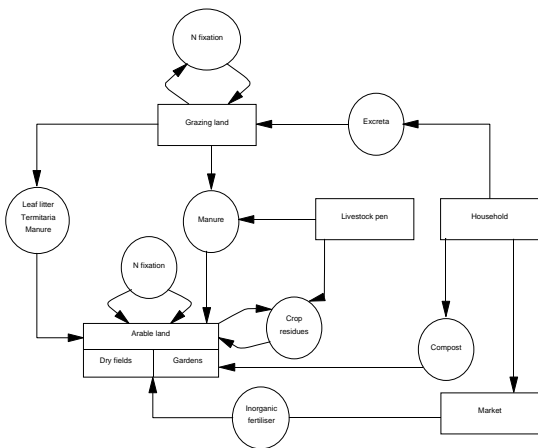
**Figure 1.** *Nutrient cycle model for an agropastoral farming system.*

## Nutrient flows: Issues of labour, cash and transport

### From livestock pen to arable land

This flow may be affected by access to transport and labour if the pen is situated some distance from the fields. In other cases, pens may be located on the fields and the flows can be more directly managed if the livestock are owned by the field owner. In other instances, where manuring contracts are involved, the negotiation of arrangements between herders and farmers is central to the flows (McCown et al, 1979; Toulmin, 1983; McIntire et al, 1992; Toulmin, 1992a; 1992b). These flows may also involve exchange of manure between friends and relatives. Manure applied to arable land may in some cases be derived from the livestock pen of a friend or relative who has excess.

In intensive agropastoral systems, such as in the highland areas of Rwanda, Cameroon or Ethiopia, pen-feeding may be economical. There is usually a high manure retrieval rate from pen-fed animals which produce high-quality manure if volatilisation is minimised. In such intensive systems, manure application may be very important to overall production (Gryseels and Anderson, 1983; Holtzman, 1986; Jones and Egui, 1987).

The reverse of this flow may involve the transfer of crop residues from arable areas to the livestock pen (as pen feed for animals or as biomass additions to the manure). This again requires labour and the degree to which this flows is important will depend on the other demands for crop residues as fodder, fencing, roofing or fuel.

### **From grazing land to livestock pen**

The flow of livestock manure is determined by the way in which herders manage the grazing and kraaling patterns of livestock. Kraaling animals overnight is a common practice; this ensures that around 50% of all dung produced by the animals is deposited in the pen. Longer periods of kraaling increase the recovery of manure, although, without pen-feeding, this may constrain the grazing time and feed intake of animals (Bayer, 1986). A certain proportion of the manure produced is deposited directly as the animals pass through arable and grazing lands. Where this is actually deposited will depend on the grazing behaviour of the animals (in free-grazing situations) or the herding practices of the herder. Other fertility inputs may also be important as part of this flow. Termitaria and leaf litter may be collected from the grazing land and added to the livestock pen (or applied directly to the field as part of the grazing to arable land flow). This usually requires a considerable amount of labour investment but is particularly important for farmers with limited access to alternative fertility inputs (Watson, 1977; Carter, 1992).

### **From markets to arable land**

This flow is highly variable depending on access to cash, prices and availability of fertilisers in the market. For example, in many African countries, fertiliser prices have escalated due to the removal of subsidies as part of structural adjustment programmes, greatly reducing the use of this input.

The management of all flows requires both labour and skills for fine-tuned management to maximise nutrient use and reduce losses. Efficient nutrient cycling is thus dependent on a range of socio-economic dimensions, which are differentiated within any farming community. How different individual farmers decide to manage the nutrient pools at their disposal and the nutrient flows within their command will depend on a variety of issues related to access to labour, capital assets, disposable cash income, secure rights over land, the resource endowments of the land, management skills and so on. Different farmers will approach the nutrient-cycling challenge in different ways.

The dynamics of this differentiated approach to nutrient cycling are examined in a series of case studies.

## **Ecological and economic factors influencing nutrient cycling in agropastoral production**

Whether nutrient cycling is a limiting factor in agropastoral production will depend on a variety of ecological and economic factors. These are considered briefly below.

### **Ecological factors**

The productivity of savannahs is affected by a trade-off between the moisture and nutrients available to plants (Huntley and Walker, 1982; Walker, 1985; Frost et al, 1986). This trade-off can be illustrated schematically with a simple diagram (Figure 2).

Soil nutrient availability (the horizontal axis in Figure 2) is influenced by parent geology, and by nutrient transport from weathering and water movement. The overall availability of plant available moisture (the vertical axis in Figure 2) is influenced by total rainfall levels and distribution, soil physical properties (particularly infiltration rates) and topography.

An interaction of base geology and rainfall levels thus creates the distinction between arid-eutrophic and moist-dystrophic savannahs (Huntley, 1982), although local conditions of geology,

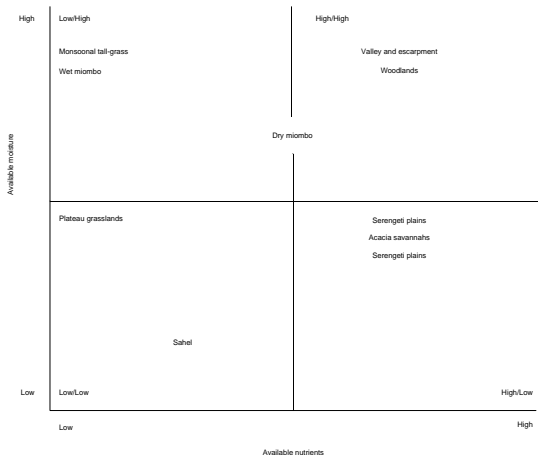
**Figure 2.** Hypothetical distribution of savannah types in relation to the major determinants of savannah function.

Source: Frost et al (1986).

soil form or topography may override this simple distinction. For instance, low-lying areas within zones of nutrient poor soils may be the sink for leached nutrients and high-quality soils transported from elsewhere. Such areas may also act as sinks or transition sites for drainage of water from upland areas. Such "key resource" areas exist as high value patches within landscapes dominated by the major forms of savannah type. The major limiting constraints of available soil water or soil nutrients will not apply in such key resource patches (Scoones, 1989).

This characterisation of savannah types is important for understanding patterns of nutrient cycling, use and management. The importance of nutrients as a limiting factor in production increases as we move from arid areas of low water availability to subhumid areas with higher water availability for plant growth, as in West Africa from the desert edge, and the Sahelian fringe to the southern savannahs (Penning de Vries and Djiteye, 1982). Nutrient availability also becomes an increasingly important constraint on production as we move from eutrophic environments with nutrient rich heavy clay or volcanic soils to dystrophic environments dominated by poor sandy soils, as in areas of East and southern Africa, where volcanic soils or doleritic intrusions lie in close proximity to poorer sandy soils derived from granite (Bell, 1982; Huntley, 1982). Thus nutrients are the most likely constraint on

production in wetter, dystrophic (sandy soil) environments and a much lesser constraint in drier, eutrophic environments.

However, landscape and micro-level heterogeneity may override this broader pattern. For instance, within a sandy soil catena in a dystrophic environment (e.g. a *miombo* area in central-southern Africa) there may be important run-on sites where nutrients are deposited and richer soils develop (e.g. *dambo* areas in southern Africa). Here the nutrient constraints evident in the rest of the catena are not so tight, allowing the development of higher quality grasses for grazing and crop farming with lower input levels (Ingram, 1991; Scoones, 1992). Spatial heterogeneity at the micro-level may also affect nutrient availability. The effect of a tree canopy in nutrient-poor savannahs may boost production through leaf deposition and reduced moisture loss (Kellman, 1979). A heterogenous pattern at a small scale is also created by selective clearance within closed woodland (Campbell et al, 1988). Similar patterns of micro-level variation may be created by the grazing effects of large herbivores, the deposition of dung and urine, (Putmann, 1986) and through termite activity (Watson, 1977).

Thus, the role played by nutrient cycling depends on the farm site, both in a regional sense and at a more local level. It also depends on time period, as the importance and effect of nutrients will vary between both seasons and years.

Temporal variation in nutrient availability and the systems through which they are cycled are critical in understanding how farmers are able to manage nutrient cycles in farm landscapes. In savannahs, two interconnected nutrient cycles operate at differing speeds. Nutrients from grasses and annual crops cycle relatively fast through the agro-ecosystem. By contrast, nutrients locked up in trees and perennial crops move more slowly (Frost, 1985). Trees are particularly important in savannah nutrient cycles since they provide a renewable nutrient pool and a less variable pattern of nutrient release than do grasses and annual crops (Prinsley and Swift, 1986). The speed of biomass decomposition and recycling will depend on a variety of factors related to the nature of the biomass material, the soil types and soil fauna. In general, nutrient cycles are faster in wetter savannahs and slower in drier areas (Anderson and Ingram, 1993). Nutrient release follows a pulsed rhythm in savannah systems, with peaks occurring at the onset of the rains when decomposition increases. The greater variety of different materials that are recycled (grasses, crop residues, leaves, twigs etc), the greater the number of different nutrient release pulses occur as the season unfolds.

Managing this spatial and temporal variation in nutrient pools and flows within a farm landscape is a major challenge for the farmer. Mechanisms for nutrient conservation and regeneration are key to the efficient management of nutrient cycles in agro-ecosystems. The conditions for successful management are dependent on a variety of socio-economic factors, and are discussed in the next section.

### **Socio-economic factors**

Management of the nutrient cycle will depend on farmers' access to and returns from the use of different nutrient pools. These returns will depend not only on ecological but also on socio-economic factors. Socio-economic factors include population trends and resource availability, variable access to production inputs, prices, markets and economic policy, and the social context within which nutrients are managed.

### **Population trends**

As population density increases the marginal productivity of labour will decline at the extensive margin of agricultural production because land of decreasing nutrient quality is put under production. At the intensive margin a similar pattern of decreasing marginal productivity is observed due to diminishing returns to labour. Under conditions of rising demand for land through increasing population pressure, and as marginal returns continue to decline there are two possible options. One is the doomsday scenario of Malthus where populations outstrip resources and food supply. The other option, following

Boserup, sees the agricultural production function moving upwards in the long run through technological change, initiated and promoted by population growth (Boserup, 1981). Under the Malthus scenario long-term declines in both per area and per capita food production can be expected with consequent deprivation. Under the Boserup scenario, farmers innovate with different fertility-management options, manipulating and adapting nutrient cycles to sustain food production.

### **Varying access to factors of production**

Farm households face different constraints to production depending on their own and the wider economic situation (Ellis, 1988). In some cases land may be the limiting factor in production. When this is the case, farmers would be expected to invest labour and capital in securing higher returns per unit area of land through land-intensive measures (e.g. nutrient conservation and harvesting techniques). In other cases labour may be limiting (e.g. through male outmigration, old age or infirmity etc). In these situations, land extensive options with low labour requirements may be a better alternative nutrient management solution (e.g. agroforestry options involving low labour input, extensive application of fertiliser etc).

In other instances capital may be the limiting factor. Lack of capital assets, such as livestock, will constrain manuring options, and farmers will need to make alternative arrangements (manuring contracts, exchanges with relatives, or other fertility management techniques). Lack of capital may also constrain options requiring cash expenditures such as the purchase of inorganic fertiliser.

### **Prices, markets and economic policies**

Prices and market conditions affect the demand for different fertility-management options, which may be secured through both formal and informal markets. These are in turn affected by prevailing economic policy as determined by national governments and international conditions. For instance, the relative returns (financial benefits minus costs) of different fertility inputs from internal or external sources will clearly affect farmers' choice. In many parts of Africa inorganic fertilisers were heavily subsidised during the 1960s and 1970s, significantly reducing the financial costs to farmers. Since the 1980s, economic policies have shifted and many agricultural subsidies have been removed as a result of structural adjustment programmes. This has swung the balance back towards the management of internal resources, putting a higher premium on manure and locally produced biomass sources of soil nutrients.

Choices between the exploitation of different internal nutrient pools and the management of different internal flows will equally depend on the relative costs and benefits of different options. For instance, the growing transaction costs involved in securing manuring contracts between farmers and herders in the Sahelian region provide an increased incentive for farmers to invest in livestock of their own to secure manure and other livestock goods (Toulmin, 1992a; Thébaud, 1993). Equally if labour is employed locally to assist with transportation of manure (e.g. hiring of scotch carts) or collection of termitaria or leaf litter, the local wage labour rates will be a significant factor in choosing between different options.

### **Labour and management skills**

The management of nutrient cycles in highly variable environments requires a great deal of skilled management. Farmers' management must fine-tune applications of a mix of fertility inputs to the spatial variation in soil types and available nutrients, as well as the temporal variation in decomposition processes and the dynamics of nutrient release. To manage available nutrients efficiently, reducing the need for use of external inputs such as inorganic fertiliser, farmers must carefully match inputs with plant needs within different parts of the agro-ecosystem. For instance, spot applications of manure at particular times on particular crops may make the best use of a limited resource, reducing leaching and volatilisation effects and maximising yield. Such tasks require farmer knowledge, skills and labour

inputs. In many farm settings these may not be available. Skills may be lacking, particularly in instances where a strong reliance on subsidised fertiliser existed in previous decades or where migration to urban areas for employment means there is little skilled male labour available for farming. Incentives for low-input agriculture must include investment in increasing skill levels of farmers and securing economically viable returns from such investment (Pretty et al, 1992). In drier agropastoral areas of Africa, where yields are highly variable due to erratic rainfall and where marketing opportunities are uncertain because of distance from markets and low prices, farmers may have little interest in investing in organic or chemical fertilisers. In addition, the risk of drought will discourage heavy use of nutrient imports because of the damage caused to crops from 'burning', which occurs on well fertilised land when rains are light (Sumberg, 1991).

### **Social context**

In many dryland regions, farming and livestock keeping are carried out by different ethnic groups. For example, the Fulani are widely known as herders throughout West Africa; they keep their own animals and are hired to look after those of settled farmers. While decades of drought and herd losses have forced many herding groups to settle and farm, a strong element of ethnic and occupational distinctiveness remains between those who are primarily farmers, and those from a pastoral herding background. Such differences lie in terms of language, culture, dress, and ways of life, as well as the particular political and economic interests of the groups involved. Relations between these groups are coloured not merely by complementary and conflicting interests associated with their main activity — cultivation, or livestock-keeping — but also by historical factors which strengthen attitudes of either hostility or friendship.

In much of Sahelian West Africa, farming groups have established and maintained control over land, based in part on customary rules, and in part on the emphasis given by national governments to supporting increased agricultural production. The priority given to farming has been at the expense of pastoral groups, who have lost rights to use and manage many water and grazing resources on which they formerly depended. Farmers are thus in a strong position to set the terms for exchanging access to water with herding groups. Were herders to acquire formal rights to settle and dig wells of their own, farmers in this region would lose such easy and low cost means of acquiring access to nutrients (Toulmin, 1992a). Already, many farmers are building up their own cattle herds, partly as a source of wealth, and partly to provide access to sufficient dung to enable them to do without visiting herding groups.

Thus, institutional and social relations set the pattern of flow of nutrients between different groups, and the terms of access. The power balance between ethnic groups at a national and local level is important in understanding how and by whom the terms of such exchange relations are set.

### **Case studies: Exploring the context for nutrient cycling**

This section presents five case studies from different agropastoral settings in dryland Africa, illustrating how particular socio-economic dimensions affect options for nutrient cycling. Fertility management options vary between sites and between different people in a given site.

The first case, from Burkina Faso and Senegal, highlights the importance of labour availability in the management of soil fertility. Male out-migration results in the redirection of women's work from their own fields to household fields owned by men. The second case, from Kenya, shows how increased population pressure on available resources may result in increased investment of labour and other farm resources in nutrient management as land becomes scarce. The third case, from Zimbabwe, illustrates how the land resource itself is highly heterogenous and how fine-tuned fertility management is essential for maintaining yields with low input levels. The final two cases, from Nigeria and Mali, examine the social and economic context for nutrient flows between agriculturalists and pastoralists

and how these are changing over time as different socio-economic circumstances influence the relative costs and benefits of different forms of crop–livestock interaction in agropastoral areas.

### **Impacts of male labour migration in the Sahel**

A series of studies carried out by SOS-Sahel (David and Ruthven, 1993; David et al, 1993) illustrates how changing labour availability alters the ability of people to invest in soil fertility management in the Sahel. In the Burkina Faso study site, migrants' wives have to invest more time in agriculture because of the reduction in family labour. Extra time spent applying household waste and manure on the village plots means that women have less time to invest in their own farm plots. Women's plots thus tend to have low fertility inputs, such as the occasional use of *Loudetia* grass mulch and *karite* leaves, but rarely do they have access to manure or to inorganic fertiliser.

A similar pattern is seen in some areas of Senegal where 70–80% of the men leave the villages during the dry season for work in the capital, Dakar. In this case, the lack of male labour reduces the ability to transport manure to the fields. The result is poor timing of fertility applications and reduced yields. Manure is applied to family fields close to the village. Women's plots appear to receive little manure and rely on small inputs of household ash or waste.

The case studies highlight how effective nutrient management requires considerable labour, both for transportation of manure and for timely application. Complex combinations of organic inputs require high labour inputs and good timing for effective returns. With reductions in labour availability through male-outmigration in the Sahel, low-input fertility management strategies appear to be the only option available to farm households.

### **Population pressure and agricultural intensification in Kenya**

The population of Machakos District, Kenya, grew at a rate of between 2.5 and 3.75% annually between 1930 and 1990 (Mortimore, 1991). This 60-year period has seen a number of major changes in the farming system. Since the 1970s total farm productivity per head of population and per unit area has risen dramatically (Tiffen and Mortimore, 1992). In most years productivity increases through investment in agricultural intensification have more than kept up with district level population increases. Agricultural intensification has occurred through shifts to short season maize varieties, closer management of smaller livestock herds, and diversification of production to include high-value vegetables and non-farm income sources (Mortimore, 1991).

Intensification has included investment in soil conservation and nutrient management techniques. Soil and water conservation measures (including terraces) have expanded greatly in the past few decades. The resultant reduction in erosion levels has meant that soil surface nutrients have been retained in the fields rather than being washed away (Thomas, 1991). Nutrient management practices have also changed. Increased amounts of manure, fertiliser and mulches are now applied to arable land. Fertility levels (nitrogen, phosphorus and carbon) are significantly lower on cultivated lands than most grazing and fallow areas (Mbuvi, 1991), reflecting a long-term decline in the fertility of arable areas that has been going on since the 1930s. However, this trend of fertility loss is now being reversed through agricultural intensification. While the volume of fertiliser application is low, it provides a sufficient boost in fertility levels to maintain yields, although the amounts applied will probably not result in complete fertility restoration in the longer term. This will only occur through longer term processes of soil regeneration, assisted by reduced top soil loss, and will be realised through investments in soil and water conservation (Mortimore, 1991).

The Machakos case shows how agricultural intensification can occur under conditions of high and rising population pressure, if farmers have access to markets, extension and support services (Tiffen and Mortimore, 1992). Under such conditions farmers invest in effective nutrient management, allowing yield levels to be sustained or increased and long-term declines in land degradation to be reversed.



## Soil fertility management in heterogeneous farm landscapes: The case of Zimbabwe

Fertility management is not uniform across farm landscapes. In most instances farmers apply very different amounts and types of fertilisers between plots and crops. In Zimbabwe, most fertility inputs are applied to home fields and gardens. Estimates from the Mutoko communal land area suggest that over 80% of the nitrogen (N) applied to field and garden areas is derived from kraal manure. Leaf litter is another significant source (around 10% of total N applications). N applications are six times as high per unit area in gardens (120 kg N/ha per year) as in fields (20 kg N/ha per year). Manure is used on arable fields and gardens (78% and 22% respectively) while leaf litter is kept for garden use. Within cropland fertility applications are further differentiated, with most fertiliser going to the home fields and maize crop (Campbell et al, unpublished). Clay soils in dry areas receive very little extra fertility input, except in gardens where water is available for irrigation. The mosaic of soil types found both within and between fields means that blanket applications of any fertility input are inappropriate. Instead fine-tuned, spatially differentiated inputs are required (FSRU, 1993).

Despite applying only 30% of the recommended levels for inorganic fertiliser and 60% of the recommended levels for manure, farmers achieve yields of around 2 t/ha of maize in Mutoko area when rainfall reaches the expected average (c. 800 mm) (Campbell et al, unpublished). In the drier areas of Chivi communal area (average rainfall c. 500 mm), even lower fertiliser application levels are seen. Returns from inorganic fertiliser are low because of erratic rainfall. Organic fertilisers, such as manure, have higher returns because of their beneficial effects on soil structure, but high application levels cause problems of crop burn when rainfall levels are low. In these dry areas, crop yields are more constrained by rainfall levels than fertility.

Maintaining yield levels despite low application rates requires fine-tuned and highly responsive fertility management that focuses on increasing N-use efficiency rather than boosting application levels. Low-input fertility management includes: realising the benefits of the interactive effects of multiple types of fertiliser use, exploiting the residual carry-over effects of certain fertilisers, the careful timing of application in relation to rainfall events, and the focused spatial application of fertilisers in relation to micro-variations in soil type or plant position (Carter, 1992; FSRU, 1993). A combination of these management tactics allows farmers with limited nutrients to continue in agricultural production, even under highly marginal conditions.

## Changing access to manure: the case of northern and central Nigeria

Manure is an important input into permanently cultivated farm plots close to settlement areas (Hill, 1972; Norman et al, 1982; Mortimore, 1989). These intensively farmed fields tend to be planted with cereals, compared with more distant *gona* or bush fields where non-food crops, such as cotton, are usually grown (Norman et al, 1982). On the basis of several years' farm production data from the late 1960s, Norman et al (1982: 139–140) calculated that fertility input levels have no effect on gross returns per hectare. Instead total farm production is more directly affected by access to low-lying wetland (*fadama*) areas and to family and hired labour.

However, despite these findings, settled farmers in northern Nigeria continue to invest heavily in securing access to manure. This may be from sales of manure which, although rare, occurred during the droughts of the 1970s and 1980s, when many poorer households sold manure from their own livestock pens or from manure collected on grazing lands (Mortimore, 1989). Manure may also be acquired through arrangements whereby Fulani herders are invited to pen their livestock on farmers' fields in exchange for crop residues or other fodder supplies (Powell, 1986; Powell and Mohamed-Saleem, 1987; McIntire et al, 1992). However, the transaction costs of such arrangements are increasing and so are the incentives for farmers to invest in their own livestock. In areas where resource-use pressures are high, such as the Kano Close Settled Zone, manure is managed most carefully (Mortimore, 1989).

## Manure and investment in farming communities in central Mali

On the northern fringe of the farming zone in Mali, Bambara farmers dig wells on the fields surrounding the village to attract livestock during the dry season (Toulmin, 1992a). In this lightly populated region, with less than 20 people per km<sup>2</sup>, a very extensive farming system has developed, following the introduction of light ridging and weeding tools, drawn by oxen. Animal traction allows farming households to sow and weed a large, shifting field in the bush, as well as several heavily manured plots around the village.

Manure comes from two main sources: animals owned by the household, and those belonging to visiting herders. In addition, women gain significant quantities from sweeping the compound where sheep, goats, and horses are tethered, as 'payment' for the water they bring daily to these livestock. Women use this nutrient source to fertilise their private plots of grain and vegetables. Inorganic fertiliser has almost never been used by villagers, partly because of the long distance to the nearest market (more than 12 hours' walk on foot and by donkey cart), partly due to the difficulty and cost of fertiliser purchase at the market, and partly because of the damage it can cause to crops in years when rainfall is low and poorly distributed. Individual households benefit from particular nutrient sources, such as those with stands of *Faidherbia albida*, in whose shade animals wait during the hot dry season, to be watered at the nearby well. This shade resource brings benefits from the dung deposited there, as well as from the *Faidherbia* leaf litter.

Over the past 30 years, most households in the village of Kala have invested in digging a well on their village fields. Until Mali's independence in 1960, only the *chef du village* was allowed to dig a well. However, legislation immediately following 1960 broke down the traditional prerogative of village chiefs to control access to land and water and, as a result, there has been a boom in well investment. From one private well owned by a household other than the chief's in 1963, there were 27 in 1981 and 46 in 1988.

Water from these wells is exchanged for access to dung, with the many transhumant herding groups who move southwards to this farming zone during the long dry season. In return for watering his stock at the farmer's well, the herder must kraal his animals on the farmer's land overnight. Over a period of several months, the kraal will be shifted to allow a more even spread of dung across the land. The advantage to the farmer is the access this provides to supplies of dung far in excess of that produced by his own animals. For the herder, establishing a contract with a well-owner ensures access to water and also to the relatively favourable grazing resources found in this lightly settled region. Many of these northern farming villages, with their extensive sandy soils are also renowned for producing substantial surpluses of millet and, hence, are good sources of cheap grain in the dry season.

A small number of farm households have also built up very substantial cattle holdings of their own from cash earned through peanut cultivation during the 1950s and 1960s, when rains were plentiful, and in more recent years from sales of millet from their well-fertilised village fields. Such cattle herds provide the farmer with additional sources of manure, in addition to milk, draft power, young animals, and a source of wealth.

Yields of millet from the manured village fields averaged 1000 kg/ha in years receiving 350–400 mm of rainfall, while on the smallest and most heavily fertilised plots, more than 2000 kg/ha was achieved. As a result, the costs of getting a well dug could be recouped in a couple of years.

However, not every household has benefitted from investing in a well, since this requires access to either labour or cash — in the first case for actually digging the well, and in the second for hiring someone else to carry out the work. Thus, the larger households, with sufficient labour and cash, were the first to get wells dug and now own three or four wells each, bringing handsome returns for further investment in cattle, oxen plough teams, and marriage expenses.

The main physical constraint on the system involves the availability of grazing around the village. In years of good rainfall, sufficient pasture in the neighbourhood of the village allows a substantial

number of animals to be maintained through the long dry season. However, when rains have been poor, such as in 1984, by the late dry season in March and April, visiting and village herds may have exhausted easily reached sources of fodder. Visiting herds move elsewhere at this stage, but for village owned stock, such a shift is less easy, and young calves are particularly vulnerable to a shortage of digestible forage. With increasing population density in the region, this extensive system for nutrient cycling will become less viable and farmers will need to invest more time in the careful management and efficient use of smaller quantities of manure.

Rights to dig a well remain in the hands of Bambara farming communities. Fulani and Maure herders are usually refused the right to settle and establish a well of their own. As a result, the Bambara can maintain their control over this source of nutrients of such value to their yields of millet. Should further changes in legislation take place, the Bambara's access to this supply of manure would become less assured.

## Sustainable nutrient cycling in agropastoral systems: Policy issues for the future

A core question that arises from the above analysis of nutrient cycling in agropastoral systems is that of their sustainability. Under conditions of increasing demands for nutrients, can the flows be sustained without depleting the pools from which they come and the consequent loss of productivity? This question is not easy to answer, as it requires a detailed data set for analysing nutrient stocks, flows and balances.

Limited data sets to examine this question are only available for a couple of cases in dryland Africa from which divergent conclusions are reached. The first case is based on data from the Sahel (Burkina Faso and Mali) and offers a gloomy prognosis (van Keulen and Breman, 1990; Breman, 1990b). The second case is based on data from southern Africa (Zimbabwe) and is more optimistic (Swift et al, 1989).

Within the Sahelian region, nutrients are the major limiting factor to production in areas with over 250 mm annual rainfall. Water appears to be a limiting factor only in shallow soils and in dry years, as demonstrated by fertiliser experiments and models which explore yield limitations (Penning de Vries and Djiteye, 1982; van Keulen and Breman, 1990). Some commentators argue that biomass production in the Sahel is under serious threat as fertility inputs continue to decline. A decline in organic recycling through infrequent fallowing, limited re-incorporation of crop residues, and low manure applications are not being compensated for by inputs of inorganic fertiliser (cf. van Keulen and Breman, 1990). The result has been an extensification of agriculture, a shift to areas of relatively high agricultural potential (wetlands, *bas fonds* etc), an increase in animals kept by sedentary agriculturalists, and a movement out of dryland agriculture altogether often through male migration to urban areas. This situation is unsustainable and must be rectified by major investments in the use of inorganic fertilisers as external inputs. Alternatives to inorganic fertiliser are inappropriate, because of the limited potential for significant yield increases, the high labour requirements of most options and the high levels of skill and complex management needed to make the most of low-external input alternatives (Breman, 1990; van Keulen and Breman, 1990).

Modelling studies from Zimbabwe paint a more optimistic picture, through examining the ratio of grazing to arable land required to maintain adequate fertility levels on land under crops. Assuming manure inputs of 10 t/ha per year of high quality manure<sup>1</sup> to be necessary, Swift et al (1989) estimated

1. Although recommended manure input levels are between 10 and 15 t/ha per year (Grant, 1981; Mugwira and Shumba, 1986), actual application rates are far lower. However, the quality of kraal manure is highly variable, with N levels as % of DM ranging from 0.46 to 1.98% (Mugwira and Mukurumbira, 1985; Tanner and Mugwira, 1984). Such levels are far lower than N contents found in manures derived from feedlot cattle or from ranch cattle fed with supplements. Much communal area cattle manure contains high fractions of sand. N levels also vary between seasons with changes in the quality and availability of different fodder.

that a very large grazing area would have to be maintained to sustain arable production, unless increases in N use efficiency were achieved. This simplified rangeland–cropland ratio model assumed blanket applications of manure in dryland fields; this is not how farmers actually manage nutrient cycles in their farms (Turner, 1993). Instead nutrients are focused in time and space. This increases their effectiveness and thus reduces the need for the high levels assumed in this model. A variety of further measures act to increase N-use efficiency in arable systems:

- decreased volatilisation of N during cattle pen storage
- decreased early season leaching of released nutrients
- increased synchronisation of nutrient release and plant demand
- improved mixes of fertility inputs with a variety of release times and other properties
- raised levels of soil organic matter (SOM) or reduced SOM breakdown.

Unfortunately very little agricultural research has been focused to date on such issues in Zimbabwe (or elsewhere). Instead work has concentrated on applications of a single kind of fertiliser (invariably inorganic fertiliser trials) at uniform levels at one time, rather than the management of multiple inputs with fine-tuned application.

Overall, the modelling study from Zimbabwe concluded that sustainable production was possible without high levels of external inputs if there was sufficient grazing land to support nutrient transfers to arable areas, if the grazing land could act as a stable and renewable reservoir for nutrients (particularly through slow nutrient cycling by trees), and if there was a high (and increasing) efficiency of nutrient use on arable land (Swift et al, 1989).

These cases from the Sahel and Zimbabwe outline two contrasting scenarios for the future. The first argues that current practices are unsustainable and, with increasing resource pressure, this will only get worse. As a consequence, either large-scale external nutrient subsidies to the system are required through fertiliser application, or the region will suffer intensified and widespread land degradation, impoverishment and outmigration. The second case emphasises the importance of improved management of existing nutrient pools and flows and increased efficiency with which internal resources are used, combined with low external inputs.

Examples from elsewhere in Africa suggest that opportunities exist for the optimistic scenario, if certain conditions are met. However, it is important to be realistic about what is possible. Farmers will not invest in complex, resource management practices if the right conditions are not met. Many agronomic trials have shown, without dispute, that manure applications result in significant boosts in crop yield (e.g. Jones, 1971; McWalter and Wimble, 1976; Pichot et al, 1981), and extension workers across Africa have long beseeched farmers to adopt manuring and rotation practices. Yet it is only when there are significant and secure returns to the extra labour inputs needed to head-load the manure to fields or transport it in carts (i.e. under conditions of land shortage or severe fertility limitation), that farmers invest in manure use (McIntire et al, 1992).

Current economic conditions in much of sub-Saharan Africa (subsidy removal, exchange rate devaluation, high inflation, retrenchment and reduction in remittance flows with real wage levels) are not conducive to high use of external nutrient inputs. Fertiliser prices are currently out of the reach of most farmers in Africa and, if projections of economic trends are to be believed, this is likely to remain the case for some time. The use of inorganic fertilisers in dryland areas of Africa will therefore remain concentrated on limited and carefully timed applications for particular crops.

High input options may also have other significant costs. Nitrate pollution of drinking water supplies or eutrophication of lakes have resulted from the high input option in many parts of Europe, as well as in parts of Africa, such as near irrigation schemes (Conway and Pretty, 1991). Such environmental and health costs should be taken into account in any policy assessment of alternative options. In Africa, use of organic fertiliser has rarely produced adverse impacts of this sort on a significant scale.

Experience from agropastoral areas of Africa suggests that there are a number of key conditions for sustainable management of nutrient cycles. These include:

- sufficient resource pressure (land scarcity and population pressures) to provide incentives for intensification and investment in nutrient conservation measures on farmland
- market conditions (prices, market access etc) that bring reasonable returns to increased investment
- availability of labour and skills on-farm to permit the careful timing and application of limited nutrient inputs
- socio-economic conditions at the local level that allow relatively assured access to different nutrient pools and their flexible management (e.g. secure tenure, access to livestock, stable exchange relationships between herders and farmers etc).

To make the most of such indigenous methods of nutrient cycling requires a complementary input from researchers into ways of improving nutrient conservation and nutrient harvesting measures, particularly involving the synchronisation of crop growth and application of fertility input mixes within the highly variable environments of dryland Africa.

## References

- Anderson J and Ingram J. 1993. *Tropical soil biology and fertility: A handbook of methods*. Second edition. CABI (Commonwealth Agricultural Bureaux International), Wallingford, UK. 221 pp.
- Bayer W. 1986. Agropastoral herding practices and grazing behaviour of cattle in the subhumid zone of Nigeria. *ILCA Bulletin* 24:8–13. ILCA (International Livestock Centre for Africa), Addis Ababa, Ethiopia.
- Bell R. 1982. The effect of soil nutrient availability on community structure in African ecosystems. In: Huntley B and Walker B (eds), *Ecology of tropical savannas*. Springer Verlag, Berlin, Germany. pp. 193–216.
- Borlaug N. 1992. Small-scale agriculture in Africa. The myths and realities. Feeding the Future. *Newsletter of the Sasakawa African Association* 4:2.
- Boserup E. 1981. *Population and technical change: A study of long term trends*. Chicago University Press, Chicago, Illinois, USA.
- Breman H. 1990a. No sustainability without external inputs. In: *Beyond adjustment. Sub-Saharan Africa*. Africa Seminar, Maastricht, The Netherlands. DGIS, Ministry of Foreign Affairs, Hague, The Netherlands. pp. 124–134.
- Breman H. 1990b. Integrating crops and livestock in southern Mali: Rural development and environmental degradation. In: Rabbinge R, Goudrian J, van Keulen H, Penning de Vries F and Van Laar H (eds), *Theoretical production ecology: Reflections and prospects*. Pudoc, Wageningen, The Netherlands. pp. 277–294.
- Campbell B, Swift M J, Hatton J and Frost P. 1988. Small-scale vegetation patterns and nutrient cycling in miombo woodland. In: Verhoeven J, Heil G and Werger M (eds), *Vegetation structure in relation to carbon and nutrient economy*. SPB Academic Publishing, The Hague, Netherlands. pp. 69–85.
- Carter S. 1992. *Soil fertility management in Mutoko communal area, Zimbabwe*. Tropical Soil Biology and Fertility Programme, UNESCO Nairobi, Kenya. 78 pp.
- Conway G and Pretty J. 1991. *Unwelcome harvest. Agriculture and pollution*. Earthscan Publications, London, UK.
- David R and Ruthven O. 1993. *The effects of male out-migration on women's management of the natural resource base in the Sahel: Summary report of the first phase of the research in Diourbel (Senegal)*. SOS-Sahel International, UK.
- David R, Yabré P and Traoré C. 1993. *The effects of male out-migration on women's management of the natural resource base in the Sahel: Draft report of the research in Burkina Faso*. SOS-Sahel International, UK.
- Ellis F. 1988. *Peasant economics: Farm households and agrarian development*. Cambridge University Press, Cambridge, UK. 257 pp.

- Frost P G H. 1985. Organic matter and nutrient dynamics in a broadleaved African savanna. In: Tohill J C and Mott J J (eds), *Ecology and management of the world's savannas*. Australian Academy of Sciences, Canberra, Australia/CAB (Commonwealth Agricultural Bureaux), Farnham Royal, Bucks, UK. pp. 200–206.
- Frost P, Menaut J, Walker B, Medina E, Solbrig O and Swift M J. 1986. *Responses of savannas to stress and disturbance: A proposal for a collaborative programme of research*. Biological International Special Issue 10. IUBS (International Union of Biological Sciences), Paris, France.
- FSRU (Farming Systems Research Unit). 1993. *Soil fertility management by small holder farmers. A participatory rapid appraisal in Chivi and Mangwende communal areas, Zimbabwe*. FSRU, DR and SS (Department of Research and Specialist Services), Harare, Zimbabwe.
- Grant P. 1981. The fertilisation of sandy soils in peasant agriculture. *Zimbabwe Agricultural Journal* 78:169–175.
- Gryseels G and Anderson F. 1983. *Research on farm and livestock productivity in the central Ethiopian Highlands: Initial results, 1977–1980*. ILCA Research Report 4. ILCA (International Livestock Research Centre for Africa), Addis Ababa, Ethiopia. 52 pp.
- Hill P. 1972. *Rural Hausa: A village and a setting*. Cambridge University Press, Cambridge, UK. 368 pp.
- Holtzman J. 1986. *Stall feeding of cattle in the Mandara mountains of northern Cameroon: Maintaining the economic viability of intensive farming systems in a semi-arid region*. Department of Agricultural Economics, Michigan State University, Michigan, USA. 31 pp.
- Huntley B J. 1982. Southern African savannas. In: Huntley B J and Walker B H (eds), *Ecology of tropical savannas*. Springer Verlag, Berlin, Germany. pp. 101–119.
- Huntley B J and Walker B H (eds). 1982. *Ecology of tropical savannas*. Ecological Studies 42. Springer Verlag, Berlin, Germany. 669 pp.
- Jones M. 1971. The maintenance of soil organic matter under continuous cultivation at Samaru, Nigeria. *Journal of Agricultural Science* 81:483–492.
- Jones W and Egui R. 1987. *Farming systems in Africa: The great lakes highlands of Zaire, Rwanda, Burundi*. Technical Paper 27. World Bank, Washington, DC, USA. 107 pp.
- Kellman M. 1979. Soil enrichment by neotropical savanna trees. *Journal of Ecology* 67:565–577.
- Mbuvi J. 1991. Soil Fertility. In: Mortimore M (ed), *Environmental change and dryland management in Machakos District, Kenya, 1930–1990*. Production Profile. ODI Working Paper 53. ODI (Overseas Development Institute), London, UK.
- McCown R, Haaland G and de Haan C. 1979. The interaction between cultivation and livestock production in semi-arid Africa. *Ecological Studies* 34:297–332.
- McIntire J, Bourzat D and Pingali P. 1992. *Crop-livestock interaction in sub-Saharan Africa*. World Bank Regional and Sectoral Studies, World Bank, Washington, DC, USA. 246 pp.
- Mortimore M. 1989. *Adapting to drought: Farmers, famines and desertification in West Africa*. Cambridge University Press, Cambridge, UK.
- Mortimore M. 1991. *Environmental change and dryland management in Machakos District, Kenya: 1939–1990*. Environmental Profile. Overseas Development Institute Working Paper 53. Overseas Development Institute, London, UK.
- Mugwira L and Mukurumbira L. 1985. Nutrient supply in gpower of different groups of manure from the communal areas and commercial feedlots. *Zimbabwe Agricultural Journal* 83:25–29.
- Mugwira L and Shumba E. 1986. Rate of manure applied in some communal areas and their effect on plant growth and maize grain yields. *Zimbabwe Agricultural Journal* 83:99–104.
- Norman D, Simmons E and Hays H. 1982. *Farming systems in the Nigerian savannas*. Westview, Boulder, Colorado, USA. 275 pp.
- Penning de Vries F W T and Djiteye M A (eds). 1982. *La productivité des pâturages sahéliens, une étude des sols, des végétations et de l'exploitation de cette ressource naturelle*. Agricultural Research Report 918. Pudoc, Wageningen, The Netherlands.
- Pichot J, Sedogo M P, Poulain J F and Arrivets J. 1981. Evolution de la fertilité d'un sol ferrugineux tropical sous l'influence des fumures minérales et organiques. *Agronomie Tropicale* 28:66–77.

- Powell J M. 1986. Manure for cropping: A case study from central Nigeria. *Experimental Agriculture* 22:15–24.
- Powell J M and Mohamed-Saleem M A. 1987. Nitrogen and phosphorous transfers in a crop–livestock system in West Africa. *Agricultural Systems* 25:261–277.
- Pretty J, Guijt I, Scoones I and Thompson J. 1992. Regenerating agriculture: The agroecology of low-external input and community based development. In: Holmberg J (ed), *Policies for a small planet*. Earthscan Publications, London, UK. pp. 91–118.
- Prinsley R and Swift M J. 1986. *Amelioration of soil by trees: A review of current concepts and practices*. Commonwealth Science Council, London, UK. 181 pp.
- Putmann R. 1986. *Grazing in temperate ecosystems: Large herbivores and the ecology of the new forest*. Croom Helm, Beckenham, UK.
- Reijntjes C, Haverkort B and Waters-Bayer A. 1992. *Farming for the future. An introduction to low-external-input and sustainable agriculture*. ILEIA/MacMillan, London, UK.
- Scoones I. 1989. *Patch use by cattle in dryland Zimbabwe: Farmer knowledge and ecological theory*. ODI Pastoral Development Network Paper 28b. Overseas Development Institute, London, UK.
- Scoones I. 1992. *Wetlands in drylands: The agroecology of savanna systems in Africa. Part 1: Overview – ecological, economic and social issues*. IIED (International Institute for Environment and Development), London, UK.
- Sumberg J. 1991. *NGOs and agriculture at the margin: Research, participation and sustainability in West Africa*. ODI Agricultural Administration (Research and Extension) Network Paper 27. ODI (Overseas Development Institute), London, UK.
- Swift M J, Frost P, Campbell B, Hatton J and Wilson K. 1989. Nitrogen cycling in farming systems derived from savanna: Perspectives and challenges. In: Clarholm M and Bergstran L (eds), *Ecology of arable land*. Kluwer, Amsterdam, The Netherlands. pp. 63–76.
- Tanner P and Mugwira L. 1984. Effectiveness of communal area manures as sources of manures for young maize plants. *Zimbabwe Agricultural Journal* 81:31–35.
- Thébaud B. 1993. *Agro-pastoral land management in the Western Sahel: The example of Sebba in the Sahelian region of Burkina Faso*. Case study paper for research workshop on New Directions in African Range Management and Policy, 31 May–4 June, Woburn, UK. IIED/ODI/Commonwealth Secretariat, London.
- Thomas D. 1991. Soil Erosion. In: Mortimore M (ed), *Environmental change and dryland management in Machakos, Kenya, 1930–1990*. Production profile. ODI Working Paper 53. ODI (Overseas Development Institute), London, UK.
- Tiffen M and Mortimore M. 1992. Environment, population growth and productivity in Kenya: A case study of Machakos District. *Development Policy Review* 10:359–387.
- Toulmin C. 1983. *Herders and farmers or farmer-herders and herder-farmers?*. ODI Pastoral Development Network 15d. ODI (Overseas Development Institute), London, UK. 22 pp.
- Toulmin C. 1992a. *Cattle, women and wells: Managing household survival in the Sahel*. Clarendon Press, Oxford, UK. 295 pp.
- Toulmin C. 1992b. *Herding contracts: For better or worse?* ILEIA Newsletter 8:8–9. ILEIA (Information Centre for Low-External-Input and Sustainable Agriculture), Lensen, The Netherlands.
- TSBF (Tropical Soil Biology and Fertility Programme). 1991. *TSBF Annual Report*. UNESCO (United Nations Educational Scientific and Cultural Organization), Nairobi, Kenya.
- TSBF (Tropical Soil Biology and Fertility Programme). 1992. *TSBF Annual Report*. UNESCO (United Nations Educational Scientific and Cultural Organization), Nairobi, Kenya.
- Van Keulen H and Breman H. 1990. Agricultural development in the West African Sahelian region: A cure against hunger? *Agriculture Ecosystems and Environment* 32:177–197.
- Walker B. 1985. The structure and function of savannas: An overview. In: Tohill J and Mott J (eds), *Ecology and management of the world's savannas*. Australian Academy of Sciences, Canberra, Australia. pp. 83–91.
- Watson J. 1977. The use of mounds of the termite *Macrotermes falciger* (Gerstaecker) as a soil amendment. *Journal of Soil Science* 28:664–672.

# Nutrient transfers from livestock in West African agricultural systems

*P.N. de Leeuw,<sup>1</sup> L. Reynolds<sup>2</sup> and B. Rey<sup>3</sup>*

1. International Livestock Centre for Africa (ILCA), P O Box 46847, Nairobi, Kenya

2. 70, Springfield Crescent, Kibworth Beauchamp, Leicester LE8 0LH, UK  
(formerly with ILCA)

3. International Livestock Centre for Africa (ILCA), P O Box 5689, Addis Ababa, Ethiopia

## Abstract

The potential supply of nutrients from excreta voided by livestock and what is potentially available for transfer to cropland are examined within a West African context. Nutrient output from cattle is derived from a simulation model that predicts nutrient intake in relation to animal performance and monthly feed supplies; it subsequently links intake to excreted output of lactating and dry cows and young growing stock, as well as of entire cattle herds. The supply side of potential nutrient transfers is addressed at several scales, from agro-ecological zones to that of individual farmers, by analysing ratios between livestock and farmed and non-farmed land. At a regional scale, focus is on Nigeria and on the cottonbelt in francophone West Africa. The Nigerian situation elucidates the relationships between livestock and land along the rainfall gradient and brings out the multiple interactions between settled smallholder farmers and more mobile agropastoral and transhumant herders. Farming systems in the cottonbelt demonstrate the importance of animal traction and cash cropping as determinants of nutrient-transfer patterns. At the farm level, three case areas are analysed: two in the cottonbelt of Mali and Côte d'Ivoire and one in the closely settled zone in semi-arid Nigeria. These analyses highlight the variable scenarios of nutrient transfers at the farm and village level, demonstrating that heterogeneity among farmers is as much at play as differences between zones and countries. The implications of these nutrient-transfer scenarios are discussed with emphasis on crop–livestock interactions at increasing levels of population pressure and how they may affect pathways of land-use intensification and soil-fertility maintenance.

## Le transfert d'éléments nutritifs par les animaux dans les systèmes agricoles en Afrique de l'Ouest

*P.N. de Leeuw<sup>1</sup>, L. Reynolds<sup>2</sup> et B. Rey<sup>3</sup>*

1. Centre international pour l'élevage en Afrique (CIPEA), P.O.Box 46847, Nairobi (Kenya)

2. 70, Springfield Crescent, Kibworth Beauchamp, Leicester LE8 0LH (R.-U.)  
(précédemment en service au CIPEA)

3. Centre international pour l'élevage en Afrique (CIPEA), B.P. 5689, Addis-Abeba (Ethiopie)

## Résumé

*Cet article évalue l'élimination d'éléments nutritifs dans les déjections des animaux et le transfert potentiel desdits éléments aux terres arables en Afrique de l'Ouest. L'élimination a été déterminée à l'aide d'un modèle de simulation permettant de prédire l'ingestion d'éléments nutritifs compte tenu des performances des animaux et des quantités d'aliments qui leur sont apportées chaque mois. Le modèle rapproche ensuite l'ingestion et l'excrétion pour les vaches en lactation, les vaches tarées et les jeunes en pleine croissance, de même que pour des troupeaux entiers. Le problème de la fourniture*



*d'éléments nutritifs qui peuvent être transférés est abordé à différentes échelles, allant des zones agro-écologiques au niveau du paysan, grâce à l'analyse des rapports entre le cheptel et les terres cultivées ou non. A l'échelle régionale, l'accent a porté sur le Nigéria et la zone cotonnière de l'Afrique de l'Ouest francophone. La situation du Nigéria permet de comprendre les relations entre les effectifs animaux et les terres le long du gradient de pluviosité ainsi que les multiples interactions entre les petits paysans sédentarisés, les éleveurs plus mobiles des systèmes agropastoraux ainsi que les éleveurs transhumants. Les systèmes de production de la zone cotonnière mettent en lumière l'importance de la traction animale et des cultures de rente en tant que déterminants des modes de transfert des éléments nutritifs. Au niveau de l'exploitation, trois études de cas ont été analysées: deux dans la zone cotonnière du Mali et de la Côte d'Ivoire et une dans la zone semi-aride densément peuplée du Nigéria. Ces analyses rendent compte de la variabilité des scénarios de transfert d'éléments nutritifs à l'échelle de l'exploitation et du village, et montrent que l'hétérogénéité des paysans dans un site est aussi importante que les différences entre zones et pays. Les implications de ces scénarios de transfert d'éléments nutritifs sur les interactions élevage-agriculture sont abordées et discutées en rapport avec des densités croissantes de la population et leur effet éventuel sur l'intensité d'utilisation des sols et le maintien de la fertilité du sol.*

## Introduction

Transfers of nutrients from livestock to cropped land are easy to assess when farmers are fully settled and have control over their own land, including grazing areas. For instance, in semi-arid Kenya, farmers own their land in freehold and therefore can manage and allocate their own feed and manure resources (de Leeuw et al, 1990; Tiffen and Mortimore, 1992). Likewise, in the close-settled zone around Kano in semi-arid Nigeria, up to 85% of all land is under cultivation and most feed for livestock is derived from crop residues, farm by-products or is purchased (Mortimore, 1989; Agyemang et al, 1993). Where population pressure is lower and traditional land tenure institutions prevail, there is less human control over land and livestock; hence nutrient transfers from livestock to land are less transparent and more difficult to quantify.

Livestock move on a daily basis from their night enclosures to uncropped land (fallows and natural pastures) and nutrients are lost when excreta are deposited beyond cultivated areas. When livestock are penned or tethered at night, it is assumed that only 60% of the excreta are returned and the remainder is voided on the land grazed during the day (Reynolds and de Leeuw, this volume, pp. ). In many systems, cattle are permanently entrusted to pastoralist herders with several farmers pooling their livestock. Manure accumulates in a common corral, which is emptied once or twice a year (Landais, 1983; Lhoste, 1990). Provided they have labour and transport, farmers may have access to their share of stored nutrients, but their control is diluted by common ownership. Conversely, rich herd owners have their own corrals exerting full control (Bonnet, 1988). In more densely farmed areas, livestock are often kept away from the cropping zone during the growing season for fear of damage to crops. Manure is deposited in distant corrals and may not be transferred to the farmland of the owner; thus, over half the annual nutrient yield from his livestock may be of no benefit to his crops.

Exchange of manure for crop residues and stock water is common where pastoral and settled farmers share the same environment (van Raay, 1974; Powell, 1986; Mortimore, 1991). Owning private wells and a surplus of crop residues may be wealth-biased, benefitting mainly the richer segment of the community (Toulmin, 1983). Pastoral and agropastoral cattle owners, many of whom have large herds, remove nutrients from communal grazing lands which are lost when not transferred through manuring contracts. However, when farming themselves, Peuhl (FulBe) herders tether their animals at night on their cropland around the homestead as do farmers in northern Mali (Toulmin, 1983), in The Gambia (Sumberg, 1992; Sumberg and Gilbert, 1992) and Nigeria (van Raay, 1974; Powell, 1986). As a result, there are farmed fields with high fertility contrasting with nutrient depletion of more distant croplands and natural pastures.

Other mobility patterns involve short-distance transhumance during the dry season, when dry herds (dry cows, male stock etc) are moved away from more densely cropped areas to less-populated locations where rangelands are more plentiful or stock watering is easier (river basins etc). Finally, there are large herds on long-distance transhumance during the dry season foraging on open-access communal grazing lands and crop residues while on the move. Not only do they deprive farmers of their crop residues, but there is no return of excreted nutrients, unless there is an agreement between farmers and herders to kraal on the land. Thus, quantifying nutrient transfer pathways is near impossible where different production systems co-exist within the same spatial context and are exploiting the same feed resources.<sup>1</sup>

This paper commences with a brief review of the potential contribution of ruminant livestock to the nutrient supply of cropland. It summarises the approach and analysis given in Reynolds and de Leeuw (this volume). Thereafter, the supply side of nutrient transfer is addressed at several levels of scale, from the West African subcontinent to the individual farmer. An analysis of the scale of agro-ecological zones within West Africa is deemed necessary to capture the relationships between livestock, farmed and non-farmed land. These ratios determine the potential scope of transfers of nutrients from livestock to crops and provide a framework of limitations and opportunities.

On a regional scale, focus will be on Nigeria, and on the 'cotton belt' in francophone West Africa. Nigeria was chosen because a very detailed data set of livestock populations and land use has become available, the analysis of which will bring out the major factors influencing nutrient transfers from livestock to cropland. The selection of the cottonbelt is justified because of the added dimensions of animal traction and cash cropping.

At the farm level, three 'case areas' are analysed: two in the cottonbelt and one in the closed-settled zone in semi-arid Nigeria. The analyses are aimed at highlighting variable scenarios of nutrient transfers at the farm and village level, demonstrating that heterogeneity among farmers is as much at play as differences between zones and countries.

## **Analytical procedures**

### **The simulation model**

The simulation model (Reynolds and de Leeuw, this volume) predicts dry-matter (DM) and crude-protein (CP) intake, and cattle performance, based on live weight, age, pasture conditions and supplementary feeding using equations developed by Australian workers (SCA, 1990). Intake data are then used to estimate rumen degradation and post-ruminal digestion, from which nitrogen (N) retention and faecal and urine excretion of N are calculated.

The model was first used to examine the effects of on- and off-farm feed supplies and between-farm differences in livestock holdings on the on-farm nutrient inputs from livestock in the coastal zone of Kenya. Also, nutrient requirements for the entire zonal livestock population were calculated and matched with feed resources to predict at what level of rural population density feed demand would exceed supply leading to a reduction in the livestock population. For West Africa, the model is used to simulate the relationships between livestock density and excreted nutrient output.

---

1. In southern Mali, it was estimated that out of the 1.6 million cattle, 25% belonged to transhumant pastoralists. However, in the more densely populated areas only 2% of the cattle were kept in mobile herds, 87% were owned by farmers and 11% by traders and civil servants (Hykoop et al, 1991: 36). In the south-west of Burkina Faso where population density is lower (5% cultivation) pastoralist herds remain important. Some have settled permanently, moving over short distances during the dry season whereas others are long-distance transhumants with permanent homesteads further north (Hellemans and Compere, 1990). In Côte d'Ivoire, 330 000 cattle (or 40% of the total) are classified as transhumant herds owned by Peuhl, although, as in Burkina Faso, many herd owners are in the process of settling. Surprisingly, most Peuhl cattle are found in the better settled areas in the north-west, with densities of 8–15 of rural people/km<sup>2</sup> and a substantial settled cattle population of 3–7 head/km<sup>2</sup> (Landais, 1983: 268). These areas attract Peuhl pastoralists because of potential employment as hired herders, a high demand for milk and low tsetse challenge.

Nutrient output is influenced by the production level of the different age/sex groups in the herd, which can be broadly categorised as lactating and dry cows, and growing stock. Based on average herd structures, it is assumed that these three groups represent 26, 26 and 48% of the herd live weight. Maximum and minimum output of nutrients were simulated for the early wet and late dry season as representative of high and low productivity; this was measured as milk yields in lactating cows and weight changes in dry cows and growing stock (Table 1).

**Table 1.** Simulated feed intake, voided nutrient output and productivity of three major herd groups in the early wet and late dry season.<sup>1</sup>

	Early wet season			Late dry season		
	Lactating cows	Dry cows	Heifers	Lactating cows	Dry cows	Heifers
Weight, kg	250	250	160	250	250	160
Feed parameters						
DM digestibility %	74	74	74	58	58	58
CP, g/kg	107	107	82	68	82	82
Intake, kg/DM per day	6.54	3.76	3.63	4.78	2.83	2.73
Weight change, kg per day	-0.20	0.30	0.30	-0.20	-0.22	-0.10
Excreta						
Faeces, N g per day	54.7	31.4	30.3	32.7	21.3	20.6
Urine, N g per day	41.4	26.9	25.1	21.8	17.9	15.4

1. Cows are 6–7 years old and produce 3.8 litres of milk in the wet and 0.1 litre per day in the dry season during early lactation (100 days post-partum). Weight losses of lactating cows are used as inputs into the model, whereas weight changes of dry cows and 2-year-old heifers are modelled outputs.

Seasonal nitrogen output per TLU (of 250 kg live weight) per day varies from 85 to 54 g per day; with a N recovery rate of 45%, a herd of 100 TLU would deposit 2.3 and 1.5 kg of N per day, respectively, assuming that 60% of the total daily excreta are voided on cropped land. Thus, to achieve an equivalent of 20 kg of voided N/ha before planting early in the wet season, 8.7 nights of tethering would be required (Powell, 1986). Given 1 TLU/per ha of cropland (Table 6) and assuming a fully settled production system, potential transfers add up to 6.9 kg N/ha per year. If instead of a 60% recovery of manure, a 90% rate is assumed, deposition of N per TLU can be boosted to 10 kg N/ha. Such efficiency may be achieved where 80% of the land is cultivated and on-farm feed is the foremost source. Maximum and minimum values for P-uptake are 10.8 g and 4.1 g per day per TLU, respectively, assuming herbage P-contents from 0.2 to 0.1% of DM (Peters, 1992).

The theoretical nutrient supply from faecal DM output can also be calculated from herbage intake and digestibility (Table 1): wet and dry season levels are 1.4 and 1.7 kg DM per day containing 3.2% and 1.6% of faecal N and 0.77% and 0.24% of faecal P, respectively. Thus, wet season faecal output is superior: 100% higher for N and over 200% for P content (assuming that all P is excreted in the faeces).

## Livestock distribution patterns

The framework for the distributional pattern of livestock population in West Africa was derived from Jahnke (1982; Table 2). In his study, numbers of livestock species were listed by agro-ecological zones within countries. Zones were defined by the length of the growing period (LGP): arid, 0–90 days; semi-arid (SA), 90–180 days, subhumid (SH), 180–270 days and humid, >270 days; highlands are defined as land >1500 m asl. The West African analysis included 17 countries as listed in Table 3 and shown in Figure 1. Countries within each of the four zones were subdivided into two groups using the parameters given in Tables 2 and 3. In an analysis for the entire continent, it was found that human and livestock densities and their ratios were sufficient to cluster countries, whereas small ruminant (SR)/cattle ratios were suitable as complementary indicators (de Leeuw and Rey, 1993).

**Table 2.** Land, people and livestock in West Africa by agro-ecological zones in 1979–81.

	Arid <sup>1</sup>	Semi-arid	Subhumid	Humid	Total
	----- millions (or %) -----				
Land	1.7 (32)	1.5 (27)	1.3 (22)	1.0 (19)	5.5
Rural people (number)	7.0 (7)	35.9 (38)	26.6 (28)	25.7 (27)	95.2
Cattle (number)	9.0 (23)	19.6 (51)	7.7 (20)	1.9 (5)	38.7 <sup>2</sup>
Sheep (number)	13.2 (37)	10.0 (28)	6.7 (19)	5.9 (16)	35.8
Goats (number)	14.8 (27)	19.2 (36)	11.6 (22)	8.0 (15)	53.6
TLU (number)	10.8 (29) <sup>3</sup>	16.6 (44)	7.3 (19)	2.8 (7)	37.8
TLU/caput	1.5	0.5	0.3	0.1	0.4
TLU/km <sup>2</sup>	6.4	11.1	5.6	2.8	

1. Excludes hyper-arid land with <100 mm rainfall per annum.

2. Includes 470 000 cattle (340 000 TLU) in the highlands of Nigeria and Cameroon.

3. Includes 1.7 million camels.

Source: Adapted from Jahnke (1982) and de Leeuw and Rey (1993).

## An overview of livestock distributions

West Africa is one of the most important livestock production regions in sub-Saharan Africa, as it harbours 30% of the continents' cattle and 40% of small ruminants on 30% of the total land area (Figure 2). More importantly, 40% of Africa's rural people live in West Africa producing US\$ 21 000 million worth of agricultural products (47% of the total; US\$ 220/capita) of which close to one-fifth is contributed by livestock products. The share of livestock in the total agricultural product value increases along the aridity gradient: about 50% for countries with much arid land, 20% for those located predominantly in the semi-arid and subhumid zones, and decreasing to 10% in the coastal countries. Not included in these product values are the indirect benefits accruing from livestock such as animal traction and the provision of manure nor are other functions such as store of capital accounted for (Winrock International, 1992: 11).

Aggregate relationships between land, people and livestock are set out in Table 2. The rural population density averaged 17.5 people/km<sup>2</sup>, being very low in the arid zone (4) but fairly similar across the other zones (22–25), although intra-zonal heterogeneity is larger (Table 3). The average

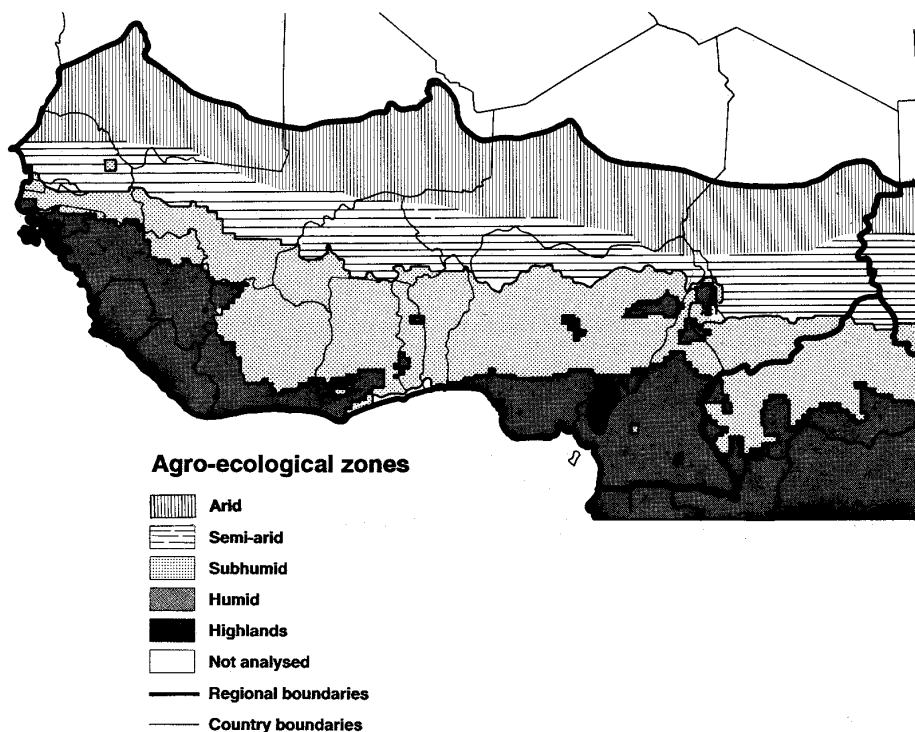
**Figure 1.** Agro-ecological zonation and geographical subdivision of sub-Saharan Africa.

livestock/land ratio equals 7 TLU/km<sup>2</sup> (14 ha/TLU) varying from 2.7 in the humid to 11.1 TLU/km<sup>2</sup> in the semi-arid zone. The zonal distribution also shows that the semi-arid zone contains half the cattle, whereas small ruminants (SR) are more equally distributed; SR/cattle ratios are higher in the arid zone (3.1) and the humid zone (7.3) than in the two other zones. The importance of livestock decreases inversely with rainfall amount, as shown by the decline of TLU/caput from 1.5 in the arid to 0.1 in the humid zone. These trends will be further examined in an analysis of the individual zones.

Distribution patterns have changed substantially over time; between 1980 and 1989, cattle populations rose by 10% and sheep and goats by 27% and 13%, respectively (Winrock International, 1992: 9). While cattle numbers in the drier countries (Mali, Chad and Mauritania) dropped or stagnated, increases of 15–50% were recorded in Nigeria and in several subhumid countries (Cameroon, Ghana and Côte d'Ivoire). In several countries sheep and goats doubled in number; whether these trends represent real increments or reflect more accurate census data remains an open question.

### The arid zone

The main group (Table 3) comprises four Sahelian countries, whose territories extend northwards into the Sahara desert. Human and livestock populations are low whereas livestock wealth is high (1.7 TLU/caput) and similar to that in other arid regions in East and southern Africa (de Leeuw and Rey, 1993). The second group consists of four countries with small strips of arid land along their northern borders. Cross-border livestock trade and transhumance accounts for the high livestock density. Also, the Senegal river and its floodplain forming the border with Mauritania attracts high stocking densities especially during the dry season.

Figure 2. Agro-ecological zonation of Nigeria by States.

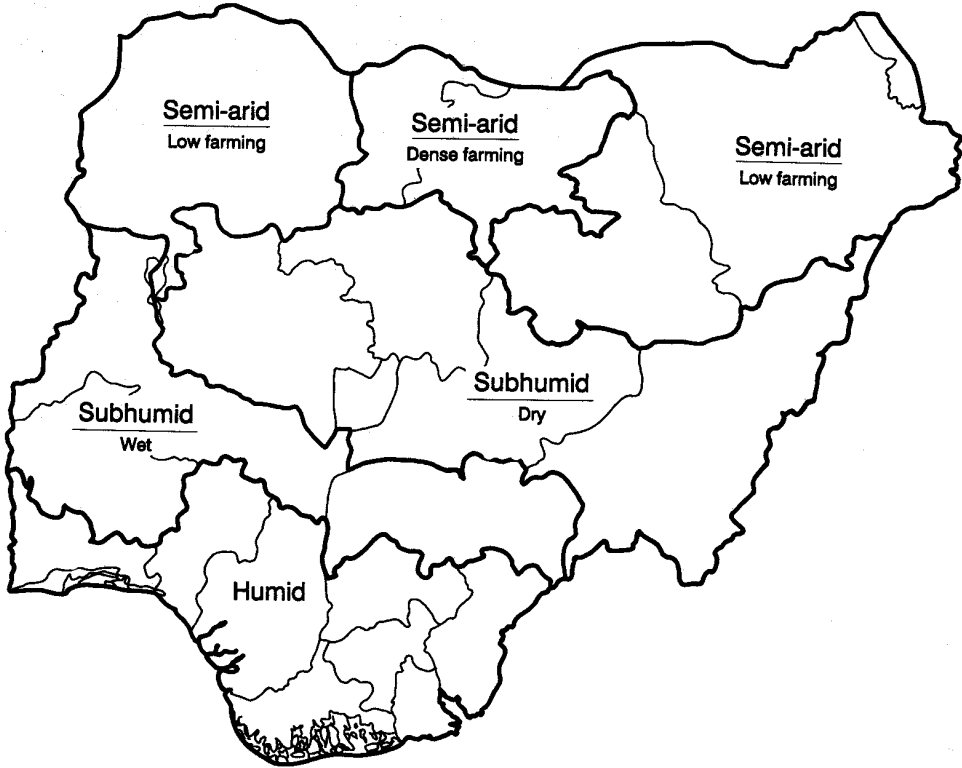

Table 3. Population and livestock densities in West Africa by agro-ecological zone in 1979–81.

	Arid		Semi-arid		Subhumid		Humid	
	1 <sup>a</sup>	2	1	2	1	2	1	2
People/km <sup>2</sup>	3.6	17.5	10.1	36.6	12.3	33.4	11.7	46.7
Cattle/km <sup>2</sup>	4.9	16.2	6.7	18.9	7.8	5.0	0.5	4.2
SR/km <sup>2</sup>	16.1	22.7	10.3	27.8	9.0	22.4	3.7	29.7
TLU/km <sup>2</sup>	6.1	14.1	5.7	16.0	6.4	2.7	0.7	5.9
SR/TLU, %	27	16	18	17	14	39	52	50
Camel/TLU, %	17	4	—	—	—	—	—	—
TLU/caput	1.7	0.8	0.6	0.4	0.5	0.2	0.1	0.1
TLU (% of zonal total)	92	8	25	75	56	44	17	83
Land (" ")	96	4	48	52	53	47	62	38
People (" ")	85	15	20	80	29	71	29	71

a. The countries that make up each group are (major ones are underlined):

Arid: 1. Chad, Mali, Mauritania, Niger

2. Burkina Faso; Cameroon; Nigeria, Senegal

Semi-arid: 1. Benin, Chad, Mali, Mauritania

2. Burkina Faso, Cameroon, Gambia, Niger, Nigeria, Senegal

Subhumid: 1. Benin, Burkina Faso, Cameroon, Chad, Guinea Bissao, Ghana, Guinea

2. Côte d'Ivoire, Nigeria, Sierra Leone, Togo

Humid: 1. Cameroon, Côte d'Ivoire, Liberia, Togo

2. Ghana, Guinea, Nigeria, Sierra Leone

Source: Adapted from Jahnke (1982) and de Leeuw and Rey (1993).

## **The semi-arid zone**

Two major groupings emerge based on differences in human and livestock population densities which appear closely linked. The low-density cluster (1) comprises four francophone countries, two of which are landlocked. In the high-density group (2), Nigeria has the major share and, like the other contributing countries, has a well-developed mixed farming economy often with important cash cropping (groundnuts in Senegal and The Gambia; cotton in Burkina Faso and Cameroon).

## **The subhumid zone**

Two clusters emerged: low-density countries (group 1) of which Ghana and Guinea are the most important in terms of size and livestock population, and high-density countries of which Nigeria and Côte d'Ivoire are prominent (group 2). While in the semi-arid zone there is often a close correspondence between population pressure and livestock numbers, this is less so further south. At the southern end of the zone (LGP>210 days) livestock are less important and small-scale farmers keep mainly small ruminants as they do in the humid zone. Due to southward migratory movements and settlement of pastoralists, and increased agricultural development during the last two decades, this zone has gained greater importance, often at the expense of the drier zones.

## **The humid zone**

The eight countries making up the humid zone fall into two distinct groups due to contrasting human population densities, which are closely linked with that of cattle, SR and overall livestock mass. Countries in group 1 are thinly populated and densely forested, making them rather unsuitable for livestock. While group 2 represents about 40% of the total land, it contains 84% of all zonal cattle and SR, most of which are found in the highly populated coastal areas of Nigeria and Ghana (Table 2).

# **Nigeria**

## **Population estimates**

In the zonal analysis shown in Tables 2 and 3 the overall livestock in Nigeria was estimated at 11.7 million TLU consisting of 12 million cattle, 8.5 million sheep and 24.2 million goats which correspond with the estimates of FAO for 1979–1980. Of this mass, 65% was believed to be in the arid and semi-arid zone, 20% in the subhumid and 13% in the humid zone, giving equivalent densities of 23, 6 and 9 TLU/km<sup>2</sup>, respectively.<sup>2</sup>

These trends can be compared with new estimates and distribution patterns of livestock derived from aerial surveys carried out in the dry and wet seasons of 1990 (RIM, 1992). A preliminary analysis established the following trends using the data of 1979–81, from the zonal analysis as a baseline (Tables 4 and 5):

- Total cattle, sheep and goat numbers increased by 15, 160 and 42%, respectively, contributing to an overall rise in the total livestock mass of 37%.
- Changes in cattle density by zone amounted to a reduction of 15% in the semi-arid and an increase of 270% in the subhumid zone as numbers rose from 1.8 to 6.8 million.
- Small ruminants density increased by 80% in the semi-arid, by 65% in the subhumid and by 55% in the humid zone.
- In the semi-arid zone overall TLU density remained almost unchanged (25 TLU/km<sup>2</sup>), increased from 6 to 14 TLU/km<sup>2</sup> (+ 145%) in the subhumid, but remained at 9 TLU/km<sup>2</sup> in the humid zone.

---

2. FAO statistics for earlier years indicate that in 1963 there were 10.9 million cattle and 28 million small ruminants, whereas the Federal Office of Statistics (FOS) gave estimates for 1960 of 4.4 million cattle and 20 million small stock, and for 1982 of 7.5 million cattle and 43 million smallstock (RIM, 1992: 32). Thus, according to FAO between 1963 and 1979–80, Nigeria's national herd experienced hardly any growth, whereas FOS data showed a 70% growth in cattle and a 115% growth in smallstock numbers.

These aerial surveys confirm earlier evidence of a large permanent influx of cattle into the subhumid zone, but refuted the hypothesis that this shift has reduced the grazing pressure in the semi-arid zone. Even though cattle numbers dropped somewhat, small ruminants rose concomitantly, undoubtedly because in the more densely farmed areas, there has been a switch from cattle to small stock (Table 5) causing the overall grazing pressure to increase to 33 TLU/km<sup>2</sup> (Table 4).

Other changes are also evident: as there was little difference between zonal populations in the wet and dry season, it appears that long-distance transhumance has declined (Table 4). Even at the State level, seasonal changes were minor, but south-bound shifts within states during the dry season remained important.

**Table 4.** *Distribution of TLUs and cattle in Nigeria by agro-ecological zone, 1990.*

Zone	Land %	Crops %	TLU			Cattle		
			%	x10 <sup>6</sup>	no./km <sup>2</sup>	x10 <sup>6(a)</sup>	WS(b)	DS <sup>(b)</sup>
Semi-arid-low <sup>(c)</sup>	31	26	40	6.5	23	6.2	45	44
Semi-arid-high	7	58	14	2.2	33	1.7	13	11
Total (mean)	38	(31)	54	8.7	(25)	7.9	58	5
Subhumid-dry	29	20	28	4.4	17	4.9	35	35
Subhumid-wet	16	14	9	1.5	10	0.9	6	8
Total (mean)	45	(18)	37	5.9	(14)	5.8	41	43
Humid	17	22	9	1.4	9	0.2	1	2
Total	100	100	100	16.0	17.5	13.9	100	100

(a) Mean for wet and dry season estimates.

(b) Per cent of total population in the wet (WS) and in the dry season (DS).

(c) Per cent of total land under cropping, grouped as low or high.

Source: Adapted from RIM (1992).

**Table 5.** *Distribution of small ruminants in Nigeria, 1990.*

Zones	Total x10 <sup>6</sup>	SR/km <sup>2</sup>	% of TLU	Goats/sheep
Semi-arid, low <sup>1</sup>	16.9	60	26	1.2
Semi-arid, high	9.1	135	41	1.1
Total (mean)	26.0	(74)	(30)	(1.2)
Subhumid, dry	9.6	36	21	1.6
Subhumid, wet	8.0	53	54	2.1
Total (mean)	17.6	(42)	(30)	(1.8)
Humid	12.9	83	91	2.4
Total (mean)	56.5	(61)	(35)	(1.6)

1. Per cent of active cropping, see Table 4.

Source: Adapted from RIM (1992).



## **Ownership and distribution patterns**

A distinction can be made between livestock belonging to settled farmers (i.e. village-based) and pastoral livestock belonging to and managed by mostly FulBe herd owners.<sup>3</sup>

Although transfers of nutrients from FulBe herds to non-FulBe farmland are common, they are less transparent in space and time than those from settled livestock, due to herd mobility and the individual nature of manuring contracts.

Zonal differences are also important. Whereas in the semi-arid zone, there is a high level of integration between pastoral and settled farming systems, this linkage is weaker further south. In the north, most FulBe are assimilated into the settled population through culture and religion and the majority are agropastoralists (van Raay, 1974; Norman, 1978). In the subhumid middle belt on the contrary, there is a large diversity of tribes, differing in culture, farming practices and attitudes to livestock husbandry. Some tribes own hardly any livestock, whereas others concentrate on cut-and-carry fattening of a few cattle, on large-scale milk production competing with FulBe herd owners, or keep cattle for animal traction (Blench et al, 1985).

Since interactions are mostly based on exchange of manure for residues from cereal and grain legume crops, the predominance of root crops in small-holder farms in the southern subhumid zone, is an impediment.

To estimate the potential levels of manure deposits on farmed land, the TLU density per ha of farmland is used as a proxy. TLU mass was divided into pastoral and village/urban, because on-farm livestock are likely to transfer a larger proportion of their voided nutrients to cropland than do pastoral herds. Across states, TLU per ha of cropped land ranged from 1.4 ha in states where the fraction of cultivated land was low, to where either livestock population was low or cropping density was high. In the aggregate, this on-farm livestock mass consisted of 64% SR, 27% cattle and 9% equines (Table 6). This distribution shows the importance of small ruminants for the farmer-controlled nutrient supply and explains the importance of incorporating pastoral cattle into nutrient transfer transactions as they constitute 57% of the overall livestock biomass.

Patterns of SR ownership by village-based farmers varied. In the densely populated semi-arid zone, farmers owned 14–24 head, as compared to 8–11 head in the drier parts, declining to 4–7 head in the wetter parts of the subhumid zone. In 1983, a survey around Abuja showed that only 56% of the farmers kept SR, each owning on average 13 sheep and 12 goats (von Kaufmann and Blench, 1986: 54). Since average farm size in the wetter SH zone was 2.0–2.5 ha, there are about 10 head/ha of farmed land.

In the humid zone, SR densities are high ranging from 75–150 head/km<sup>2</sup> (Table 5). However, within-state differences are large: in Anambra State, 30% of the Local Government Areas had <50 head/km<sup>2</sup> and 35% had >100 head/km<sup>2</sup> giving a mean density of 100 SR/km<sup>2</sup> (RIM, 1989: 20). Due to the high population density and small farm size, ownership per household is low, averaging about three head. Nonetheless, given that about 20% of the land is cropped, there are five head/ha of farmed land. Livestock are mainly kept in the compound farms with intensive cropping of food crops combined with multi-purpose trees. Most of these home gardens are <0.5 ha in size and SR play a major role in fertility maintenance (Okafor and Fernandes, 1987: 414).

One of the most pertinent trends emerging from a decade of aerial surveys in Nigeria, is the close association between cropping and livestock density. These linkages operate at two levels. As the majority of farmers keep several livestock species, their density is likely to increase with a rising rural population and the proportion of cropped land (Blench et al, 1986; RIM, 1992). However, trends were less evident for the more mobile herds of (agro) pastoral FulBe, consequently regression equations of percentages of cropped land on cattle and SR densities, combining village and pastoral

---

3. The RIM survey data were presented in three groupings village- or urban-based derived from ground surveys, and pastoral (Table 6); (RIM, 1992: 3).

stock were not significant whether data for states or data from previous smaller-scale aerial surveys were aggregated.

The association between cropped land and livestock points to two concurrent trends: to a strengthening of crop–livestock interactions in the more densely settled farming communities, and to the continuing penetration of FulBe herders into the less populated space of the subhumid zone. However, as in the cotton belt, spatial patterns of livestock ownerships have become very complex not only because different tribal groups are using the same space but also because each group uses different movement patterns for their herds. As a result, balances between nutrients removed and returned by livestock to land are difficult to quantify.

**Table 6.** Livestock densities per hectare of cropped land by agro-ecological zone in Nigeria.

	Semi-arid		Subhumid		Mean
Fraction cropped,%	25	57	29	22	24
TLU per ha					
On-farm <sup>1</sup>	0.35	0.37	0.26	0.41	0.34 <sup>2</sup>
Pastoral	0.55	0.21	0.58	0.28	0.45
Total	0.90	0.58	0.84	0.28	0.79
Fraction on-farm, %					
Cattle	17	34	11	12	17
Sheep	76	92	87	96	85
Goats	87	99	100	100	95
Overall	39	64	31	59	43

1. On-farm and pastoral livestock were separated by proportional allocation to habitation types recorded during aerial surveys and ground counts in villages and towns.

2. Total includes 1.1 million horses and donkeys.

Source: RIM (1989; 1992).

## The cotton belt

Cotton lint production in West and central Africa reached a total of 428 000 t in 1989/90, equivalent to 1 million t of seed cotton. Mali and Côte d'Ivoire are the major producers, accounting for about half of the total output. Land cropped to cotton was close to 1 million ha indicating an average yield of 1 t of seed cotton per ha. Average yields reached 1.2 t/ha in Mali, Côte d'Ivoire, Senegal and Cameroon but were lower (0.6–1.0 t/ha) in the other countries, probably due to lower levels of mechanisation, and of fertiliser, manure and insecticide applications (Table 7).

Cotton production became an important cash crop in the early 1960s when total seed cotton production reached 120 000 t, 80% of which was produced in central Africa. Ten years later overall output had tripled with the West and central African region producing equal shares. Between 1971–72 and 1987–88, West African output rose from 180 000 to 720 000 t, an increase of 450% as compared to a rise of only 67% in central Africa.

**Table 7.** *The importance of cotton production in francophone West and central Africa in 1989/90.*

	Output of cotton lint 1000 t	Area 1000 ha	Mechanised % of area	Chemical fertiliser % of area
West Africa				
Burkina Faso	62.4	150	75	90
Mali	98.7	178	91	95
Côte d'Ivoire	107.5	201	41	96
Others <sup>1</sup>	47.7	110	17	96
Central Africa				
Chad	57.9	185	90	63
Others <sup>2</sup>	53.8	128	65	75
Total	428.0	952	66	86

1. Niger, Senegal, Togo.

2. Central African Republic (CAR) and Cameroon.

Source: Afrique Agriculture (1991).

Cotton growing has had a major impact on the spatial distribution of cattle. In 1987–88, the areas of intensive cotton production in southern Mali, the south-western part of Burkina Faso and northern Côte d'Ivoire harboured some 3.3 million cattle. Livestock densities varied from more than 20 TLU/km<sup>2</sup> in the high-intensity areas to as low as 1 TLU/km<sup>2</sup> where cotton production was introduced only recently; however, most of the cattle are found in areas with growing periods of 120 to 210 days (Table 8).

**Table 8.** *Cattle populations (thousands) and TLU density in the West African cotton zone by country and agro-ecological zone, 1987–88.*

Zonation by LGP, days <sup>1</sup>	Mali		Burkina Faso		Côte d'Ivoire	
	Cattle x10 <sup>3</sup>	TLU km <sup>2</sup>	Cattle x10 <sup>3</sup>	TLU/ km <sup>2</sup>	Cattle x10 <sup>3</sup>	TLU/ km <sup>2</sup>
90–100	111	9.9	–	–	–	–
120–150	690	18.3	900	8.1	–	–
150–210	746	9.9	270	5.6	582 <sup>2</sup>	15.4
	–	–	–	–	29 <sup>3</sup>	1.2
210–270	–	–	–	–	35	0.9
Total	1547		1170		646	

1. LGP = Length of growing period.

2. North-central.

3. North-west.

Source: Lhoste (1990: 41).

Ratios of oxen owned per ha of cotton cultivated with traction vary. The greatest portions of cotton areas cultivated by oxen are in Mali and Burkina Faso and lowest in Côte d'Ivoire (Table 7). In Mali, in the 1980s the number of oxen increased by 11% and cotton production by 15% per annum. Output per ox owned rose due to the intensification of land use, increased mechanisation and use of manure and inorganic fertilisers (Adesina, 1992).

It was estimated that in Mali about 30% of all cropped land received manure. Manure management was improved by adding bedding (of maize straw and cotton stalks) in corrals, while the increased availability of transport equipment facilitated manure transfer to the field (Traoré, 1990). Chemical fertiliser use on cotton has become widespread although it is not clear how much is applied and to what extent other crops are fertilised (Table 7). Intensification of mechanisation and transport has occurred as shown by the rising number of animal-drawn seeders, harrows and donkey and ox-carts, the latter increasing by 14% per year. Whereas cotton-growing encouraged animal traction use, mechanisation including row-seeding and weeding is spreading to other crops, in particular maize, but less to sorghum and millet.

The cultivation of leguminous forage crops has been promoted both for fertility maintenance and production of livestock feed. In Mali, 20 000 ha are devoted to forage crops with dual-purpose cowpeas varieties, *Dolichos* and *Stylosanthes* spp as the main species (Hykoop et al, 1991; Traoré, 1990). In Côte d'Ivoire, pigeon pea and multi-purpose trees are used for both improved fallows and hedges. To assist in the extension of forage growing on fallow land, large-scale seed production on 840 ha produced 24 t of seed, mostly of *S. hamata*, *Aeschynomene histrix* and *Panicum maximum* (Soh, 1990).

### Spatial dimensions of nutrient transfer

While nutrient transfers can be viewed within the context of individual farms, a wider spatial perspective is needed when analysing transfers between ecosystem components. These involve two levels: actual or potential exchanges of feed and manure between farmers and transfers from fallows and communally owned natural pastures. These complex interactions arise from the intermingling of what in essence are different farming systems. This will be illustrated by two examples in the cotton belt: one from northern Mali where there has been a long tradition of intensive cash cropping, and the other from northern Côte d'Ivoire, where ox-drawn cropping of cotton was introduced more recently.

The example from Mali shows the large diversity of farmers in terms of land, oxen, other livestock they own and the use of inputs. There are two wealthy groups: long-established Bambara farmers growing cotton with ample animal power and equipment to till, sow and weed crops, and to transport manure from, and crop residues and bush grass to, the homestead. They receive income from sales of cotton, surplus grain and livestock. Similarly, more recently settled Peuhl are rich in livestock enabling them to manure their land, produce and train their own oxen, and sell surplus grain. Farmers can conveniently be divided into two classes: rich and poor in livestock. They differ in farm size (17 vs 4 ha) and in oxen/land ratios (0.23 vs 0.10 oxen/ha) which have implications for nutrient transfer as shown by the high manure use of the 'rich' group (Table 9).

**Table 9.** Characteristics of four types of farm enterprises in the northern cotton zone of Mali.

	Tribes			Peuhl Large
	Large	Medium	Small	
Total land, ha	17	10	4	11
Cotton, ha	3.4	1.7	0.6	–
Oxen, number	4.0	1.6	0.4	3.7
Cattle, number	25	3	–	35
Smallstock, number	23	5	–	11
Manure, carts/ha	4.0	3.0	–	3.2
Fertiliser, kg/ha	40	50	–	not known

Source: Bonnet (1988).

Although theoretically there is common access to grazing land (stocked at an overall level of 15 TLU/km<sup>2</sup>), the location of corrals and the territorial claims of individual villages sharing communal land, has reduced access. In the growing season, mobility is further restricted by cropping. As a result, half the livestock had access to land stocked at 2 ha/TLU, 28% to about 5 ha and remaining 14% could graze up to 15 ha of land per TLU. In the dry season, 40% of the livestock had access to only 3 ha/TLU, whereas the other 60% had 7–13 ha of grazing land (Bonnet, 1988). It can therefore be concluded that soil nutrient balances not only differ between farms within the same location because of livestock wealth, but are also influenced by grazing rights at the higher spatial level of villages and neighbourhoods.

In Côte d'Ivoire, a survey of almost 3000 farmers identified five farm-types using livestock wealth and degree of mechanisation as criteria. These types were classified as livestock-rich (20%) and livestock-poor (80%). Farmers with large livestock wealth (possessing over 10 TLU) also had more land, oxen, farm equipment and greater investments in housing and other assets. Farmers with little or no livestock, owned on average 0.3 oxen, and at the most a few sheep and goats. As a result of this disparity in wealth, the "rich" farmers used more inputs (fertilisers and insecticides) especially on cotton and maize. On-farm feed sufficiency showed a reverse trend. It varied from over 5 t/TLU to 0.4 t/TLU for the livestock-poor and the livestock-rich groups, respectively (Table 10).

On a large spatial scale this skewed distribution of livestock has implications for the balance of feed and nutrients. Since cropping patterns did not change substantially with livestock wealth (Table 10), the livestock-poor farmers owned 70% of the farmed land and its potential crop residue output. In contrast, they owned 45% of all oxen, but only 12% of the total livestock (Table 11). When viewing the distribution of farmers in the aggregate, the overall feed supply amounted to 1.3 t of crop residues per TLU consisting of 70% cereal straw and 30% higher quality leguminous feed (Table 10).

**Table 10.** Characteristics of farms with high and low livestock wealth in northern Côte d'Ivoire.

Parameters	Livestock wealth	
	High	Low
Cropped land, ha	6.9	4.2
Work oxen, number	1.6	0.3
Total livestock, TLU numbers	14.3	0.5
Cropping pattern, % of total land		
Maize	26	23
Rice	12	13
Cotton	24	24
Groundnuts	12	21
Other crops	26	19
On-farm feed, t DM per farm <sup>1</sup>		
Cereal straw	4.2	3.0
Crop residues	0.6	0.4
Groundnut haulms	0.6	0.3
Total	5.4	3.7
Feed, t DM/TLU	0.4	5.3
Feed, t DM/oxen	3.9	8.1 <sup>2</sup>

1. Edible residues in t DM/ha: maize 1.4; rice 2.0; cotton 0.6; groundnuts 0.6 as given by Leloup and Traoré (1989) in southern Mali.

2. For farmers owning livestock (60% of the low wealth group).

Source: Adapted from Schuetterle and Coulibaly (1988).

As the overall stocking rate is 1.5 ha per TLU of farmed land, the theoretical N-transfer from required feed consumed by all stock would amount to 4.7 kg/ha (Table 11). However, as they own 88% of the livestock, each rich farmer transfers nutrients from 109 ha of grazing land amounting to 79 kg of N and 36 kg of P. Of the total nutrients derived from livestock, only 22% originates from crop residues in the rich farm compared to 58% for the poor farmer. As the wealthy farmers own 2 TLU/ha of farmed land, there is a potential annual transfer of 14.5 kg of N/ha and 5.6 kg of P (Table 11).

To improve the nutrient cycling of the entire system, there should be an exchange of feed for manure between the two strata. In practice, it seems likely that the wealthy farmers have the potential capacity to maintain fertility due to their livestock wealth and their financial resources. The majority of farmers, on the contrary, are poor in assets, cash income and livestock, and therefore incapable of countering the nutrient depletion of their cropland, although the surplus of 0.8 t of residues per ha of cropped land could be incorporated into the soil to retard the process.

**Table 11.** Land, feed and nitrogen allocations in a hypothetical village of 100 farmers in northern Côte d'Ivoire.<sup>1</sup>

Parameters	Livestock wealth		
	High	Low	Total
Number of farmers	20	80	100
Farmed land, ha (%)	138 (29)	336 (71)	474
Crop residues, t (%)	108 (27)	296 (73)	404
Amount fed, t	108	40	148
TLU, number (%)	286 (88)	40 (12)	326
Natural pasture, ha	2174	304	2478
Total land, ha	2312	640	2952 <sup>2</sup>
Nitrogen transfer			
From pasture, kg	1539	116	1655
From farm, kg	434	160	594
Total	1973	276	2249
Transfer, kg N/ha	14.3	0.8	4.7

1. Assumptions: intake/TLU: 1.73 t DM/yr or 4.9 kg per day; average N content of feed: 15 g/kg; total N excreted is 25.5 kg/TLU/yr of which 60% is stored on farm and 55% is lost; N transfer is 6.9 kg N/TLU/yr. (See Reynolds and de Leeuw, this volume and Table 1)

2. The survey area had an estimated livestock density of 10–11 TLU/km<sup>2</sup> (Landais, 1983; Lhoste, 1990), which was used to calculate the extent of natural pastures available to the "village".

## The closed-settled zone in Nigeria

In Nigeria, intensively managed crop–livestock systems are predominant in Katsina and Kano states covering some 70 000 km<sup>2</sup> and receiving an annual rainfall of 750–1000 mm (RIM, 1992).<sup>4</sup>

The fraction of land under cultivation varies from 60–85% and densities of up to 400 people/km<sup>2</sup> have been reported (Mortimore, 1989). At this high pressure only 9% of the farmers owned cattle, but most kept SR (mean 13 per household) and donkeys (0.8; Mortimore, 1991: 79).<sup>5</sup>

4. Cattle, sheep and goat densities of 20–50, 50–150 and 50–200 head/km<sup>2</sup>, respectively, are indicative of the high level of livestock integration (Tables 4 and 5). Points of interaction are the collection and storage of crop residues, high levels of manure application often combined with inorganic fertilisers and high cover of useful farm trees providing fruits, fuelwood, browse and litter for soil fertility enhancement (Mortimore, 1989; 1991).

5. High rural population densities of 100–400 persons/km<sup>2</sup> were prevailing as early as 1952 (Fricke, 1979). Mortimore (1991: 6) stated that in 1962 around Kano town, the rural population density averaged 235 persons/km<sup>2</sup>, rising to 350/km<sup>2</sup> in the densest areas. Assuming a net increase of 1.4% this rate would have generated an average density of 350 persons/km<sup>2</sup> or 0.24 ha of arable land per head in 1990. Comparisons of aerial photo cover in 1965 and 1981 showed no change in the proportion of cultivated upland, which had reached a maximum level of 85% as early as 1965.

At a slightly lower population pressures of about 300 rural people/km<sup>2</sup>, 60% of the farmers still retain cattle, many of which are used for traction and milk production (Agyemang et al, 1993). Average livestock owned was four cattle and 22 SR, while farm size averaged 3.3 ha. Consequently, the on-farm stocking rate amounted to 1.5 TLU/ha, or, since about 70% of the land is farmed, to 100 TLU/km<sup>2</sup>. About 20 t of dry manure is applied on 1.2 ha of land (ranging from 0.5–1.5) in a rotation of one year in three. Such high applications are quite common in Kano State where the average is estimated at about 4 t/ha per season (Mortimore, 1989: 28). Responses of sorghum and millet were estimated at 45 kg and 30 kg per t of manure applied, giving yields of 2.5 and 2.2 t/ha of grain, respectively (Agyemang et al, 1993). These yields are higher than the 1.8 t/ha on fertilised fields reported by Mortimore (1989: 29) and are attributed to oxen tillage combined with manuring.

Feed supplies are limited and most farmers purchase feed spending an equivalent of 1460 Naira (US\$ 70) on average per annum (Mortimore, 1989). On-farm feed resources were estimated at about 1.5 t DM/ha, 40% of which consisted of high-quality groundnut haulms and cowpea hay (Hendy, 1977). Assuming that purchased feeds were high in energy (brans etc) and in protein (oil-cakes), 100 TLU/km<sup>2</sup> can be maintained provided that browse from farm trees and herbage from grazing land are efficiently utilised.

A stocking rate of 4 TLU per manured hectare is unlikely to provide 20 t manure, suggesting that manure was mixed before application with household refuse, ash and feed residues or that outside sources of manure were available.<sup>6</sup> Transfer of N from the actual on-farm animals — given the high level of feeding — may add 48 kg of N per hectare.<sup>7</sup>

## Discussion

### Temporal patterns of manure deposition

Differences in manure output and quality are large because of changes in feed intake of livestock driven by pulses in productivity during periods of high feed supplies (Table 1). For growing stock, weight gains coincide with the rainy season, being high (up to 1 kg per day) in the early part, tapering off towards the end. For reproductive stock, late pregnancy and early lactation are periods of high feed demand; these may coincide with favourable feed supply or, when conception occurs in June–July, may fall in low-feed periods (de Leeuw and Wilson, 1987).

Farmers exploit this upsurge in high-quality manure output by tethering their stock on cropland after the first rains but before tillage begins. Powell (1986) indicated that daily voided nutrients per TLU were up to fourfold higher than those in the late dry season due to a doubling of manure output and its quality. In addition, as the time interval between deposits and incorporation into the soil is short, losses are low.

Most manuring contracts involve exchanges of manure for access to crop residues, water and temporary shelter. Hence the period from late November to early February witnesses the highest inputs from itinerant and local sedentary cattle alike. During this time transhumant herds are moved closer to high-residue areas, whereas settled farmers and FulBe tether their stock on their own fields. Rotational night-paddocking may continue throughout the dry season, although transhumant herds usually move to floodplains and to savannah grazing to exploit post-fire regrowth and browse.

### Spatial patterns of manure deposition

Soil fertility enhancement from manuring is spatially variant extending from differences between farmers within the same village, to regional differences. The latter depend on the rural population

6. That manure was adulterated with other material is shown by its nutrient content of 0.5% N on a DM basis, suggesting a "dilution" of 50–60% (Mortimore, 1989).

7. With an assumed 55% loss, a 90% on-farm excreta rate and a 10% N retention for production, total output equals 12 kg N/TLU derived from 2.2 t DM per TLU of feed containing 1.5% N.

density influencing farm size and feed resources, on the degree of animal-powered mechanisation, on crop mixtures (in particular root vs grain crops) and on cultural attitudes to livestock keeping. Furthermore, management practices related to herding, kraaling and tethering stock impinge on nutrient capture, storage and its allocation to land. The other factors governing nutrient transfers are herd and flock size, the degree of control the owner has over their management and their actual location over time in relation to cropland. When in full control, farmers can direct the allocation of nutrients in space and over time according to their own priorities.

Within individual farms, further disparities in soil fertility are caused by selective application to specific crops. In Mali, maize is grown as a cash crop and more heavily manured than sorghum and millet which are mostly used for home consumption. Likewise, in Nigeria, farmers grow ginger as the principal cash crop and engage FulBe herds in high-intensity manuring (Powell, 1986).

Due to these interacting variables, actual nutrient returns from livestock to the land create patchworks or mosaics of land with contrasting fertility status. At the upper end there are small-scale highly integrated farming systems in close-settled areas, farms with elevated ratios of livestock to land, as demonstrated by well-mechanised farms in the cottonbelt and FulBe agropastoralists with 50 cattle and <2 ha of cropland. Such "nutrient-rich islands" intermingle with stockless farmers with nutrient-depleted croplands. Thus, inequity of the fertility status of land further widens the disparities caused by livestock wealth, farm size and associated higher incomes. However, it may be argued that although they are "mining" communal rangelands to enrich their own farms only the wealthy can afford the costs associated with efficient manure management and use.

## **Manure, crop yields and forage legumes**

The utilisation by farmers of the nutrients voided by livestock depends on expected benefits and costs. Although manuring of cropland enhances soil fertility, farmers are more likely to view the short-term increases in crop yields as the principal benefits, which they then weigh against manuring costs. Therefore, low-cost nutrient transfers are preferred such as tethering stock on land rather than storing manure in corrals requiring labour-intensive collection and distribution.

Crop responses to manure, as reviewed by McIntire et al (1992: 78) were variable and low ranging from 15 to 86 kg of grain/t of manure in cereals and from 14 to 27 kg of groundnuts. When manure application was combined with chemical fertilisers up to 94 kg of grain was produced. While confirming that manuring was widespread in drier West Africa, McIntire et al (1992: 88) stressed that low applications (0.1–0.9 t/ha) were most common; with an average response of 50 kg of grain/t manure, benefit/cost ratios were unattractive because of the high transport cost, discouraging heavier applications.

Powell (1986) confirmed the low levels of application in areas with low cattle/land ratios but indicated that higher rates (1.9–4.0 t) were applied when cattle/land ratios increased in tandem with the percentage of cropped land. He showed that Peuhl farmers possessing 50 cattle could potentially deposit 6.9 t of manure in the dry season and 5.5 t in the early wet season on 1 ha of crops every second year, requiring a total of 90 days of night-tethering per year. This application of 5.5 t produced 2.3 t/ha being equivalent to 1.0 t of incremental grain of maize or 180 kg/t of manure. Similar responses were reported from the semi-arid zone of Kenya with bimodal rainfall. Ikombo (1989) found low first-season responses of 44 kg of maize/t of manure when rainfall and resulting yields were low (0.4 to 0.8 t/ha). This compared to 178 kg when seasonal rainfall was favourable producing control yields of 1.2 to 2.2 t/ha. Combining three seasons, total increments ranged from 40 to 300 kg/t, the best performances coming from a single first-year application of 8–16 t of manure/ha. The residual effects persisted up to the third cropping season and amounted to 135 kg and 170 kg of grain/t of manure in the second and third seasons with good rains, in contrast to an average of 70 kg in less favourable seasons.



An example from Kenya by Smaling et al (1992) reported on the interactions between fertilisers and manure on maize yields.<sup>8</sup> They showed that 5 t of manure per season, containing 75 kg of N and 25 kg of P, remedied deficiencies in two high-potential sites and increased maize yields from 3.2 t to 5.4 t/ha, an average response of 440 kg/t of manure. At the coastal site, this amount of nutrients was insufficient to raise yields above the control yield of 1.6 t/ha. When manure was combined with remedial N or P fertiliser, increments were 590 kg in the high potential, and 350 kg/t of manure in the low potential site. The incremental effect of manure as a supplement to fertiliser application was lower, being 350 kg in the favourable sites and 140 kg/t of manure when measured in the low-potential location.

Since intercropping of cereals with grain legumes is common practice and the promotion of improved fallows through forage legume seeding has received high research priority, the importance of manure as a source of phosphorus needs urgent consideration. At a P-content of 0.3%, 5 t of dry manure can provide 15 kg of P which is sufficient for successful *Stylosanthes* spp establishment (Otsyina et al, 1987; Peters, 1992). Hence, the contribution of manure in crop rotations where forage legumes are grown in short-term fallow periods warrants further emphasis. Assuming that most nitrogen can be derived from legume crops, retention of sufficient soil P through manure may become the essential component of long-term integrated fertility management (Smaling et al, 1992; de Leeuw, 1994).

### Grazing pressure and nutrient removal

With a total population of 38 million TLU in West Africa, the theoretical manure output would be in the order of 19 million t, if the entire production of 0.5 t/TLU per year were utilised (Table 1). However, most transfers are confined to the semi-arid and subhumid zones comprising 24 million TLU at an average density of 8.6 TLU/km<sup>2</sup>. Assuming that 20% of all land is cultivated, this would convert 0.43 TLU/ha, although in several areas higher ratios obtain (e.g. Nigeria, Tables 4 and 6).

In terms of nutrients, the total population of 24 million TLU could provide manure containing 144 000 t of N (1.2%) and 36 000 t of P (0.3%). This results in a potential annual transfer of 2.5 kg of N and 0.6 kg of P per ha of cropped land. When expressed in potential incremental grain yields, this manure output would convert to 1.2 million t of grain if a conservative ratio of 100 kg of grain/t of manure DM is taken. This is a 5% increase above the total cereal production of West Africa of 22.8 million tonnes in 1987.<sup>9</sup> A higher potential rise in production could be achieved if manure management were improved and urine-N were better captured. However, actual increase due to manure is currently much lower as only a small fraction of the manure is deposited on cropped land.

Substantial growth of the livestock population would be an additional solution. It was shown that in the closed-settled zone in Nigeria, densities of up to 100 TLU/km<sup>2</sup> can be maintained in a sustainable farming system (Mortimore, 1989). Conversely, the current level of stocking (Table 3) in the two main zones is below their livestock support capacity. This was estimated at 17 TLU/km<sup>2</sup> for the semi-arid and 22 TLU km<sup>2</sup> for the subhumid zone (Winrock International, 1992: 35–36); such densities are approached or surpassed only in the cottonbelt (Table 7) and in Nigeria (Table 4).

In estimates of support capacity based on feed demand and supply ratios, feed on offer is conservatively targeted to prevent overgrazing and excess removal of nutrients, and to safeguard the sustainability of the feed resource. Nutrient removal levels can be calculated from average intake data and stocking density. Given a stocking density of 20 TLU/km<sup>2</sup> and an actual feed intake of 1.73 t TLU per year, the removal would be equivalent to 0.35 t of biomass DM/ha (Table 1). If a "proper-use" rate

8. This analysis is based on factorial fertiliser trials carried out in Kenya during four seasons (1987–90) at three sites: two sites in Western Kenya were classed as high-yielding (seasonal rainfall 1180 and 650 mm) and one site in coastal Kenya as low-yielding (rainfall 350 mm); 37–50 kg N/season was applied in the N-deficit site and 17–22 kg P to the P-deficient site; the low-yielding site received N:P 50:22.

9. Fifteen and a half million tonnes of sorghum and millet, 3.6 million t of maize and 3.6 million t of rice (World Bank, 1989: 230–231).

of 30% of the total biomass is deemed permissible, the required herbage yield of 1.2 t DM/ha is surpassed in most savannah rangeland and by on-farm crop residues (Cesar, 1989; Hykoop et al, 1991; de Ridder and Breman, 1993). Removal of N amounts to 25.6 kg/TLU per year, 63% of which occurs during the 6-month growing season (Table 1). At this prescribed stocking density, N removal stands at 5.1 kg/ha, out of which 234 kg is returned to the soil, leaving a net removal of 2.8 kg/ha. This net removal rate by grazing is in the order of 11% of the average above-ground plant uptake and is estimated at about 25 kg N/ha per year.

## Conclusions

At current stocking densities in West Africa livestock produce insufficient manure to replenish the nutrients lost from cropland by crop, erosion and leaching. Hence, in most African farming systems there is a negative nutrient balance and a gradual reduction of soil fertility (Smaling, 1993).

Nutrient transfers from livestock to cropping depend on the level of integration between the two enterprises. When under full farmer control, efficient utilisation of nutrients from several sources has developed in systems with animal-powered cash-cropping and in intensively managed smallholder systems in densely populated areas, where land values are high, and infrastructure and markets are well-developed.

As relatively low population densities (20–50 people/km<sup>2</sup>) prevail in most of West Africa, natural pastures remain the major source of livestock feed and of transferable nutrients. Therefore, benefits flow to those who own or manage the livestock that most depend on this resource, i.e. transhumant and settled pastoralists and the livestock-rich settled farmers. Improvement of transfer mechanisms would spread these benefits wider and would reduce the disparity in soil fertility status at different spatial levels (between farmers, communities, etc).

More efficient utilisation of livestock-derived nutrients can be enhanced by:

- improving integrated resource management with emphasis on communally owned land by regulating and controlling multiple use (grazing, fuelwood extraction etc) and fires
- promoting the integration of efficient manure use in long-term soil nutrient management aimed at rotational systems that combine cash crops, cereal–legume and short-term legume-enriched fallows
- exploring further the synergisms between inorganic fertilisers, and manure combined with crop residue management for livestock feeding and fertility maintenance.

## References

- Afrique Agriculture. 1991. Le coton dans 16 pays d'Afrique noire. *Afrique Agriculture* 184:5–7.
- Agyemang K, Little D A and Singh B B. 1993. *Emerging evidence of highly integrated crop–livestock farming systems in northern Nigeria: A case study from Kano State*. Draft Report. ILCA (International Livestock Centre for Africa), Kaduna, Nigeria. 9 pp.
- Adesina A A. 1992. Oxen cultivation in semi-arid West Africa: Profitability analysis in Mali. *Agricultural Systems* 38:131–147.
- Blench R M, Bourn D and Wint W. 1986. *Integrated air-ground surveys in the Nigerian subhumid zone*. Report by Resource Inventory and Management (RIM). ILCA (International Livestock Centre for Africa), Subhumid Programme, Kaduna, Nigeria. 84 pp.
- Bonnet B. 1988. *Etude de l'élevage dans le développement des zones cotonnières*. PhD Dissertation, University of Montpellier. CIRAD/IEMVT, Paris, France. 120 pp.
- Cesar J. 1989. Typologie, diagnostic et évaluation de la production fourragère des formations pastorales en Afrique tropicale. *Fourrages* 128:423–442.

- Fricke W. 1979. *Cattle husbandry in Nigeria. A study of its ecological conditions and socio-geographical differentiations*. Heft 58. Geographischen Institut der Universitaet Heidelberg, Germany. 250 pp.
- Hellemans P and Compere R. 1990. Aspects techniques et socio-économiques de la transhumance des troupeaux de zébus en zone soudanienne de la Bougouriba (Burkina-Faso). *Tropicultura* 8:59–63.
- Hendy C R C. 1977. *Animal production in Kano State*. Land Resource Report 21. Land Resource Division, Tolworth, UK.
- Hykoop J, van der Poel P and Kaya B. 1991. *Une lutte de longue haleine*. Institut d'économie rurale, Bamako, Mali; Institut royal des tropiques, Amsterdam, Pays-Bas. 154 pp.
- Ikombo B M. 1989. Effect of farmyard manure and fertilizers on maize in semi-arid areas of eastern Kenya. *East African Agricultural and Forestry Journal* 44:266–274.
- Jahnke H E. 1982. *Livestock production systems and livestock development in tropical Africa*. Kieler Wissenschaftsverlag Vauk, Kiel, Germany. 253 pp.
- von Kaufmann R and Blench R. 1986. *The subhumid zone of Nigeria: A systems study*. Draft report. ILCA (International Livestock Centre for Africa), Kaduna, Nigeria. 439 pp.
- Landais E. 1983. *Analyse des systèmes d'élevage bovin sédentaire du nord de la Côte d'Ivoire*. Tome 1, IEMVT, Maisons-Alfort, France. 344 pp.
- de Leeuw P N. 1994. Stylo as forage and fallow: Synthesis and review. In: de Leeuw P N, Mohamed-Saleem M A and Nyamu A M (eds), *Stylosanthes as a forage and fallow crop*. Proceedings of the Regional Workshop on the use of *Stylosanthes* in West Africa, held in Kaduna, Nigeria, 26–31 October 1992. ILCA (International Livestock Centre for Africa), Addis Ababa, Ethiopia. pp. 325–334.
- de Leeuw P N and Rey B. 1993. An analysis of current trends in the distribution patterns of ruminant livestock in sub-Saharan Africa. Paper presented at the Workshop on African Savannah, Land Use and Global Change. Victoria Falls, Zimbabwe, 2–5 June 1993.
- de Leeuw P N and Wilson R T. 1987. Comparative productivity under traditional management in sub-Saharan Africa. *Quarterly Journal of International Agriculture* 26:377–390.
- de Leeuw P N, Dzowela B H and Nyambaka R. 1990. Budgeting and allocation of feed resources. In: *Proceedings of the First Joint Workshop of PANESA/ARNAB, Lilongwe, Malawi, December 1988*. ILCA (International Livestock Centre for Africa), Addis Ababa, Ethiopia. pp. 222–233.
- Leloup S and Traoré M. 1989. *La situation fourragère dans le Sud-Est du Mali-CMDT de Sikasso et de Koutiala (1989)*. Institut d'économie rurale, Sikasso, Mali and Institut royal des tropiques (KIT), Amsterdam, The Netherlands. 91 pp.
- Lhoste P (ed). 1990. *Actes du séminaire sur l'élevage en zone cotonnière, 25–29 octobre 1989, Ouagadougou, Burkina Faso*. Etude et synthèses d'IEMVT 36. IEMVT (Institut d'élevage et de médecine vétérinaire des pays tropicaux), Maisons-Alfort, France. 352 pp.
- McIntire J, Bourzat D and Pingali P. 1992. *Crop–livestock interaction in sub-Saharan Africa*. World Bank, Regional and Sectoral Studies. World Bank, Washington, DC, USA. 246 pp.
- Mortimore M. 1989. *The causes, nature and rate of soil degradation in the northernmost states of Nigeria and an assessment of the role of fertilizer in counteracting the process of degradation*. Environment Department Working Paper 17. World Bank, Washington, DC, USA. 63 pp.
- Mortimore M. 1991. *A review of mixed farming systems in the semi-arid zone of sub-Saharan Africa*. Livestock Economics Division. Working Document 17. ILCA (International Livestock Centre for Africa), Addis Ababa, Ethiopia. 181 pp.
- Norman D W. 1978. Farming systems and problems of improving them. In: Kowal J M and Kassam A H (eds), *Agricultural ecology of savanna. A study of West Africa*. Clarendon Press, Oxford, UK. pp. 318–347.
- Okafor J C and Fernandes E C M. 1987. The compound farms of south-eastern Nigeria: A predominant agroforestry homegarden system with crops and small livestock. *Agroforestry Systems* 5:153–168.
- Otsyina R M, von Kaufmann R, Mohamed-Saleem M A and Suleiman H. 1987. *Manual on fodder bank establishment and management*. Subhumid Zone Programme, ILCA (International Livestock Centre for Africa), Addis Ababa, Ethiopia. 27 pp.

- Peters M. 1992. Evaluierung von tropische Weidelegummosen fuer Fodder Banks im subhumiden Nigerian. Doctoral dissertation, Justus-liebig Universitaet Giessen, Germany. 219 pp.
- Powell J M. 1986. Crop–livestock interactions in the subhumid zone of Nigeria. In: von Kaufmann R, Chater S and Blench R (eds), *Livestock systems research in Nigeria's subhumid zone*. Proceedings of the Second ILCA/NAPRI Symposium held in Kaduna, Nigeria, 29 October–2 November 1984. ILCA (International Livestock Centre for Africa), Addis Ababa, Ethiopia. pp. 268–303.
- van Raay J G T. 1974. *Rural planning in a savanna region*. Universitaire Press, Rotterdam, The Netherlands. 186 pp.
- de Ridder N and Breman H. 1993. A new approach to evaluating rangeland productivity in Sahelian countries. In: Behnke R H, Scoones I and Kerven C (eds), *Range ecology at disequilibrium*. ODI (Overseas Development Institute), London, UK. pp. 104–117.
- RIM (Resource Inventory Management Ltd). 1989. *Livestock and land use in Niger and Anambra States of Nigeria*. RIM, Jersey, UK.
- RIM (Resource Inventory Management Ltd). 1992. *Nigerian livestock resources. Vol. 2. National synthesis*. RIM, Jersey, UK.
- SCA (Standing Committee on Agriculture). 1990. *Ruminants: Feeding standards for Australian livestock*. CSIRO Publications, Melbourne, Australia. 265 pp.
- Schuetterle A and Coulibaly L. 1988. The socio-economic aspects of livestock production in villages in northern Côte d'Ivoire. In: ILCA (International Livestock Centre for Africa) (ed), *Livestock production in tsetse affected areas of Africa*. ILCA, Addis Ababa, Ethiopia. pp. 389–398.
- Smaling E M A. 1993. *An agro-ecological framework for integrated nutrient management with special reference to Kenya*. PhD thesis, Agricultural University, Wageningen, The Netherlands. 250 pp.
- Smaling E M A, Nandwa S M, Prestele H, Roetter R and Muchena F N. 1992. Yield response of maize to fertilizers and manure under different agro-ecological conditions in Kenya. *Agriculture, Ecosystems and Environment* 41:241–252.
- Soh J A. 1990. L'élèveage au nord de la Côte d'Ivoire. 1990. In: Lhoste P (ed), *Actes du séminaire sur l'élèveage en zone cotonnière, Ouagadougou, 25–29 octobre 1989*. Etude et synthèses d'IEMVT 36. IEMVT (Institut d'élèveage et de médecine vétérinaire des pays tropicaux), Maisons-Alfort, France. pp. 201–217.
- Sumberg J E. 1992. Livestock development in The Gambia. *Tropical Animal Health and Production* 24:193–203.
- Sumberg J E and Gilbert E. 1992. Agricultural mechanisation in The Gambia: Drought, donkeys and minimum tillage. *African Livestock Research* 1:1–10.
- Tiffen M and Mortimore M. 1992. Environment, population growth and productivity in Kenya: A case study of Machakos District. *Development Policy Review* 10:359–387.
- Toulmin C. 1983. *Herders and farmers or farmer-herders and herder-farmers*. ODI Pastoral Network Paper 15d. ODI (Overseas Development Institute), London, UK. 22 pp.
- Traoré M. 1990. Situation du développement rural dans la zone Cotonnière du Mali. In: Lhoste P (ed), *Actes du séminaire sur l'élèveage en zone cotonnière, Ouagadougou, 25–29 octobre 1989*. Etude et synthèses d'IEMVT 36. IEMVT (Institut d'élèveage et de médecine vétérinaire des pays tropicaux), Maisons-Alfort, France. pp. 237–272.
- Winrock International. 1992. *Assessment of animal agriculture in sub-Saharan Africa*. Winrock International, Morrilton, Arkansas, USA. 125 pp.
- World Bank. 1989. *Sub-Saharan Africa. From crisis to sustainable growth*. The World Bank, Washington, DC, USA. 300 pp.

# Manure utilisation, drought cycles and herd dynamics in the Sahel: Implications for cropland productivity

T.O. Williams,<sup>1</sup> J.M. Powell<sup>2</sup> and S. Fernández-Rivera<sup>1</sup>

1. International Livestock Centre for Africa (ILCA)/ICRISAT, BP 12404, Niamey, Niger
2. 458 Glenway Street, Madison WI, 53711, USA (formerly with ILCA)

## Abstract

Animal manure is of vital importance to soil-fertility maintenance in semi-arid West Africa due to its intrinsic value as a soil amendment and because of the low level of inorganic fertiliser use. This paper provides a regional overview of manure utilisation for food crop production. Results of experimental trials and on-farm studies are reviewed to evaluate the agronomic and economic effectiveness of livestock manure as a source of nutrients for millet and sorghum production. The potential and actual amounts of manure available for crop production during normal rainfall years are estimated, and the effect of drought-induced changes in livestock population and species composition on manure availability and cropland productivity are assessed. In doing this, on-station and on-farm data from Niger are used to assess nutrient losses from croplands and to estimate the amount of manure required to maintain crop production at various yield levels. The number of animals needed to produce this level of manure and the feed resources required to maintain them are estimated and compared with the level of livestock holdings and feeds found in village studies. The influence of drought on the structure of national and village herds are evaluated and the amounts of different types of manure that are likely to be available in the years immediately preceding and following a drought are estimated. These estimates and feed availability parameters are used to assess the adequacy of available manure for food crop production, and the role that manure and other soil amendments can play in the future intensification of agricultural production in semi-arid West Africa.

## Utilisation du fumier, cycles de la sécheresse et dynamique des troupeaux dans le Sahel: implications pour la productivité des terres agricoles

T.O. Williams,<sup>1</sup> J.M. Powell<sup>2</sup> et S. Fernández-Rivera<sup>1</sup>

1. Centre international pour l'élevage en Afrique (CIPEA)/Centre sahélien de l'ICRISAT B.P. 12404, Niamey (Niger)
2. 458 Glenway Street, Madison WI 53711 (E.-U.) (précédemment en service au CIPEA)

## Résumé

*Le fumier est essentiel pour le maintien de la fertilité des sols dans la zone semi-aride d'Afrique de l'Ouest, en raison de sa valeur intrinsèque pour la fertilisation mais également parce que les engrais inorganiques sont peu utilisés. Cet article présente un aperçu de l'utilisation du fumier dans la production vivrière dans cette région. Les résultats d'essais en station et en milieu réel ont été analysés en vue d'évaluer l'efficacité agronomique et économique du fumier comme source d'éléments nutritifs pour la production du mil et du sorgho. On a déterminé les quantités potentielles et réelles de fumier disponibles pour la production agricole au cours des années de pluviosité moyenne. Ensuite, l'effet de la sécheresse sur les effectifs animaux et la composition spécifique du cheptel ainsi que ses conséquences sur la quantité de fumier disponible et la productivité agricole a été évalué. Pour ce faire, des données d'essais effectués en station et en milieu réel au Niger ont été utilisées pour estimer les pertes en éléments nutritifs des terres arables ainsi que les quantités de fumier nécessaires pour*

*obtenir divers rendements. Le nombre d'animaux nécessaires pour produire ce fumier et les ressources fourragères nécessaires pour les maintenir ont également été déterminés et comparés respectivement aux effectifs réels et aux ressources fourragères effectivement disponibles dans des études effectuées au niveau villageois. L'effet de la sécheresse sur la composition des troupeaux a été déterminé à l'échelle du pays et du village ainsi que les quantités probables des différents types de fumier au cours des années précédant et suivant immédiatement une sécheresse. Ces estimations ainsi que les paramètres relatifs aux fourrages disponibles ont ensuite été utilisés pour évaluer la capacité du fumier disponible à assurer la production vivrière, ainsi que le rôle possible du fumier et d'autres amendements dans l'intensification de la production agricole dans la zone semi-aride de l'Afrique de l'Ouest.*

## **Introduction**

Animal manure is an integral component of soil-fertility management practices in semi-arid West Africa (SAWA). Soils in this region are deficient in nutrients, particularly phosphorus (P) and nitrogen (N). However, low rural incomes, high cost of fertiliser, inappropriate public policies and infrastructural constraints prevent the widespread use of inorganic fertiliser. Under this situation, as population pressure increases and fallow cycles are shortened, animal manure becomes one of the principal sources of nutrients for soil-fertility maintenance and crop production.

Research indicates that manure increases yields of crops and forages. It augments soil organic matter content, raises soil pH, improves nutrient exchange and water holding capacity of soils and, when sufficient quantity is applied on a continuous basis, might permit stable intensified crop production (Mokwunye, 1980; Pichot et al, 1981; Padwick, 1983; Pieri, 1986). Also when manure is used in combination with inorganic fertiliser, especially N, it serves to reduce the negative effects of fertiliser, particularly acidification and increased removal of nutrients other than the one supplied by the fertiliser (de Ridder and van Keulen, 1990).

Despite its vital role in sustaining crop productivity, a key question that has often been posed is whether sufficient amounts of manure are available to permit adequate food production and improvement of soil quality on a long-term basis (Schleich, 1986; Sandford, 1989; de Ridder and van Keulen, 1990; McIntire et al, 1992). While this question can be addressed at a regional, national, village or household level, this paper examines it at the household, village, and national levels.

The objective of this paper is to assess the impact of drought induced changes in livestock population and species composition on manure availability and cropland productivity. To achieve this aim, the amount of manure required to replace nutrients taken up from croplands at various yield levels, and the number of animals required to produce the manure needed are estimated. Using longitudinal data from Niger, the influence of drought on herd structure and species composition are sketched and estimates of the quantities of different types of manure that are likely to be available in pre- and post-drought years are determined. These estimates, given the availability of feeds to support animals, provide an indication of the upper and lower limits of manure availability. This range of manure availability when compared with what is required to maintain cropland productivity gives an idea of the additional measures and inputs that might be needed to improve and augment available manure to sustain crop production. To put the analysis that follows in perspective, the next section reviews available evidence on the usefulness of manure as an input for crop production in SAWA.

## **The effect of manure and inorganic fertilisers on millet and sorghum yields**

Experimental trials on research stations in SAWA have shown that the beneficial effect of manure can be divided into two parts: the effect on soil physical and chemical properties, and the effect on crop growth through the provision of plant nutrients. This review focusses on the influence of manure on crop yields, but a complete assessment of the usefulness of manure needs to consider both effects.<sup>1</sup>

---

1. For a brief review of the effects of manure on soil properties in SAWA, see Haque et al, 1995.

The types and amounts of nutrients that manure can supply depend on animal species, season of the year, types of feeds available, manure storage and method of application. Table 1 shows the variation in the nutrient composition of manure in SAWA. Crop response to manure is also influenced by an array of soil, crop and environmental factors. This implies that results of crop responses to manure at a location cannot be extrapolated to other sites without due recognition of the underlying factors that have combined to produce the observed results.

**Table 1.** *Nutrient composition of manure at selected sites in semi-arid West Africa.*

Location and type of manure	Nurient composition (%)			Source
	N	P	K	
Saria, Burkina Faso				
Farm yard manure	1.5–2.5	0.09–0.11	1.3– 3.7	1
Northern Burkina Faso				
Cattle manure	1.28	0.11	0.46	2
Small ruminant manure	2.20	0.12	0.73	2
Senegal				
Fresh cattle dung	1.44	0.35	0.58	3
Dry cattle manure	0.89	0.13	0.25	3
Niger				
Cattle manure	1.2–1.7	0.15–0.21	–	4
Sheep manure	1.0–2.2	0.13–0.27	–	4

Sources: 1. Pichot et al (1981); 2. Quilfen and Milleville (1983); 3. Landais and Lhoste (1993); 4. Powell (unpublished data).

Table 2 summarises the results of a number of trials conducted at research stations in SAWA. It shows that manure collected from stables and applied alone produces a response of about 20 to 60 kg/ha of cereal grain and 70 to 178 kg/ha of stover per tonne of manure. When animals are corralled on cropland, a common practice in the region, both manure and urine are returned to the soil. The additional crop response due to urine application can be substantial (Table 2). Application of 3 t of manure plus urine produced grain and stover yields that were three to four times as high as when only manure was applied. Although the N in urine is subject to large gaseous losses, soil N, pH and P levels increase dramatically in areas where urine has been deposited (Powell et al, 1992).

Given that single rates of manure were used in most of the reported trials, it is impossible to estimate the optimum level of manure needed to support millet and sorghum production. Also, nearly all responses were measured in the year of manure application and the information that was available in some of the long-term experiments was insufficient to permit a precise estimation of the residual effect of manure on grain and stover yields. Nonetheless, the Niger studies appear to indicate that application of 3 to 5 t of manure per ha may be needed to ensure good crop response. Such annual manure application has long been found to be adequate for sustainable sorghum and millet production in the subhumid zone of northern Nigeria (Dennison, 1961; Watson and Goldsworthy, 1964).

In combination with inorganic fertilisers, the range of crop response is between 32 to 90 kg/ha of grain and 84 to 192 kg/ha of stover per tonne of manure. The yield response to manure and fertiliser combinations appears to correspond with findings from northern Nigeria which show that over an 11-year period no additional grain or stover response to fertiliser was obtained when manure applications on sorghum or millet were greater than 7.5 t/ha (Abdullahi and Lombin, 1978).

**Table 2.** Results of manuring experiments at three sites in semi-arid West Africa.

Panel A: Manure only					
Location	Amount of manure applied (t/ha)	Crop	Crop response <sup>1</sup> (kg of DM/t manure)		Source
			Grain	Stover	
M'Pesoba, Mali	10	Sorghum	35 <sup>2</sup>	n.s.	1
Saria, Burkina Faso	10	Sorghum	58	n.s.	2
Sadoré, Niger 1987	5	Pearl millet	38	178	3
	20	Pearl millet	34	106	3
Sadoré, Niger 1990	3	Pearl millet	62	148	4
	10	Pearl millet	22	71	4
	3 <sup>3</sup>	Pearl millet	169	663	4
	10 <sup>3</sup>	Pearl millet	32	295	4
Panel B: Manure with inorganic fertiliser					
Location	Amount of		Crop	Crop response <sup>1</sup> (kg of DM/t manure)	
	Manure (t/ha)	Fertiliser (kg/ha)		Grain	Stover
M'Pesoba, Mali	5	NPK: 8–24–0	Sorghum	90 <sup>4</sup>	n.s.
Saria, Burkina Faso	10	Urea N: 60	Sorghum	80	n.s.
Sadore, Niger					
1987	5	SSP P: 8.7	P. millet	82	192
1987	20	SSP P:17.5	P. millet	32	84

1. Responses were calculated at the reported treatment means for crop yields as: (treatment yield – control yield)/quantity of manure applied.

2. Response of sorghum planted in the second year of a 4-year rotation involving cotton–sorghum–groundnut–sorghum. Manure was applied in the first year.

3. Manure plus urine.

4. Estimated from visual intrapolation of graph.

n.s. implies not specified.

Sources: 1. Pieri (1981); 2. Pieri (1986); 3. Baidu-Forson and Bationo (1992); 4. Powell (unpublished data).

Manure application rates and crop response to manuring appear to be lower in farmers' fields (Table 3) than on experimental stations. Except for the high grain response obtained in Burkina Faso (due to successive manure application in four out of the preceding six years), grain response in farmers fields ranged from 19 to 38 kg/ha, and stover response from 140 to 219 kg/ha per tonne of manure. The low manure application rates and crop response to manuring in farmers fields probably indicate that farmers are unable to apply enough manure to ensure optimum yield increases. However, the low application rates in the drier area of Niger appears to be a rational strategy of farmers. A survey of farms in this area showed that in a poor rainfall year yields in manured fields were significantly lower than in adjacent non-manured plots (ILCA, 1991). This shows that the risk of excessive manure application increases with decreasing rainfall.



**Table 3.** *Effects of manure application on millet yields in farmers' fields in selected parts of semi-arid West Africa.*

Location	Average long-term rainfall (mm/annum)	Manure DM applied (kg/ha)	Crop	Crop response <sup>1</sup> (kg of DM/t manure)		Source
				Grain	Stover	
Ouallam arrond., Niger	350	1300	Pearl millet	19	219	1
Kolo arrond., Niger	425	1700	Pearl millet	38	152	1
Say arrond., Niger	650	3800	Pearl millet	31	140	1
Djibo, Burkina Faso	600	250–285	Pearl millet <sup>2</sup>	21–92	n.s.	2

1. Responses were calculated at the reported treatment means for crop yields as: (treatment yield – control yield)/ quantity of manure applied.

2. Millet intercropped with cowpea and sauce plants.

n.s. means not specified.

Note: Animals were corralled in the fields in Niger, whereas manure was collected from compounds and transported to the fields in Burkina Faso.

Sources: 1. Powell (unpublished data); 2. Prudencio (1987).

The fact that manured fields yield more than unmanured plots does not imply that manure use is profitable. Partial budget analysis conducted under various assumptions indicate that application of 5 t/ha of manure with an average response of 50 kg of grain and 150 kg of stover per tonne of manure, will give value cost ratios (VCR) ranging from 0.7 to 1.5. The lower VCR is obtained when the farmer pays for both the manure and the labour involved in transporting and spreading of manure, and in harvesting the extra yield produced. A VCR less than 1 indicates a negative net return to the farmer. The VCR of 1.5 is obtained under the assumption that manure is deposited directly on the cropland by animals so that labour is not required for transporting and spreading it. A VCR of 1.5 represents a return above the cost of manure of 50%. This indicates that manure use may be profitable, particularly when the labour involved in its application is minimised. The level of return, however, appears to be low given the climatic and price risks faced by farmers in this region.

At this juncture, it is useful to briefly consider the response of millet and sorghum to inorganic fertilisers. This is necessary because while there are still impediments to the use of inorganic fertilisers, they represent a potentially viable alternative to organic soil amendments such as manure.

In an extensive review of fertiliser trials in sub-Saharan Africa, McIntire et al (1992) reported that application of 20 kg of N/ha on millet and sorghum gave a response range of 5 to 10 kg of grain/kg of nutrient, while application of 20 kg of P/ha gave a response range of 4 to 8 of grain/kg of nutrient. Reports on N efficiency research conducted within the West African Fertiliser Management and Evaluation Network (WAFMEN) indicated that application of 50 kg N/ha to sorghum and 30 kg N/ha to millet gave a response of 20 kg and 9 kg of grain/kg of N for sorghum and millet, respectively. Bationo et al (1986) reported the results of farmer managed trials conducted in Niger in 1984. In this dry year, application of 11 kg of P/ha to millet gave a response of about 10 kg of grain/kg of nutrient.

Given these reported responses, it is clear that the yield benefit accruable through the use of fertiliser is much greater than what could be expected from the use of manure.<sup>2</sup> For example, a tonne of single superphosphate (75 kg P) at a modest response of 6 kg of millet grain/kg P, would give 450 kg of millet grain per tonne of additional fertiliser. A tonne of manure would give about 50 kg of additional grain in the year of application. Even if the residual effect of manure is taken into

2. Given that the 'specific effect' of manure is weak (McIntire et al, 1992), it is permissible to compare manure and inorganic fertilisers in terms of cost per unit of nutrient.

consideration and it is assumed that an additional 25 kg of grain can be subsequently produced, the figures here indicate that the labour costs per unit of grain output would be much higher for manure (see also McIntire et al, 1992).

Nonetheless, two points are clear. First, although the profitability of even relatively small doses of fertiliser is well established (Couston, 1971; Baanante, 1986), the use of fertiliser is still very low in SAWA. Secondly, the analysis conducted above ignores the beneficial effect of manure on soil physical and chemical properties. Pichot et al (1981), reporting on 20 years of experimental trials in Saria, Burkina Faso, found that continuous cultivation without soil amendment diminishes soil productivity. However, a light fertiliser application with manure was found to be superior to a heavy fertiliser application without manure. Thus, for these and other reasons, manure will remain an essential input for crop production in SAWA. To fully assess the future role that manure and inorganic fertilisers can be expected to play as agricultural production is intensified, it is necessary to determine the agronomic demands for manure, its availability, and how this availability can be influenced by natural factors.

## Manure requirements for stable crop production

Table 4 presents data on nutrient removal by millet at three locations in Niger. The sites, Ouallam, Kolo and Say, represent dry (300–400 mm annual rainfall), moderately dry (400–500 mm) and relatively wet (500–600 mm) regions of western Niger.

**Table 4.** Millet dry-matter (DM) yields and nitrogen (N) and phosphorus (P) uptake in farmers' fields in Niger.<sup>1</sup>

	Location								
	Ouallam			Kollo			Say		
	DM	N	P	DM	N	P	DM	N	P
	-----kg/ha-----								
Grain	370	8.6	1.3	580	15.3	2.3	840	22.3	3.4
Leaf	710	7.6	0.9	750	8.1	0.8	940	8.1	1.1
Stem	770	4.6	0.7	880	6.3	0.9	1400	7.2	1.3

1. DM yields averaged over two years (1990–91) in non-manured fields; N and P contents of grain, leaf and stem in 1991 only.

In estimating the amount of manure required to sustain the observed crop yields, a key technical consideration is the rate of nutrient release from manure. Soil moisture and temperature highly influence the nutrient release from manures (see Murwira et al, this volume). Whereas nutrients in fertiliser are in readily soluble form, and therefore become rapidly available to crops, nutrients in manure must mineralise and, therefore, become more slowly available. All the nutrients may not mineralise from manure during the first year after application. Results from a long-term on-station trial in Niger show that cattle manure and urine can have positive effects on millet yields even up to three years after application (ILCA, 1993).

“Decay series” (Pratt et al, 1976) are used to estimate manure application rates needed to achieve a given level of nutrient availability to crops. This approach takes into consideration the amount of nutrients released during the first and subsequent years after application. Farmers in Niger apply manure every 2 to 3 years, depending on soil type, rainfall, and manure availability. Our assumptions concerning the nutrient release from manure, upon which we calculate manure requirements for yield maintenance, are simple, and we recognise the many factors (rainfall, temperature, soil type, manure

nutrient content, farmer management etc) that can affect these estimates. We first assume a manure decay series of 50:40:10, or that 50% of the nutrients in manure will be released in year 1, 40% in year 2, and 10% in year 3; that fields are manured every 2 years; that manuring has been practised for some years so that 60% of the nutrients in manure would be available during the year of application (50% year 1 plus 10% year 3 residual) and 40% year 2.

Not all the nutrients released from manure will, however, be available for uptake by millet. For example, in the predominantly sandy soils of the Sahel, only 20 to 37% of fertiliser N may be taken up by millet (Christianson et al, 1990). Nutrients are lost from cropland via erosion, leaching, and as gases (N). Nutrients may also recombine with soil components into forms that are unavailable to plants. Since the decomposition of, and nutrient release from manure depends on the same factors (moisture and temperature) that affect plant growth, nutrients from manure may be released in a pattern that more closely coincides with plant demands. In calculating manure requirements to offset nutrient removals shown in Table 4, we assume that 60% of the N and P released from manure in any given year will actually be taken up by millet.

The potential uptake of manure-N and manure-P by millet would be lower in the second than the first year after application (Table 5). As biennial manure applications continue for some years, however, soil nutrient levels will build-up gradually and nutrient uptake (and yields) will stabilise.

**Table 5.** *Estimates of nutrient uptake by millet in fields receiving one tonne of cattle or sheep manure every two years.*

		N	P
		-----kg/ha-----	
Year 1	Cattle	4.68	0.65
	Sheep	5.76	0.72
Year 2	Cattle	3.12	0.43
	Sheep	3.84	0.48

Assumes manure "decay series" of 50:40:10; N and P content of cattle and sheep manure of 13.0, 1.8 and 16.0, 2.0 kg/t, respectively; 60% N and P uptake efficiency by millet.

Biennial manure applications to replenish the P (and N) taken up from farmers fields at various levels of stover removal are given in Table 6. The actual amount of manure needed is equal to the quantity required to replace the most constraining nutrient, i.e. P. This amount of manure will also supply a sufficient amount of N to replace that taken up by the millet plant. Thus, the manure requirements would range from about 2.1–3.2 t/ha in the dry to 5.1–6.9 t/ha in the wet zone depending on whether cattle or sheep manure is used. More cattle than sheep manure would be required and manure requirements increase as more stover is removed for feed. Increasing stover removal from only 25% of the leaves to 75% of the leaves plus 20% of the stalks increases biennial manure requirements by approximately 1 t/ha. These calculations do not, however, consider the small amount of manure that is returned to fields during crop residue grazing nor does it consider the N return in urine when animals are corralled on cropland. The positive effects of urine on yields (Table 2) are probably due to N return. Since approximately 50% of the N excreted by animals is in urine (NAS, 1983) manure requirements for N replenishment would most likely be less if animals were corralled versus if manure were collected from stalls and hand-spread on cropland. However, urine contains little P so manuring requirements for P replenishment would be the same for corraling and manure hand-spreading.

**Table 6.** Biennial manure requirements to maintain soil fertility in farmers' fields in Niger.<sup>1</sup>

Leaf/stem N and P removals (% of original)	Nutrient to replenish	Location					
		Ouallam		Kolo		Say	
		Cattle	Sheep	Cattle	Sheep	Cattle	Sheep
-----Manure requirement, t/ha <sup>2</sup> -----							
25/0	N	2.2	1.8	3.7	3.0	5.2	4.2
	P	2.3	2.1	3.8	3.5	5.6	5.1
50/10	N	2.8	2.2	4.3	3.5	5.8	4.7
	P	2.8	2.5	4.3	3.9	6.3	5.7
75/20	N	3.2	2.6	4.8	3.9	6.4	5.2
	P	3.2	2.9	4.7	4.3	6.9	6.2

1. Nutrients available from urine are not taken into account in estimating these requirements (see text for further explanation).
2. Nutrient removals were calculated from Table 4 using total grain and leaf/stem N and P removals of 25/0, 50/10 and 75/20% of uptake. Manure requirement = (Nutrient removal) divided by (nutrient uptake). Nutrient uptake taken from Table 5: Year 1.

## Livestock and manure production

The amounts of manure that can be produced by different ruminant livestock species in SAWA have been estimated by Fernández et al (this volume). Assuming average growth rates and an 8-month manure-collection period extending from October to May, 301, 60 and 45 kg DM of manure per animal can be obtained from cattle, sheep and goats, respectively.

Given these estimates, Table 7 indicates how many cattle or sheep are required to provide the manure needed to sustain the grain yields and stover removals specified (in Table 6) on a continuous basis. It shows, for example, that to maintain a sustained yield of 370 kg of millet grain and removal of 50 and 10% of the leaves and stalks on 1 ha of cropped land in Ouallam area, a farmer needs nine cattle or 42 sheep. Given the same level of stover removal, a farmer in Say area needs 21 cattle or 95 sheep to maintain a grain yield of 840 kg/ha. In general, across zones it appears that about 4–5 head of sheep can be used to replace each head of cattle for manuring purposes.

**Table 7.** Number of animals required to supply manure needed to restore soil fertility at different levels of nutrient removal.

Leaf/stem removals	Ouallam		Kollo		Say	
	Cattle	Sheep	Cattle	Sheep	Cattle	Sheep
25/0	8	35	13	58	19	85
50/10	9	42	14	65	21	95
75/20	11	48	16	72	23	103

The issue of feed required to maintain livestock producing different amounts of manure in SAWA is addressed by Fernández et al (this volume). Depending on rangeland productivity and taking into consideration the amounts of crop residues available from manured and nonmanured fields, the nine cattle or (42 sheep) required for manuring in Ouallam will need between 11–42 or (10–40) ha of dry season grazing land, and 4–11 or (3–10) ha of rangeland for wet-season grazing. The grazing land requirement for the 21 cattle or (95 sheep) needed in Say is from 34–138 or (32–129) ha for the dry season and 9–27 or (6–24) ha for the wet season. In all cases, sheep requirements for grazing area are slightly lower than those for cattle on account of the higher nutrient content of sheep's manure. For both species, less grazing area is required when range productivity is high.

Leaving the question of feed availability aside, it is useful to consider whether farmers have sufficient animals to provide the required manure. Given the climatic conditions in SAWA, the question of adequacy of livestock holdings cannot be discussed without considering the impact of rainfall on livestock population and growth.

## **Drought and livestock population dynamics in semi-arid West Africa**

Over the last 25 years, one of the persistent factors that has affected livestock population and its geographic distribution in SAWA is recurrent drought. Since 1968, annual rainfall has been declining in this region and severe drought occurred between 1968–73 and 1983–85 (Figure 1).

The effect of drought on livestock depends on a variety of factors including the duration and pervasiveness of the shortfall in rainfall, rangeland productivity and grazing pressure on pastures before the drought, the species of livestock, herd management techniques etc (Sandford, 1977; Penning de Vries, 1983; Toulmin, 1983; 1985). Given the extensive system of livestock management in SAWA, localised rainfall shortages can easily be accommodated by moving animals to areas with better rainfall. However, this opportunity becomes limited when drought is widespread. Moreover, if animal stocking levels have been consistently high relative to the longterm capacity of the range, a shortfall in rainfall can lead to huge livestock losses due to limited availability of forage, and the weakened state of livestock arising from low body reserves.

Apart from its effect on livestock numbers, drought also influences the species composition of herds due to the varying degree of susceptibility of different animal species. Available evidence indicates that in periods of drought, small ruminants, particularly goats, have a higher survival rate than cattle (Arnal and Garcia, 1974; Dahl and Hjort, 1976). Also, the rapid reproduction and growth rates of small ruminants allow them to reconstitute their numbers much faster than cattle, and this partly explains the changes in the composition of livestock populations in favour of small ruminants in the postdrought period when reconstitution gets underway.

In Niger, as elsewhere in the West African Sahel, the prolonged drought of 1968–73 and the limited, but severe, drought of 1984–85 led to drastic fall in livestock numbers (Figure 2). Data in Table 8 shows that between 1968 and 1973, Niger's cattle herd declined by about 50% from 4.45 to 2.2 million. The losses in sheep and goat flocks over the same period were lower at about 36 and 18%, respectively. These losses occurred as a result of deaths and distress sale of animals. However, by 1983 the national livestock herd had been reconstituted to pre-drought levels, although cattle numbers remained somewhat lower and small ruminant numbers were higher. Following the 1984–85 drought, livestock numbers fell again with cattle, sheep and goat populations declining by 59, 26 and 45%, respectively, between 1983 and 1986.

This pattern of loss was also evident in other Sahelian states even though the severity varied considerably between countries. For example, between 1972–74 the cattle herd in the Sahelian zone of Mali declined from 4.75 to 2.64 million. Thereafter, it increased to 4.02 million in 1982 but this was followed by a sharp drop between 1983–85 when a new low of 2.69 million cattle was recorded (IEMVT, 1989; de Leeuw et al, 1990).

**Figure 1.** Mean annual rainfall, five-year moving average and long-term average rainfall at Hombori (Mali), Say (Niger) and Saria (Burkina Faso).

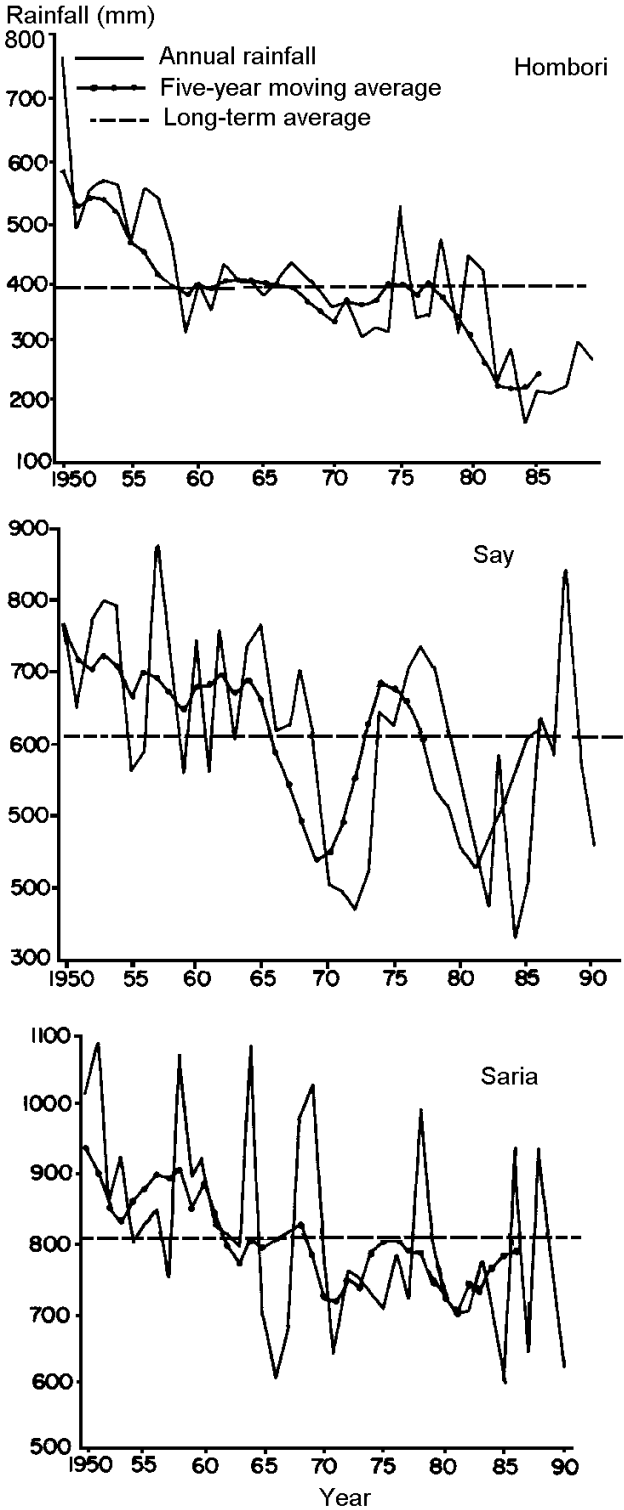

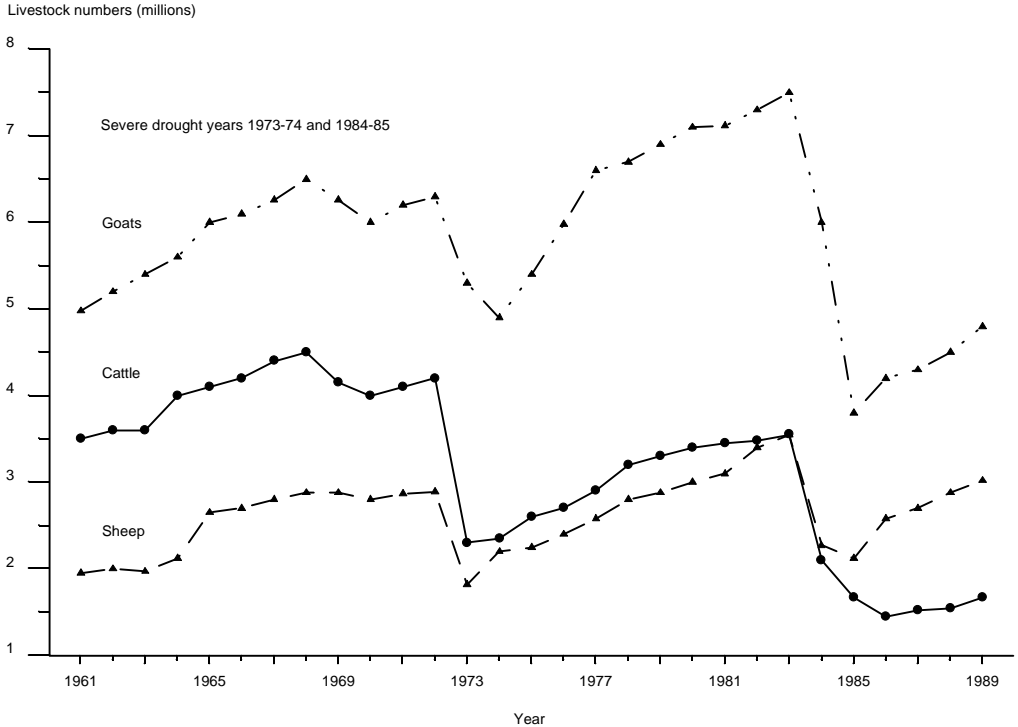
**Figure 2.** Livestock population in Niger, 1961–89.

Going by the scale of livestock losses experienced in Niger during the 1984–85 drought, the time it took to reconstitute the herds after the earlier drought of 1968–73 and even by estimates derivable from herd growth models, it is clear that it is still too early for the Niger herds to be reconstituted to their former numbers.<sup>3</sup> Table 8 shows that herd reconstitution is underway, albeit relatively slowly for cattle.<sup>4</sup> In the meantime, if the 1991 figures are compared with the 1961–63 data, it is seen that the ratio of small ruminants to cattle has more than doubled. This shift in the species composition of herds is supported by data from farm surveys conducted by ILCA scientists in Niger at various periods between 1983 and 1991. The surveys were initiated before the 1984 drought in two villages in Ouallam arrondissement about 90 km north of Niamey, the capital of Niger. Mean livestock holdings of sampled households appear to confirm the growing importance of small ruminants relative to cattle (Table 9).<sup>5</sup>

While this situation may become reversed in the future as cattle population increases, experience in SAWA has shown that the post-drought period represents a time when livestock numbers are drastically reduced and the species composition of herds are altered. These changes have obvious implications for manure availability and these will be explored below.

3. A number of herd models exist which simulates drought-induced losses and subsequently estimates the number of years required for herd reconstitution (Tacher, 1975; Dahl and Hjort, 1976; Clark, 1984). Tacher's model of Sahelian cattle herds, for example, predicts that after losses of 40% cattle populations will be back to their former level in about 12 years.
4. The accuracy of the 1991 figures of livestock population is questionable because since 1987, a livestock census has not been conducted in Niger. Livestock population figures since 1987 have been estimated based on the growth rates derived from animal head counts during vaccination campaigns. It is most likely that livestock numbers, particularly small ruminants, have been under-estimated since it is not obligatory to vaccinate sheep and goats.
5. An on-going survey that was started in 1993 in these two villages is investigating the reason for the persistence of drought-induced shift in species composition.

**Table 8.** Long-term trends in livestock population in Niger.

Species ('000 head)	Year						Growth rate			
							% change		(% per annum)	
	1961–63	1968	1973	1983	1986	1991	68–73	83–86	61–63/68	73/83
Cattle	3560	4450	2200	3524	1429	1790	(–51)	(–59)	3.8	4.4
Sheep	1965	2800	1800	3448	2549	3252	(–36)	(–26)	6.1	6.1
Goats	5180	6430	5300	7478	4114	5214	(–18)	(–45)	3.7	3.2
Small ruminant/ cattle ratio	2:1	2:1	3:1	3:1	3.5:1	4.7:1				

Source: Republique du Niger (1991; 1993).

**Table 9.** Mean livestock holdings in two Ouallam villages in Niger, 1983 and 1991.

Animal type	Sadeize-Koara (n = 15)				Samari (n = 25)			
	1983		1991		1983		1991	
	Mean	Range	Mean	Range	Mean	Range	Mean	Range
Cattle	5.5	0–27	1.8	0–10	2.3	0–14	1.0	0–5
Sheep	6.6	0–29	9.6	0–32	1.4	0–8	6.4	0–17
Goats	12.5	0–40	22.3	1–81	10.6	0–30	16.3	2–60

Sources: Dicko (unpublished data); Williams (unpublished data).

## Household herd sizes in relation to animal requirements for manuring

The mean livestock holdings for 1983 (Table 9) are fairly representative of many smallholder farmer's pre-drought herd sizes (see also Wilson, 1986; Swinton, 1988). If the mean livestock holdings of about 4 head of cattle and 15 head of small ruminants found in the two Ouallam villages in 1983 are compared with the number of animals required to produce the manure needed to sustain yields (Table 7), it is seen that the mean herd size will be able to manure only 0.9 ha annually when 25% of the millet leaves are removed.<sup>6</sup> When 75% of the leaves and 20% of the stalks are removed, only 0.6 ha can be manured annually. However, because it is assumed that effect of manure lasts for two years, the same herd size will allow the farmer to spread "manure effect" over twice the area indicated at each level of stover removal.

Given the mean herd size of one head of cattle and 27 head of small ruminants found in the two villages in 1991 it is clear that, in comparison with the pre-drought situation, farmers in Ouallam will need to rely more on small ruminants to manure their fields. However, despite the increase in small ruminant numbers, the area that can be manured is lower. For example when only 25% of the millet

6. To calculate the total amount of manure that can be obtained from a given herd size, goat manure is assumed to be of the same quality as sheep manure. However, small ruminant manure is known to be of a slightly higher quality than cattle manure (Table 5), and this fact is taken into account when small ruminant manure is added to cattle manure to obtain total manure estimate.



leaves are removed the number of animals available to the farmer will be able to manure only 0.8 ha annually. If 75% of the leaves and 20% of the stalks are removed, only about 0.5 ha can be manured annually. Again, in terms of “manure effect”, twice the area indicated here would be under manure in each year.

The situation in Say area is not any different. A survey conducted in Gueladio in 1991 (ILCA, 1993) found an average of 7 cattle, 7 sheep, and 17 goats per household. Compared to what is needed to sustain millet yields, this herd size will only be able to manure 0.6 ha annually when 25% of the leaves are removed and about 0.5 ha annually when 75% of the leaves and 20% of the stalks are removed. When compared to Ouallam, it appears that farmers in Say are unable to manure more cultivated area with their higher herd size probably because Say is a more humid area. The relative wetness in Say causes more rapid manure decomposition, higher crop yields and nutrient removals, and therefore greater manure requirements.

At this point, it is informative to compare the results obtained above with farmers’ manuring practices. In Ouallam and Say districts, farmers cultivate on the average about 10 and 3 ha per household, respectively. Given the calculations above, it is clear that farmers will not be able to manure a substantial proportion of their fields if they rely only on their own animals. Indeed, given the 1991 herd sizes in the surveyed villages, farmers will only be able to manure in a year between 10 to 16% and 30 to 40% of the total cultivated household fields in Ouallam and Say, respectively. The insufficiency of household animals for manuring is one reason why only a small proportion of cultivated fields are manured. Matlon and Fafchamps (1988) found that in three agroclimatic zones of Burkina Faso, less than half of the sorghum and millet area receives manure in any given year. They also found that sorghum and especially millet tend to be grown on land manured the previous year. Powell and Williams (1993) found in the same three districts of Niger covered in this paper that only 30–50% of the millet fields are manured annually (see also Gavian, 1992). When the area that available herd size per household in Ouallam can manure annually if yield level is to be sustained (1.0–1.6 ha) is compared with the 3 ha that farmers now manure in practice, a number of issues come to the fore.

First, it appears that farmers in Ouallam rely on herds other than their own to maintain their current practice. With the 1991 herd size, the farmer will obtain about 1.8 t of manure, but farmers in this area apply about 1.3 t/ha (Powell and Williams, 1993) meaning that they apply a total of 3.9 ha annually over the 3 ha that they manure. Second, even with additional manure coming in from outside, farmers’ current strategy will not necessarily allow yields to be maintained on a continuous basis. Manure application rate of 1.3 t/ha is between 40–60% of what is needed if the objective is to sustain yields. In the case of Say, although there is a closer correspondence between area that available herds can manure and current manuring practice, the manure application rates are lower than what will be needed to sustain yields continuously. As pointed out earlier, low manure application rates may be a rational strategy to minimise the risk of crop burning in the event of drought.

The objective or strategy notwithstanding, what is clear from the above analysis is that farmers’ herd sizes in the two villages will be insufficient to manure all the cultivated fields on an annual basis. The smallness of household herds compared to farmers’ manuring needs is another reason why farmers pool herds and also enter into crop residue/manure exchange contracts with transhumant herders. Thus in addition to household herds, farmers can also rely on herds coming in from outside the village. However, the regularity and size of the incoming transhumant herds is difficult to estimate as it depends on climatic, social and institutional factors.

## **National herd sizes in relation to animal requirements for manuring**

The question of manure availability and its adequacy can also be considered at the national level. Just as at the household/village level, herds can also enter a given country from neighbouring states and the same problem of estimating the contribution of such animals to the overall supply of manure still remains.

Nonetheless, Table 8 shows that in 1983 before the last major drought there were about 3.5, 3.5 and 7.5 million head of cattle, sheep and goats, respectively, in Niger. This herd size, assuming all animals can be used for manuring, will produce about 1.7 million tonnes of manure. In that same year, about 3.1 million hectares of millet were cultivated in Niger with an average yield of 414 kg/ha (Republique du Niger, 1991). This yield level is about 12% higher than the yields observed in farmers' fields in Ouallam (Table 4). If we assume that only 30% of the cultivated area is manured; that we need to sustain millet yields at the level found in Ouallam; and that 25% of the millet leaves will be removed, then about 2.1 million tonnes of manure will be needed. Compared to what is available, there will be a shortfall of 0.4 million tonnes of manure. If 75% of the leaves and 20% of the stalks are removed the shortfall will be about 1.3 million tonnes of manure.

If the post-drought situation in 1991 is considered, 4.4 million hectares of millet were cultivated and the average yield was about 418 kg/ha (Republique du Niger, 1991). Table 8 shows that there were about 1.8, 3.3 and 5.2 million head of cattle, sheep and goats, respectively, in Niger in the same year. If we make the same assumptions that were made above for 1983, the shortfall in manure supply will be 2 million tonnes of manure when only 25% of the leaves are removed, and 3.2 million tonnes of manure when 75% of the leaves and 20% of the stalks are removed.

While the estimates sketched above need to be considered in relation to the reliability of the statistics and assumptions used to derive them, they nonetheless give an indication of the bounds of manure availability and the proportion of cultivated fields that can be manured in pre- and post-drought periods.

## Implications for cropland productivity

The case of Niger shows that aggregate livestock population is a key factor that may effectively limit the amount of manure available for crop production. The insufficiency of animals to provide adequate manure implies that with the present increasing intensity of land use in Niger and other parts of SAWA, external inputs in the form of inorganic fertilisers are needed, in addition to manure, to prevent decline in soil fertility and crop yields.

This observation is consistent with the conclusions of other studies (Breman, 1990; de Ridder and van Keulen, 1990; McIntire and Powell, this volume). This conclusion remains valid even if other considerations (e.g. role of fallow, competition between food and feed for land and the possibility of increased manure collection) which have not been fully addressed in this paper are taken into account. For example, in many parts of SAWA, fallowing is no longer a viable option for maintaining soil fertility as a result of high population growth and declining rainfall which have encouraged extensification and continuous cropping of arable lands. Increasing animal numbers in order to obtain more manure is also not a sustainable option given the competition for land between food and feed that is bound to develop if this option is adopted (McIntire et al, 1992). The extensive system of livestock management practised in SAWA reduces the possibility of increased manure collection. The survival of animals under this system of management depends on extensive grazing; thus a certain amount of manure is bound to be lost when animals are out grazing. The high labour costs of collecting the manure deposited in rangeland in relation to expected returns will not make this a particularly attractive option to cereal farmers.

Given that inorganic fertilisers are needed to augment manure that is available for crop production, it is useful to have some indication of what quantities will be needed. If single nutrient fertilisers were to be used to meet the shortfall of 3.2 million tonnes of manure estimated for 1991, about 81 400 t of urea and 172 800 t of single superphosphate (SSP) will be needed.<sup>7</sup> Between 1984/85, 1500 t of N and 786 t of P<sub>2</sub>O<sub>5</sub> fertilisers were imported into Niger (FAO, 1992). Since then the level of imports has fallen to less than a third of these figures due to removal of government subsidy and the subsequent

7. It is assumed that urea contains 46% N by weight and that millet N efficiency uptake from urea is 40%. SSP contains 7.5% of P by weight and millet P efficiency uptake is 16% (Bationo et al, 1993).

increase in the domestic prices of fertilisers. The huge gap between what is currently imported and what is needed to meet manure shortfalls on only 30% of the cultivated areas suggests an important role for government policy to facilitate and encourage the use of fertiliser in semi-arid West Africa.

## Conclusions

This paper highlights the importance of aggregate livestock population and species composition as key determinants of manure availability. Given the level of nutrient losses from croplands in Niger, it was shown that insufficient animals were available to provide the manure needed to maintain crop yields. The shortfall in manure availability was particularly evident in post-drought years. The limitations posed by animal numbers and feed availability imply that with the present increasing intensity of land use in Niger and other countries in SAWA, manuring alone is not going to provide the key to attainment of sustainable yield levels. External inputs in the form of inorganic fertilisers are needed to augment available manure to sustain crop production. However, the gap between present fertiliser use and what is required to supplement available manure is wide. To ensure the availability and increased use of fertilisers at the farm level, appropriate public policies are needed to ease the constraints that have inhibited the widespread use of fertilisers in SAWA.

## References

- Abdullahi A and Lombin G. 1978. *Long-term fertility studies at SamaruNigeria: Comparative effectiveness of separate and combined applications of mineral fertilisers and farmyard manure in maintaining soil productivity under continuous cultivation in the savanna*. Samaru Miscellaneous Publication 75. Ahmadu Bello University, Zaria, Nigeria. 54 pp.
- Arnal J P and Garcia M. 1974. Evaluation des pertes de bétail dues à la sécheresse (Niger, Haute Volta) In: Bulletin trimestriel, information technique économique de la Communauté économique de l'Afrique de l'Ouest, No. 8–9, Ouagadougou.
- Baanante C. 1986. Economic evaluation of alternative fertiliser technologies for tropical African agriculture. In: Mokwunye A U and Vlek P L G (eds), *Management of nitrogen and phosphorus fertilisers in sub-Saharan Africa*. Development in Plant and Soil Sciences 24. Martinus Nijhoff Publishers, Dordrecht, The Netherlands.
- Baidu-Forson J and Bationo A. 1992. An economic evaluation of a long-term experiment on phosphorus and manure amendments to sandy Sahelian soils: Using a stochastic dominance model. *Fertilizer Research* 33:193–202.
- Bationo A, Sedogo M P, Buerkert A and Ayuk E. 1993. Recent achievements on agronomic evaluation of phosphorus fertilizer sources and management in the West African semi-arid tropics. Paper prepared for the workshop on sustainable land management for the semi-arid and subhumid regions. The Scientific Committee on Problems of the Environment (SCOPE), Dakar, Senegal, 15–20 November 1993.
- Breman H. 1990. No sustainability without external inputs. In: *Beyond adjustment. Sub-Saharan Africa*. Africa Seminar, Maastricht. Ministry of Foreign Affairs, The Hague, The Netherlands.
- Christianson C B, Bationo A, Henao J and Vlek P L G. 1990. Fate and efficiency of N fertilizers applied to pearl millet in Niger. *Plant and Soil* 125:221–231.
- Clark N T. 1984. Some probable effects of drought on flock structure and production parameters in north-western Afghanistan. *Nomadic Peoples* 15:67–74.
- Couston J W. 1971. Summary of economic returns to fertilizer in African countries. In: FAO (Food and Agriculture Organization of the United Nations), *Improving soil fertility in Africa*. FAO Soils Bulletin 14. FAO, Rome, Italy.
- Dahl G and Hjort A. 1976. *Having herds. Pastoral herd growth and household economy*. Stockholm University, Stockholm, Sweden.
- Dennison E B. 1961. The value of farmyard manure in maintaining fertility in northern Nigeria. *Empire Journal of Experimental Agriculture* 29:330–336.

- Gavian S. 1992. *Manure and crop residue management strategies used by farmers in selected regions of the Tillabéri Department, Niger*. Consultancy Report submitted to ILCA Niger.
- Haque I, Powell J M and Ehui S. 1995. Improved crop–livestock strategies for sustainable soil management in tropical Africa. *Advances in Soil Science* (in press).
- IEMVT (Institut d'élevage et de médecine vétérinaire des pays tropicaux). 1989. *Elevage et potentialités pastorales sahéliennes: synthèses cartographiques*. IEMVT/CTA, Maisons-Alfort, France.
- ILCA (International Livestock Centre for Africa). 1991. *ILCA Annual Programme Report 1990*. ILCA, Addis Ababa, Ethiopia.
- ILCA (International Livestock Centre for Africa). 1993. *ILCA Annual Programme Report 1992*. ILCA, Addis Ababa, Ethiopia. 228 pp.
- Landais E and Lhoste P. 1993. Systèmes d'élevage et transferts de fertilité dans la zone des savanes africaines. *Cahiers Agricultures* 2:9–25.
- de Leeuw P N, Diarra L and Hiernaux P. 1990. *Livestock populations, feed resources and carrying capacity of the Gourma region in Mali*. Paper prepared for the technical meeting on "Savanna Development and Pasture Production" Woburn, UK, 19–21 November. ODI (Overseas Development Institute)/Commonwealth Secretariat, London, UK.
- Matlon P J and Fafchamps M. 1988. *Crop budgets for three agro-climatic zones of the West African semi-arid tropics*. Resource Management Program, Economics Group Progress Report 85. ICRISAT (International Crops Research Institute for the Semi-Arid Tropics), Patancheru, India. 48 pp.
- McIntire J, Bourzat D and Pingali P. 1992. *Crop–livestock interaction in subSaharan Africa*. The World Bank, Washington, DC, USA. 246 pp.
- Mokwunye A U. 1980. Interaction between farmyard manure and NPK fertilizers in savanna soils. In: FAO (Food and Agriculture Organization of the United Nations), *Organic recycling in Africa*. FAO Soils Bulletin 43. FAO, Rome, Italy.
- NAS (National Academy of Sciences). 1983. *Underutilized resources as animal feedstuffs*. National Academy Press, Washington, DC, USA.
- Padwick G W. 1983. The maintenance of soil fertility in tropical Africa: A review. *Experimental Agriculture* 19:293–310.
- Penning de Vries F W T. 1983. *The productivity of Sahelian rangelands — A summary report*. Pastoral Network Paper 15b. ODI (Overseas Development Institute), London, UK.
- Pichot J, Sedogo M P, Poulain J F and Arrivets J. 1981. Evolution de la fertilité d'un sol ferrugineux tropical sous l'influence de fumures minérales et organiques. *Agronomie Tropicale* 36:122–133.
- Pieri C. 1986. Fertilisation des cultures vivrières et fertilité des sols en agriculture paysanne subsaharienne. *Agronomie Tropicale* 41:1–20.
- Powell J M and Williams T O. 1993. *Livestock, nutrient cycling and sustainable agriculture in the West African Sahel*. IIED (International Institute for Environment and Development) Gatekeeper Series SA37. IIED, London, UK. 15 pp.
- Powell J M, Ikpe F N and Somda Z C. 1992. *Nutrient cycling in low external input millet-based mixed farming systems of West Africa*. Agronomy Abstracts. American Society of Agronomy, Madison, Wisconsin, USA. 70 pp.
- Pratt P F, Davis S and Sharpless R G. 1976. A four-year field trial with animal manures. *Hilgardia* 44:99–125
- Prudencio Y C. 1987. *Soil and crop management in selected farming systems of Burkina Faso: Agricultural research and policy implications*. Preliminary Edition. OAU/STRC/SAFGRAD, Ouagadougou, Burkina Faso.
- Quilfen J P and Milleville P. 1983. Résidus de culture et fumure animale: un aspect des relations agriculture–élevage dans le nord de la Haute-Volta. *Agronomie Tropicale* 38:206–212.
- République du Niger. 1991. *Annuaire des statistiques. Séries longues*. Ministère du Plan. Niamey, Niger.
- République du Niger. 1993. *Annuaire des statistiques de l'agriculture et de l'élevage 1991*. Ministère de l'agriculture et de l'élevage. Niamey, Niger.

- de Ridder N and van Keulen H. 1990. Some aspects of the role of organic matter in sustainable intensified arable farming systems in the west African semiarid tropics. *Fertilizer Research* 26:299–310
- Sandford S. 1977. *Dealing with drought and livestock in Botswana*. ODI (Overseas Development Institute) Report, London, UK.
- Sandford S. 1989. Crop residue/livestock relationships. In: ICRISAT (International Crops Research Institute for the Semi-Arid Tropics), *Soil, crop, and water management systems for rainfed agriculture in the Sudano-Sahelian zone*. Proceedings of an International Workshop held at ICRISAT Sahelian Centre, Niamey, Niger, 11–16 January 1987. ICRISAT, Patancheru, India. pp. 169–182.
- Schleich K. 1986. Le fumier peut-il remplacer la jachère? Possibilité d'utilisation du fumier: exemple de la savane d'Afrique occidentale. *Revue d'élevage et de médecine vétérinaire des pays tropicaux* 39:97–102.
- Swinton S M. 1988. Drought survival tactics of subsistence farmers in Niger. *Human Ecology* 16:123–144.
- Tacher G. 1975. Notes sur la démographie bovine au Sahel. *Revue d'élevage et de médecine vétérinaire des pays tropicaux* 28:547–595.
- Toulmin C. 1983. *Economic behaviour among livestock keeping peoples: A review of the literature on the economics of pastoral production in the semi-arid zones of Africa*. Development Studies Occasional Paper 25. University of East Anglia, Norwich, UK. 117 pp.
- Toulmin C. 1985. *Livestock losses and post-drought rehabilitation in sub-Saharan Africa*. LPU Working Paper 9. ILCA (International Livestock Centre for Africa), Addis Ababa, Ethiopia. 105 pp.
- Watson K A and Goldsworthy P R. 1964. Soil fertility investigations in the middle belt of Nigeria. *Empire Journal of Experimental Agriculture* 22:290–302.
- Wilson R T. 1986. *Livestock production in central Mali: Long-term studies on cattle and small ruminants in the agropastoral system*. ILCA Research Report 14. ILCA (International Livestock Centre for Africa), Addis Ababa, Ethiopia. 111 pp.

# Nutrient flux between maize and livestock in a maize–coffee–livestock system in central Kenya

J.K. Ransom,<sup>1</sup> J. Ojiem<sup>2</sup> and F.K. Kanampiu<sup>3</sup>

1. Centro Internacional de Mejoramiento de Maiz y Trigo (CIMMYT)  
P O Box 25171, Nairobi, Kenya
2. Kenya Agricultural Research Institute (KARI), P O Box 169, Kakamega, Kenya
3. Kenya Agricultural Research Institute (KARI), P O Box 27, Embu, Kenya

## Abstract

Soil productivity has been declining in the central highlands of Kenya due to intensive cropping. To obtain information on potential points which could be managed to better conserve nutrients within the farming system, the flux of nitrogen and phosphorus was monitored in four randomly selected farms in Embu District during the 1990/91 short rainy season and in three farms during the same season in 1991/92. Grain yield, stover production, stover removal, and fertiliser and manure use were measured. Maize yields on average were nearly 4 t/ha in the 1990/91 and 5 t/ha in 1991/92. Measured stover production averaged 2.9 t/ha and 4.9 t/ha in the 1990/91 and 1991/92 seasons, respectively. Averaged across all farms and years, 72% of all stover was fed to animals. Nitrogen and phosphorus removal by grain averaged 50.7 kg/ha and 17.5 kg/ha, respectively, and by stover 4.9 kg/ha and 1.9 kg/ha, respectively. All four farms received chemical fertiliser in 1990/91 but only one received fertiliser in 1991/92. Fertiliser supplied more than 50% of the phosphorus. Manure was applied in five of the seven farm-years and supplied most of the nitrogen in the system. Inputs of nutrients by manure far exceeded their removal by stover. Due to the importance of manure in maintaining the productivity of the soil, sustaining the production of fodder and developing improved manure-handling techniques are suggested as key elements in sustaining maize productivity in this area.

## Flux d'éléments nutritifs entre le maïs et les animaux d'élevage dans un système maïs–café–élevage au Kenya central

J.K. Ransom,<sup>1</sup> J. Ojiem<sup>2</sup> et F.K. Kanampiu<sup>3</sup>

1. Centro Intenacional de Mejoramiento de Maiz y Trigo (CIMMYT), P.O. Box 25171, Nairobi (Kenya)
2. Kenya Agricultural Research Institute (KARI), P.O. Box 169, Kakamega (Kenya)
3. Kenya Agricultural Research Institute (KARI), P.O. Box 27, Embu (Kenya)

## Résumé

*La productivité des sols diminue dans les hauts plateaux du Kenya central en raison des pratiques culturales intensives fréquentes dans cette région. Les flux d'azote et de phosphore ont été mesurés au cours des petites saisons des pluies de 1990/91 et de 1991/92 dans quatre exploitations du district d'Embu choisies au hasard. L'objectif était d'obtenir des informations sur les paramètres des systèmes de production dont on pourrait améliorer la gestion afin de mieux conserver les éléments nutritifs dans le système agraire. Pour ce faire, on a déterminé les rendements en grains, la production et l'utilisation de paille, ainsi que l'utilisation d'engrais et de fumier. En moyenne, les rendements de maïs avoisinaient 4 t/ha en 1990/91 et 5 t/ha en 1991/92. Quant à la production moyenne de paille, elle était de 2,9 t/ha en 1990/91 et de 4,9 t/ha en 1991/92. Environ 72% de la production totale de*

*paille était utilisée pour nourrir le bétail. Les quantités moyennes d'azote et de phosphore exportées pour les grains étaient de 50,7 kg/ha et 17,5 kg/ha contre 4,9 kg/ha et 1,9 kg/ha pour la paille. Alors que toutes les exploitations avaient été fertilisées en 1990/91, seul un tiers d'entre elles l'avait été en 1991/92. Les engrais avaient apporté plus de 50% du phosphore. Du fumier avait été appliqué dans cinq des sept exploitations et constituait la source de la presque totalité de l'azote dans le système. Les quantités d'éléments nutritifs apportées par le fumier étaient largement supérieures à celles exportées par la paille. Etant donné l'importance du fumier dans le maintien de la productivité des sols, la production durable de fourrage et l'adoption de meilleures techniques de gestion du fumier ont été identifiées comme étant les principales actions à entreprendre pour promouvoir une productivité soutenue du maïs dans cette région.*

## Introduction

The central highlands are an important agricultural zone in Kenya. They have relatively good rainfall and fertile soils which have to date sustained sufficient production of both food and cash crops to meet the needs of the rapidly increasing population. Productivity gains in these highlands in the recent past have been achieved through intensification of land use, as little new land is available. Within this zone, land is permanently cropped. This generally involves the continuous cultivation of maize. Maize productivity was greatly enhanced in this area through the introduction of a production package which included high yielding hybrids (Mwania et al, 1990).

The sustained productivity of the soils in the central highlands has become a serious concern because of intensive cultivation. Soil fertility has been identified as one of the most important constraints to maize production in Embu District (Mwenda, 1985). This decline suggests the need to increase research directed toward developing technologies which maintain or increase soil nutrient availability to crops, fodder and trees. One strategy that can be used to accomplish this is through the judicious and complementary addition of nutrients from outside the livestock-crop system. Increases in maize yield have consistently been obtained through the addition of chemical fertiliser in Embu District. On-farm experiments have shown that yields can often be doubled with modest applications of between 40–50 kg/ha each of nitrogen (N) and  $P_2O_5$  (KARI, 1989). Nevertheless, few farmers appear to use fertiliser on their food crops even after observing the beneficial effects in on-farm trials. Although fertiliser is used on coffee more often than on maize, the levels used are also below those recommended (Muriithi, 1990). A disincentive for the use of fertiliser on maize is the relatively high cost. The nitrogen fertiliser to maize grain price ratio (kg/kg), which has experienced wide fluctuation in recent months, was 9.1:1 a year before this study was initiated, one of the highest for all of Africa (CIMMYT, 1990).

Another strategy for maintaining the productivity of the soil would be to develop ways of reducing or eliminating nutrient losses in the system. Loevinsohn and Wang'ati (1993) suggested a number of ways in which this might be accomplished. These include increased efficiency of nutrient capture and the transformation and return to the soil of nutrients in plant and animal products; better synchronisation of the release of nutrients in the soil and uptake by crops; and conserving organic matter and maintaining soil pH at an acceptable level.

Developing recommendations based on the cycling of existing nutrients in the system is usually more complex than basing them on applications of fertiliser or other amendments external to the farming system. However, recommendations are urgently needed if the rate of soil productivity decline is to be arrested. To identify leverage points in the farming system that can be exploited to increase the utilisation of nutrients in the existing system, a detailed inventory of the nutrient movement is needed. Little information of this type is available for most farming systems in Kenya. The objective of this research was to document the movement of above-ground sources of N and phosphorus (P) among the various components of a maize-animal-coffee system in central Kenya.

## Materials and methods

The study was initiated with the harvest of the 1990/91 short rains crop (January 1991) and concluded with the planting of the 1992 long rains crop (March 1992). The study site was located in Embu District of central Kenya.

### Description of the study site

Embu District is located on the slopes of Mount Kenya and the farms which were sampled were within 20 km of the Kenya Agricultural Research Institute (KARI), Regional Research Centre, Embu. The elevation of the study area is about 1500 m above sea level. Rainfall varies between 1000 and 1400 mm per annum falling in two distinct cropping seasons (long rains March–August, short rains October–January). The soils are described as very deep, well drained humid Nitrosols, which are dusky red to dark reddish brown in colour. They are generally very friable and have a moderate to high level of inherent fertility (Muchena et al, 1982).

The farming system is relatively complex and intense. Coffee is the predominant cash crop and occupies on average 50% of the cultivated area. Coffee generally receives priority in the allocation of labour and purchased inputs because of its cash generating capacity. Annual food crops occupy the remaining area, the dominant crop being maize. Maize is grown as a sole crop or intercropped with beans. The mid-altitude maize hybrids, H511 and H512, are commonly planted in both seasons, and there is limited crop rotation and fallowing. Potatoes, sweet potatoes and bananas are also cultivated, though on a limited area.

Farmers also keep dairy cattle (one or two units, generally) under a zero or semi-zero grazing system, where fodder is cut and carried to the animal. The main source of forage is Napier grass (*Pennisetum purpureum*), which is often grown on the edges of the cultivated fields. Additionally, crop residues are important supplementary feeds.

### Field measurements

Four farms were randomly selected within the Embu District. These farms had similar farming systems containing components that included maize, coffee and livestock. At the time of the maize harvest, four 5 x 5 m subsamples were harvested from each farm. From these subsamples, grain yield, total stover weight and the amount of stover carried from the field to the animals was determined.

These same maize fields were monitored before planting and records of all the manure and fertiliser applied were kept. The amount of fertiliser applied was determined by dividing the total amount of fertiliser purchased and applied by the farmer by the area of application. The amount of manure applied was determined by weighing five sample manure piles in the field before they were broadcast and incorporated. The total number of piles were counted and the weight per hectare calculated based on the total area to be planted. The same sites were used during both monitoring seasons with the exception of farm #4 in 1991/92 where no data were taken. Subsamples of manure, maize grain and maize stover were analysed to determine their N and P content at the National Agricultural Laboratories in Nairobi.

## Results and discussion

Grain yields were generally high with the average yield for both seasons exceeding 4 t/ha (Table 1). This is more than double the national average yield for Kenya for the period 1989–91 (CIMMYT, 1992). The range in yield between farms was 2.1 t/ha in 1990/91 and 1.1 t/ha in 1991. Stover yields were correlated to grain yield, though the total amount recorded was less than expected given the grain yields measured. This was particularly true in 1991. The harvest index of the fields often exceeded 50%. Nevertheless, it was not readily apparent why the stover weight might have been under-estimated.



The proportion of stover removed from the field after harvest was high, with an average of 75% of all stover being fed to animals in 1990/91 and 68% in 1991. The quality of the dry maize stover was probably quite low, since the N content of the maize stover ranged from 0.48 to 0.55% in 1990/91 and 0.60 to 0.98% in 1991. Nevertheless, the confined animals consumed the maize stover, and it became an important component of their diet after harvest.

Total nitrogen removal by grain and stover averaged 58.8 kg/ha in 1990/91 and 74.6 kg/ha in 1991 (Table 2). Stover removal accounted for 20% of the N in 1990/91 and 26% in 1991. Total phosphorus removal (expressed as P<sub>2</sub>O<sub>5</sub>) was 18.7 kg/ha in 1990/91 and 20.4 kg/ha in 1991/92. Stover removal accounted for only 11 and 9% of the total phosphate removed by the maize crop in 1990/91 and 1991, respectively.

**Table 1.** *Maize grain and stover yields and percentage of maize stover removed from fields at harvest in four farms in central Kenya, 1990/91 and 1991/92.*

Farm	Grain yield (kg/ha)	Stover yield (kg/ha)	Stover removed (%)
1990			
1	3200	3156	83
2	3380	1728	71
3	5365	4306	75
4	3957	2508	70
Mean	3975	2925	75
1991			
1	4820	4610	80
2	5530	5250	68
3	4430	4820	56
4	—	—	—
Mean	5663	4893	68

**Table 2.** *Nitrogen and phosphorus removal from maize fields by grain and stover in four farms in central Kenya, 1990/91 and 1991/92.*

Farm	Nitrogen			P <sub>2</sub> O <sub>5</sub>		
	Grain	Stover	Total	Grain	Stover	Total
1990/91 season						
1	41.9	12.6	54.5	14.6	3.0	17.6
2	35.8	6.5	42.3	14.7	0.8	15.5
3	60.1	17.2	77.3	22.1	3.0	25.1
4	51.4	9.8	61.2	14.5	2.0	16.5
Mean	47.3	11.5	58.8	16.5	2.2	18.7
1991/92 season						
1	57.9	22.6	80.5	19.7	1.9	21.6
2	54.8	19.6	74.4	18.7	1.2	19.9
3	53.1	16.1	69.2	18.2	1.3	19.5
4	—	—	—	—	—	—
Mean	55.2	19.4	74.6	18.9	1.5	20.4

Fertiliser use was generally low when compared to the 50:50 kg/ha N:P<sub>2</sub>O<sub>5</sub> that is recommended for the area (Table 3). Phosphorous was applied at about twice the rate of nitrogen, largely due to the wide-spread use at planting of diammonium phosphate, which was the primary fertiliser type available in the market. All farmers applied fertiliser in 1990, while only one farmer applied fertiliser in 1991. The reduced use of fertiliser in 1991/92 may be related to its increased price and its reduced availability during the planting period.

**Table 3.** Fertiliser and manure applications to maize fields and their nitrogen and phosphorus contribution to four farms in central Kenya, 1990/91 and 1991/92.

Farm	Fertiliser		Manure		
	Nitrogen	P <sub>2</sub> O <sub>5</sub>	Dry matter	Nitrogen	P <sub>2</sub> O <sub>5</sub>
			(kg/ha)		
1990					
1	8.4	21.5	3040	41.5	13.4
2	13.3	6.7	7980	84.6	31.1
3	16.2	41.3	0	0	0
4	17.5	44.8	5320	65.4	20.7
Mean	13.9	28.6	5447	63.9	21.7
1991					
1	11.4	29.3	0	0	0
2	0	0	13000	260	35.1
3	0	0	5380	108	14.5
4	–	–	–	–	–
Mean	3.8	9.8	6127	123	16.5

Manure was applied in five of the seven farm-years (Table 3). Levels applied ranged from 3040 to 13,000 kg/ha. In all cases when applied, manure contributed more N to the field than did chemical fertiliser. In 1990, farmers applying manure also applied fertiliser, while in 1991 they applied either one or the other. Manure samples contained an average of 1.2% N in 1990/91 and 2.0% in 1991/92 (only one composite sample was analysed in 1992). The 1.2% value is within the range of values found for good quality manure in eastern Africa (Probert et al, 1992). The 2.0% value was higher than expected. Farmer #2 consistently applied high rates of manure. Probert et al (1992) found even higher application rates of 38 to 168 t/ha in drier parts of eastern Kenya, though the quality of the manure was much lower than we found in this study. Nevertheless, the total nutrients applied far exceeded the nutrient requirements of the following crop.

The flux of nitrogen and phosphorus into and out of the maize fields was calculated based on the nutrients removed by the grain and stover and the inputs of nutrients into the field through fertiliser and manure (Table 4). These net values were calculated using the measured concentration of N and P in the manure as well as a theoretical level, which is based on an average per cent N and P (0.72% N and 0.57% P<sub>2</sub>O<sub>5</sub>) found in manure reported by others in eastern Africa (Probert et al, 1992). This allows a more conservative look at the potential contribution of N and P by manures.

**Table 4.** *The flux of nitrogen and phosphorus (inputs of fertilisers and manure minus removal by grain and stover) in four farms in central Kenya, for the 1990/91 and 1991/92 short rainy seasons using both the measured and average reported nutrient content for manure.*

Farm	Measured nutrients		Average reported nutrient	
	Nitrogen	P <sub>2</sub> O <sub>5</sub>	Nitrogen	P <sub>2</sub> O <sub>5</sub>
	----- (kg/ha) -----			
1990				
1	-4.6	17.3	-24.2	21.2
2	55.6	22.3	28.5	36.7
3	-61.1	16.2	-61.1	16.2
4	21.7	49.0	-5.4	58.6
Mean	6.6	26.2	-15.6	33.2
1991				
1	-69.1	7.7	-69.1	7.7
2	185.6	16.0	19.2	73.7
3	38.8	-5.0	-30.5	19.2
4	-	-	-	-
Mean	51.8	6.2	-26.8	33.5

Averaged over all farms using the measured levels of N and P, there was a net gain in both nutrients in both years. However, the N balance of individual farms varied considerably, ranging from -69.1 to 185.6 kg/ha N. Only farmer #1 had a negative N balance both years. Based on a more conservative nutrient concentration in the manure, however, average N balances were negative both years. Furthermore, only farmer #2 had positive N values both seasons. Inputs of P, for the most part, were equal to or greater than its removal. Only farmer #3 recorded a negative value, and this was only in 1991/92.

This study did not try to quantify the inputs and losses of plant essential nutrients through ways other than those described here. No doubt they can significantly affect the final nutrient balance of the system. Nevertheless, these data give some indication of the potential sustainability of the system, and suggest that the farmers in this study are able to sustain a fairly high level of production using a combination of fertilisers and manures. Chemical fertilisers contributed 56% of the phosphorus in 1990/91, but only 37% in 1991/92. Nitrogen, however, was supplied to a greater extent by manure than by fertiliser with 82 and 98% supplied by manure in 1990/91 and 1991/92, respectively. Nitrogen and phosphorus removal was greater by grain than by stover. Even though the percentage of stover fed to the animal was very high, the amount of nutrients being returned in the manure in most cases far exceeded the amount removed by stover. This suggests that the maize field is benefitting from nutrients derived from other components of the systems, which are transferred to it via animal manure. Napier grass and fodders from on- or off-farm sources are likely contributors, and were not examined in this study. Maintaining productivity of such sources, however, appears to be essential to the maintenance of the soil fertility level of the maize fields. Technology which would maximise the conservation of essential nutrients in the manure would also be valuable. Considerable variability was observed in the way that farmers currently handle the manure produced on-farm.

## Acknowledgements

The financial contribution of the Canadian International Development Agency (CIDA) through the East Africa Cereals Project, is gratefully acknowledged. Special thanks are also given to the technical assistance provided by E. Njiru and N.N. Njakuthi.

## References

- CIMMYT (Centro Internacional de Mejoramiento de Maiz y Trigo). 1990. *1989/90 CIMMYT world maize facts and trends: Realizing the potential of maize in sub-Saharan Africa*. CIMMYT, Mexico, D.F., Mexico. 72 pp.
- CIMMYT (Centro Internacional de Mejoramiento de Maiz y Trigo). 1992. *1991–92 CIMMYT world maize facts and trends: Maize research investment and impacts in developing countries*. CIMMYT, Mexico, D.F., Mexico. 57 pp.
- KARI (Kenya Agricultural Research Institute). 1989. *Annual Report of the Regional Research Centre—Embu*. KARI, Embu, Kenya.
- Loevinsohn M and Wang'ati F. 1993. *Integrated natural resource management research for the highlands of east and central Africa*. Consultants report. ICRAF (International Centre for Research in Agro-Forestry), Nairobi, Kenya.
- Muchena F N, Van der Pour B J and Siderius W. 1982. *An outline of major soils in Kenya*. Kenya Soil Survey, National Agricultural Laboratories, Ministry of Agriculture, Nairobi, Kenya.
- Muriithi F M. 1990. *Factors influencing the use of purchased inputs in food crop production: Gaturi south location Runyenjes Division, Embu District, Kenya*. KARI (Kenya Agricultural Research Institute), Regional Research Centre, Embu, Kenya. (unpublished).
- Mwania N W, Shiluli M C and Kamidi M K. 1990. Towards appropriate agronomic recommendations for small-holder maize production in the highlands of Western Kenya. In: Gebrekidan B (ed), *Maize improvement, production and protection in eastern and southern Africa*. Proceedings of the Third Eastern and Southern Africa Regional Maize Workshop. CIMMYT (Centro Internacional de Mejoramiento de Maiz y Trigo), Nairobi, Kenya. pp. 321–337.
- Mwenda E W. 1985. The maize program in Kenya. In: Gelaw B (ed), *To feed ourselves*. A Proceedings of the First Eastern, Central and Southern Africa Regional Maize Workshop. CIMMYT, Mexico. pp. 32–37.
- Probert M E, Okalebo J R, Simpson J R and Jones R K. 1992. The role of boma manure for improving soil fertility. In: Probert M E (ed), *A search for strategies for sustainable dryland cropping in semi-arid eastern Kenya*. Proceedings of a Symposium held in Nairobi, Kenya, 10–11 December 1990. ACIAR Proceedings 41. ACIAR (Australian Centre for International Agricultural Research), Canberra, Australia. pp. 63–69.

# Farmer and pastoral strategies in Saurashtra, Gujarat: An analysis of landless pastoralism and dependence on the manure market

R.P. Cincotta<sup>1</sup> and G. Pangare<sup>2</sup>

1. Agency for International Development (USAID), Washington, DC 20523–1819, USA

2. Institute of Rural Management, Anand 388 001, Gujarat, India.

## Abstract

Over the past 40 years, Bharavad pastoralists from Saurashtra in Gujarat State, India, have found themselves divested of rangelands and village commons that were formerly the primary source of nutrition for their ruminant livestock. To adjust to the changing socio-economic and biotic–edaphic environments, Bharavad pastoralists in this region have de-emphasised the production of more nutrient-demanding livestock products and focused on co-existing with farm production through marketing livestock manure. A model that was used to examine the economics of farmers' involvement in the agropastoral production system predicts that farmers with improved dairy cattle will profit most from (a) utilising high quality on-farm crop residues for their own milk production, and (b) trading low quality crop residue to pastoralists for manure. Other researchers have suggested [in response to our own analysis] that farmer–pastoralist relationships focusing on nutrient cycling can often be over-emphasised. This paper argues that in Saurashtra (and most likely in other areas where pastoral groups are politically marginalised), manure trade is the only production activity available to herders that utilises pastoral skills and is remotely sustainable.

## Stratégies agricoles et pastorales à Saurashtra dans l'Etat de Gujarat (Inde): les éleveurs sans terre et la dépendance vis-à-vis du fumier

R. P. Cincotta<sup>1</sup> et G. Pangare<sup>2</sup>

1. Agency for International Development (USAID), Washington, DC 20523–1819 (E.-U.)

2. Institute of Rural Management, Anand 388 001, Gujarat (Inde)

## Résumé

*Au cours des 40 dernières années, les éleveurs Bharavad de Saurashtra, dans l'Etat de Gujarat (Inde), se sont retrouvés privés des pâturages et des terrains communaux qui leur procuraient l'essentiel des aliments de leurs animaux. Afin de s'adapter à ce nouvel environnement socio-économique et bio-édaphique, ces éleveurs délaissent les productions animales, plus exigeantes en éléments nutritifs, au profit de l'association agriculture–élevage grâce à la commercialisation de fumier. L'utilisation d'un modèle d'évaluation de la rentabilité de l'adoption d'un système de production agropastorale prévoit que les paysans possédant des vaches laitières tirent le meilleur parti possible de a) l'utilisation de résidus de récolte de bonne qualité produits sur l'exploitation pour leur propre production de lait et b) l'échange de résidus de qualité médiocre contre du fumier avec les éleveurs. D'autres chercheurs estiment (suite à notre analyse) que l'on accorde souvent trop d'importance aux relations entre agriculteurs et éleveurs. Il reste cependant qu'à Saurashtra et probablement dans d'autres régions où ils sont politiquement marginalisés, les éleveurs, compte tenu de leurs aptitudes, ne peuvent pratiquer que l'échange de fumier comme activité productive, activité dont la viabilité est en outre marginale.*

## Introduction

Gujarat is the home of several pastoral peoples, most notably the Bharavads, Maldharis and Rebaris. These communities have for centuries utilised the vast grasslands, shrublands and savannahs of this state to graze their livestock. However, rapid human population growth (especially within the farming community), the increased application of agricultural technology, and changes in village-level land tenure arrangements have irrevocably altered the face of Gujarat's rural landscape. The community that this paper will focus upon, Bharavad pastoralists in the Rajkot District of Saurashtra (the south-central region of Gujarat), have been greatly affected by, and have adapted to these changes. They presently participate in the agricultural system by providing important nutrient and energy inputs to small farms: farms exchange crop residue feeds and sometimes cash supplements for small ruminant (sheep and goat) manure and human labour (Cincotta and Pangare, 1992; 1993a; 1993b).

Scientists and managers have questioned the overall animal productivity of this system. Scientists who are concerned about small ruminant productivity point out that keeping goats and sheep in enclosures to facilitate dung collection is likely to limit grazing time and reduce animal productivity. Many professional dairy managers who are interested in increasing regional milk output suggest that these residues, chiefly the straws of *bajra* (pearl millet) and wheat, could be used in the rations of additional dairy cattle to produce some milk in addition to manure (R.P. Aneja, personal communication). In fact, the relatively large rumen volumes and slow rates of passage associated with milch cattle and buffalo digestive anatomies, are better suited to extracting energy from fibrous feeds than are the less voluminous digestive tracts of sheep and goats (cf. Demment and Van Soest, 1985).

However, the productivity of an agricultural system can neither be understood nor dealt with as a whole. These production systems are sets of individual adaptive strategies that each participant has evolved to cope with the environment, with each other, and with the economic and political constraints that history has imposed. Thus, one should assume that each producer will have consciously attempted to achieve an optimal use of available (constrained) inputs given the information on hand and the perceived planning period.

The objective of this paper is to propose models that conceptualise the opportunities that crop residue utilisation and manure production represent for both farmer and pastoralist in this system. These conceptualisations (or general hypotheses) are drawn from analyses of participant observation and interviews obtained in a pilot study of members of 20 herder and 10 farmer households conducted in 1992 in Saurashtra (Cincotta and Pangare, 1992; 1993a; 1993b). The conclusions reflect upon the apparent sustainability of the agropastoral system that was observed and conceptualised, and compares it to other pastoral production systems that remain in existence both within and outside of India.

## Study site

The major part of this study was undertaken in the town of Sarapdad in Rajkot District. There were approximately 40 Bharavad families out of a total of about 7000 inhabitants. A rural town, the inhabitants of Sarapdad are primarily farmers and shopkeepers. The nearby smaller towns of Shri Kerala and Suvag have a similar percentage of Bharavads: 4–5% of the populace. In this area of Saurashtra, Bharavad pastoralists are almost exclusively small ruminant herders although a minority (about eight households) have focused on other village trades, especially local transport (motorised rickshaws) and farming.

Presently, Bharavads live in brick houses along the edges of towns and villages, which are clustered in a "communal style". The houses have common areas in which Bharavad families mix. Nearby, on the outskirts of the village, each household maintains a corral (characteristically 300–600 m<sup>2</sup>) which is enclosed on all sides by a "natural" fence (2–2.5 m high) of prickly pear cactus<sup>1</sup> and can be entered

1. Species in the cactus family (Cactaceae) are not native to India. However, despite the semi-arid conditions of the village commons, no spurious spread of this non-native plant was observed beyond the hedgerows that were planted by the Bharavad pastoralists. Village children regularly picked the abundant ripe fruits of the cactus and ate them.

through a narrow hand-wired gate. The corrals, built adjacent to one another with common fence-lines, grow to resemble a confusing maze of cactus hedge rows. Essentially, these corrals are a focal point for manure accumulation and harvest, and the location from which much of this material must be transported to agricultural fields up to 5 km from the village.

Bharavad households around Sarapdad keep from 40–250 small ruminants, about 90% of which are of the Maravadi sheep breed (the other 10% are goats), a native, coarse wool breed. Income (either in cash or trade goods) from sheep is generated from the sale of live animals for meat, sheered wool, milk and dung. Black-haired goats are kept, as well, principally for their milk production. Two families keep only goats, sending their milk to the local village milk co-operative society (butter fat content of about 3.5%). Goat hair is harvested and spun by family members for rope.

Around 25% of the Bharavad herds are involved in a dry-season migrational circuit that takes them onto irrigated farmland in central Gujarat (near Ahmedabad). Interviewed pastoralists suggested that during severe drought (such as 1986–87), where both forage and water are in short supply in the village, nearly all families migrate with their herds in search of forage. During the drought of 1986–87, most families lost or sold 50–75% of their livestock.

## **Model 1: Agropastoralism in Saurashtra**

### **Evolution of agropastoralism**

What Galaty (1992) referred to as "the nightmare of landless pastoralism" has largely become a fact of life for most of Gujarat's pastoralists over the past four decades. Irrigation and improved techniques of dryland farming have permitted small-scale agricultural production to virtually overwhelm the most productive rangelands. In the early 1950s, the Gujarat Government endorsed the precepts of a Gandhian grassroots movement, the Bhoodan Movement, that pressured local governments to distribute the remaining common lands to the village landless, mainly Harijans, for farming. The majority of Bharavad households, however, continue to rely at least partly on livestock rearing as their source of livelihood.

Because the local Bharavad community has lost control of its access to forage and to land (Cincotta and Pangare, 1993a; 1993b), its pastoral existence lies inextricably tied to farmers, who by virtue of their production of crop residues, now control a critical element of pastoral production. Moreover, during the past two decades, small farmers in Gujarat have been organised into a system of district level dairies and supporting village cooperative societies by the National Dairy Development Board (NDDB), and have assumed the central role in large ruminant (cattle and buffalo) production. Although Gujarat's dairies process an enormous volume of milk, the industry, which is based upon a per-animal production of less than seven litres per day, is supported principally by on-farm crop residues. NDDB has, more recently, encouraged farmers to upgrade their dairy animals and their forage sources to increase milk production.

Although Bharavads have traditionally been cattle keepers, both for bullock and milk production (Rangnekar, 1993), the vast majority of these pastoralists have adapted to the loss of access to forage by taking up small ruminant production (sheep and goats). Their animals produce manure, wool, and meat for local markets (Bharavads, themselves, are vegetarians), while milk and goat hair are principally used in the household. Because butterfat content is the parameter by which milk is priced in cooperative dairy societies in India, the low butterfat content of local goat milk (3–3.5%) does not greatly reward participation. Where access to fodder has been retained, either by purchasing or acquiring land during land reform (Chen, 1991), or by obtaining access to reliable markets of good quality fodder and feed (Salzman, 1988), these pastoralists have participated actively in dairy cooperatives.

Today, Bharavad small ruminant livestock producers gain access to forage principally by trading small ruminant manure and human labour for crop residues and use of fallow fields (Cincotta and

Pangare, 1993a). In fact, with the expansion of irrigation schemes and the acceleration of cropping, this livelihood is likely to expand (Cincotta and Pangare, 1993b). Thus, Bharavad communities have continued to use many of the traditional skills, the knowledge base, and organisational systems that are associated with livestock keeping.

### **A decision tree of pastoral constraints**

A decision tree has been designed (Figure 1) to explain the narrowing of productive possibilities that face Bharavad pastoralists in Saurashtra, and indeed many pastoralists throughout India. Whereas a decision tree is usually generated to conceptualise the contemporary path of options that is accessible to a decision-maker, it will become apparent that, in actuality, the pastoralist enjoys few real productive options: decisions have already been made for the pastoralist by an historical chain of events. Our decision tree is perhaps more like a dichotomous key, the points of articulation representing constraints in control over resources and capital that circumscribe and characterise systems of livestock production in Gujarat. Most Bharavad pastoralists are confined to the lower extremes of this decision tree, where constraints on resources are most severe.

The decision tree begins by acknowledging the changes wrought to the grazing ecosystem by the dramatic increase in human population during this century, and the conversion of common land to agriculture (Figure 1, Decision 1). Grassland and forest pastoralism still exist in Gujarat, among them Sindhi Muslim pastoralists in the Banni Grasslands of the nearby Kachchh Region (Bharara, 1987; 1993; Saxena, 1993), and a small group of Maldharis in the Gir Forest of Saurashtra (Seth, 1990). Yet even these systems rely on crop residues during some parts of the dry season (Singh et al, 1993).

The next tier of constraints (Decision 2) is associated with the availability of an adequate and continuous supply of high-quality forage for milk production, either from grazing, on-farm or commercial sources. Milk production decreases rapidly and non-linearly because low-forage quality (low digestible energy and N) both result in a decreased supply of nutrients per kg ingested, and suppresses total feed intake. To live off modern dairy production (which is not what small farmers do; dairy production is only a supplemental activity) pastoralists must have access to good quality forage, the ready capital to afford purchases, the herd capital in the form of improved milch animals, and the availability of veterinary care infrastructure to protect that capital. It is probably true that few Gujarati pastoralists have ever been in a position to put that combination together. However, pastoralists have previously been able to use combinations of grazing and low quality residues to raise strong, slow-growing bullocks (especially Kankrej breed) that have been marketed to farmers for pulling and plowing. This activity continues among some ethnic/caste groups in Gujarat, especially pastoral communities in the Kachchh (Chen, 1991; Mittal, 1993). However, with the increased mechanisation of threshing and farming, the demand for high-quality bullocks in the village has substantially decreased (Chen, 1991).

Most Bharavad pastoralists in and around Sarapdad do not have continuous access to supplies of good-quality forage, and thus have chosen to raise small ruminants for manure production. Pastoral herds of goats and sheep are principally maintained on energy metabolised from the digestible portions of low-quality residues. Nitrogen is obtained from grazing on local common property where heavily grazed forage vegetation tends to be sparse, physically defended (thorny, woody and sprawling), and chemically defended (inhibitory to digestion; Rhoades, 1979). This strategy is successful because sheep and goats are selective feeders, more physically adapted than cattle and buffalo to consuming self-defended vegetation (Ahuja and Rathore, 1987). Small ruminants have small mouth parts and prehensile lips, coupled with an ability to learn to forage among physical obstacles (especially goats; Pfister et al, 1988; Provenza and Balph, 1990). Selective feeders are also capable of ingesting nutritious compounds while maintaining themselves below critical thresholds of simultaneously ingested toxins and refractory substances. In Sarapdad, "wild" forage resources remain only on severely eroded village commons, in hedgerows, in fallow fields and along roadsides. Whereas these non-crop feed sources probably represent a relatively small amount of the biomass ingested, they are generally green and



**Figure 1.** Decision tree describing the historical evolution of constraints that have been imposed upon pastoralism, and the strategic adaptations to livestock raising within those constraints.

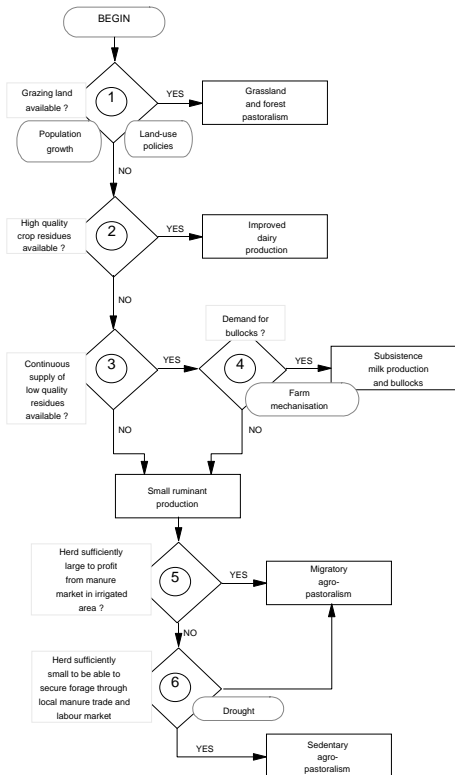

growing, and probably supply a good deal of the nitrogen necessary to maintain rumen bacterial function. Thus, it is likely that agropastoralism in Sarapdad encourages a net transport of nitrogen from village common land to agricultural fields.

In the village, manure is traded in three ways: (1) by exchanging small ruminant manure that was collected in corrals, for equal volumes of residue straw; (2) by keeping herds overnight on specified agricultural fields; and (3) by permitting pastoralists to graze their herds by day on fallow and uncut residue, especially cotton stover. According to interviewed farmers, pastoralists negotiate crop residues and cash for harvest labour, but manure is only infrequently purchased with cash in the village. However, interviewed pastoralists described arrangements in distant irrigated areas where exchanges of manure for cash were common.

### Agropastoral migration

During the dry season of average rainfall years, about 25% of Bharavad herders residing in and around Sarapdad move their small ruminants to irrigated areas of North Gujarat in pursuit of ample water, livestock feed, and wages (Cincotta and Pangare, 1993a). Availability of these benefits is associated with the continuous cropping system of irrigated agriculture, which (even during the climatic dry season) creates a continuous demand for organic manure and harvest labour, and a ready supply of crop residues.

Large herds, generally over 200 small ruminants, were most likely to undertake long-distant migration (Figure 2); the reason for this is not immediately obvious. However, if one considers that during the dry season it is common for pastoral labour to be traded for crop residue; it is clear that households with large herds often have insufficient labour available to meet the nutritional demand for maintenance of their animals. In addition, it is possible that their presence during a period of resource scarcity could strain relationships with other users of common resources such as water and any vegetation on common property. More significant is the apparent "commercial attraction" of owners of large herds to irrigated areas (Kavoori, nd). According to interviewed pastoralists, herders receive combinations of crop residue and cash for bedding their small ruminants on specified sections of cropland. Reportedly, cash payments range from Rupees (Rs) 0.25 to 1.00 per day for each adult animal, though some labour may be involved in this exchange.

**Figure 2.** Size distribution of migrant and non-migrant small ruminant herds in and around Sarapdad, Rajkot District, Gujarat.<sup>1</sup>

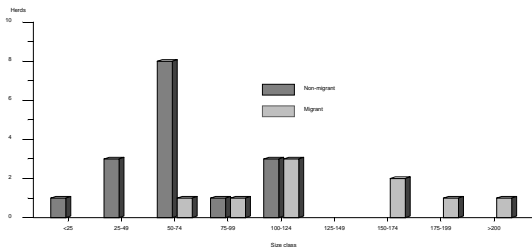

1. Larger herds appear more likely to migrate during the dry season.

Climatic conditions mediate the numbers of agropastoralists that undertake migration. When severe drought hit Saurashtra in 1987, nearly all of the local Bharavad herders were faced with shortages of water, forage, crop residues, and labour opportunity in the village. Large ruminants, which are owned primarily by farmers in the Sarapdad area, were maintained in cattle camps on government and Private Volunteer Organization (PVO)-supported rations (Jain, 1989). However, nearly all pastoralists reported that during the drought they had moved with their small ruminants to North Gujarat, causing livestock feed shortages along the route and even in the irrigated areas (small ruminants are not eligible for government-supported drought rations).

The social costs of migration include the insecurity of life in a tent, and the vulnerability of animals outside corrals. Bharavads suggest that, in migrating, there is theft of sheep, and sometimes violent altercations with farmers and townspeople (see Times of India, 1992).

## Model 2: Dairying for the small farmer

### Economic options associated with crop residues

Given the rate at which the rural population has grown and grazing land has disappeared over the last three decades, it is obvious that most of Gujarat's pastoralists face a situation of primary dependence on agricultural residues for animal nutrition. At the same time, there is a rising demand among farmers for plant nutrients and organic matter. Farm sizes continue to decrease due to subdivision during inheritance, while production has generally intensified because of the increased access to methods of irrigation. In addition, fertiliser subsidies are being eliminated as part of a general restructuring of the Indian economy that began in 1991. To conceptualise the interdependence between pastoralist and farmer, it is necessary to look at both sides of the relationship: (a) at the economics of being a farmer who has the option of exchanging crop residue for manure produced by pastoral herds of small ruminant, or use that residue for his own on-farm dairy production; and (b) at the narrowing of options that face the pastoralist in a changing political environment and ecological landscape.

Agriculture in Sarapdad, practised on holdings of 1–3 ha, is rainfed and largely dedicated to cash crops. Rainfall is bimodal: during the long rains (*kharif*) groundnuts appear to be the crop of choice; in the short rains (*rabi*) cotton, wheat, *bajra*, or groundnuts are sown. Farmers rely heavily upon livestock for nitrogen fertilisation and replacement of organic matter in soils. Small amounts of inorganic phosphorous are added at the beginning of the *kharif*, and urea is applied lightly before the flowering of some crops.

The ownership of a few (generally 1–3) dairy cattle and/or buffaloes represents an important component of production on small and medium-sized farms in Gujarat. The success and proliferation of the cooperative dairy movement has brought the full weight of urban demand for large quantities of high quality (high percentage of butterfat) milk to the village. This demand for milk and fat-heavy milk products (butter, cheese, yoghurt, Indian confections, ice-cream and flavoured milk drinks) has encouraged the acceptance of improved breeding and stall-feeding of dairy cattle/buffaloes. In the past, low-quality agricultural residues (e.g. wheat and millet straws) were fed to bullocks and milch livestock providing only little more than maintenance rations. However, bullocks did not require rapid growth to attain sufficient size and strength for traction (Rangnekar, 1993) and only very limited markets were open to dairy producers and these were controlled by middle-men. Thus, there was little financial incentive to produce much more than subsistence quantities of milk.

With markets opening to the small dairy producer, high quality forage (low cell wall, high digestible energy, and high digestible nitrogen content) was needed for increasing milk yield. Prices of nitrogenous forages, such as groundnut tops, other legumes, cottonseed meal and purchased commercial feeds increased (George, 1985). Farmers with some capital on hand, and agricultural residues left from their farming operations are faced with the choice between feeding the residue to their own dairy cattle or leaving residues to be eaten by the small ruminants of pastoral communities. These pastoralists would then reciprocate, through some local arrangement, by providing manure to

be sent to the field or directly applying manure and urine by leaving their herds on the agricultural fields overnight.

Interviewed farmers indicated that the success of their production strategy depends upon the partitioning of crop residues into low quality and high quality livestock feeds. At the same time, pastoralists have little control over the quality of the feed supply that is available from farmers, although they control the most readily available supplies of manure and, quite often, village labour. As a result, the bulk of feed intake for pastoral small ruminant herds is low quality residues, while nitrogen is obtained primarily from plants that are grazed on degraded common property while the animals are herded during the day.

### An optimisation model of crop residue partitioning

The choice of a crop residue partitioning strategy for farmers can be explained in the following equations that focus on the total economic value,  $V_t$ , of the dry matter of each kg of agricultural residue feed of a particular quality,  $q$ . For any residue the total value equals the value (net benefits) generated by residues minus the opportunity costs:

$$V_{tq} = (V_{mq} + V_{fq}) - (OC_{mq} + OC_{fq})$$

where:

$V_m$  is the net benefit of milk production

$V_f$  is the net benefit of manure production

$OC_m$  and  $OC_f$  are the opportunity costs for those same material outputs (i.e. the benefits foregone by not applying that quality of residue to another available strategy)

This model seeks to choose between only two simple production strategies, agropastoralism (subscript AP) and dairy production with on-farm sources of feed (subscript D). The strategy with the greatest payoff,  $V_t^*$ , from a kg of forage of a specific quality is the maximum of the two strategies:

Strategy 1

$$V_{tq}^* = \text{Max} [(V_{DMq} + V_{Dfq}) - (OC_{DMq} + OC_{Dfq}), (V_{APmq} + V_{APfq}) - (OC_{APmq} + OC_{APfq})]$$

Strategy 2

The net benefits to the farmer from the on-farm dairy strategy, D, are:

$$V_{DMq} = BF_{ANIM} MY(DE_{AVAIL}(DE_q, I(CW_q, UL_{ANIM}))) v_B / I(CW_q, UL_{ANIM})$$

where:

$BF_{ANIM}$  equals the kg butterfat per kg milk

$MY$  is the kg of milk produced from consumption of digestible energy

$DE$  is digestible energy, which itself is limited by the intake ( $I$ ) of that forage

$v_B$  is the value per kg butterfat

$I$  is the kg forage ingested as a function of  $CW$

$CW$  is the kg cell wall per kg forage

$UL$  is the upper limit to intake (see appendix)

$BF_{ANIM}$  is dependent upon the species and breed of ruminant animal (although intake of forages that are low in cell wall tends to depress butterfat content, intake of such forages, i.e. concentrates, is not a consideration in this simple model). In the case of village on-farm dairy production, either 0.045 for breed cow and 0.060 for buffalo are possible values.

$$V_{Dfq} = N_q FY(DIG_q, I(CW_q, UL_{ANIM})) v_N / I(CW_q, UL_{ANIM})$$

where:

$N$  is the nitrogen yield per kg faecal matter (assumed to be at 50% of the concentration of the forage nitrogen ingested)

$FY$  (correspondent to  $MY$ ) is the kg of manure produced on the forage consumed

$DIG$  is the digestibility of the forage

I is forage intake

$V_N$  is the average value per kg nitrogen estimated from interviews concerning the purchase of faeces by farmers and the faecal N of that material.

The amount of manure produced is a function of the digestibility of the forage (DIG), a factor that is depressed by forage intake (I).

For providing a residue to agropastoral herds (the agropastoral strategy), AP, net benefits to the farmer are:

$$V_{APm_q} = 0$$

$$V_{APf_q} = N_C \text{ FY}(\text{DIG}_C, I(\text{CWC}, \text{ULANIM})) V_N / I(\text{CWC}, \text{ULANIM})$$

Of course, no milk is returned to the farmer when forage is fed to someone else's small ruminant herd. The subscript C in the equation for manure benefits refers to the influence from intake of well-defended nitrogenous forages, grazed on common property, by the small ruminant herds. Nitrogen content of their faeces, total digestibility of the diet, and cell-wall content were assumed to include other sources outside crop residues, and were assigned mid-range values for hay, specifically those of groundnut hay (NRC, 1978).

For the on-farm dairy strategy, equations for opportunity costs consider the net benefits provided by the alternative strategy of purchasing good quality forage (subscript P)  $V_{Pm_p}$  and  $V_{Pf_p}$ . This includes reduction of value from feed costs, FC, as expressed as a fraction of the net benefit from milk and manure. The price was assumed to be 50% of the net value returned.

$$V_{Pm_p} = FC \text{ BF}_{ANIM} \text{ MY}(\text{DE}_{AVAIL}(\text{DE}_P, I(\text{CWP}, \text{ULANIM}))) V_B / I(\text{CWP}, \text{ULANIM})$$

$$V_{Pf_p} = FC \text{ N}_P \text{ FY}(\text{DIG}_P, I(\text{CWP}, \text{ULANIM})) V_N / I(\text{CWP}, \text{ULANIM})$$

Opportunity costs for on-farm dairy production would then be the amount lost by not taking advantage of the availability of this strategy, assuming that good-quality feed is available and capital can be advanced to purchase it. In Saurashtra, this feed is generally groundnut hay ( $\text{DE} = 2.55 \text{ kcal/g}$ ; NRC, 1978). Since opportunity costs are penalties for forgone benefits, by definition their sum must be greater than or equal to zero.

$$\text{OC}_{Dm_q} = V_{Pm_p} - V_{Dm_q}$$

$$\text{OC}_{Df_q} = V_{Pf_p} - V_{Df_q}$$

Condition: If  $(\text{OC}_{Dm_q} + \text{OC}_{Df_q}) < 0$ , then  $(\text{OC}_{Dm_q} + \text{OC}_{Df_q}) = 0$ .

For the agropastoral strategy, opportunity costs are associated with using the forage to feed on-farm improved dairy cattle rather than the combination of purchasing feed for them and trading the forage for small ruminant manure production. Thus,

$$\text{OC}_{APm_q} = V_{Dm_q} - V_{Pm_p} - V_{APm_q}$$

$$\text{OC}_{APf_q} = V_{Df_q} - V_{Pf_p} - V_{APf_q}$$

Condition: If  $(\text{OC}_{APm_q} + \text{OC}_{APf_q}) < 0$ , then  $(\text{OC}_{APm_q} + \text{OC}_{APf_q}) = 0$ .

Functions in these equations vary non-linearly with elements of forage quality: cell-wall content, digestible energy, and forage digestibility (see appendix for functions used in the model).

## Results of the model

Results of this modelling suggest that low-quality forage is best left in the field for pastoral livestock, or cut and traded for manure and labour. Feeding low quality forage to improved milch stock when either forage or capital (to purchase very expensive feed) is available for feed purchase, is to accept opportunity costs of forgone milk production (Figures 3a and b). Conversely, to feed high quality forage to small ruminants owned by pastoralists is to forgo milk profits likely to be obtained from utilising an on-farm source of nutrition. Thus, optimal use of on-farm crop residues is a question of identifying the production value of a residue given its quality and that quality's impact on intake and milk production.

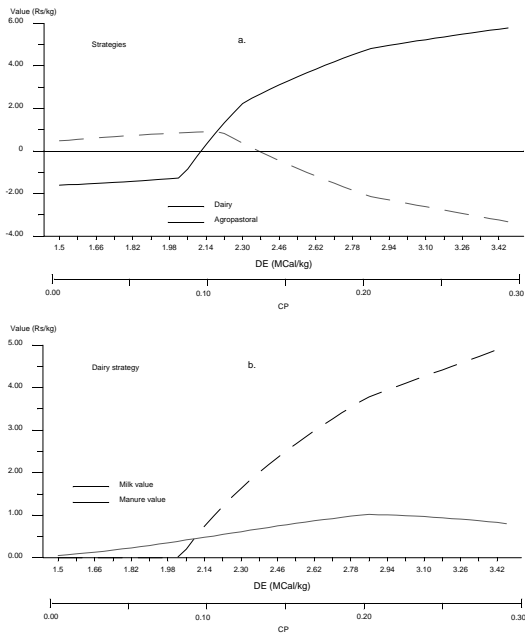
**Figure 3.** Modelled economic returns for farmer strategies of crop residue use in Sarapdad, Rajkot District, Gujarat.<sup>1</sup>

1. Graphs show values of strategies (including opportunity costs), expressed in Indian rupees (Rs) per kg feed, calculated along a gradient of feed of digestible energy (DE) and crude protein (CP). This gradient was produced by simultaneously increasing DE and CP and calculating returns for those sets of values (NB). Although increases in both DE and CP are recognised as increases in forage quality, there are no theoretical reasons why they should be positively correlated among feeds). Farmers have the option (shown in Figure 3a) to either feed on-farm residue to their own milk cows, or to trade the residue to small ruminant pastoralists for manure and purchase good quality residues (groundnut hay) for their milk cows. The relationships between components for the on-farm fed dairy strategy and agropastoral strategy (Figure 3b) suggest reasons why the strategies show different returns at opposite ends of the forage quality gradient.

In addition to quantifiable benefits and opportunity costs (covered in the models presented), there are several latent benefits and costs associated with pastoral participation in the agricultural system. Firstly, the 1–2 cm pellets that constitute small ruminant manure are particularly well suited to rapid decomposition and integration into the soil. Like all ruminant manure, it is composed primarily of organic matter that, when reintroduced to the soil, improves soil physical qualities and augments the microbial populations that drive nutrient cycling. Chemical fertiliser inputs make little or no positive impact to long-term components of the agro-ecosystem. However, interviewed farmers noted that because goats and sheep are also grazed on common property vegetation, applications of small ruminant manure increases the frequency of weeds and labour costs for weeding. In addition, agropastoralism facilitates other exchanges, especially long-term relationships concerning labour exchanges, that are difficult to quantify.

## **Conclusions**

### **System stability**

The models presented in this paper suggest that pastoral loss of land and forage, the growth of on-farm dairy production, and the expansion of irrigated farming in Saurashtra have contributed to the formation of agropastoralism. To adjust to these changes in the socio-economic and biotic–edaphic environments, Bharavad pastoralists have de-emphasised more "nutrient-demanding" livestock products and focused on marketing manure, a strategy of coexistence with the crop production objectives of neighbouring farmers.

Stability is a key feature of pastoral and farmer strategies in this system. Pastoralists have been historically and economically constrained to a feeding strategy based on crop residues. These feeds are non-exportable outputs because of their low economic value and bulkiness which makes it difficult to market them outside the system. Farmers see trading of residues for manure as a viable option among alternatives for soil fertilisation. When they choose this option, farmers obtain affordable inputs in manure that are non-exportable outputs of pastoral production. Thus, both parties are drawn to an integrated system whose internal efficiency may be high, since these non-exportable outputs are recycled, but at a cost to total productivity. Remnant degraded common grazing land is unlikely to improve under these circumstances unless there is a revolutionary change in perceptions of their value by the community, and the emergence of institutional means to control and protect them (such as has occurred in several cases of common property management directed at improving water harvesting).

The observation that farmers and pastoralists can be drawn to this system is not a surprising conclusion: farmer–pastoral relationships of this nature have persisted for centuries, especially in the western Sahel (Le Houérou, 1989). However, it is perhaps surprising to observe stability of agropastoral relationships in a modern context, where agricultural intensity is increasing. Modern agriculture has often fractured traditional interdependencies among farmer, labourer and pastoralist. For example, machinery and fertiliser have displaced the need for both farm labour and animal traction, especially during the planting season. In addition, crop residue feeds can become locally scarce in Gujarat when farmers are drawn to planting portions of their farms to certain cash crops (e.g. tobacco) that have little or no fodder value (Phansalkar and Pandey, 1991).

### **Small ruminant productivity**

Scientists and managers who have criticised the overall productivity of this system are basically correct; small ruminant productivity is depressed, and the condition of common grazing land remains exceptionally poor. Although authors have stated that, because of depressed productivity, such farmer–pastoral relationships can be overemphasised, we wonder "how?". Do most pastoral systems offer a better future, or a even a certain future? This paper suggests that they do not.

Although an idealisation of transhumant pastoralism captures the essence of an environmentally sustainable production system, few contemporary pastoral systems are either biologically,

economically or politically sustainable. In fact, pastoralists in grazing ecosystems throughout the world will continue to lose control of feed resources and land because of several interrelated problems: (1) a lack of political power in the face of encroaching dryland and irrigated agriculture (Goldschmidt, 1981; Salzman, 1986; Perrier 1990; Köhler-Rollefson, 1992a; 1992b); (2) an inability to develop and support powerful institutions that effectively manage the utilisation of communal grazing land; (3) an inability to control population-related positive feedbacks, i.e. growth of human population size, demand for livestock products, and the growth of livestock numbers; (4) sale of grazing land to speculators and non-agricultural users (Galaty, 1992); (5) conflicts with other legitimate uses of common property resources (Libecap, 1981) that are supported by powerful urban and environmental interests, such as watershed, recreation, and restoration of previous ecosystem components (biodiversity). At the root of each of these problems are powerful destabilising forces of a political and social nature about which natural scientists understand very little.

In closing, we suggest that the conversion of rangeland pastoralism to agropastoralism is the scenario of the present and the future in a world of exponential population growth, and expanding agricultural technology. We submit that there remains some expectation among scientists who work in grazing ecosystems that pastoral production systems can retain, or once again achieve, some of the characteristics that once permitted them to be environmentally sustainable. Optimistic development specialists believe that pastoral production systems can be converted into sustainable, regionally productive commercial enterprises. Probably neither is true. We submit that the fate of many pastoral peoples will most likely be similar to that of Bharavads in Saurashtra: their pastoral livelihood will be sustained through servicing agricultural systems as agents for rapid nutrient cycling and nutrient transport.

## References

- Ahuja K and Rathore M.S. 1987. *Goats and goatkeepers*. Printwell Publishers, Jaipur, India.
- Bharara L.P. 1987. *Preliminary report on socio-economic survey of the Banni Area, Kutch District (Gujarat)*. Central Arid Zone Research Institute, Jodhpur, India.
- Bharara L.P. 1993. Socio-economic aspects of Banni pastoralists and factors effecting changes in their perceptions toward the future. In: Cincotta R P and Pangare G (eds), *Pastoralism and pastoral migration in Gujarat*. Proceedings of the Workshop on Transhumant Pastoralism in Gujarat. IRM (Institute of Rural Management), Anand, Gujarat, India.
- Chen M A. 1991. *Coping with seasonality and drought*. Sage, New Delhi, India.
- Cincotta R P and Pangare G. 1992. Turning the nutrient cycle. *Information Centre for Low External Input Sustainable Agriculture Newsletter* 8(3):15–16.
- Cincotta R P and Pangare G. 1993a. Evidence of transhumance in "sedentary" Bharwad small ruminant pastoralists in Saurashtra. In: Cincotta R P and Pangare G (eds), *Pastoralism and pastoral migration in Gujarat*. Proceedings of the Workshop on Transhumant Pastoralism in Gujarat. IRM (Institute of Rural Management), Anand, Gujarat, India. pp. 39–43
- Cincotta R P and Pangare G. 1993b. Pastoralists: Brokers of agricultural soil fertility. *Wastelands News (India)* 8(3):40–44.
- Demment M W and Van Soest P J. 1985. A nutritional explanation for body-size patterns of ruminant and nonruminant herbivores. *American Naturalist* 125(5):641–672.
- Galaty J G. 1992. The land is yours: Social and economic factors in the privatization, sub-division and sale of Maasai ranches. *Nomadic Peoples* 30: 26–40.
- George S. 1985. Nomadic cattle breeders and dairy policy in India. *Nomadic Peoples* 19:1–19.
- Goldschmidt W. 1981. The failure of pastoralist economic development programs in Africa. In: *The future of pastoral peoples*. IDRC (International Development Research Centre), Ottawa, Canada. pp. 284–293.
- Jain P.S. 1989. *Voluntary organisations and public systems: A case study of cattle camps in Gujarat*. IRM (Institute of Rural Management), Anand, Gujarat, India.



- Kavoori P S (nd). *Pastoral transhumance in western Rajasthan: A report on the migratory system of sheep*. Norwegian Agency for Development, New Delhi, India.
- Köhler-Rollefson I. 1992a. The Raika camel pastoralists of western India. *Research and Exploration* 8(1):117–119.
- Köhler-Rollefson I. 1992b. The Raika dromedary breeders of Rajasthan: A pastoral system in crisis. *Nomadic Peoples* 30:74–83.
- Le Houérou H N. 1989. *The grazing land ecosystems of the African Sahel*. Springer-Verlag, Berlin, Germany.
- Libecap G D. 1981. *Locking up the range*. Ballinger, Cambridge, Massachusetts, USA.
- Mittal J P. 1993. The changing pattern of livestock farming in arid environments. In: Cincotta R P and Pangare G (eds), *Pastoralism and pastoral migration in Gujarat*. Proceedings of the Workshop on Transhumant Pastoralism in Gujarat. IRM (Institute of Rural Management), Anand, India.
- NRC (National Research Council). 1978. *Nutrient requirements of dairy cattle*. Fifth revised edition. Nutrient Requirements of Domestic Animals Series 3. National Academy of Sciences, Washington, DC, USA.
- Perrier G K. 1990. *The contextual nature of range management*. ODI Pastoral Network Paper 30c. ODI (Overseas Development Institute), London, UK. 8 pp.
- Pfister J A, Malechek J C and Balph D F. 1988. Foraging behaviour of goats and sheep in the Caatinga of Brazil. *Journal of Applied Ecology* 25:379–388.
- Phansalker S J and Pandey V. 1991. *Current situation regarding availability of fodder in India*. IRM (Institute of Rural Management), Anand, Gujarat, India.
- Provenza F and Balph D F. 1990. Applicability of five diet-selection models to various foraging challenges ruminants encounter. In: Hughes R N (ed), *Behavioral mechanisms of food selection*. NATO ASU Series G: Ecological Science Vol. 20. Springer-Verlag, Berlin, Germany. pp. 423–459.
- Rangnekar D V. 1993. Traditional livestock production systems among pastoralists: their perceptions of the production system and attitude to change. In: Cincotta R P and Pangare G (eds), *Pastoralism and pastoral migration in Gujarat*. Proceedings of the Workshop on Transhumant Pastoralism in Gujarat. IRM (Institute of Rural Management), Anand, India.
- Rhoades D F. 1979. Evolution of plant chemical defense against herbivores. In: Rosenthal G A, Janzen D H (eds), *Herbivores: Their interaction with secondary plant metabolites*. Academic Press, New York, USA. pp. 454.
- Salzman P C. 1986. Shrinking pasture for Rajasthani pastoralists. *Nomadic Peoples* 20:29–61.
- Salzman P C. 1988. From nomads to dairymen: Two Gujarati cases. *Economic and Political Weekly* 31:1582–1586.
- Saxena S K. 1993. Present status of the Banni Grassland. In: Cincotta R P and Pangare G (eds), *Pastoralism and pastoral migration in Gujarat*. Proceedings of the Workshop on Transhumant Pastoralism in Gujarat. IRM (Institute of Rural Management), Anand, India.
- Seth A. 1990. *Voices from the village: The people's perspective on development*. Aga Khan Rural Support Program (India), Ahmedabad, India.
- Singh P, Tyagi R K and Shankar V. 1993. Forage supply and demand analysis for Saurashtra and Kachchh. In: Cincotta R P and Pangare G (eds), *Pastoralism and pastoral migration in Gujarat*. Proceedings of the Workshop on Transhumant Pastoralism in Gujarat. IRM (Institute of Rural Management), Anand, India.
- Times of India. 1992. Shepherds attack police. *Times of India*, 19 July 1992. p. 5.
- Van Soest P J. 1982. *Nutritional ecology of the ruminant*. O & B Books, Corvallis, Oregon, USA. 374 pp.

## Appendix

### Nutritional variables

#### Independent variables

DE<sub>q</sub>: digestible energy of forage (kcal/g)

CP<sub>q</sub>: crude-protein content of forage

NB. Because it was assumed that forage quality includes both digestible energy and crude protein, the forage quality gradient is created in the algorithm by increasing CP as DE is increased (see Figure 3).

#### Associated variables

N<sub>q</sub>: nitrogen content of faeces =  $0.5 (CP_q / 6.25)$

NB. We assume that the faecal nitrogen content is one-half that observed in crude protein. This accounts for both indigestible N in the crude protein, and the addition of endogenous sources of N in the faeces.

CW<sub>q</sub>: cell wall  
=  $(DE_q - 4.33) / -0.0266) 0.01$

NB. Empirical relationship derived from regression of 10 crop residues and fodder crops (wheat straw, pearl millet straw, lucerne, corn stover, tops, cottonseed meal, cotton leaves, corn stalks, corn tops, groundnut hay; values from NRC, 1978).

DIG<sub>q</sub>: digestibility  
=  $(1.0 - CW_q) + (0.5 CW_q)$

NB. Relationship approximated; assumes that digestibility is equal to the mass of the cell contents plus one-half the cell wall, expressed as a fraction of the total forage mass.

### Parameters

BF<sub>ANIM</sub>: butterfat content for dairy cow  
= 0.045

UL<sub>ANIM</sub>: upper limit of intake (kg)  
=  $0.065 \times \text{body weight} = 0.065 \times 400 = 26.0 \text{ kg}$

v<sub>B</sub>: value of butterfat (Rupees/kg)  
=  $\text{Rs. } 3.0 / 0.045 \text{ kg} = \text{Rs } 66.667/\text{kg}$

v<sub>N</sub>: value of nitrogen (Rupees/kg)  
=  $\text{Rs } 0.625 / 0.035 \text{ kg} = \text{Rs } 17.857/\text{kg}$

DE<sub>MAINT</sub>: digestible energy required for maintenance for 400 kg dairy cow  
= 13.0 MCal per day

DE<sub>MILK</sub>: digestible energy required per litre (or roughly, per kg) milk for 400 kg dairy cow  
= 1.52 MCal per litre (or kcal/g)

## Functions

MY: milk yield (kg)

$$= (DE_{AVAIL}(DE_q, I(CW_q, UL_{ANIM})) - (DIG_{LOSS} DE_{AVAIL}(DE_q, I(CW_q, UL_{ANIM}))) - DE_{MAINT}) / DE_{MILK}$$

DIG<sub>LOSS</sub> : decrease in digestibility of material as intake increases over maintenance energy requirements (-4% per multiple of maintenance requirement; cf. Van Soest, 1982).

$$= (((DE_{AVAIL}(DE_q, I(CW_q, UL_{ANIM})) / DE_{MAINT}) - 1.0) 0.04$$

DE<sub>AVAIL</sub> : digestible energy available in forage consumed (MCal)

$$= DE_q I(CW_q, UL_{ANIM})$$

I: intake (kg)

$$= ((-0.945 CW_q) + 1.0624) UL_{ANIM};$$

NB. Relationship from regression of cell wall on intake (reviewed in Van Soest, 1982:285)

FY: manure yield (kg)

$$= I(CW_q, UL_{ANIM}) ((1.0 - DIG_q) + DIG_{LOSS})$$

# **The sustainability of rangeland to cropland nutrient transfer in semi-arid West Africa: Ecological and social dimensions neglected in the debate**

*M. Turner*

International Livestock Centre for Africa (ILCA)/ICRISAT Sahelian Center, BP 12404, Niamey, Niger

## **Abstract**

The integration of crops and livestock has often been cited as a model for agricultural development in semi-arid West Africa. Recent formulations treat the adoption of more intensive forms of manuring as a critical step in agricultural development. These analyses have been criticised for ignoring or underestimating the possible negative consequences of such management on rangeland and livestock productivity. This paper critically examines this debate. It is argued that the agronomic benefits of manuring depend largely on nutrient transfers from non-cropped grazing lands. In this respect, the ecological critiques are correct in arguing that, except in sparsely cultivated areas, the livestock required to support continuous cropping cannot be maintained by local pastures without external inputs. Over the long-term, such nutrient transfers cannot be sustained; nutrient outflows from pastures will exceed inflows resulting in a combination of reductions in livestock productivity, manure quality, pasture productivity and local livestock presence. However, these analyses have ignored the large influence of village-level agronomic and livestock management on the parameters used in such calculations. Once the temporal and spatial aspects of rangeland-cropland nutrient transfer are considered, it is shown that the dynamic sustainability of the process is determined, not simply by rangeland/cropland ratios and livestock stocking rates, but by differences in grazing and manure management at the village and household levels. Village-based livestock management is an area of active concern and experimentation by crop-livestock producers in semi-arid West Africa. More efficient nutrient management can be promoted through a combination of policy and extension efforts.

## **Viabilité du transfert des éléments nutritifs des pâturages aux terres agricoles dans la zone semi-aride de l'Afrique de l'Ouest: aspects écologiques et sociaux négligés dans le débat**

*M. Turner*

Centre international pour l'élevage en Afrique (CIPEA)/Centre sahélien de l'ICRISAT  
B.P. 12404, Niamey (Niger)

## **Résumé**

*L'intégration de l'agriculture et de l'élevage est souvent citée comme modèle de développement agricole dans les régions semi-arides de l'Afrique de l'Ouest. Depuis peu, l'intensification du mode de fumure est considérée comme une étape essentielle de ce processus. On a reproché aux tenants de cette théorie d'ignorer ou de sous-estimer les possibles conséquences fâcheuses d'un tel mode de gestion des pâturages et de l'élevage. Cet article procède à un examen critique du débat en cours. D'aucuns affirment que les avantages agronomiques de la fumure dépendent essentiellement du transfert d'éléments nutritifs des terres de parcours non cultivées. A cet égard, les écologistes ont raison de rétorquer qu'à l'exception des régions peu cultivées, les parcours ne peuvent supporter le cheptel nécessaire pour assurer des cultures continues sans intrants externes. A long terme, ces transferts d'éléments nutritifs ne peuvent être viables. Les pertes d'éléments nutritifs des pâturages excéderont les apports, entraînant simultanément une baisse de la productivité du bétail, de la qualité*

*du fumier, de la productivité des pâturages et de l'effectif du cheptel local. Malheureusement, ces analyses ignorent l'influence du mode de gestion des cultures et du cheptel au niveau des villages sur les paramètres employés dans les calculs. L'examen, dans l'espace et dans le temps, des caractéristiques du transfert des éléments nutritifs des pâturages aux terres cultivées montre que la viabilité dynamique du processus dépend, non pas seulement des rapports entre terres de parcours et terres cultivées et de la charge, mais également des différences des modes de gestion de parcours et du fumier à l'échelle du village et des ménages. La gestion des animaux au niveau du village suscite beaucoup d'intérêt et fait l'objet de nombreux essais au niveau des populations agropastorales des régions semi-arides de l'Afrique de l'Ouest. On peut promouvoir une meilleure gestion des éléments nutritifs en associant des mesures appropriées à des efforts bien orientés des politiques de vulgarisation.*

## Introduction

Despite low mean annual rainfall (400–1000 mm), agronomic and ecological research has found that nitrogen (N) and phosphorus (P) availabilities in the soil, more often than water, limit range and crop production for most of the southern Sahel and Sudanian zones of West Africa (Penning de Vries and Djitéye, 1982; Breman and de Wit, 1983). Moreover, there is growing concern about the declining fertility status of soils as a result of population growth and a concomitant decline in fallowing rates. Nutrient budgets calculated over a range of spatial scales for low-input agricultural systems in this zone are negative (Pieri, 1989; Stoorvogel and Smaling, 1990; van der Pol, 1992; Hafner et al, 1993). Some analysts argue that the resulting decline in soil fertility is a major factor behind the stagnation or decline in cropland productivity observed across the region (van Keulen and Breman, 1990).

These observations have helped to revive interest in the greater integration of crop and livestock production. The productive benefit of the mixed farming model most stressed in recent formulations is the use of livestock to provide manure/urine to agricultural fields in areas where the rate of fallowing no longer maintains fertility. This view has been criticised on the grounds that the productive benefits of manuring are overestimated and that the maintenance of cropland fertility through manuring alone will only occur to the detriment of rangeland and livestock productivity (van Keulen and Breman, 1990). This paper analyses critical issues of this debate. In so doing, it will be argued that by abstracting from a number of ecological and socio-economic realities of semi-arid West Africa, the regionally emergent properties of socio-economic processes that influence local patterns of livestock ownership, agronomic management and livestock management have been obscured.

## Models for crop–livestock integration and their emphasis on manuring

Increased integration of the livestock and cropping sectors has long been viewed as the most promising means for initiating improvements in agricultural productivity in semi-arid West Africa (Landais and Lhoste, 1990). Animal husbandry is viewed as improving crop production through the provision of animal traction and manure, while deriving benefits from the cropping system through the latter's incorporation of fodder crops into the cropping cycle. Development efforts to promote such integration have found it necessary to do so within a context of pre-existing patterns of interaction between these two sectors. Compared to other parts of Africa, the livestock and cropping sectors in semi-arid West Africa have historically been much more integrated. The relationship between cropping and livestock management in the West African semi-arid zone has been typified by:

- a widespread interest in livestock ownership across all rural producers (Bernus, 1974; Gallais, 1975; Toulmin, 1983; Bonfiglioli, 1985; Starr, 1987; Turner, 1993)
- a certain degree of occupational specialisation between livestock managers and agriculturalists between households as well as within households (Gallais, 1975; Delgado, 1979; Toulmin, 1983)

- a fluidity over time in occupational categorisation resulting in part from changes in livestock ownership (Grayzel, 1977; Bonfiglioli, 1990)
- a high level of local and inter-regional exchange in grain, milk, meat, labour, animal power, fodder, and manure between households with different resource endowments and economic specialisations (Gallais, 1972; Bernus, 1974; Delgado, 1979; McCown et al, 1979).

In this context, development efforts in the past have largely focussed on encouraging the more widespread adoption of three component technologies most commonly associated with greater crop–livestock integration: manuring, animal traction, and fodder cropping. While the provision of these components could plausibly occur under a number of different management configurations, the most commonly promoted management model is mixed farming, which can be defined simply as the joint management of livestock and crop production at the level of the individual household (McIntire et al, 1992). Ownership externalities are seen as limiting the potential of providing some or all of these services at higher levels of social organisation (e.g. between households). Thus packaged, the adoption of these technologies required large changes in livestock management and the organisation of agricultural and herding labour.

Despite many years of the promotion of mixed farming in semi-arid West Africa (Landais and Lhoste, 1990), low adoption has revealed the limitations of greater crop–livestock integration generally, and mixed farming management more specifically, from the perspective of the rural producer. In particular, highly favourable comparisons of hypothetical mixed farming systems to existing agropastoral systems have overestimated the potential for such integration by overestimating the benefits/incentives of such integration; underestimating the economic costs associated with such integration; and underestimating the degree of livestock–crop integration possible between households (see Table 1).

**Table 1.** *Reasons for the limited adoption by West African farmers of management innovations to intensify agricultural production through greater crop–livestock integration (A) or mixed farming (B) in particular.*

Labour, not land, has been the most important limiting factor in cropland production in semi-arid West Africa (Lewis, 1979; Berry, 1984);	A
The often-underestimated importance of customary non-market exchanges of labour, manure, traction and fodder among and between cropland and livestock managers (Gallais, 1972; Bernus, 1974; Delgado, 1979; McCown et al, 1979);	B
High natural correlation between dry-season livestock distribution and cultivated areas due to their close association with permanent water sources (Sandford, 1983). Thus even without explicit exchange or ownership mechanisms in place, cropland grazing and manuring occur;	A
The circumscribed edaphic and climatic conditions under which each of the three technical components of crop–livestock integration significantly increases cropland production without external inputs (de Ridder and van Keulen, 1990; McIntire et al, 1992);	A
The implicit assumption of access to external inputs (fertilisers, feed supplements, improved seeds) or more productive soils when calculating the productivity of integrated crop–livestock systems from on-station trials (Rabot, 1990);	A
The costs to animal and range productivity associated with the reduction in livestock mobility required by the mixed farming model (Calvet et al, 1965; Breman and de Wit 1983; Bassett 1986; Turner 1992; Swallow, 1994);	B
The degree of specialised knowledge and wider network of social contacts required for successful animal husbandry in semi-arid West Africa (Bonfiglioli, 1982; Niamir, 1990; McCorkle and Mathias-Mundy, 1992);	B
A large fraction of household income is derived from outside the agricultural sector entirely (Reardon et al, 1988; Delgado, 1989). Non-agricultural activities may compete successfully with the increased labour requirements necessary for the intensification of the farming system (Berry, 1984).	A

Despite limited success in the past, there has been a resurgence of interest among agronomists and economists in the mixed farming model in recent years. As mentioned above, the accumulation of a critical mass of research results demonstrating the importance of nutrients in limiting crop production and the prevalence of negative crop nutrient budgets has spurred this interest. More importantly, proponents of mixed farming argue that rural conditions are now changing in such a way to make adoption more likely. The major change cited has been an increase in population densities in many parts of the Sudanian zone, which has led to a reduction in fallows. Continued population growth in these areas will lead to an intensification of agricultural land use (Pingali et al, 1986; Sandford, 1990; McIntire et al, 1992; Winrock International, 1992). The underlying theoretical basis for these arguments is E. Boserup's model that predicts that increases in rural population density will necessarily lead to greater labour inputs per unit of cropland (Boserup, 1965). In other words, increased population density will lower the availability of land relative to labour, spurring an increase in the investment of labour to improve or better maintain the land's productivity.<sup>1</sup>

While Boserup's model does not prescribe the manner in which land-use intensity will increase at higher population densities, many see agricultural intensification in semi-arid systems as first occurring through the integration of livestock and cropping systems at the level of the household. Implicit to such models is the view that among the various factors found to limit the adoption of mixed farming in the past (Table 1), population density dominates. Once population densities are sufficiently high, other remaining barriers to adoption are assumed to be small. Alternative intensification trajectories with labour organised at higher levels of social organisation and/or using different technologies are often not considered. This void is all the more surprising given the continued importance of labour scarcity in highly populated zones (Delgado, 1989). As a result of the influence of these views, agricultural intensification in semi-arid West Africa, crop-livestock integration, and mixed farming are often mistakenly treated as synonymous in the development literature.

As a result of the new emphasis on fertility management and agricultural intensification as justifications for mixed farming as a development strategy, recent formulations have emphasised the agronomic benefits of manuring compared to the past, when animal traction was viewed as the major benefit that would drive adoption (Lhoste, 1987: 109; Matlon, 1988; McIntire et al, 1992; Winrock International, 1992). Population pressure is now seen to initially stimulate the incentives for increased self-management of livestock in order for agricultural households to more fully reap the manure benefits of livestock ownership (McIntire et al, 1992: 35). The adoption of the plow is seen to be more likely under situations of continuous cultivation and dependence on livestock manure for fertiliser (Pingali et al, 1986: 41). In fact, manuring is now viewed by many as the critical technological component driving agricultural intensification at its initial stages.

Over the past two decades of recurrent drought, one has witnessed, as a result of shifts in herd ownership and rural subsistence strategies, a growing fraction of livestock being owned by sedentary agriculturalists (Toulmin, 1983; White, 1984; Bonfiglioli, 1985; Grayzel, 1990; Turner, 1993). As a result of the movements of human and livestock populations, many areas within the Sudanian zone have experienced rapid population growth, a corresponding expansion of cultivated area and decline in fallowing rates; and the rapid accumulation of livestock (van Keulen and Breman, 1990; Landais and Lhoste, 1993). The concurrence of these trends has been used by some observers as evidence for

1. Boserup's model is important in that it has provided a necessary countervailing conceptual framework to Malthusian prescriptions of the consequences of population growth on land-use and resource management. Moreover, it integrates well with studies demonstrating active experimentation and innovation by rural producers in Africa (Richards, 1985). However, to say that increased population density leads to greater cultivation intensity is redundant and self-evident. Once all arable land is cleared, a greater number of people supported by the same amount of land will necessarily have to be utilising the land more intensively. In this way, inter-regional cross-sectional studies that show rural agricultural population densities to be positively correlated with land-use intensity are uninteresting (McIntire et al, 1992: 33-35). In fact the findings of such studies are also consistent with Malthusian models. What is of real interest is how such population equilibriums come about. Will rural population growth lead to agricultural intensification, migration to uncultivated frontiers, seasonal/permanent migration to cities, or ecological deterioration and increased death rates? To use population growth as the sole factor for predicting changes in land-use intensity over a wide range of population densities and historical circumstances is questionable.

smallholders choosing to intensify their agriculture in response to increased population pressure, through tighter integration of farming and livestock husbandry (Ramaswamy and Sanders, 1992; Landais and Lhoste, 1993). While this shift has made livestock–cropland integration more possible, to infer that the accumulation of livestock by sedentary agriculturalists results from their desire to “integrate” these two production systems is not warranted without more detailed research. Such research would have to demonstrate that livestock are increasingly being purchased more for their traction power and manure than for their historic role in the region as a growing source of capital that can be tapped for a range of expenses (Gallais, 1972; Pelissier, 1977; Reardon et al, 1988; Swinton, 1988; Turner, 1993).

The increase in livestock managed by sedentary agricultural populations in the West African semi-arid zone, whatever the cause, has been viewed as a positive trend by proponents of crop–livestock integration since it provides the basis for greater agronomic use of manure, a critical step in sustainable agricultural intensification. Others view the same trend with a great deal more trepidation. They argue that in most situations, the negative consequences of the stocking rates required to support continuous cultivation will not allow the agronomic benefits of manuring to be maintained over time (van Keulen and Breman, 1990).

### **Agronomic benefits of manuring: Reliance on rangeland to cropland nutrient transfer**

To evaluate, even qualitatively, the sustainability of manure-supported continuous cropping requires an understanding of how the agronomic benefits of manuring relate to the nutrient cycle of the whole farming system. A number of agronomic benefits of manure and urine application on semi-arid soils have been cited in the agronomy and soils literature. Table 2 lists a few prominent examples. From a nutrient budgeting perspective, these improve the nutrient status of crops by either accelerating the nutrient cycle, increasing the efficiency of the nutrient cycle or importing nutrients to the particular cropped area from elsewhere. A fair amount of confusion exists about the nutrient budgetary costs and benefits of manure/urine application in the farming systems literature. Benefits of manure/urine application, as commonly stated, need to be disaggregated into one or more of these three mechanisms to understand how they can affect the nutrient budget of the whole farming system. For example, manure/urine application is often described as leading to increased soil organic matter (SOM) and increased nutrient availability. The contribution to SOM of a given amount of manure cannot exceed that contributed by the equivalent amount of crop residue fed to animals producing the manure. Therefore, soil organic matter improvement to cropped areas by manuring can only occur through imports from grazed areas outside of cropped areas. On the other hand, the pool of nutrients available to crop growth results from a combination of an absolute increase in nutrient stocks caused by nutrient imports and by an acceleration of the nutrient cycle brought about by increasing nutrient availability.

Such disaggregations are helpful in making sense of the claims and counter-claims made by manuring proponents and their ecological critics. To what extent do the agronomic benefits of manuring rely on nutrient transfers from rangelands? Detailed quantitative analyses are not required for one to conclude that the benefits of manuring rely heavily on nutrient transfers from rangeland. As suggested by Table 2, a large proportion of the agronomic benefits of manuring rely directly on nutrient transfers from rangeland. The agronomic benefits derived from the acceleration and increased efficiency of nutrient cycling do not rely on transfers from rangeland. However, those benefits that increase crop production by accelerating the nutrient cycle, only do so at a cost, since by increasing nutrient availability, they also increase the potential for loss from the farming system through leaching and volatilisation (de Ridder and van Keulen, 1990). Therefore, such modes cannot be viewed as sustainable in the long-term — spinning the wheel faster is not sufficient for maintaining crop production levels. This along with a consideration of nutrient harvest indexes typical of millet-based systems in semi-arid West Africa (Powell and Fussell (1993) estimate 45% N and 51% P), reveals that fertility maintenance of croplands through manuring in semi-arid West Africa can only be achieved through nutrient exports from non-cropped rangelands.



**Table 2.** *Agronomic benefits of manure/urine application to cropland and their underlying nutrient budgetary mechanisms.*

Agronomic benefit of manure/urine application	Mechanism
An increase in the availability of crop residue-bound nutrients (Ruess and McNaughton, 1987)	Acceleration
A rise in soil pH, which for many acid soils, increases the availability of phosphorus and nitrogen (Pieri, 1989; Powell and Ikpe, 1992)	Acceleration
Nutrient mineralisation more synchronous with the crop nutrient demand (Swift et al, 1989; Somda et al, this volume)	Efficiency
Increased soil organic matter thereby increasing CEC and reducing nutrient losses (Jones, 1973; Pieri, 1989)	Transfer
Increased soil organic matter improving soil structure and thus water-holding capacity, aeration, and infiltration (Charreau and Nicou, 1971; Landais and Lhoste, 1993)	Transfer
Increased soil organic matter which promotes the activity of free-living N <sub>2</sub> -fixing bacteria (Hafner et al, 1993)	Transfer
Increased soil nutrient pools (Quilfen and Milleville, 1981; Pieri 1986; Powell and Mohamed-Saleem 1987; Powell and Ikpe, 1992)	Transfer

## The sustainability of nutrient harvesting from rangeland

Sustainability can be evaluated using a range of different criteria (Lélé, 1993). For the purposes of this discussion, sustainability will be defined narrowly as the joint maintenance of cropland and rangeland productivity to support grain and livestock production. Any working definition of sustainability requires some sense of the maximum temporal and minimum spatial dimensions (Fresco and Kroonenberg, 1992). In this case, relevant spatial boundaries are determined by the maximal grazing radius of the livestock providing manure to the cropland (around 7 km).<sup>2</sup>

From a practical standpoint, the temporal scale can be set as the maximum planning horizon for government policy makers and rural producers (around 25 years). Over such temporal and spatial dimensions, livestock and agricultural production cannot necessarily be viewed as activities that do not compete for land at lower population densities (<100 persons/km<sup>2</sup>), as has been suggested by some mixed farming advocates (McIntire et al, 1992: 41–44).<sup>3</sup> Nor can rangeland and cropland productivity be viewed as evolving independently of each other. A decline in the productivity of a rangeland, reflected in a combination of lower manure quality, livestock productivity, and local livestock presence, will result in a decline in the productivity of the cropland supported by its nutrient exports.

While there are many locations in semi-arid West Africa, especially to the north, where livestock-mediated transfer can be viewed as being limited by the availability of animals as transfer agents (Williams et al, this volume), a necessary step for any analysis of the sustainability of manure-supported continuous cropping is to relate the rangeland requirements necessary to sustainably support these transfers with the rangeland available. To this end, a number of analyses have estimated

2. This results from the simple fact that for animals to provide manure/urine to fields, they must spend time either on the field or in nearby paddocks. Daily grazing radii of livestock are generally less than 7 km. Carting manure over longer distances is rare.

3. Such conclusions are generally based on the following argument (McIntire et al, 1992: 42). The extension of cropland primarily limits fodder availability during the rainy season. Livestock production, however, is limited by dry season fodder supply. Therefore the extension of cultivated area does not significantly lower livestock productivity. Such arguments have misinterpreted the results of ecological research. It is true that livestock productivity is most limited during the dry season. However, it is generally limited by fodder quality (nutrient content and digestibility) not quantity. In this respect, replacing natural range with millet, with 30–40% of its nutrient yield harvested for human consumption, can only reduce dry-season forage availability. Moreover, research has shown that Sahelian rangeland productivity is most negatively affected by grazing during the rainy season (Breman and Cissé, 1975; Grouzis, 1988; Hiernaux and Turner, 1993), so that, restriction of grazing during the rainy season by cropping, even if it did not restrict livestock productivity in the short term, may very well lower it over the long term.

minimum rangeland–cropland ratios (RCR) that would be necessary for such systems (Quilfen and Milleville, 1981; Breman et al, 1986; Swift et al, 1989; van Keulen and Breman, 1990). To avoid the spatial and temporal complexities of local-level crop residue, manure and livestock management systems, these calculations are performed on a regional basis — comparing the computed ratio with aggregate land-use statistics. The series of calculations used to derive these ratios are of the same general form. The annual nutrient deficit of cropland (kg/ha per year) is multiplied by the ratio of the rangeland's carrying capacity (ha/TLU per year) divided by annual nutrient excretion by livestock on cropped areas (kg/TLU per year).

In practice, these calculations are more complex, incorporating many more than three factors. A more realistic, but still limited, set of calculations to estimate the rangeland–cropland ratio necessary to maintain the N and P status of a continuously-cropped millet monoculture are presented below.<sup>4</sup> These equations are not presented as a pretext to present another set of estimations but to more clearly demonstrate the ramifications of their underlying assumptions. Equation 1 is the calculation used to estimate the nutrients required from manure/urine to maintain soil fertility:

$$IN_{mu} = \frac{NR}{UE} - (IN_p + IN_f + IN_h) \quad (1)$$

where:

- NR = nutrient requirements to replenish losses resulting from biomass removals due to harvesting, weeding, and grazing kg/ha per year (N and P)
- UE = annual fraction of mobilised nutrients which are available to crops after losses due to leaching, volatilisation, weed uptake and erosion losses (N and P)
- IN<sub>p</sub> = nutrient inputs through rainfall, kg/ha per year (N and P)
- IN<sub>f</sub> = mean mineralisation rate of nutrients fixed from atmosphere, kg/ha per year (N)
- IN<sub>h</sub> = mineralisation from soil nutrient pools with mean residence times >25 years, kg/ha per year (N and P)
- IN<sub>mu</sub> = required mean mineralisation rate of nutrients supplied by manure and urine, kg/ha per year (N and P)

From this estimate of the nutrients required to be supplied by manure/urine to replenish losses from the cropping system (IN<sub>mu</sub>), the rangeland–cropland ratio (RCR) is estimated for each limiting nutrient (N, P) with the following equation:

$$RCR = \frac{RCF \times CC \times IN_{mu}}{(MP \times MC) \times [(DF_m \times NP) + (DF_u \times NF)]} \quad (2)$$

where:

- RCR = rangeland–cropland ratio necessary to support manure-supported continuous cropping
- RCF = fraction of total nutrients ingested by livestock that are provided by local rangelands
- CC = carrying capacity of grazed rangeland (ha/TLU per year)
- MP = kg of manure produced/TLU per year
- MC = nutrient content of manure, kg/kg (N and P)
- NP = mean annual nutrient mineralisation rate per kg of manure-supplied resulting from a chosen manuring regime, kg/kg per year (N and P)
- NF = ratio of nutrients voided in urine compared with those voided as manure (N)

4. Nutrient requirements of the cropping system derived from manure/urine are estimated by balancing the flow of plant-utilisable mineralised nutrients with nutrient losses from the cropping system through the removal of plant material. Nutrient flows resulting from the mineralisation of nutrient pools having residence times significantly greater than the chosen sustainability time-scale (25 years) are treated as external inflows. Simplifying assumptions include: nutrient inflows and outflows through the movement of dust are assumed to be equal; the uptake efficiency (UE) is assumed to be the same for all mineralised nutrient flows despite differences in their release with respect to the root zone; no significant differences between livestock species with respect to nutrient excretion per kg of live weight (MP × MC), urine/manure fractionation (NF), or deposition fractions (DF<sub>m</sub> and DF<sub>u</sub>).

$DF_m$  = fraction of manure voided that is deposited or transported to fields (N and P)

$DF_u$  = fraction of urine voided that is deposited on fields (N).

The maximum of the two ratios calculated separately for N and P would then be used as the final estimate of the amount of rangeland required to maintain the fertility of the manured cropland.

Estimates of rangeland/cropland ratios using this general computational structure, typically range from 15–45 ha of rangeland needed to support the livestock required to manure one ha of cropland (Quilfen and Milleville, 1981; Breman et al. 1986; Swift et al. 1989; van Keulen and Breman, 1990). The wide range of these estimates reflects the significant uncertainties associated with the parameters. Estimations of RCR have typically but not ubiquitously ignored or excluded a number of the parameters of the above equations. Those parameters most commonly excluded are designated in the above equations in normal (not bold) typeface. Such omissions reflect different disciplinary perspectives, sustainability time scales, and assumed management systems. The effect of each of the most common omissions is to increase the estimated RCR.<sup>5</sup> Inclusion of these omissions into the computation of RCR for millet monoculture systems in semi-arid West Africa, would generally result in estimates falling within the lower end of the 15–45 ha/ha range (e.g. 10–30 ha/ha).

Even if reduced, these RCRs call into question the viability of mixed farming as a model for agricultural development in the West African semi-arid zone. They place a ceiling on manure-supported cropping fractions (4 to 9%) well below that of total cultivated fractions in many areas of the Sudanian zone (van Keulen and Breman, 1990). Therefore, there are strong biophysical limits to the intensification of agriculture through greater crop–livestock integration. Conversion of existing cropped areas to continuous cropping can never be supported solely by manuring (van Keulen and Breman, 1990). Based on these values, continuous cropping of cultivated fractions greater than 9% cannot be achieved without fertilisers and/or livestock feed supplements.

It should also be noted that the RCRs are most commonly estimated using livestock-based carrying capacities. That is, they are based on the nutritional requirements of livestock and not on long-term degradation processes. Therefore, the biophysical limits that are referred to here are production based, i.e. animal production will suffer in situations where grazing lands available per unit of manure-supported, continuously-cropped land fall below the appropriate RCR. Moreover, there is a limited possibility of allowing the productivity of animals to decline in order to gain greater nutrient transfers from non-cropped lands. As the nutritional status of animals decline, so will the quality and quantity of their excretions. Not surprisingly, longitudinal studies in heavily cropped zones have observed a decline in livestock presence with the extension of cultivated area, resulting from livestock wealth reductions or increased transhumance (Lhoste, 1987; Garin et al, 1990).

Estimated RCRs are somewhat surprising given that increased manuring is viewed as critical for the intensification of land use. Not only are there significant limits to the expansion of such cropping systems, but they often represent a more extensive use of arable lands than alternatives. The total land requirement of such a system is significantly higher than so-called "extensive" fallowing systems, which have a sustainable fallow/cropland ratio of 5 (Young and Wright, 1980). Under higher land pressures, farmers will collectively pursue a mixed strategy to maintain the fertility of a maximum amount of cropland, thereby maintaining the fertility of higher cultivated fractions than predicted from RCRs alone.

5. The omission of natural sources of nutrient input through rainfall, N-fixation, and mineralisation of long-term nutrient pools ( $IN_p, IN_r, IN_b = 0$ ) reflects the assumption that the fertility status of uncultivated lands is in equilibrium – nutrient inputs equal outputs. Therefore, any cropping-related export outputs must be balanced by new nutrient inputs. However, the fertility status of many uncultivated lands is not in equilibrium, as evidenced by the role of fallowing in restoring soil fertility. The exclusion of urine as a nitrogen source ( $DF_u = 0$ ), is based on assumptions concerning livestock management and urine volatilisation which are not valid for semi-arid West African farming systems (Powell and Ikpe, 1992). The assumption that all nutrients are derived from local rangelands ( $RCF = 1$ ) results from the combination of assuming that crop residues represent a very small portion of livestock diets; and choosing to perform the analysis at a regional scale where it is assumed that, despite seasonal transhumance, livestock are being supported by rangeland within the circumscribed area.

The relative importance of manuring in maintaining the fertility of cropland will vary with respect to the type of land available to a village. A simple model will illustrate this point. Assume that a village could regulate its animal population and fertility management in such a way as to maximise its sustainably-supported cropland. In addition, assume that manure-supported and fallow-supported cropland are separately managed (in-field, out-field pattern), and that livestock manuring cropland graze on both rangeland and fallows. Figures 1a and 1b show how both total cultivated area and the manure-supported fraction of cultivated area would vary with respect to the extent of non-arable lands within the daily grazing orbit of village herds at two different RCRs.<sup>6</sup> As would be expected, the fraction of cropland supported by manure increases non-linearly with the non-arable fraction. Manure-supported fractions are consistently higher at lower RCRs.<sup>7</sup>

A reduction in RCR increases the total cropped fraction, especially where village lands have high non-arable fractions. In this example, increasing RCR from 10 to 30 leads to an 18% and 45% reduction in sustainable cropped fraction at 0% and 80% non-arable fractions, respectively. Therefore, the appropriate fertility management strategies pursued by rural producers will vary with respect to their access to land resources under existing livestock ownership and management constraints.

## The importance of management

Calculated RCRs support arguments that the potential for continuous cropping without fertiliser is limited in semi-arid West Africa. Therefore they are useful in guiding long-term agricultural planning. At high population densities, the mixed farming model is not viable without external inputs. However, such calculations provide surprisingly little insight into the appropriate policies and technologies that will improve resource management to better maintain productivity. There are two major reasons for this. The first is the wide variation in the RCR estimates with little knowledge about the factors behind this variability. An RCR range of 10–45 may be useful in discussing the future of agriculture in semi-arid West Africa, but it does not provide any guidance for planners and policy makers working at national and subnational levels. The second is the high degree of spatial aggregation inherent to such calculations. This paper argues that these two deficiencies are both cause and effect of the limited amount of analysis of the socio-economic factors affecting local-level management practices. It is only from a synthesis of such knowledge that aggregation can validly be conducted and future trends predicted.

## High variation in RCR values

The wide variation in the estimated values for RCRs provide little guidance for policy makers and planners. This variation results less from a lack in basic knowledge of nutrient soil dynamics, nutrient uptake by crops, and range ecology, and more from a limited understanding of the landscape-level nutrient cycling ramifications of different management practices; the variation structure of these management practices (individual, household, village and region); and the social and biophysical factors that affect these practices. A review of equations 1 and 2 reveals that the values of many parameters are strongly affected by management practices. For example, the NR and UE parameters in equation 1 are influenced by agronomic practices such as the extent of weeding, interannual regimes

6. For cases where  $(1-NAF) > 1/RCR$ , cultivated surface fraction (CF) would be equal to:

$$\frac{NAF + (1-CF)}{RCR} + \frac{(1-CF-NAF)}{FR} = CF$$

(manure-supported) (fallow-supported) (total)

where NAF is the non-arable fraction of village lands, RCR is the assumed sustainable rangeland-to-cropland ratio and FR is the ratio of fallows to fallow-supported croplands. Once this equation is simplified CF is equal to:

$$\frac{FR + RCR(1-NAF)}{RCR(FR+1) + FR} = CF$$

except in cases where  $(1-NAF) \leq 1/RCR$ , then  $CF = 1/RCR$ .

7. These fractions are consistent with the findings of land-use surveys conducted at different villages in the semi-arid zone (Prudencio, 1987; Gavian, 1992). In systems where there is a more extensive incorporation of annual and perennial legumes into the cropping and fallow systems, higher cultivated fractions and manure-supported fractions can be maintained (Garin et al, 1990). One important limitation of this presentation however is that RCR will vary in an inverse fashion with respect to non-arable land fraction since carrying capacities (CC) are generally lower for non-arable lands.

**Figure 1.** The relationship between total cropped fraction and the non-arable fraction of village lands, where the former is maximised by varying the fraction of fields that are maintained by fallowing or manuring at an assumed sustainable rangeland-to-cropland ratio (RCR) of 10 (A) and 30 (B).

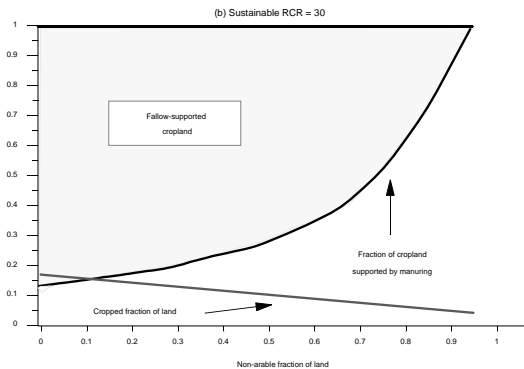
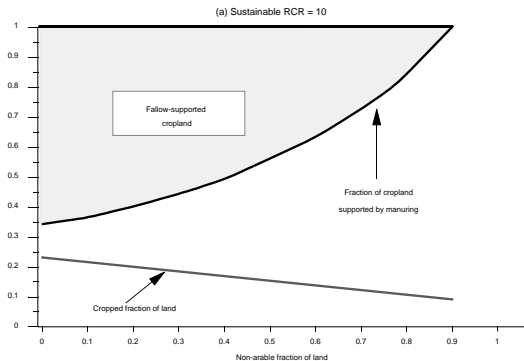

for manure/urine application, manure/urine and crop residue incorporation into the soil, crop residue removals and plowing. Virtually all of the parameters of equation 2 are affected by the livestock ownership and livestock management decisions of rural producers. Livestock species composition will directly affect manure production rates (MP), manure quality (MC) and carrying capacity (CC). Management decisions, such as those on crop residue grazing, transhumance and nocturnal location of livestock, will determine the dependence of livestock on local pastures (RCF) and the amount of manure/urine deposited or transported to fields ( $DF_m$  and  $DF_u$ ).

Even carrying capacities, which are often assumed to be based on biophysical criteria, are heavily dependent on management strategies. Carrying capacities are normally presented as annually-aggregated values. Implicit in such calculations is that livestock are sedentarily managed. In reality, livestock management in most Sahelian villages is very fluid. The seasonality of grazing experienced on local pastures can be significantly modified by decisions made by villagers on the sending their livestock or receiving outside livestock on transhumance. For CC estimations based on livestock nutritional requirements, the seasonality of grazing will have a significant effect on the forage utilisation coefficients that are possible (de Leeuw and Tothill, 1990; Breman and de Ridder, 1991: 390). For those based on range ecology, the productivity and composition of pastures have been found to most affected by persistent grazing during the rainy season (Turner, 1992: 331–398; Hiernaux and Turner, 1993). The distinction between a fully-sedentary and a highly mobile pastoral system might not be a very useful distinction either for describing present indigenous systems nor to design 'optimum' farming systems. Due to the seasonal variation of rangeland sensitivity and nutrient transfer efficiencies, the degree of damage to rangeland per unit of nutrient transferred to agricultural fields will vary significantly across the year.

The importance of the variation in livestock wealth, access to land-based resources, agronomic management, and livestock management in affecting the values of RCR cannot be queried. However, there has been relatively little analysis attempting to characterise the structure of this variation with respect to spatial and social units of analysis (individual, household, village and region), and quantify the nutrient transfer implications of this variation. All evidence points to large intra-village and intra-regional variation in access to land, livestock ownership, agronomic and livestock management (Sutter, 1987; Raynaut, 1988; Bonnet, 1990; Gavian, 1992). All too often, analyses have been performed using averaged data to depict agricultural management typical for the "farming system" in a region or bioclimatic zone. Averages are added, multiplied, and divided by averages. Such an approach not only has important mathematical problems, which could lead to large divergences from reality,<sup>8</sup> but it provides little insight into what policies and technologies could improve local resource management nor how such "systems" will change in the future. A more complete understanding of the variation structure of important management practices and the socio-economic and biophysical incentives and constraints affecting these practices would provide us a much better basis not only for aggregation but for predicting future changes in these "systems" and identifying arenas where outside policy or technology interventions may improve the situation (Blaikie, 1985).

## Spatial abstraction

Evaluations of the sustainability of manure-supported, continuous cropping through the calculation of RCRs, have been conducted at a regional level. There is nothing intrinsically wrong with this. However, the problem is that much of the analysis, discussion and debate about the sustainability of different fertility management strategies have remained at this high plane of abstraction. In so doing, there has been a tendency to ignore the fact that from a fertility management perspective, spatial scales closer to the level of the village are much more appropriate. This becomes all the more clear when one

8. Since many of the underlying relationships are non-linear, there is potentially a fair amount of error introduced by such a method. Moreover, there is likely to be a fair amount of autocorrelation among the underlying management and biophysical variables (Williams, 1994). As a result, the RCR as calculated from mean parameters can diverge significantly from the true mean RCR.

**Figure 2.** Results of GIS analyses of two land use maps at 1:100000 scale of the same 440 km<sup>2</sup> zone north-east of Maradi, Niger, in 1957 and 1976.<sup>1</sup>

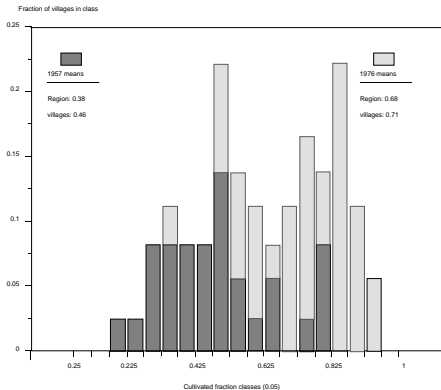

1. Cultivated areas presented in these maps most likely include recent fallows. The uncultivated-to-cultivated ratio for the whole 440 km<sup>2</sup> zone is compared to the range of values found for village perimeters of 3 km radius and for their overall mean in both years.

Source: de Miranda (1980: 50–51).

considers how to use a regional RCR to guide resource policy and village-based management innovations. As shown in Figure 2, the cultivated fraction for particular village lands diverge widely from the regional average. Villages are in quite different positions with respect to local land use. Moreover, given the higher density of cultivated area near villages, average RCRs for village lands will always be lower than the regional average.

A reliance on regional-scale analyses also ignores the primary importance of grazing and herd management in determining the sustainability of livestock-mediated nutrient transfers. All rangeland is assumed to be accessible to village-based livestock. The analysis above suggests that large areas of rangeland within a region are outside the daily grazing orbits of village-based livestock. Therefore, these areas cannot provide nutrients to cropland, they can only provide nutrition for village livestock that leave on short transhumance. Even within an area which could be considered within the grazing range of village-based livestock (7 km), differences in how these animals are managed will affect the effective grazing orbit. Significant differences in livestock productivity have been documented between herds managed by adult herders in the same area reflecting, in part, differences in daily herding practice (Koyate, 1987; Killanga et al, 1989; Turner, 1992: 225–278). Add to this variability the wide differences in grazing radius between free-ranging, children-herded, and adult-herded livestock, it becomes clear that the rangeland surrounding a village that is grazed by livestock is highly dependent on management.

To illustrate this point, consider a simple model of village land use where a circle of manure-supported continuously-cropped land immediately surrounding the village is surrounded by a ring of unmanured fields, fallows, and rangeland. For simplicity, assume that all land outside the continuously-cropped zone is open for grazing (ignores unmanured fields and assumes no externally-imposed boundary). The grazing perimeter for the village livestock is determined by the nocturnal location and effective grazing radius (GR) of its herds (affected by livestock species and herding practice). Cropland area is determined by dividing the grazed area by the assumed RCR.<sup>9</sup> Figure 3 shows how grazing radius can affect the amount of supportable agricultural land. Each of these two options are practised by different villages in Niger.<sup>10</sup> Bringing the animals to the perimeter of the cropped zone at night entails greater labour cost to the villagers, not only for guarding herds at night but also for the trips to the herd for milking. During the dry season, the relationship would fall between these two options since the cattle would spend nights on the fields.

**Figure 3.** The relationship between supportable continuously-cropped area and assumed sustainable rangeland-to-cropland ratio (RCR) as predicted by a simple landscape model where continuously cropped area is surrounded by freely available pastures.<sup>1</sup>

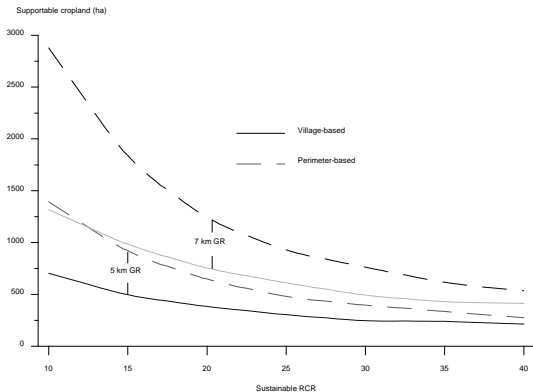

1. Different types of grazing management are reflected in two different grazing radii (5 and 7 km) and whether animals spend the night at the edge of the continuously-cultivated perimeter (dotted lines) or in the village (solid lines).

9. In cases where livestock are kept in the village at night, continuously-cropped land which is supportable by village herds (SA in hectares) is calculated thusly:

$$SA = \frac{100\pi \times GR^2}{(RCR + 1)}$$

Alternatively, where livestock are kept at the edge of the continuously-cropped zone,

$$SA = \frac{100\pi \times GR^2}{RCR - 2(\sqrt{RCR + 1} - 1)}$$

10. These examples do not come close to encompassing the full range of grazing radii and nocturnal locations in semi-arid West Africa. In fact, the two levels of grazing radius and nocturnal location presented here are based on the herd management practices of two neighbouring Djerma villages (3 km apart) in south-east Niger.



The interesting feature of this simple model is that it shows that over a wide range of sustainability ratios (e.g. 20–40), the supportable cropped area is determined more by the livestock management options taken by village households than by the sustainability ratio (RCR) itself. There is wide inter-household and inter-village variation in the grazing management of village-based livestock, reflecting differences in local patterns of land types, livestock management experience, labour availability, and prevalence of labour sharing. This variation also reflects a fair amount of experimentation by villagers. Therefore, there is the potential for management changes that would have significant positive effects on sustainability of agropastoral systems — a possibility often overlooked by development specialists who often mistakenly view livestock management as inherently resistant to change (Pouillon, 1990).

## Conclusions

This paper first introduces the mixed farming model for agricultural development in semi-arid West Africa and shows how it is often mistakenly viewed as synonymous with the more general concept of crop–livestock integration. It is shown that despite many years of failure, mixed farming proponents view the present demographic and economic situation as more conducive for widespread adoption. As a result of the theoretical and empirical evidence to support this claim, manuring has assumed the role as the most critical technical component of the mixed farming package. However, calculations of the rangeland required to support this practice show that there are severe biophysical limits to the widespread adoption of the mixed farming model. Continuous-cropping cannot be supported without the provision of fertilisers and/or animal supplements, both of which require foreign exchange. During the period before widespread availability of fertilisers and/or feed supplements in semi-arid West Africa, farmers will need to be able to pursue a wide range of practices to help maintain soil fertility. Given labour constraints in rural areas, there will be a continued need for labour-sharing, occupational specialisation, and barter exchange between different groups above the level of the household. The false promise of sedentary mixed farming has indirectly reduced the management options available to livestock owners by providing justification for government indifference towards the protection of transhumance corridors from agricultural encroachment, despite the fact that greater livestock mobility has become more necessary in heavily cultivated areas due to declining availability of local pastures.

While demonstrating the severe limits for the future of sedentary mixed farming, the high spatial and temporal abstraction of such analyses and the wide variation in their estimates are both cause and effect of the limited awareness of the critical importance of local management practices in affecting the sustainability of rangeland-to-cropland nutrient transfer. In other words, how rural producers utilise their local resources can be just as important as how many rural producers there are. Examples have been given in this paper showing that there is wide variation in management practices that significantly affect the efficiency of nutrient transfer and that these local practices have regionally emergent effects on the sustainability of rural production. Simply comparing regional land-use statistics with an estimated RCR range, while undoubtedly showing the need for population control and fertiliser imports, provides little guidance to policy makers, planners, and extension agents in implementing resource management policy.

## References

- Bassett T J. 1986. Fulani herd movements. *The Geographical Review* 76:233–248.
- Bernus E. 1974. L'évolution récente des relations entre éleveurs et agriculteurs en Afrique tropicale: l'exemple du Sahel Nigérien. *Cahiers de l'ORSTOM, Série Science Humaine* 11:137–143.
- Berry S. 1984. The food crisis and agrarian change in Africa: A review essay. *African Studies Review* 27:59–112.
- Blaikie P. 1985. *The political economy of soil erosion in developing countries*. Longman, London, UK. 188 pp.
- Bonfiglioli A M. 1982. *Ngaynaka: Herding according to the Wodaabe*. USAID/NRL (United States Agency for International Development/National Resources Laboratory), Niamey, Niger.

- Bonfiglioli A M. 1985. Évolution de la propriété animale chez les Wodaabe au Niger. *Journal des Africanistes* 55:29–37.
- Bonfiglioli A M. 1990. Pastoralisme, agropastoralisme et retour: itinéraires sahéliens. *Cahiers des Sciences Humaines* 26:255–266.
- Bonnet B. 1990. Elevage et gestion de terroirs en zone soudanienne. *Les Cahiers de la Recherche Développement* 25:43–67.
- Boserup E. 1965. *The conditions of agricultural growth: The economics of agrarian change under population pressure*. Aldine, New York, USA.
- Breman H and Cissé M I. 1975. Influence of the intensity of exploitation on the productivity of grasslands. In: ILCA (International Livestock Centre for Africa), *Evaluation and mapping of tropical African rangelands*. Proceedings of the Seminar, Bamako, Mali, 3–8 March 1975. ILCA, Addis Ababa, Ethiopia. pp. 207–212.
- Breman H and de Ridder N. 1991. *Manuel sur les pâturages des pays sahéliens*. ACCT (Agence de coopération culturelle et technique), Karthala, Paris, France and CTA (Centre technique de coopération agricole et rurale), Wageningen, The Netherlands. 485 pp.
- Breman H and de Wit C T. 1983. Rangeland production and exploitation in the Sahel. *Science* 221:1341–1347.
- Breman H, Traoré N, Bonfiglioli A, Eriksen J H, Ketelaars J J M H and Sawadogo K. 1986. *Analyse des conditions de l'élevage et propositions de politiques et de programmes*. République du Mali. OCDE (Organisation de coopération et de développement économiques), Paris, France. 213 pp.
- Calvet H, Picart P, Doutra M and Chambron J. 1965. Aphasose et botulisme au Sénégal. *Revue d'élevage et de médecine vétérinaire des pays tropicaux* 18:249–282.
- Charreau C and Nicou R. 1971. *L'amélioration du profil cultural dans les sols sableux et sablo-argileux de la zone tropicale sèche ouest-africaine et ses incidences agronomiques*. IRAT Bulletin Agronomique 23. IRAT, Paris, France. 254 pp.
- Delgado C L. 1979. *The southern Fulani farming system in Upper Volta: A model for the integration of crop and livestock production in the West African savannah*. MSU African Rural Economy Paper 20. MSU (Michigan State University), Lansing, Michigan, USA. 185 pp.
- Delgado C L. 1989. The changing economic context of mixed farming in Savanna West Africa: A conceptual framework applied to Burkina Faso. *Quarterly Journal of International Agriculture* 28:351–364.
- Fresco L O and Kroonenberg S B. 1992. Time and spatial scales in ecological sustainability. *Land Use Policy* 9:155–168.
- Gallais J. 1972. Essai sur la situation actuelle des relations entre pasteurs et paysans dans le Sahel ouest-africain. In: *Etudes de géographie tropicale offertes à Pierre Gourou*. Mouton, Paris, France. pp. 301–313.
- Gallais J. 1975. *Paysans et pasteurs du Gourma. La condition sahélienne*. CNRS (Centre national de la recherche scientifique), Paris, France.
- Garin P, Faye A, Lericollais A and Sissokho M. 1990. Evolution du rôle du bétail dans la gestion de la fertilité des terroirs Sereer au Sénégal. *Les Cahiers de la Recherche Développement* 26:65–84.
- Gavian S. 1992. *Manure and crop residue management strategies used by farmers in selected regions of the Tillabéri Department, Niger*. ILCA Niger Research Report 92/1. ILCA (International Livestock Centre for Africa), Niamey, Niger. 71 pp.
- Grayzel J A. 1977. *The ecology of ethnic-class identity among an African pastoral people: The Doukoloma Fulbe*. Doctoral dissertation, Department of Anthropology, University of Oregon, Eugene, Oregon, USA.
- Grayzel J A. 1990. Markets and migration: A Fulbe pastoral system in Mali. In: Galaty J G and Johnson D L (eds), *The world of pastoralism: Herding systems in comparative perspective*. Guilford Press, New York, USA. pp. 35–68.
- Grouzis M. 1988. *Structure, productivité, et dynamique des systèmes écologiques sahéliens (Mare d'Oursi, Burkina Faso)*. Editions de l'ORSTOM, Paris, France. 336 pp.
- Hafner H, Bley J, Bationo A, Martin P and Marschner H. 1993. Long-term nitrogen balance for pearl millet (*Pennisetum glaucum* L.) in an acid sandy soil of Niger. *Z. Pflanzenernähr. Bodenkd* 156:169–176.

- Hiernaux P and Turner M. 1993. The effect of the timing and frequency of clipping on nutrient uptake and production of sahelian annual rangelands. Submitted to the *Journal of Applied Ecology*.
- Jones M J. 1973. The organic matter content of the savanna soils of West Africa. *Journal of Soil Science* 24:42–53.
- Killanga S, Traoré A and Hardouin J. 1989. Différences de productivité entre troupeaux de petits ruminants dans le système agropastoral du Mali central. In: Wilson R T and Azeb Melaku (eds), *African small ruminant research and development*. ILCA (International Livestock Centre for Africa), Addis Ababa, Ethiopia. pp. 86–95.
- Koyate O. 1987. *Gestion et productivité des bovins dans le système agropastoral associé à la riziculture irriguée: contribution à l'étude des causes de différence de productivité entre troupeaux*. Mémoire de fin d'études, L'Institut polytechnique rural de Katibougou, Katibougou, 45 pp.
- Landais E and Lhoste P. 1990. L'association agriculture-élevage en Afrique intertropicale: un mythe techniciste confronté aux réalités du terrain. *Cahiers des Sciences Humaines* 26:217–235.
- Landais E and Lhoste P. 1993. Systèmes d'élevage et transferts de fertilité dans la zone des savanes africaines. *Cahiers Agricultures* 2:9–25.
- de Leeuw P N and Tohill J C. 1990. *The concept of rangeland carrying capacity in sub-Saharan Africa – myth or reality*. Pastoral Development Network Paper 29b. ODI (Overseas Development Institute), London, UK.
- Lélé S. 1993. A framework for sustainability: A plural, multi-dimensional approach. *Ecological Economics* (in press).
- Lewis J v D. 1979. *Descendants and crops: Two poles of production in a Malian peasant village*. Doctoral dissertation, Yale University, New Haven, USA.
- Lhoste P. 1987. *L'association agriculture-élevage. Evolution du système agropastoral au Sine-Saloum (Sénégal)*. Etudes et synthèses de l'IEMVT 21. IEMVT (Institut d'élevage et de médecine vétérinaire des pays tropicaux), Maisons-Alfort, France. 314 pp.
- Matlon P. 1988. The West African semi-arid tropics. In: Delgado C L and Blackie M J (eds), *Accelerating food production in sub-Saharan Africa*. Johns Hopkins University Press, Baltimore, USA. pp. 59–77.
- McCorkle C M and Mathias-Mundy E. 1992. Ethnoveterinary medicine in Africa. *Africa* 62:59–93.
- McCown R L, Haaland G and de Haan C. 1979. The inter-action between cultivation and livestock production in semi-arid Africa. In: Hall A E, Cannell G H and Lawton H W (eds), *Agriculture in semi-arid environments*. Springer-Verlag, Berlin, Germany. pp. 297–332.
- McIntire J, Bourzat D and Pingali P. 1992. *Crop-livestock interaction in sub-Saharan Africa*. The World Bank, Washington, DC, USA. 246 pp.
- de Miranda E E. 1980. *Essai sur les déséquilibres écologiques et agricoles en zone tropicale semi-aride: le cas de la région de Maradi au Niger*. Thèse de Docteur-Ingénieur, Université des sciences et techniques du Languedoc, Montpellier, France. 231 pp.
- Niamir M. 1990. *Herders' decision-making in natural resources management in arid and semi-arid Africa*. FAO Community Forestry Note 4. FAO (Food and Agriculture Organization of the United Nations), Rome, Italy. 126 pp.
- Pelissier P. 1977. Competition and the integration of agriculture and cattle raising in Sahelian and Soudano-Sahelian Africa. In: Cannell G H (eds), *Proceedings of an International Symposium on Rainfed Agriculture in Semi-Arid Regions, Riverside, California, 17–22 April 1977*. The University of California, Riverside, California, USA. pp. 513–519.
- Penning de Vries F W T and Djitéye M A. 1982. *La productivité des pâturages sahéliens*. Centre for Agricultural Publishing and Documentation, Wageningen, The Netherlands.
- Pieri C. 1986. Fertilisation des cultures vivrières et fertilité des sols en agriculture paysanne subsaharienne. *Agronomie Tropicale* 41:1–20.
- Pieri C. 1989. *Fertilité des terres de savanes*. Ministère de la coopération et du développement and Centre de coopération internationale en recherche agronomique pour le développement, Paris, France. 444 pp.
- Pingali P, Bigot Y and Binswanger H. 1986. *Agricultural mechanization and the evolution of farming systems in sub-Saharan Africa*. World Bank Discussion Paper Report ARU 40. The World Bank, Washington, DC, USA.

- Pouillon F. 1990. Sur la "stagnation" technique chez les pasteurs nomades: les peuls du Nord-Sénégal entre l'économie politique et l'histoire contemporaine. *Cahiers des Sciences Humaines* 26:173–192.
- Powell J M and Fussell L K. 1993. Nutrient and structural carbohydrate partitioning in pearl millet. *Agronomy Journal* 85:862–866.
- Powell M and Ikpe F. 1992. Fertiliser factories. *ILEIA Newsletter* 8:13–14. ILEIA (Information Centre for Low-External-Input and Sustainable Agriculture), Lensden, The Netherlands.
- Powell J M and Mohamed-Saleem M A. 1987. Nitrogen and phosphorus transfers in a crop–livestock system in West Africa. *Agricultural Systems* 25:261–277.
- Prudencio Y C. 1987. *Soil and crop management in selected farming systems of Burkina Faso: Agricultural research and policy implications*. Semi-Arid Food Grain Research and Development, Ouagadougou, Burkina Faso. 152 pp.
- Quilfen J P and Milleville P. 1981. Résidus de culture et fumure animale: un aspect des relations agriculture–élevage dans le nord de la Haute-Volta. *Agronomie Tropicale* 38:206–212.
- Rabot C. 1990. Transferts de fertilité et gestion des terroirs. *Les Cahiers de la Recherche Développement* 25:19–32.
- Ramaswamy S and Sanders J H. 1992. Population pressure, land degradation and sustainable agricultural technologies in the Sahel. *Agricultural Systems* 40:361–378.
- Raynaud C. 1988. Aspects of the problem of land concentration in Niger. In: Downs R E and Reyna S P (eds), *Land and society in contemporary Africa*. University Press of New England, Hanover, USA. pp. 221–242.
- Reardon T, Matlon P and Delgado C. 1988. Coping with household-level food insecurity in drought-affected areas of Burkina Faso. *World Development* 16:1065–1074.
- Richards P. 1985. *Indigenous agricultural revolution*. Westview Press, Boulder, Colorado, USA.
- de Ridder N and van Keulen H. 1990. Some aspects of the role of organic matter in sustainable intensified arable farming systems in the West African semi-arid-tropics (SAT). *Fertilizer Research* 26:299–310.
- Ruess R W and McNaughton S J. 1987. Grazing and the dynamics of nutrient and energy regulated microbial processes in the Serengeti grasslands. *Oikos* 49:101–110.
- Sandford S. 1983. *Organisation and management of water supplies in tropical Africa*. ILCA Research Report 8. ILCA (International Livestock Centre for Africa), Addis Ababa, Ethiopia. 45 pp.
- Sandford S. 1990. Integrated cropping–livestock systems for dryland farming in Africa. In: Unger P W, Sneed T V, Jordan W R and Jensen R (eds), *Challenges in dryland agriculture – A global perspective*. Proceedings of the International Conference on Dryland Farming. Texas Agricultural Experiment Station, College Station, Texas, USA. pp. 861–872.
- Starr M. 1987. Risk, environmental variability and drought-induced impoverishment: The pastoral economy of central Niger. *Africa* 57:29–49.
- Stoorvogel J J and Smaling E M A. 1990. *Assessment of soil nutrient depletion in sub-Saharan Africa: 1983–2000*. The Winand Staring Centre, Wageningen, The Netherlands.
- Sutter J W. 1987. Cattle and inequality: Herd size differences and pastoral production among the Fulani of northeastern Senegal. *Africa* 57:196–218.
- Swallow B M. 1994. *The role of mobility within the risk management strategies of pastoralists and agro-pastoralists*. IIED Gatekeeper Series 47. IIED (International Institute for Environment and Development), London, UK. 27 pp.
- Swift M J, Frost P G H, Campbell B M, Hatton J C and Wilson K B. 1989. Nitrogen cycling in farming systems derived from savanna: Perspectives and challenges. In: Clarholm M and Bergström L (eds), *Ecology of arid lands*. Kluwer Academic Publishers, Dordrecht, The Netherlands. pp. 63–76.
- Swinton S M. 1988. Drought survival tactics of subsistence farmers in Niger. *Human Ecology* 16:123–144.
- Toulmin C. 1983. *Herders and farmers or farmer-herders and herder-farmers*. ODI Pastoral Network Paper 15d. ODI (Overseas Development Institute), London, UK. 22 pp.

- Turner M. 1992. *Living on the edge: FulBe herding practices and the relationship between economy and ecology in the Inland Niger Delta of Mali*. Doctoral dissertation, Energy and Resources Group, University of California, Berkeley, USA. 469 pp.
- Turner M. 1993. Overstocking the range: A critical analysis of the environmental science of Sahelian pastoralism. *Economic Geography* 69(4):402–421.
- van der Pol F. 1992. *Soil mining: An unseen contributor to farm income in southern Mali*. Royal Tropical Institute, Amsterdam, The Netherlands.
- van Keulen H and Breman H. 1990. Agricultural development in the West African Sahelian region: A cure against land hunger? *Agriculture, Ecosystems and Environment* 32:177–197.
- White C. 1984. *Herd reconstitution: The role of credit among WoDaaBe herders in Central Niger*. ODI Pastoral Development Network Paper 18d. ODI (Overseas Development Institute), London, UK.
- Williams T O. 1994. Identifying target groups for livestock improvement research: The classification of sedentary producers in western Niger. *Agricultural Systems* 46(2):227–237.
- Winrock International. 1992. *Assessment of animal agriculture in sub-Saharan Africa*. Winrock International Institute for Agricultural Development, Morrilton, Arkansas, USA. 125 pp.
- Young A and Wright A C. 1980. Rest period requirements of tropical and subtropical soils under annual crops. In: FAO (Food and Agriculture Organization of the United Nations), *Land resources for populations of the future*. Report of the Second ILCA/UNFPA Expert Consultation, 4–6 December 1979. FAO, Rome, Italy. pp. 197–268.

# Measuring the sustainability of crop–livestock systems in sub-Saharan Africa: Methods and data requirements

S. Ehui and M.A. Jabbar

International Livestock Centre for Africa (ILCA), P O Box 5689, Addis Ababa, Ethiopia

## Abstract

Livestock are an important component of farming systems in sub-Saharan Africa. They are raised mainly for meat, milk and skin and provide a flexible financial reserve in years of crop failure. They also play a critical role in the agricultural intensification process by providing draft power and manure for crop production. With increasing human population and economic changes, cultivated areas in many sub-Saharan African countries have expanded on to marginal lands and fallow periods are being shortened. As a result, large areas of land have been degraded and crop and animal yields have fallen. Improved crop–livestock production systems and technologies are currently being developed in response to the growing demand for food and the degradation of the natural resource base. These technologies must enhance food production; they also need to maintain ecological stability and preserve the natural resource base, i.e. they must be sustainable. However, the notion of sustainability has been of limited operational use to policy makers and researchers attempting to evaluate new technologies and/or determine the effects of various policies and technologies. This paper discusses a methodology for measuring the sustainability and economic viability of crop–livestock systems. The approach is based on the concept of intertemporal and interspatial total factor productivity, paying particular attention to the valuation of natural resource stock and flows. The method is applied to a data set available at the International Livestock Centre for Africa (ILCA). Intertemporal and interspatial total factor productivity indices are computed for three farming systems in south-western Nigeria. Results show that the sustainability and economic viability measures are sensitive to changes in the stock and flow of soil nutrients as well as to material inputs and outputs. The advantage of this approach is that intertemporal and interspatial total factor productivity measures are computed using only price and quantity data, thus eliminating the need for econometric estimation.

## Evaluation de la durabilité des systèmes mixtes de production agropastorale en Afrique subsaharienne: méthodes et données requises

S. Ehui et M.A. Jabbar

Centre international pour l'élevage en Afrique (CIPEA), B.P. 5689, Addis-Abeba (Ethiopie)

## Résumé

*L'élevage est une composante importante des systèmes de production agricole de l'Afrique subsaharienne. Les animaux sont élevés essentiellement pour la viande, le lait et les peaux et constituent une réserve financière souple, particulièrement utile les années de mauvaises récoltes. Ils jouent également un rôle majeur dans le processus d'intensification agricole dans la mesure où ils fournissent la force de traction et produisent le fumier nécessaire pour la production végétale. Compte tenu de la croissance démographique et des changements économiques, les surfaces emblavées dans de nombreux pays d'Afrique subsaharienne s'étendent aux terres marginales et les jachères se raccourcissent. En conséquence, de vastes étendues de terre se dégradent et la productivité de l'élevage et des cultures diminuent. Des systèmes améliorés de production mixte et de nouvelles technologies sont actuellement développés pour faire face à la demande croissante de produits*

*alimentaires et à la dégradation de la base de ressources naturelles. Ces techniques devront permettre, non seulement d'améliorer la production vivrière, mais également de maintenir la stabilité de l'environnement et de préserver la base de ressources. En d'autres termes, elles se doivent donc d'être durables. Malheureusement, le concept de durabilité est d'une utilité pratique limitée pour des responsables et des chercheurs désireux d'évaluer de nouvelles technologies et/ou de déterminer leur impact ou celui de politiques diverses. Cet article examine une méthodologie de mesure de la durabilité et de la viabilité économique des systèmes mixtes de production agropastorale. L'approche utilisée est basée sur le concept de productivité totale de facteurs dans le temps et dans l'espace et fait une large place à l'estimation de la valeur monétaire des réserves et des flux de ressources naturelles. Cette méthode a été appliquée à un ensemble de données disponibles au Centre international pour l'élevage en Afrique (CIPEA). Les indices de productivité totale des facteurs dans le temps et dans l'espace ont été calculés pour trois systèmes de production du sud-ouest du Nigéria. Les résultats ont montré que les mesures de la durabilité et de la viabilité économique étaient sensibles aux fluctuations des réserves et des flux d'éléments nutritifs du sol de même qu'aux intrants et aux extrants matériels. L'avantage de cette approche est que la productivité totale de facteurs dans le temps et dans l'espace est calculée uniquement à partir de données de prix et de quantité, ce qui signifie qu'elle ne nécessite aucune évaluation économétrique.*

## **Introduction**

Livestock are an important component of farming systems in sub-Saharan Africa. They are raised mainly for meat, milk and skin and provide a flexible financial reserve for farmers in years of crop failure. They also play a critical role in the agricultural intensification process by providing draft power and manure for fertiliser and fuel (Winrock International, 1992; Fitzhugh et al, 1992). With increasing human population and economic changes, cultivated areas in many sub-Saharan African countries have expanded on to marginal lands and fallow periods are being shortened. As a result, large areas of land are being degraded and crop and animal yields are falling (IBRD, 1989; Ehui and Hertel, 1989). Where both crops and livestock are raised, technology is low, inputs scarce, and markets poorly developed, population pressures lead to the evolution of crop–livestock systems as the most efficient and sustainable means of increasing off-take from a fixed land base (McIntire et al, 1992). Thus smallholders will benefit from livestock if they can be successfully integrated with the cropping systems.

Improved crop–livestock production systems and technologies are currently being developed in response to the growing demand for food and the degradation of the natural resource base (ILCA, 1993). These technologies must not only enhance food production but also maintain ecological stability and preserve the natural resource base, i.e. they must be sustainable. However, the notion of sustainability has been of limited operational use to policy makers and researchers attempting to evaluate new technologies and determine the effects of various policies and technologies. This paper discusses a methodology for measuring the agricultural sustainability and economic viability of crop–livestock systems. The approach is based on the concept of intertemporal and interspatial total factor productivity (TFP) paying particular attention to valuation of natural resource stock and flows (Ehui and Spencer, 1993).

## **Derivation of intertemporal and interspatial TFP indices**

The conventional approach to growth accounting uses TFP indices to measure the residual growth in outputs not accounted for by the growth in factor inputs. The rate of growth of TFP is conventionally defined as the rate of growth of aggregate output minus the rate of growth of aggregate inputs (Capalbo and Antle, 1988).

Agriculture, however, is a sector which utilises common pools of natural resources (e.g. air, water, soil nutrients etc). The stock of these resources affects the production environment, but is in many

cases beyond the control of the farmers. For example soil nutrients are removed by crops, erosion or leaching beyond the crop root zone, or other processes such as volatilisation of nitrogen. Agricultural production can also contribute to the stock of some of the nutrients, particularly of nitrogen by leguminous plants and animal manure.

When the stock of nutrients is reduced through nutrient losses, the farmer faces an implicit cost in terms of productivity loss. Conversely, when the stock of resources is increased during the production process (e.g. via nitrogen fixation or manuring) the farmer derives an implicit benefit from the system. If these implicit costs and benefits are not accounted for when TFP is measured, results will be misleading.

The model used here builds on that developed by Ehui and Spencer (1993). They show that a system will be said to be sustainable if the associated intertemporal TFP index, which incorporates and values changes in the resource stock and flow, does not decrease. They also show that one system will be said to be economically more viable than another if the interspatial TFP index associated with the former, which incorporates and values spatial differences in the resource stock and flow, is higher than the interspatial TFP index associated with the latter. While intertemporal TFP is about the productive capacity of a system over time (thus sustainability) interspatial TFP is a static concept which refers to the efficiency with which resources are employed in the production process at a given period. In both cases the measures include the unpriced contribution from natural resources and their unpriced production flows.

Figure 1 illustrates the difference between intertemporal and interspatial TFP for two hypothetical systems. System 1 is sustainable since its intertemporal TFP increases from "a" to "d" over the same period. However, system 2 is economically more viable (or efficient) than system 1 in year 2 ( $c > a$ ), but it is economically less viable in year n ( $d > b$ ).

**Figure 1.** Total factor productivity changes for two hypothetical agricultural systems over time.

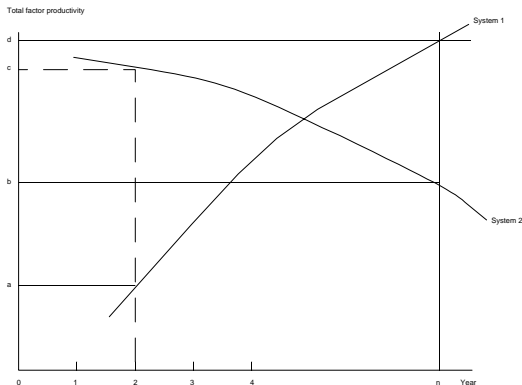



To derive the generalised model for TFP measurement, Ehui and Spencer (1993) solved a maximisation problem. When changes in resource stock levels are positive, the problem is stated as:

$$\text{Max } \pi_t = P_{yt} Y_t + P_{zt} Z_t - G(Y_t, Z_t, W_t, B_t, t) \quad (1)$$

$$[Y_t, Z_t]$$

In this equation  $\pi_t$  is a measure of aggregate profit in period  $t$ , including all benefits and costs of resource exploitation;  $Y_t$  is an index of crop outputs;  $Z_t$  is an externality denoting the net resource flow in period  $t$ ; when changes in resource abundance levels are positive, we have a positive externality and the resulting net resource flow,  $Z_t$ , is treated as an output, thus contributing positively to the aggregate profit.  $P_{yt}$  and  $P_{zt}$  are the product and resource flow prices;  $B_t$  is a technology shift variable representing the level of resource abundance in period  $t$ . Equation (1) represents the case of "open access" in which  $B_t$  is not a choice variable. The resource stock is beyond the control of farmers who thus ignore its opportunity cost.  $G(\cdot)$  is the variable cost function for the optimal combination of variable inputs, where  $G(\cdot)/B < 0$  and  $G(\cdot)/Z > 0$ .  $W_t$  is a vector of variable input prices;  $t$  is the time trend representing the state of technical knowledge.

When the production process is depleting the resource at a rate faster than that required for sustainability, net changes in resource abundance levels are negative. Thus, we have a negative externality and  $Z_t$  is treated as a cost, contributing negatively to the aggregate profit. This requires modification of the objective function (1) by replacing the (+) sign before  $P_{zt}Z_t$  with a (-) sign, and in this case,  $G(\cdot)/Z < 0$ .

Using the first order conditions of (1), development of the continuous time Divisia index by method of the growth accounting approach gives:

$$-\partial \text{Ln}C/\partial t = [P_y Y/C] \dot{Y} + [P_z Z/C] \dot{Z} - \sum_j [(W_j X_j)/C] \dot{X}_j - \dot{B} \quad (2)$$

In this equation  $C = \sum_j W_j X_j = P_y Y + P_z Z$  = total revenue assuming constant returns to scale. Dots on variables imply the logarithm derivation of the associated variable with time.

When changes in the resource stock are negative, the productivity index becomes:

$$-\partial \text{Ln}C/\partial t = [P_y Y/C] \dot{Y} - [(P_z Z)/C] \dot{Z} - \sum_j [(W_j X_j)/C] \dot{X}_j - \dot{B} \quad (3)$$

where  $C = \sum_j W_j X_j + P_z Z = P_y Y$ , assuming constant returns to scale.

Equations (2) and (3) indicate that TFP is measured as the residual after the growth rate of output  $\{[P_y Y/C]\}$  has been allocated among changes in inputs  $\{\sum_j [(W_j X_j)/C]\}$  and resource abundance  $\{B\}$  and flows  $[P_z Z/C]Z$ . The basic difference between (2) and (3) is that in (2) the change in resource stock is assumed positive and the resulting flow is treated as a benefit. In equation (3) the change in resource stock is assumed to be negative and the resulting flow is treated as a cost.

It is clear from equations (2) and (3) that total factor productivity measures are biased unless variations in the resource stock abundance levels and resource flows are accounted for. Note that although it is not a choice variable,  $B_t$  is part of the solution because it appears in the variable cost function,  $G$ .

A discrete-time approximation to the continuous time Divisia indexes of equations (2) and (3) is given by the Tornqvist approximation (Diewert, 1976; Ehui and Spencer, 1993). Allowing for resource abundance and flows this approximation gives measures of the intertemporal and interspatial TFP indexes. As in equations (2) and (3) we distinguish between two cases:

### Case of net positive changes in resource stock

- Intertemporal TFP

$$\tau_{st} = \frac{1}{2} \sum_j [R_{js} + R_{jt}] \cdot [\text{Ln}Y_{js} - \text{Ln}Y_{jt}] + \frac{1}{2} [R_{zs} + R_{zt}] \cdot [\text{Ln}Z_s - \text{Ln}Z_t]$$

$$- \frac{1}{2} \sum_k [S_{ks} + S_{kt}] \cdot [\text{Ln}X_{ks} - \text{Ln}X_{kt}] - [\text{Ln}B_s - \text{Ln}B_t] \quad (4)$$

- Interspatial TFP

$$\rho_{io} = \frac{1}{2} \sum_j [R_{ji} + R_{jo}] \cdot [\ln Y_{ji} - \ln Y_{jo}] + \frac{1}{2} [R_{zi} + R_{zo}] \cdot [\ln Z_i - \ln Z_o] - \frac{1}{2} \sum_k [S_{ki} + S_{ko}] \cdot [\ln X_{ki} - \ln X_{ko}] - [\ln B_i - \ln B_o] \quad (5)$$

### Case of net negative changes in resource stock

- Intertemporal TFP

$$\tau'_{st} = \sum_j [\ln Y_{js} - \ln Y_{jt}] - \frac{1}{2} [S_{zs} + S_{zt}] \cdot [\ln Z_s - \ln Z_t] - \frac{1}{2} \sum_k [S_{ks} + S_{kt}] \cdot [\ln X_{ks} - \ln X_{kt}] - [\ln B_s - \ln B_t] \quad (6)$$

- Interspatial TFP

$$\rho'_{io} = \sum_j [\ln Y_{ji} - \ln Y_{jo}] - \frac{1}{2} [S_{zi} + S_{zo}] \cdot [\ln Z_i - \ln Z_o] - \frac{1}{2} \sum_k [S_{ki} + S_{ko}] \cdot [\ln X_{ki} - \ln X_{ko}] - [\ln B_i - \ln B_o] \quad (7)$$

where *s* and *t* represent two distinct time periods and *i* and *o* represent two distinct farming systems or two distinct geographical areas; *B* is the composite index of soil nutrient abundance; *Z* denotes the resource flow;  $R_j = (P_j Y_j) / (\sum_j P_j Y_j)$  is the revenue share for output *Y<sub>j</sub>*;  $S = (W_k X_k) / (\sum_k W_k X_k)$  is the cost share for variable input *k*, and *S<sub>z</sub>* and *R<sub>z</sub>* are the cost and revenue shares of resource flow *Z*. The basic difference between  $\tau_{st}$  and  $\rho_{io}$  and  $\tau'_{st}$  and  $\rho'_{io}$  is that in equations (4) and (5) the net increase in resource stock is treated as benefit while in equations (6) and (7) it is treated as cost. It is clear from equations (4) to (7) that the productivity differences across different farming systems and time periods can be broken into four components including: an output effect (the first term in equations (4) to (7)), a resource flow (the second term in equations (4) to (7)) effect, an input effect (the third term in equations (4) to (7)) and a resource stock effect (the last term in equations (4) to (7)).

## Data sources

The framework discussed above is demonstrated using a set of data generated during a nine-year study by the International Livestock Centre for Africa (ILCA) at Ibadan (south-western Nigeria). The experiment comprised three systems: the traditional method of cultivation (system A) commonly known as bush fallow system; the continuous alley farming systems (system B); and alley farming with fallow (system C).

In the traditional system farmers fell and burn the fallow vegetation, cultivate the cleared land (typically one to three years) and then abandon the site (from 4 to 20 years) to forest or bush cover (Sanchez, 1976). This traditional agricultural production system, which is known to be stable and biologically efficient, operates effectively only where there is sufficient land to allow a long fallow period to restore soil productivity (Kang et al, 1989). The fallow land also serves as a source of feed for the animals. In recent times, population growth and various economic changes have caused the fallow period to be shortened or eliminated. This is resulting in increased degradation of farm land, lower supply of quality feed, declining crop and animal yields and reduced production of food from both crop and animal origins.

Alley farming is an agroforestry system in which crops are grown in alleys formed by hedgerows of trees and shrubs, preferably fast-growing leguminous species. The hedgerows are cut back at the time of planting food crops and are periodically pruned during cropping to prevent shading and to reduce competition with the associated food crops. They may also be established along slopes to

minimise erosion. A portion of the hedgerow foliage is used as animal feed. Using woody legumes provides rich mulch and green manure to maintain soil fertility, enhance crop production, and provide protein-rich fodder for livestock. In this experiment small ruminants were part of the system and were fed part of the hedgerow foliage. One major advantage of alley farming over the traditional bush fallow system is that cropping, animal feeding and fallow phases can take place concurrently on the same land unit, allowing the farmer to crop the land and feed the animals for an extended period. However, where it is technically feasible, it is possible to combine alley farming with some short cycle fallow periods as in system C.

Since the cropping systems have multiple crop outputs (maize and cowpea) an implicit output index is calculated by dividing the total value of all output by a price index. The latter is obtained by weighting the maize and cowpea prices by the revenue share of each crop.

Three major inputs are distinguished: planting materials, labour and fertiliser. While labour and fertiliser input quantities are used as observed, the planting material indices are bilateral Tornqvist chain indices for each type of planting materials. Planting materials for each crop is aggregated to a single index weighted by the cost share of each planting material.

The Divisia index for the soil nutrient stock is calculated by share-weighting the total quantities of main soil nutrients (nitrogen, phosphorus and potassium) available in the top soil (0–10 cm). The opportunity cost of each soil nutrient is approximated by its replacement cost, i.e. market price for chemical fertiliser. Resource (nutrient) flows are derived as the difference between nutrient abundance levels for a given production system between 1983 and 1984, and between 1983 and 1990. These two periods were chosen to assess short- and long-run effects.

## Empirical results

Intertemporal and interspatial total factor productivity indices for the three production systems under different scenarios were calculated and are reported in Tables 1 and 2, respectively. The basic analysis is conducted under two scenarios: (1) with and without resource stock and flows and (2) with and without a livestock component. Scenario (2) was evaluated to assess the impact of the livestock component on the TFP measures.

**Table 1.** *Intertemporal total factor productivity (sustainability) indices for three crop–livestock systems under experimental conditions in south-western Nigeria, 1983–1984 and 1983–1990.*

Systems	Not accounting for resource stock and flows		Accounting for resource stock and flows			
	1983–84	1983–90	1983–84		1983–90	
			Livestock	No livestock	Livestock	No livestock
(1)	(2)	(3)	(4)	(5)	(6)	
Traditional bush fallow (A)	1.24	0.92	1.17*	1.34*	0.78**	0.69**
Continuous alley farming (B)	1.31	1.46	1.08*	1.59*	1.28**	0.64**
Alley farming with fallow (C)	1.17	0.60	1.00*	1.47*	0.60*	0.56*

\* = positive resource flow; \*\* = negative resource flow.

From column (5) in Table 1, over the period from 1983 to 1990, TFP increased for the continuous alley-farming systems (system B) and declined for both the traditional system (system A) and alley-farming with fallow (system C). The continuous alley-farming system produced 1.28 times as much output in 1990 as in 1983 using the 1983 input bundle. Therefore, the continuous alley-farming system can be said to be sustainable over the seven-year interval since after properly accounting for

temporal differences in input quality and quantity and resource flows and stocks, it produced more than in the reference year (1983). The traditional bush-fallow system and the alley-farming systems with fallow produced only 0.78 and 0.60 as much output in 1990 as in 1983 using the 1983 input bundle. Thus these two systems can be said to be non-sustainable. During the period 1983–1984, the three systems had total factor productivity measures greater than one, indicating that they were sustainable over the relatively short one-year period (Table 1, column 3). Totally accounting for changes in resource stock levels and flows, alters the productivity measures (Table 1). For example during 1983–90 when resource stock and flows are not accounted for, results indicate that the continuous alley-farming system and the traditional bush fallow-system produced 1.46 and 0.92 as much output as in 1983 using 1983 input bundle. However, since there was a decline in nutrient stock level in both systems over time the gain in productivity level was actually lower (1.28 and 0.28), respectively (Table 1).

**Table 2.** *Interspatial total factor productivity (economic viability) indices for three crop–livestock systems under experimental conditions in south-western Nigeria during 1983, 1984, 1989 and 1990.*

Systems	Not accounting for resource stock and flows			Accounting for resource stock and flows					
	1983	1984	1990	1983		1984		1990	
				Livestock	No livestock	Livestock	No livestock	Livestock	No livestock
(1)	(2)	(3)	(4)	(5)	(6)	(7)	(8)	(9)	
Traditional bush fallow (A)	1	1	1	1	1	1	1	1	1
Continuous alley farming (B)	1.91	1.63	1.36	1.87*	1.045*	1.41*	0.94*	1.26*	0.95*
Alley farming with fallow (C)	2.11	2.14	1.45	2.06*	1.045*	1.93*	1.15*	1.18*	1.03*

\* = positive resource flow.

In Table 2, the economic viability of the three systems during 1983, 1984 and 1990 are compared. The traditional bush-fallow system is used as the reference base system. In 1983, 1984 and 1990, after accounting for changes in resource abundance and flows, both the alley-farming systems (continuous and with fallow) are shown to be relatively more productive than the traditional bush-fallow system. The estimated interspatial TFP measures are largely greater than one, indicating that the two alley farming systems produced comparatively more output than the traditional bush-fallow system using the latter system's input bundle. Comparison of columns (1) to (3) with columns (4), (6) and (8) indicate that when resource stock and flows are accounted for the productivity measures yield different results. The extent of these differences, of course, depend on how significant the changes in resource stock and flows are. In this case, changes in resource stock levels and flows have not been significant enough to substantially alter the productivity measures.

To assess the relative importance of the livestock component in the TFP measures, the analysis was conducted with and without a livestock component. In all cases except for the measurement of the intertemporal TFP during 1983–84, all the productivity measures declined significantly indicating that livestock do play a significant role in the total productivity of the farm. Therefore when farmers raise animals on the farm (as all of them do) and the productivity measures consider only the crop aspect, results will be biased. A system may be said to be non-sustainable when it is like the continuous alley farming during the period from 1983 to 1990. When the animal component is ignored, the

intertemporal TFP measure is only 0.64. When the livestock component is accounted for the same productivity measure doubles to 1.28 (Table 1). The same is true for interspatial TFP measures. For example during 1990 when the livestock component is omitted from the analysis, we erroneously conclude that the continuous alley farming is economically less viable than the traditional bush-fallow system (see Table 2, columns (8) and (9)).

## Conclusions

Intertemporal and interspatial TFP adjusted for resource flows and stock provide an excellent framework for evaluating the sustainability and economic viability of production systems. In this paper conventional TFPs are modified to develop a generalised TFP framework in which the contribution of crop and livestock outputs and the unpriced contribution of nutrient stock and flows are separately and properly accounted for. This paper shows that where resource flows and stocks are not negligible, the measures of TFP indices provide markedly different results from conventional TFP approaches. Disentangling the productivity residual from changes in resource stock and flows honed the productivity residual to finer precision. While the analytical framework presented within this paper is appealing, its successful application depends greatly on data availability. In this paper only changes in major soil nutrient are taken into consideration. The model needs to take into consideration other indications of natural resource degradation, including vegetation, and the physical, chemical and microbiological properties of soil.

## References

- Capalbo S M and Antle J M (eds). 1988. *Agricultural productivity measurement and explanation*. Resource for the Future, Washington, DC, USA.
- Diewert W E. 1976. Exact and superlative index numbers. *Journal of Econometrics* 4:115–145.
- Ehui S K and Hertel T W. 1989. Deforestation and agricultural productivity in the Côte d'Ivoire. *American Journal of Agricultural Economics* 71:703–711.
- Ehui S K and Spencer D S C. 1993. Measuring the sustainability and economic viability of tropical farming systems: A model from sub-Saharan Africa. *Agricultural Economics* 4:279–296.
- Fitzhugh H A, Ehui S K and Lahlou-Kassi A. 1992. Research strategies for development of animal agriculture. *World Animal Review* 72(3):9–19.
- IBRD (International Bank for Reconstruction and Development). 1989. *Sub-Saharan Africa: From crisis to sustainable growth*. A long-term perspective study. World Bank, Washington, DC, USA. 300 pp.
- ILCA (International Livestock Centre for Africa). 1993. *ILCA 1992: Annual Report and Programme Highlights*. ILCA, Addis Ababa, Ethiopia. 86 pp.
- Kang B T, van der Kruijs A C B M and Couper D C. 1989. Alley cropping for food crop production in the humid and subhumid tropics. In: Kang B T and Reynolds L (eds), *Alley farming in the humid and subhumid tropics*. Proceedings of an international workshop held at Ibadan, Nigeria, 10–14 March 1986. IDRC (International Development Research Centre), Ottawa, Ontario, Canada. pp. 16–26.
- McIntire J, Bourzat D and Pingali P. 1992. *Crop–livestock interaction in sub-Saharan Africa*. The World Bank, Washington, DC, USA. 246 pp.
- Sanchez P A. 1976. *Properties and management of soil in the tropics*. Wiley, New York, USA.
- Winrock International. 1992. *Assessment of animal agriculture in sub-Saharan Africa*. Winrock International Institute for Agricultural Development, Morrilton, Arkansas, USA. 125 pp.

# The role of livestock in sustainable agriculture and natural resource management

*J.D. Reed and J. Bert*

Department of Meat and Animal Science, University of Wisconsin, Madison, WI 53706, USA

## Abstract

The objectives of this paper are to introduce the reader to the Sustainable Agriculture and Natural Resource Management Collaborative Research Support Program (SANREM/CRSP) and the Landscape Approach to Sustainability in the Tropics (LAST) and discuss the role of livestock in these projects. LAST uses landscape ecology to research the interactions among ecosystems within a watershed. The farmer-back-to-farmer research approach and gender analysis are integral tools which are used throughout the design and implementation of the project. The results of a Participatory Landscape Appraisal conducted in collaboration with LAST researchers and the farmers in the watershed which encompasses the village of Donsin in Burkina Faso are used to illustrate the role of livestock in SANREM. Livestock in the Donsin watershed have a direct impact on: conservation of soil and water resources; management of soil fertility and the soil's physical and biological characteristics; nutrient cycles within the watershed; cultural practices for controlling erosion; maximising biological production potential; the management of forest resources; and the introduction of agroforestry projects. The people of Donsin are heavily dependent on the natural resource base within their watershed but these resources are undergoing rapid transformations due to drought and increased exploitation. The LAST approach will use participatory research in SANREM to assist the people of Donsin improve their standard of living by developing tools which can be used for appropriate management of natural resources. Interdisciplinary research on the role of livestock needs to be incorporated into broader research themes within the context of human and agricultural ecology to assist farmers in Donsin manage natural resources.

## Rôle de l'élevage dans une agriculture viable et une gestion rationnelle des ressources naturelles

*J.D. Reed et J. Bert*

Department of Meat and Animal Science, University of Wisconsin, Madison, WI 53706 (E.-U.)

## Résumé

*Cet article présente le Programme d'appui à la recherche concertée sur l'agriculture et la gestion des ressources naturelles (SANREM/CRSP) et l'approche Terroir pour la durabilité dans les régions tropicales (LAST) et examine la place de l'élevage dans ces projets. Sur la base de l'écologie du terroir, le LAST examine les interactions entre les écosystèmes d'un même bassin hydrographique. L'approche paysan-paysan et l'étude du rôle de la femme sont des outils présents à tous les stades de la conception et de l'exécution du projet. Les résultats d'une évaluation participative de la situation du terroir effectuée en collaboration avec les chercheurs du LAST et des paysans du bassin abritant le village de Donsin (Burkina Faso) ont été utilisés pour illustrer le rôle de l'élevage dans le Programme d'appui. L'élevage dans ce bassin avait un impact direct sur la conservation des sols et des ressources en eau, la gestion de la fertilité et les caractéristiques physiques et biologiques des sols, le recyclage des éléments nutritifs dans le bassin versant, les pratiques culturelles utilisées dans la lutte contre l'érosion, l'optimisation du potentiel de production biologique, la gestion des ressources forestières et l'introduction de projets agroforestiers. Les populations de Donsin sont largement tributaires des ressources naturelles du bassin, mais celles-ci subissent des transformations*

*rapides en raison de la sécheresse et d'une exploitation croissante. Le LAST envisage de recourir à une approche participative au sein du Programme d'appui pour aider les populations de Donsin à améliorer leurs conditions de vie par la mise au point d'outils nécessaires pour améliorer la gestion des ressources naturelles. Cela passe par l'intégration de la recherche interdisciplinaire sur le rôle de l'élevage dans des thèmes de recherche plus vastes dans le cadre aussi bien du milieu humain que de l'écosystème agricole.*

## Introduction

The objectives of this paper are to present the role of livestock in sustainable agricultural systems; introduce the reader to the Sustainable Agriculture and Natural Resources Management (SANREM) Collaborative Research Support Program (CRSP) and the Landscape Approach to Sustainability in the Tropics (LAST); present relevant results of the reconnaissance survey from the SANREM/CRSP Burkina Faso site; and discuss how interdisciplinary research on the role of livestock is part of elucidating principles of SANREM.

Sustainable agriculture has been defined by the National Agricultural Research, Extension and Training Policy Act of 1977, as amended by Section 1603 of the Fact Act as:

*an integrated system of plant and animal production practices having a site-specific application that will, over the long term: 1) satisfy human food and fiber needs; 2) enhance environmental quality and the natural resource base upon which the agricultural economy depends; 3) make the most efficient use of nonrenewable resources and on-farm resources and integrate where appropriate, natural biological cycles and controls; 4) sustain the economic viability of farm operations; and 5) enhance the quality of life for farmers and society as a whole (USDA, 1994).*

Almost all definitions of sustainable agriculture include the need for long-term maintenance of natural resources and agricultural productivity, minimal adverse environmental impacts, adequate economic returns to farmers, optimal crop production with minimised chemical inputs, satisfaction of human needs for food and income, and provision for the social needs of farm families and communities (NRC, 1991).

The role of livestock in promoting sustainable agriculture and natural resource management is implicit in these definitions. Livestock production has a direct impact on four of the eight elements of sustainable agriculture as listed by the NRC (1991): 1) conservation of soil and water resources and soil physical and biological characteristics, processes and cycles that maintain soil fertility; 2) cultural practices for improving soil fertility, controlling erosion, and maximising biological production potential (e.g. tillage methods, crop residue management, irrigation, alley cropping and agroforestry); 3) indigenous practices and uses of germplasm and the economic and cultural consequences of biodiversity loss and preservation; and 4) the consequence of converting forest and savannah lands into range for cattle production. Livestock production systems also affect other elements of sustainable agriculture such as integrated pest management, institutional arrangements, resource management, land tenure, public policy and production of food crops and cash crops (NRC, 1991).

The central themes of sustainable agriculture are crucial to food production and the well being of farmers in agropastoral and mixed farming systems in Africa. In these farming systems, crop and livestock production interact in ways which either complement or compete for natural and human resources (Reed, 1988; McIntire et al, 1992). Most farms in African agropastoral and mixed farming systems are operated by a single extended family with little or no hired labour. Levels of crop and livestock production provide subsistence, but do not provide sufficient savings and capital for investment and the purchase of external inputs. These farms have a significant dependence on livestock (McDowell, 1977a). Income from animal-related products is typically 40% of the gross farm income, but may be as high as 70% (Gryseels and Getachew Asamenew, 1985).

Ruminant livestock contribute a large diversity of non-food products (McDowell, 1977b). Milk and meat production are less important than livestock products which complement crop production such as animal traction and manure for increasing soil fertility (McDowell, 1977b). Other uses are also important, especially the role of livestock as a source of capital for purchasing seeds and food when on-farm production of food is inadequate. Manure is used to increase soil fertility as fertilisers are often unavailable or too expensive. Animal traction is used for cultivation, weeding, carting, water-lifting and processing food crops. Domestic ruminants and equines increase overall farm productivity by grazing uncultivated land and crop residues. Swine, poultry and a large diversity of other species complement food production by using kitchen wastes and by-products of food processing, and therefore increase overall crop productivity.

However, livestock may also compete with food crop production in the use of resources (land, labour and capital). Increases in the area of land cultivated leads to restriction of grazing areas and the potential of damage to crops from grazing animals (cf. Loofboro, 1993). Labour for herding livestock during the cropping season may not be available because young adults have emigrated to urban areas, children are attending school and existing labour is needed for cultivating, planting, weeding and harvesting food crops. If labour for herding is unavailable, cattle, sheep and goats may be tethered for extended periods of time during the cropping season. Tethered livestock have low productivity because they have insufficient feed, decreased grazing time and increased exposure to disease (especially internal parasites). Development of rice cultivation and vegetable gardening in seasonally flooded pasture land is another form of competition between livestock and crop production.

## **A landscape approach to sustainability in the tropics**

The Sustainable Agriculture and Natural Resource Management Collaborative Research Support Program (SANREM/CRSP) is funded by the United States Agency for International Development (USAID). The aim of this programme is to support innovative, integrated systems-based research that will lead to the identification and development of sustainable agricultural production systems in developing countries. The consortium of universities, non-government organisations, national and international agricultural research centres which are implementing this programme has adopted a Landscape Approach to Sustainability in the Tropics (LAST). The lead institution for LAST is the University of Georgia. LAST was developed with the mission to implement a comprehensive, farmer participatory, interdisciplinary research, training, and information-exchange programme for elucidating and establishing the principles of sustainable agriculture and natural resource management on a landscape scale.

The project focuses on two broad ecological zones (mega-zones): the humid tropics and the semi-arid/subhumid tropics. A landscape ecology approach is used to study the internal, external and interactive processes among ecosystems within a toposequence. These processes include the human aspect of the ecosystem in addition to biological and physical processes. The project has adopted a "farmer-back-to-farmer" model for research which includes the farmer in identification of research problems, design of potential solutions, formulation of recommendations, and the final decision on appropriateness of technology (Rhoades and Booth, 1982). In addition, gender analysis is an integral part of research design and implementation. Gender analysis is used to identify the actual user (men or women, young or old) of technology and its potential contribution to family income and effects on income use. LAST has selected watersheds in participating countries as the appropriate geographical scale in which to study the ecology of the interactions between agricultural and natural biological ecosystems.

Project design and implementation is currently underway at two research sites: the Manupali watershed on the island of Mindanao in the Philippines and a watershed which encompasses the village of Donsin in the semi-arid zone of Burkina Faso, West Africa. Project implementation occurs in three stages. The first stage consists of network building among key institutions involved in the CRSP to develop communications and collaborative relationships among the researchers and communities in the watershed. The second stage consists of a Participatory Landscape Lifescape Appraisal (PLLA)



conducted in the watershed by teams from collaborating institutions and residents of the watershed. The PLLA adopted several of the techniques developed for Rapid Rural Appraisal and Participatory Rural Appraisal for the purpose of assisting residents of the watershed and LAST researchers in the identification of key research issues in SANREM. The third stage consists of a national workshop attended by representatives of all participating institutions including farmers and other representatives of residents in the watershed. The major research themes and problems are identified at the workshop. The output is used by the National Coordinating Committee as a guideline for developing the work plans for the research programme. This process has been completed for the Philippines and is in the fourth stage for Burkina Faso.

## **Livestock in the village of Donsin**

This section illustrates the role of livestock in the LAST project by presenting relevant results of the reconnaissance PLLA conducted in the watershed (SANREM/CRSP, 1993), and results of diagnostic studies carried out by the Burkina Faso Agricultural Research Institute (CNRST/INERA), as well as other regional studies.

The watershed surrounding the village of Donsin in Burkina Faso's central plateau (100 km north-east of Ouagadougou) was selected as the SANREM/CRSP site which represents the semi-arid tropics. The area has an average annual rainfall of between 600 and 900 mm which occurs from June to September. The watershed boundaries are defined by escarpments in the south, east and west and a seasonal river in the north. The site encompasses approximately 6400 hectares. Its agricultural ecology can be described as an agrosylvopastoral farming system. The site was chosen because there is a high percentage of degraded land, the village territory encompasses an entire watershed, and non-governmental organisations and the national agricultural research system are carrying out projects in the watershed but few agricultural technologies have been introduced.

The livestock raised by farmers in Donsin include cattle, horses, donkeys, sheep, goats, chicken, guinea fowl, pigeons, ducks and pigs. The village of Donsin is estimated to have 167 cows, 640 sheep, 950 goats, 161 donkeys, 15 pigs, and almost 4000 fowl (Gnouman, 1992). The average number of animals per household was not determined, however all households raise fowl (chicken, guinea fowl and ducks), and goats and/or sheep. Wealthier households raise cattle (Gnouman, 1992). Horses are also owned by wealthier farmers but the number of horses in the village has declined in recent years; pigs were recently introduced. The use of animal traction for cultivation and transportation is low and only a few farmers use donkey carts (Gnouman, 1992). According to village elders, there are more cattle, sheep and goats in the village today than there were 30 years ago.

Livestock are used to store wealth and are frequently sold to buy food when harvests are poor. Livestock are also sold to buy items such as medicine or clothing. Donsin livestock owners sell cattle, sheep, and goats in markets outside of the village to obtain a cash income. Livestock have an important cultural role in society as they are given as gifts or consumed for weddings, baptisms and festivals. Lang (1985) studied five villages in Burkina Faso, three in the central plateau, and reported that livestock were sold for various purposes depending on village cash needs. In the village with a poor harvest in 1984, 68% of revenues from livestock sales went to purchase food items. Other important uses of revenues from livestock sales included clothing, taxes, marriages, festivals and debt payment (Lang, 1985). The importance of livestock in the cash economy of the village may be a strong incentive to increase the livestock population.

The ownership and use patterns for livestock have changed over the last 30 years. Before, only men owned livestock which were raised for consumption by the family and during cultural events. Today, both men and women own livestock. Women now raise goats and sheep for sale (Sorgho, 1992) and have total rights over chickens, goats, sheep, and cows that they purchase and/or raise themselves. However, women do not control manure from their animals. Men decide which fields are manured and these fields are usually not the women's personal fields.

During the rainy season, sheep and goats are herded by children or left tethered near household compounds to prevent crop damage (Gnouman, 1992). In the dry season, sheep and goats are allowed to roam freely in search of food during the day. Cattle are herded throughout the year because of their higher value. During the dry season, only the most valuable livestock are fed crop residues but most livestock are dependent on grazing the residues remaining on croplands and natural vegetation growing on fallow and rangelands. Livestock obtain water from seasonal ponds or streams and from wells when surface water has dried up. All wells in the village have an animal trough.

Farmers state that livestock feed is insufficient during the dry season. In a diagnostic survey, CNRST/INERA (1991) found insufficient livestock feed to be a major problem in the village. Dominant herbaceous species in Donsin's pasture lands are *Andropogon pseudapricus*; *Loudetia togoensis*, and *Schoenefeldia gracilis* (Gnouman, 1992). Zoungrana (1991) described this type of pasture as having very low productivity and extremely low nutritional value. In the past, pastures were more productive and crop residues were grazed directly in the fields; harvesting crop residues for dry season feed was unnecessary. Today, some farmers harvest and store crop residues for feeding livestock during the dry season. However, farmers indicated that the nutritive value of drought-resistant crop varieties (especially legumes) now used, is inferior to their traditional crop varieties.

A few farmers manage their livestock more intensively to obtain manure for maintaining and managing soil fertility. Most of these farmers collect manure and spread it over fields (Gnouman, 1992); however, some keep livestock corralled or tethered in their fields for direct deposition of excreta. In the past, farmers had manuring contracts with Fulani pastoralists. Farmers in Donsin traditionally spread senescent grasses along with crop residues over their fields to improve crop productivity, a practice still widely used.

In the past, Fulani pastoralists managed cattle which were owned by the Mossi. The Fulani would take these cattle to dry-season range in the southern part of Burkina Faso in exchange for grain. As is occurring elsewhere in the central plateau (Wardman and Salas, 1991), this relationship has broken down in recent years because the Mossi no longer trust the Fulani. Now, the Mossi take their own cattle to the south in search of water and pasture during the dry season. Each cattle owner guards their own cattle or entrusts them to another cattle owner from Donsin.

Farmers in Donsin allow livestock belonging to neighbouring villages to use pasture land in the Donsin watershed. This fosters good relations and also allows farmers from Donsin to access rangelands outside their village territory in years when their grazing lands have low production. Grazing corridors are also used by transhumanant pastoralists for several weeks each year.

The residents of Donsin do not share forest resources with neighboring villages. The growing scarcity of wood has forced residents of Donsin to protect their trees from being cut by non-residents who sell firewood in larger towns of the region. Farmers state that they no longer cut trees for feeding livestock, though browsed and cut trees can be observed throughout the watershed. The tree species which were used for feeding livestock include *Khaya senegalensis*, *Faidherbia albida*, *Boscia senegalensis* and *Acacia seyal*. Transhumanant pastoralists also used trees and shrubs in Donsin for feeding their cattle during the dry season. However, forestry codes enforced by the Government of Burkina Faso prevent cutting woody vegetation for feeding livestock. The inability to use trees for dry-season feeding is one of the factors forcing Fulani pastoralists out of the Donsin watershed.

## **Interdisciplinary research on the role of livestock in the Donsin watershed**

Results of the PLLA indicate that technology which strengthens the complementarity between crop and livestock production could contribute to SANREM in the Donsin watershed. Biological and social science researchers need to focus on practices that are already being used by farmers in order to understand how the farming system has evolved. Researchers must work with farmers to determine the "best bet" research and development areas to pursue. Important research issues in sustainable

agriculture and natural resource management that involve the interaction of soils, crops, forests, rangelands and livestock in the watershed are: the role of livestock in nutrient cycles and the maintenance of soil fertility; use of livestock to optimise the use of on-farm biological resources (especially crop residues); the potential conflict between livestock grazing crop residues and the direct use of residues for soil conservation and improvement of other soil characteristics; the importance of livestock in management of forest resources and the introduction of agroforestry systems for improved livestock production.

### Livestock and nutrient management

Research is needed to understand the most effective use of manure in the watershed. Diet as influenced by season will have a large effect on nutrient content, especially nitrogen and phosphorus (Powell, 1986; Somda et al, this volume). Powell (1986) found the nitrogen content of mid-dry season manure to be 0.60% dry matter (DM) as compared with 1.89% DM in the early rainy season when the nutritional value of animal diets improves. Similarly, phosphorus content was found to increase from 0.15% DM in the mid-dry season, to 0.27% early in the rainy season.

The use of fodder produced by trees in the dry season may improve the value of manure by increasing its content of nitrogen, phosphorus and other nutrients. Tannins and related phenolic compounds in browse have been shown to increase the amount of nitrogen excreted (Woodward and Reed, 1989; Reed et al, 1990). Table 1 shows the effect of proanthocyanidins on nitrogen digestibility. These compounds also increase the proportion of nitrogen in faeces as opposed to urine where it volatilises rapidly (Reed et al, 1990; Coppock and Reed, 1992; Somda et al, this volume). Storage, method and time of application may affect the amount of nutrients lost through volatilisation and leaching (Powell and Williams, 1993). Grazing ruminants harvest nutrients from uncultivated areas and concentrate nutrients in croplands where they are corralled or tethered for the accumulation of manure. This practice is widely used throughout semi-arid West Africa.

**Table 1.** Nitrogen digestibilities and contents of proanthocyanidins for nine browses.

Browse <sup>1</sup>	True nitrogen digestibility (%)	Proanthocyanidins (A550)
<i>Sesbania sesban</i> (l)	92	0.06
<i>Acacia nilotica</i> (l)	92	0.18
<i>Acacia brevispica</i> (l)	85	0.37
<i>Acacia seyal</i> (l)	85	0.30
<i>Acacia tortilis</i> (f)	81	0.31
<i>Acacia albida</i> (f)	80	0.27
<i>Acacia nilotica</i> (f)	80	0.89
<i>Acacia sieberiana</i> (f)	72	0.12
<i>Acacia cyanophylla</i> (l)	52	0.45

1. Plant parts used were leaves (l) and fruits (f).

Source: Reed et al (1990).

Research on the effects of socio-economic status and gender on access and use of manure should complement biological research on the effects of manure on soil fertility and structure. Manure is important to, and highly valued for the intensification of crop production. Fields closest to the compound receive the greatest amount and usually have high yields. However, manure may not be available to all farmers at all times of the year. Social interactions and individual decisions determine access to feed and manure resources (cf. Toulmin, 1983; Baur and Mathess, 1989; de Boer and Prins,

1989; Taylor-Powell, 1991; Loofbora, 1993). The effect of grazing area and diet on nutrient cycles in relationship to soil fertility and crop yields is a research area which requires an interdisciplinary approach.

### Crop residue management

Crop residues are used for feed, construction and mulch in the Donsin watershed. The use of crop residues is often ignored by crop improvement programmes. However, quantity and feeding value of crop residues are important criteria in a farmer's decision to grow a particular crop variety (Reed et al, 1988). Crop variety and site conditions have a large impact on residue feeding value (Reed et al, 1988). Table 2 shows varietal effects on digestibility of sorghum, millet and cowpea crop residues. Resource poor farmers have rejected new varieties that were proven successful at plant breeding centres when they realised that yield and nutritive value of the crop residue was unacceptable (Nordblom, 1988; Ceccarelli, 1993).

**Table 2.** Varietal effect on the content and digestibility of neutral-detergent fibre (NDF) in crop residues of sorghum, millet and cowpeas.

Crop residue	Range among varieties (% NDF)	Range among varieties (digestibility of NDF)	Significance of variety effect (digestibility of NDF)
<i>Sorghum (Sorghum bicolor)</i>			
Blade	58.4–61.4	49.4–67.8	***
Sheath	74.5–80.6	40.5–57.6	***
Stem	69.6–83.4	36.6–66.0	**
<i>Millet (Pennisetum typhoides)</i>			
Blade	57.7–63.0	55.7–62.2	***
Sheath	65.5–70.8	38.1–44.9	***
Stem	72.5–79.6	27.6–35.2	*
<i>Cowpea (Vigna unguiculata)</i>			
Leaves	30–33	54–66	*
Stems	47–56	37–46	*

\* P<0.05; \*\* P<0.01; \*\*\* P<0.001.

Source: Woodward and Reed (1990).

Wind erosion and crop damage from wind storms early in the growing season (wind blast) are important problems. Research has demonstrated that large amounts of whole crop residues left on the field can have a positive effect on soil characteristics (Bationo and Mokwunye, 1991). However, crop residues are also an important dry-season feed. Research is needed on the trade-off between leaving whole cereal crop residues on the field to prevent soil erosion and improve soil characteristics, versus grazing or harvesting for livestock feed.

Land tenure may also affect the use of crop residues. The access to crop residues and their end uses are affected by factors such as gender and marital status. Women do not usually farm major cash crops and therefore may not have access to the crop residues, but they may own a large number of small ruminants. Technologies intended to assist women improve sheep and goat production would need to assess the ability of women to use crop residues and other feed resources (Reed et al, 1991).

In general, livestock are allowed free access to croplands as soon as crops are harvested. If a farmer does not have adequate transportation to remove crop residues before the livestock are released, their crop residues may be grazed by livestock belonging to other farmers. Although crop residues are an important feed resource, livestock compete with many other uses such as construction, fuel and mulch. Farmers may have problems in harvesting crop residues for these alternative uses if livestock have free access to cropland after grain is harvested. Socio-economic research coupled with agronomy, animal science and soil science is needed to study crop residue management and estimate the long-term effects of its use for controlling erosion, and maximising biological production potential.

### **Forest management and agroforestry**

Poor nutrition is a major constraint to increasing livestock productivity. Feed shortages due to long dry seasons and periodic droughts limit animal productivity. The low nutritive value of feed resources also limits livestock productivity. Available grazing and crop residues are low in protein and energy, and may also be limited by mineral deficiencies. Agroforestry with multi-purpose trees (MPTs) that also provide fodder could be integrated with the farming system as another means to improve livestock productivity. *Faidherbia albida*, *Balanites aegyptiaca*, *Acacia seyal* and other native trees are already present in the Donsin watershed. These trees produce both leaves and fruits in the dry season which are utilised by livestock. Forage produced by MPTs provides protein for ruminants which can improve the nutritional value of grasses and cereal crop residues, otherwise deficient in protein (Reed et al, 1990; Coppock and Reed, 1992). MPTs are important components of the vegetation which provide feed during the dry season.

Livestock management and tenure relationships in the Donsin watershed will affect forest management and agroforestry projects. Farmers using borrowed land are often reluctant to plant trees from which they will receive no long-term benefits. Owners fear that trees planted by tenants provide the basis for strengthening tenants' long-term claims to property (Fortman, 1985).

Forest codes make it illegal for pastoralists and farmers to cut branches for livestock feeding regardless of the location of the tree. In many cases, enforcement of forest codes have a negative effect on farmers' incentives to plant trees (Lawry, 1990; McLain, 1991; Steinbarger et al, 1991) These codes have ignored the traditional use of resources and the means by which woody species were managed. They have also led to conflicts between farmers and the officials who enforce regulations. Research on the ability of trees to sustain browsing and cutting of branches for livestock feeding is required to develop more realistic management strategies for native and introduced tree species.

### **Conclusion**

Farmers in the Donsin watershed are concerned about the decline in natural resources. The standard of living of people in Donsin is heavily dependent on natural resources. The results of the PLLA indicate that the decrease in rainfall over the last 20 years has led to a decline in the standard of living. The LAST will use participatory, landscape ecology research on SANREM to assist the people of Donsin reverse this trend. The livestock production system is a key component of this process. However, component research on livestock production is unlikely to be effective in assisting Donsin farmers to improve natural resource management. The interactions among crops, livestock and natural resources are important to the maintenance and improvement of agricultural production. Research on the role of livestock in SANREM needs to take place within the context of interdisciplinary themes which focus on the human and agricultural ecology of the watershed.

### **Acknowledgements**

The PLLA was conducted by a team of SANREM/CRSP researchers from Burkina Faso and the United States in collaboration with the farmers of the village. The authors gratefully acknowledge the efforts of the team and the participation of the people from the village of Donsin.

## References

- Bationo A and Mokwunye A U. 1991. Role of manure and crop residues in alleviating soil fertility constraints to crop production: With special reference to the Sahelian and Sudanian zones of West Africa. *Fertilizer Research* 29:117–125.
- Baur H and Mathess A. 1989. Land tenure and human objectives in animal production systems of sub-Saharan Africa: Implications for development. *Quarterly Journal of International Agriculture (Germany)* 28(1):35–47.
- de Boer W F and Prins H T T. 1989. Decisions of cattle herdsmen in Burkina Faso and optimal foraging models. *Human Ecology* 17(4):445–464.
- Ceccarelli S. 1993. Plant breeding technologies relevant to developing countries. In: Gill M, Owen E, Pollott G E and Lawrence T L J (eds), *Animal production in developing countries*. BSAP Occasional Publication 16. BSAP (The British Society of Animal Production), UK. pp. 37–46.
- CNRST/INERA. 1991. *Rapport synthèse des activités RSP zone centre 1990–91*. Institut d'études et de recherches agricoles, Ouagadougou, Burkina Faso.
- Coppock L D and Reed J D. 1992. Cultivated and naive browse legumes as calf supplements in Ethiopia. *Journal of Range Management* 45:231–238.
- Fortman L. 1985. The tree tenure factor in agroforestry with particular reference to Africa. *Agroforestry Systems* 2:229–251.
- Gnouman B. 1992. Systèmes d'élevage et espaces pâtures dans les villages de Tiougou et Donsin: identification et caractérisation. Document de travail #20. INERA/RSP.
- Gryseels G and Getachew Asamenew. 1985. Links between livestock and crop production in the Ethiopian highlands. *ILCA Newsletter* 4(2):5–6. ILCA (International Livestock Centre for Africa), Addis Ababa, Ethiopia.
- Lang M. 1985. *Crop and livestock marketing patterns in Burkina-Faso*. 84–5, Purdue University Farming Systems Unit, International Programs in Agriculture, Purdue University, West Lafayette, Indiana, USA.
- Lawry S. 1990. Tenure policy towards common property natural resources in sub-Saharan Africa. *Natural Resources Journal* 30:403–422.
- Loofboro L. 1993. *Tenure relations in three agropastoral villages: A framework for analyzing natural resource use and environmental change in the arrondissement of Boboye*. Preliminary Report. Draft Discussion Paper 2. Land Tenure Center, Madison, Wisconsin, USA. 32 pp.
- McDowell R E. 1977a. *Are U. S. animal scientists prepared to help small farmers in developing countries?* Cornell International Agriculture Mimeograph 58. Cornell University, Ithaca, New York, USA. 25 pp.
- McDowell R E. 1977b. *Ruminant products: More than meat and milk*. Winrock Report. Winrock International Livestock Research and Training Center, Petit Jean Mountain, Morrilton, Arkansas, USA. 27 pp.
- McIntire J, Bourzat D and P Pingali. 1992. *Crop–livestock interaction in sub-Saharan Africa*. The World Bank, Washington DC, USA. 246 pp.
- McLain R. 1991. *Community woodlot study*. Land Tenure Center Report 5. University of Wisconsin, Madison, USA.
- Nordblom T L. 1988. The importance of crop residues as feed resources in West Asia and North Africa. In: Reed J D, Capper B S and Neate P J H (eds), *Plant breeding and the nutritive value of crop residues*. Proceedings of a workshop held at ILCA, Addis Ababa, Ethiopia, 7–10 December 1987. ILCA (International Livestock Centre for Africa), Addis Ababa, Ethiopia. pp. 41–64.
- NRC (National Research Council). 1991. *Toward sustainability*. National Academy Press, Washington, DC, USA. 147 pp.
- Powell J M. 1986. Manure for cropping: A case study from central Nigeria. *Experimental Agriculture* 22:15–24.
- Powell J M and Williams T O. 1993. *Livestock, nutrient cycling and sustainable agriculture in the West African Sahel*. Gatekeeper Series SA37. IIED (International Institute for Environment and Development), London, UK. 15 pp.

- Reed J D. 1988. Improving livestock productivity by strengthening crop/livestock interactions in small holder farming systems in Africa. In: Stone J C (ed), *The exploitation of animals in Africa*. Aberdeen University African Studies Group, Aberdeen, Scotland. pp. 71–79.
- Reed J D, Capper B S and Neate P J H (eds). 1988. *Plant breeding and the nutritive value of crop residues*. Proceedings of a workshop held at ILCA, Addis Ababa, Ethiopia, 7–10 December 1987. ILCA (International Livestock Centre for Africa), Addis Ababa, Ethiopia. 334 pp.
- Reed J D, Soller H and Woodward A. 1990. Fodder tree and straw diets for sheep: Intake, growth, digestibility, and the effects of phenolics on nitrogen utilization. *Animal Feed Science and Technology* 30:39–50.
- Reed J D, Njie M, Touray E M and Torrence E B. 1991. *Nutritive value and use of locally available feed resources for sheep*. Paper presented at the PVO and University Communities Workshop Small Ruminant Production: Systems for Sustainability. University of Maryland, 20–21 June 1991. University of Maryland, College Park, Maryland, USA.
- Rhoades R E and Booth R H. 1982. Farmer-back-to-farmer: A model generating acceptable agricultural technology. *Agricultural Administration* 11:127–137.
- SANREM/CRSP. 1993. Rapport de synthèse: résultats de la M.A.R.P. dans le village de Donsin du 23 au 27 avril 1993. SANREM/CRSP, Griffen, Georgia. 35 pp. (unpublished)
- Sorgho M C. 1992. Dimensions socio-économiques de la femme en milieu rural dans le plateau central du Burkina Faso. (Socio-economic dimensions of women in a rural setting in the Central Plateau of Burkina Faso). Mémoire de DEA, Département de sociologie. Ministère de l'enseignement supérieur et de la recherche scientifique.
- Steinbarger D M, Diop B, Lu H and McLain R. 1991. *Senegal reforestation project: Report on tree use rights and the potential impact of the proposed forestry code*. USAID Project 685–0283. USAID (United States Agency for International Development), Senegal.
- Taylor-Powell E. 1991. *Integrated management of agricultural watersheds: Land tenure and indigenous knowledge of soil and crop management*. Tropsoils Bulletin 91–04. Tropsoils CRSP, North Carolina State University, Raleigh, North Carolina, USA.
- Toulmin C. 1983. *Herders and farmers or farmer-herders and herder-farmers?* Pastoral Network Paper 15d. ODI (Overseas Development Institute), London, UK.
- USDA (United States Department of Agriculture). 1994. *National research initiative on competitive grants program: Program description*. Part 2. USDA, Washington, DC, USA. 11 pp.
- Wardman A and Salas L G. 1991. The implementation of anti-erosional techniques in the Sahel: A case study from Kaya, Burkina Faso. *Journal of Developing Areas* 26:65–80.
- Woodward A and Reed J D. 1989. The influence of polyphenolics on the nutritive value of browse: A summary of research conducted at ILCA. *ILCA Bulletin* 35:2–11. ILCA (International Livestock Centre for Africa), Addis Ababa, Ethiopia.
- Zoungrana I. 1991. Recherches sur les aires pâturées du Burkina Faso. L'Université de Bordeaux III – Docteur es science naturelles. PhD thesis.

# **Modelling nutrient cycles in plant/animal/soil systems**



# Modélisation et simulation dans l'élaboration de systèmes de production animale durables

H. Breman

Projet Production soudano-sahélienne (PSS), AB-DLO, B.P. 14, 6700 AA Wageningen (Pays-Bas)

## Résumé

Différentes approches de la modélisation des cycles des éléments nutritifs dans le système plante-animal-sol ont été présentées. Un inventaire (incomplet) des approches et des modèles disponibles a été effectué. L'utilisation pratique a été analysée et les raisons de l'utilisation restreinte actuelle ont été examinées. Plusieurs causes ont été identifiées: la formation nécessaire est quasi absente, la fiabilité laisse souvent à désirer et il est difficile pour des personnes extérieures de juger des limites de l'applicabilité et donc de la validité des résultats. Des causes bien plus difficiles à corriger pourraient être l'attitude négative face aux modèles et la méfiance vis-à-vis des résultats indésirables. L'utilisation restreinte n'implique heureusement pas que la modélisation et la simulation soient totalement ignorées en Afrique. L'approche systémique a contribué de façon notable à des changements stratégiques dans le domaine du développement rural. Il s'agit de l'attention accrue pour la fertilité des sols, la gestion des ressources naturelles et l'alimentation du bétail. Ensuite l'approche et la philosophie du projet «Production soudano-sahélienne — Exploitation optimale des éléments nutritifs en élevage (PSS)» ont été présentées pour souligner l'importance vitale de la modélisation et de la simulation pour l'élaboration de systèmes de production animale durables. Ce projet de collaboration scientifique entre le Mali et les Pays-Bas analyse la possibilité d'intensifier l'agriculture soudano-sahélienne par l'introduction d'engrais chimiques pour améliorer la production fourragère. L'approche systémique est indispensable pour une telle analyse: la valeur des essais est restreinte dans un environnement en mutation caractérisé par la surexploitation; des essais de longue durée sont indispensables pour déterminer les taux de réponse optimums des engrais sur sol pauvre; il faut du temps pour démontrer l'efficacité de l'intégration de l'agriculture biologique et intensive; la synergie de l'intégration est difficile à estimer de tête; un trop grand nombre de paramètres influencent la rentabilité de la supplémentation du bétail; les options les plus prometteuses peuvent être sélectionnées par simulation.

## Modelling and simulation in the development of sustainable animal production systems

H. Breman

AB-DLO, BP 14, 6700 AA Wageningen, The Netherlands

## Abstract

*Various approaches to nutrient-cycle modelling in the plant-animal-soil system were presented. An (incomplete) inventory of available approaches and models was carried out. Their practical utilisation was then analysed and the problem of their limited use was discussed. Several causes for this limited use were identified including lack of adequate training, low level of reliability and problems encountered by third parties seeking to assess their applicability and hence their validity. Some causes are much more difficult to address including the negative attitude towards models and suspicion with regard to undesirable results. Fortunately, limited use does not mean that modelling and simulation are totally absent in Africa. The systems approach has largely contributed to strategic changes in rural development, including increased concern for soil fertility, natural resource management and livestock nutrition. The approach and philosophy of «Production Soudano-Sahélienne Project –*

*Exploitation optimale des éléments nutritifs en élevage (PSS)» were also presented to underline the need for modelling and simulation in developing sustainable animal production systems. This scientific collaboration project between Mali and The Netherlands examines the feasibility of intensifying Soudano-Sahelian agriculture through introduction of chemical fertilisers for improved forage production. A systems approach is essential for such an analysis because: the value of trials is limited in a changing environment characterised by overexploitation; long-term trials are necessary to determine the optimal rate of response of fertilisers on poor soils; time is needed to establish the efficiency of the integration of biological and intensive agriculture; synergism of integration is difficult to assess mentally; too many parameters affect the cost efficiency of livestock supplementation; and the most promising options can be selected using simulation.*

## **Introduction**

De tout temps, l'homme a extrapolé les connaissances locales pour se faire une idée des situations prévalant ailleurs. La modélisation agricole a été amorcée quand il s'est prononcé sur le potentiel et les contraintes en un lieu et à un moment donnés, en se basant sur des rapports empiriques établis.

La modélisation et la simulation ont pu être élaborées grâce à une meilleure connaissance des processus agro-écologiques et au développement de l'informatique. Toute une gamme de modèles est disponible actuellement pour réduire le tâtonnement dans la recherche et ses applications, mais leur efficacité est liée à leur qualité et à la connaissance de leurs paramètres. Un aperçu des modèles, de leur utilisation et des résultats enregistrés est présenté dans cette étude. Une attention particulière est portée à la faisabilité de l'utilisation des engrais pour intensifier l'élevage dans les pays sahéliens.

## **Aperçu des modèles et de leur utilisation en Afrique**

### **Aperçu historique**

#### **Production végétale**

C'est à De Wit que nous devons les concepts de modélisation et de simulation agricoles.

Une de ses premières expériences de la modélisation concerne l'analyse des facteurs agricoles limitants dans le nord du désert du Néguev au début des années soixante-dix. Une conclusion importante de cette analyse est que la pauvreté des sols y est bien plus limitante pour l'agriculture que le déficit en eau (De Wit, 1975; Van Keulen *et al.*, 1976). A l'occasion du premier séminaire du CIPEA, Penning de Vries et Van Heemst (1975) ont employé le modèle développé pour estimer la production potentielle des terrains de parcours sahéliens. Ils ont estimé que la production aérienne annuelle serait de 4 000 kg/ha de matière sèche pour une pluviosité de 270 mm/an si la pauvreté du sol pouvait être corrigée. A 540 mm/an, la production potentielle serait de 5 000 à 9 000 kg/ha. Pour vérifier cette conclusion, Diarra (1976) fertilise une parcelle sur parcours naturel avec de l'azote et du phosphore. Il obtient une récolte de 5 600 kg/ha avec une pluviosité annuelle proche de 500 mm, contre 2 000 kg/ha sans fertilisation.

L'interaction entre les recherches sur le terrain et la modélisation montre clairement qu'au Sahel aussi, la pauvreté du sol est en général un facteur bien plus limitant que le déficit en eau: la végétation n'utilise en moyenne que 10 à 20% de l'eau de pluie. Environ 60% disparaît par évaporation et 25% par ruissellement. A la fin de la saison de croissance, on trouve encore jusqu'à 20% de l'eau de pluie dans le sol, à la portée des racines. En d'autres termes, ce n'est pas toujours un manque d'eau qui limite la croissance végétale. Avec un apport suffisant d'azote et de phosphore dans la partie sud du Sahel, la production fourragère pourrait être quintuplée avec la pluviosité moyenne et la végétation utiliserait effectivement 50% de l'eau de pluie.

Des modèles de simulation de trois niveaux de production ont été élaborés (Penning de Vries, 1982). Il s'agit de la production potentielle (non limitée par la disponibilité d'eau ni des éléments

nutritifs), de la production limitée uniquement par la disponibilité naturelle d'eau et de la production actuelle, limitée par l'azote, le phosphore et l'eau dans les pays sahéliens. Les comparaisons des simulations avec la production observée ont beaucoup aidé à mieux comprendre les problèmes et le comportement des éleveurs et des paysans de la région. La limitation de la production par la pauvreté du sol justifie en grande partie la médiocre qualité des pâturages, sauf en bordure du Sahara, où l'eau est encore plus limitante que les éléments nutritifs. La transhumance, le système d'élevage prédominant dans la région, tire le meilleur parti du fourrage de bonne qualité existant dans le nord pendant la saison des pluies. En saison sèche, le bétail est maintenu près des points d'eau permanents du sud du Sahel ou dans la savane soudanienne. En termes de production de protéines animales par unité de surface, cette forme d'élevage est au moins aussi productive que le ranching pratiqué dans des régions à pluviométrie comparable aux Etats-Unis et en Australie (Breman et De Wit, 1983).

Ce ne sont pas la disponibilité en eau d'abreuvement, la situation sanitaire et le potentiel génétique du bétail qui déterminent en premier lieu le niveau de production animale dans la plupart des pays sahéliens, mais plutôt la capacité de charge restreinte, dépassée dans le Sahel méridional ainsi que dans de nombreuses autres régions du Sahel et de la savane soudanienne. Les effectifs animaux sont directement liés à l'importance de la population qui en vit directement ou indirectement. Le surpâturage est une conséquence d'une agriculture minière obligée de compenser la baisse des rendements par une extension rapide des surfaces cultivées par une population sans cesse plus nombreuse. La jachère est raccourcie ou abandonnée, l'épuisement des sols progresse. Cette situation est favorisée par un régime foncier écartelé entre une législation vague et éloignée des réalités, et une tradition encore vivante mais en perte de vitesse (Breman *et al.*, 1990). Une telle analyse conduit à la conclusion selon laquelle le principal remède pour l'agriculture de la région est l'augmentation des rendements par l'apport d'intrants d'origine externe. Cela requiert un changement profond des stratégies macro-économiques en raison des rapports coûts-avantages de ces intrants, et un arrêt des pratiques du dumping des produits agricoles pratiqué sur le marché mondial par les pays riches (Van Keulen et Breman, 1990; Wooning, 1992).

Les connaissances acquises dans le cadre du projet Production soudano-sahélienne (PPS) ont permis d'élaborer le *Manuel sur les pâturages des pays sahéliens* (Breman et de Ridder, 1991). Ce manuel permet, à partir de modèles élaborés pour le Sahel et la savane soudanienne, d'estimer le potentiel de l'élevage dans une région donnée, et d'identifier les contraintes de la production fourragère et animale.

## **Production animale**

Ce manuel exploite la modélisation de la production primaire et secondaire. Le lien entre ces deux paramètres, la qualité et la quantité du fourrage ingéré ont été étudiés par Ketelaars (1991) qui a également élaboré un modèle simple permettant de déduire de cette ingestion la croissance d'effectifs et la production de viande et de lait d'un troupeau bovin. D'autres l'ont précédé dans ce domaine: Van Dyne et Abramsky (1975) présentent un aperçu des modèles appliqués aux pâturages disponibles. Christian *et al.* (1978), jugeant ces modèles trop simples pour être utilisés comme outils pratiques de gestion, ont élaboré leur propre modèle pour mieux gérer la production d'agneaux sur les pâturages artificiels des régions tempérées d'Australie. Un objectif bien différent, à savoir la compréhension de l'économie pastorale, a amené Dahl et Hjort (1976) à faire la synthèse des connaissances disponibles dans des modèles empiriques de la dynamique et de la production de troupeaux camelins, bovins, ovins et caprins. Les systèmes pastoraux de l'Afrique de l'Est constituent leur principale base de données.

Le CIPEA réalise tôt l'utilité de la modélisation pour la recherche sur les systèmes de production animale en Afrique (Anderson et Trail, 1978), la considérant comme un outil d'appui pour les choix stratégiques dans l'allocation des ressources. Deux situations se présentaient comme prioritaires: la synthèse des nombreuses données, recueillies au cours d'une longue période de temps et l'analyse d'une banque de donnée réduite. Un exemple de l'approche système à travers la modélisation dans le premier cas est l'application par le CIPEA au Botswana du modèle de la production bovine de

l'Université du Texas (CIPEA, 1982). L'utilité de ce modèle a été démontrée par la simulation des options de production, comme le changement de l'âge de sevrage et l'introduction de fourrage de *Leucaena leucocephala* comme aliment complémentaire de saison sèche.

Cela a conduit Konandreas et Anderson (1982) à élaborer un autre modèle, bien que celui de l'Université du Texas leur semblait le meilleur disponible. Fondé sur des processus biologiques, ce modèle permet de faire des calculs avec des intervalles d'un mois. Une amélioration importante concerne le traitement des animaux simulés comme entités individuelles. La productivité du troupeau est simulée dans le temps, comme fonction de l'alimentation actuelle et passée, et en rapport avec le système de gestion. Certaines composantes du modèle sont stochastiques, reflétant la connaissance restreinte des processus impliqués. La situation fourragère, par exemple, est incorporée comme un ensemble de variable stochastique, au lieu d'être simulée par le modèle même. Le modèle a été utilisé entre autres pour évaluer la productivité de l'élevage malien dans le cadre du deuxième type d'application, c'est-à-dire celui d'une situation caractérisée par la rareté des données (De Leeuw et Konandreas, 1982).

De 1980 à 1986, le CIPEA et le CABO-DLO ont collaboré pour essayer de combiner des modèles qu'ils élaboraient respectivement sur la production secondaire et primaire. Cette idée a cependant été abandonnée. On a jugé plus utile d'utiliser les résultats d'un modèle comme générateur de données pour un autre, approche utilisée pour la simulation des systèmes d'élevage de l'Afrique de l'Est par Sullivan *et al.* (1981). La modélisation de l'ingestion de fourrage a occupé une large place dans les travaux de l'atelier de clôture de la collaboration. Un autre point particulier concernait la modélisation en rapport avec la gestion et l'économie des systèmes de production animale. Il s'agissait notamment d'une contribution des chercheurs israéliens, partenaires de la première heure de la modélisation de De Wit. Le compte rendu de l'atelier présente ainsi une bonne vue d'ensemble de la modélisation des systèmes extensifs de production animale (De Ridder *et al.*, 1986). Plus récent, mais couvrant un domaine plus large, l'ouvrage *Food from dry lands. An integrated approach to planning of agricultural development* (Alberda *et al.*, 1992), premier volume d'une nouvelle série: *Systems approaches for sustainable agricultural development*.

## Aperçu général

### Sélection de modèles

Il est difficile de présenter un aperçu de tous les modèles susceptibles d'intéresser ceux qui s'occupent de la viabilité des systèmes mixtes agriculture-élevage en Afrique subsaharienne. C'est pour cela que l'aperçu historique est complété par une sélection arbitraire de modèles divers, permettant de présenter certaines réflexions sur l'approche par modélisation. A côté de modèles relativement complexes, pour lesquels on recourt en général à un ordinateur, quelques modèles statistiques relativement simples mais utiles seront présentés. Ils sont marqués d'un astérisque dans le tableau 1.

### Niveau de détail

Les modèles diffèrent énormément en terme de complexité, et on pourrait penser que cela est lié à l'ampleur des phénomènes à simuler. Ce n'est là qu'une demi-vérité. Il est vrai que les deux derniers modèles du tableau, relatifs à la socio-économie et à l'agro-écologie des systèmes entiers, sont les plus complexes des modèles présentés. Mais le modèle GRASMOD (Van de Ven, 1992), par exemple, qui vise à optimiser la production fourragère et l'utilisation du fumier en tenant compte des objectifs agronomiques, économiques et environnementaux des éleveurs et de la société, n'est pas plus complexe que le modèle de la dynamique de la matière organique du sol (Verberne *et al.*, 1990).

L'objectif des modèles en détermine souvent le niveau de complexité (Spitters, 1990). Des modèles permettant de se prononcer sur une situation donnée sont en général plus simples que ceux servant à identifier des options techniques, des stratégies destinées à changer une situation. C'est ainsi que le modèle GRASMOD est bien plus complexe que celui qui sert à évaluer le degré d'épuisement

des sols par les cultures en Afrique (Stoorvogel et Smaling, 1990). On constate, après l'utilisation de ce dernier modèle pour 38 pays, que dans presque tous les cas la perte annuelle par hectare cultivé s'élève à plus de 10 kg d'azote, de 4 kg de P<sub>2</sub>O<sub>5</sub> et de 10 kg de K<sub>2</sub>O, mais le modèle ne propose aucune solution à ce problème. De la même manière, le modèle simple de Ketelaars (1991) permet de se prononcer sur la production bovine pour une situation fourragère donnée, particulièrement pour les jeunes animaux sevrés, mais aussi globalement pour l'ensemble du troupeau. Mais le modèle complexe du CIPEA (Konandreas et Anderson, 1982) est mieux adapté à la détermination d'autres options de systèmes de production.

**Tableau 1** Sélection de modèles utiles pour l'étude de la viabilité des systèmes mixtes agriculture-élevage

Nom	Sujet	Auteur(s)	Année	Exemple d'utilisation
<i>Sol</i>				
QUEFTS	disponibilité d'éléments nutritifs	Janssen <i>et al.</i>	1990	production de maïs, Kenya
NUREQ	bilan d'éléments nutritifs	Van Duivenbooden	1992	Planification d'utilisation de terres, Mali
X	bilan d'éléments nutritifs	Stoorvogel et Smaling	1990	évaluation épuisement des sols en Afrique
X	dynamique matière organique	Verberne <i>et al.</i>	1990	optimisation utilisation d'engrais, Mali
X	optimisation d'engrais	Wolf <i>et al.</i>	1987; 1989	enrichissement de jachères
SCUAF	agroforesterie et dynamique de sol	Young et Muraya	1990	culture mixte maïs <i>Leucaena</i>
<i>Bilan d'eau</i>				
WEATHER	module de climat	Van Kraalingen <i>et al.</i>	1991	production terrain de parcours sahéliens
SARRA	bilan d'eau cultures	Clopes <i>et al.</i>	1993	risques agroclimatiques sahéliens
<i>Production végétale</i>				
SUCROS	production potentielle et production limitée par eau	Spitters <i>et al.</i>	1989	production potentielle terrain de parcours sahéliens
PAPRAN	production limitée par eau et par azote	Seligman et Van Keulen	1981	terrain de parcours zone semi-aride
X*	compétition entre espèces	Kroff et Van Laar	1993	compétition céréales et mauvaises herbes
FORGO	dynamique forestière	Mohren <i>et al.</i>	1993	forêt pays tempérés
<i>Production cultures</i>				
WOFOST	potentiel de production	Van Diepen <i>et al.</i>	1988	cultures au Burkina
DSSAT	stratégie de gestion	Anonyme	1989	cultures tropicales et tempérées
<i>Alimentation animale</i>				
X	paître: ingestion quantitative et qualitative	Ungar et Noy-Meir	1986	désert du Néguev
MIAMH	choix alimentaires ruminants	Genin	1991	caprins, Mexique
X	ingestion et digestibilité	Zemmelink	1980	moutons, Colombie
X	digestibilité, taux d'azote et ingestion	Ketelaars	1991	bovins sahéliens
<i>Production animale</i>				
X	gestion d'élevage	Konandreas et Anderson	1982	élevage africain
X	évaluation potentiel d'élevage	Ketelaars	1991	élevage bovin sahélien
X	traction bovine	Van der Lee <i>et al.</i>	1993	systèmes mixtes, Asie tropicale
X	pluviosité et capacité de charge	Vossen	1990	élevage bovin, Botswana
<i>Systèmes de production</i>				
GRASMOD	optimisation systèmes de production	Van de Ven	1992	élevage viable néerlandais
X	systèmes d'élevage	Sullivan <i>et al.</i>	1981	Afrique de l'Est
X	développement rural	Struif Bontkes	1992	région de Bor, Soudan
MALIS	planification d'utilisation de terres	Veeneklaas	1990	région de Mopti, Mali

\* modèles statistiques

Les modèles simples ne procèdent pas nécessairement de modèles plus complexes. Le cas contraire se présente en effet fréquemment: une connaissance approfondie permet de simplifier certaines situations; les modèles détaillés et complexes sont remplacés par des modèles récapitulatifs. *Le manuel pour l'évaluation des terrains de parcours sahéliens* (Breman et De Ridder, 1991) en est un exemple. Cependant certains champs de connaissance sont parfois considérés comme secondaires par rapport à l'objectif visé à travers la modélisation et la simulation. C'est ainsi que le modèle SARRA (Clopes *et al.*, 1993), élaboré pour quantifier les risques agroclimatiques, permet de calculer l'utilisation d'eau par les cultures avec un indicateur simple, et donc de se prononcer également sur les rendements attendus. La valeur de l'indicateur dépend de la culture considérée, du climat et de la fertilité du sol. Dans les modèles de production primaire comme SUCROS et WOFOST, et ceux inclus dans DSSAT, il faut disposer d'un jeu de données bien plus étendu pour pouvoir se prononcer sur la production végétale.

### "Fonction de forçage", modules et submodules

Vossen (1990) arrive à expliquer 93% de la variation interannuelle de la mortalité de bovins au Botswana au cours de la période 1977-1986 par un simple modèle statistique, décrivant la relation entre la pluviosité, l'évaporation potentielle et un indice de performances du bétail. Ici, la relation fondée sur l'empirisme permet d'éviter des modèles complexes; cependant cette relation n'a qu'une valeur locale indissociable de son époque. Il en va de même pour l'indicateur de l'utilisation d'eau par les cultures du modèle SARRA mentionné ci-dessus, et pour la relation pluviosité-capacité de charge établie par l'auteur (Breman, 1975). Le manque de choix et la précision de l'estimation de la mortalité du bétail au Mali par suite de la sécheresse du début des années soixante-dix ont par exemple amené la FAO à utiliser la relation pour estimer le potentiel d'élevage des pays sahéliens. Grâce aux travaux du projet PPS (Penning de Vries et Djitéye, 1991) on sait aujourd'hui que la précision de l'estimation de la mortalité n'était due qu'à un heureux hasard: c'est la pauvreté du sol et non la disponibilité en eau qui constitue le facteur limitant pour la production fourragère de la région. La qualité du fourrage est ainsi bien plus limitante que sa disponibilité, ce qui apparaît dans la méthode proposée pour l'estimation de la capacité de charge (Breman et De Ridder, 1991). Mais dans une année aussi sèche que 1973-1974 au Mali, la production fourragère du vrai Sahel était surtout limitée par l'eau (qualité fourragère élevée), alors que le centre de gravité de l'élevage malien se trouvait encore dans le Nord!

Il convient donc d'avoir conscience de la portée de l'introduction dans un modèle, comme "fonctions de forçage", de connaissances empiriques et des résultats de modèles statistiques. En fait, cela est inévitable, et les utilisateurs devraient en tenir compte régulièrement. Pour certains objectifs et situations, on peut évaluer l'ingestion fourragère par la simple formule 6,25 kg/UBT/jour. Mais pour estimer par exemple la production animale de la savane soudanienne, dominée par des graminées annuelles, on commet de graves erreurs avec une telle simplification. Pour que les bovins ingèrent quotidiennement une telle quantité d'aliment et arrivent à bien produire, il faut un fourrage ayant un taux d'azote de l'ordre de 16 g/kg à une digestibilité de 65%. C'est seulement pendant deux mois par an que les terres de parcours offrent un fourrage d'une telle qualité. Et pendant sept mois, la qualité ne permet qu'une ingestion maximale de 4 kg/UBT/jour; or une UBT perd presque un demi-kilo de poids vif par jour si le bétail n'a pas accès à un supplément de très bonne qualité après avoir sélectionné 20% des meilleures parties du fourrage (Breman et De Ridder, 1991).

Plusieurs possibilités permettent d'obtenir une meilleure simulation de la production animale. On fait varier la quantité et la qualité du fourrage ingéré par mois ou durant des périodes de temps plus courtes; un tableau avec des valeurs fixes est incorporé comme fonction de forçage. Des mesures périodiques peuvent servir comme sources des données en question. Pour l'ingestion elle-même, la simulation ne sera valable que pour la situation fourragère en question, déterminée par les caractéristiques et l'état du sol, le climat et le temps, le troupeau et l'exploitation du parcours. En d'autres termes, la valeur des résultats de la simulation dépendra de l'universalité de la situation

fourragère. Et le modèle ne présente pas d'intérêt pour l'analyse du potentiel de changement de cette situation pour la production animale.

Les perspectives sont meilleures cependant lorsque la situation fourragère elle-même devient la fonction de forçage. Le modèle doit être élargi dans ce cas avec un module permettant de dériver l'ingestion à l'aide de modèles restreints comme ceux de Zimmelink (1980), Genin (1991) et Ketelaars (1991). Il devient possible ainsi de se prononcer sur l'influence des variations climatiques, de l'aménagement du parcours, de la complémentation et de la gestion du troupeau; chaque situation exigeant son propre tableau de l'évolution de la situation fourragère au cours de l'année.

Mais les trois dernières sources de variations concernent des interventions humaines contrôlées, dont on voudrait connaître l'influence malgré les variations climatiques incontrôlables. On intègre un jeu de données climatiques réel comme fonction de forçage et on fait calculer la situation fourragère par un ou plusieurs modules supplémentaires, en profitant de l'étude et des modèles du projet Production primaire sahélienne (PPS) (Penning de Vries et Djitéye, 1991; Breman et De Ridder, 1991).

L'applicabilité d'un modèle, et donc la valeur des résultats de la simulation s'améliore en principe chaque fois qu'on remplace une fonction de forçage par un module de simulation. Les résultats deviennent alors plus universels et le modèle de plus en plus analytique au lieu d'être descriptif. L'amélioration ne sera cependant qu'apparente si la connaissance est insuffisante pour faire un module satisfaisant des processus concernés, ou si les valeurs numériques des paramètres utilisés ne sont pas assez précises. Ainsi, Nonhebel (1993) montre la conséquence des imprécisions des données météorologiques sur les résultats des simulations de la production agricole. Des différences entre les conditions aux champs et celles mesurées par les postes météorologiques entraînent facilement des écarts de plus ou moins 10% entre la simulation de la production limitée par l'eau et la production réelle. Des écarts pouvant aller jusqu'à 30% sont mis en évidence lorsqu'on remplace des données météorologiques manquantes par des valeurs moyennes. Pour la production fourragère actuelle des pays sahéliens, l'influence pourrait être moindre, car elle est notamment limitée par le déficit en N et P. Mais les conditions climatiques influencent aussi directement la production animale et on peut se demander si cette influence est suffisamment prise en compte dans les modules de la production animale.

Pour juger de l'utilité d'un modèle pour une situation et une question données, il est ainsi indispensable de se demander quels processus ont été décrits avec quelle précision, et quels sont ceux représentés par des fonctions de forçage. Pour leur part, les chercheurs du groupe CABO/TPE à Wageningen, qui ont élaboré des modèles comme SUCROS, estiment que l'IBSNAT, l'autre grand groupe de modélisateurs (auteurs par exemple de DSSAT), sacrifie la clarté nécessaire des modèles à leur accessibilité aux utilisateurs: à leur avis, ces modèles contiennent trop de "black boxes". La collaboration des deux groupes (ICASA, 1993) devrait permettre d'aboutir à des modèles alliant clarté et accessibilité.

Un aspect crucial dans ce cadre est d'éviter que les modèles deviennent trop grands, représentant trop de processus à la fois. Souvent, il sera plus pratique de travailler plutôt avec deux ou plusieurs submodèles, comme l'a conclu la collaboration CIPEA-CABO mentionnée plus haut. Les résultats d'un submodèle entrent dans ce cas comme fonctions de forçage. De cette façon, on peut analyser à part des rapports tels que ceux entre climat et situation fourragère et entre situation fourragère et production animale; mais aussi les rapports entre climat, conditions pédologiques et productions végétales. C'est ainsi que le projet PPS a pu identifier l'importance relative de l'influence de la disponibilité en eau, en N et en P sur la production des pâturages sahéliens. Des modèles à part ont été utilisés pour la production potentielle et la production uniquement limitée par la pluviométrie, et les résultats de simulation ont été confrontés avec la production réelle.

## Interfaces

L'utilisation des submodèles permet des simulations en travers des interfaces. Ces dernières exigent donc une attention particulière, ainsi celle entre sol et plante, plante et animal, et animal et sol. Il ne suffit pas de connaître la quantité de N, de P, etc. disponible dans le sol à une pluviosité donnée pour la production végétale, ou la quantité de fourrage que produit une terre de parcours. Il faut connaître les conséquences de l'utilisation des éléments nutritifs et du fourrage sur l'offre à long terme, car la durabilité des systèmes de production doit être assurée.

Le projet d'appui pour la planification de l'utilisation des terres dans la région de Mopti (Mali) a trouvé une solution élégante (Van Duivenbooden et Gosseye, 1990). Le niveau réel des productions a été défini à partir de statistiques agricoles. Des modèles comparables à WOFOST ont servi à simuler la production de diverses cultures limitée par l'eau, en situation d'accès libre aux engrais chimiques. Pour les deux cas, le modèle NUREQ a été employé pour déterminer la quantité de N, de P et de K à apporter annuellement pour assurer le maintien du bilan de ces éléments. Les modèles de Wolf *et al.* (1987 et 1989) ont une application plus universelle dans le cas de cultures fertilisées.

## Niveaux de production

Il est relativement aisé de modéliser la production végétale potentielle et celle limitée par l'eau. Dans le premier cas, le déficit en eau est comblé par irrigation, et des engrais corrigent les effets de la pauvreté naturelle du sol. Dans le deuxième cas, la pluie est la seule source d'eau pour les cultures, mais les déficits en éléments nutritifs sont comblés (SUCROS et WOFOST). La connaissance de la dynamique des éléments nutritifs est trop restreinte pour bien simuler la production primaire réelle. L'utilité des modèles existants (par exemple PAPRAN) reste limitée; ils décrivent la situation d'un endroit ou d'une région donnés. Il s'agit en général ou bien de la situation moyenne, ou de la situation d'une année donnée. L'obligation d'utiliser des connaissances empiriques pour les relations entre les facteurs climatiques et la disponibilité des éléments nutritifs (ou directement la production) donne à de tels modèles une valeur restreinte. Ils permettent néanmoins de savoir si la situation réelle est bien comprise.

Les modèles de la production potentielle et de la production limitée par l'eau sont plus utiles, notamment pour la recherche prospective. La quantification des écarts entre la réalité et les possibilités théoriques permet d'estimer la satisfaction des besoins, la rentabilité des investissements éventuels, etc.

## Compétition

Dans la pratique, il existera en général un écart entre les niveaux théoriques simulés de la production potentielle ou de la production limitée par l'eau et ceux réalisés dans la réalité, bien que la disponibilité en eau et/ou en éléments nutritifs ait été suffisante. Cela est dû à l'effet sur les cultures des maladies et des ravageurs, lesquels entrent en compétition pour les facteurs de croissance. C'était exactement un tel écart entre la production théorique de blé limitée par l'eau, simulée par De Wit (1965), et la réalité paysanne des années soixante-dix aux Pays-Bas, qui a mené à la découverte des maladies de maturation du blé. Les remèdes développés par la suite ont permis d'augmenter le rendement de 8 à 10 t/ha.

Une autre forme de compétition, bien plus générale, est celle entre les cultures et les adventices; la disponibilité en eau, en éléments nutritifs et en lumière risque de beaucoup baisser en absence d'actions adéquates. Kropff et Van Laar (1993) présentent une vue d'ensemble de la modélisation de cette compétition. Spitters (1980) l'a modélisée dans sa simulation de la dynamique d'une végétation sahéenne. De tels modèles et les connaissances qui en sont à la base sont indispensables pour évaluer la plus-value des cultures mixtes. Celles-ci, y compris l'agro-sylvo-pastoralisme, sont souvent proposées pour optimiser l'utilisation des ressources naturelles et exogènes. La plus-value devient notamment intéressante si elle dépasse les conséquences négatives de la compétition pour les mêmes



ressources. Un exemple simple de ce genre de modélisation concerne la compétition pour les éléments nutritifs entre une espèce herbacée et une espèce ligneuse d'un parcours naturel aux Pays-Bas (Berendse et Elberse, 1989). La compétition en question et la dynamique de la végétation qui s'ensuit va de pair avec la dynamique de la matière organique du sol. Cela est aussi un élément clef de SCUAF, un modèle d'agroforesterie et de la dynamique du sol (Young et Muraya, 1990). Breman et De Ridder (1991) utilisent des modèles très simples de la dynamique de la composante azotée de la matière organique du sol pour estimer la production herbacée sahélienne en rapport avec le recouvrement de la strate ligneuse, et pour calculer l'influence de l'exploitation des parcours sahéliens sur la production de ces parcours.

Ranganathan (1992) a utilisé le modèle de Spitters (1983) de l'estimation du degré de compétition intra- et interspécifique pour tracer les limites des possibilités de production des cultures mixtes. Ainsi elle a pu effectuer une évaluation économique de la plus-value maximale des cultures mixtes de maïs/arachide et de sorgho/pois d'Angole.

### **Programmation linéaire**

L'objectif ultime de nombreuses simulations est, comme celui de Ranganathan (1992), de permettre de se prononcer sur l'intérêt économique des options agronomiques sans être obligé de toujours recourir à des tests. De Wit (sous presse) signale que dans les fonctions de production agronomique, les agro-économistes continuent à s'intéresser aux rapports entre les intrants et les rendements des cultures. La recherche agronomique se concentre cependant de plus en plus sur la recherche explicative, l'étude des processus de la croissance des cultures. Ainsi signale-t-il, une situation est née où les économistes posent des questions pour lesquelles les agronomes n'ont plus de réponses, tandis que les agronomes ont des réponses aux questions non posées. Cette publication et l'approche de Ranganathan indiquent comment lever ce blocage. Un troisième objectif, dû aussi au moins partiellement à De Wit, est la planification à buts multiples avec l'aide de la programmation linéaire (PBM-PL).

Spharim et Seligman (1986) exploitent la programmation linéaire pour le choix des technologies de l'élevage ovin dans la région semi-aride méditerranéenne. Bien plus proche du sujet du présent séminaire est l'utilisation dans le cadre de l'élaboration d'un schéma directeur pour la région de Mopti au Mali (Veeneklaas, 1990; Veeneklaas *et al.*, 1990). La planification rationnelle de l'utilisation des terres se heurte à une compréhension insuffisante des relations variables entre les conditions agro-écologiques et socio-économiques et aux conflits entre les objectifs multiples. Il s'agit des conflits entre durabilité, survie et revenus réels, entre producteurs et consommateurs, entre les besoins de la société et ceux des individus, etc. L'étude est composée des éléments suivants:

- une description quantitative des ressources de la région concernée (Cissé et Gosseye, 1990);
- une description quantitative (rapports intrants:extrants) des systèmes de production en vigueur et des systèmes alternatifs (niveaux d'intensification plus élevés et/ou produits alternatifs); des modèles de production d'une gamme de cultures et de l'élevage ont servi pour l'estimation des niveaux de production probables, et le modèle NUREQ a été utilisé pour calculer la quantité d'intrants nécessaire pour obtenir ces niveaux (Van Duivenbooden et Gosseye, 1990);
- un modèle d'optimisation de l'utilisation des ressources (Veeneklaas, 1990);
- un inventaire des nombreux objectifs de développement de la région et les résultats d'optimisation, c'est-à-dire les stratégies de développement pour des combinaisons, des compromis divers entre des objectifs de développement (Veeneklaas *et al.*, 1990).

Les principales conclusions de l'étude peuvent se résumer comme suit: les cultures sont indispensables pour assurer l'alimentation de la population de la région dans les divers scénarios élaborés. Elles constituent cependant un secteur économique peu intéressant; les revenus devront venir de l'élevage, de la pêche et de l'émigration. Enfin, l'autosuffisance alimentaire durable n'est possible qu'avec l'utilisation d'intrants exogènes, notamment les engrais chimiques.

## Utilisation pratique des modèles

### Utilisateurs et usages

L'inventaire ci-dessus a conduit à identifier des applications de modèle à plusieurs niveaux d'intégration dont les limites sont cependant graduelles et vagues.

Il s'agit d'abord et surtout de l'utilisation dans la recherche thématique, en production végétale et animale. Les objectifs concernent l'identification des contraintes et des potentiels des activités isolées ou des systèmes complexes de production, la compréhension des processus de production, ainsi que la généralisation et l'extrapolation des données obtenues localement à un moment donné. Cette utilisation des modèles a la faculté d'accélérer la recherche et de favoriser la coopération et la coordination. Un exemple intéressant est l'utilisation du modèle SARRA (tableau 1) dans le cadre du réseau R3S (Réseau de recherche sur la résistance à la sécheresse).

La recherche prospective en amont ou dans le cadre même de la recherche sur les systèmes de production rurale, permet d'éviter l'approche par tâtonnement en diminuant le nombre de tests au niveau paysan et en augmentant les chances de succès. C'est ainsi que Leloup et Traoré (1989 et 1991) ont employé les résultats des modèles de production fourragère et de production animale pour identifier le rôle potentiel de l'élevage dans le développement rural du sud-est du Mali.

En ce qui concerne l'appui à l'élaboration et à l'exécution des stratégies de développement, les utilisateurs des modèles seront souvent encore des chercheurs, comme dans l'exemple du schéma directeur de la région de Mopti mentionné plus haut (Veeneklaas *et al.*, 1990), mais les demandeurs sont des décideurs à un certain niveau. Des agro-économistes seront bien plus souvent impliqués que dans le cas précédent et les résultats des simulations alimenteront en général des modèles économiques.

Le transfert des connaissances et la promotion de l'approche système et de l'approche multidisciplinaire sont favorisés par les modèles aux trois niveaux d'intégration ci-dessus.

Malgré tout ce qui précède, la modélisation et la simulation sont encore au stade du balbutiement en Afrique subsaharienne. Cela est encore plus vrai pour les niveaux d'intégration supérieurs que pour la recherche thématique, où la majorité des exemples a été empruntée. Les instituts internationaux ont pris l'initiative, et parmi eux les centres de recherche comme le CIPEA. Pour ces derniers l'utilisation pourrait bientôt s'intensifier si les centres du groupe GCRAI (Groupe consultatif pour la recherche agricole internationale) adoptent "l'approche écorégionale de la recherche" (Anonyme, 1993), conformément à une proposition de leur commission consultative.

L'utilisation au niveau d'intégration le plus élevé, celui des décideurs est extrêmement rare. A côté de l'exemple mentionné du schéma directeur de Mopti, deux autres sont présentés. Sur la demande de la FAO, SOW (1985) a déterminé avec l'aide du modèle WOFOST (tableau 1) l'augmentation possible de la production alimentaire du Burkina Faso, du Ghana et du Kenya sous l'effet des dons d'engrais. SOW a conclu qu'un don équivalent au triple de l'appui actuel permettrait de tripler presque la production de maïs au Burkina, soit une augmentation de 100 000 t/an de plus. Au Ghana et au Kenya, le triplement des dons d'engrais n'augmenterait la production que de 20 à 30% seulement et ce, en raison du faible niveau des dons actuels.

Sur demande de l'Office des Nations Unies pour la région sahélo-soudanienne (ONUS), Wolf (1990) a passé en revue les méthodes disponibles pour évaluer la capacité bio-économique des zones semi-arides de l'Afrique de l'Ouest, compte tenu du volume d'intrants extérieurs actuellement disponible et dans l'hypothèse de son augmentation. L'attention a porté sur les cultures, l'élevage et la production forestière. Dans chaque cas, la présentation des modèles disponibles a été accompagnée de quelques résultats de leur utilisation.

Dans aucun des trois cas ci-dessus, il n'a été question ni d'une suite directe et claire ni d'un changement de stratégie, de politique. Cela ne veut pas du tout dire que la modélisation et la simulation sont vaines en Afrique. Trois terrains au moins peuvent être indiqués où l'approche systémique a

contribué de façon notable à des changements stratégiques en rapport avec le développement rural. Il s'agit de l'attention accrue que manifestent les décideurs nationaux et les responsables des structures d'appui pour la fertilité des sols, la gestion des ressources naturelles et l'alimentation de bétail.

### **Analyse des raisons de l'utilisation restreinte des modèles**

Il y a sans doute des raisons simples à l'utilisation restreinte des modèles agronomiques en Afrique. La formation nécessaire est quasi absente, la fiabilité laisse souvent à désirer et il est difficile pour des personnes extérieures de juger des limites de l'applicabilité et partant de la validité des résultats. Pour illustrer ce dernier point, citons les conclusions de deux études: 'Des observations additionnelles sont nécessaires au Botswana, avant que le modèle puisse être utilisé comme outil pour la formulation des messages de vulgarisation' (CIPEA, 1982). 'La conclusion selon laquelle une intensité d'exploitation dépassant 5 ha/UBT est basée sur la capacité de production des années sèches, sur le rapport actuel entre gros bétail et petits ruminants, avec le maintien des effectifs animaux comme seul objectif de l'élevage, et donc sans aucun critère environnemental' (Bremen, 1990a).

Bien plus difficile à corriger pourrait être l'attitude négative en face des modèles et la méfiance vis-à-vis des résultats indésirables. Le premier problème revêt plusieurs facettes. Tout d'abord, l'enracinement des sociétés africaines dans les traditions orales. La capacité d'apprendre par coeur y est phénoménale. Elle va de pair cependant avec le risque de non-compréhension au cours de la formation scolaire 'moderne', si celle-ci est réalisée dans une langue étrangère. Une deuxième facette est celle des hommes à pensée qualitative, opposée aux outils des hommes à pensée quantitative, qualifiés de technocrates. Enfin, le conflit déjà signalé entre les agro-économistes et les agronomes et les écologistes. Les premiers exigent une place prépondérante pour le comportement paysan et pour les processus dynamiques du marché. Les modèles des derniers ont souvent à peine une réponse pour la dynamique des processus agro-écologiques. Il y a cependant des initiatives prometteuses, qui pourraient mener à une intégration satisfaisante des modèles des deux domaines (par exemple Hengsdijk et Kruseman, 1993).

La méfiance des résultats indésirables ne doit pas être négligée comme explication du faible degré d'adoption des modèles. Il est question d'une gamme de messages difficiles à digérer par les décideurs en raison des conséquences politiques nationales et internationales. Pour illustrer ce point, prenons quelques exemples dans les pays sahéliens.

Ce n'est pas la sécheresse qui est le problème numéro un au Sahel pour la production primaire, mais la pauvreté des sols (Penning de Vries et Djitéye, 1991). L'irrigation n'est pas la solution pour cette région.

La pauvreté des sols est à la base de la disponibilité restreinte de fourrage de qualité, ce qui pour l'élevage, constitue une contrainte bien plus aiguë que l'hydraulique pastorale, la situation sanitaire ou le potentiel génétique du bétail de la région (Bremen *et al.*, 1990).

Les sols pauvres, ajoutés à un climat difficile, entraînent un problème de surpopulation à une densité démographique absolue très faible, ce qui limite les investissements productifs rentables. La capacité de charge pour une utilisation intégrée des agro-écosystèmes, sans l'emploi d'intrants externes, n'est que de 1, 10 et 35 personnes/km<sup>2</sup> respectivement pour le nord du Sahel, le sud et la savane soudanienne (Bremen, 1992a). Il est vraisemblable que cela soit un élément explicatif du retard de la 'révolution verte' dans la région.

Le retard de l'intensification agricole et l'épuisement des ressources naturelles (Stoorvogel et Smaling, 1990) ne sont pas des signes d'arriération et d'incapacité des paysans auxquels il faudrait remédier par une meilleure éducation et une meilleure vulgarisation. Il s'agit plutôt des conséquences des ressources naturelles très pauvres et d'un accès inégal aux ressources en général, au niveau national aussi bien que mondial, problèmes auxquels la politique n'a pas encore donnée de réponse adéquate (Bremen, 1990b, Wooning, 1992).

Pareilles affirmations sont difficiles à accepter, et une réaction préalable et simple est la méfiance vis-à-vis des modèles à l'origine de ces conclusions. Il est facile d'y trouver des paramètres à critiquer, mais en général, on ne se gêne même pas pour en chercher. Plus rares sont encore les efforts pour montrer que l'imprécision de ces paramètres met les résultats en question.

Il faut se demander si les chercheurs et les décideurs, en Afrique et ailleurs, peuvent se permettre de rejeter les modèles à la légère. En acceptant une certaine imprécision des modèles, on peut toutefois affirmer que Diarra (1976) avait confirmé la conclusion de Penning de Vries et Van Heemst (1975) selon laquelle la pauvreté des sols est un facteur limitant de la production au Sahel. Ce sont entre autres les observations du CIPEA (Diarra, 1983) qui permettent d'affirmer que la simulation de la production animale au Sahel sur la base de la qualité fourragère permet d'obtenir des résultats réalistes (Ketelaars, 1991). Les essais d'ICRISAT-Niamey et du SAFGRAD confirment les valeurs élevées des estimations de la production céréalière potentielle du Burkina Faso (SOW, 1985). Aussi le dernier chapitre plaidera-t-il pour une introduction rapide des modèles en Afrique comme outils scientifiques et stratégiques.

## **Ingrédients d'un développement durable**

### **Intensification et modélisation**

La surexploitation des ressources naturelles en raison d'une trop forte pression démographique, situation quasi générale au Sahel méridional et dans la savane soudanienne, exige vigilance, esprit de décision et rapidité d'action. Cela est difficile dans un environnement en perpétuelle mutation, où l'expérience des générations antérieures perd rapidement sa valeur. Et, comme il est dangereux de se faire guider par l'intuition ou de préjugés, il serait sage de relativiser la réalité par des modèles, et de se faire une idée des contraintes et des potentiels grâce à des simulations, en tenant compte de la dynamique des changements.

Cette nécessité est rarement acceptée en raison de la capacité tampon des ressources naturelles. Celle-ci s'explique par le fait que l'intensité d'exploitation de ces ressources a été très faible jusqu'à un passé récent. Avant notre ère, des stocks importants avaient été constitués sous forme de biomasse vivante et morte (matière organique du sol) et de concentration en éléments nutritifs dans les couches superficielles des profils pédologiques. Les cultures céréalières de la zone prise comme exemple, entraînent facilement une perte de 10 à 20 kg/ha/an d'azote et de 2 à 3 kg de phosphore. Mais les stocks d'azote minéral et organique du sol sont de l'ordre de 500 à 1 500 kg/ha, tandis que ceux de Phosphore total représentent 25%. Les pertes par l'élevage sont nettement moindres que celles provoquées par les cultures. Il est vrai que l'élevage peut provoquer une dégradation des parcours pire que l'épuisement des sols: l'augmentation du ruissellement. La conséquence négative n'apparaît que lentement cependant, car la diminution plus rapide de la disponibilité en eau en comparaison de celle des éléments nutritifs entraîne une amélioration de la qualité fourragère, alors que la disponibilité en fourrage reste constante malgré la diminution de la production de biomasse (Penning de Vries et Djitéye, 1991). Les végétations relativement intactes ne produisent que 100 à 600 kg/ha/an de bois (du nord au sud), mais en exploitant le capital, c'est-à-dire la biomasse totale de bois, on dispose (temporairement) d'une quantité 10 à 20 fois supérieure.

Cette capacité tampon est une bénédiction dans le sens où elle nous donne le temps d'élaborer des systèmes de production viables. Mais elle permet aussi une croissance des troupeaux et une croissance démographique à un niveau bien supérieur à la capacité de charge des ressources naturelles. Une fois les limites atteintes, la qualité des ressources est si faible que la régénération, quoique techniquement encore possible, ne vaut économiquement plus la peine: il vaut mieux prévenir par l'intensification que guérir. Prévenir par intensification c'est utiliser des intrants externes comme les engrais (Breman 1992b).

Il serait illusoire de compter sur les seuls essais agronomiques pour l'élaboration des stratégies nécessaires. Le fait que l'agriculture repose déjà souvent sur la consommation de la capacité tampon des ressources naturelles signifie que le temps disponible pour la recherche de solutions est limité et

ne doit pas être gaspillé par trop de tâtonnements. De plus, la valeur des essais de courte durée est limitée dans un environnement en mutation. Cela est vrai aussi bien pour le pilier de l'intensification, l'utilisation des engrais chimiques, que pour ses alternatives écologiques.

## **Taux de réponse**

Inhérente à la nécessité d'utiliser des intrants extérieurs est la production pour le marché. Dans une situation de surpopulation, l'autosuffisance alimentaire est impossible sans les cultures de rente. La conséquence est l'obligation de produire d'une façon compétitive. Les frais relatifs des moyens de production de l'élevage intensif dans un pays comme la Hollande sont tels que les mesures destinées à éviter les pertes en éléments nutritifs sont plus coûteuses qu'un usage dépensier. Aussi des efforts en vue d'une optimisation de l'emploi d'engrais pourraient-ils devenir, à côté du faible coût de la main-d'oeuvre, un élément clef de la production compétitive en Afrique, ce qui permettrait d'éviter en même temps les problèmes de pollution par l'agriculture intensive actuelle.

Le rapport valeur/coût des engrais (une évaluation simple de leur rentabilité) s'est sérieusement dégradé en Afrique de l'Ouest au cours de la dernière décennie. Ce problème est moins sérieux pour une culture de rente comme le coton que pour les cultures céréalières et fourragères (Wooning, 1992). L'utilisation économique des engrais exige actuellement un taux de réponse très élevé.

Ce raisonnement pourrait constituer un plaidoyer en faveur de nombreux essais en vue d'établir des courbes de réponses et de déterminer des taux de réponse et des doses économiques. Cependant, quelle est l'utilité de tels tests lorsqu'on sait que le taux de réponse dépend fortement de la fertilité du sol, de sa teneur en matière organique, de la qualité de cette matière organique, de sa capacité de rétention en eau et de la disponibilité en eau, tous facteurs qui risquent de se dégrader sous l'influence de la surexploitation? Quelle est l'utilité de tels tests lorsqu'on sait que les engrais peuvent influencer ces facteurs d'une façon positive aussi bien que négative dans le temps, et cela en relation avec les systèmes de production? Quelle est l'utilité de la détermination de la dose économique maximale lorsqu'on sait que cette dose augmente en général avec l'intensification (De Wit, 1992).

Dans la réalité paysanne et sur les champs d'essais des stations de recherche, les taux de réponse à N et P montrent une variabilité infinie (Van Duivenbooden, 1992). Les essais ne sont valables que s'ils visent principalement à comprendre cette variabilité et à détecter les causes des taux de réponse trop faibles. Cela exige d'accompagner les essais par les simulations et des observations secondaires pour être capable de se prononcer sur le sort des éléments nutritifs. Sinon, les essais n'auront qu'une valeur locale et temporaire!

## **Agriculture biologique**

Pieri (1989) a montré l'importance décisive de la matière organique du sol pour la durabilité de la production agricole de la savane. Il est possible que son rôle puisse être partiellement assumé par le chaulage (De Ridder et Van Keulen, 1990), mais cela ne fera qu'augmenter les frais de la fertilisation. La matière organique n'est pas seulement une source d'éléments nutritifs, elle améliore également l'efficacité de l'utilisation des éléments nutritifs et la disponibilité en eau. Bien que le taux de matière organique des sols de la savane ouest-africaine soit très faible, les propriétés des minéraux d'argile amènent cette matière organique à rendre facilement compte de 50% de la capacité d'échange de cations (C.E.C) (Budelman, 1991). Le taux de réponse à l'azote dépend ainsi du taux de matière organique. Même le taux de réponse au phosphore en dépend indirectement, car le lessivage des cations par suite d'une C.E.C. insuffisante entraîne une baisse de pH, ce qui diminue la solubilité du phosphore. On comprend donc que l'agriculture biologique exige qu'une attention particulière soit accordée à l'état du sol en ce qui concerne la quantité et la qualité de la matière organique!

L'agriculture biologique est un domaine par excellence pour la modélisation et la simulation. Les pratiques vulgarisées ne changent les conditions de production qu'à terme et des interactions complexes ont été mises en évidence. On pourrait déplorer que les promoteurs se trouvent

essentiellement chez les gens qualifiés ci-dessus de qualitatifs. Ne surestime-t-on pas cette forme d'agriculture qui – après être reconnue par les hommes à pensée quantitative – entrave la collaboration et la mise en valeur?

La vitesse de transformation et de dégradation de la matière organique est si élevée sous les climats extrêmes des pays sahéliens, qu'il faut des apports d'énormes quantités et/ou de longues périodes de pratiques alternatives pour obtenir une augmentation limitée du taux de matière organique du sol (De Ridder et Van Keulen, 1990). L'effet des tests de courte durée ne pourra convaincre facilement les paysans et les décideurs. Il faudra donc recourir à la modélisation et à la simulation en vue d'élaborer des essais de longue durée avec de bonnes chances de succès. Une attention particulière doit être accordée à la différence entre la biomasse végétale, la production annuelle et l'exploitation maximum durable. Les biologistes savent que la biomasse énorme de la forêt tropicale pluvieuse ne permet pas d'établir la productivité de la région concernée. Mais il est difficile de transférer cette connaissance dans l'évaluation de la biomasse élevée d'une parcelle protégée au Sahel, d'un peuplement de graminées pérennes ou d'espèces ligneuses. C'est la simulation qui permet une pareille évaluation, au moins globalement. Ainsi on pourra se prononcer sur le rapport entre biomasse, production annuelle et taux de matière organique du sol. C'est encore la simulation qui permettra de déterminer dans quelle mesure l'exploitation diminue la plus-value inhérente, laquelle permet de déterminer l'exploitation optimale. Une forme très simple d'une telle simulation est celle des formules  $N_h$  et  $N_{th}$ , qui permettent de déterminer respectivement la production herbacée, et ligneuse plus herbacée des parcours, à travers la disponibilité d'azote, et cela en rapport avec l'intensité d'exploitation (Breman et De Ridder, 1991).

Une modélisation plus complexe s'avère nécessaire pour quantifier la plus-value totale de l'agriculture concernée. Il a été déjà signalé que la matière organique influence la disponibilité et l'efficacité de l'utilisation des éléments nutritifs et de l'eau. On peut par conséquent s'attendre à des effets synergiques difficiles à estimer sans ordinateur. Plus complexe encore est la question de la plus-value de la combinaison de l'agriculture biologique et de l'agriculture intensive. Il est probable que des éléments de base de la première forme d'agriculture augmentent l'efficacité des intrants externes de la deuxième forme. C'est ainsi que l'introduction d'une espèce pérenne dans une culture annuelle pourrait augmenter le taux de réponse des engrais par l'accroissement du taux de matière organique du sol. Un exemple extrême est l'agroforesterie. Il est possible que sa suppression des pertes des éléments nutritifs d'une culture fertilisée, est bien plus intéressante que son utilisation en remplacement de la fertilisation (Breman, 1990b; Breman et Kessler, en préparation). La synergie de cette agriculture intégrée sera supérieure à celle de la seule agriculture biologique.

Il serait dangereux de penser que sans la modélisation, la simulation et les tests, cette synergie sera suffisamment élevée pour permettre de remplacer l'agriculture actuelle par l'agriculture biologique simple. Le remplacement partiel du capital et des intrants externes par l'énergie et l'intelligence humaine est conseillé si l'énergie supplémentaire est au moins compensée par l'augmentation de la production, et si cette augmentation suffit pour combler les déficits. L'agriculture intégrée pourrait avoir plus de chance.

L'excès d'optimisme n'est pas de mise pour une région comme le Sahel. La plus-value technique de l'agriculture biologique est liée aux conditions agro-écologiques: la plus-value est la plus faible là où on en a le plus besoin. Le climat extrême et les sols pauvres ne permettent qu'une faible production des cultures annuelles (Penning de Vries et Djitéye, 1991). L'aridité extrême de la saison sèche entrave sérieusement le développement des espèces pérennes (Breman et De Ridder, 1991). Ces deux facteurs, ajoutés à la vitesse de dégradation élevée de la matière organique, empêchent d'atteindre les valeurs minimum du taux de matière organique du sol (m.o.s.) pour maintenir une agriculture viable au Sahel. Selon Pieri (1989) la valeur minimum taux de m.o.s./taux d'argile + limon devrait être de 0,05, c'est-à-dire que les sols sableux, limoneux et argileux devraient avoir respectivement un taux de carbone de 3, 7 et 22 g/kg. Penning de Vries et Djitéye (1991) donnent des valeurs de 1 à 4 g/kg pour les sols sablonneux, 2 à 18 pour les sols limoneux et 3 à 27 pour les sols argileux. Breman et Kessler (en préparation) estiment que les valeurs moyennes pour les zones subhumide et semi-aride de

l'Afrique de l'Ouest sont de 3 à 4 g/kg pour les terrains ouverts. Elle est deux fois plus élevée sous les couronnes des espèces ligneuses. Quant aux recouvrements jugés nécessaires pour obtenir les taux minimums de matière organique dans un système mixte de cultures et d'arbres, ils sont tels que la plus-value ainsi obtenue est entièrement perdue par la compétition entre les arbres et les cultures.

## La supplémentation

A première vue, il semble assez facile d'évaluer la rentabilité de l'utilisation directe (cultures fourragères et amélioration des parcours) ou indirecte (cultures vivrières, etc.) des engrais chimiques pour l'amélioration de la situation fourragère. Le fourrage ou les sous-produits de qualité moyenne peuvent être utilisés comme suppléments du fourrage brut, et l'amélioration de la productivité du bétail peut être déterminée. Ensuite il s'agira de calculer les coûts et les bénéfices.

Cependant, la productivité n'est pas une dérivée simple d'un certain supplément. Elle est déterminée par la quantité d'énergie digestible ingérée, laquelle dépend à son tour – outre de l'espèce et de la classe de l'animal – des valeurs absolues et relatives du taux d'azote et de la digestibilité du supplément et du fourrage brut, de leur combinaison, de leurs structures et des quantités offertes, c'est-à-dire des possibilités de choix dont dispose l'animal. Cela fait donc pas mal de combinaisons et il vaudrait mieux en sélectionner d'abord les plus prometteuses par simulation.

En réalité, la situation est encore plus complexe. Un certain niveau de production animale peut être atteint par toute une série de combinaisons d'un fourrage brut et d'un supplément donné (Kaasschieter *et al.*, en préparation). La combinaison optimale dépendra ainsi de la disponibilité du fourrage brut et du supplément. Elle sera très différente par exemple pour une zone pastorale sous-exploitée et une région surexploitée. Elle dépendra également du mode de production du supplément (extensif ou intensif), de la disponibilité relative des facteurs de production et de la situation économique.

## Conclusion

La possibilité d'économiser des essais et de limiter le tâtonnement devrait être un argument suffisant pour adopter l'approche systémique en ce qui concerne la recherche aussi bien que la planification. D'autant plus que dans une situation dynamique et incertaine caractérisée par la surexploitation des ressources naturelles, on aurait tort de se permettre de négliger la modélisation et la simulation. La situation actuelle est très différente de la durabilité à laquelle on aspire.

Ce n'est pas la situation actuelle qui est intéressante à simuler, mais les perspectives d'avenir. Ni les résultats pratiques, ni les essais ne peuvent remplacer les simulations, car les paramètres varient dans l'espace et dans le temps.

Les modèles comportent encore beaucoup de lacunes et ne peuvent pas remplacer les essais. Bien souvent, ce sont uniquement les limites supérieures des options techniques qui peuvent être simulées avec une précision acceptable. De telles limites sont cependant des guides très utiles pour détecter les défauts de la pratique et des essais. Pour profiter de cette option, les modélisateurs sont obligés de se prononcer clairement sur les points faibles et la précision de leurs modèles. En plus, ils doivent consacrer beaucoup de temps aux vérifications, même s'il s'agit de vérifications des modules individuels, si celle de la situation recherchée ne pourra être effectuée qu'après une très longue période de temps.

Les agro-écologistes et les modélisateurs devront toujours se rappeler qu'identifier une solution et l'utiliser sont deux choses différentes. La politique, avec ses stratégies de développement, est confrontée à une situation socio-économique difficilement influençable, et le comportement des producteurs et des consommateurs est difficile à prévoir. Ce constat doit cependant être nuancé. En situation de surexploitation des ressources naturelles imputables à la surpopulation, le choix des producteurs est très restreint et leur comportement prévisible: ils ne peuvent qu'épuiser les ressources

naturelles. Dans la recherche de solutions durables, les décideurs doivent s'inspirer des résultats des simulations tout en faisant preuve de prudence pour avoir le courage d'élaborer une politique sociale et économique qui donne un choix aux producteurs.

## Remerciements

Je dédie cette communication à C.T. De Wit qui de son vivant fut mon inspirateur pour l'application de la modélisation et de la simulation au Sahel. Mes remerciements vont à Peter Uithol pour la mise au point du texte, à Jean François Dejoux pour la correction du style et à Herman van Keulen et Frits Penning de Vries pour leurs commentaires et suggestions. J'exprime également ma reconnaissance aux collègues du projet PSS pour leur collaboration, et à la Direction générale de la coopération internationale du Ministère néerlandais des affaires étrangères (DGIS, La Haye) pour l'appui financier apporté à ce projet.

## Références

- Alberda Th.; Van Keulen H.; Seligman N.G. et De Wit C.T. (sous la direction de). 1992. *Food from dry lands. An integrated approach to planning of agricultural development*, Systems Approaches for Sustainable Agricultural Development Volume 1. Kluwer Academic Publishers, Dordrecht. 211 p.
- Anderson F.M. et Trail J.C.M. 1978. *Initial application of modelling techniques in livestock production systems under semi-arid conditions in Africa*. Contribution to the World Conference on Animal Production, Buenos Aires, Argentina, August 1978. Working document 8, CIPEA, Nairobi (Kenya). 11 p.
- Anonyme. 1993. *The Ecoregional Approach to Research in the CGIAR: Report of the TAC/Center Directors Working Group*. Groupe consultatif pour la recherche agricole internationale. Comité consultatif technique/Secrétariat du TAC. FAO (Organisation des Nations Unies pour l'alimentation et l'agriculture), Rome (Italie).
- Berendse F. et Elberse W.Th. 1989. Competition and nutrient losses from the plant. In: *Causes and consequences of variation in growth rate and productivity of higher plants*. Publié sous la direction de H. Lambers et al. Academic Publishing, La Haye (Pays Bas) p. 269 à 284.
- Breman H. 1975. La capacité de charge maximale des pâturages maliens. In: *Inventaire et cartographie des pâturages tropicaux Africains*. Actes du colloque. Bamako-Mali, 3-8 mars 1975, CIPEA, Addis-Abeba (Ethiopie). p. 249 à 256.
- Breman H. 1990a. No sustainability without external inputs. In: *Beyond adjustment*. Africa Seminar, Maastricht (Pays-Bas). Ministère des affaires étrangères. p. 124 à 133.
- Breman H. 1990b. Integrating crops and livestock in southern Mali: rural development or environmental degradation. In: *Theoretical production ecology: reflections and prospects*. Publié sous la direction de R. Rabbinge; J. Goudriaan; H. Van Keulen; F.W.T. Penning de Vries et H.H. Van Laar. 1990. Simulation Monographs 34, Pudoc, Wageningen (Pays-Bas). p. 277 à 294.
- Breman H. 1992a. Agro-ecological zones in the Sahel: potentials and constraints. In: *Poverty and development. Analysis and Policy. Vol. 4. Sustainable development in semi-arid sub-saharan Africa*. Publié sous la direction de A. Blokland A. et F. van der Staay. Ministère des affaires étrangères, La Haye (Pays Bas).
- Breman H. 1992b. Desertification control, the West African case; prevention is better than cure. *Biotropica* 24:328-334.
- Breman H. et De Ridder N. (sous la direction de). 1991. *Manuel sur les pâturages des pays sahéliens*. ACCT (Agence de coopération culturelle et technique), CTA (Centre technique de coopération agricole), Karthala, Paris. 485 p.
- Breman H. et De Wit C.T. 1983. Rangeland productivity and exploitation in the Sahel. *Science* 221:1341-1347.
- Breman H. et Kessler J.J. *Woody plants in West Africa*. Springer Verlag (en préparation).
- Breman H.; Ketelaars J.J.M.H. et Traoré N. 1990. Un remède contre le manque de terre? Bilan des éléments nutritifs, production primaire et élevage au Sahel. *Sécheresse* 1(2) :109-117.



- Budelman A. 1991. Woody species in auxiliary roles. Live stakes in yam cultivation. Thèse de doctorat (Ph.D.), Agricultural University Wageningen, KIT, Amsterdam (Pays-Bas).
- Christian K.R.; Freer M.; Donnelly J.R.; Davidson J.L. et Armstrong J.S. 1978. *Simulation of grazing systems*. Simulation Monographs, Pudoc, Wageningen (Pays-Bas). 115 p.
- CIPEA (Centre international pour l'élevage en Afrique). 1982. Modélisation mathématique des systèmes de production animale: application au Botswana du modèle de production bovine de la Texas A & M University. CIPEA étude de systèmes 1. CIPEA, Addis-Abeba (Ethiopie). 57 p.
- Cissé S. et Gosseye P.A. (sous la direction de). 1990. *Compétition pour des ressources limitées: le cas de la cinquième région du Mali. Rapport 1: ressources naturelles et population*. ESPR, Mopti and CABO-DLO, Wageningen (Pays-Bas). 106 p.
- Clopes A.; Baron C. et Forest F. 1993. *Développement d'un système d'évaluation de la faisabilité et de la performance des activités de production agricole en régions à fort risque climatique. Système d'analyse régionale risques agroclimatiques (SARRA). Manuel d'utilisation*. CIRAD (Centre de coopération internationale en recherche agronomique pour le développement, Montpellier (France). 64 p.
- Dahl G. et Hjort A. 1976. *Having herds: pastoral herd growth and household economy*. Stockholm Studies in Social Anthropology, University of Stockholm (Suède). 335 p.
- De Leeuw P.N. et Konandreas P.A. 1982. The use of an integrated and stochastic model to estimate the productivity of four pastoral production systems in West Africa. In: *Proceedings of the National Beef Conference*, Kaduna, (Nigeria) July 1982. p. 184 à 212.
- De Ridder N. et Van Keulen H. 1990. Some aspects of the role of organic matter in sustainable intensified arable farming systems in the West African semi-arid tropics (SAT). *Fertilizer Research* 26:299-310.
- De Ridder N.; Van Keulen H.; Seligman N.G. et Neate P.J.H. (sous la direction de). 1986. *Modelling of extensive livestock production systems*. Actes d'atelier CIPEA/ARO/CABO tenu à l'ARO, Bet Dagan (Israël) du 5 au 9 février 1985. CIPEA (Centre international pour l'élevage en Afrique), Addis-Abeba (Ethiopie). 349 p.
- De Wit C.T. 1965. *Photosynthesis of leaf canopies*. Agricultural Research Reports no. 663, Pudoc, Wageningen (Pays-Bas). 57 p.
- De Wit C.T. 1975. Etudes au moyen de modèles sur la production réelle et la production possible des pâturages dans les régions arides. Dans actes du colloque: *Inventaire et cartographie des pâturages tropicaux africains*, Bamako, 3-8 mars 1975, CIPEA (Centre international pour l'élevage en Afrique), Addis-Abeba (Ethiopie). p. 329 à 332.
- De Wit C.T. 1992. Resource use efficiency in agriculture. *Agricultural Systems* 40:125-151.
- De Wit C.T. (sous presse). A struggle for inter-disciplinarity. In: *Proceedings of the Symposium: The future of the land, Wageningen the 22th-25th of August 1993*. John Wiley and Sons.
- Diarra L. 1976. Composition floristique et productivité des pâturages soudano-sahéliens sous une pluviosité annuelle moyenne de 1100 à 400 mm. Thèse de doctorat en biologie. Centre pédagogique supérieure, Bamako (Mali). 95 p.
- Diarra L. 1983. *Production et gestion des parcours sahéliens: synthèse de cinq années de recherches au Ranch de Niono*. Document de programme n° AZ 94. CIPEA, Bamako (Mali). 82 p.
- Genin D. 1991. Modèle prévisionnel des choix alimentaires des ruminants sur parcours. In: *Actes du Quatrième congrès international des terres de parcours, Montpellier 22-26 avril 1991*. Publié sous la direction de A. Gaston, M. Kernick et H.N. Le Houérou. CIRAD (Centre de coopération internationale en recherche agronomique pour le développement, Montpellier (France). p. 632 à 635.
- Hengsdijk H. et Kruseman G. 1993. *Operationalizing the DLV program: An integrated agro-economic and agro-ecological approach to a methodology for analysis of sustainable land use and regional agricultural policy*. DLV Report no. 1. CABO (Centre for Agro-biological Research)-DLO/Dept. of Dev. Economics-WAU, Wageningen (Pays-Bas).
- ICASA (International Consortium for Applications of Systems approaches to Agriculture). 1993. *International Consortium for Applications of Systems approaches to Agriculture*. Brochure Department of Crop and Soil Sciences, Michigan State University, East Lansing and TPE, Agricultural University, Wageningen (Pays-Bas).

- Janssen B.H.; Guiking F.C.T.; Van der Eijk D.; Smaling E.M.A.; Wolf J. et van Reuler H. 1990. A system for quantitative evaluation of the fertility of tropical soils (QUEFTS). *Geoderma* 46:299–318.
- Kaasschieter G.A.; Coulibaly Y. et Kane M. *Supplémentation de la paille de mil (Pennisetum thypoides) avec le tourteau de coton: effets sur l'ingestion, la digestibilité et la sélection.* (en préparation).
- Ketelaars J.J.M.H. 1991. La production animale. In: *Manuel sur les pâturages des pays sahéliens*. Publié sous la direction de H. Breman et N. De Ridder. ACCT (Agence de coopération culturelle et technique), CTA (Centre technique de coopération agricole et rurale), Karthala, Paris (France). p. 357 à 388.
- Konandreas P.A. et Anderson F.M. 1982. *Dynamique du troupeau de bovins: un modèle entier et stochastique pour l'évaluation des options de production*. CIPEA Rapport de recherche 2. CIPEA (Centre international pour l'élevage en Afrique), Addis-Abeba (Éthiopie). 74 p.
- Kropff M.J. et Van Laar H.H. (sous la direction de). 1993. *Modelling crop-weed interactions*. CAB (Offices agricoles du Commonwealth), Wallingford (R.-U.). 274 p.
- Leloup S. et Traoré M. 1989. *La situation fourragère dans le Sud-Est du Mali – Région CMDT de Sikasso et de Kouitiatla – Une étude agro-écologique. Tome I*. DRSPR (Département de recherches sur les systèmes de production rurale), Sikasso (Mali)/Institut royal des tropiques, Amsterdam (Pays-Bas).
- Leloup S. et Traoré M. 1991. *La situation fourragère dans le Sud-Est du Mali – Région CMDT de San – Une étude agro-écologique. Tome II*. DRSPR (Département de recherches sur les systèmes de production rurale), Sikasso (Mali)/Institut royal des tropiques, Amsterdam (Pays-Bas).
- Mohren G.M.J.; Bartelink H.H.; Jorritsma I.T.M. et Kramer K. 1993. A process-based growth model for analysis of forest dynamics in relation to environmental factors. In: *Forest reserves workshop. Proceedings of a workshop held in Wageningen*. Publié sous la direction de M. Broekmeijer, W. Vos et H.G.J.M. Koop. Pudoc, Wageningen (Pays-Bas).
- Nonhebel S. 1993. The importance of weather data in crop growth simulation models and assessment of climatic change effects. Thèse de doctorat (Ph.D.), Agricultural University, Wageningen (Pays-Bas). 144 p.
- Penning de Vries F.W.T. 1982. Systems analysis and models of crop growth. In: *Simulation of plant growth and crop production*. Publié sous la direction de F.W.T. Penning de Vries et H.H. Van Laar. PUDOC, Wageningen (Pays-Bas). p. 9 à 19.
- Penning de Vries F.W.T. et Djitéye M.A. (sous la direction de). 1991 (2<sup>e</sup> édition). *La productivité des pâturages sahéliens. Une étude des sols, des végétations et de l'exploitation de cette ressource naturelle*. Agricultural Research Reports 918, Pudoc, Wageningen (Pays-Bas). 525 p.
- Penning de Vries F.W.T. et Van Heemst H.D.J. 1975. Potential primary production of unirrigated land in the Sahel. Dans actes du colloque: *Inventaire et cartographie des pâturages tropicaux africains, Bamako, 3–8 mars 1975*, CIPEA (Centre international pour l'élevage en Afrique), Addis-Abeba (Éthiopie). p. 323 à 328.
- Pieri C. 1989. *Fertilité des terres de savanes. Bilan de trente ans de recherche et de développement agricoles au sud du Sahara*. Ministère de la coopération et du développement et CIRAD (Centre de coopération internationale en recherche agronomique pour le développement)–IRAT (Institut de recherches agronomiques tropicales et des cultures vivrières), Montpellier (France). 444 p.
- Ranganathan R. 1992. Analysis of yield advantage in mixed cropping. Thèse de doctorat (Ph.D.), Wageningen Agricultural University, Wageningen (Pays-Bas). 93 p.
- Seligman N.G. et Van Keulen H. 1981. PAPAN: A simulation model of annual pasture production limited by rainfall and nitrogen. In: *Simulation of nitrogen behaviour of soil-plant systems*. Publié sous la direction de M.J. Frissel et J.A. Van Veen. Pudoc, Wageningen (Pays-Bas). p. 192 à 221.
- SOW. 1985. *Potential food production increases from fertilizer aid. A case study of Burkina Faso, Ghana and Kenya*. Etude élaborée à la demande de la FAO par le Centre d'études alimentaires dans le monde. Wageningen (Pays-Bas). 48 p.
- Spharim I. et Seligman N.G. 1986. Selection of sheep husbandry technologies under single and multiple goal constraints. In: *Modelling of extensive livestock production systems*. Publié sous la direction de N. De Ridder, H. Van Keulen, N.G. Seligman et P.J.H. Neate. 1986. Actes d'un atelier CIPEA/ARO/CABO tenu à l'ARO, Bet Dagan (Israël), 5–9 février 1985. CIPEA, Addis-Abeba (Éthiopie). p. 323–342.

- Spitters C.J.T. 1980. *Simulating the vegetation dynamics of sahelian pastures*. Communication présentée à l'atelier des biologistes européens de la population tenu le 9 mai 1980, School of Plant Biology, Bangor. Dept. of Theoretical Production Ecology, Agricultural University, Wageningen (Pays-Bas).
- Spitters C.J.T. 1983. An alternate approach to the analysis of mixed cropping experiments. 1. Estimation of competition effects. *Netherlands Journal of Agricultural Sciences* 31:111.
- Spitters C.J.T. 1990. Crop growth models: their usefulness and limitations. *Acta Horticulturae* 267: 349–362.
- Spitters C.J.T.; Van Keulen H. et Van Kraalingen D.W.G. 1989. A simple and universal crop growth simulator: SUCROS87. In: *Simulation and systems management in crop protection*. Publié sous la direction de R. Rabbinge, S.A. Ward et H.H. Van Laar. Simulation Monographs 32. Pudoc, Wageningen (Pays-Bas). p. 147 à 181.
- Stoorvogel J.J. et Smaling E.M.A. 1990. *Assessment of soil nutrient depletion in sub-saharan Africa: 1983–2000. Volume I Main report; volume IV Computer programs*. Report 28, WSC, Wageningen (Pays-Bas). p. 137 et 162.
- Struif Bontkes T. 1992. *On Dinka, cattle and grain. An interdisciplinary simulation study of a rural area in Southern Sudan*. Wageningen Agricultural University Papers 91–3, Agricultural University, Wageningen (Pays-Bas). 102 p.
- Sullivan G.M.; Cartwright T.C. et Farris DE. 1981. Simulation of production systems in east Africa by use of interfaced forage and cattle models. *Agricultural Systems* 7: 245–265.
- Ungar E.D. et Noy-Meir I. 1986. Behavioural aspects of intake at pasture in ruminants. In: *Modelling of extensive livestock production systems*. Publié sous la direction de N. De Ridder, H. Van Keulen, N.G. Seligman et P.J.H. Neate. Actes de l'atelier CIPEA/ARO/CABO tenu à l'ARO, Bet Dagan (Israël), 5–9 février 1985. CIPEA (Centre international pour l'élevage en Afrique), Addis-Abeba (Ethiopie). p. 80 à 107.
- Van de Ven G.W.J. 1992. *GRASMOD, a grassland management model to calculate nitrogen losses from grassland*. Report 158, Centre for Agrobiological Research (CABO-DLO), Wageningen (Pays-Bas). 109 p.
- Van der Lee J.; Udo H.M.J. et Brouwer B.O. 1993. Design and validation of an animal traction module for small holder livestock systems simulation models. *Agricultural Systems* 43:199–227.
- Van Diepen C.A.; Rappoldt C.; Wolf J. et Van Keulen H. 1988. *CWFS crop growth simulation model WOFOST*. Documentation version 4.1. Document de travail SOW-88–01. Centre d'études alimentaires dans le monde (CWFS), Amsterdam-Wageningen (Pays-Bas). 299 p.
- Van Duivenbooden N. 1992. *Sustainability in terms of nutrient elements with special reference to West Africa*. Report 160, Centre for Agrobiological Research (CABO-DLO), Wageningen (Pays-Bas). 261 p.
- Van Duivenbooden N. et Gosseye P.A. (sous la direction de ). 1990. *Compétition pour des ressources limitées: le cas de la cinquième région du Mali. Rapport 2. Productions végétales, animales et halieutiques*. CABO (Centre for Agrobiological Research), Wageningen (Pays-Bas) et ESPR, Mopti (Mali). 266 p. + annexes.
- Van Dyne G.M. et Abramsky Z. 1975. Agricultural systems models and modelling: an overview. In: *Study of agricultural systems*. Publié sous la direction de G.E. Dalton. Applied Science Publishers, Londres (R.-U.). p. 23 à 106.
- Van Keulen H. et Breman H. 1990. Agricultural development in the West African Sahelian region: a cure against land hunger? *Agriculture, Ecosystems and Environment* 32:177–197.
- Van Keulen H.; De Wit C.T. et Lof H. 1976. The use of simulation models for productivity studies in arid regions. In: *Water and plant life; problems and modern approaches. Ecological Studies*. Publié sous la direction de O.L. Lange; L. Kappen et E.D. Schultz. 19, Springer Verlag, Heidelberg. p. 408 à 420.
- Van Kraalingen D.W.G.; Stol W.; Uithol P.W.J. et Verbeek M.G.M. 1991. *User manual of CABO/TPE Weather System*. Document interne CABO/TPE. 27 p.
- Veeneklaas F.R. 1990. *Compétition pour des ressources limitées: le cas de la cinquième région du Mali. Rapport 3: Description formelle du modèle d'optimisation MALI5*. CABO (Centre for Agrobiological Research), Wageningen et ESPR, Mopti (Mali). 63 p.
- Veeneklaas F.R.; Cissé S.; Gosseye P.A.; Van Duivenbooden N. et Van Keulen H. 1990. *Compétition pour des ressources limitées: le cas de la cinquième région du Mali. Rapport 4. Scénarios de développement*. CABO (Centre for Agrobiological Research), Wageningen (Pays-Bas) et ESPR, Mopti (Mali). 182 p. + annexes.

- Verberne E.L.J.; Hassink J.; De Willigen P.; Groot J.J.R. et Van Veen J.A. 1990. Modelling organic matter dynamics in different soils. *Netherlands Journal of Agricultural Science* 38:221–238.
- Vossen P. 1990. A simple water-balance model for the assessment of livestock performance in Botswana. *Agricultural and Forest Meteorology* 50:189–199.
- Wolf J. 1990. *Bio-economic capability of West-African drylands*. Vol. 2: tables and figures, CABO (Centre for Agro-biological Research), Wageningen (Pays-Bas). 46 p.
- Wolf J.; De Wit C.T.; Janssen B.H. et Lathwell D.J. 1987. Modelling long-term crop response to fertilizer phosphorus. I. The model. *Agronomy Journal* 79:445–451.
- Wolf J.; De Wit C.T. et Van Keulen H. 1989. Modeling long-term crop response to fertilizer and soil nitrogen. I. Model description and application. *Plant and Soil* 120:11–22.
- Wooning A. 1992. *Les prix du bétail, de la viande, des produits laitiers et des engrais dans les pays sahéliens. Une étude d'appui à l'équipe modélisation des systèmes*. Rapports PSS n° 1. IER/CABO–DLO/DAN–UAW/IB–DLO, Wageningen (Pays-Bas). 72 p.
- Young A. et Muraya P. 1990. *SCUAF. Soil changes under agroforestry. Computer program with user's handbook Version 2*. ICRAF (Centre international pour la recherche en agroforesterie), Nairobi (Kenya). 123 p.
- Zemmelink G. 1980. *Effect of selective consumption on voluntary intake and digestibility of tropical forages*. Agricultural Research Reports 896, Pudoc, Wageningen (Pays-Bas). 100 p.

# **Modelling the effects of livestock on nutrient flows in mixed crop–livestock systems**

*P.J. Thorne*

Natural Resources Institute (NRI), Central Avenue, Chatham Maritime, Kent ME4 4TB, UK

## **Abstract**

Some of the effects of the passage of biomass through livestock on the dynamics of whole-system nutrient cycles are relatively clearly defined. However, processes in the livestock component may have other far-reaching effects that are less readily accounted for. For example, changes in diet composition can affect the partitioning of excreted nitrogen between manure and urine. Such changes can interact with animal and compost management practices to affect the dynamics of processes occurring in soil organic matter. A model based on digestive processes in ruminants is described which has been developed to assist in resolving these effects and interactions. Initial simulations with the basic Animal Production/Manure (APM) model have been conducted, both alone and in conjunction with the SCUAF (Soil Changes Under Agroforestry) model. These have been based on a system in which livestock are fed crop residues but may also graze or receive concentrate supplementation to highlight a number of issues, in particular that: animals may, depending on access to grazing and concentrate supplements, act as importers of nutrients into more intensively cropped land; and optimum production from the animal component may not necessarily be associated with maximum losses of nutrients from this land, even when the use of concentrate supplements is limited. Apart from improving our understanding of whole-cycle nutrient dynamics, the approach used in developing the APM model might also allow a unified approach to questions of whole-system productivity in mixed crop–livestock systems. Future efforts will concentrate on defining the parameters of the processes on which APM is based and the validation of the model against field data.

## **Modélisation de l'influence des animaux d'élevage sur les flux d'éléments nutritifs dans les systèmes mixtes agriculture–élevage**

*P.J. Thorne*

Natural Resources Institute (NRI), Central Avenue, Chatham Maritime, Kent ME4 4TB (R.-U.)

## **Résumé**

*Certains des effets du transit de la biomasse par le système digestif des animaux sur la dynamique générale des cycles des éléments minéraux sont relativement bien définis. Toutefois, les processus survenant au niveau des animaux mêmes peuvent avoir des conséquences extrêmement importantes mais moins faciles à prendre en compte. Par exemple, les changements de la composition des régimes alimentaires peuvent modifier les proportions d'azote excrété dans le fumier et l'urine. L'interaction de tels changements avec les modes de gestion des animaux mêmes et du compost peut influencer les processus survenant dans la matière organique du sol. Cet article décrit un modèle basé sur les processus digestifs des ruminants et élaboré pour expliquer ces effets et ces interactions. Les premières simulations ont été effectuées soit avec le modèle Production animale/fumure (APM), soit avec celui-ci et le modèle Changements pédologiques en agroforesterie (SCUAF). Ces simulations sont basées sur un système dans lequel les animaux reçoivent des résidus de cultures mais peuvent aussi pâturer ou recevoir une complémentation de concentrés. L'objectif consistait à démontrer que les animaux peuvent, selon l'accès au pâturage et aux concentrés, importer des éléments nutritifs dans les terres soumises à une exploitation intensive et qu'une production animale optimale ne doit pas être nécessairement associée à des pertes accrues d'éléments nutritifs de la terre, même en condition*

*d'utilisation limitée de concentrés. Non seulement cette approche permet de mieux cerner la dynamique générale des cycles d'éléments nutritifs, mais également elle pourrait déboucher sur une approche globale du problème de la productivité totale des systèmes mixtes agriculture-élevage. Des travaux futurs viseront à améliorer la définition des paramètres intervenant dans les processus de l'APM ainsi qu'à valider le modèle à partir de données de terrain.*

## Introduction

Models are a useful component in the analytical framework, which includes observation and experimentation, that can be applied to the evaluation of a wide variety of systems. Used in this way, modelling approaches have proved themselves powerful tools for integrating data from a wide variety of sources for the formulation of hypotheses and the testing of assumptions about key processes within a number of systems.

The objectives of models are unlikely to encompass the perfect simulation of observational data. To assume that this might be achievable in most complex biological systems is naive. Furthermore, such a feat would merely reflect the fact that knowledge of the system under study was at a perfect stage and that further analysis would be unnecessary. It is arguable, therefore, that failures of predictive models are in many ways their most interesting features as they can help to focus researchers' attention on those processes about which information is inadequate or inaccurate.

Models have been widely employed to explore the complexities of soil nutrient dynamics and the interactions between the factors which affect these (Parton et al, 1987; Thornley and Verberne, 1989) and, in many cases, have furnished the benefits outlined above. It is surprising, therefore, that a similar approach has not been taken to evaluate fluxes through the livestock component of nutrient cycles. The range of digestive and physiological processes which determine the partitioning and ultimate fate of nutrients as they pass through livestock operate at a similar level of complexity to soil processes. The interactions of these processes with the range of management strategies relating to feed and movement further complicate the elaboration of the subtle effects of livestock on nutrient fluxes within the system as a whole. The development of livestock models that can be interfaced with soil models could also have benefits for the modelling of whole-system dynamics and productivity with nutrient transfers being used to unify soil, crop and livestock components.

Many of the effects of livestock on nutrient cycle dynamics are likely to be susceptible to evaluation using a process-based modelling approach as they are readily quantifiable. The efficiency of extraction of nutrients from feed by animals within a herd, the turnover of ingested nutrients within the animals, both in the short and longer terms and the partitioning of excreted nutrients between urine and faeces have all been assessed in formulating nutrient requirements for domestic livestock (ARC, 1980; IDWP, 1992). It is these processes that can affect the quantity and chemical composition of organic returns to cropland and, consequently, the dynamics of subsequent fluxes in the soil (Tian et al, 1992). There are, however, a number of other factors involved, e.g. the effects of tannin on nitrogen fluxes (Sivapalan, 1982; Rittner and Reed, 1992) that require further quantification. The integration of a modelling approach at an early stage could facilitate the identification of priorities for research in these areas.

This paper, while not able to address these issues in great detail, sets out to demonstrate the potential of a modelling approach to contribute to the analysis of nutrient flows within crop-livestock systems. The principal objective of the Animal Production/Manure (APM) model developed was to assess the utility of a modelling approach for evaluating the effects on outputs, including nitrogen in excreta, of a range of management decisions that smallholders operating mixed crop-livestock systems must make. These decisions relate to the principal areas in which such farmers are likely to have options — stocking density, use of grazing and the use of feed supplements. The model can be used to examine trade-offs between the different productive outputs of the livestock component of the system. Its outputs can also be used to examine the consequences of interventions within the livestock component for other parts of the farming system by using these as input data for soil models.

## Materials and methods

### Model construction

The APM model is based on the treatments of nutrient and energy absorption and utilisation developed by ARC (1980) for metabolisable energy (ME) and IDWP (1992) for metabolisable protein (MP). The basic input data set required by APM (Table 1) has been minimised to allow the model to be operated in situations where available data are limited. Therefore, some of the feed parameters required by the model must be derived indirectly. These include the feed metabolisability ( $q = \text{ME} / \text{Gross Energy}$ ), the acid detergent insoluble nitrogen (ADIN) content of the feed and three parameters which describe the dynamics of protein degradation in the rumen, a, b and c (Orskov and McDonald, 1979). ADIN and a, b and c are required by the MP system upon which the nitrogen component of the model is based and the values used are averages for each feed type. APM assumes that all animals in the herd are identical in type (for example, growing animals of a fixed mean live weight). This approach simplifies simulations for a range of herd sizes and is considered justifiable as the model is designed principally to examine the effects of livestock, as a system component, on nutrient fluxes.

**Table 1.** Basic input data required for an APM simulation.

Parameter	Unit
Feeds	
Quantity	kg available/day (as fed) or hours spent grazing
Type of feed	Grass, grass hay, cereal crop residue, legume crop residue, tree fodder, grain, animal protein supplement, vegetable protein supplement
Dry matter	g/kg
Crude protein	g/kg dry matter
Crude fibre	g/kg dry matter
Ether extract	g/kg dry matter
Metabolisable energy	MJ/kg dry matter
Animal	
Species	<i>Bos taurus</i> , <i>Bos indicus</i> , buffalo, sheep, goat
Sex	Male, female, castrate
Class	Growing, mature
Live weight	kg
Number in herd	Integer

The composition of the diet consumed by animals in the herd is a function of the capacity of the type of animal selected to consume the feed that is available (its voluntary dry-matter intake; VDMI) and the herd size. If the total amount of feed available is greater than the total VDMI of the herd, it is assumed that feeds with the highest value for  $q$  are consumed preferentially. Thus, animals in a small herd will, at a given level of feed availability, tend to consume feeds of a better quality up to their maximum predicted VDMI (Forbes, 1986) and reject those of poorer quality. This approach allows the model to account, in principle at least, for the selectivity observed in animals offered feed in excess of their capacity to consume it (Osafo et al, 1992). When herd size is larger and the quantity of feed available is less than the total VDMI for the herd, a reduction in dry matter intake below VDMI is calculated that is proportional to herd size. Grazing intake is calculated separately, assuming that each animal in the herd consumes a quantity of grass that is proportional to the hours spent at pasture during each day. Thus, for a grazing herd, the potential intake of feeds presented in the stall is obtained by subtraction of the dry matter consumed at pasture from the VDMI of each animal.

The simulation of animal performance is derived initially from the difference between the ME supplied in the feed consumed and the maintenance ME requirement appropriate for the type of animal in the herd, calculated using equations of ARC (1980). A mean daily rate of production (milk or liveweight change) and total production (or liveweight loss) during one month is calculated from the amount of ME in excess or deficit of the maintenance ME required. In the latter case, weight loss is

calculated from the amount of body reserves mobilised to meet a shortfall in ME for maintenance (ARC, 1980).

The animals' ability to achieve the level of performance predicted from ME intake depends on the adequate supply of protein for turnover and production. The protein component of the model, based on the UK MP system, uses the same general approach described by Dewhurst and Thomas (1992) who evaluated the effects of dietary changes on urine production. Dietary MP supply is checked against the MP required to support the level of production by the energy component. If the former is found to be inadequate, a correction is made to the predicted production level on the basis of the rate of MP utilisation that the current MP intake will support. If MP supply is inadequate for protein turnover, a weight loss is calculated as specified by IDWP (1992).

The MP system also allows the prediction of the partitioning of nitrogen between faeces and urine (Table 2). In animals that are not grazed, it is assumed that all excreted nitrogen is incorporated into compost together with any feeds that are rejected by a herd that is fed in excess of VDMI. In herds that graze for part of the day, it is assumed that the amounts of faecal and urine N deposited on the pasture or range are proportional to the amount of time spent grazing. The current implementation of the model assumes that there is no diurnal variation in faeces or urine output.

**Table 2.** Equations used for predicting nitrogen outputs in faeces and urine.

Species	Faeces		Urine	
	Indigestible nitrogen (g/day)	Endogenous losses (g/day)	From protein utilisation (g/day)	Endogenous losses (g/day)
Cattle	Acid detergent insoluble nitrogen content of the diet	$0.35 \times (\text{weight})^{0.75}$	$\text{MP} \times \text{K}_N$  ( $\text{K}_N = 0.85$ for maintenance and pregnancy, $0.59$ for growth, $0.68$ for lactation)	$0.13 \times (\text{weight})^{0.75}$
Sheep + goats	As above	As above	As above + $\text{K}_N = 0.26$ for wool	$0.02348 \times \text{weight} + 0.54^2$

1.  $\text{K}_N$  is the efficiency of conversion of absorbed nitrogen for different productive purposes and for maintenance.

2. ARC (1980).

Source: IDWP (1992).

## Simulation of published experimental and field observations

APM is a mechanistic model (albeit at a fairly low level of disaggregation) in the sense that the parameters used in its construction are related by the discrete, identifiable processes that are said to govern nitrogen and energy transactions in the animal. The scope of the model's applicability depends, therefore, on how generally these processes apply. The key question here is: do the descriptions of processes derived by ARC (1980) and IDWP (1992) for animals under European conditions apply to animals, of different genotypes, kept under more extensive feeding and management systems in Africa or elsewhere? A reliable answer to this question would require detailed validation and testing of the model using individual animal data for several species under a wide range of feed management systems. Such testing of APM might be envisaged for the future when a number of inadequacies, which will become apparent, relating to the parameterisation and data used in the construction of the model have been addressed.

For the purposes of this paper, a simple comparison between APM predictions and experimental observations is presented to illustrate current limitations on the predictive capacity of the model. The



input data used for this simulation (Table 3) are derived from a nitrogen balance experiment conducted with indigenous Malawi goats offered a range of hay-supplement combinations (Reynolds, 1981) which was selected at random from a number of suitable, published studies.

**Table 3.** *Input data for simulation of published data.*

Feed	Feed type	Dry matter (g/kg DM)	Crude protein (g/kg DM)	Crude fibre (g/kg DM)	Ether extract (g/kg DM)	Metabolisable ( MJ/kg DM estimated)
<i>Chloris gayana</i> hay (1)	Grass hay	895	59	427	8	7.40
<i>Chloris gayana</i> hay (2)	"	920	53	435	10	7.40
<i>Chloris gayana</i> hay (3)	"	900	59	362	9	8.15
<i>Chloris gayana</i> hay (4)	"	932	58	445	8	7.40
Concentrate (1)	"	927	100	60	90	11.75
Concentrate (2)	"	908	230	100	65	11.44
Concentrate (3)	"	913	347	99	69	11.29

Animal details: One 30 kg mature castrated goat.

Source: Reynolds (1981).

### Effects of feeding and management strategies on livestock production and nutrient flows in a mixed crop–livestock system

Simulations were conducted with APM to evaluate the effects of herd size, availability of grazing and supplementary feeds and their interactions on liveweight production and nitrogen outputs for composting from a livestock holding associated with a specific system. The system used was a hedgerow intercrop of pigeon pea and maize producing 1020 and 2220 kg/ha per year, respectively, of forage dry matter which, for the purposes of the simulation was assumed to be available as feed (6 kg of maize stover and 2.8 kg pigeon pea haulm per day). This level of forage production was based on predictions for the crop generated by an example simulation presented by Young and Muraya (1990) using the Soil Changes Under Agroforestry (SCUAF) model. The system was chosen so that possibilities for using the APM model in conjunction with this soil nutrient model could also be explored. The APM model simulations were based on the assumption that all forage was removed from the cropped land and all compost produced was available subsequently for fertilising the crop.

The effects on liveweight production and sources of nitrogen in the compost, of grazing for four or eight hours per day and a fixed availability of concentrate of 0.5 kg or 1 kg per day in addition to the forage available from crop residues were also examined. The model was also used to examine the effects of grazing and supplement availability on net nutrient transfers between the livestock component and the crop land. Basic input data for these APM simulations are shown in Table 4.

**Table 4.** *Basic input data for APM simulations of liveweight production and nitrogen outputs from a livestock holding associated with one hectare of pigeon pea/maize intercrop.*

Feed	Feed type	Dry matter g/kg DM)	Crude protein (g/kg DM)	Crude fibre (g/kg DM)	Ether extract (g/kg DM)	Metabolisable energy (MJ/kg DM)
Maize stover	Cereal crop residue	841	59	385	18	8.6
Pigeon-pea haulm	Legume crop residue	900	167	297	25	9.99
Groundnut cake	Vegetable protein supplement	926	495	53	92	14.46
<i>Chloris gayana</i>	Grass	282	89	379	10	10.12

Animal details: Varying number of 100 kg growing male *Bos taurus*.

## **Interfacing with a soil nutrient model**

APM model simulations were also conducted in tandem with simulations of soil changes and their consequences for crop productivity over a six-year period that were generated using the SCUAF model. The SCUAF model was developed for making approximate predictions of the effects of agroforestry systems on soil parameters (erodibility and nutrient status) and to use these predictions to assist in the design and conduct of agroforestry experimentation. It is divided into a plant and a soil compartment. The soil compartment simulates changes in soil stability and fertility over a specified period by considering soil erosion — based on a simplified version of the Universal Soil Loss Equation (FAO, 1979) — and carbon and nitrogen cycling. Changes in plant growth over time in response to changes in the soil compartment are estimated using a number of user-specified feedback factors which describe the extent to which soil factors influence plant growth.

The basic input data used for the SCUAF simulations conducted here were presented by Young and Muraya (1990). These simulations assumed a constant rate of inorganic fertiliser application of 100 kg of 40% N per year. Grains from the pigeon pea/maize intercrop were harvested annually for human consumption and therefore represented losses to the system. Residues from both crops (pigeon-pea haulms and maize stover) were also removed for animal feeding but compost was accounted for, where appropriate, as an input to the SCUAF model. The woody above-ground parts of the pigeon pea remain in the system from year to year as standing biomass and the roots which die and decompose at varying rates return nutrients to the labile pools in the soil.

To run the joint simulations, the crop model was used to produce yearly forage inputs for APM. On the basis of these, APM supplied input data on the quantity and quality of organic matter returns to the soil for SCUAF for the following year. Years were considered to be identical except for the levels of removals, determined by SCUAF, and returns, determined by APM.

Feed and compost-management scenarios for each joint simulation were developed using the APM simulations of the effects of herd size, access to grazing and use of supplementary feeding. It was assumed that, for a given feed-management strategy, the farmer adopted a herd size which maximised the live weight gained by the herd as a whole. Thus, the four basic management scenarios used in defining conditions for the joint simulations were:

1. All crop residues removed for feeding but no return of compost. In this simulation, there would be no feedback effects of livestock management on the crop component (net outflow of N in feeds from crop land = 47.28 kg/year).
2. Removal of crop residues for feeding and all compost returned subsequently for fertilising the crop. No grazing or supplementary feeding of a herd of two animals (net outflow of N in feeds from the crop = 19.56 kg/year).
3. As for simulation 2 but with a herd of four animals grazed for 8 hours per day (net outflow of N in feeds from the crop = 21.84 kg/year).
4. As for simulation 3 but with a herd of ten animals also offered 0.5 kg per head per day of supplementary groundnut cake (net outflow of N in feeds from the crop = -31.08 kg/year).

The results of these simulations were related to a baseline simulation in which all crop residues were returned to the crop directly, after harvest. This represents the pigeon pea–maize intercrop with no associated livestock component.

## **Results and discussion**

### **Simulation of published experimental and field observations**

Faecal and urinary nitrogen production from indigenous Malawi goats consuming diets with a range of nitrogen contents observed experimentally (Reynolds, 1981) and predicted by APM using input data derived from this study are shown in Figure 1. Accurate quantitative prediction of the individual

**Figure 1.** Comparison of observed and predicted values for N excretion by indigenous Malawi goats consuming different levels of nitrogen (observed values from Reynolds, 1981).

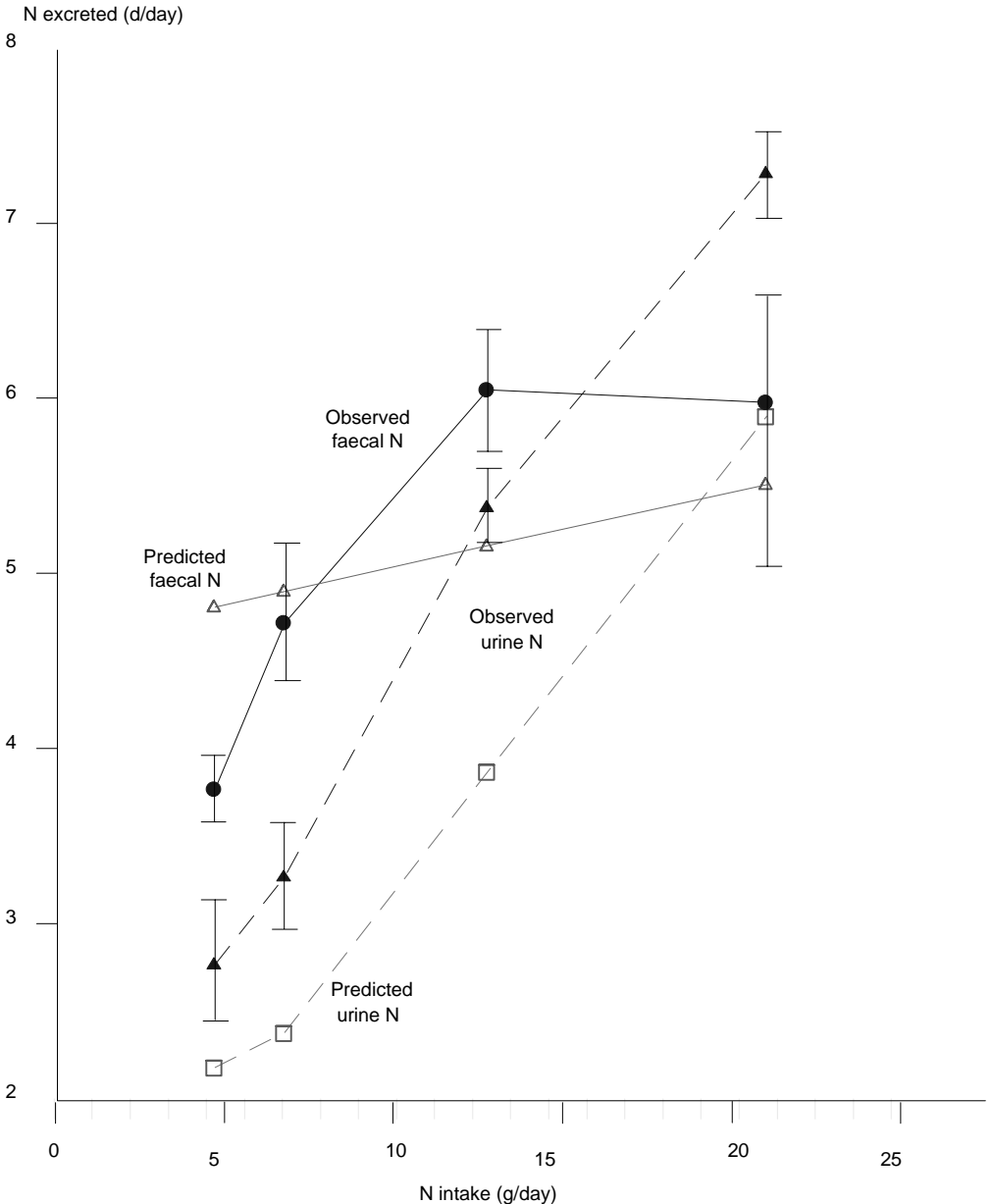

experimental observations was not achieved by the model as, in general, predicted values fall outside the ranges of the errors associated with the observed values. However, the direction and rates of the predicted responses to increasing dietary N were significantly correlated (faecal N,  $r^2 = 0.676$ ; urine N,  $r^2 = 0.981$ ) with those observed *in vivo*.

Similar inaccuracies were also observed in the quantitative prediction of nitrogen balance (Table 5) but again, correlation over the range of treatments was significant ( $r = 0.959$ ). Growth performance

data were not available for the experiment. However, weight changes predicted by the APM model (also shown in Table 5) were, to an extent, consistent with the observed nitrogen balance data. As might be expected animals that were in negative N balance in the experimental study lost weight in the simulations. However, the group with the highest predicted percentage of ingested nitrogen retained was not the group with the fastest growth rate in the experimental study and the levels of N retention predicted might have been expected to be associated with rather higher rates of gain.

**Table 5.** *Predicted and observed nitrogen balances and predicted growth rates.*

Treatment	Nitrogen balance		Predicted weight change (g/day)
	Observed	Predicted	
Hay	-1.81±0.394	-1.85	-94
Hay + concentrate 1	-1.20±0.357	0.00	-31
Hay + concentrate 2	1.11±0.312	3.98	35
Hay + concentrate 3	7.45±0.378	9.61	17

Source: Reynolds (1981).

The inadequacies of the predictions, for urine N production at least, would appear to be errors of quantification rather than due to the general formulation of the relationships which define the model. This implies that there are inaccuracies in the data used within the simulations. It is suggested that the parameters most likely to be responsible are those which describe protein degradation in the rumen (a, b and c) and ADIN which contributes directly to faecal N levels. Values used in the model are derived means for each different class of feed but, for a, b and c, are likely to be subject to quite large inaccuracies as these parameters are highly variable (Webster, 1993) even when determined for the same samples at different laboratories. The use of ADIN to represent undegradable, undigested nitrogen has been adopted relatively recently, therefore, only limited data are available on which to base model predictions. Thus, increasing the accuracy with which a, b, c and ADIN are quantified is likely to be the most significant barrier to improving the quantitative predictive capacity of the model in future. Direct input of these parameters for feeds used in simulations could be expected to increase accuracy of prediction. However, these data are not widely available for practical situations and insistence on their use would probably compromise the utility of the model.

### **Effects of feeding and management strategies on livestock production and nutrient flows in a mixed crop–livestock system**

Changes in the production of live weight by herds in response to increasing herd size followed similar patterns under all conditions of feed availability simulated with the APM model (Figure 2). Daily liveweight gain (DLWG) by individual animals decreased initially as the quality and quantity of feed available to each one declined. In contrast, total liveweight production increased initially to a peak with increasing herd size. As herd size was increased further, liveweight production declined as the incremental reduction in DLWG in all animals due to the reduction in nutrient intake brought about by the sharing of available feed with an additional animal exceeded the increase in live weight due to that extra animal. Not only the size but also the position and shape of the peak in live-weight production was dependent on feed availability. Increased feed availability due to the provision of supplements or, in particular, grazing shifted the peak to a larger herd size.

Grazing access also tended to broaden the peak as the provision of extra forage, proportional to the number of animals in the herd, allowed the higher quality feeds (pigeon-pea haulm and groundnut cake) to be spread more widely. A similar response to supplementation was observed when a fixed allowance per animal was offered rather than allowing this to vary by the allocation of a flat rate for the herd. The provision of grazing and supplements in this way could potentially allow farmers more

Figure 2. Effects of herd size, supplementation and grazing access and their interactions on growth rates and production of live weight (LW).

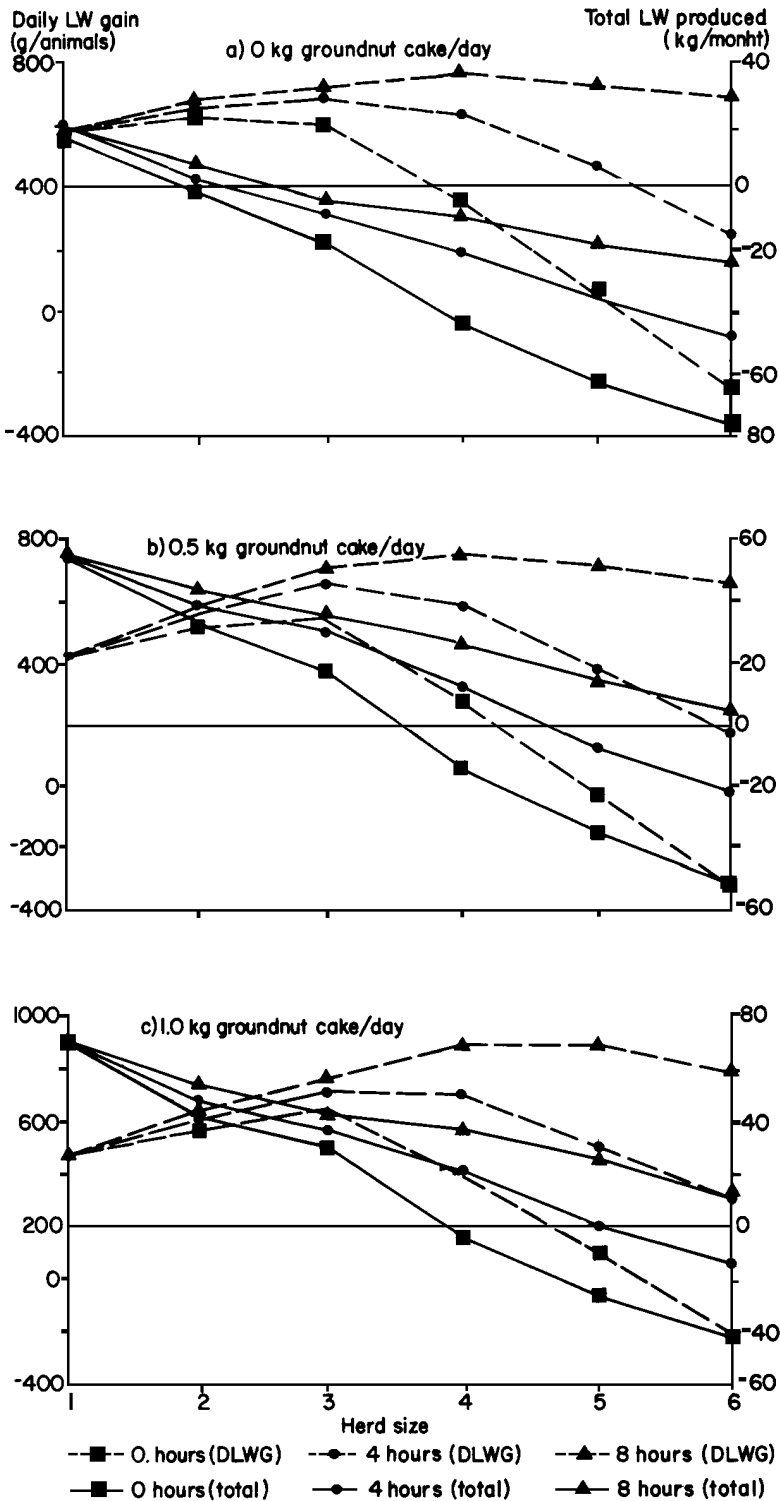

flexibility in planning stocking rates. If total live weight produced is similar over a range of herd sizes, there is scope for optimising other variables such as nutrient fluxes within that range.

The relationships between herd size and the sources and quantities of nitrogen in the compost under the different supplementation regimes are shown in Figure 3 and different levels of grazing access in Figure 4. In general total N in the compost tended towards a minimum with increasing herd size. This minimum was observed when herd size was large enough for all offered feeds to be consumed. Subsequently compost N increased with increasing herd size due to the progressively larger contributions of endogenous urinary and faecal N.

Sources of nitrogen in the compost are likely to have a significant effect on its quality as a soil adjuvant. In small herds which do not consume all the available feed, a proportion of the compost is made up of maize stover and at higher levels of supplementation and grazing a limited amount of pigeon pea haulm. Manure nitrogen is probably of higher value as a soil adjuvant than undegraded plant material (Sandford, 1989) although some undegraded plant material is necessary for good quality compost and efficient urine capture. Animals in small herds also consume diets of higher quality in terms of dietary protein:energy ratio. Under these conditions the ratio of faecal to urine nitrogen is lower. This highlights the importance of management practices, such as the provision of bedding or placement of stalls on land that is to be cropped in future, that are aimed at conserving urine N, particularly when improved feeding practices are introduced. The consequences of ineffective urine capture have been demonstrated in practice by Powell and Williams (1991) who observed increases in DM production of more than 50% in plots treated with manure and urine in comparison with other plots treated with manure alone.

Responses in nitrogen excretion to increasing herd size when grazing access was allowed were similar although total N in the compost was reduced at a particular herd size as a proportion of faeces and urine was excreted on the pasture. If herd sizes optimum for liveweight production are compared for grazing and non-grazing animals, levels of N added to compost are similar but the provision of supplements resulted in higher levels of compost nitrogen at optimum herd size.

The division by the model of nitrogen excreted in faeces and urine between pasture and compost assumes that there is no diurnal variation in output. There is, however, evidence that this is probably not the case in practice as marked diurnal variation in faecal and urine production and N content has been observed experimentally. Betteridge et al (1986) suggested that up to 66% of urinary nitrogen may be excreted during the night.

Figure 5 shows the effects of the size of a herd grazing eight hours per day on net fluxes from the cropland both with and without the provision of 0.5 kg of groundnut cake per animal per day. This simulation illustrates how animals can act as importers of nutrients into crop land. The removal of crop residues for livestock feeding represents a constant flow of 47.28 kg of nitrogen per year from the cropland. In the unsupplemented herd, a net flow of zero does not occur until a herd size of 10 is reached. At this stage, the herd is losing live weight. With supplementation, a net flow of zero is achieved within the range in which live-weight production is maximised. Furthermore, the high rate of supplementation ensures that the peak for live-weight production is broad and, at a herd size of 13, outflows from the plot can be returned in faecal nitrogen alone reducing the importance of efficient husbandry of urine. This latter simulation illustrates how intensification of feeding systems in crop–livestock systems through the use of agro-industrial by-products are likely to lead incidentally to improved sustainability of associated crop production activities.

## **Interfacing with soil nutrient models**

While net fluxes can be evaluated using APM alone, the wider effects of the quantities and composition of compost available in crop–livestock systems need to be evaluated using the APM model in conjunction with the SCUAF model.

**Figure 3.** Effects of herd size and supplementation on sources and quantities of nitrogen in compost.

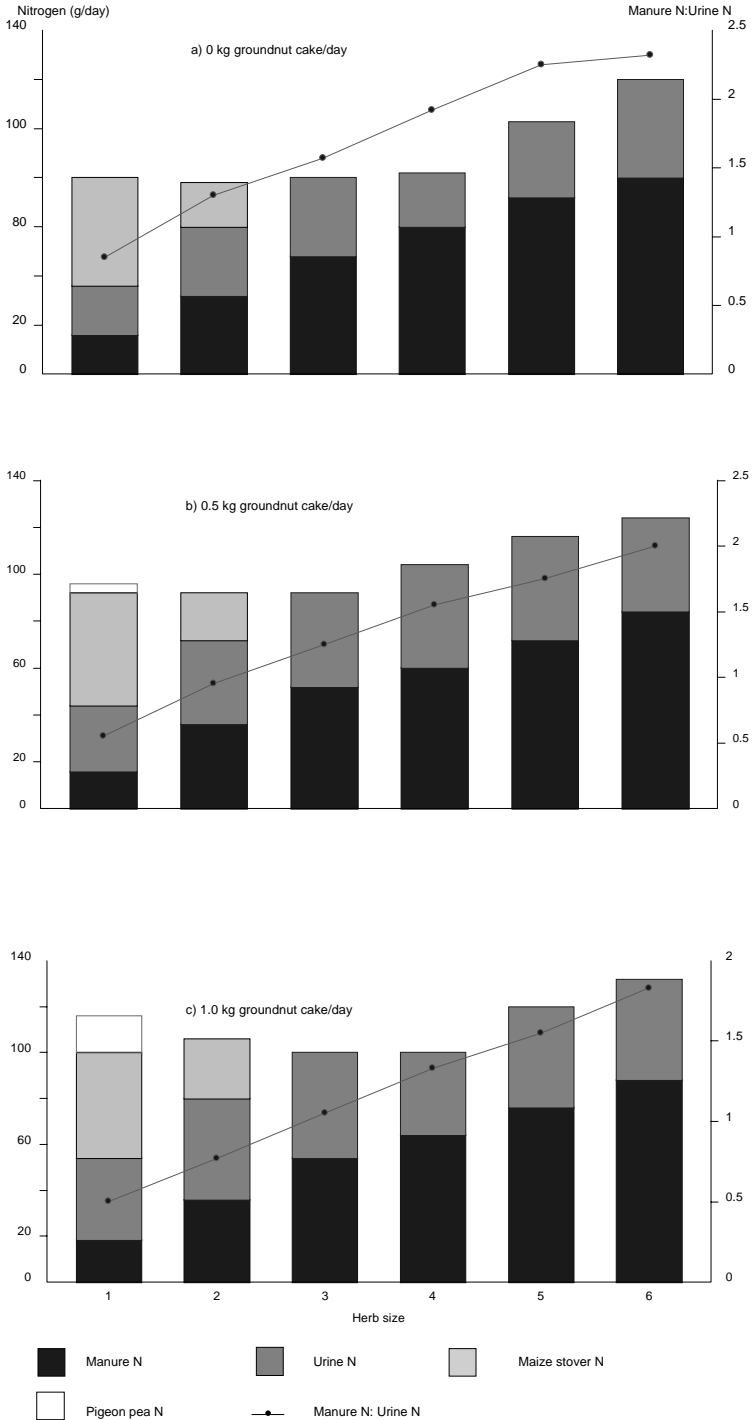

**Figure 4.** Effects of herd size and grazing access on sources and quantities of nitrogen in compost.

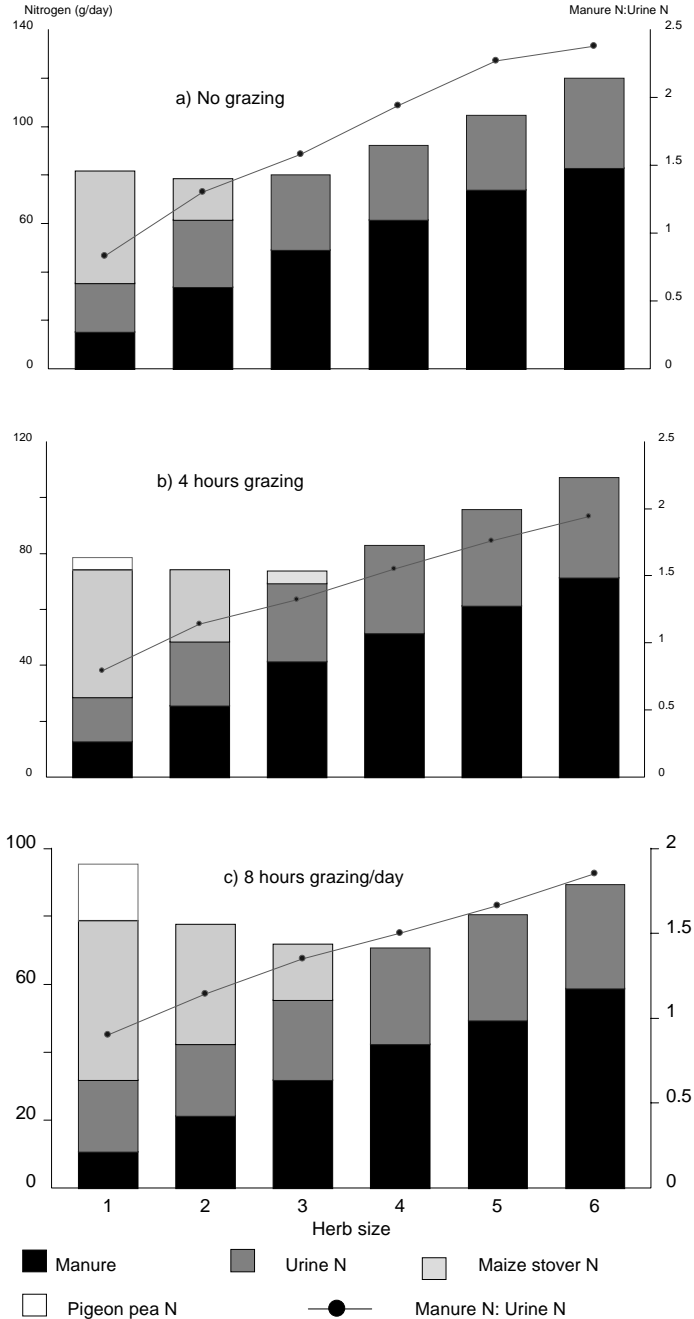



Figure 5. Effects of size of a grazed herd and supplementation on net nitrogen fluxes from cropland.

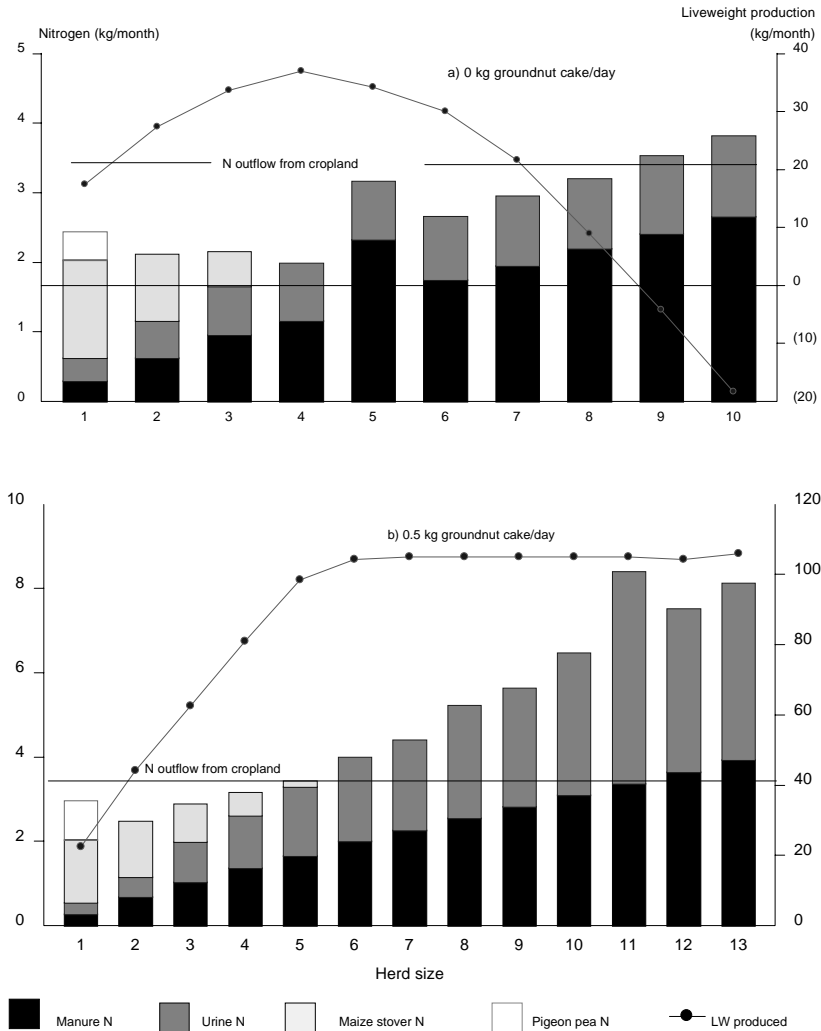
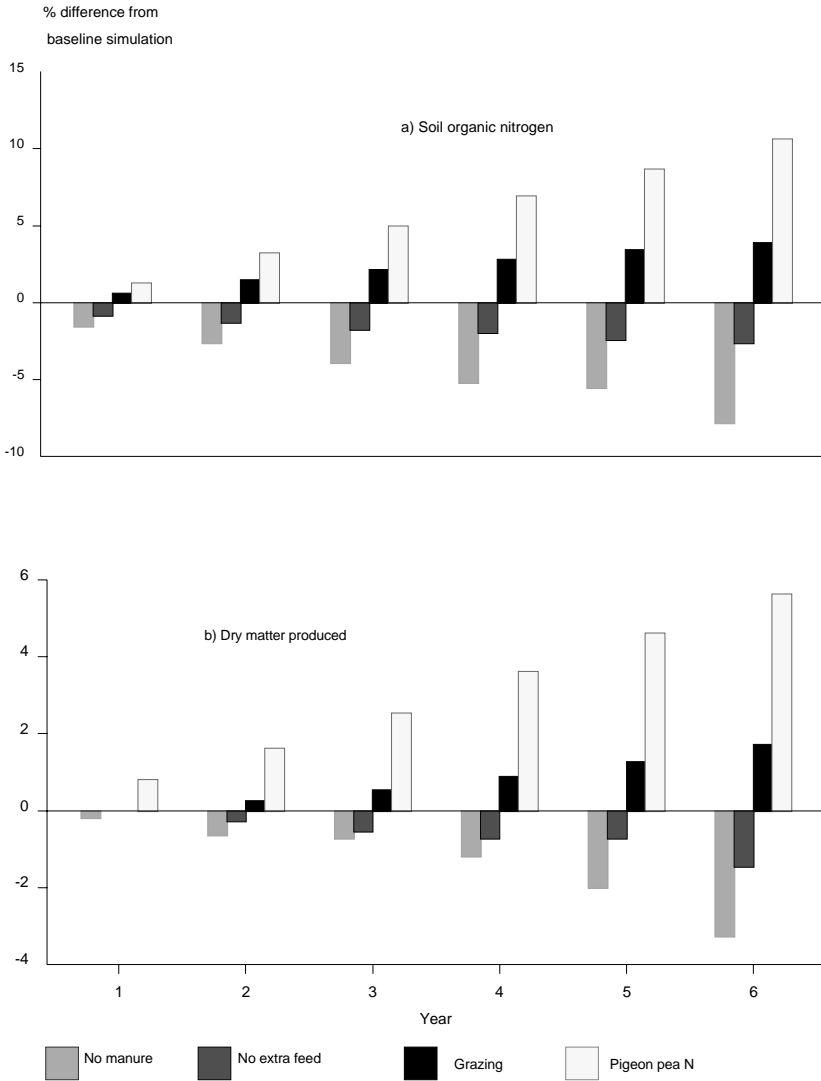

Figure 6 illustrates the consequences of the four scenarios used in the joint simulations on changes in soil organic matter and crop productivity over the six-year period of the simulations. It is not surprising that under scenario 1 the removal of crop residues for feed with no return of compost results in an accelerating decline in soil organic nitrogen and crop productivity. Equally expected is the increase in soil organic nitrogen and productivity observed under scenario 4 where there was a net influx of 31.08 kg/year of compost nitrogen into the plot.

**Figure 6.** Effects of feed and compost management scenarios on soil organic nitrogen and crop production (SCUAF simulations).



Perhaps most interesting are the differences between scenarios 2 (no grazing or supplementation) and 3 (8 hours grazing per day). Although net annual N fluxes were similar (19.56 versus 21.84 kg/year), more than twice the volume of compost dry matter was returned under scenario 3 (2188 versus 1009 kg/year) which supported a herd size of four as opposed to two animals. This is reflected by differences in the ratios of carbon to nitrogen in the organic returns which, under scenario 2, averaged 15.5 and under scenario 3, 34.5. The higher organic-matter returns under scenario 3 are likely to be more beneficial for soil structure and would thereby promote more effective retention of N in the soil.

## Conclusions

Modelling studies conducted to date indicate a need for improved parameterisation to account for the effects of livestock on nutrient cycle dynamics under tropical conditions. There are three areas in which this could be particularly improved:

- Integration of the effects of other feed factors such as tannin which affect protein metabolism and soil processes and are found in a range of tropical feeds.
- A treatment of diurnal variation in manure and urine production or, failing this, an ability of the model to test the sensitivity of simulations to variation in these parameters.
- Increase the potential of animal models to interface directly with soil models, a treatment of the degradation of manure and urine, post-voiding.

The current study has also identified problems in assimilating basic data for running simulations of nitrogen transactions in the animal for a wide range of tropical feeds. The use of multivariate statistical analysis to identify groups of feeds with common properties relating to the degradation and digestibility of nitrogen might promote improvements in the ability of the APM model make quantitative predictions.

## References

- ARC (Agricultural Research Council). 1980. *The nutrient requirements of ruminant livestock*. CAB (Commonwealth Agricultural Bureaux), Farnham Royal, UK. 351 pp.
- Betteridge K, Andrews W G K and Sedcole J R. 1986. Intake and excretion of nitrogen, potassium and phosphorus by grazing steers. *Journal of Agricultural Science (Cambridge)* 106:393–404.
- Dewhurst R J and Thomas C. 1992. Modelling of nitrogen transactions in the dairy cow and their environmental consequences. *Livestock Production Science* 31:1–16.
- FAO (Food and Agriculture Organization of the United Nations). 1979. *A provisional methodology for soil degradation assessment*. FAO, Rome, Italy. 84 pp.
- Forbes J M. 1986. *The voluntary food intake of farm animals*. Butterworths, London, UK. 206 pp.
- IDWP (Interdepartmental Working Party). 1992. Nutritive requirements of ruminant animals: Protein. AFRC Technical Committee on Responses to Nutrients Report 9. *Nutrition Abstracts and Reviews (Series B)* 62(12):787–835.
- Orskov E R and McDonald P. 1979. The estimation of protein degradability in the rumen from incubation measurements weighted according to rates of passage. *Journal of Agricultural Science (Cambridge)* 92:499–503.
- Osafo E L K, Owen E, Said A N, Gill M, McAllan A B and Sherrington J. 1992. Feeding sorghum stover to Ethiopian yearling cattle: Effects of amount of stover offered and cottonseed cake supplement on intake and growth. *Animal Production* 54:501. (Abstract)
- Parton W J, Schimel D S, Cole C V and Ojima D S. 1987. Analysis of factors controlling soil organic matter levels in Great Plains grasslands. *Soil Science Society of America Journal* 51:1173–1179.
- Powell J M and Williams T O. 1991. Etudes de fumure effectuées par le Centre international pour l'élevage en Afrique (CIPEA), Niger. *Echanges Plus* 6:7–9.
- Reynolds L. 1981. Nitrogen metabolism in indigenous Malawi goats. *Journal of Agricultural Science (Cambridge)* 96:347–351.
- Rittner U and Reed J D. 1992. Phenolics and *in vitro* degradability of protein and fibre in West African browses. *Journal of the Science of Food and Agriculture* 58:21–28.
- Sandford S G. 1989. Crop residue/livestock relationships. In: ICRISAT (International Crops Research Institute for the Semi-Arid Tropics), *Soil, crop and water management systems for rainfed agriculture in the Sudano-Sahelian zone*. Proceedings of an international workshop held at the ICRISAT Sahelian Center, Niamey, Niger, 11–16 January 1987. ICRISAT, Patancheru, India. pp. 169–182.
- Sivapalan K. 1982. Humification of polyphenol-rich plant residues. *Soil Biology and Biochemistry* 14:309–310.
- Thornley J H M and Verberne E L J. 1989. A model of nitrogen flows in grassland. *Plant Cell and Environment* 12:863–886.

- Tian G, Kang B T and Brussard L. 1992. Biological effects of plant residues with contrasting chemical compositions under humid tropical conditions – decomposition and nutrient release. *Soil Biology and Biochemistry* 24:1051–1060.
- Webster A J F. 1993. The metabolizable protein system for ruminants. In: Haresign W and Garnsworthy P C (eds), *Recent advances in animal nutrition – 1992*. Butterworths, London, UK. pp. 93–110.
- Young A and Muraya P. 1990. *SCUAF, soil changes under agroforestry*. ICRAF (International Centre for Research in Agroforestry), Nairobi, Kenya. 124 pp.

# Myth and manure in nitrogen cycling: A case study of Kaloleni Division in Coast Province, Kenya

*L. Reynolds and P.N. de Leeuw*

1. 70, Springfield Crescent, Kibworth Beauchamp, Leicester LE8 0LH, UK (formerly with ILCA)
2. International Livestock Centre for Africa (ILCA), P O Box 46847, Nairobi, Kenya

## Abstract

A simulation model was developed that predicts dry-matter (DM) and crude-protein (CP) intake and associated cattle performance based on live weight, age, pasture conditions and supplementary feeding. Intake data were used to estimate the amount of nitrogen (N) retained by cattle and that excreted in faeces and urine. The N levels in excreta were varied according to the nature, quantity and quality of the diet. Dietary CP level and degradability further influences N excretion in urine and faeces. The availability of excreted nutrients for recycling through soils depends on the livestock management system. The model was also used to examine the effects of on- and off-farm feed supplies and differences in livestock holdings on the on-farm nutrient inputs from livestock in Kaloleni Division of coastal Kenya. Nutrient requirements for the entire livestock population were calculated and matched with feed resources to predict how rural population density affects the balance between feed demand and supply. The model showed that cattle owners are able to provide a net input of 25 kg N/ha to their maize, sufficient to maintain a grain yield of 1.8 t/ha. Farmers without cattle suffered a net outflow of N from grazing of crop residue by cattle from other farms. As human population density increases and farm size declines, cattle owners obtain a decreasing proportion of animal feed from their own farms, and cattle spend more time grazing elsewhere. Hence, the net inflow of N will rise at the expense of the rest of the community. Purchased concentrates, an economically viable alternative for dairy cattle, are another external nutrient source for raising the N levels in excreta and can help maintain soil fertility.

## Le fumier dans le recyclage des éléments nutritifs: étude de cas du district de Kaloleni dans la province côtière du Kenya

*L. Reynolds<sup>1</sup> et P.N. de Leeuw<sup>2</sup>*

1. 70, Springfield Crescent, Kibworth Beauchamp, Leicester LE8 0LH (R.-U.) (précédemment en service au CIPEA)
2. Centre international pour l'élevage en Afrique (CIPEA), P.O. Box 46847, Nairobi (Kenya)

## Résumé

*Un modèle de simulation a été construit pour prévoir la consommation de matière sèche (MS) et de protéines brutes (PB) et les performances des bovins à partir du poids vif, de l'âge, de l'état des pâturages et du niveau de complémentation. Les données d'ingestion ont été utilisées pour évaluer les quantités d'azote (N) assimilées par les animaux, et les quantités excrétées dans les fèces et l'urine. La teneur en azote des excréments dépendait de la nature, de la quantité et de la qualité des aliments. Le taux et la dégradabilité des protéines brutes de la ration influençaient aussi l'excrétion d'azote dans les fèces et l'urine. La proportion des éléments nutritifs excrétés qui étaient recyclés dans le sol dépendait du mode de gestion des animaux. Le modèle a également été utilisé pour examiner l'effet des compléments endogènes ou exogènes et des effectifs animaux sur les quantités d'éléments nutritifs recyclés par le bétail dans le district de Kaloleni sur la côte kényenne. Les besoins en éléments minéraux ont été calculés pour l'ensemble du cheptel et comparés aux ressources alimentaires afin*

*de déterminer l'effet de la densité de population rurale sur l'équilibre entre la demande et l'offre d'aliments du bétail. Il ressort des résultats que les propriétaires de bovins peuvent apporter à leur maïs une quantité nette de 25 kg de N/ha, suffisante pour assurer un rendement grains de 1,8 t/ha. Les terres des agriculteurs sans bovins subissaient des pertes nettes d'azote par suite de la pâture des résidus de culture par les bovins. Avec l'augmentation de la densité de population et la diminution de la taille des exploitations, les propriétaires de bovins n'obtenaient sur leurs exploitations qu'une proportion décroissante des aliments du bétail dont ils ont besoin et les animaux passaient plus de temps à pâturer ailleurs. Par conséquent, le flux net d'azote augmentait au détriment du reste de la communauté. L'achat de concentrés, alternative économiquement viable pour l'élevage de bovins laitiers, est une autre source externe d'éléments nutritifs capable d'augmenter le taux d'azote excrété et de maintenir la fertilité des sols.*

## Introduction

Plant material is the primary level of production from land, with animals (humans, domesticated and wild animals) as secondary users in competition for plant material. Most of the consumed nutrients are rapidly returned by animals to the soil in faeces and urine, but nutrients are removed when plant material is consumed and the nutrients retained in body tissue or in milk. Nutrients are returned to the soil in excreta when livestock products are consumed by other animals, and later when animals die and their carcasses decompose.

In areas of high population density, grazing areas may no longer be available. Cultivated forages, with natural forages from on- and off-farm sources, sometimes supplemented with purchased feeds, provide the necessary dietary nutrients for animal production. Animals may be confined and hand-fed or tethered on the farm. With lower population densities, grazing on- and off-farm is more common. Grazing animals consume plant biomass growing over a wide area, but faecal and urine deposits are concentrated in patches. Farmers can take advantage of this by collecting manure from kraals to spread over their cropland. Urine is more difficult to collect, except with stall-fed animals on concrete. A large area is depleted of nutrients to the benefit of a small area. Grazing livestock can enhance the nutrient status of cropped areas on mixed farms, but at the expense of extensive grazing areas.

It is difficult to collect sufficiently detailed data on-farm to accurately measure the flows of nutrients within, to and from a farm. The objective of this paper is to explore ways of estimating nutrient balances based on milk production and reproductive performance of cattle, estimate dietary nutrient requirements to achieve that level of production, and the probable faecal and urine nutrient outputs. Predictions of animal requirements for given levels of production, and corresponding faecal and urine output are based on equations developed in Australia for grazing animals (SCA, 1990). A further simulation model predicts the feed availability, animal requirements and nitrogen (N) excretion for a case study area (Kaloleni Division of Coast Province, Kenya) and indicates the overall effect on N balance on- and off-farm for increasing levels of human population density.

The SCA model takes an approach similar to that of the Agricultural Research Council (1980; 1992) requiring information on age, body weight, sex and physiological state of an animal, and on dry-matter (DM) energy and protein intake, and degradability of the protein. In addition, SCA allows predictions of intake to be made for grazing animals based on pasture biomass, composition and quality. Since tropical rations, especially when forage-based, are more heterogeneous than the rations on which cattle are raised in temperate regions, post-ruminal protein digestibility for undegraded dietary protein is based on protein concentration in the forage (Webster et al, 1982) rather than using a fixed value.

The spreadsheet predictions start from dietary protein and energy intake, and assume that faecal N is determined by dietary N degradability, post-ruminal digestibility and absorption of microbial N and undegraded N, plus endogenous N. Urinary N is determined by the efficiency of utilisation of

absorbed N, unutilised N from rumen-degradable protein RDP and dietary non-protein nitrogen (if limited by dietary metabolisable energy (ME)), plus endogenous N.

Firstly, the effects are shown of cattle at different production levels on the nitrogen balance within farms. It highlights the role of sources of feed external to the farm in raising the amounts of N excreted in faeces and urine which can provide nitrogen inputs for soil fertility and plant growth. Secondly, using survey data from the semi-humid coastal lowlands of Kenya, the effects of livestock are shown on nitrogen balance of smallholder farms in the coconut/cassava (CL3) and cashewnut/cassava (CL4) agro-ecological zones.

## Dietary intake and nitrogen excretion

The efficiency with which dietary nutrients are converted by indigenous tropical cattle to animal products is low. Livestock in a typical tropical smallholder system will retain less than 20% of the ingested N for productive purposes. The rest is expelled in faeces and urine. Livestock provide an anaerobic environment for rumen microbes to extract soluble N and some of the insoluble N compounds from ingested dietary material. Further along the intestinal tract, enzymes secreted by the animal allow absorption of N compounds to occur, before the remainder are excreted in faeces. Absorbed but unwanted N, and N from metabolic by-products are excreted in urine.

### Animals at maintenance

A zebu cow on pasture weighing 190 kg and consuming 2.4% of its body weight of a ration with 80 g crude protein (CP)/kg DM, N degradability of 0.70 and 8 MJ ME/kg DM, has a net maintenance requirement of 117.5 g CP/day (18.8 g N/day). Dietary requirements (SCA, 1990) are higher than net N requirements because of inefficiencies in digestion, absorption and assimilation. For the reference animal dietary N needs are 58.7 g/day, producing a total faecal output of 34.8 g N and urine excretion of 23.0 g N.

Maintenance requirements are dependant upon dietary CP level (Figure 1) and the degradability of N in the ration (Figure 2). When N degradability is 0.80, maintenance would be achieved with an intake of 2.0% of body weight, with a daily faecal and urine N output of 26.7 and 22.0 g N, respectively.

### Animals above maintenance

If intake is higher than 2.4% of body weight on a ration with 80 g CP/kg DM, N degradability of 0.7 and 8 MJ ME/kg DM, the animal will retain N in the body. As the quantity of N in the ration increases, the level of N retained in the body will rise, as will faecal and urine excretion (Figure 3). At an intake of 2.7% of body weight on the ration used in the maintenance example, the animal will retain 0.9 g N/day, losing 38.9 g N in faeces, and 24.9 g N in urine. As N degradability increases, N retention and urinary N losses increase, but faecal N losses decline (Figure 4).

Less N will be returned to the soil in excreta than have been removed by the grazing animal. Animal production must involve the storage of nutrients taken from plant (and hence from soil) in body tissue or milk. Farmers only receive an income from livestock when milk or meat are sold, and this inevitably involves removal of nutrients from the farm.

### Animals below maintenance

If intake is less than 2.4% of body weight on the ration described for maintenance, the animal will excrete more N than it consumes. At an intake of 2.0% of body weight faecal excretion will be 28.8 g and urine 20.2 g N/day: a net loss of 1.3 g N/day. Under these circumstances, more N is returned to the soil than was removed during grazing.

**Figure 1.** Effect of N degradability and DMI on retained N (g/day) for a 190-kg grazing cow receiving a ration containing 8 MJ ME/kg DM, and 80 g CP/kg.

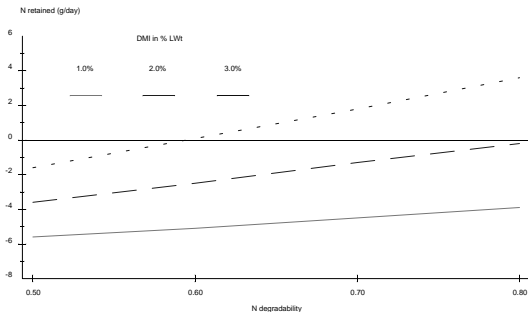

**Figure 2.** Effect of dietary CP level and DMI on retained N (g/day) for a 190-kg grazing cow receiving a ration containing 8 MJ ME/kg DM, and N degradability of 0.70.

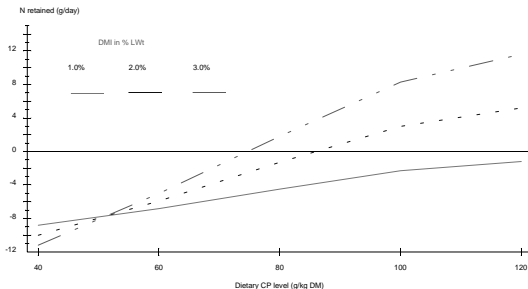

## Spatial considerations: Grazing versus stall-feeding

A grazing cow may walk 2 to 6 km per day, with a grazing area of approximately 0.5 m on either side of its line of passage. Hence, the total area from which forage has been harvested may be between 0.2 and 0.6 ha/day. Over 24 hours, a grazing animal defaecates 10 to 12 times, and urinates 4 to 6 times. Dung will cover a total area of approximately 1 m<sup>2</sup>, and urine 2.5 m<sup>2</sup> (Holmes, 1980). Excreta are



**Figure 3.** Effect of dietary CP level and DMI on faecal and urinary-N excretion (g/day) from a 190-kg grazing cow receiving a ration containing 8 MJ ME/kg DM and degradability of 0.70.

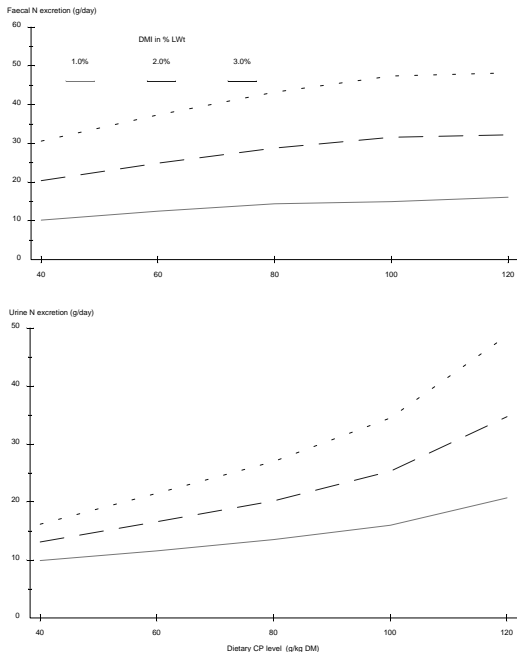

deposited where animals are grazing. It can be assumed that the amount of excreta dropped while grazing is proportional to the time spent in that area. With a grazing time of 8 hours per day, one-third of total excreta will be deposited in the field, and two-thirds in the kraal.

Urine deposited in the kraal will partly be absorbed in the dung layer, but will also soak into the underlying soil. Kraal manure taken to cropland will contain therefore only a portion of the N excreted by the animal in the kraal. Temporary corralling on cropping areas before planting allows *in situ*

**Figure 4.** Effects of N degradability and DMI on faecal and urine-N excretion (g/day) for a 190-kg zebu cow grazing 8 MJ ME/kg DM and 80 g CP/kg DM.

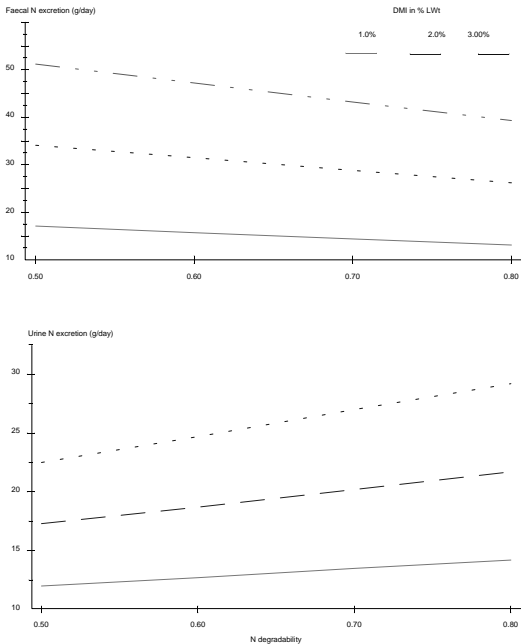

manuring (Powell, 1986), avoiding the labour of transporting manure to cropping areas. It also allows urine to be deposited where it will be most useful.

### Temporal considerations in manure production and use

In most parts of Africa there is a relatively short time during a year when food crops are growing, and it is during this period when nutrients from manure are most needed. Soluble N in manure, and urine

N are almost immediately available to plants, while insoluble N, tied to undigestible plant residues will only be mineralised slowly. However, manure is deposited year round, and nutrient losses occur when dung is left on the soil surface, and from urine absorbed in the soil. Excreta dropped at pasture by a grazing animal lose around 50% of urine N over a few weeks, and 5% of faecal N, mainly from the soluble fraction and mostly from volatilisation. There are smaller losses from denitrification and leaching.

Thus, half of the N consumed by an animal at a maintenance level of production will be lost from the excreta before it can be re-used by soil microflora and fauna, and by plants. The rate of mineralisation of N is faster, and losses from volatilisation are greater from animal excreta than from plant litter. Vertregt and Rutgers (1988) estimated that ammonia losses accounted for four times as much of the N excreted from animals when compared with the N losses from decaying herbage from pasture. Hence, although animal excreta provides nutrients for plants in a more usable form, the loss of N from the system is accelerated.

When manure is collected in the kraal or from a stall, it accumulates daily. Whether it is stored *in situ* on the floor of the kraal, in a manure heap or a slurry pit, losses of N will occur before the excreta is needed on cropland. Losses in a manure heap will be slower than from the equivalent amount of dung in scattered pats on pasture, because the surface area exposed to the atmosphere is less. Losses of N between the deposition of excreta in a stall unit with subsequent storage in an open heap, and application on the land were estimated to be up to 55% of total N (Iowa State University, 1975).

Composting can occur in the interior of a manure heap, and this will accelerate the mineralisation of N, so that when the compost is spread on cropland, nutrients will be available for plant use more rapidly. Slurry, a mixture of excreta and water, shows higher losses of N from volatilisation when applied to the surface of the soil, than when it is incorporated in the soil.

## Closed versus open farming systems

In a closed or subsistence farming system, there is no import or export of nutrients to or from the farm. There is no sale of live animals, meat or milk, and no forage from outside grazing or supplementary feed enter the farm. Animals obtain nutrients only from on-farm natural pasture, cultivated forages and crop residues.

With animals at maintenance, by definition, intake of N is equal to output of N, and there is theoretically no overall effect on the N balance of the farm. However, because of the volatile nature of much of the N in excreta, a portion is lost to the atmosphere. The overall result is a decline in the N status of the farm as a result of the presence of livestock, even if the farm is operated at a subsistence level.

In an open or commercially oriented farm, nutrients will be exported in milk and meat. There must be a net drain on farm nutrients if all the feed has been produced on the farm, but when animals graze outside the farm or where supplementary feeds are purchased, a profit and loss account for nutrients can be drawn up. For example a 190-kg cow grazing for 8 hours/day, consuming 7.4 kg DM/day (the equivalent of 3.9% of body weight) containing 81 g CP/kg DM (degradability of 0.70) and 10.4 MJ ME/kg DM, and producing 1.0 kg milk/day will have an intake of 96.0 g N, of which 5.1 g will be found in milk, 0.9 g in dermal losses, 56.6 g in faeces and 33.4 g in urine.

The N balance of the farm will benefit if more feed N is brought on to the farm than is removed when the milk is sold. The calculation is simple if external feed sources are a supplement to on-farm grazing, and livestock do not move off-farm. In this case, N in the supplement must be greater than N in any milk sold off-farm for a positive N balance to occur. The situation is slightly more complicated when livestock graze on- and off-farm, because nutrients will be ingested and excreted throughout the day, some on-farm, and some off-farm. Intake depends upon a combination of animal and pasture characteristics and their interactions. Excretion in a particular location is largely dependent upon the time spent there. If the reference animal spends eight hours grazing, of which two hours are on-farm and six off-farm and assuming that all the milk is consumed on-farm, the net gain of N to the farm will be 60.0 g/day.

If the farmer provides, from off-farm sources, 1 kg of supplement containing 160 g CP/kg DM with a degradability of 0.65 to the grazing animal described above, daily intake will increase to 7.52 kg (4.0% of body weight) as the supplement acts as a partial substitute for some of the forage, and milk yield will increase to 2.0 kg/day, containing 10.2 g N. Nitrogen intake will increase to 111.5 g, with dermal, faecal and urine losses of 1.1, 62.2 and 37.9 g N/day, respectively. Given an 8-hour grazing period, 67% of the excreta will be dropped in the kraal area (i.e. 41.7 g faecal N and 25.4 g urine N). If grazing is divided between two hours on-farm and six hours off-farm, the net gain to the farm will increase to 71.4 g N/day.

## Kaloleni Division, Kenya coast

Jaetzold and Schmidt (1983) reported that the 1979 population of Kaloleni was 151 500 people, in 21 700 rural households. Agricultural land accounted for 915 km<sup>2</sup>, with roads, homesteads and rivers covering 98 km<sup>2</sup>, and steep slopes (unsuitable for agriculture) covering the remaining 40 km<sup>2</sup> totalling 1053 km<sup>2</sup>. Thus, on agricultural land, there is a density of 143 persons/km<sup>2</sup>, implying an average farm size of 4.2 ha. In Kaloleni, agro-ecological zone CL3 (coconut/cassava) covers 160 km<sup>2</sup>, CL4 (cashewnut/cassava) covers 429 km<sup>2</sup> with a further 326 km<sup>2</sup> in drier areas. A small-scale farm survey of CL3 and CL4 zones in 1977, which included part of Kaloleni Division, reported an average of 5 cattle, 2 sheep and 16 goats per household.

In 1988/89 ILCA undertook a survey of 1800 households in CL3 and CL4 agro-ecological zones of Kaloleni. Total farm size for the first and second plot combined was 5.7 ha for households based in CL3 and 7.6 ha for households based in CL4, implying only 2802 and 5608 households in the two respective zones (Thorpe et al, 1993).<sup>1</sup> Farm size and livestock holdings are summarised in Tables 1 and 2. In zones CL3/4 of Kaloleni there are 17 917 tropical livestock units (TLU) from cattle, 94% of which were zebu animals, and 2859 TLU from small ruminants, giving a total of 20 776 TLU and a density of 35 TLU/km<sup>2</sup>.

**Table 1.** Farm size, and livestock distribution according to the livestock status of farms in agro-ecological zones CL3/4 in Kaloleni Division.

Livestock status of farms	Proportion of households	Farm size (ha)	Proportion of agricultural land <sup>1</sup>
None	0.35	5.80	0.29
SR only <sup>2</sup>	0.45	6.67	0.43
Cattle	0.20	9.82	0.28

1. Based on frequency and farm size.

2. SR = Small ruminants.

Source: Adapted from Thorpe et al (1993).

**Table 2.** Livestock distribution across farms in agro-ecological zones CL3/4 of Kaloleni Division.

Livestock status of farms	Number/household		Total TLU	
	Small ruminants	Cattle	Small ruminants	Cattle
SR only	8.3	–	1918	–
Cattle	9.2	18.5	941	17 916

Source: Adapted from Thorpe et al (1993).

1. These numbers are much lower than the 30 804 rural households estimated for Kaloleni as a whole, including CL5/6, in the 1989 census (Central Bureau of Statistics, unpublished data), which would indicate a mean farm area of less than 3 ha per household. Farm size increases as rainfall decreases, and therefore including the drier zones should raise the mean farm size. The overall result suggests a large number of effectively landless households. However, these figures should be interpreted with caution because the definitions of farm household may have differed across surveys.

### Total livestock requirements in CL3/4

Cattle-owning farms account for 20% of all farms in Kaloleni (Table 1), keeping 6.9 adult zebu cows, of which 25% (1.7 cows) will be in milk. Based on the studies of Maloo et al (1988) at the coast, the estimated lactation length is 177 days, milk extraction is 158 kg and the calf takes another 270 litres, and there is a calving interval of 708 days (Table 3). With a mean live weight of 190 kg, animal requirements for dry matter and protein for a complete reproductive cycle will be 3.6 t DM and 314 kg CP, respectively, equivalent to 1.86 t DM and 162 kg CP/year. Over a complete reproductive cycle, 6.9 adult cows will require 25.1 t DM and 2.17 t dietary CP, equivalent to 13 t DM/year and 1131 kg dietary CP/year.

**Table 3.** Dry-matter (DM) and crude-protein (CP) requirements over a complete reproductive cycle for grazing zebu cows in Kaloleni Division, producing 408 kg milk/lactation.

	Dry	Lactation	Pregnancy	Total for reproductive cycle
Cycle length (days)	531	177	270	708
DMI (t/animal)	2.30	1.34	a	3.64
Dietary protein (kg/animal)	172.1	118.8	22.9	313.8

a. DM requirements for pregnancy already covered during dry and lactation periods.

The total feed requirements for all adult cows in CL3/4 are estimated at 19 715 t DM and 1712 t CP per year. Adult cows represent 52% of the total ruminant TLUs in Kaloleni. The requirement for other cattle is 12 193 t DM and 1050 t dietary CP/year, and for small ruminants is 5792 t DM and 496 t of CP/year. Hence, total annual feed requirements for ruminant livestock in the CL3/4 zones of Kaloleni are 37 700 t DM and 3258 t dietary CP/year.

### Forage availability in CL3/4 in Kaloleni

Forage will be available from natural pasture, fallow land, herbage underneath permanent tree crops, cultivated forages and from crop residues. In 1977, 27% of the land was under natural pasture, 5% under fallow, 32% under tree crops and 34% under annual crops (Jaetzold and Schmidt, 1983). By 1985–87, Leegwater et al (1991) found that 43% of all farmland was under food crops. Thus over time, as human population density increases, an increasing portion of the land is being used for annual crops.

The actual areas under different land-use categories are summarised in Table 4. An assumption is made that natural herbage biomass production is the same under permanent tree crops, as from natural pasture, fallows and roadsides. Forty per cent of the cropped land is occupied by maize, cowpeas cover 10%, and cassava 20% (Jaetzold and Schmidt, 1983). Residues, including 2.5 t of maize stover (1.65 t edible) and 0.5 t of maize bran/ha plus 0.9 t/ha of cowpea haulms will be available for animal feed. Losses in the field from termites, weathering and trampling, account for 50% of the residue yield. This produces annually 8484 tonnes of edible maize stover, 4558 t of maize bran and 1139 tonnes of edible cowpea haulms (Table 5).

**Table 4.** Land allocation in agro-ecological zones CL3/4 in Kaloleni Division, according to livestock status of farms.<sup>1</sup>

Livestock status of farms	Area (ha)					
	Roadsides	Tree crops, pasture and fallows	Annual crops			
			Total <sup>2</sup>	Maize	Cowpeas	Cassava
None	435	9736	7345	2938	734	1469
SR only	645	14436	10 891	4356	1089	2178
Cattle	420	9400	7192	2837	709	1419

1. Based on proportion of agricultural land shown in Table 1.

2. Including all crops.

**Table 5.** Ruminant feed production in agro-ecological zones CL3/4 in Kaloleni Division, according to the livestock status of the farm.

Livestock status of farms	Edible material (t/year)					Total (%)
	Grass	Browse	Maize		Cowpea haulms	
			Stover	Bran		
None	6 103	1272	2460	1322	330	11 486(29)
SR only	9 049	1885	3648	1960	490	17 032(43)
Cattle	5 892	1227	2376	1277	319	11 092(28)
Total DM	21 043	4384	8485	4559	1139	39 610
CP	1 683	658	679	638	205	3 863

Cassava is harvested 10–11 months after planting, and the land is unavailable to grazing livestock because of the probability of crop damage. Livestock owners are assumed to feed crop residues from their farm to their own animals, but any surplus will be available to animals from other owners who face feed deficits. Standing herbage biomass on natural pasture varied over a period of two years from 0.7 t DM/ha at the end of the dry season to 2.4 t/ha at the end of the rainy season (P. Bullerdiek, unpublished data). Mean levels were 1.6, 1.2, 1.5 and 1.2 t/ha for April–June, July–September, October–December and January–March, respectively. Assuming that only 50% of the grass biomass can be harvested by grazing animals, 21 000 t of natural forage will be available annually (Table 5).

Browse is assumed to produce 0.5 t DM/ha at 15% CP, of which 50% can be harvested by grazing animals. Half of all the non-cropped land is assumed to produce browse. In Kaloleni for grazing cattle and goats, grass accounts for 79% and 42% of bites, respectively (Ramadhan et al, 1992). Total browse, that can be harvested by grazing animals is 4384 t DM and 658 t CP/year.

Based on 1989 figures, animal DM requirements are met by available feed with a surplus equivalent to 5% of annual DM requirements, and a 16% excess of dietary CP. On the basis of these estimates, Kaloleni Division is slightly understocked (Table 5).

### Faecal and urinary output

For zones CL3/4, ruminant livestock produce a total intake of 515 t N/year, from which 268 t N is deposited in faeces, 216 t N in urine, 9 t N in dermal losses and 22 t N is retained for production. Gains and losses of deposited N differ between the three groups of farmers and depend on livestock ownership. Livestock from other farmers remove 105 t N from those without livestock and return 35 t of N in excreta giving this group a negative balance of 70 t/year (Table 6). Similarly, small-stock farms lose 111 t of N per year, the main beneficiaries being the cattle owners who gain 150 t or 89 kg N/farm per year. These cattle-owning farmers occupy 28% of the land, but produce 93% of all excreta. These N-returns, if distributed evenly on the 43% of their land allocated to annual crops, are equivalent to 9 kg N/ha per year. If, instead of manuring all 4.2 ha of their cropped land, cattle owners deposit all excreta on their 1.7 ha of maize, the net benefit would amount to 22 kg N/ha per year.

**Table 6.** The effect of livestock status on nitrogen (N) intake, excretion and balance (t/year) in agro-ecological zones CL3/CL4 in Kaloleni Division.

Livestock status of farms	N excretion					
	N intake		Farmers' stock			N balance
	Farmers' stock	Others' stock	Kraal	Grazing	Others' stock	
None	0	105	0	0	35	-70
SR only	56	163	35	17	56	-111
Cattle	191	0	288	53	0	+150

Boxem et al (1987) predicted that 50 kg of N/ha is required to maintain a maize yield of 1.8 t of grain on the sandy soils in Kilifi District, of which 25 kg can be obtained from the soil, and the remainder must be provided from other sources. If animal numbers were at a level to fully utilise feed supplies, the area could carry 41 TLU/km<sup>2</sup> and support a population density of 164 persons/km<sup>2</sup>. At this density, the net contribution of livestock on cattle farms would be equivalent to 27 kg N/ha of maize, close to the level needed to maintain a grain yield of 1.8 t/ha. For food security it can be argued that sustainable maize production has the highest priority for all classes of farmers. Land allocation to maize (1.0 ha for no livestock, 1.2 ha for small ruminant only and 1.7 ha for cattle-owning farms) and an average yield of 1.8 t maize grain/ha would provide an annual provision of 200 kg/person. Assuming storage losses are 30%, 140 kg of edible grain would be available per person.

## Predictions for the future

The human population in the Coast Province may be increasing at a rate of 3.5% per annum. In 12 years the population will be 1.5 times as high as in 1989 and in 20 years it will have doubled. As population and the number of households increase, farm size will decrease. The proportion of total feed required by ruminants in Kaloleni that can be met from natural pasture (herbage and browse) and crop residues, will decrease if numbers of livestock/household remain at 1989 levels.

There are many scenarios that could ensue as populations increase. More land could be allocated towards annual crops and within the annual crop portion to maize and cassava in an attempt to ensure subsistence food production. Numbers of animals/household could decrease following existing trends of fewer animals as total farm land declines. Increasing annual crops slightly improves the output of both feed DM and CP, because crop residues produce more livestock feed than natural grass and browse. Irrespective of allocation of land to annual crops, as human population increases and farm size drops, the proportion of required feed that can be obtained by cattle on-farm will decline, although farms with only small ruminants will continue to meet feed requirements from their own resources. Hence, cattle must spend an increasing proportion of their grazing time on non-cropped land and on land of "other" farmers (Table 6). As a result, across the population pressure gradient, total net N transfers to cattle owners will rise from 150 to 195 t of N. However, with a nearly constant livestock population, the stocking density per area of maize will drop from 7.1 to 4.2 TLU/ha thereby lowering the N-deposits per ha and potentially leading to declining grain yields (Table 7).

**Table 7.** *The predicted effect of increasing human population on feed availability and contribution of livestock to the N balance on cattle-owning farms, with changing land allocation and numbers of animals/household in agro-ecological zones CL3/CLA of Kaloleni Division.*

Population density, people/km <sup>2</sup>	164 <sup>1</sup>	246	410	492		
All households (HH),						
Average farm size, ha <sup>2</sup>	7.0	4.7	2.8	2.3		
		-----		-----		
Maize cropping:						
Fraction of land	0.17	0.17	0.27	0.27	0.33	0.33
ha	1.2	0.8	1.3	0.8	0.9	0.8
Total feed, t DM/HH	4.71	3.14	3.38	2.03	2.13	1.77
TLU/HH, no.	2.6	1.7	1.9	1.1	1.2	1.0
Households with cattle						
Maize cropping, ha	1.7	1.1	1.8	1.1	1.3	1.1
TLU/HH, no.	11.9	8.0	8.6	5.1	5.4	4.5
Kg N/ha of maize <sup>3</sup>	53	53	36	35	29	30

1. Population density in 1989 based on 11.5 person/HH.

2. Farm size is based on the assumption that all agricultural land is adjudicated to farmers (see Tables 1, 4 and 5).

3. Net N before losses due to volatilisation.

Zebu animals are not sufficiently productive for purchased feeds to be an economic proposition, but with crossbred dairy cows the use of purchased concentrate can be financially profitable. As has been shown by Snijders (1992) for zero-grazing dairy farms with crossbred cows in the highlands of Kenya, the import of N in purchased concentrate allows zero-grazed dairy farms to remain in positive N balance despite annual sales of 2500 litres milk/cow. This scenario will be increasingly important for the small number of farms producing milk from crossbred cattle in Kaloleni as human populations increase and farm size decreases. However, it is less likely to be relevant to the zebu cattle owners who are currently in the majority.

## Conclusion

Grazing livestock collect nutrients from a wide area and deposit a large proportion in excreta in very small areas. High losses of nitrogen from volatilisation occur in urine together with smaller losses from faeces. Volatilisation losses of N from excreta are higher than the losses that would occur if the N remained as a constituent of uneaten plant material. Any sales of livestock or their products will remove N from the farm. The net effect of livestock on the N balance of a farm will only be positive where feed N imported in concentrate or harvested off-farm by grazing animals outweighs the N exported in livestock sales. In Kaloleni Division, farms with grazing cattle show a net positive N balance at the expense of non-cattle owning farms in the area, provided there is unrestricted access to all on- and off-farm feed resources.

## References

- ARC (Agricultural Research Council). 1980. *The nutrient requirement of ruminant livestock*. CAB (Commonwealth Agricultural Bureaux), Farnham Royal, UK. 351 pp.
- ARC (Agricultural Research Council). 1992. Nutritive requirements of ruminant animals: Protein. AFRC Technical Committee on responses to nutrients. Report 9. *Nutrition Abstracts and Reviews (Series B)* 62(12):787-835.
- Boxem H W, de Meester T and Smaling E M A. 1987. *Soils of the Kilifi area*. Reconnaissance Soil Survey Report R11. Kenya Soil Survey, Ministry of Agriculture, Nairobi, Kenya. 249 pp.
- Holmes W. 1980. *Grass, its production and utilisation*. Blackwell Scientific Publications, Oxford, UK. 295 pp.
- Iowa State University. 1975. *Livestock waste facilities handbook*. Midwest Plan Service 18. Iowa State University, Iowa, USA. 94 pp.
- Jaetzold R and Schmidt H. 1983. *Farm management handbook of Kenya. Vol II. Natural conditions and farm management information. Part C: East Kenya*. Ministry of Agriculture, Nairobi, Kenya. 411 pp.
- Leegwater P, Ngolo J and Hoorweg J. 1991. *Nutrition and dairy development in Kilifi District*. Report 35. Food and Nutrition Planning Unit, Ministry of Planning and National Development, Nairobi and African Studies Centre, Leiden, The Netherlands. 104 pp.
- Maloo S H, Chema S, Connor R, Durkin J, Kimotho P, Maehl J H H, Mukendi F, Murray M, Rarieya J M and Trail J C M. 1988. The use of chemoprophylaxis in East African Zebu village cattle exposed to trypanosomiasis in Muhaka, Kenya. In: *Livestock production in tsetse affected areas of Africa*. Proceedings of a meeting, Nairobi, Kenya, 23-27 November 1987. The African Trypanotolerant Livestock Network. ILCA (International Livestock Centre for Africa)/ILRAD (International Laboratory for Research on Animal Diseases), Nairobi, Kenya. pp. 283-288.
- Powell J M. 1986. Manure for cropping: A case study from central Nigeria. *Experimental Agriculture* 22:111-117.
- Ramadhan A, Rowlands G D and Reynolds L. 1992. Feeding behaviour of goats and cattle under extensive management on smallholder farms in the coastal sub-humid zone of Kenya. Paper presented at the 10th SR-CRSP Scientific Workshop, Nairobi, Kenya, February 1992.
- SCA (Standing Committee for Agriculture). 1990. *Feeding standards for Australian livestock: Ruminants*. CSIRO (Commonwealth Scientific and Industrial Research Organisation), Melbourne, Australia. 266 pp.



- Snijders P M J. 1992. *Standards for the supply and utilisation of fodders on zero-grazing farms in the highlands of Kenya*. NDDP (National Dairy Development Project)/KARI (Kenya Agricultural Research Institute), Naivasha, Kenya. 47 pp.
- Thorpe W, Chabari F, Muinga R, Mullins G, Mureithi J, Nyambaka R and Otieno L. 1993. *Smallholder agriculture in coastal lowland Kenya: A farming systems survey in Kaloleni division*. Draft Working Document 3. KARI (Kenya Agricultural Research Institute)/ILCA (International Livestock Centre for Africa), Mtwapa, Kenya.
- Vertregt N and Rutgers B. 1988. *Ammonia volatilisation from grazed pastures*. Centre for Agrobiological Research Report 84. Centre for Agrobiological Research, Wageningen, The Netherlands. 37 pp.
- Webster A F J, Simmons I P and Kitcherside M A. 1982. Forage protein in ruminant animal production. In: Thompson D J, Beever, D E and Gunn R G (eds), *Forage protein in ruminant animal production*. BSAP Occasional Publication 6. BSAP (British Society of Animal Production), UK. pp. 89–95.

# **A static model of nutrient flow on mixed farms in the highlands of western Kenya to explore the possible impact of improved management**

*K.D. Shepherd<sup>1</sup>, E. Ohlsson<sup>1</sup>, J.R. Okalebo<sup>2</sup>, J.K. Ndufa<sup>3</sup> and S. David<sup>1</sup>*

1. International Centre for Research in Agroforestry (ICRAF), P O Box 30677, Nairobi, Kenya
2. Soil Chemistry Section, Kenya Agricultural Research Institute (KARI)  
P O Box 30148, Nairobi, Kenya
3. Kenya Forestry Research Institute (KFRI), P O Box 25188, Otonglo, Kisumu, Kenya.

## **Abstract**

Currently there is much interest in the potential role of agroforestry in the mitigation of nutrient depletion in sub-Saharan Africa. Using data from farm surveys and trials static models of nutrient flow for existing farm systems and improved agroforestry systems were constructed. These included boundary plantings of trees, hedgerow intercropping for green manure or fodder, and a well-managed zero-grazing system with moderate fertiliser inputs. The objective was to explore the possible impact on nutrient budgets of improved management options. Major nitrogen (N) losses (70% of total farm loss) occurred in the field and hedgerow compartments, principally through leaching and denitrification, which exceeded 60 kg N/ha per annum in all systems. However, there was uncertainty in predicted net mineralisation and the potential amounts of soil-N losses, and the study indicated substantial potential for N mineralisation in deep subsoils. In contrast, phosphorus (P) was efficiently conserved in the farm system, and moderate additions of inorganic P fertilisers could maintain soil-P stocks. Net soil nutrient balances ranged from -39 to -118 kg N/ha per annum and from -7 to +31 kg P/ha per annum in the different simulated systems. N inputs through biological N fixation and deep N capture were significant in agroforestry systems (up to 122 kg N/ha per annum), but when trees were used for production purposes these additional inputs were offset by increases in consumable N harvested (grain, wood and milk) which ranged from 35 to 195 kg N/ha. Improved manure management reduced soil-N deficits by 70 kg N/ha per annum in a zero-grazing system with a high manure flux. Research priorities for the humid highland farming systems include the quantification and dynamic modelling of (1) N mineralisation and N dynamics throughout soil profiles, (2) spatial and temporal patterns of N uptake by trees in agroforestry systems, and (3) nutrient budgets in long-term systems trials.

## **Modèle statique du flux d'éléments nutritifs en vue de l'évaluation d'une méthode de gestion améliorée dans les exploitations mixtes des hauts plateaux de l'ouest du Kenya**

*K.D. Shepherd<sup>1</sup>, E. Ohlsson<sup>1</sup>, J.R. Okalebo<sup>2</sup>, J.K. Ndufa<sup>3</sup> et S. David<sup>1</sup>*

1. Centre international pour la recherche en agroforesterie (ICRAF), P.O. Box 30677, Nairobi (Kenya)
2. Soil Chemistry Section, Kenya Agricultural Research Institute (KARI)  
P.O. Box 30148, Nairobi (Kenya)
3. Kenya Forestry Research Institute (KFRI), P.O. Box 25188, Otonglo, Kisumu (Kenya)

## **Résumé**

*La possibilité de recourir à l'agroforesterie pour réduire les pertes d'éléments nutritifs dans les sols en Afrique subsaharienne suscite aujourd'hui beaucoup d'intérêt. A partir de données d'enquêtes*

*et d'essais en milieu paysan, des modèles statiques du flux d'éléments nutritifs ont été construits pour les systèmes agricoles existants et des systèmes agroforestiers améliorés, y compris la mise en place d'arbres en bordure des champs, le semis entre des haies en vue de la production d'engrais vert et de fourrage et un système approprié de zéro-pâturage avec apport de quantités moyennes d'engrais. L'objectif était d'évaluer l'impact possible des options de gestion améliorée sur les stocks d'éléments nutritifs. Des pertes importantes d'azote (70% des pertes totales) supérieures à 60 kg/ha/an — essentiellement par lessivage et par dénitrification — ont été enregistrées dans les champs et les haies dans tous les systèmes étudiés. Toutefois, les prévisions relatives à la minéralisation nette et aux pertes d'azote des sols laissaient à désirer, mais les résultats indiquaient une forte possibilité de minéralisation de l'azote dans les horizons profonds du sous-sol. En revanche, le phosphore (P) était bien conservé dans ces systèmes et l'addition de quantités moyennes d'engrais phosphorés inorganiques permettait d'en maintenir les stocks dans les sols. Le bilan d'éléments nutritifs des sols était de -39 à -118 kg/ha/an pour l'azote et de -7 à +31 kg/ha/an pour le phosphore dans les différents systèmes simulés. Les apports d'azote par fixation biologique et à partir des horizons profonds étaient significatifs dans les systèmes agroforestiers (jusqu'à 122 kg/ha/an), mais lorsque les arbres étaient utilisés pour la production (graines, bois et lait), ces apports étaient contrebalancés par l'azote contenu dans les produits récoltés, soit de 35 à 195 kg/ha. L'amélioration de la gestion du fumier se traduisait par une baisse de 70 kg/ha/an des carences en azote du sol dans un système de zéro-pâturage à flux élevé de fumier. Les priorités de recherche dans les systèmes agricoles des zones humides comprennent la quantification et la modélisation dynamique 1) de la minéralisation et de la dynamique de l'azote à travers les horizons; 2) des caractéristiques spatiales et temporelles de la fixation de l'azote dans les systèmes agroforestiers; et 3) des stocks d'éléments nutritifs dans des études de système de longue durée.*

## Introduction

The mitigation of land depletion and rural poverty is currently a major world concern. There is currently gross nutrient mining of agricultural soils resulting from crop production with low levels of nutrient inputs coupled with poor nutrient conservation practices. The situation is particularly severe in sub-Saharan Africa where soils are generally less fertile and fertiliser use is lower than in other continents. For example, the annual average nutrient loss per hectare of arable land for the sub-Saharan region has been estimated at 22 kg N, 2.5 kg P and 15 kg K (Stoorvogel et al, 1993). The most severe nutrient mining occurs in areas that have favourable climates for crop production and high population densities, notably in the East African highlands.

There are a number of hypotheses on how agroforestry systems and improved management of organic resources (e.g. animal manures and composts) may improve soil fertility (Young, 1989). However, much of the experimental work to test these hypotheses is done at the plot level without regard to the limits on the availability of nutrient resources at the farm or regional level. There is need for thorough *ex-ante* analysis of technologies at the farm level in order to direct long-term experiments on improved management systems. Examples of quantitative models of nutrient cycling and budgets at the regional scale are given by Smaling et al (1993) and Van der Pol (1992), and at the agro-ecosystem or farm scale by Frissel (1978), Powell and Mohamed-Saleem (1987) and Swift et al (1989). This paper models nutrient flows and balances on mixed farms in the humid highlands of western Kenya, including tree, crop and livestock components. The objectives are to explore the possible impact of improved management systems on soil nutrient balances and thereby identify priorities for research.

## The farming system

The study area was chosen to represent an area that has high agricultural potential but severe land depletion. It includes parts of Siaya, Kisumu and Vihiga districts in the highlands of western Kenya that have a humid climate and an altitude of about 1500 m (Ndufa et al, 1992). The area has an annual

rainfall of 1600–1800 mm with a mean annual temperature of 21°C. The landscape is gently undulating, dominated by Acrisols, Nitisols, and Ferralsols. The area has a subsistence-level mixed crop–livestock farming system. The major crops are maize (mostly unimproved varieties), beans, cassava, bananas, sweet potatoes and sorghum. There are two cropping seasons, the long rains from March to August, and the short rains from September to December. Cattle (mostly unimproved breeds of zebu) are kept mainly as a source of liquid capital, though there is increasing interest in small-scale dairying. Average farm size ranges from 0.5 to 2.0 ha and population exceeds 1000 persons/km<sup>2</sup> in some areas (KEFINCO, 1990). Land tenure is mostly secure as most land has been purchased. Out-migration of male labour has resulted in about 45% of female-headed households (Sands, 1983).

## Materials and methods

### Data sources

A survey of soil nutrient stocks for cropped fields of 32 farms was conducted to assess the main variation in soils in the area. The soil chemical methods used are given by Anderson and Ingram (1989). The nitrogen mineralisation index was determined using anaerobic incubation (Page et al, 1982: 717).

Data on farmers' soil fertility management practices were obtained from multi-visit ethnographic interviews with 11 farmers using a checklist of questions on five topics: soil erosion control, fallows and rotations, management of manure and organic residues, use of fertilisers, and knowledge of soils. A formal survey was administered to a random selection of 71 farmers to quantify the findings.

Data on crop, tree and hedgerow yields and nutrient contents are median values taken from farmer-managed agroforestry trials conducted in the area (Ndufa et al, 1992). The data on shrub dry matter and nutrient content is based on hedgerows of *Leucaena leucocephala* and *Calliandra calothyrsus* planted in farmers' cropland four metres apart and cut four times a year for green manure and fodder. *Sesbania sesban* dry matter and nutrient contents were taken from an improved fallow trial on one farm. Other data is taken from the literature as indicated in the text.

### Nutrient budget model

A static model was constructed of the annual inputs and outputs of nitrogen and phosphorus to/from the farm, and the annual flows of these nutrients between six compartments within the farm: field, hedgerow, livestock, *boma*, compost and homestead (Figure 1). Nutrient resources outside the farm's external fence, in the atmosphere above the farm, or in the soil below a depth of 0.5 m were considered external to the farm system. The field component was taken to include areas that are cropped or under temporary fallow, while the hedgerow compartment included all permanently fallow areas (mainly the perimeter, soil conservation bunds and areas around the homestead that have permanent grass cover). The livestock compartment was designed to simulate livestock grazing both on and off the farm. The homestead compartment was taken to accumulate nutrients consumed by the household, but recycle some components, such as ash from burning fuelwood. Storage (S) for each compartment was calculated from inputs (I), outputs (Q), and flows to/from each compartment (F), exemplified below for the field compartment (Figure 1). Steady state (no change in storage) was assumed for the livestock, *boma* and compost compartments.

$$S_f = I_f + F_f^* - Q_f - F_f$$

Individual inputs and outputs of nutrients for the soil were similar for both the field and hedgerow compartments (Table 2a). Inputs from the atmosphere as wet deposition were predicted from annual rainfall (1800 mm) using the transfer function of Stoorvogel and Smaling (1990), while dry deposition was assumed to be negligible in humid environments. Biological nitrogen fixation was estimated as 50% of total uptake in above-ground biomass of N-fixing plants, although maximum literature values may exceed 75% (Giller and Wilson, 1991). Asymbiotic nitrogen fixation was also estimated from annual rainfall using the transfer function of Stoorvogel and Smaling (1990). Input from weathering of minerals was taken as 0.1 kg P/ha per annum, as a typical rate for poor parent materials (Hingston,

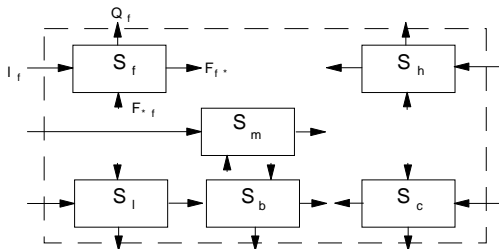
**Figure 1.** Static nutrient budget model of a mixed farm.

The storage compartments are:  $S_f$  = field soil,  $S_h$  = hedgerow soil,  $S_l$  = livestock,  $S_b$  = boma,  $S_c$  = compost,  $S_m$  = homestead.  $I_f$  = the sum of annual inputs and  $Q_f$  = the sum of annual outputs for the field compartment.  $F_{f*}$  = sum of annual flows from the field compartment to the other compartments and  $F_{*f}$  = sum of annual flows into the field compartment from the other compartments. The dotted box is the boundary of the farm system.

1977). Deep uptake of N from below 0.5 m was taken as zero for shallow-rooted plants (e.g. annual crops) and 50% of above-ground N uptake for deep-rooted plants (perennial grasses, shrubs and trees) up to a maximum value equal to the amount of leached N. Shrubs and trees in the hedgerow compartment were allowed to access leaching N from the field compartment. Simulations by Noordwijk (1989) indicate that deep root systems could capture much of the leached N in humid environments, but field measurements are lacking. For slowly mobile nutrients, Commerford et al (1984) suggested maximum values of up to 80% of plant uptake from layers below 0.15–0.30 m depth for deep rooted plants, but high values were mainly associated with prolonged dry spells. In the model, however, deep uptake of P was set to zero because of the low available P status of the subsoils. Fertiliser application rates were specified as part of the farm systems described later.

**Table 1.** Soil properties and nutrient stocks in 32 farm fields in western Kenya.

	Soil layer					
	0–0.15 m			0.15–0.50 m		
	Minimum	Median	Maximum	Minimum	Median	Maximum
Bulk density ( $t/m^3$ )	0.57	0.77	1.07	0.46	0.96	1.79
pH	4.0	4.7	5.8	4.3	5.0	5.6
Organic C (g/kg)	9.3	15.7	36.5	5.8	12.8	20.3
Total N (t/ha)	0.87	1.44	2.69	1.96	3.59	6.40
N avail. index <sup>1</sup> (mg/kg)	3	17	36	5	12	26
Total P (t/ha)	0.29	0.52	1.44	0.29	0.61	2.60
Olsen P (kg/ha)	0.7	4.2	81.1	1.2	5.3	56.5
Ex. bases ( $cmol_c/kg$ )	2.1	5.4	12.7	1.2	4.8	11.3
Ex. Al ( $cmol_c/kg$ )	0.1	1.5	20.4	0.5	2.2	11.2
Al saturation (%)	1	25	89	6	29	83

Note: Values are expressed on an air-dry soil basis for <2 mm soil fines. Exclusion of gravels gave low bulk density values for some samples.

1. Anaerobic incubation, Page et al (1982).

Losses of N by leaching and denitrification, expressed as percentage of total mineralisable soil-N plus fertiliser-N, were estimated from soil texture (35–55% clay) and annual rainfall using the transfer functions of Smaling et al (1993). The functions are based on a synthesis of experimental data from a range of environments. These gave values of 26% for leaching and 15% for denitrification. Mineralisable soil-N was calculated from measured total soil-N, assuming a fixed annual nitrogen mineralisation rate of 3.0% (Young, 1989). Total nitrogen contents in our soils for the 0–0.50 m layer ranged from 3.3 to 8.2 t N/ha (median 4.92 t N/ha) giving predicted leaching rates of 26 to 64 kg N/ha per annum (median 39 kg N/ha per annum) and denitrification rates of 15 to 37 kg N/ha per annum (median 22 kg N/ha per annum). Leaching of P and volatilisation of soil and fertiliser N were assumed to be negligible. Literature estimates of volatilisation from livestock droppings are in the range of 8–80% for faecal N and 12–90% for urinary-N (Woodmansee, 1979). Following Woodmansee (1979) default values for volatilisation as 80% of urinary-N and 20% of faecal-N deposited on the land were taken. Volatilisation from burning of crop or wood residues was assumed to be 100% of residue-N, but zero for residue-P.

**Table 2a.** Nutrient inputs, outputs and flows for each compartment.

Variable (kg nutrient/ha per annum)	Source of information
<b>Field/hedgerow compartments</b>	
<b>Inputs</b>	
Deposition	f (annual rainfall)
Biological fixation (N)	f (N uptake)
Asymbiotic fixation (N)	f (annual rainfall)
Weathering (P)	Literature estimate
Fertiliser	Specified
Deep uptake (N)	f (N uptake potential, plant type)
<b>Outputs</b>	
Leaching (N)	f (mineralisable N)
Denitrification (N)	f (mineralisable N, rainfall, texture)
Volatilisation (N)	f (faeces/urine deposited + residues burned)
Erosion (hedgerow only)	f (field erosion flow, fraction captured in hedgerow)
<b>Flows</b>	
Herb harvest yield → field (green manure)	Yield and fractions apportioned to other compartments are specified
livestock (grazing, fodder), compost, homestead (grain)	
Herb residue yield (field only) → field (returned), livestock, <i>boma</i> (bedding), compost, homestead (fuel), off-farm (burned)	Yield and fractions are specified
Shrub/tree leaf yield field, livestock, compost	Yield and fractions are specified
Shrub/tree branch yield → homestead (fuelwood)	Yield specified
Tree trunk yield → homestead (polewood)	Yield specified
Erosion from field → hedgerow	Predicted using USLE

→ indicates destination compartments for products. Off-farm is an output.

Soil erosion was estimated using the Universal Soil Loss Equation (Wischmeier and Smith, 1978). Using the original units, rainfall erosivity (R) factor has been estimated as 500 for the western Kenya highlands around Lake Victoria (Wenner, 1981), and the soil erodibility factor (K) from 0.04 on stable soils, such as kaolinitic Ferralsols and Nitisols, to 0.2 on less stable soils, such as Acrisols (Barber et al, 1979). Slope gradients in the Project area are generally between 0 and 10%, and a median value of 6% from the farm survey (71 farms) was used as a default value, giving a slope gradient factor of 0.45 (Wenner, 1981). The slope length factor was derived from the slope length measured in the farm survey (average distance between soil conservation structures), which had a median value of 35 m (range 5–154 m) giving a median slope length factor of 1.26. A cover factor of 0.3 was used to represent maize/beans intercropping (Smaling et al, 1993). The land management factor was set at 0.31 to represent slopes of 6%, with contour farming plus strip cropping (Wenner, 1981). Nutrient loss in eroded soil was calculated using the total N and P contents of the topsoil from the farm survey, times an enrichment factor of 1.5 (Gachene, 1989). Using the median values above gave erosion losses for the field compartment of 11 kg N/ha per annum and 3.7 kg P/ha per annum. It was assumed that there is no erosion from hedgerow areas as they are usually under permanent grass, however, erosion from the field compartment was taken to flow into the hedge compartment where a fraction of the nutrient flow was deposited (default value = 80% deposited).

Nutrient flows to other compartments or out of the farm were calculated from nutrient yields of harvested biomass together with the fraction of the biomass apportioned to the various destinations (Table 2a). The biomass included three components: herb (e.g. food crop, fodder crop, grass and weeds), shrub, and upper-storey tree. The herb component was divided into harvested parts and residues, whereas shrubs and trees were divided into leaf (green matter), branch and trunk (trees only). Nutrient concentrations for each plant part are given in the farm system descriptions below.

The livestock component was specified as the number of lactating zebu, crossbred, or purebred cows on the farm, which determined the potential nutrient intake (Table 2b). Maximum potential values for nitrogen intake for maintenance requirements and annual milk yields were estimated based on standard equations (ARC, 1980; CSIRO, 1990) assuming zero growth and standard live weights for each breed (Table 3). Actual intake was calculated according to the feed materials available to the livestock up to the potential intake value. If excess feed was available, preference was given to the highest quality feed materials. The ingested nutrient was partitioned between milk, faeces and urine (Table 3) assuming milk nutrient contents of 5.5 g N/kg and 1 g P/kg. Nutrient excretion in faeces and urine was partitioned between the field, hedgerow, *boma* and off-farm according to the time the livestock would spend in each compartment (Table 2b). Nutrient export from sale of livestock was not considered in the model but based on equations given by the ARC (1980) a purebred cow (which may be retained on a farm for several years) is expected to contain 11 kg N and 4 kg P.

Nitrogen losses from a *boma* may occur through volatilisation, leaching and denitrification. The potential for high losses by volatilisation, particularly from urinary-N, has already been noted. However, there are fewer opportunities for loss of P, although leaching of organic P is possible. Probert et al (1992) provide evidence for accumulation of substantial quantities of nutrients beneath *bomas* with earth floors, but the use of concrete floors, roofing, bedding materials, and frequent emptying would tend to reduce losses. In zero-grazing units, use of concrete-lined urine pits, frequent washing out of the unit floor, covering of the pits, and frequent emptying of pits would also help to reduce N losses from urine. In the model a nutrient retention fraction equal to the amount of nutrient recovered from the *boma* as a proportion of the nutrient excreted there is specified. Response to management was simulated by varying the nutrient retention fraction within the ranges of 0.4–0.9 for faecal N, 0.0–0.8 for urinary N, and 0.8–1.0 for faecal P. Nutrient recovered from the *boma* (in faeces and urine separately, or faeces plus urine soaked up in bedding material) was apportioned between several destinations (Table 2b).

Nutrient losses from the compost compartment were handled in a similar way to the *boma* (Table 2b). Improved management, such as covering to reduce leaching and high temperatures, was simulated by increasing the nutrient recovery fraction within the range 0.41–0.85 for N and 0.72–0.88 for P (Kwakye, 1980; Guar et al, 1984).

Nutrients harvested in food crops, fuelwood and poles were allocated to the homestead compartment, but off-farm exports of consumable products from the homestead and utilisation of human excrement were not modelled. Organic wastes derived from food brought into the farm were estimated assuming that a maximum of half of the household food requirement (equivalent to 50% of 950 kg maize grain for a household of five) is purchased (Sands, 1983) and that 10% of the food is residue. This gave imports in food wastes of 0.7 kg N per annum and 0.1 kg P per annum. Organic residues obtained from sweeping around the homestead were estimated at 1 kg N per annum and 0.1 kg P per annum. Average household fuelwood needs are in the range 6–10 kg dry matter per day which is equivalent to maximum imports of 11 kg N per annum and 1.1 kg P per annum, although most households meet two-thirds of this need from within the farm (Muturi and Franzel, 1992).

**Table 2b.** Nutrient inputs, outputs and flows for each compartment.

Variable (kg/nutrient per annum)	Source of information
<b>Livestock compartment</b>	
Inputs	
Grazing off-farm	Specified
Fodder import	Specified
Concentrates	Specified
Mineral supplements	Specified
Flows	
Milk → homestead	f (fodder intake, breed)
Faeces/urine excretion →field, hedgerow, <i>boma</i> , off-farm	f (fodder intake, breed), Fractions apportioned to other compartments are specified
<b>Boma compartment</b>	
Outputs	
Losses from faeces/urine	f (amount excreted in boma, recovery fraction)
Flows	
Faeces/urine removal →field, hedgerow, compost off-farm	= (amount excreted in boma minus losses) fractions are specified
<b>Compost compartment</b>	
Inputs	
Residue import	Specified
Outputs	
Losses during composting	f (amount composted)
Flows	
Compost removal →field, hedgerow, off-farm	= (amount composted minus losses) fractions are specified
<b>Homestead compartment</b>	
Inputs	
Fuelwood import	Specified
Food waste import	Specified
Outputs	
Losses on burning fuelwood	f (amount fuelwood, recovery fraction)
Flows	
Sweepings → compost	Specified
Wood ash removal →field, hedgerow, compost	= (amount of woodfuel minus losses), fractions are specified

→ indicates destination compartments for products. Off-farm is an output.



**Table 3.** Partitioning of nutrients in the livestock sub-model.

	Zebu	Crossbred	Purebred
Animal weight (kg)	300	400	500
Potential DM intake (t/annum)	1.95	3.00	4.19
Potential N intake (kg/annum)	34	51	72
Potential milk yield (t/annum)	1.22	5.52	5.12
Milk-N:intake-N fraction	0.20	0.38	0.39
Faeces-N:intake-N fraction	0.50	0.50	0.50
Urine-N:intake-N fraction	0.30	0.12	0.11
Milk-P:intake-P fraction	0.31	0.40	0.45
Faeces-P:intake-P fraction	0.69	0.60	0.55

### Model of existing system

An existing farm system was defined to represent the situation for farms with median farm size and resources and was used as a baseline with which to compare improved management options. Median survey values were 0.8 ha for the field area and 0.2 ha for the hedgerow area. Median crop dry-matter production from the field was 1 t/ha maize grain (1.5% N, 0.20% P) plus 0.3 Mg/ha of field beans (3.5% N, 0.50% P). A harvest index of 0.5 was taken for both crops, with 0.6% N and 0.06% P in maize stover and 0.8% N and 0.08% P in bean stover. The survey showed that only 41% of farmers regularly use fertiliser on maize, and most apply diammonium phosphate alone, and only during the long rains. The farmers who used fertiliser (75%) estimated average application rates of less than 5 kg N/ha per annum and 6 kg P/ha per annum, thus in the simulation no fertiliser use was assumed. The survey showed that over half the farmers use some maize stover for fodder and fuel but leave the remainder in the field. About 20% of the farmers graze cattle on the stover in the field, 18% sell some, and 13% burn the residues in the field. In the simulation crop residues were partitioned between fodder (0.5 of total), and fuel (0.2), with the remainder returned to the field.

For the hedgerow compartment, above-ground herb production was taken as 5 t/ha per annum of natural grass at 3.0% N and 0.33% P (Sands, 1983), and shrub production as 3.2 t/ha per annum, partitioned into leaf plus twig biomass (0.84 of total biomass, 1.8% N, 0.09% P) and branch biomass (0.16 of total biomass, 0.73% N, 0.06% P). Shrubs were assumed to be unimproved species that do not fix N. Upper storey tree production was calculated assuming five seven-year-old *Grevillea robusta* trees (10 cm mean diameter) were harvested each year (Muturi and Franzel, 1992). Total dry matter per tree was 142 kg (partitioned into 0.12 leaf + twig, 0.17 branch, and 0.71 trunk) with nutrient concentrations of 1.5% N and 0.16% P in leaf/twig; 0.3% N and 0.04% P in branch; and 0.31% N and 0.06% P in the trunk (Visser, 1960). The survey showed that the main product of the hedgerows was fuelwood, with lower levels of utilisation for poles, fodder, grazing, and composting. In the simulation, it was assumed that natural grass was grazed, the tree trunk component was used for poles, the hedge and tree wood components were used for fuelwood, and the leaf material was divided equally between fodder, grazing and compost.

Most households own cattle (74%) with a median of four zebu per household, but only one-third own shoats. Only 9% of households own crossbreeds and 6% own purebreds. While more than three-quarters of the cattle owners use both grazing and cut-and-carry feeding, 68% rely mainly or solely on their own farm for grazing land. Off-farm grazing is usually restricted to the roadside grass around the border of the farm, commonly for about six hours per day. Farmers estimated that about 80% of the cut-and-carry fodder that is used comes from within the farm (e.g. maize thinnings and stover). In the simulation it was assumed that four zebu cows, with off-farm grazing restricted to 0.10

ha of roadside grass yielding 5 t/ha with 1.5% N and 0.15% P (Sands, 1983), giving an off-farm intake of 15 kg N and 1.5 kg P per annum. Deposition of faeces/urine was apportioned to the *boma* (0.5), off-farm (0.2), hedgerow (0.2) and field (0.1).

The survey showed that on the majority of farms cattle are kept at night in a roofed building, or enclosure, with an earth floor without bedding. Emptying of the faeces is usually done daily. To reflect this situation, the nutrient retention fractions for the *boma* were estimated at 0.8 of faecal N, 0.95 of faecal P, and zero for urinary N.

The majority of cattle owners (85%) compost the manure from the *boma* in a pit or heap. Crop residues, household scraps and sweepings are usually added to the compost, but no materials are collected from outside the farm. The compost is usually not protected from rain or sun but is commonly mixed once or twice during a storage period of about six months. The median amount of compost produced (farmers' estimates) was 20 wheel-barrows, equivalent to about 360 kg of dry matter. Median concentrations of nutrients in manure measured from seven farms were low at 0.6% N and 0.22% P, giving 3 kg N/ha and 1.0 kg P/ha applied to cropland. The most common practice is to apply a handful of composted manure into each maize planting hole, and broadcast any remaining. It is also a common practice to apply some manure direct to the fields from the *boma*, especially during the growing season. Thus in the simulation, 20% of the manure from the *boma* was apportioned to the field and 80% was composted, with all the compost being apportioned to the field. Nutrient retention fractions were set in the low range, at 0.4 for N and 0.7 for P, to reflect the poor standard of compost management. The homestead was assumed to import 20% of the maximum fuelwood requirements and the ash from burning fuelwood was allocated to the compost compartment.

### Improved manure management

The potential impact of improved manure management was simulated, assuming that 30% of crop residues are used as bedding in the *boma*, resulting in an increase in the recovery fraction for urinary N from zero to 0.8. Improved compost management (covering) was assumed to increase the recovery fraction from 0.4 to 0.8 for N, and from 0.7 to 0.9 for P.

### Improved boundary planting

Improved boundary planting was simulated with *Grevillea robusta* trees planted every 2.5 m along the external farm boundaries and along contour bunds at 35 m apart, giving 400 trees in the 0.2 ha hedgerow compartment. Assuming a seven-year rotation, 57 trees would be harvested each year. It was assumed that poles were harvested for construction or sale, branches were utilised for fuelwood, and the leaf fraction was composted using the improved compost management regime. It was also assumed that the additional tree growth did not suppress the growth of other field or hedgerow vegetation, and that no fuelwood was imported.

### Traditional and improved fallows

The survey revealed that over half the farmers leave some of their land fallow, more usually to restore soil fertility, but also because of labour shortages. The most common length of fallow is one year (36% of fallowers), with periods of one season or for longer than one year being slightly less common. Here, a traditional weedy fallow compared with an improved fallow was simulated. The field area was allocated to maize-beans during the long rains and natural fallow (weeds) or improved fallow (plus *Sesbania sesban*) during the short rains. It was assumed that the sesbania was inter-sown with the previous maize-beans crop. Deep nutrient capture was allowed to occur in the improved fallow but not in the natural fallow. Crop yields during the long rainy season were taken as 0.6 of the default annual crop yield, and crop production was increased by a factor of two in the natural fallow system, and by a factor of three in the improved fallow system. We assumed the natural fallow vegetation (2.5 t/ha, 1.5% N, 0.15% P) was burned before subsequent cropping, whereas the sesbania fallow (3 t/ha)

had a leaf/twig fraction (0.36 of total dry matter, 1.8% N, 0.09% P) which is returned to the soil as green manure, and a branch fraction (0.64 of dry matter, 0.73% N, 0.06% P) which is utilised for fuelwood.

### **Hedgerow intercropping**

Hedges of calliandra or leucaena planted 4 m apart on the field area, yielding 5 t/ha of above-ground biomass in prunings was modelled. The leaf/twig fraction was apportioned to the soil as green manure, while the branch fraction was allocated for fuelwood. Shrub biomass partitioning into leaf/twig and stem, and their nutrient contents were the same as given for the hedgerow compartment but the shrubs were assumed to fix N. Field erosion was set to zero.

### **High fertiliser inputs**

Based on the results of fertiliser trials in the region (Jaetzold and Schmidt, 1982) fertiliser inputs of 130 kg N and 50 kg P were assumed to produce 4 t/ha of maize grain plus 400 kg/ha of bean seed from the field. Otherwise the specifications were the same as the existing system.

### **Improved agroforestry system**

Our survey showed that only 4% of all farmers have purebred cows in zero-grazing units. However, there is strong interest in the enterprise and in some other parts of the Kenya highlands (e.g. Embu District) over 90% of farmers are engaged in dairying, although management practices are often poor. Average Napier dry-matter yields in the study area are 12–22 t/ha per annum and milk yields for lactating cows are 6–9 kg per day (van der Valk, 1990). Farmers apply only about one-fifth of the recommended rate of fertiliser to their Napier plots (the recommendation is 100 kg N plus 20 kg P/ha, with all the manure and urine returned to the Napier plot). However, up to half of the farmers return no manure to the Napier plots, and less than half of the farmers use urine pits, which are mostly uncovered and emptied at intervals of more than one week.

The simulation combined boundary planting, hedgerow intercropping, moderate fertiliser inputs, and a well-managed zero-grazing dairy unit. The field area was modelled as 50% under Napier grass and 50% under a high input maize/beans intercrop. We assumed that the Napier received recommended fertiliser rates of 100 kg N plus 20 kg P/ha and yielded 30 t dry matter/ha of 1.5% N and 0.30% P (Bayer, 1990). The whole field area was specified under hedgerow intercropping with the leaf/twig fraction allocated for fodder. The hedgerow areas included Napier grass and hedges of N-fixing shrubs harvested for fodder, and improved boundary planting. A zero-grazing unit with four pure-bred cows utilising all the crop stover as fodder was simulated. Minerals were supplied at 20 kg per day per cow containing 11.8% P, but the legume fodder was used as a substitute for concentrates. It was assumed that faeces were emptied daily from the concrete floor of the grazing unit and composted, while urine was collected in a pit and emptied daily on to the field. These practices were assumed to give high N retention fractions in the *boma* (0.9 for faecal N and P, and 0.8 for urinary N). A high level of compost management was also assumed.

## **Results and discussion**

In terms of validation, the model gave realistic values for milk and compost production. The predicted milk yield in the existing farm system was equivalent to 1.2 kg per day for each animal, which is close to estimates of 1.1 kg per day for zebu in Kakamega District (Sands, 1983). The predicted milk yield for the improved agroforestry system was equivalent to 13.6 kg per day per cow which is, as expected, slightly higher than the yields of 6–9 kg per day usually obtained by zero-grazing farmers in the area (van der Valk, 1990). The predicted amount of composted manure applied to the field in the existing farm system was 6 kg N/ha, compared with 3 kg N/ha in the farm survey.

However, the modelling approach used had several limitations. First, the model could not be used to simulate long-term effects on nutrient budgets because biomass production was not modelled as a function of nutrient availability. Second, there were major uncertainties in the estimates of soil-N losses and yet these constituted the main source of N loss from the farm system (apart from harvested N). Third, nutrient inputs entering the system in below-ground biomass production were not considered. Fourth, several other feedback mechanisms were not accounted for, like reductions in N leaching through increased N uptake, and the possible effects of quality of organic inputs on microbial activity. Despite these limitations, the results illustrate a number of important points.

### Sources of nutrient loss

The major N losses came from the field and hedgerow compartments (Figure 2), principally from leaching and denitrification from the field compartment which totalled 61 kg N/ha in the existing farm system and 108 kg N/ha in the improved agroforestry system (Table 4). The losses could potentially range from half to twice this value on different farms on the basis of their range in soil-N content (Table 1). Also, if total-N in the 0–0.15 m layer, rather than in the 0–0.5 m layer, is taken as the basis for predicting mineral-N, then the losses would also be approximately halved. In addition, net mineralisation rates are likely to vary between soils. Hence there is uncertainty in the predicted net mineralisation and the potential amounts of soil-N losses. However, in the soils studied there appeared to be substantial potential for mineralisation in the subsoil: the median N availability index in the subsoil was 1.2% of total N (by weight), almost the same as in the topsoil at 1.3% of total N.

**Figure 2.** Amount of nitrogen loss from leaching, denitrification, and volatilisation (kg/annum) from the different compartments for existing and improved agroforestry farm systems.

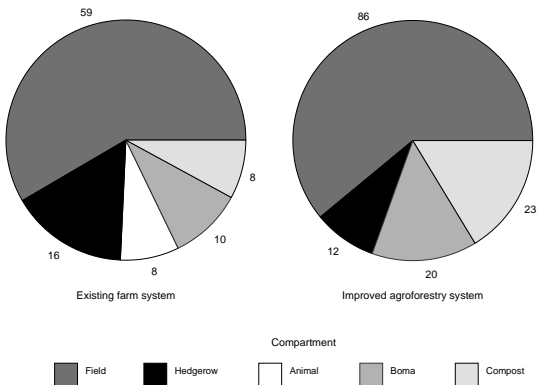

**Table 4.** Annual soil nitrogen (N) and phosphorus (P) budgets for the field compartment in the existing farm system and the improved agroforestry farm system.

	kg N/ha		kg P/ha	
	Existing	Improved	Existing	Improved
Rock weathering	–	–	0.1	0.1
Deep uptake	0	69	–	–
Biological fixation	6	69	–	–
Asymbiotic fixation	4	4	–	–
Atmospheric deposition	6	6	1.0	1.0
Fertiliser application	0	115	0	35.0
Sum inputs	16	263	1.1	36.1
Annual faeces deposited	3	0	0.5	0
Annual urine deposited	2	0	–	–
Manure from <i>boma</i>	3	31	0.4	6.7
Urine from <i>boma</i> pit	0	31	–	–
Compost	6	116	2.0	27.0
Sum transfer in	14	178	2.9	33.7
Denitrification	22	39	–	–
Volatilisation	2	0	–	–
Leaching	39	69	–	–
Sum outputs	63	108	0	0
Tree leaf fed	0	48	0	2.4
Fuelwood	0	4	0	0.3
Crop harvest, fodder	0	224	0	45.1
Crop harvest, grain	26	75	3.5	9.9
Crop residues, fodder	4	27	0.4	2.7
Crop residues, fuel	2	0	0.2	0
Erosion to hedgerow	11	0	3.7	0
Sum transfer out	43	378	7.8	60.4
Field balance	–76	–45	–3.8	+9.4

P was efficiently conserved because there were few pathways for loss from the farm system. The losses in the existing farm system were from field erosion (3.8 kg P/ha, but 80% of this was captured by the hedgerow), deposition off-farm by livestock in faeces (0.9 kg P/ha), loss in the *boma* (0.1 kg P/ha), and loss on composting (0.9 kg P/ha). Even in the improved agroforestry system losses were only 1.8 kg P/ha from the *boma* and 3.0 kg P/ha from the compost, compared with a harvested produce of 35 kg P/ha.

### Nutrient budgets

Nutrient budgets in terms of the net soil balance of the field plus hedgerow compartments were analysed. These ranged from –39 to –110 kg N/ha and –7 to +31 kg P/ha in the different farm systems (Table 5). These contrast with the positive balances of >300 kg N/ha found on high input dairy farms in Europe (Frissel, 1978: 88). Even when leaching and denitrification were set to zero the soil-N deficits remained significant at –37 kg N/ha in System 1 and –88 kg N/ha in System 8.

**Table 5.** Soil nitrogen and phosphorus budgets for the field plus hedgerow compartments.

	Farm system <sup>a</sup>							
	1	2	3	4	5	6	7	8
	Net soil-N balance (kg/ha)							
	-86	-76	-94	-118	-70	-39	-69	-110
	Consumable harvested N (kg/ha)							
Grain	21	21	21	25	37	21	59	60
Milk	10	10	14	10	11	10	12	109
Fuelwood <sup>b</sup>	2	2	7	2	14	5	5	9
Polewood	2	2	18	2	2	2	2	18
Total harvested	35	35	59	39	64	38	78	195
	Cycled N (kg/ha)							
Biological fix	9	9	9	10	26	30	11	59
Deep uptake	12	12	31	12	39	39	12	63
Total cycled	21	21	40	22	65	69	23	122
	Net soil-P balance (kg/ha)							
	-3.8	-3.3	-7.3	-4.0	-6.2	-3.2	30.6	-1.6

a. 1. Existing; 2. improved composting; 3. improved boundary planting; 4. natural fallow; 5. improved fallow; 6. hedgerow intercropping; 7. high fertiliser inputs; and 8. improved agroforestry.

b. Fuel-wood includes crop residues used as fuel.

The agroforestry systems (3, 5, 6, 8 in Table 5) significantly increased N inputs from cycled N (biological N fixation and deep N capture). However, in the systems where tree products were harvested for consumption there was little impact on the size of the soil nutrient deficit. For example, in the improved boundary planting system (compared with the existing system) the input from cycled N was increased by 19 kg N/ha, but this was more than off-set by the increase in consumable harvest of 24 kg N/ha. Similarly, two-thirds of the extra N cycled in the improved fallow system (44 kg N/ha) was off-set by the higher N harvests in grain and fuelwood compared with the existing system. Also, the use of hedgerow areas for fodder banks was not sustainable without inputs — it resulted in larger soil nutrient deficits in the hedgerow compartment (75 kg N) than in the field compartment (36 kg N).

The only system that significantly decreased the soil-N deficit was the hedgerow intercropping system in which most of the cycled N was returned to the soil as green manure. However, this benefit would also have been partially off-set if grain yields had been assumed to increase as a result of hedgerow intercropping. Nevertheless, the removal of the benefits of cycled N would significantly increase the amount of external N input required to support the same level of production. In System 8 this amounted to 122 kg N/ha, or 63% of the consumable N harvested. However, it may be unreasonable to assume that N-fixing trees can provide a sink for deep N uptake similar to that provided by non-fixing trees.

The possible implications of ignoring inputs via root growth processes can be assessed by assuming that 20% of the cycled N input was retained in root biomass. This would reduce the N deficits by only 4 kg N/ha (5%) in System 1 and by 24 kg N/ha (22%) in System 8.

The trends in the deficits for the soil-P budgets were broadly similar to those for the soil-N budgets, except that moderate applications of P fertilisers significantly reduced the deficits or resulted in a positive balance. However, P requirements for adequate availability to crops would be larger than required to maintain zero soil balances because these soils can absorb large quantities of P, of up to 400 mg P/kg soil at soil solution concentrations of 0.2 mg P per litre (Okalebo, 1987).

Improved manure and compost management had a significant impact on soil-N budgets, notably in the improved agroforestry system with zero-grazing because of the large manure flux. Improved manure management reduced the soil-N deficit by 10 kg N/ha in the existing system, but removing good management from the zero-grazing system increased the deficit by 71 kg N/ha.

## Conclusion

The model proved a useful tool for exploring limits on the potential impact of alternative farm management practices on soil nutrient stocks, taking into account organic and inorganic nutrient resources available both on and off the farm. However, nutrient balances were sensitive to estimates of mineralisation, leaching and denitrification, for which reported field measurements are scarce.

The results suggest that the integration of trees on to farms for production purposes (fuel, poles, timber and milk) may not decrease the rate of depletion of soil nutrient stocks. On the contrary, there is opportunity for accelerating nutrient depletion. However, strategies that maximise inputs by biological N fixation and the capture of subsoil-N by deep-rooted plants may substantially reduce the amounts of external N inputs required to support a given level of farm production.

While soil-P stocks may be maintained or increased by moderate additions of inorganic P fertilisers this may not be the case for N. Inorganic N inputs alone may not be sufficient to maintain or increase soil organic N on depleted soils, even when coupled with management strategies to reduce N losses. What is additionally required is that a higher proportion of the N input is retained in the system rather than being exported in harvests. In the absence of external organic inputs, this will require an increase in the proportion of biomass N that is returned to the soil (either as green manure or increased root growth) at the expense of N removal in harvests. Unfortunately, these strategies are not normally economical in the short-term, but may have to be considered for sustainable soil use.

Research priorities for the humid highland farming systems include the quantification and dynamic modelling of (1) N mineralisation and N dynamics throughout soil profiles, (2) spatial and temporal patterns of N uptake by trees in agroforestry systems, and (3) nutrient budgets in long-term systems trials.

## Acknowledgements

We acknowledge the support of the on-farm technical staff of the KEFRI/KARI/ICRAF Agroforestry Research Project at Maseno, Kenya, and of the laboratory technical staff at KARI, Muguga, Kenya. We thank the Rockefeller Foundation and SIDA for financial support, and Drs Odera and Nyamai of KEFRI for facilitating collaborative links between the institutions involved.

## References

- Anderson J M and Ingram J S I (eds). 1989. *Tropical soil biology and fertility: A handbook of methods*. CAB (Commonwealth Agricultural Bureaux International), Wallingford, UK. 171 pp.
- ARC (Agricultural Research Council). 1980. *The nutritional requirements of ruminant livestock*. CABI (Commonwealth Agricultural Bureaux International), Slough, UK. 351 pp.
- Barber R G, Moore T R and Thomas D B. 1979. The erodibility of two soils from Kenya. *Journal of Soil Science* 30:579-591.

- Bayer W. 1990. Napier grass – a promising fodder for smallholder livestock production in the tropics. *Plant Research and Development* 31:103–111.
- Commerford N B, Kidder G and Mollitor A V. 1984. Importance of subsoil fertility to forest and non-forest plant nutrition. In: Stone E L (ed), *Forest soils and treatment impacts*. Proceedings of the Sixth North American Forest Soils Conference, June 1983. The University of Tennessee, Knoxville, USA. pp. 381–404.
- CSIRO (Commonwealth Scientific and Industrial Research Organisation). 1990. *Feeding standards for Australian livestock ruminants*. Standing Committee on Agriculture, Ruminants Subcommittee, CSIRO, East Melbourne, Australia. 266 pp.
- Frissel M J (ed). 1978. *Cycling of mineral nutrients in agricultural ecosystems*. Agro Ecosystems 4. Elsevier Scientific Publishing Company, Amsterdam, The Netherlands. pp. 1–354.
- Gachene C K K. 1989. Nutrient losses in eroded soil material from some Kenyan soils. In: Thomas D B, Biamah E K, Kilewe A M, Lundgren L and Mochoge B O (eds), *Soil and water conservation in Kenya*. Department of Agricultural Engineering, University of Nairobi, Kenya. pp. 34–37.
- Giller K E and Wilson K J. 1991. *Nitrogen fixation in tropical cropping systems*. CABI (Commonwealth Agricultural Bureaux International), Wallingford, UK. 313 pp.
- Guar A C, Neelakantan S and Dargan K S. 1984. *Organic manures*. Indian Council of Agricultural Research, New Delhi, India. 160 pp.
- Hingston F J. 1977. Sources of, and sinks for, nutrients in forest ecosystems. In: *Proceedings of a Nutrient Cycling in Indigenous Forest Ecosystem Symposium*. CSIRO (Commonwealth Scientific and Industrial Research Organisation) Division, Land Resource Management, Perth, Australia. pp. 41–53.
- Jatzold R and Schmidt H. 1982. *Farm management handbook of Kenya. Vol II/A: West Kenya*. Ministry of Agriculture, Nairobi, Kenya. 397 pp.
- KEFINCO. 1990. *Western Province Kakamega District Map, July 1990. Water supply development plan 1990*. Ministry of Water Development, Nairobi, Kenya.
- Kwakye P K. 1980. The effects of method of dung storage and its nutrient content and crop yield in the north east savanna zone of Ghana. In: FAO (Food and Agriculture Organization of the United Nations), *Organic recycling in Africa*. FAO, Rome, Italy. pp. 282–288.
- Muturi W M and Franzel, S. 1992. Availability and use of wood products in the high potential zones of western Kenya. *East and Central African AFRENA Workshop*. Kigali, Rwanda, 22–26 June 1992. Summary Proceedings. AFRENA Report 58. ICRAF (International Centre for Research in Agroforestry), Nairobi, Kenya. pp. 48–50.
- Ndufa J K, Ohlsson E and Shepherd K D. 1992. *Participatory research methods for agroforestry technology development in western Kenya*. A paper presented to the 12th Annual Farming Systems Symposium, Michigan State University, USA, 13–18 September 1992. 14 pp.
- Noordwijk van M. 1989. Rooting depth in cropping systems in the humid tropics in relation to nutrient use efficiency. In: van der Heide J (ed), *Nutrient management for food crop production in tropical farming systems*. Institute for Soil Fertility, Haren, The Netherlands. pp. 129–144.
- Okalebo J R. 1987. *A study of phosphate fertilizers on maize and sorghum production in some East African soils*. PhD thesis, University of Nairobi, Kenya.
- Page A L, Miller R H, and Keeney D R (eds). 1982. *Methods of soil analysis. Part II: Chemical and microbiological properties*. American Society of Agronomy, Madison, USA. pp. 727–728.
- Powell J M and Mohamed-Saleem M A. 1987. Nitrogen and phosphorus transfers in a crop–livestock system in West Africa. *Agricultural Systems* 25:261–277.
- Probert M E, Okalebo J R, Simpson, J R and Jones R K. 1992. The role of boma manure for improving soil fertility. In: Probert M E (ed), *A search for strategies for sustainable dryland cropping in semi-arid eastern Kenya*. ACIAR (Australian Centre for International Agricultural Research), Canberra, Australia. pp. 63–70.
- Sands W W. 1983. *Role of livestock on smallholder farms in western Kenya: Prospects for a dual purpose goat*. PhD thesis, Cornell University, Cornell, USA. 218 pp.



- Smaling E M A, Stoorvogel J J and Windmeijer P N. 1993. Calculating soil nutrient balances in Africa at different scale. II: District scale. In: Smaling E (ed), *An agro-ecological framework for integrated nutrient management with special reference to Kenya*. Doctoral thesis, Agricultural University, Wageningen, The Netherlands. pp. 93–120.
- Stoorvogel J J and Smaling E M A. 1990. *Assessment of soil nutrient depletion in sub-Saharan Africa: 1983–2000. Vol. III: Literature review and description of land use systems*. Report 28. The Winand Staring Centre, Wageningen, The Netherlands. 137 pp.
- Stoorvogel J J, Smaling, E M A and Janssen B H. 1993. Calculating soil nutrient balances in Africa at different scales. I: Supra-national scale. In: Smaling E (ed), *An agro-ecological framework for integrated nutrient management with special reference to Kenya*. Doctoral thesis, Agricultural University, Wageningen, The Netherlands. pp. 75–90.
- Swift M J, Frost P G H, Campbell B M, Hatton J C and Wilson K B. 1989. Nitrogen cycling in farming systems derived from savanna: Perspectives and challenges. In: Clarholm M and Bergstrom L (eds), *Ecology of arable land*. Kluwer Academic Publishers, Dordrecht, The Netherlands. pp. 63–76.
- Van der Pol F. 1992. *Soil mining as a source of farmers' income in southern Mali*. Bulletin 325. Royal Tropical Institute, Amsterdam, The Netherlands.
- Van der Valk Y S. 1990. Review report of the DEAF-surveys during 1989. NDDP (National Dairy Development Project), Ministry of Livestock Development, Naivasha, Kenya. 69 pp.
- Visser T. 1960. Interplanting in tea. I. Effects of shade trees, weeds and bush crops. *Tea Quarterly* 32:69–87.
- Wenner C G. 1981. *Soil conservation in Kenya*. The Soil Conservation Extension Unit, Ministry of Agriculture, Nairobi, Kenya. 230 pp.
- Wischmeier W H and Smith D D. 1978. *Predicting rainfall erosion losses. A guide to conservation planning*. Agricultural Handbook 537. USDA (United States Department of Agriculture), Washington, DC, USA. 58 pp.
- Woodmansee R G. 1979. Factors influencing input and output of nitrogen in grasslands. In: French N R (ed), *Perspectives in grassland ecology*. Springer-Verlag, New York, USA. pp. 117–134.
- Young A. 1989. *Agroforestry for soil conservation*. CABI (Commonwealth Agricultural Bureaux International), Wallingford, UK. 276 pp.

# African semi-arid tropical agriculture cannot grow without external inputs

*J. McIntire<sup>1</sup> and J.M. Powell<sup>2</sup>*

1. The World Bank, 1818 H Street, N.W., Washington, D.C. 20433, USA

2. 458 Glenway Street, Madison WI 53711, USA (formerly with ILCA)

## Abstract

A multi-period non-linear optimisation model was constructed of a mixed millet and cattle producing area in the semi-arid tropics of Niger, a poor West African country which is largely agricultural. The model compared the economics of “low-input sustainable” (LIS) agriculture, with animal manure but without mineral fertilisers, to those of agriculture using mineral fertilisers and manure subject to a minimum soil fertility constraint. Agriculture using mineral fertilisers was superior at average fertiliser prices, at fertiliser prices 50% higher than average and at a higher fertiliser response to LIS agriculture. LIS agriculture was not more stable than agriculture with mineral fertilisers and did not grow more rapidly. A low economic interest rate did not affect the results significantly. LIS agriculture is inferior because it requires very high pasture area per unit of crop area — at least in a ratio of 10:1 — in order to produce enough manure to maintain soil fertility in the absence of mineral fertiliser. Such pasture area would only be available at very low population densities; at higher population densities, competition for land between crops and livestock without mineral fertilisers necessarily results in low income or exhaustion of the soil.

## Les intrants extérieurs, facteurs indispensables au développement agricole dans la zone semi-aride de l’Afrique tropicale

*J. McIntire<sup>1</sup> et J.M. Powell<sup>2</sup>*

1. Banque mondiale, 1818 H Street, N.W., Washington, D.C. 20433 (E.-U.)

2. 458 Glenway Street, Madison WI 53711 (E.-U.) (précédemment en service au CIPEA)

## Résumé

*Un modèle d’optimisation non linéaire et multipériodique a été construit pour une région où la production de mil est associée à l’élevage bovin dans la zone semi-aride du Niger, pays pauvre à vocation essentiellement agricole de l’Afrique de l’Ouest. Ce modèle a servi à comparer la rentabilité économique d’une agriculture durable à faible niveau d’intrants utilisant du fumier mais pas d’engrais minéraux, et celle d’une agriculture utilisant des engrais minéraux et du fumier et moins préoccupée par les problèmes de fertilité des sols. Cette dernière était plus rentable que l’agriculture durable aux prix moyens des engrais, lorsque ces prix étaient de 50% supérieurs aux prix moyens et lorsque la réponse à l’application des engrais était élevée. L’agriculture durable n’était pas plus stable et ne croissait pas plus vite que l’agriculture utilisant des engrais minéraux. Une baisse des taux d’intérêt n’affectait pas les résultats. En fait, l’agriculture durable était moins performante car il fallait de très vastes superficies de pâturage par unité de surface cultivée — au moins dans un rapport de 10 à 1 — pour produire suffisamment de fumier afin de maintenir la fertilité des sols. De telles superficies ne peuvent être disponibles que si la densité de la population est très faible. A des densités plus élevées et en l’absence d’engrais minéraux, la concurrence entre les cultures et le bétail pour la terre se traduira inévitablement par de très faibles revenus ou l’épuisement des sols.*

## Introduction

Mixed farming systems of semi-arid West Africa (SAWA) are characterised by the cultivation of pearl millet (*Pennisetum glaucum* [L.] R.Br.), sorghum (*Sorghum bicolor* [L.] Moench.), cowpeas (*Vigna unguiculata* L. Walp.) and groundnuts (*Arachis hypogea*), and the raising of cattle, sheep and goats. Crop and livestock production are always complementary enterprises. Crop residues provide important feeds, especially during the 6 to 8 month dry season, and animals are used for transport and traction and provide manure that sustains the yields of many cultivated areas.

The expansion of the cultivated areas has been the most common path for augmenting crop production. The rate of bringing new land under cultivation has been much faster than population growth, however, causing severe stress on the land resource base (Boulier and Jouve, 1988). Grain yields per unit area have decreased over this period. The decline in fallowing practices for soil fertility maintenance and the expansion of cropping into marginal lands has mined soil nutrients (Stoorvogel and Smaling, 1990), jeopardising the long-term sustainability of the farming system.

The cycling of biomass through livestock in the form of manure and urine that fertilise the soil has long been an important means of restoring soil nutrients in semi-arid Africa (McCown et al, 1979; Swift et al, 1989; McIntire et al, 1992; Powell and Williams, 1993). The predominantly sandy soils of SAWA are very low in organic matter (Kowal and Kassam, 1978; Pieri, 1989), nitrogen and especially phosphorus. Although manuring greatly improves these soil properties and crop yields, (Abdullahi and Lombin, 1978; Powell, 1986; Bationo and Mokwunye, 1991), the amounts of available manure are limited and insufficient for widespread use. Long-term gains in crop production will therefore require increased use of chemical fertilisers (Bremen, 1990; Van Keulen and Bremen, 1990). However, the cost of fertilisers is high compared to their economic productivity therefore little is applied to cropland.

Sustainable agriculture is often argued to be urgently required in SAWA, but serious analysis of its potential attainment is scarce. This paper seeks to give some empirical meaning to one variant of sustainable agriculture by analysing its costs and benefits over time. A putatively sustainable system, based on nutrient cycling between crops and livestock in a mixed farm enterprise is used as an illustration of a semi-arid tropical site in western Niger. The site is representative of the drier parts of the African semi-arid tropics and is one where sustainable farming systems are urgently needed to prevent land degradation.

## Characteristics of two SAT farming sites

Two sites were chosen for long-term studies of SAT farming in Niger. The sites are roughly 13 and 14° N and 2° E. There are two villages at each site. Population density is 1015 persons/km<sup>2</sup> at the northern site and 50–60 in the southern one. The climate is hot and usually dry. More intensive modes of crop and livestock production are practised in the more densely populated southern areas. These sites have higher annual rainfall (600 mm) as compared to the areas of lower population densities (400 mm). Other aspects that differentiate the high from low population density sites include more land under permanent cultivation than in fallow, smaller cultivated areas per household and more manuring per unit of land.

Crop production is almost entirely rainfed and there is only one growing season, of 90–120 days. The principal crops are millet (by far the most important), cowpea, sorghum, groundnut, and some vegetables. There are no perennial crops of importance. Livestock are an important complement to grain production. There is almost no farm mechanisation, except animals for transport, and all field activities are done with hand labour. Essentially all work is done by family members and few farmers hire labour. A description of the millet production system can be found in McIntire and Fussell (1989).

Crop and livestock production interact closely. The interactions can be competitive or complementary. Livestock graze residues produced by crops and crops use manure produced by animals. Corralling animals overnight on fields during the dry season is the predominant method of

manuring cropland. Some manure is also gathered from corrals outside the cropped areas and hand spread on to fields. Higher manure application rates (3.8 versus 1.3 t/ha), shorter intervals between applications (2–3 years), and smaller cultivated areas (3.2 versus 9.2 ha/household) occur in the higher than the lower population density areas of western Niger where cattle are more important than sheep and goats (Powell and Williams, 1993).

Millet and cattle are by far the most important enterprises. Almost no cash inputs are used in either. Production is highly variable, due to variations in rainfall. Crop and livestock production interact closely and the interactions can be competitive or complementary. Crops use manure produced by animals while livestock graze crop residues. Both activities compete, however, for labour or land. The millet–cattle systems and the principal interactions between them have been described by McIntire et al (1992).

## A model of crop–livestock farming

The farming system in western Niger is summarised in a model with two goods, millet and cattle (Table 1). Other crops occupying small areas are excluded. Sheep and goats are common but are excluded to simplify the notation.<sup>1</sup>

**Table 1.** *Average values of some model variables.*

Variable	Average Value	Source
Cattle production		McIntire et al (1992); S. Fernández-Rivera and P. Hiernaux (pers. comm.); Powell and Fussell (1993)
Daily feed intake, kg/TLU <sup>1</sup>	6.3	
Daily manure output, kg/TLU <sup>1</sup>	3.0	
Manure N content, %	1.5	
Net herd growth, %	5	
Natural pasture production		"
Consumable pasture yield, kg/ha <sup>1</sup>	1200	
Pasture digestibility, %	55	
Pearl millet production		"
Grain yield, kg/ha	250	
Grain N content, %	2.0	
Usable stover yield, kg/ha <sup>1</sup>	315	
Stover N content, %	1.0	
Soil fertility		Brouwer and Powell (this volume)
Initial N storage kg/ha to 2-m depth		
Millet field	2500	
Prices <sup>1</sup>		World Bank (1992b)
Millet grain, \$/t	175	
Cattle live weight, \$/t	980	
Urea (45% N), \$/t of N	540	
Real interest rate, annual %	10	
Other		World Bank (1992a)
Annual population growth, %	3.3	

1. Derivation in appendix.

1. The model treats sheep and goats as small cattle, in essence. The drawback to this assumption is that the risk of small ruminant production may differ significantly from that of cattle production.

A model of crop–livestock farming requires some assumptions about how producers behave and a quantitative structure of the production technology. The behavioural assumptions in this paper are that producers are rational—that they attempt to use their resources efficiently within the limits of the information and technology available to them.

With respect to the production technology, one alternative is a statistical estimation of its structure using a profit function for farms producing several crops jointly. Such models may be superior to single-product econometric models because they capture the interactions among different outputs. They would also be superior to normative programming models, because they do not assume a given production technology. The joint product profit function approach was not feasible here because data to estimate a production function for livestock or to estimate a full set of interactions among inputs for crops are lacking. The approach here was to extract the production technology from survey and experimental data and to put it into a non-linear multi-period optimisation model.

## **Millet**

Millet production uses labour, land and soil fertility inputs, but no fixed inputs such as machinery or draft animals. Labour is by far the most important input, but is not included in the model reported in this paper because it is used at such low intensity—less than 100 hours per hectare per year (McIntire and Fussell, 1989)—that it is not a constraint to millet production over the full year. If the model were a seasonal one, or were it restricted to only a few weeks in the agricultural season, then it would be relevant to include labour.

The millet production function is:

$$q_t = af(m,z)_t + q_0 \quad (1)$$

where:

$q$  is millet grain yield per hectare

$t$  is year

$a$  is area cropped in millet

the function  $f(m, z)$  represents the millet grain yield response to manure and mineral fertilisers

$m$  is manure

$z$  is mineral fertiliser

$q_0$  is the base yield

Manure and mineral fertilisers, collectively termed soil fertility inputs, appear separately in the production function because they have distinct effects on output. The base yield,  $q_0$ , is determined by a random number generator annually from the mean and standard deviation of grain yield (250 and 100 kg/ha, respectively).

The highest population densities have the greater potential positive response to fertiliser and manure addition (due to more favourable rainfall) and accessibility to inputs than areas of lower population density. Indeed, over a two-year period, millet yield in an area of higher rainfall (650 mm) and population density were double the yields in an area of lower rainfall (350 mm) and population density (Williams et al, this volume).

The response function of millet grain to fertiliser is quadratic

$$q = 6z - 0.03z^2 \quad (2)$$

as is the manure response function:

$$q = 0.075m - 0.0000055m^2 \quad (3)$$

Manure and fertilisers have positive effects on millet stover yield. Stover increases due to fertiliser and manure are proportional to increases in grain yield (Powell and Fussell, 1993). Millet stover (leaf plus stalk) yield can be estimated from the equation:

$$s = [\text{grain} - \text{grain}(\text{HI})/\text{HI}] \quad (4)$$

where:

$s$  is millet stover

$HI$  is the harvest index or the grain fraction of total millet biomass (grain plus stover) which equals approximately 0.25

Not all millet stover can be consumed by livestock. Consumable millet stover is approximately 75% of total leaf and 20% of the total stalk yield where leaf is 40% and stalk 60% of stover yield at grain harvest (Fernández-Rivera et al, this volume), giving a ratio of usable stover to grain of 1.26.

## Cattle

The cattle herd is equal to the herd in the previous year minus offtake plus net births (births minus deaths):

$$h_t = h_{t-1} - \Theta_t + \Omega_t \quad (5)$$

where:

$h$  indicates herd size

$\Theta$  indicates offtake

$\Omega$  indicates the annual rate of net births

all expressed in tropical livestock units (TLU).<sup>2</sup>

Offtake—the number of animals sold annually—is determined by the balance between feed demand and feed supply. Letting net births be zero, defining  $u_t$  as the total supply of feed from all sources, and  $n$  as the constant annual feed intake of 1 TLU, then the feasible herd in any year is  $h_t = u_t/n$ , and:

$$\Theta_t = h_{t-1} - u_t/n \quad (6)$$

The total supply of feed from all sources,  $u_t$ , is:

$$u_t = r_t*(A - a_t) + s_t*a_t \quad (7)$$

where:

$r_t$  is consumable pasture yield

$A$  is total land area (crops plus pastures)

Annual pasture yield is determined by a random number generator from a mean of 810 kg/ha and a standard deviation of 324 kg/ha, both expressed in consumable pasture.

Offtake is always negative, or in other words, cattle purchases are not allowed. Purchases of adult animals for breeding, as opposed to immediate consumption, are rare because of the costs and risks of acquiring breeding stock through a market.

The impact of labour use on livestock output is ignored. This is because of economies of scale when animals are managed collectively, as is the practice in western Niger. The range of possible herd sizes for a given labour input is large and, therefore, the range of possible marginal products of labour is small.

## Crop–livestock interactions

Two important interactions occur between millet and cattle production. Millet produces crop-residue inputs for cattle production, and herds produce manure that can be used for crops. Total crop residue output,  $S_t$ , is given by:

$$S_t = a_t s_t \quad (8)$$

and manure production by:

$$m_t = h_t M \quad (9)$$

where:

$M$  is a constant expressing the manure produced annually per TLU (see Appendix)

In this model, crop-residue use is restricted to cattle feed. This admittedly unrealistic assumption is likely to affect the results and therefore deserves some comment. Analysis of the Niger sites, and

2. A TLU is one animal of 250 kg live weight.

of others in Ethiopia and Nigeria (McIntire et al, 1992) showed that feeding crop residue to livestock was usually more profitable than mulching it to the soil. Because that conclusion was believed to be very sensitive to the grain prices and labour costs used in the analysis, sensitivity analysis was done for several grain prices and wage rates, and the conclusion did not change.

The superiority of grazing over mulching depended on the assumption that the stocking rate was infinite. A more complete linear programming model of crop residue management at the Niger site was then done with a finite stocking rate. At finite stocking rates, and without mineral fertiliser, about 60% of crop residue would be mulched and 40% grazed (McIntire et al, 1992:130). It is therefore probable that the scenarios without fertiliser presented in this paper understate total income because they exclude the option of mulching crop residue.

### **Soil fertility**

The key resource in the long-term sustainability of this farming system is the soil. Measures of the soil resource are the quantities of N, P, and organic matter. In western Niger, mineral fertilisers, manure, and crop residues can supply N, P and organic matter for millet production; crop residues can also provide livestock feed.

The soil resource is considered to be the stock of nitrogen available at the beginning of the production process. Crop production both exports nitrogen in grain and straw and imports it as manure or mineral fertiliser. Natural inputs of N into these productions systems are considered minimal although biological N-fixation can be high in some instances. The stock of soil N is:

$$N_t = a_t(N_m + N_z - N_g - N_s)_t + (A - a_t)r_t N_{rt} + N_{t-1} \quad (10)$$

The amount of manure that can be captured and applied to cropland and its nutrient content vary considerably (Fernández-Rivera et al, this volume), but those sources of variation cannot be taken into account in this model. The model assumes a constant daily manure output of 3 kg/TLU of which 1.0 kg is deposited during nighttime corralling on cropland. The remainder is deposited on pasture. Negligible amounts of manure are returned to millet fields during crop residue grazing (Van Raay, 1975; Powell, 1986) and are not considered in this model.

Assumptions on initial soil-N are critical to the response functions. Equations 2 and 3 assume continuously cultivated soils. Responses to manure and fertilisers would be quite different in the last 4 to 5 years before fallow. After fallow, built-up soil organic matter reserves mineralise and provide N so millet response to fertiliser- and manure-N might then be minimal.

The stock of soil nitrogen in any year is equal by definition to the stock carried over from the previous year,  $N_{t-1}$ , plus the additions of N from fertiliser and manure, minus the N removed by grain, straw and pasture production ( $N_g$ ,  $N_s$  and  $N_r$ , respectively). The N stock in the initial year ( $t = 0$ ),  $N_0$ , is the stock of nitrogen in the soil after a long fallow.

The stock of initial soil-N is equal to soil-N storage of 2500 kg/ha to a 2 m depth (Brouwer and Powell, this volume) in a continuously cropped millet field under traditional management. Nutrient levels of continuously cultivated fields are in equilibrium when nutrient exports equal nutrient imports. If N imports exceed N exports, the surplus N would be carried over for the next crop. It is understood that this formulation of the soil constraint ignores the possible long-term negative effects (acidification) of mineral fertiliser and positive effects (increases in cation exchange and water holding capacities and soil pH) of manuring. By definition, the stock of N can never be negative, but the annual change in the stock can be positive or negative. If N imports are greater than N exports—i.e. the annual change in the stock is positive—then the difference is stored in the soil and carried over into the next year, and vice versa if the change in the stock is negative.

### **Population growth**

National population growth is projected to be 3.3% annually in the next decade (World Bank, 1992a). Population in any year is therefore  $P_t = P_0(1.033)^t$ .

## Prices

The prices of millet grain and of livestock are fixed in real terms throughout the 20 years of each simulation. However, the price of N fertiliser varies annually. It is determined by a random number generator from the calculated mean and standard deviation of world urea prices.

## The objective function

The multi-period programming programme is fully described by equations (1) through (10). The equations have three annual decision variables: cropped area, the quantity of fertiliser to apply, and offtake. Because the total area is fixed, the pasture area is defined by the total area minus the cropped area, so pasture area is not a decision variable. The quantity of manure to apply is not a decision variable because it is determined by the herd size at the end of a year, which is itself a function of pasture area (total – cropped) and offtake.

The formal problem is:

$$\text{maximise NPV } \sum_t \pi_t = a_t (p_q f(m, z)_t) - p_1 \Theta_t - z_t p_z \quad (11)$$

where:

$p_q$  is the price of millet grain

$p_1$  is the price per cattle TLU

The second term on the right-hand side, expressing the value of livestock sales, is negative because a sale of livestock is defined as negative offtake from equation (5).

Equation (11) is maximised by solving for the vectors of  $[a]_t$ ,  $[z]_t$  and  $[\Theta]_t$ , subject to the constraints:

$$\begin{aligned} [a]_t &\geq 0 \\ [a]_t &\leq 100, \text{ the maximum land area} \\ [z]_t &\geq 0 \\ -[\Theta]_t &\geq 0 \\ -[\Theta]_t &\leq h_{t-1} \\ h_t &\geq 0 \\ N_t &\geq 0 \end{aligned}$$

The partial derivative of the objective function with respect to fertiliser is:

$$\partial \pi / \partial z = a \{ p_q (\partial q / \partial z) + p_1 [\Psi (\partial q / \partial z) / n] \} - p_z, \quad (12)$$

where the second term on the right hand side is the indirect effect of fertiliser on livestock offtake through the production of crop residue, and the constant  $\Psi$  is the average ratio of available digestible stover to millet grain yield of 1.26 (see Appendix for derivation) and the year subscript is suppressed.

The partial derivative of the objective function with respect to offtake is:

$$\partial \pi / \partial \Theta = P_1 - \{ [p_q (\partial q / \partial m) \Delta m / \Delta \Theta] - P_1 [\Psi (\partial q / \partial m) \Delta m / \Delta \Theta] / n \} \quad (13)$$

The right hand side of equation (13) represents the net effect of offtake on profits. The net effect has three components. The first is the positive direct effect of livestock sales. The second is the negative indirect effect of offtake on profits through its indirect effects on manure availability and hence on grain yield output. The third is the indirect negative effect on profits through manure availability, stover production and feasible herd size.

## Construction of the model

The millet production function was estimated with farm data collected from studies done in Niger from 1982 through 1985 (McIntire and Fussell, 1989), from experimental data from many African sources as reported in McIntire et al (1992), and from other information contained in the references.



The simulation period is 20 years; a longer period increases the solution time enormously with little effect on the results. The total area modeled is 100 hectares; the area to model has no effect on the results, so 100 hectares is used because it is a round number.

### **Relations among inputs**

The model is simplistic in the sense that it does not incorporate complex interactions among inputs. For example, greater manure and fertiliser use in this model do not imply more labour use, but obviously would in a real farming situation. In addition, more land use always requires more labour, and sometimes more fertility inputs if additional land cultivated is of poorer quality.

### **Initial conditions**

Models of this type are sensitive to the conditions in the first year of the simulation. Particularly important initial conditions are: the stock of N in the soil; the cropped area and the herd size. The initial stock of N in the soil is roughly equal to that found in a continuously cultivated millet under traditional management. The initial cropped area is set at 24 hectares, which is the area needed to produce the food for consumption by 30 people living on 100 hectares; the remaining 76 hectares are given to pasture. The initial herd size is determined from the feed produced from the specified areas in crops and pastures and from the average yields of pastures and crop residues. The initial quantity of manure available is determined directly from the herd size. The initial quantity of fertiliser used is the profit-maximising quantity. The initial offtake is set to zero.

## **Results**

The basic sustainability questions are: what path of agricultural income over time maximises the net present value (NPV) of income; what production systems are associated with the highest income; and how stable are the paths of income?

Values of the basic model parameters are given in Table 1. Figure 1 depicts the results derived from the initial model parameters, shown as the average fertiliser price scenario in Table 2. The most relevant comparisons are the ribbons in Figure 1 depicting the average fertiliser price scenario and the no fertiliser scenario.

**Table 2.** *Results of initial scenarios.*

Average values in 20-year scenario	Average fertiliser price	High fertiliser price	No fertiliser	High fertiliser response
Cropped area, ha	62.5	56.1	22.6	90.0
Herd, TLU	5.0	5.0	7.6	30.1
Offtake, TLU	-2.1	-2.1	-2.3	-3.3
Fertiliser, kg of N/ha	50.9	42.5	0.0	97.1
Income				
Average, \$/capita	104	92	42	233
cv, %	44	45	68	16

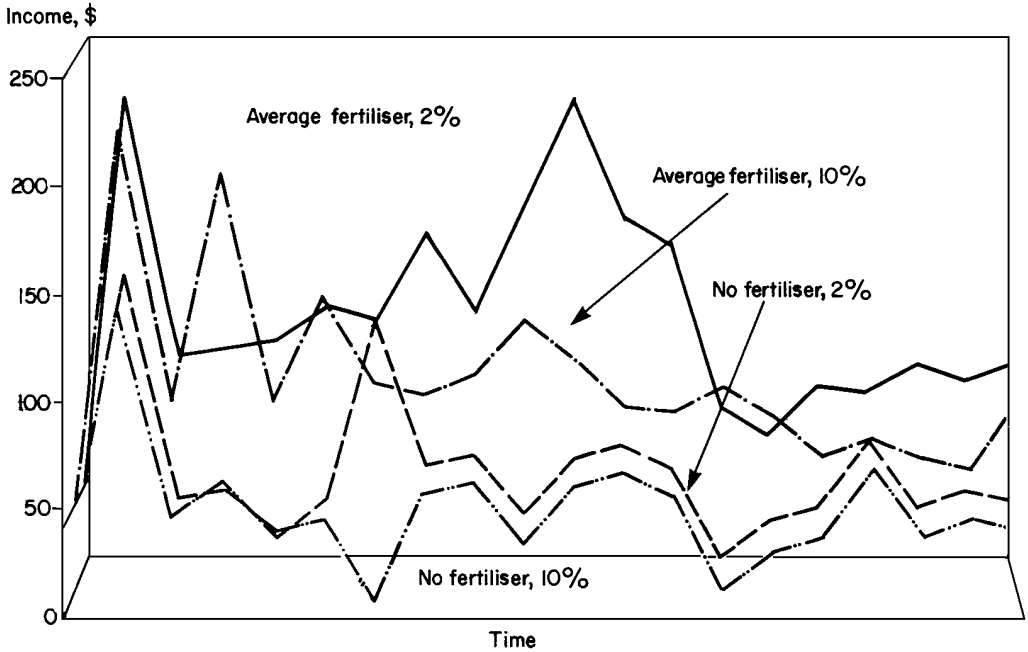
**Figure 1.** Annual average per caput income in initial scenarios.

The scenario with no mineral fertiliser use most closely represents the historical situation. With average fertiliser prices, although no fertiliser is used; (i) cropped area falls to 22.6 from 62.5 hectares; (ii) the average herd grows by about 52%; and (iii) average income falls 60%. With respect to the change in income, the coefficient of variation in the no-fertiliser scenario is 55% more than that of the average fertiliser price scenario, i.e. lower income without fertiliser is associated with much higher relative variation of income. Figure 1 shows more about the behaviour of per capita income in the initial scenarios. The nofertiliser scenario is never as good as any of the others and the high fertiliser response scenario, which represents high-input agriculture, is always better.

The average fertiliser price scenario does not exclude manure use, but the quantity of manure per hectare is only about 26% of that in the nofertiliser price scenario. The quantity per hectare is lower in the average fertiliser price scenario because the herd size is 34% smaller and the cropped area is 2.8 times as large. These relations show the basic constraint to the manure variant of LIS agriculture—it is a form of recycling that can generally only be applied to very small areas because it is constrained by feed availability. The higher fertiliser prices in the initial scenarios cause: (i) a 12% decline in mean income; (ii) no decline in mean herd size; and (iii) 13% less relative income variability.

### Cyclical scenarios

A key assumption in the initial scenarios is that crop and pasture yields are not cyclical, though they are highly variable. Assume now that they are cyclical, with regular rising and falling phases. Such cyclical yields would be caused by cyclical patterns of rainfall that may occur in semi-arid West Africa. Within each phase, there is still random variation around the rising or falling trend. During the rising phase, one expects longer buildup of soil N stocks and herds, and vice versa during the falling phases. In the cyclical scenario, a rising phase of 10 years is assumed to precede a falling phase of 10 years.

The cyclical scenario also requires different assumptions about the initial conditions for the cropped area, the stock of soil N and herd size. For the rising/falling scenario, the initial conditions were set equal to those obtaining at the end of the last falling period, i.e. it is assumed that the beginning of the rising cycle coincides with the end of a falling cycle.

The results for the cyclical scenarios (Figure 2) are similar to those of the initial scenarios. Higher fertiliser prices induce: (i) lower overall income; (ii) slightly lower (relatively) income variability; (iii) a larger herd size, though a lower stocking rate per hectare of pasture; and (iv) a marginally smaller cropped area. The cyclical no fertiliser scenario produces lower income than the acyclical no fertiliser scenario.

**Figure 2.** Average annual income in cyclical scenarios.

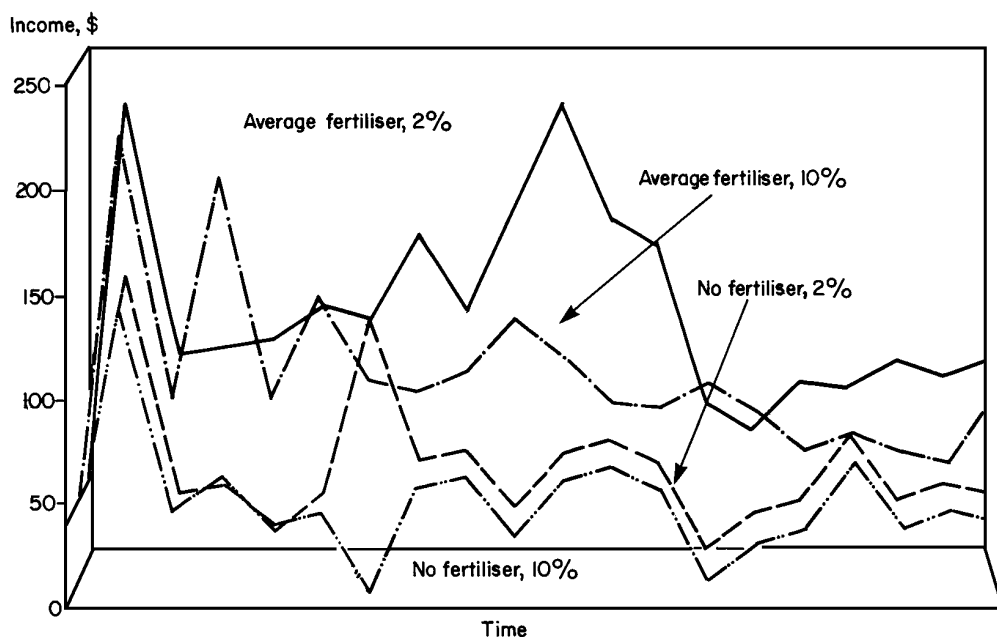

No time trend for any of the cyclical scenarios was statistically significant; however, the trends for high fertiliser prices and no fertilisers were nearly, but not, significant. This is because their mean values were lower; they were more strongly affected by the cyclical yield trends—which were introduced into the cyclical scenarios by assumption—than the scenarios with average fertiliser prices and high fertiliser responses. In the latter, the additional grain and residue yields produced by the greater fertiliser quantities tended to damp the effects of the cycles.

### Sensitivity analysis

Some results of the analysis may depend on: (i) the interest rate applied to future benefits and costs; and (ii) the cyclical nature of variations in grain and pasture yields.

### Interest rates

The interest rate to discount future values in the initial analyses was 10%. Some of the environmental literature argues that lower rates should be used to value future resources. Would a lower rate affect

the conclusions? A lower rate would encourage a longer herd build-up—by penalising future offtake less than the higher interest rate—thus permitting a longer buildup of soil N from manure alone.

Model results are presented in Table 3, and depicted in Figure 2, for two scenarios with the initial 10% real interest rate and a 2% real interest rate. The 2% interest rate is of little importance to the cropped area, offtake, fertiliser use, or per caput income without fertiliser. At the average fertiliser price scenario, the higher discount rate leads to greater cropped area, a smaller herd, more fertiliser use, and higher income. LIS agriculture is inferior to agriculture based on mineral fertiliser in terms of average income and the variability of income.

**Table 3.** *Additional scenarios — Cyclical variations, different interest rates.*

Variable	Average fertiliser price	No fertiliser	Average fertiliser price	No fertiliser
Real annual interest rate, %	2	2	10	10
Area, ha	64.0	33.7	80.9	36.6
Herd, TLU	10.2	8.4	6.1	8.4
Offtake, TLU	-1.7	-1.6	-1.4	-1.6
Fertiliser use, kg of N/ha	50.6	0.0	60.2	0.0
Income				
Average, \$/capita	105	47	125	51
cv, %	39	60	37	65

### Feed recycling from a larger area

Advocates of LIS may object to these results on the grounds that it is possible to recycle soil nutrients via manure from a much larger pasture area. For example, seasonal grazing of areas that cannot be cropped can satisfy part of the annual feed demand of livestock and thereby make more manure available than what would be available from the pasture area immediately adjacent to the cropped area. Analysing this possibility amounts to answering the question: How much more area is needed to produce an equivalent LIS income and satisfy the soilN constraint? Table 2 shows that 22.6 hectares is the average cropped area with no fertiliser and 62.5 hectares is the average cropped area with average fertiliser prices; the per capita incomes are US\$ 42 and US\$ 104, respectively.

The ratio of pasture to cropped area needed to produce a per capita income of about US\$ 200 (from millet and cattle production) was calculated from the model with the no fertiliser scenario. The resulting ratios, plus the herd sizes and manure quantities per hectare, are plotted against cropped area in Figure 3. If the cropped area is 10 ha, the ratio is 5.3; if the cropped area exceeds 30 ha, the ratio is typically less than 10. The ratio is not initially constant with respect to cropped area because more cattle, and hence higher cattle offtake, are needed to meet the income target when the cropped area is very small. As the cropped area increases, then more millet production is available to meet the income target and the ratio of pasture to cropland needed to satisfy the N constraint becomes nearly constant over a wide range of cropped areas.

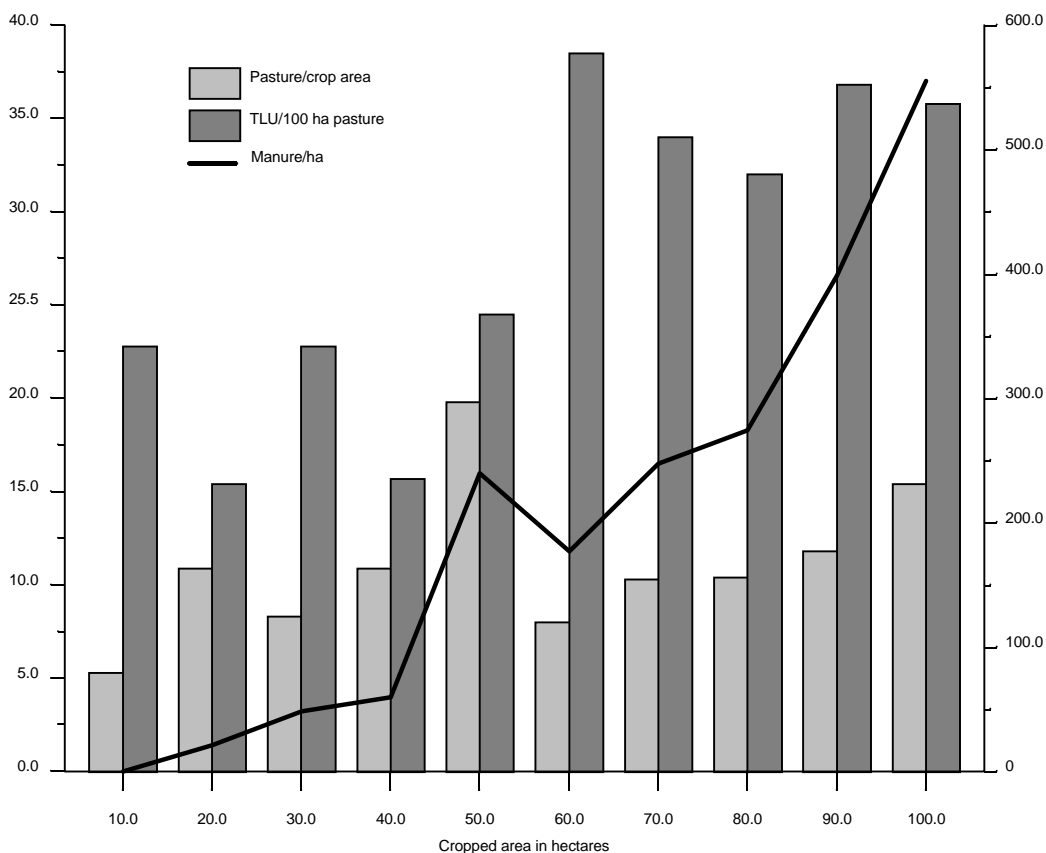
**Figure 3.** Crop–livestock relations with no fertiliser.

## Discussion

The model utilises average crop and cattle response functions to derive its solutions. However, climatic variability can be great in SAWA and affects both crop and livestock output tremendously. For example, whereas millet responds positively to fertiliser P during years of both poor and good rainfall, positive responses to fertiliser N are obtained only during years of adequate rainfall (Powell and Fussell, 1993). Millet responses to manure applications are similar. During a year of low rainfall, yields in manured fields of farmers were only 6 to 20% greater than yields in adjacent non-manured fields (Powell, unpublished data). Manuring actually decreased yields significantly in one village of the dry zone reflecting the risk of excessive manure application in low rainfall areas. During the following year when rainfall was more favorable, total millet production in manured areas were 60 to 99% greater than adjacent non-manured areas.

The millet response function for manure (equation 3) does not account for the fact that manure also appears to have positive residual effects on millet production. Whereas manure decomposes and releases nutrients slowly, mineral fertilisers are soluble and release nutrient rapidly. The efficiency of fertiliser N uptake by millet is only in the range of 20 to 37% (Christianson et al, 1990). Less manure- than fertiliser-N, however, may be transferred to millet during the first year preceding manure application. A high proportion of manure-N would probably be incorporated into soil organic matter and be available more slowly than fertiliser-N (Wolf et al, 1989). The same factors that govern plant growth control manure decomposition. The amounts of residual-N from manure available for the next millet crop would depend, therefore, on climatic conditions and millet yields the previous year.

Partial results of a long-term trial (Powell, unpublished) show that total millet yields in fields where cattle were corralled (manure plus urine application) during each of the previous three dry seasons were on average 2.2 times greater than in fields where only manure was hand-spread. The positive effects of urine on millet were also evident in the residual plots, or where animals were corralled two or three dry seasons before. Millet yield in plots where cattle had been corralled two and three years before was 1.7 and 1.6 times greater than where only manure was applied (ILCA, 1993).

The model showed a distinct tradeoff between crops and livestock when fertilisers are introduced into the production system, especially at an average price and when millet response to fertiliser is high. The combination of manure and fertiliser is, perhaps, the most efficient way to utilise these inputs. The application of both nutrient sources can enhance the synchrony of nutrient release such that it coincides more closely with crop nutrient demands (Ingram and Swift, 1989; Swift et al, 1989). Research in Niger has shown that the efficiency of fertiliser use by millet can be greatly enhanced when combined with manures (Fussell et al, 1987; Bationo and Mokwunye, 1991). The judicious use of both organic and inorganic nutrient sources is a prerequisite to achieving sustainable increases in agricultural production from mixed farming systems in SAWA.

## Conclusions

Mineral fertiliser use is an essential technology for increasing the food and feed supply from cropland and pastures, and for raising farmers' incomes. New cultivable areas are scarce so that long-term production gains must come through intensification of land already under cultivation. Although long-term profitability plays an important role in fertiliser adoption, other factors must be considered such as supply, credit and extension. In particular, policies are required that give farmers timely access to fertilisers.

The traditional management practices of farmers need to be investigated, understood and incorporated into recommendations for manure and fertiliser use. Incentives are required that discourage current practices of soil nutrient mining for short-term gain. The sustainability of nutrient cycling between crops and livestock in these production systems depend on management strategies that do not deplete the nutrient supply in pastures through excessive grazing in order to increase the nutrient supply and yields in cropland. A balance between nutrient inputs, the food and feed supply and human and livestock populations will be critical to the long-term sustainability of these production systems.

## References

- Abdullahi A and Lombin G. 1978. *Long-term fertility studies at Samaru-Nigeria: Comparative effectiveness of separate and combined applications of mineral fertilizers and farmyard manure in maintaining soil productivity under continuous cultivation in the Savanna*. Samaru Miscellaneous Publication 75. Ahmadu Bello University, Zaria, Nigeria. 54 pp.
- Bationo A and Mokwunye A U. 1991. Role of manures and crop residues in alleviating soil fertility constraints to crop production: With special reference to the Sahelian and Sudanian zones of West Africa. In: Mokwunye A U (ed), *Alleviating soil fertility constraints to increased crop production in West Africa*. Kluwer Academic Publishers, Dordrecht, The Netherlands. pp. 217–226.
- Boulier F and Jouve P. 1988. Etude comparée de l'évolution des systèmes de production sahéliens et leur coopération internationale en recherche pour le développement. Montpellier, France.
- Breman H. 1990. No sustainability without external inputs. In: *Beyond adjustment: Sub-Saharan Africa*. Africa Seminar. Maastricht, The Netherlands. pp. 124–134.
- Christianson C B, Bationo A, Henao J and Vlek P L G. 1990. Fate and efficiency of N fertilizers applied to pearl millet in Niger. *Plant and Soil* 125:221–231.
- Fussell L K, Serafini P G, Bationo A and Klaij M C. 1987. Management practices to increase yield and yield stability of pearl millet in Africa. In: ICRISAT (International Crops Research Institute for the SemiArid

- Tropics), *Proceedings of the International Pearl Millet Workshop*. ICRISAT Centre, 7–11 April 1986. ICRISAT, Patancheru, India. pp. 255–267.
- ILCA (International Livestock Centre for Africa). 1993. *ILCA 1992: Annual Report and Programme Highlights*. ILCA, Addis Ababa, Ethiopia.
- Ingram J A and Swift M J. 1989. Sustainability of cereal–legume intercroppings in relation to management of organic matter and nutrient cycling. *Farming Systems Bulletin for East and Southern Africa* 4:7–21. CIMMYT (International Maize and Wheat Improvement Center), Harare, Zimbabwe.
- Kowal J M and Kassam A H. 1978. *Agricultural ecology of savanna: A study of West Africa*. Clarendon Press, Oxford, UK.
- McCown R L, Haaland G and de Haan C. 1979. The interaction between cultivation and livestock production in semi-arid Africa. In: Hall A E, Cannell G W and Lawton H W (eds), *Agriculture in semi-arid environments*. Springer-Verlag, Berlin, Germany. pp. 297–332.
- McIntire J and Fussell L K. 1989. On-farm trials with millet in Niger: Crop establishment, yield loss factors, and economic analysis. *Experimental Agriculture* 25(2):217–233.
- McIntire J, Bourzat D and Pingali P. 1992. *Crop–livestock interaction in sub-Saharan Africa*. World Bank, Washington, DC, USA.
- Pieri C. 1989. Fertilité des terres de savanes: bilan de trente ans de recherche et de développement agricole au sud du Sahara. Ministère de la coopération et du développement et Centre de coopération internationale en recherche agronomique pour le développement, Montpellier, France.
- Powell J M. 1986. Manure for cropping: A case study from central Nigeria. *Experimental Agriculture* 22:15–24.
- Powell J M and Fussell L K. 1993. Nutrient and carbohydrate partitioning in millet. *Agronomy Journal* 85:862–866.
- Powell J M and Williams T O. 1993. *Livestock, nutrient cycling, and sustainable agriculture in the West African Sahel*. Gatekeeper Series SA37. IIED (International Institute for Environment and Development), London, UK. 15 pp.
- Stoorvogel J J and Smaling E M A. 1990. *Assessment of soil nutrient depletion in Sub-Saharan Africa: 1983–2000*. The Winand Staring Centre, Wageningen, The Netherlands.
- Swift M J, Frost P G H, Campbell B M, Hatton J C and Wilson K. 1989. Nutrient cycling in farming systems derived from savanna: Perspectives and challenges. In: Clarholm M and Berstrom D (eds), *Ecology of arid lands*. Kluwer Academic Publishers, Dordrecht, The Netherlands. pp. 6376.
- Van Keulen H and Breman H. 1990. Agricultural development in the West African Sahelian region: A cure against hunger? *Agriculture Ecosystems & Environment* 32:177–197.
- Van Raay H G T. 1975. *Rural planning in a savannah region*. University Press, Rotterdam, The Netherlands.
- Wolf J, De Witt C T and Van Kuelen H. 1989. Modelling long-term crop response to fertilizer and soil nitrogen. I. Model description and application. *Plant and Soil* 120:11–22.
- World Bank. 1992a. *World development report*. World Bank, Washington, DC, USA.
- World Bank. 1992b. *Market outlook for major primary commodities*. Report 814/92. World Bank, Washington, DC, USA.

## Appendix

### Derivation of model coefficients

#### Cattle production

Daily feed intake = 250 kg/TLU  
\* 0.025 (% of LW ingested as digestible dry matter each day)  
\* 365  
= 6.25 kg.

#### Manure production and capture

Daily manure production = Daily feed intake in kg  
\* 0.5 (share of daily feed intake passed through animal)  
\* 0.5 (share of available in total manure)  
\* 240/365 (days in year that animals are corralled on cropland)  
= 1.027 kg.

#### Natural pasture production

Consumable pasture yield =  
400 mm annual rainfall  
\* 9 kg dry matter/mm rainfall  
\* 0.45 (average pasture digestibility)  
\* 0.5 (share of available pasture in total digestible pasture)  
= 810 kg/year.

#### Stover production

Stover yield =  
250 kg/ha millet grain yield  
\* 3 (stover/grain ratio)  
\* {[ 0.75 (share of millet leaf that is consumable)  
\* 0.40 (share of leaf in stover yield)]  
+ [0.2 (share of millet stalk that is consumable)  
\* 0.6 (share of stalk in stover yield)]}  
= 315 kg/ha

#### Millet grain price

Millet grain price =  
US\$ 100/t (world maize price)  
US\$ 75/t (transport costs to Niger) assuming that Niger remains an importer  
= US\$ 175/t



## **Livestock price**

LW price =

US\$ 2613 = world beef price

\* 0.5 (conversion of beef price to liveweight price)

\* 0.75 (conversion of world cif price to fob price, Niger) assuming  
that Niger remains an exporter of livestock

= US\$ 980/t.

# List of Participants

**A.A. Agboola**

Department of Agronomy  
University of Ibadan  
Ibadan  
NIGERIA

**M. Bengaly**

Institute d'Economie rurale  
DRSPR  
BP 186  
Sikasso  
MALI

**R. Bosma**

DRSPR/IRRT  
BP 186  
Sikasso  
MALI

**D. Bredewold**

Larenstein International Agricultural College  
P O Box 7  
7400 AA Deventer  
THE NETHERLANDS

**H. Breman**

AB-DLO  
BP 14  
6700 AA Wageningen  
THE NETHERLANDS

**J. Brouwer**

ICRISAT Sahelian Center  
BP 12404  
Niamey  
NIGER

**A. Buerkert**

Institute of Plant Nutrition  
University of Hohenheim  
D-70593 Stuttgart  
GERMANY

**L.W. Burgos**

Land and Water Development Division  
FAO  
Via delle Terme di Caracalla 00100  
Rome  
ITALY

**C.E. Castilla**

ICRAF/CPAF-RO  
Caixa Postal 406  
CEP 78900-000  
Porto Velho, Rondonia  
BRAZIL

**L. Diarra**

Institut d'Economie Rural  
BP 262  
Bamako  
MALI

**S. Ehui**

ILCA  
P O Box 5689  
Addis Ababa  
ETHIOPIA

**S. Fernández-Rivera**

ILCA  
ICRISAT Sahelian Center  
BP 12404  
Niamey  
NIGER

**H.A. Fitzhugh**

ILCA  
P O Box 5689  
Addis Ababa  
ETHIOPIA

**S. Gavian**

ILCA  
P O Box 5689  
Addis Ababa  
ETHIOPIA

**A.V. Goodchild**

ICARDA  
P O Box 5466  
Aleppo  
SYRIA

**J.J.R. Groot**

Project PSS  
BP 2220  
Bamako  
MALI

**F.M.A. Harris**

Department of Geography  
Bayero University  
PMB 3011  
Kano  
NIGERIA

**P. Hiernaux**

ILCA  
ICRISAT Sahelian Center  
BP 2220  
Niamey  
NIGER

**R. Van der Hoek**

Adaptive Research Planning Team—  
Western Province  
P O Box 910064  
Mongu  
ZAMBIA

**G.A. Kaasschieter**

Projet PSS  
BP 2220  
Bamako  
MALI

**C.T. Kadzere**

Department of Livestock and Pasture Science  
University of Fort Hare  
P B X1314, Alice 5700  
SOUTH AFRICA

**A. Karlsson**

SIDA/Project SCAFE  
Department of Agriculture  
P O Box 510091  
Chipata  
ZAMBIA

**A. de Kartzow**

Regional Soil Conservation Unit/SIDA  
P O Box 30600  
Nairobi  
KENYA

**R.O. Kileo**

Farming Systems Research Programme  
Lake Zone Research Institute  
P O Box 1433  
Mpwapwa  
TANZANIA

**U.P. Kreuter**

Ranching Systems Group  
Department of Rangeland Ecology and  
Management  
Texas A & M University  
College Station, TX 77845  
USA

**A. Larbi**

PMB 5320  
Ibadan  
NIGERIA

**P.N. de Leeuw**

ILCA  
P O Box 46847  
Nairobi  
KENYA

**N.Z. Lupwayi**

ILCA  
P O Box 5689  
Addis Ababa  
ETHIOPIA

**F. Mahler**

ICRISAT Sahelian Center  
BP 12404  
Niamey  
NIGER

**M.A. Mohamed-Saleem**

ILCA  
P O Box 5689  
Addis Ababa  
ETHIOPIA

**H.K. Murwira**

Department of Research and Specialist  
Services  
Chemistry and Soil Research Institute  
P O Box 8100  
Causeway, Harare  
ZIMBABWE

**G.S. Nambayo**

Adaptive Research Planning Team—  
Western Province  
P O Box 910064  
Mongu  
ZAMBIA

**G. Pangare**

Institute of Rural Management  
P O Box 60  
Anand 399 001  
Gujarat  
INDIA

**J.M. Powell**

458 Glenway Street  
Madison WI 53711  
USA

**J.K. Ransom**

CIMMYT  
P O Box 25171  
Nairobi  
KENYA

**J.D. Reed**

Department of Meat and Animal Science  
1675 Observatory Drive  
Room 256  
University of Wisconsin  
Madison, WI 53706  
USA

**C. Renard**

ICRISAT Sahelian Center  
BP 12404  
Niamey  
NIGER

**R. Roeleveld**

Lake Zone Farming Systems Research Project  
P O Box 2807  
Mwanza  
TANZANIA

**J. Ryan**

ICARDA  
P O Box 5466  
Aleppo  
SYRIA

**K.L. Sahrawat**

WARDA/ADRAO  
01 BP 2551  
Bouaké  
COTE D'IVOIRE

**E. Schlecht**

Institute for Animal Production in the Tropics  
and Subtropics  
University of Hohenheim  
70593 Stuttgart  
GERMANY

**I. Scoones**

IIED  
3 Endsleigh Street  
London, WC1H ODD  
UK

**K.D. Shepherd**

ICRAF  
P O Box 30677  
Nairobi  
KENYA

**K. Sissoko**

Institut d'Economie Rurale  
Projet Production  
Soudano-Sahelienne/PSS  
BP 2220  
Bamako  
MALI

**Z.C. Somda**

ILCA  
ICRISAT Sahelian Center  
BP 12404  
Niamey  
NIGER

**P.J. Stangel**

Stangel and Associates Agricultural  
Consultants  
Rural Route 7, Box 380  
Florence, AL 35630  
USA

**M.J. Swift**

TSBF  
c/o UNESCO-ROSTA  
P O Box 30592  
Gigiri  
Nairobi  
KENYA

**J.C. Tanner**

Cwm Mawr  
Hyssington  
Montgomery  
Powys SY15 6DZ  
UK

**G. Tarawali**

ILCA  
PMB 2248  
Kaduna  
NIGERIA

**Tekie Gebregziabher**

SIDA/HADO Projet  
P O Box 144  
Kandoa  
TANZANIA

**R.J. Thomas**

CIAT  
Apartado Aereo 6713  
Cali  
COLOMBIA

**P.J. Thorne**

NRI  
Central Avenue, Chatham  
Maritime

Kent ME4 4TB  
UK

**M. Turner**

ILCA  
ICRISAT Sahelian Center  
BP 12404  
Niamey  
NIGER

**V.N. Umunna**

ILCA  
P O Box 5689  
Addis Ababa  
ETHIOPIA

**E.B. Wella**

Lake Zone Farming Systems Research Project  
P O Box 1433  
Mwanza  
TANZANIA

**T.O. Williams**

ILCA  
ICRISAT Sahelian Center  
BP 12404  
Niamey  
NIGER