

Accurate measurements of CO₂ mole fraction in the atmospheric surface layer by an affordable instrumentation

Petri Keronen¹⁾, Anni Reissell¹⁾⁸⁾, Frédéric Chevallier⁴⁾, Erkki Siivola¹⁾,
Toivo Pohja²⁾, Veijo Hiltunen²⁾, Juha Hatakka³⁾, Tuula Aalto³⁾,
Leonard Rivier⁴⁾, Philippe Ciais⁴⁾, Armin Jordan⁵⁾, Pertti Hari⁷⁾, Yrjö Viisanen³⁾
and Timo Vesala¹⁾

¹⁾ Department of Physics, P.O. Box 64, FI-00014 University of Helsinki, Finland

²⁾ Hyytiälä Forestry Field Station, Hyytiäläntie 124, FI-35500 Korkeakoski, Finland

³⁾ Finnish Meteorological Institute, P.O. Box 503, FI-00101 Helsinki, Finland

⁴⁾ Laboratoire des Sciences du Climat et de l'Environnement, CEA-CNRS-UVSQ, Orme des Merisiers
Bât. 701, FR-91191 Gif-sur-Yvette Cedex, France

⁵⁾ Max-Planck-Institute for Biogeochemistry, P.O. Box 100164, D-07701 Jena, Germany

⁷⁾ Department of Forest Sciences, P.O. Box 27, FI-00014 University of Helsinki, Finland

⁸⁾ International Institute for Applied Systems Analysis (IIASA), Schlossplatz 1, AT-2361 Laxenburg, Austria

Received 11 Nov. 2013, final version received 6 Apr. 2014, accepted 7 May 2014

Keronen, P., Reissell, A., Chevallier, F., Siivola, E., Pohja, T., Hiltunen, V., Hatakka, J., Aalto, T., Rivier, L., Ciais, P., Jordan, A., Hari, P., Viisanen, Y. & Vesala, T. 2014: Accurate measurements of CO₂ mole fraction in the atmospheric surface layer by an affordable instrumentation. *Boreal Env. Res.* 19 (suppl. B): 35–54.

We aimed to assess the feasibility of an affordable instrumentation, based on a non-dispersive infrared analyser, to obtain atmospheric CO₂ mole fraction data for background CO₂ measurements from a flux tower site in southern Finland. The measurement period was November 2006–December 2011. We describe the instrumentation, calibration, measurements and data processing and a comparison between two analysers, inter-comparisons with a flask sampling system and with reference gas cylinders and a comparison with an independent inversion model. The obtained accuracy was better than 0.5 ppm. The inter-comparisons showed discrepancies ranging from –0.3 ppm to 0.06 ppm between the measured and reference data. The comparison between the analyzers showed a 0.1 ± 0.4 ppm difference. The trend and phase of the measured and simulated data agreed generally well and the bias of the simulation was 0.2 ± 3.3 ppm. The study highlighted the importance of quantifying all sources of measurement uncertainty.

Introduction

While carbon dioxide (CO₂) mole fractions have been increasing in the atmosphere since the 19th century, terrestrial ecosystems have been storing carbon at the global scale (Le Quere *et al.* 2013). The processes driving this uptake are still

not well known (e.g. Gurney and Eckels 2011, Francey *et al.* 2013), but the mid-latitudes of the northern hemisphere are likely an important CO₂ uptake region (e.g. Tans *et al.* 1990, Ciais *et al.* 2010).

At the local scale (~1–10 km² area), the CO₂ exchange between the surface and the atmos-

phere can be routinely assessed using eddy covariance measurements (e.g. Baldocchi 2003). At regional ($\sim 10^4$ – 10^6 km² area) to global scales, the exchange can be estimated via atmospheric inverse modelling, biogeochemical process models, remote sensing based ecosystem models such as the fusion of eddy-covariance data with remote sensing or inventory observations (e.g. Tans *et al.* 1990, Potter *et al.* 1993, Running *et al.* 1999, Pacala *et al.* 2001, Gurney *et al.* 2002, Lauvaux *et al.* 2009, Jung *et al.* 2011, Meesters *et al.* 2012). In the case of regional-scale atmospheric inversions and close to local sources or sinks, dense networks of accurate continuous measurements of atmospheric CO₂ are needed (Broquet *et al.* 2013). Indeed, over vegetated regions, the biotic CO₂ fluxes are spatially heterogeneous and temporally very variable. Over densely-populated areas, anthropogenic CO₂ emissions are further super-imposed on the biotic fluxes and contribute to CO₂ mole fraction variability (Peylin *et al.* 2011). The interpretation of the atmospheric signals is complicated by the variability in atmospheric transport, in particular the diurnal boundary layer dynamics. Previous studies show that land flux estimates can be constrained by atmospheric CO₂ measurements if: (1) the network of stations is spatially dense, with observing sites ideally spaced within 200–300 km of each other (Lauvaux *et al.* 2008, Carouge *et al.* 2010, Broquet *et al.* 2013), (2) the measurements are taken on a continuous basis (Gerbig *et al.* 2008), (3) the measurement short-term precision is high enough as compared with the (synoptic, diurnal) CO₂ mole fraction variability, and (4) the measurement accuracy is good enough over time scales ranging from hour to decades so that data from different sites can be combined into the same inversion, and drifts in calibration or instruments do not alter the inversion results (Masarie *et al.* 2011).

Especially over the continents, the current accuracy of regional-scale estimates based on the integration of data and inverse modelling are unfortunately limited by too sparse atmospheric CO₂ mole fraction observation network (Karstens *et al.* 2006, Xiao *et al.* 2008). So there is a need for continuous, accurate and consistent data of boundary layer CO₂ mole fraction to be used in the models estimating global and

regional carbon sinks. As measurements of the boundary layer CO₂ mole fraction would be too difficult and troublesome in practice to be performed, it can instead be estimated by performing the measurements at a fixed height in the surface layer using towers of moderate height (30–115 m) presuming that the data is selected properly (Bakwin *et al.* 2004, Karstens *et al.* 2006). By utilising e.g. CO₂ mole fraction profile measurements the situations where the atmosphere is well mixed can be chosen.

The various flux tower networks that measure exchanges of carbon dioxide, water vapour, and energy between terrestrial ecosystems and the atmosphere with their eddy covariance tower sites are potential candidates to provide the needed CO₂ mole fractions for regional atmospheric inversions (Bakwin *et al.* 2004). To achieve consistent results, the measurements should be performed following internationally accepted standards and the calibrations should be traceable to the globally accepted World Meteorological Organisation (WMO) CO₂ mole fraction scale (Bakwin *et al.* 2004). To improve the accuracy of the inverse models at regional scale, networks of stations should be established where the distances between the stations would not exceed a few hundred kilometres (Karstens *et al.* 2006).

Uncalibrated measurements of CO₂ mole fractions at the flux tower sites are routinely performed using commercial non-dispersive infrared (NDIR) absorption gas analyzers. Calibration and accuracy can be achieved by the use of calibration standards (Zhao *et al.* 1997, Haszpra *et al.* 2001, Hatakka *et al.* 2003). The required compatibility of the measured CO₂ mole fraction is 0.1 ppm at the Global Atmospheric Watch (GAW) stations in the northern hemisphere (http://www.wmo.int/pages/prog/arep/gaw/documents/Final_GAW_206_web.pdf). In many locations, the accuracy of transport model simulations is not better than a few ppm. They would benefit from the assimilation of observational data with an accuracy of a few tenths of ppm, e.g. 0.5 ppm. Indeed, the impact of measurement biases on atmospheric inverse modelling depends on their magnitude relative to the model-minus-measurement departures (Chevallier *et al.* 2005).

In this study, we aimed to assess the technical feasibility of an affordable instrumentation on top of flux towers or of any tower of moderate height whose top lies well above the canopy to obtain accurate and continuous atmospheric CO₂ mole fraction data to be used in an inversion modelling of regional CO₂ exchange. The site in the study was the comprehensive Hyytiälä SMEAR II (Station for Measuring Ecosystem–Atmosphere Relations) station in southern Finland. The period covered in this study was November 2006–December 2011.

Material and methods

Measurement site

The measurement site was the SMEAR II station (Station for Measuring Forest Ecosystem–Atmosphere Relations) located in Hyytiälä, southern Finland, 220 km to the north-west from Helsinki (61°50′50.69″N, 24°17′41.17″E, 198 m a.m.s.l. in the WGS84 reference frame) (Fig. 1).

The 73-m-high micrometeorological measurement tower is located within extended forested areas. Around the tower there is a 44-year-old (in 2006) Scots pine (*Pinus sylvestris*) stand, which is homogeneous for about 200 m in all directions, and extending to the north for about 1 km. At longer distances, other stand types, different in age and/or composition, are also present. The dominant height of the stand near the tower is about 14 m and the total (all-sided) needle area is about 6 m² m⁻². Towards the south-west at a distance of about 700 m there is an about 200 m wide, oblong lake (Kuivajärvi), situated at 150 m a.s.l. and perpendicular to the south-west direction.

The station is situated in a relatively remote area. There are two anthropogenic sources of CO₂ nearby, namely the heating plant of the Hyytiälä Forestry Field Station (0.7 km in direction 245°) and a saw mill and a local power plant in the village of Korkeakoski (7 km in direction 145°). In addition to heating and power plants emitting CO₂, there are also paper mills, steelworks and limestone factories within about 200 km radius from the station. Compared with

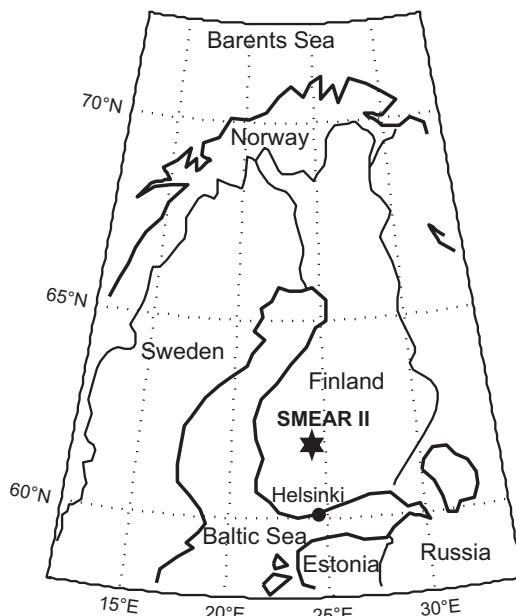

Fig. 1. Map of the region. Location of the tower is indicated by an asterisk. Coast and shore lines are indicated with thick lines.

other directions, sectors 270°–40° and 60°–140° are relatively free from major CO₂ sources to distance up to 300 km.

More information about the station is given in e.g. Hari and Kulmala (2005) and Vesala *et al.* (2005).

Instrumentation

Ambient air sampling

At the SMEAR II station, the ambient mole fraction of CO₂, along with other trace gases, are measured from the measurement tower alternately from six heights (67.2, 50.4, 33.6, 16.8, 8.4 and 4.2 m above ground) (Rannik *et al.* 2004). The sample line system and instrumentation at the SMEAR II station is designed for measuring accurately the concentration profiles. In this study, we utilised the measurements from 67.2 and 33.6 m. We used the gradient between the 67.2- and 33.6-m levels as a measure to indicate well-mixed conditions. The data from the 67.2-m level, reaching to 265 m a.m.s.l., were used as an estimate of planetary boundary layer

(PBL) CO₂ mole fraction during well-mixed conditions.

Each of the six sample lines was 100 m long, 16 mm/14 mm in diameter PTFE tube (Bohlender GmbH, Grünsfeld, Germany). The flow rate in each of these lines was 45 l min⁻¹ and the estimated lag time 20 s. The length of the lines in the measurement cabin was about 0.5 m, and the sample was taken as a side flow from each main flow by means of PTFE manifolds (T. Pohja, Juupajoki, Finland). The sample lines between the manifolds and the analyzers were 1/8" (3.18 mm/2.1 mm) in diameter sleek metal tubes (Supelco™ 20526U, electro-polished grade AISI304 SS, Sigma-Aldrich, St. Louis, MO, USA). For a diagram of the instrumentation, see Fig. 2.

PTFE (fluoropolymer) is generally recognised to be susceptible to permeation of CO₂ through the tube wall. Instead of measuring the exchange of CO₂ through the tube walls, we calculated an order-of-magnitude estimate. We based this estimate on Darcy's law, giving a relationship between a volumetric flow rate and partial pressure difference of a compound through a porous medium.

Gas analyzers

We utilised URAS 4 analyzers for CO₂ and water vapour (H₂O) (Hartmann & Braun, Frankfurt am Main, Germany), already in use for the profile measurements, between October 2006 and February 2008. The relatively large size, weight and power consumption of the URAS 4 analyzers led to the change to a more compact-sized analyzer. We left, however, the URAS 4 CO₂ analyzer in the system as a backup instrument. In May 2010, the URAS 4 CO₂ analyser started to malfunction severely, so we removed it from the system on 29 May 2010.

In March 2008, we added a LI-840 CO₂/H₂O analyzer (Li-Cor Inc., Lincoln, NE, USA) to the measurement system. Although the URAS 4 and the LI-840 analyzers utilise a common method, namely NDIR, for measuring the mole fractions, the different type of detectors made it possible to compare the performance of the two CO₂ analyzers during 26 months. In September 2011, we

replaced the LI-840 analyzer with a LI-820 CO₂ analyzer (Li-Cor Inc., Lincoln, NE, USA). The LI-840 and LI-820 are basically similar instruments with the same type of (CO₂) detector. The SMEAR II instrumentation will hereafter be referred to as SMEAR II CO₂.

Operational procedures

Correction for the H₂O interference, variation of pressure and temperature, and conditioning of ambient air sample

H₂O vapour is the major interfering component when atmospheric gas concentrations are measured with the NDIR method. The atmospheric mole fraction of H₂O vapour is high compared with that of other components and this mole fraction is highly variable. H₂O vapour has multiple strong absorption peaks that overlap with those of other components, and the broad tails of these peaks cause background in the measurement signal (Heard 2006). At SMEAR II, the potential mole fraction range of H₂O vapour is from about 400 ppm at -30 °C to about 30 000 ppm at 25 °C ambient temperature. In addition to the interference effects also the effect of H₂O vapour on the partial pressure of CO₂ is significant and must be taken into account to obtain accurate results.

The design of all three analyzers is aimed to minimise the interference caused by H₂O vapour in the sample air. The use of CO₂-filled detectors in URAS 4 CO₂ analyzers and the use of an optical band filter in LI-840 analyzers reduce the effect of H₂O vapour on the CO₂ absorption signal. LI-840 analyzers also have a correction algorithm for the direct cross sensitivity by H₂O on the CO₂ absorption signal. The sensitivity of a URAS 4 CO₂ analyzer to H₂O vapour is not given in the instrument specifications. We performed separate measurements to examine the interference of H₂O vapour on the CO₂ mole fraction signal of the URAS 4 analyzer (data not shown). The results showed an interference effect in the CO₂ signal equal to 3 ppm CO₂ per 1 mmol mol⁻¹ of H₂O vapour. According to the specifications of an LI-840 analyzer, the CO₂ signal has sensitivity of less than 0.1 ppm CO₂ per 1 mmol mol⁻¹ of H₂O vapour. With separate

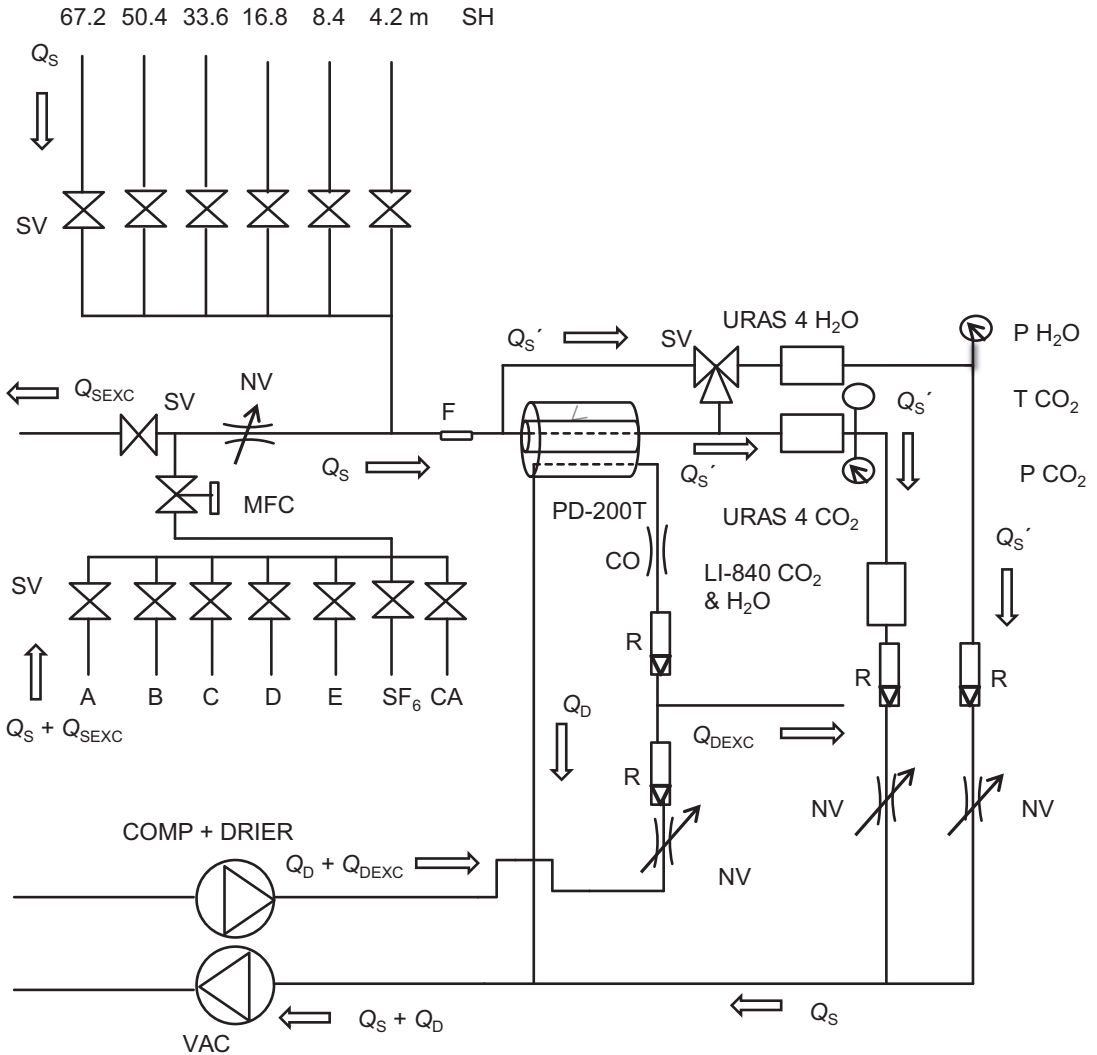

Fig. 2. The instrumentation for the measurement of the ambient CO₂ mole fraction. In the top there are the branch lines connected to the main sample lines (not drawn) from the tower. Sampling height (SH) is selected with solenoid valves (SV), and sample air flow (Q_s) is directed through a drier (PD-200T) to the gas analyzers (URAS 4 H₂O, URAS 4 CO₂ and LI-840 CO₂ & H₂O). F is a particulate filter. P H₂O and P CO₂ are pressure transducers of URAS 4 H₂O and URAS CO₂ analyzers, respectively. T CO₂ is a temperature sensor of the URAS 4 CO₂ analyzer. Rotameters (R) show the sample air and drier purge air (Q_D) flow rates. The sample air flow rates are set with needle valves (NV) and the purge air flow rate is set with a critical orifice (CO). The cylinders (not drawn) of the CO₂ calibration gas standards (A, B, C, D and E), H₂O calibration gas standard (SF₆) and compressed natural air (CA) are installed in the basement of the station. The central vacuum pump (VAC) and compressed air system (COMP + DRIER) of the station are also installed in the basement. The flow rates from the gas cylinders are set by a mass flow controller (MFC). The excess flow (Q_{sEXC}) from the gas cylinders is diverted out of the system. Likewise the excess flow of the compressed air (Q_{DEXC}) is diverted out of the system.

measurements, we could confirm the specification of the interference to be correct.

We considered that an accurate and reliable H₂O interference correction equation for the URAS 4 CO₂ analyzer was not reasonable to

be formulated and decided to reduce the amount of interference in the first place by installing a sample air dryer in the system (Nafion® membrane, 12'' PD™-200T-KA, Perma Pure LLC, Toms River, NJ, USA).

The temperature and pressure affect directly the gas concentration inside the measurement chamber of an analyzer, and the differences in these factors between the calibration and measurement situations had to be taken into account. In addition to the direct effect, the pressure also affects the shape of the absorption lines, so that they become broader and thus the total absorption per mole of an absorber increases with an increasing pressure (Burch *et al.* 1962). The variation of the line widths with the temperature is not significant at the temperature range occurring in the atmosphere (Jamieson *et al.* 1963), so the effect of the temperature on the line shape can be neglected. Moreover, gases have different abilities in causing the pressure broadening, so the composition of the sample has to be taken into account.

The URAS 4 analyzers were not equipped with pressure correction modules, so we installed separate pressure sensors (Barocap® PTB100A, Vaisala Oyj, Helsinki, Finland) at the outlets of the measurement cells to allow for the pressure correction of the signals. The temperatures of the detector subassemblies in the URAS 4 analyzers are kept at 60 °C, and as a consequence the measurement cells are also maintained at a warmer than ambient temperature, but the signals were not corrected for temperature dependence by the software of the instruments. We installed a thermistor (type PT100, accuracy ± 0.1 °C) at the outlet of the URAS 4 CO₂ analyzer measurement cell to facilitate a temperature correction. The LI-840 (and LI-820) analyzer is equipped with a pressure sensor to measure the pressure of the sample gas inside the sample cell and the effect of the sample pressure on the signal is taken into account by the instrument's software. The housings of the radiation source and the detector in an LI-840 analyzer are thermostatically heated and regulated at a constant operating temperature of 50 °C. The source and detector housings are equipped with temperature sensors and the instrument's software performs a temperature correction as a part of the signal processing.

We minimized the degree of the pressure correction by setting the pressure decrease of the sample gas during a calibration to approximately equal to the pressure decrease in the ambient air sample lines. We accomplished this by install-

ing a pressure-decreasing needle valve in the calibration gas feed line. We also performed all calibration adjustments (both hardware and software) at the same consistent pressure. The temperature equilibration features of the analyzers minimized the degree of temperature correction needed. We took the remaining effect of the pressure into account by developing semi-empirical correction algorithms. We corrected the effects of minor temperature differences by applying the ideal gas law. To minimize the effect of the gas composition, we used calibration gases prepared on synthetic air with added argon close to the atmospheric composition. We made the correction calculations for the effects of the pressure and temperature on the signals during the processing of the measured data.

Calibration gases and calibration gas sample conditioning

We installed five 40-l calibration gas cylinders filled to a pressure of 160 bar (referred to as A, B, C, D and E cylinders) into the system. The CO₂ mole fractions covered a range from 350 to 430 ppm (Table 1). The compositions (CO₂, O₂, N₂ and Ar) were analysed by the manufacturer with an accuracy of 1% (Deuste Steininger GmbH, Mühlhausen, Germany). All in all, we had two sets of calibration gas cylinders in use during the study. We checked the calibration gas lines from the pressure regulator-gas cylinder connection all the way to the inlets of the solenoid valves (Fig. 2) for leaks with helium. Every time when we changed the calibration gas cylinders and pressure regulators, we checked the gas line, regulator and cylinder connections for leaks by liquid leak detector and by leaving the lines pressurized with the cylinder valves closed. We also performed quick and easy checks for any leaks in the sample lines and at the various connections in them indoors in the measurement cabin by feeding zero gas to the instrumentation and looking for higher than offset CO₂ signals caused by exhalation.

The more accurate CO₂ mole fractions of the calibration gases than specified by the manufacturer were determined by the Finnish Meteorological Institute (FMI) at their Pallas-Sodankylä GAW station against the WMO X2007 CO₂ mole

fraction scale (Zhao and Tans 2006, http://www.esrl.noaa.gov/gmd/ccl/co2_scale.html). The initial calibration of the first set of the calibration gases was performed in July 2006 shortly before the measurements started. In September 2009, the second set of calibration gases was taken into use. An intermediate check of the first set of gases was performed in April 2008. The differences between the results of the initial and intermediate determination ranged from -0.03 to 0.07 ppm. The final check of the first set was performed in April 2010 and the differences to the initial determination ranged from 0.08 to 0.12 ppm. The final check of the second set was performed in January 2013. The differences to the initial determination of the second set ranged from 0.08 to -0.20 ppm. The measurements in January 2013 were performed with a different reference analyzer than the one that was used in the previous checks. See Table 1 for the details of the calibration gas CO₂ mole fractions.

We also connected a cylinder of compressed, dry natural air (filler Messer Suomi Oy, Tuusula, Finland until November 2008 and AGA Oy, Espoo, Finland henceforth) to the system. We used it for flushing the sample lines and measurement chambers of the analyzers prior to feeding the calibration gases. In addition, we used it to verify the stability of the instrumental response during each calibration and it also served as a (short term) surveillance gas between day and nighttime calibrations (repeatability).

For the calibration of the URAS 4 H₂O analyzer we used a cylinder of sulphur hexafluoride (6% SF₆ in N₂, Air Liquide Deutschland GmbH, Krefeld, Germany).

In the case of the calibration gases, as well as the bottled natural air, the sample air dryer functioned as a humidifier instead of drying the sample.

Measurements of ambient air and calibration gases

The calibration of the analyzers and the dedicated measurement of the atmospheric CO₂ mole fraction was performed twice a day, first between 01:00 and 01:30 and then between 13:00 and 13:30 of local winter time (UTC + 2 h). Between these two measurements, the instrumentation was used for the CO₂ and H₂O concentration profile measurements with a different measurement program and signal recorder.

The afternoon measurement sequence consisted of the measurement of (in the given order) ambient sample air, flushing the lines and the analyzers dry with the bottled natural air (CA), measurement of the bottled natural air, measurement of the five calibration gases (E, C, A, B, D), measurement of the bottled natural air for the second time and finally measurement of ambient sample at the end of the sequence. The 3-way solenoid valve (see Fig. 2) was activated to split

Table 1. CO₂ mole fractions (ppm) in the calibration gas cylinders as determined (14 measurements per cylinder) by the Finnish Meteorological Institute against calibration standards acquired from World Meteorological Organization/Central Calibration Laboratory (WMO/CCL). The mole fractions are given on WMO X2007 CO₂ scale. The precisions are given as standard deviations. Accuracy is 0.05 ppm.

Analysis date	First set of cylinders				
	cylinder A	cylinder B	cylinder C	cylinder D	cylinder E
6 Jul 2006	350.82 ± 0.02	370.27 ± 0.02	390.48 ± 0.03	410.87 ± 0.03	430.40 ± 0.02
26 Apr 2008	350.87 ± 0.01	370.31 ± 0.01	390.55 ± 0.02	410.80 ± 0.02	430.37 ± 0.02
9 Apr 2010	350.94 ± 0.02	370.35 ± 0.02	390.59 ± 0.02	410.96 ± 0.02	430.48 ± 0.02
	Second set of cylinders				
	cylinder A	cylinder B	cylinder C	cylinder D	cylinder E
30 Aug 2009	350.78 ± 0.03	370.96 ± 0.02	390.09 ± 0.03	410.70 ± 0.03	430.55 ± 0.03
30 Jan 2013	350.84 ± 0.01	371.07 ± 0.01	390.00 ± 0.01	410.88 ± 0.01	430.67 ± 0.01

the sample flow in half after the dryer so that the H₂O mole fraction was measured simultaneously from the same dried sample air.

The nighttime measurement sequence consisted of measuring (in the given order) ambient sample air, flushing the lines and the analyzers with the bottled natural air, measurement of the bottled natural air, measurement of the five calibration gases (D, C, B, A, E), measurement of SF₆ calibration gas, and flushing SF₆ from the system with the bottled natural air. During the nighttime calibration sequence, the calibration gas and bottled natural air samples by-passed the permeation dryer. The last CO₂ calibration gas during the nighttime sequence also served as a zero calibration gas for the H₂O analyzer. The nighttime measurement was designed for H₂O-analyzer calibration, but combined with the afternoon measurement it also provided data to study the possible effect of the dryer and of the calibration gas feeding order on the CO₂ calibration.

During this study, we performed test runs of the times that would be needed for the calibration gas signals to stabilize. We also tested the effect of different feeding orders of the calibration gases on the calibration results.

Inter-comparison experiments

Inter-comparison experiment I: flask samples

In August 2007, we performed a comparison experiment during which we measured ambient CO₂ mole fraction simultaneously while collecting four-flask samples. Each collection period was about 3-min long. The sample line of the flasks was connected directly to the PTFE manifold of the main sample line from the 67.2 m sampling height (SH in Fig. 2) in front of the solenoid valve (SV in Fig. 2). The flask sampling instrumentation and the post-collection gas chromatographic analysis of the flask samples were provided by BGC-GasLab of Max-Planck-Institute for Biogeochemistry, Jena, Germany. The CO₂ calibration scale of BGC-GasLab for measurements of ambient samples is directly linked to the WMO X2007 CO₂ mole fraction scale. The analyses were performed about one week after

the collection. The flask sampling instrumentation will be hereafter referred to as MPI CO₂.

Inter-comparison experiments II: gas cylinders with unknown CO₂ mole fractions

In July 2008 and April 2009, we performed comparison experiments during which we analysed gas cylinders filled with natural air containing different CO₂ mole fractions with the SMEAR II instrumentation. The CO₂ mole fractions in the cylinders were not provided. In the first inter-comparison experiment, there were three gas cylinders and we analysed each cylinder twice. We used the averages of the mole fractions obtained in the two measurements as the results for the CO₂ mole fractions of the cylinders. In the second inter-comparison, there were two gas cylinders. We analysed one of the cylinders six times and the other five times, and we used the averages of the mole fractions obtained in the measurements as the results for the CO₂ mole fractions of the cylinders.

In the first experiment, the cylinders belonged to the CarboEurope-Atmosphere Cucumber Inter-comparison programme (*see* <http://cucumbers.uea.ac.uk/>), and in the second experiment they belonged to the Flux Tower Inter-comparison programme of the CarboEurope Integrated Project (*see* <http://www.carboeurope.org/>). The measurements of the CarboEurope-Atmosphere Cucumber Inter-comparison programme cylinders remained at the SMEAR II site also after the second experiment. During the period of this study the cylinders were thus analysed also in May 2010, January 2011 and December 2011.

Ancillary measurements

We utilised the data from the meteorological measurements of air temperature, humidity, wind speed and direction routinely performed at the SMEAR II station.

Simulation of atmospheric CO₂ mole fractions

We compared the measured CO₂ mole fraction

data with a global simulation of CO₂ atmospheric transport as averages between 11:00 and 11:30 UTC for a period of October 2006–December 2011. This global simulation corresponded to version 11.2 of the CO₂ inversion product from the Monitoring Atmospheric Composition and Climate — Interim Implementation (MACC-II) service (*see* <http://www.gmes-atmosphere.eu/>) that covers the years 1979–2011. An earlier version of this product is described by Chevallier *et al.* (2010). It used CO₂ mole fraction measurements from 134 sites recorded in a series of global databases. Data from the Finnish GAW station, Pallas-Sammaltunturi, were exploited in the inversion system, but since this station is located 700 km north of the SMEAR II site, the MACC-II simulation could be considered completely independent.

We reported the simulated CO₂ mole fractions for the first layer (200-m thick) of the simulation which included all the sampling heights at the site.

Results and discussion

Instrumentation

Permeation through sample line tube wall

Based on the observations, the CO₂ mole fraction at 0.3 m above the soil surface in summer ranged from somewhat below 400 to 500 ppm or higher, depending on the time of day and meteorological conditions. During winter, the CO₂ mole fraction at 0.3 m above the soil surface was rather constant at around 400 ppm. In order to get an order-of-magnitude estimate of the exchange through the tube walls, we considered a CO₂ mole fraction difference of 125 ppm across the sample line tube wall. The estimated permeation rate of CO₂ through the tube wall was $7.5 \times 10^{-13} \text{ m}^3 \text{ s}^{-1}$. Combined with the 20-s lag time, the estimated increase of CO₂ in the sample air during its flow in the main sample line was about $1.5 \times 10^{-11} \text{ m}^3$. Since the internal volume of the sample line was about 0.015 m³, the maximum estimated increase of the CO₂ mole fraction in the sample line was 0.001 ppm. Hence, we considered the permeation through the sample line tube wall negligible.

Signal pressure and temperature correction

We performed test measurements in December 2005 in order to determine the dependence of the CO₂ mole fraction signal of the URAS 4 CO₂ analyzer on the sample pressure. The standard deviations of CO₂ mole fraction and pressure signals were 0.05 ppm and 0.15 hPa, respectively. The measurements took about one hour, with about 5 min between each measurement. There was a slight linear decrease in the signal, resulting in a difference of about –0.2 ppm between the first and last measured value. We assumed this to be a result of a calibration drift during the one-hour time, so we subsequently corrected for it by de-trending the measured time series. By applying this drift correction to the measured values of the CO₂ mole fraction of the reference gas at different sample pressures, we could determine an adequate pressure correction equation. The basis of the correction equation for the pressure dependence of the signal were (i) the Beer-Lambert absorption law, stating that the intensity of light decreases exponentially as it travels through a medium; and (ii) the method presented by Jamieson *et al.* (1963) for scaling the absorption measured in one pressure to another pressure condition. The dependence of the URAS 4 CO₂ mole fraction signal on the sample pressure was found to be adequately described with a second order polynomial. So the pressure correction equation was determined by fitting pressure ratios to measured concentrations to obtain an equation

$$\frac{C}{C_{\text{ref}}} = a \left(\frac{p}{p_{\text{ref}}} \right)^2 + b \left(\frac{p}{p_{\text{ref}}} \right) + c, \quad (1)$$

where C is the measured concentration, $C_{\text{ref}} = 442.6$ ppm is the reference concentration, p is the set pressure, $p_{\text{ref}} = 883.5$ hPa is the reference pressure, and $a = 0.2822$, $b = 0.8305$ and $c = -0.1127$ are the coefficients determined by the regression. The reference pressure was chosen to be equal to the pressure at which the calibration of the URAS 4 analyzer was adjusted. The pressure corrected signals were consistent among each other (Fig. 3a). Further, we applied the correction for the observed drift and a calibration correction to the mole fraction signals measured at different pressures (*see* Fig. 3b). We estimated

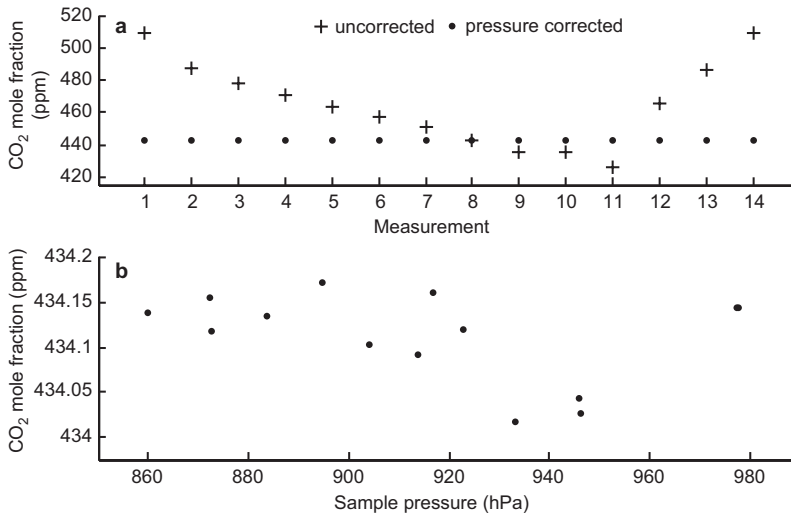

Fig. 3. (a) Uncorrected and pressure-corrected CO₂ mole fraction signals of URAS 4 analyzer. Time span between the measurements was 1 h. For the pressure correction the reference pressure and CO₂ mole fraction were 883.5 hPa and 442.6 ppm, respectively. (b) Pressure, calibration and drift-corrected CO₂ mole fraction signals of the URAS 4 analyzer. There are actually two data points at the pressure near 980 hPa, but they overlap so closely that they are not distinguishable here.

the precision of the pressure correction during the test to be 0.1 ppm.

The magnitude of the correction to the CO₂ signal of the URAS 4 analyzer due to the pressure difference between the calibration and ambient air sample varied during the period covered in this study, because the pressure decrease in the main sample line and also the throttle effect of the needle valve in the calibration gas sample line were variable. The pressure ratio (p/p_{pref} in Eq. 1) changed from ~ 0.998 to ~ 1.005 , and as a result during this study the correction factor applied to the CO₂ signal of the URAS 4 analyzer ranged from about 0.9972 to 1.0070. Expressed in terms of concentration, the amount of correction ranged from about 1 to -3 ppm. As the sample pressure varied in the same interval as during the test measurements, we assumed the precision of the correction to be also 0.1 ppm.

The LI-840 (LI-820) analyzer had also a distinct dependence of CO₂ mole fraction signal on the sample pressure even after the pressure correction implemented by the internal correction algorithm of the analyzer. However, this remaining dependence was relatively small, approximately -0.0082 ppm hPa⁻¹. The pressure difference between the ambient air sample and the calibration gas samples was of the order of 5 hPa, so the error of the internal pressure correction of the LI-840 analyzer was about 0.04 ppm. We applied a similar pressure correction algorithm that was used for the URAS 4 analyzer and the

precision of the correction was 0.02 ppm.

We found the sample temperature during the measurements of the calibration gases and during the measurements of the ambient air samples to differ by less than 0.1 °C, which resulted in a correction of 0.1 ppm or less to the CO₂ mole fraction signals based on calculations using the ideal gas law. On average, the temperature difference was slightly negative (about -0.02 °C), and this resulted in about 0.03 ppm (positive) correction to the CO₂ signal. Considering the precision of the temperature signal (about 0.05 °C), the precision of the correction due to the temperature difference was about 0.07 ppm.

H₂O interference correction

Compared with the calibration gases by-passing the dryer, there was an approximately 0.2 mmol mol⁻¹ residual H₂O mole fraction (data not shown) in the ambient sample air after passing through the dryer. This was in accordance with the specifications of the dryer. The results also showed that while the dryer removed H₂O vapour from the ambient sample air, it also humidified the calibration gases to the above-mentioned H₂O mole fraction. On average, we found a systematic difference of less than 0.01 mmol mol⁻¹ in the H₂O mole fraction between the dried ambient air and humidified cylinder gas. Rather than trying to achieve a greater degree of drying efficiency,

which would have required major modifications also to the pneumatics system of the station, we considered it better to let the calibration gases be humidified to the same H₂O mole fraction as the sample air was dried to. This way we could estimate the interference and dilution effects of H₂O vapour on the CO₂ signal to be equal for both the ambient sample air and the calibration gases.

The difference between the biases in the CO₂ mole fraction signal (less than 0.02 ppm) caused by the different amounts of H₂O vapour was not relevant for the results obtained with either analyzer because it was not discernible from the CO₂ mole fraction signal noise (approximately 0.1 ppm). So we considered the ambient sample air and the calibration gases to have the same H₂O mole fraction, and made no corrections due to signal bias and dilution caused by H₂O vapour.

Signal noise of the analyzers

In the case of the URAS 4 analyzer, we found the noise (estimated as standard deviation) of the CO₂ signal for the calibration gases to vary considerably between measurements, from 0.04 ppm to close to 1.4 ppm. We found that the magnitude of the noise depended on the CO₂ mole fraction of the calibration gas (higher mole fraction corresponding to higher noise). We found that the baseline of the noise was about 0.04 ppm, and a considerable fraction of this could be assumed to be due to the noise of the sample pressure and temperature signals.

In case of the LI-840 analyzer, we found that the CO₂ signal noise level for the calibration gases was more stable than that of the URAS 4 analyzer. The baseline of the LI-840 CO₂ signal noise was about 0.1 ppm, the noise did not exceed 0.5 ppm, and the noise did not depend on the CO₂ mole fraction of the calibration gas (data not shown).

Precision of the calibration

We found that the fit residuals for the CO₂ calibration gases were generally between -0.1 and 0.1 ppm (in the case of a second order polynomial fit) for all the analyzers. Until 10 October

2007 (URAS 4 analyzer was in use), only three calibration gases were in use and the residuals of the (linear) fit were between -0.2 and 0.4 ppm. The use of five calibration gases from 11 October 2007 onwards improved the (polynomial) fit without any re-linearization of the analyzer. In case of the LI-840 (and LI-820) analyzer, there was no essential difference between the linear and the polynomial fit.

During test runs performed during this study, we found that the times needed for the signals of the calibration gases E and D gases to stabilize were about 1 min longer than for the other gases, but once the flush times were set long enough (1 min 40 s), we could not find any trend during the recording of the signals (1 min 20 s). We also tested the effect of different feeding orders of the gases on the calibration results. There was no discernible effect.

We considered the RMS value of the residuals to be a measure of the precision of the fit and estimated it to be ~0.3 ppm until 10 October 2007 and 0.1 ppm from 11 October 2007 onwards (Fig. 4).

Stability of the instrumental response

The difference of the measured CO₂ mole fractions of the bottled natural air between before and after the feeding of the calibration gases provided a measure of the stability of the instrumental response (*see* Fig. 5). We found that the determined CO₂ value of the bottled natural air cylinder varied by less than 0.5 ppm in the course of the daily calibration sequences. Occasions when the difference exceeded ± 0.5 ppm were related to known malfunctions also pointed out by other indicators.

Between 1 October 2006 and 10 October 2007, the difference was -0.01 ± 0.11 ppm (URAS 4 analyzer in use). From 11 October 2007 onwards, the measured difference was -0.09 ± 0.11 ppm, and a similar systematic difference (-0.06 ± 0.07 ppm) was evident also in the data from the LI-840 analyzer. Since there should not be any real change of the CO₂ mole fraction in the bottled natural air from the cylinder during the 30 min period, we considered this finding to be an indication that the previous

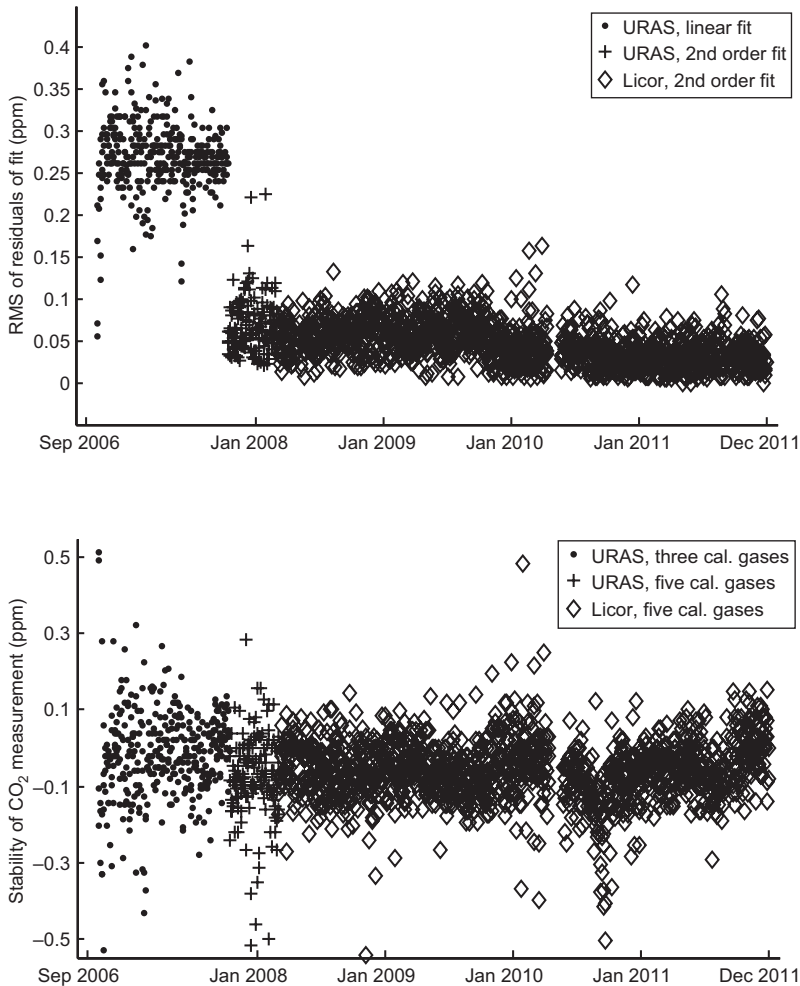

Fig. 4. Average (RMS) of the fit residuals for the calibration gases. Until 10 October 2007, there were three calibration gases in use and subsequently a linear regression was used in the fit. From 11 October 2007 onwards there were five calibration gases in use and a second order fit was used. The data are from the URAS analyser until 29 February 2008. Starting 1 March 2008, the data are from the LI-840 (LI-820) analyser.

Fig. 5. Measured difference in the CO₂ mole fraction of the compressed natural air cylinder between the measurements before and after the calibration gas feed (identified as stability).

sample was not completely flushed from the optical cell of the instrument in either measurement. The change in the measured difference coincided with the change of the calibration gas preceding the latter measurement of the bottled natural air from A (~350 ppm of CO₂) to D (~410 ppm of CO₂), so the reason for the difference seemed to be an inadequate flushing of the (higher mole fraction) calibration gas. However, we found no trend in the mole fraction signals recorded (for 1 min 50 s) during the measurement of the bottled natural air. In addition, with this explanation the observed difference should have had the opposite sign until 10 October 2007, as the CO₂ concentration of calibration gas A was significantly lower than that of ambient air. But as we did not find such positive difference, the reason for the change remained unclear.

We considered the difference in the measured CO₂ mole fraction of the bottled natural air (at a circa 15-min interval) to indicate that the instrumentation was stable with the variability of less than 0.5 ppm, but the sudden change in the measured mole fraction indicated an additional systematic error of 0.1 ppm of the calibration.

Repeatability of the instrumentation

The comparison between the night and afternoon CO₂ mole fraction results for the bottled natural air (Fig. 6) included only the measurements preceding the feeding of the calibration gases. The reason was that flushing of SF₆ in nitrogen calibration gas, fed to the system between the calibration gases and the bottled natural air

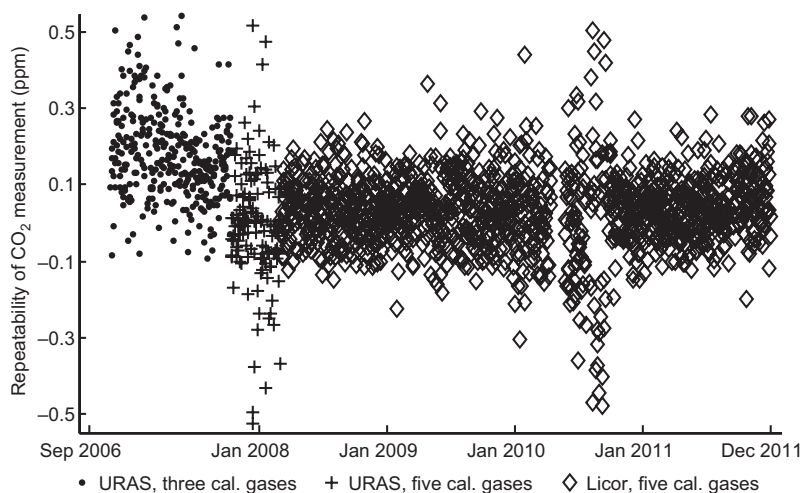

Fig. 6. Observed difference in the CO₂ mole fraction of the compressed natural air cylinder between afternoon and night-time measurements (identified as repeatability). Until 10 October 2007, the A, C, E and the B, C and D calibration gases were in use during the afternoon and night measurements, respectively. From 11 October 2007 onwards, all five calibration gases were in use during the afternoon measurements, and from 27 Nov 2007 onwards, all five calibration gases were in use also during the night measurements. The data is from URAS analyser until 29 February 2008. Starting from 1 March 2008, the data are from LI-840 (LI-820) analyser.

during the night sequence seemed to require a relatively longer time than flushing of the CO₂ calibration gases (data not shown). The systematic difference between the night and afternoon results for the CO₂ mole fractions of the bottled natural air was approximately 0.1 ppm until 10 October 2007. Coincidentally with the addition of two more calibration gases (namely cylinders B and D) to the afternoon calibration sequence, and thereby allowing for the application of a second order polynomial fit, the systematic difference between the night and afternoon results disappeared on 11 October 2007. The time series for the CO₂ mole fraction in the bottled natural air observed in the afternoon measurements also showed a step-like change of about 0.1 ppm on 11 October 2007. We increased the number of the calibration gases in the nighttime measurements also to five on 27 November 2007 (cylinders A and E added), but we did not observe any change in the measured CO₂ mole fraction of the bottled natural air. This we assumed to be due to the CO₂ mole fractions in calibration gases B, C and D all being closer to the CO₂ mole fraction in the natural air cylinder.

We concluded that the differences between the CO₂ mole fraction results of the bottled natural air measured at a 12-h interval added

an inaccuracy of 0.1 ppm to the calibration due to the choice of the concentration range of the calibration gases.

Reliability of the instrumentation

Due to technical problems related directly to the instrumentation, about 1% of the measurements (in two instances) were unsuccessful. The LI-840 analyzer had one breakdown due to the finite working life of its IR lamp. Also the URAS 4 analyzer had one breakdown, but this occurred when it had already been replaced by the LI-840 analyzer. The data collection system had one breakdown. About 2% of the measurements were cancelled on purpose, and we intentionally rejected about 2% of the measurement results because of bad data. All in all the total fraction of the (potential) ambient CO₂ mole fraction data missing was about 5%.

Affordability of the instrumentation

The subsystems of our instrumentation for the measurement of the ambient CO₂ concentration included the main sample lines with the mani-

folds and valves, relays for valve control, calibration gas cylinders, pressure regulators, tubes, valves and mass flow controller, sample air dryer, compressor, compressed air dryer, gas analyser, pressure and temperature sensors, needle valves, flow meters and sample air pump (Fig. 2). By utilizing an optional system with a gas analyser of a different design and technique featuring inherently higher precision, accuracy and stability, we could have left out the sample air dryer, compressor and the compressed air dryer. The overall consumption of the calibration gases was about 64 m³ during this 62-month-long study. With a more stable analyser, the estimated consumption of calibration gases could have been about half of this amount. However, two sets of five gas cylinders and cylinder pressure regulators would have been needed also with an optional system as the CO₂ concentrations of the calibration gases were certified to be stable for three years and thus at least one re-calibration of the calibration gases was needed during the study.

The price of the analytical parts, excluding the calibration gas cylinders and pressure regulators, of our instrumentation was about 11 000 euro, and by taking into account the filling of the calibration gas cylinders, the price still remained under 15 000 euro. We estimate that this overall cost was in between one third and one fourth of that of an alternative higher-precision analytical system.

Comparisons

Inter-comparison experiment I (ambient air samples)

Flask samples were collected in triplicate such that we obtained three CO₂ mole fraction results for each sample collection period with the MPI CO₂ instrumentation. We used the average of the three mole fractions results as the result for the CO₂ mole fraction (referred to as CO₂ Flask MPI). We applied the standard deviation of the flask triplet results as a measure of the precision.

With the SMEAR II CO₂ instrumentation, we used the median of the readings over the last three minutes of the sample collection period as the CO₂ mole fraction result (referred to as CO₂ Flask SMEAR II). We took the standard

deviation between the readings as a measure of the uncertainty of the *in-situ* measurement data for the flask sampling event. For the error estimate of the difference between the results of the two instrumentations, we applied the rule of error propagation assuming that the instrumental errors were independent of each other.

The results from the inter-comparison between the instrumentations are given in Table 2. During the comparison experiment I, only three (A, C and E) calibration gases were in use and results of the SMEAR II CO₂ instrumentation were from the data obtained with the URAS 4 analyzer. The CO₂ mole fractions obtained with the SMEAR II CO₂ instrumentation were systematically lower than the reference mole fractions obtained with the MPI CO₂ instrumentation. The average discrepancy (-0.3 ± 0.2 ppm) was, however, smaller than the limit set for the desired accuracy (0.5 ppm). The residual of the fit at CO₂ mole fraction of 370.31 ppm (for the calibration gas B) was -0.1 ppm. This was in line with the observed difference in the measured CO₂ mole fraction between the two instrumentations when the ambient mole fraction was about 372 ppm, and thus might partly explain it. The MPI CO₂ flask samples were collected directly from the main sample line from the 67.2-m height, so they were not exposed to possible leaks through the pneumatic connections between the main sample line manifold and the analyser.

We consider the good agreement between the results of the SMEAR II CO₂ and the MPI CO₂ instrumentation as an indication that the SMEAR II instrumentation inside the measurement cabin was not affected by any leaks.

Inter-comparison experiment II (cylinder gas samples)

In the first inter-comparison experiment II in July 2008, the CO₂ mole fractions measured with the SMEAR II CO₂ instrumentation for the cylinders were systematically slightly higher than the reference mole fractions determined by University of Heidelberg Institute of Environmental Physics, Germany (UHEI-IUP, Table 3). The average deviation from the reference CO₂ mole fractions

was 0.06 ± 0.10 ppm, which was smaller than the 0.5 ppm limit set for the desired accuracy.

In the second inter-comparison experiment II in April 2009, the average deviation from the reference CO₂ mole fractions was 0.08 ± 0.08 ppm. The reference values were determined by Max-Planck-Institute for Biogeochemistry, Germany (MPI-BGC). While the result for the one cylinder showed in practice a perfect agreement (discrepancy of -0.01 ppm), the result for the other cylinder differed by -0.16 ppm from the reference CO₂ mole fraction (Table 3). It was during the measurement of that cylinder (reference CO₂ mole fraction 377.86 ppm) that the stabilisation of the signal took a considerably long time. The laboratory of MPI-BGC also reported problems associated with drift of the CO₂ mole fraction signal with that same cylinder (A. Jordan pers. comm.). Thus it unfortunately remains unclear whether those measurements could be performed correctly or the cylinder had a large drift.

In the following inter-comparison measurements (May 2010, January 2011 and December 2011), the average deviations from the reference values of the cylinders continued to be within the range of -0.1 to 0.1 ppm (data not shown) and thus met our accuracy target.

Comparison between the two analyzers

The average difference between the ambient CO₂ mole fractions obtained with the URAS 4

Table 2. The reference ambient CO₂ mole fractions (ppm) measured with the MPI CO₂ instrumentation and the discrepancies between the reference values and the mole fractions determined with SMEAR II CO₂ instrumentation during 28 August 2007–29 August 2007. The standard deviations reflect the variability of the *in-situ* measurement data and comprise the precision of the analyzer as well as the atmospheric variability in the sampling period.

Sampling period	MPI CO ₂	MPI CO ₂ – SMEAR II CO ₂ (mean ± SD)
15:45–16:01	372.13	0.37 ± 0.27
16:27–16:43	372.13	0.50 ± 0.20
07:27–07:43	372.82	0.17 ± 0.22
10:26–10:42	371.12	0.43 ± 0.28
18:26–18:42	372.59	0.15 ± 0.26

and LiCor analyzers was 0.1 ± 0.4 ppm and the URAS 4 analyzer indicated a higher mole fraction (Fig. 7). We found that the true variability of the ambient CO₂ mole fraction in the course of the 5-min measurement periods was considerable (> 0.5 ppm) during growing seasons. The standard deviations of the signals for the ambient CO₂ mole fraction from both analyzers were similar. By weighing the difference signals with the reciprocals of the 5-min standard deviations we could obtain a more clear set of data, because the larger differences found to be linked to more variable CO₂ mole fractions were attenuated. The weighing did not affect the average difference between the CO₂ mole fraction results and it remained essentially the same.

The temperature correction to the URAS 4 CO₂ mole fraction signal was on average 0.03 ppm and it was towards higher mole fractions, while the pressure correction varied between 0 and 2 ppm and it was towards lower mole fractions. But while the pressure ratio had remarkable variability and even clear trends, we did not find corresponding changes in the difference of the CO₂ mole fraction signals. The reason for the average difference remained unclear.

Table 3. The reference gas cylinder CO₂ mole fractions (ppm) and the discrepancies between the reference values and the mole fractions determined with SMEAR II CO₂ instrumentation in July 2008 (the values in lines 1–3) and in April 2009 (the values in lines 4–5). In July 2008, the reference gas cylinders belonged to the CarboEurope-Atmosphere Cucumber Inter-comparison programme (see <http://cucumbers.uea.ac.uk/>) and were analysed by University of Heidelberg Institute of Environmental Physics, Germany. In April 2009, the reference gas cylinders belonged to the Flux Tower Inter-comparison programme of the CarboEurope Integrated Project (see <http://www.carboeurope.org/>) and were analysed by Max-Planck-Institute for Biogeochemistry, Germany.

Reference gas cylinder no.	Reference	Reference – SMEAR II CO ₂ (mean ± SD)
D88473	379.26	-0.08 ± 0.12
D88482	359.95	-0.07 ± 0.09
D88486	408.42	-0.04 ± 0.10
D88477	377.86	0.16 ± 0.10
D88488	399.79	0.01 ± 0.06

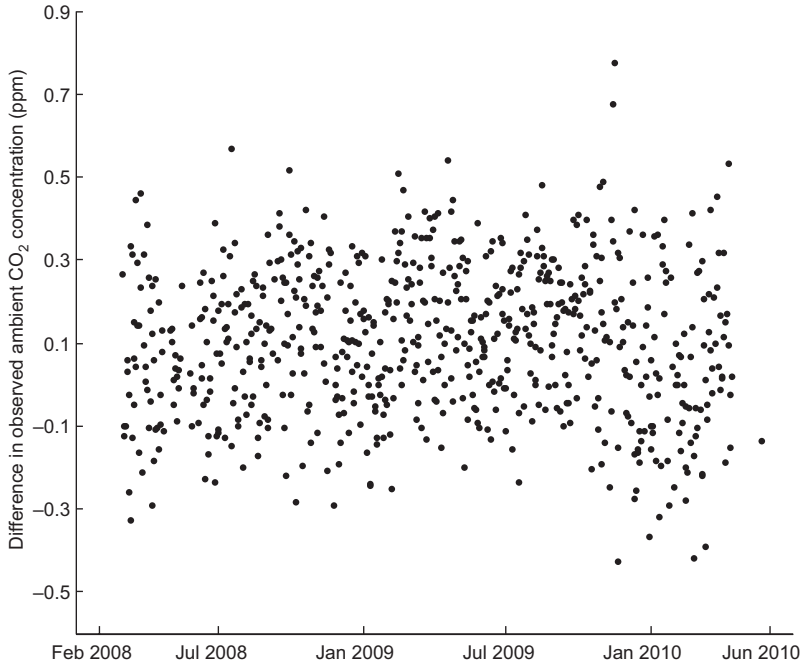

Fig. 7. Difference between the ambient CO₂ mole fraction results measured with the URAS 4 and LI-840 analyzers. The data covers the period 1 Mar 2008–28 May 2010.

Comparison with the large scale MACC-II atmospheric transport simulation results

For the comparison with the model simulation, we filtered the data of the measured afternoon CO₂ mole fractions using the CO₂ mole fraction profile data. We searched the profile data for situations in which the atmosphere was well mixed. In practice, we set the selection criteria to have the gradient between the 67.2-m and 33.6-m heights smaller than 0.2 ppm. This filtering improved the fit between the observations and simulation data: the median (\pm SD) of the difference over the time series was -0.38 ppm (± 3.7 ppm) with the full, unfiltered, data set and -0.20 ppm (± 3.3 ppm) with the filtering applied.

We considered both the trend and phase of the observed and simulated CO₂ mole fractions to agree generally well (*see* Fig. 8a) and the overall bias of the simulation was within the accuracy of the instrumentation. This difference was well below the observation error (instrumental, model representation and model error) used in the MACC-II inversion, which is typically of several ppm (Chevallier *et al.* 2010). It was not expected that the model would provide a perfect match with the measured CO₂ time series, since the data

from this site were not used by the inversion, so that fluxes were constrained only by data from the remote Pallas station (and other stations). The data also indicated that the amplitude in the simulation data was in some cases underestimated. More specifically the simulated uptake of CO₂ was not strong enough for some of the years (by 1–3 ppm of CO₂ in 2007 and 2008), and that some periods showed biases up to several ppm of CO₂ (Fig. 8b). The most notable period was during May–July 2010 when the observed CO₂ drawdown temporarily stopped while the model accelerated it. Some of this discrepancy could be caused by errors in taking into account the transport of CO₂ in the simulation, but as the CO₂ mole fraction signal for the site simulated by the model was driven instead by remote measurements and by the prior fluxes, we considered that the lack of local measurement constraints in the area was the main contributor to the discrepancy.

Summary and conclusions

The instrumentation fulfilled the two basic requirements — accurate results and continuous operation. Due to technical problems, directly

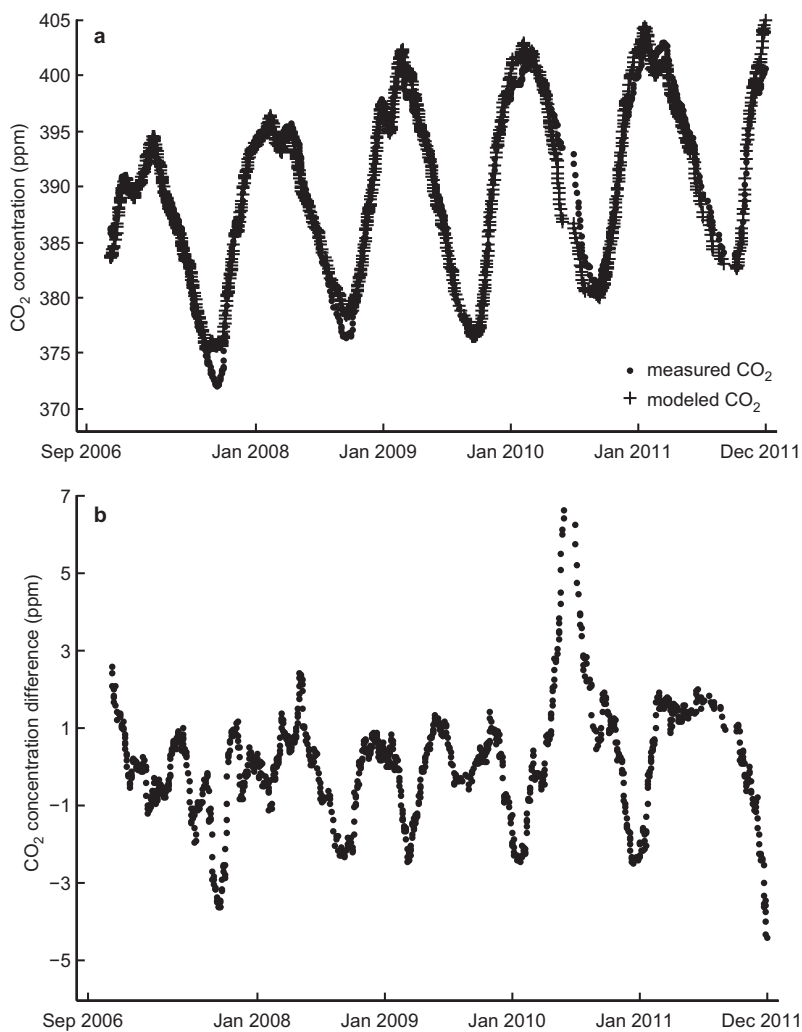

Fig. 8. (a) Measured and simulated atmospheric CO₂ mole fractions, and (b) difference (measured – simulated) between the atmospheric CO₂ mole fractions during situations with well mixed atmosphere.

related to the instrumentation, about 1% of the measurements (in two instances) were unsuccessful. The set goal of accuracy of 0.5 ppm was also clearly achieved.

Based on the comparison with a reference instrumentation (flask samples of MPI in August 2007) measuring the same sample air, we determined the accuracy to be 0.3 ppm (our instrumentation gave lower CO₂ mole fraction). Based on the comparison (in July 2008) with the three reference gas cylinders of CarboEurope ICP, we determined the accuracy to be 0.06 ppm (our instrumentation gave higher CO₂ mole fraction for all the five cylinders). Finally, based on the comparison (in April 2009) with the two reference gas cylinders of Flux Tower ICP, we

determined the accuracy to be 0.01 ppm for one cylinder and 0.16 ppm for the other one (our instrumentation gave higher CO₂ mole fraction for the both cylinders).

Summing up the random errors (pressure correction, temperature correction, signal noise, precision of the calibration, stability and repeatability), the estimates for the precision of the measured ambient CO₂ mole fraction were ± 0.4 ppm when the calibration was performed with three reference gases (until 10 October 2007), and ± 0.2 ppm when the calibration was performed with five reference gases (from 11 October 2007 onwards). The accuracies obtained from the results of the inter-comparison experiments were in agreement with the accuracies

of the calibration standards (0.05 ppm) and the estimated precisions.

The results of the comparison between the analyzers URAS 4 and LI-840 showed a 0.1 ppm difference in the ambient CO₂ mole fraction with the URAS 4 giving higher mole fraction results. We considered such deviation between the results a minor one when taking into account that the pressure correction to the URAS 4 CO₂ mole fraction signal alone ranged from 0 to 2 ppm. Although it could be argued that the pressure correction equations worked for the analyzers, we concluded that it was advisable to keep the sample pressure as equal as possible during the measurement of the calibration gases and the ambient sample air. Likewise, the temperatures of the calibration gases and ambient sample air should be equal.

The use of a sample air dryer to dry the ambient sample as well as humidify the calibration gases reduced significantly the bias that would have been caused by the H₂O vapour, especially in the case of the URAS 4 analyzer. For the URAS 4 analyzer, the H₂O mole fraction of about 0.2 mmol mol⁻¹ left in the ambient sample air after the drying would have resulted in a correction approximately equalling the target accuracy. Also in the case of the LI-840 analyzer, we considered the use of a dryer as beneficial in order to achieve target accuracy by eliminating the need to measure H₂O vapour mole fraction accurately and calculate the dilution correction to the CO₂ mole fraction signal.

We found out that the use of only three calibration gases (until 10 October 2007 in the afternoon measurements) was a mistake because it impaired the accuracy as the relatively large residuals (on the average 0.3 ppm) of the fit degraded the measurement precision. That the actual CO₂ mole fractions of two of the three calibration gases during the same time were at the ends of the calibration range also impaired the accuracy of the calibration by about 0.1 ppm. However, the introduction of two more calibration gases, with CO₂ mole fractions at the ends of the calibration range, to the nighttime calibration sequence did not cause any noticeable change in the measured CO₂ mole fraction of the bottled natural air. Considering this, we could argue that the use of three calibration gases

with CO₂ mole fractions near (± 20 ppm) the CO₂ mole fraction of the bottled natural air, or the CO₂ mole fraction of the atmospheric sample air as a matter of fact, would have been an adequate procedure. But the use of more calibration gases naturally added to the number of calibration data points and this way improved precision. We did not find the feeding order of the calibration gases to affect the accuracy. We did not find any distinctive changes (i.e. greater than 0.1 ppm) in the CO₂ mole fractions of the calibration gases.

The general agreement between the measured and simulated CO₂ mole fraction data indicated a good behaviour of the simulation. We interpreted the periods of disagreement to be due to the lack of local measurement constraints that were not used by the current simulation. Overall, this comparison with the MACC-II simulation suggested that the model would be able to reproduce after flux correction the observed CO₂ variability at the SMEAR II site. Hence, the measurement of the CO₂ mole fraction at the site would be desirable for future simulations.

This study highlighted the importance of quantifying all the sources of uncertainty in measurements, especially in view of stringent requirements for continuous CO₂ mole fraction data from long-term measurement stations and large station networks (such as GAW and ICOS) used in climate change studies.

Acknowledgements: The study was supported by the Academy of Finland Center of Excellence program (project number 1118615), projects ICOS 271878, ICOS-Finland 281255 and ICOS-ERIC 281250 funded by Academy of Finland, by EU projects GHG-Europe and InGOS and by the NordForsk Nordic Centre of Excellence (project DEFROST). Personnel at the SMEAR II station are acknowledged for the maintenance of the instrumentation.

References

- Baldocchi D.D. 2003. Assessing the eddy covariance technique for evaluating carbon dioxide exchange rates of ecosystems: past, present and future. *Global Change Biol.* 9: 479–492.
- Bakwin P.S., Davis K.J., Yi C., Wofsy S.C., Munger J.W. & Haszpra L. 2004. Regional carbon dioxide fluxes from mixing ratio data. *Tellus* 56B: 301–311.
- Broquet G., Chevallier F., Bréon F.-M., Kadygrov N., Alemanno M., Apadula F., Hammer S., Haszpra L., Meinhardt F., Morguá J.A., Necki J., Piacentino S., Ramonet

- M., Schmidt M., Thompson R.L., Vermeulen S.T., Yver C. & Ciais P. 2013. Regional inversion of CO₂ ecosystem fluxes from atmospheric measurements: reliability of the uncertainty estimates. *Atmos. Chem. Phys.* 13: 9039–9056.
- Burch D.E., Singleton E.B. & Williams D. 1963. Absorption line broadening in the infrared. *Applied Optics* 1: 359–363.
- Carouge C., Bousquet P., Peylin P., Rayner P.J. & Ciais P. 2010. What can we learn from European continuous atmospheric CO₂ measurements to quantify regional fluxes — Part 1: Potential of the 2001 network. *Atmos. Chem. Phys.* 10: 3107–3117.
- Chevallier F., Engelen R.J. & Peylin P. 2005. The contribution of AIRS data to the estimation of CO₂ sources and sinks. *Geophys. Res. Lett.* 32, L23801, doi:10.1029/2005GL024229.
- Chevallier F., Ciais P., Conway T.J., Aalto T., Anderson B.E., Bousquet P., Brunke E.G., Ciattaglia L., Esaki Y., Fröhlich M., Gomez A., Gomez-Pelaez A.J., Haszpra L., Krummel P.B., Langenfelds R.L., Leuenberger M., Machida T., Maignan F., Matsueda H., Morgui J.A., Mukai H., Nakazawa T., Peylin P., Ramonet M., Rivier L., Sawa Y., Schmidt M., Steele P., Vay S.A., Vermeulen A.T., Wofsy S. & Worthy D. 2010. CO₂ surface fluxes at grid point scale estimated from a global 21 year reanalysis of atmospheric measurements. *J. Geophys. Res.* 115, D21307, doi:10.1029/2010JD013887.
- Ciais P., Canadell J.G., Luysaert S., Chevallier F., Shvidenko A., Poussi Z., Jonas M., Peylin P., King A.W., Schulze E.-D., Piao S., Rödenbeck C., Peters W. & Bréon F.-M. 2010. Can we reconcile atmospheric estimates of the Northern terrestrial carbon sink with land-based accounting? *Current Opinion in Environmental Sustainability* 2: 225–230.
- Francey R.J., Trudinger C.M., van der Schoot M., Law R.M., Krummel P.B., Langenfelds R.L., Steele L.P., Allison C.E., Stavert A.R., Andres R.J. & Rödenbeck C. 2013. Atmospheric verification of anthropogenic CO₂ emission trends. *Nature Climate Change* 3: 520–524.
- Gerbig C., Körner S. & Lin J.C. 2008. Vertical mixing in atmospheric tracer transport models: error characterization and propagation. *Atmos. Chem. Phys.* 8: 591–602.
- Gurney K.R., Law R.M., Denning A.S., Rayner P.J., Baker D., Bousquet P., Bruhwiler L., Chen Y.-H., Ciais P., Fan S., Fung I.Y., Gloor M., Heimann M., Higuchi K., John J., Maki T., Maksyutov S., Masarie K., Peylin P., Prather M., Pak B.C., Randerson J., Sarmiento J., Taguchi S., Takahashi T. & Yuen C.-W. 2002. Towards robust regional estimates of CO₂ sources and sinks using atmospheric transport models. *Nature* 415: 626–630.
- Gurney K.R. & Eckels W.J. 2011. Regional trends in terrestrial carbon exchange and their seasonal signatures. *Tellus* 63B: 328–339.
- Hari P. & Kulmala M. 2005. Station for Measuring Ecosystem–Atmosphere Relations (SMEAR II). *Boreal Env. Res.* 10: 315–322.
- Haszpra L., Barcza Z., Bakwin P.S., Berger B.W., Davis K.J. & Weidinger T. 2001. Measuring system for the long-term monitoring of biosphere/atmosphere exchange of carbon dioxide. *J. Geophys. Res.* 106: 3057–3069.
- Hatakka J., Aalto T., Aaltonen V., Aurela M., Hakola H., Komppula M., Laurila T., Lihavainen H., Paatero J., Salminen K. & Viisanen Y. 2003. Overview of the atmospheric research activities and results at Pallas GAW station. *Boreal Env. Res.* 8: 365–383.
- Heard D.E. 2006. *Analytical techniques for atmospheric measurement*. Blackwell Publishing Ltd., Oxford, UK.
- Jamieson J.A., McFee R.H., Plass G.N., Grube R.H. & Richards R.G. 1963. *Infrared physics and engineering*. Inter-University Electronics Series, McGraw-Hill Book Company, Inc., New York, NY.
- Jung M., Reichstein M., Margolis H.A., Cescatti A., Richardson A.D., Arain M.A., Arneth A., Bernhofer C., Bonal D., Chen J., Gianelle D., Gobron N., Kiely G., Kutsch W., Lasslop G., Law B.E., Lindroth A., Merbold L., Montagnani L., Moors E.J., Papale D., Sottocornola M., Vaccari F. & Williams C. 2011. Global patterns of land-atmosphere fluxes of carbon dioxide, latent heat, and sensible heat derived from eddy covariance, satellite, and meteorological observations. *J. Geophys. Res.* 116, G00J07, doi:10.1029/2010JG001566.
- Karstens U., Gloor M., Heimann M. & Rödenbeck C. 2006. Insights from simulations with high-resolution transport and process models on sampling of the atmosphere for constraining midlatitude land carbon sinks. *J. Geophys. Res.* 111: 12301–12320.
- Lauvaux T., Uliasz M., Sarraat C., Chevallier F., Bousquet P., Lac C., Davis K.J., Ciais P., Denning A.S. & Rayner P.J. 2008. Mesoscale inversion: first results from the CERES campaign with synthetic data. *Atmos. Chem. Phys.* 8: 3459–3471.
- Lauvaux T., Gioli B., Sarraat C., Rayner P.J., Ciais P., Chevallier F., Noilhan J., Miglietta F., Brunet Y., Ceschia E., Dolman H., Elbers J.A., Gerbig C., Hutjes R., Jarosz N., Legain D. & Uliasz M. 2009. Bridging the gap between atmospheric concentrations and local ecosystem measurements. *Geophys. Res. Lett.* 36, L19809, doi:10.1029/2009GL039574.
- Le Quéré C., Andres R.J., Boden T., Conway T., Houghton R.A., House J.I., Marland G., Peters G.P., van der Werf G.R., Ahlström A., Andrew R.M., Bopp L., Canadell J. G., Ciais P., Doney S.C., Enright C., Friedlingstein P., Huntingford C., Jain A.K., Jourdain C., Kato E., Keeling R.F., Goldewijk K., Levis S., Levy P., Lomas M., Poulter B., Raupach M.R., Schwinger J., Sitch S., Stocker B.D., Viovy N., Zaehle S. & Zeng N. 2013. The global carbon budget 1959–2011. *Earth Syst. Sci. Data* 5: 165–185.
- Masarie K.A., Pétron G., Andrews A., Bruhwiler L., Conway T.J., Jacobson A.R., Miller J.B., Tans P.P., Worthy D.E. & Peters W. 2011. Impact of CO₂ measurement bias on CarbonTracker surface flux estimates. *J. Geophys. Res.* 116, D17305, doi:10.1029/2011JD016270.
- Meesters A.G.C.A., Tolk L.F., Peters W., Hutjes R.W.A., Vellinga O.S., Elbers J.A., Vermeulen A.T., van der Laan S., Neubert R.E.M., Meijer H.A.J. & Dolman A.J. 2012. Inverse carbon dioxide flux estimates for the Netherlands. *J. Geophys. Res.* 117, D20306, doi:10.1029/2012JD017797.
- Pacala S.W., Hurtt, G.C., Baker, D., Peylin P., Houghton

- R.A., Birdsey R.A., Heath L., Sundquist E.T., Stallard R.F., Ciais P., Moorcroft P., Caspersen J.P., Shevliakova E., Moore B., Kohlmaier G., Holland E., Gloor M., Harmon M.E., Fan S.-M., Sarmiento J.L., Goodale C.L., Schimel D. & Field C.B. 2001. Consistent land- and atmosphere-based U.S. carbon sink estimates. *Science* 292: 2316–2320.
- Peylin P., Houweling S., Krol M. C., Karstens U., Rödenbeck C., Geels C., Vermeulen A., Badawy B., Aulagnier C., Pregger T., Delage F., Pieterse G., Ciais P. & Heimann M. 2011. Importance of fossil fuel emission uncertainties over Europe for CO₂ modeling: model intercomparison. *Atmos. Chem. Phys.* 11: 6607–6622.
- Potter C.S., Randerson J.T., Field C.B., Matson P.A., Vitousek P.M., Mooney H.A. & Klooster S.A. 1993. Terrestrial ecosystem production: a process model based on global satellite and surface data. *Global Biogeochem. Cycles* 7: 811–841.
- Rannik Ü., Keronen P., Hari P. & Vesala T. 2004. Estimation of forest–atmosphere CO₂ exchange by eddy covariance and profile techniques. *Agric. Forest Meteorol.* 126: 141–155.
- Running S.W., Baldocchi D.D., Turner D.P., Gower S.T., Bakwin P.S. & Hibbard K.A. 1999. A global terrestrial monitoring network integrating tower fluxes, flask sampling, ecosystem modelling and EOS satellite data. *Remote Sensing Environ.* 70: 108–127.
- Tans P.P., Fung I.Y. & Takahashi T. 1990. Observational constraints on the global atmospheric CO₂ budget. *Science* 247: 1431–1438.
- Vesala T., Suni T., Rannik Ü., Keronen P., Markkanen T., Sevanto S., Grönholm T., Smolander S., Kulmala M., Ilvesniemi H., Ojansuu R., Uotila A., Levula J., Mäkelä A., Pumpanen J., Kolari P., Kulmala L., Altimir N., Berninger F., Nikinmaa E. & Hari P. 2005. Effect of thinning on surface fluxes in a boreal forest. *Global Biogeochem. Cycles* 19, GB2001, doi:10.1029/2004GB002316.
- Xiao, J., Zhuang, Q., Baldocchi, D.D., Law B.E., Richardson A.D., Chen J., Oren R., Starr G., Noormets A., Ma S., Verma S.B., Wharton S., Wofsy S.C., Bolstad P.V., Burns S.P., Cook D.R., Curtis P.S., Drake B.G., Falk M., Fischer M.L., Foster D.R., Gu L., Hadley J.L., Hollinger D.Y., Katul G.G., Litvak M., Martin T.A., Matamala R., McNulty S., Meyers T.P., Monson R.K., Munger J.W., Oechel W.C., Paw U.K.T., Schmid H.P., Scott R.L., Sun G., Suyker A.E. & Torn M.S. 2008. Estimation of net ecosystem carbon exchange for the conterminous United States by combining MODIS and AmeriFlux data. *Agric. Forest Meteorol.* 148: 1827–1847.
- Yamaji T., Sakai T., Endo T., Baruah P.J., Akiyama T., Saigusa N., Nakai Y., Kitamura K., Ishizuka M. & Yasuoka Y. 2008. Scaling-up technique for net ecosystem productivity of deciduous broadleaved forests in Japan using MODIS data. *Ecol. Res.* 23: 765–775.
- Zhao C.L., Bakwin P.S. & Tans P.P. 1997. A design for unattended monitoring of carbon dioxide on a very tall tower. *J. Atmos. Oceanic Technol.* 14: 1139–1145.
- Zhao C.L. & Tans P.P. 2006. Estimating uncertainty of the WMO mole fraction scale for carbon dioxide in air. *J. Geophys. Res.* 111, D08S09, doi:10.1029/2005JD006003.