

# “Sweat-on-a-Chip”: Analysing Sweat in Real Time with Disposable Micro-devices

Fernando Benito-Lopez\*, Shirley Coyle, Robert Byrne, Vincenzo F. Curto, Dermot Diamond  
CLARITY: Centre for Sensor Web Technologies, Dublin City University, Dublin 9, IRELAND

**Abstract**— Here we present the fabrication and the performance of a novel, wearable, robust, flexible and disposable micro-fluidic device which incorporates miniature optical components as a detection system, for wireless monitoring in real time mode of sweat pH during an exercise session. This micro-fluidic platform is completely non-invasive, with the great advantage of providing a continuous flow of fresh sweat for continuous real time analysis, ensuring immediate feedback regarding sweat composition to an athlete and/or coach. To the best of our knowledge, this is the first wearable and wireless micro-fluidic device suitable for real time analysis and reporting of the wearer’s physiological state.

## I. INTRODUCTION

Wearable sensors are becoming increasingly employed, through the use of embedded transducers or smart fabrics for monitoring parameters like breathing rate, heart rate and footfall [1]. However, due to their relative complexity, there is very little activity in the development of real-time wearable chemo/bio sensing for sports applications. These sensors require that the desired sample of analysis (usually a body fluid such as sweat) is delivered to the sensor’s active surface, whereupon a reaction happens and a signal is generated. Moreover the system must be low cost, while still being robust, miniature, flexible, washable, reusable or disposable [2]. All these requirements point to micro-fluidic devices as the key tools for improving wearable chemo-/bio-sensing.

Sweat is an accessible body fluid composed of a filtrate of blood plasma which contains many substances such as sodium and chloride. Other substances exist in lower concentrations including potassium, bicarbonate and calcium. Sweat electrolyte concentration varies greatly between individuals, being affected by genetics, sweat rate, type of training, degree of hydration and the state of heat acclimatization.

In particular, sweat analysis has been investigated for sports nutrition and performance, and it is known that maintaining fluid and electrolyte balance is essential for health [3]. However the information available is somewhat limited due to the difficulties in collecting sweat for analysis. The most commonly employed approach to date involves the use of patches or pouches placed on the skin to gather a sample, followed by laboratory analysis using standard measurement

techniques. This leads to a delay between sampling and analysis. There is also a risk of contamination of the sample and it may be difficult to ensure the integrity of collection. Sampling sweat from a single site on the body may not give an accurate representation of the total body electrolyte loss as there are regional variations in sweat composition and volume.

Electrolyte losses are a function of sweating rate and sweat composition. Both of these vary over time, and are also influenced by the exercise conditions and the physiology of the individual [4]. Therefore measurements need to be provided in real-time in order for the individual to manage their fluid and electrolyte needs. The need to place sensors at different locations on the body may be addressed by using integrated textile-based sensors which could form a body sensor network within a garment.

In our laboratories, as part of Biotex EU-funded project (see [www.biotex-eu.com/](http://www.biotex-eu.com/)), a wearable, wireless sweat analysis system was successfully fabricated and tested for monitoring sports performance and training [5] [6]. The sensors were integrated into a wearable platform that allowed direct collection of sweat in an unobtrusive way. A textile-based fluidic system used a combination of moisture wicking fabrics and superabsorbent materials to collect and deliver sweat, Figure 1.

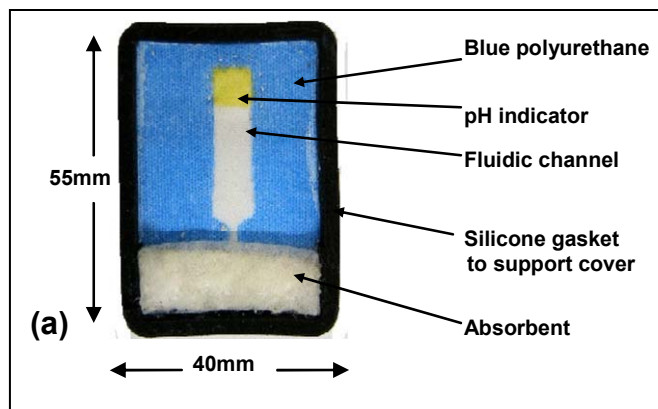

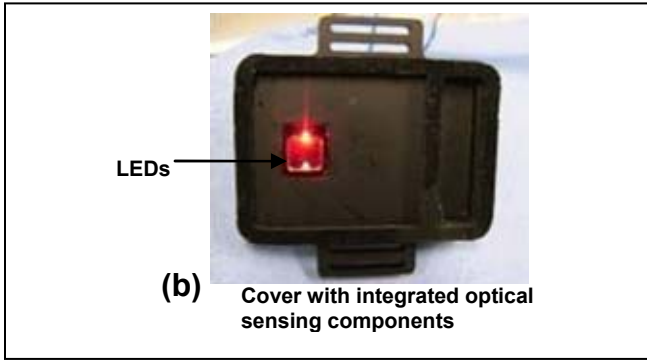

Figure 1. Fabric-based sweat analysis system, developed as part of the BIOTEX project. (A) shows the fabric fluidic channel with a pH sensitive dye (bromocresol purple) integrated in the channel. (B) the colorimetric response of the dye was detected using LEDs integrated into the device cover.

Despite the fact of the success of this system, a smaller device with smaller dead volumes would reduce the delay between commencing exercise and generating valid data and also make the device accessible for a wider range of user groups. Therefore we have developed a micro-fluidic version of the platform to measure changes in the pH of sweat.

## II. MICRO-FLUIDIC DEVICE FABRICATION

Figure 2 shows a schematic representation of the fabrication of the micro-chip structure. The micro-chip (2 x 3 cm) is easily fabricated using poly(methyl-methacrylate) and pressure-sensitive adhesive in three layers using a CO<sub>2</sub> ablation laser. The inlet has a drop shape for efficient sweat collection when in contact with the skin.

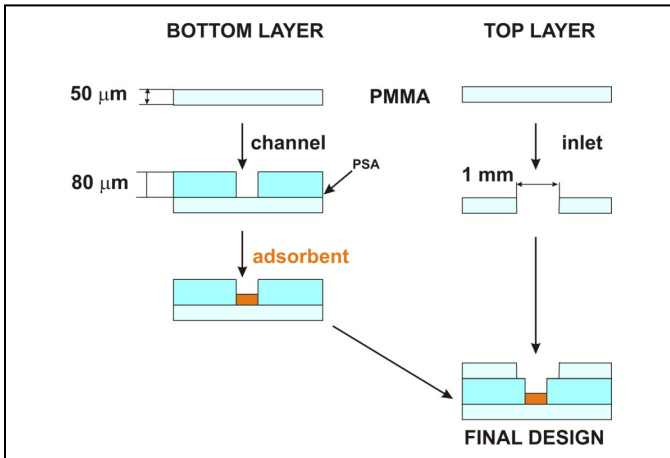

Figure 2. Schematic representation of the micro-chip fabrication;

The sensing area is a small patch of 1 x 1 mm with a pH sensitive dye, which varies in colour depending on the acid/base nature of the sweat moving along the micro-fluidic channel. Since human sweat generally lies in the region of pH 5-7, bromocresol purple has been chosen as it shows a colour change from yellow to blue over this pH range.

Figure 3 presents a picture of the micro-chip. Here in its acidic form the fabric patch is yellow. The green square is a reference patch used for video colour analysis. The sweat is drawn into the sensing area by an absorbent fiber placed at the end of the channel. The small dimensions of the device ensures the reduction in the physical scale of the system, and therefore smaller quantities of sweat are needed for analysis, which makes the device suitable for users with low sweat rate, and simultaneously improves the system response time [7]. The final device (180 μm thick) is flexible and can adapt easily to contours of the body.

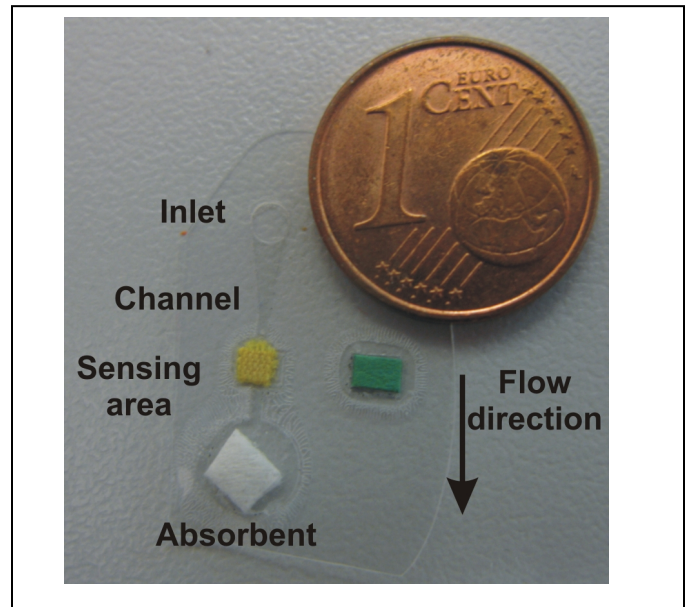

Figure 3. Picture of the micro-chip. The yellow spot is the sensing area and the green spot is the reference colour point.

## III. RESULT AND DISCUSSION

The micro-fluidic system was evaluated by calibration with buffer solutions at different pH's, Figure 4, using artificial sweat prepared according to the standard ISO 3160-2 (20 g/L NaCl, 17.5 g/L NH<sub>4</sub>OH, 5 g/L acetic acid and 15 g/L lactic acid).

The detection takes place by means of a surface mount photodiode and a light emitting diode (LED) placed above and below the sensing area. Black masking tape is used to position the LED and the photodiode and to block ambient light. The LED and photodiode were coated with clear silicone to ensure effective sealing from moisture during on-body trials. Light is attenuated as it passes through the sensing region depending on the pH of the sample.

LED and photodiode are controlled by a microcontroller (LilyPad Arduino) which is designed for wearable applications as it has pins that can be stitched to using conductive threads. The detected light signal was sampled by a 10-bit analog to digital (A/D) channel of an Xbee transceiver at a rate of 2Hz. Data was wirelessly transferred to an Xbee base-station connected to a laptop using a USB serial link, Figure 5.

The microfluidic device is protected from the external influence, like light, by a velcro belt.

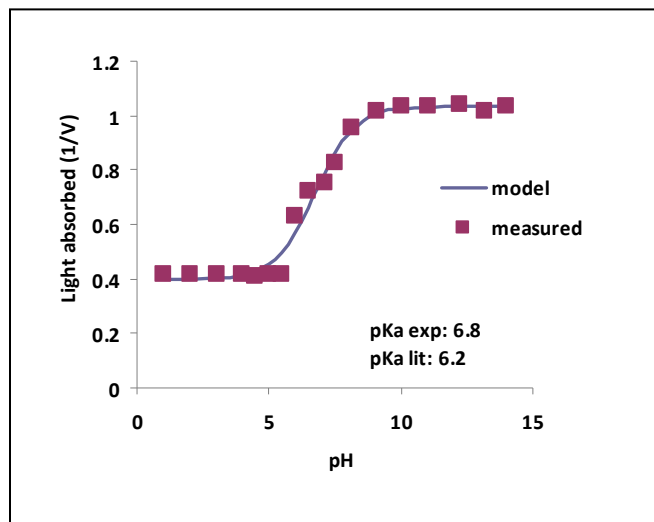

Figure 4. Calibration curve showing pH vs. light absorbed of bromocresol purple from the micro-fluidic device taken at each pH.

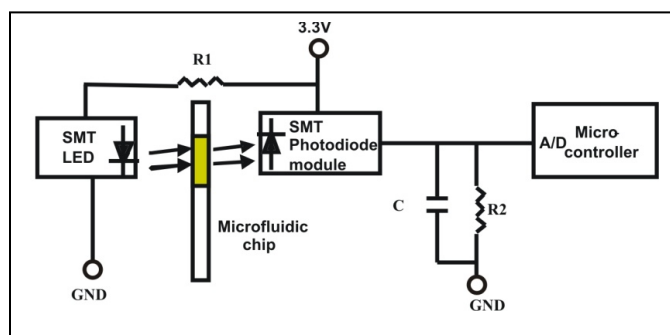

Figure 5. Circuit diagram for micro-fluidic pH sweat sensor.

The device was attached to the lower back using surgical tape during experimental trials as shown in Figure 6.

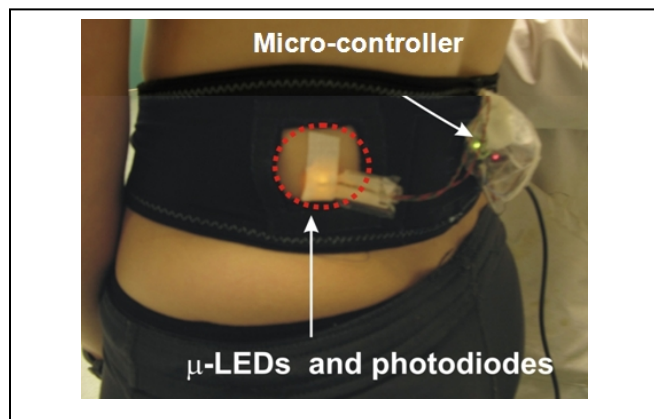

Figure 6. Sensor placed on the lower back during an exercise trial.

Sweat pH was monitored in real time, during a 45-minutes exercise training period, using the micro-fluidic device (Figure 7). This exercise trial involved indoor cycling at self selected pace. The pH reported by the device compared reasonably well with parallel reference measurements obtained with a commercial pH probe.

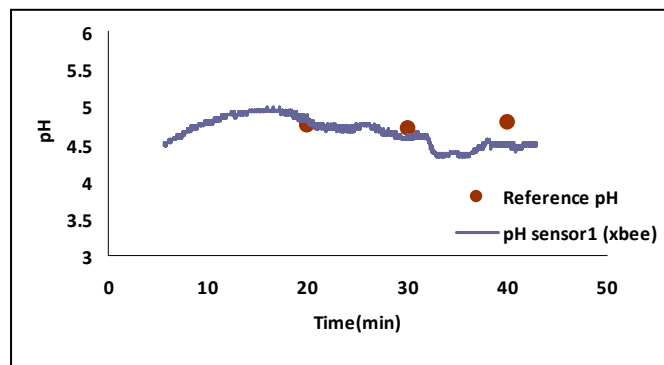

Figure 7. Circuit diagram for micro-fluidic pH sweat sensor.

#### IV. CONCLUSIONS

The micro-device acts as a self-indicating system for monitoring changes in sweat pH over time during exercise, giving immediate response to the individuals who are using it. Moreover, it measures the sweat pH from the point of emergence from the skin, drawing it into an enclosed package, which reduces errors arising from ingress by atmospheric CO<sub>2</sub>, and contamination by sweat emerging from other locations.

In addition, the device is flexible and comfortable to wear providing an unobtrusive and non-invasive method for the analysis of sweat during exercise.

#### ACKNOWLEDGMENT

This work is supported by Science Foundation Ireland under grant 07/CE/I1147 and the European Union (Biotex FP6-2004-IST-NMP-2). We thank Prof. Niall Moyna and Ms. Sarah Hughes for discussions and excellent assistance during body trials.

#### REFERENCES

- [1] S. Brady, L.E. Dunne, A. Lynch, B. Smyth, D. Diamond "Wearable Sensors - What is there to sense?", 'Studies in Health Technology and Informatics', 117, 80-88.
- [2] D. Diamond, S. Coyle, S. Scarmagnani, J. Hayes, "Wireless Sensor Networks and Chemo-/Biosensing", Chem.Rev., vol. 108, 652-679. 2008.
- [3] R. J. Maughan, S. M. Shirreffs, "Development of individual hydration strategies for athletes" Int. J. Sport Nutr. Exercise Metab., vol. 18, 5, 457-472, 2008.
- [4] R. Maughan, In Nutrition In Sport. Edited by Ronald J. Maughan. Malden, MA, Blackwell Science Ltd.
- [5] D. Morris, B. Schazmann, Y. Wu, S. Coyle, S/ Brady, C. N. Fay, J. Hayes, K. T. Lau, G. Wallace, D. Diamond, "Wearable Technology for Bio-chemical Analysis of Body Fluids During Exercise", IEEE Eng. Med. Biol. Soc., vol. 1-8, 5741-5744, 2008.

- [6] D. Morris, S. Coyle, Y. Wu, K. T. Lau, G. Wallace, D. Diamond, "Bio-sensing Textile Based Patch with Integrated Optical Detection System for Sweat Monitoring. *Sens. Actuators, B*; vol. 139, 231-236, 2009.
- [7] F. Benito-Lopez, S. Coyle, R. Byrne, A.F. Smeaton, N.E. O'Connor, D. Diamond, "Pump less wearable microfluidic device for real time pH sweat monitoring" *Procedia Chemistry*, vol. 1, 1, 1103-1106. 2009.