



RESEARCH ARTICLE

10.1002/2017JD026624

Key Points:

- Maximum 65 ppt ClNO₂ was recorded during nighttime in the low NO_x ground-based study, with up to 95 ppt measured on an airborne platform
- Vertical profiles of ClNO₂ showed elevated concentrations at the surface with a reduction after ~600 m in height
- Cl atom oxidation from ClNO₂ photolysis was generally insignificant for total oxidation

Supporting Information:

- Figure S1

Correspondence to:

T. J. Bannan and D. E. Shallcross,
thomas.bannan@manchester.ac.uk;
d.e.shallcross@bristol.ac.uk

Citation:

Bannan, T. J., Bacak, A., Le Breton, M., Flynn, M., Ouyang, B., McLeod, M., ... Percival, C. J. (2017). Ground and airborne U.K. measurements of nitryl chloride: An investigation of the role of Cl atom oxidation at Weybourne Atmospheric Observatory. *Journal of Geophysical Research: Atmospheres*, 122, 11,154–11,165. <https://doi.org/10.1002/2017JD026624>

Received 8 FEB 2017

Accepted 26 SEP 2017

Accepted article online 30 SEP 2017

Published online 19 OCT 2017

©2017. The Authors.

This is an open access article under the terms of the Creative Commons Attribution License, which permits use, distribution and reproduction in any medium, provided the original work is properly cited.

Ground and Airborne U.K. Measurements of Nitryl Chloride: An Investigation of the Role of Cl Atom Oxidation at Weybourne Atmospheric Observatory

Thomas J. Bannan¹ , Asan Bacak¹, Michael Le Breton¹ , Michael Flynn¹, Bin Ouyang², Matthew McLeod², Rod Jones², Tamsin L. Malkin³, Lisa K. Whalley^{3,4}, Dwayne E. Heard^{3,4} , Brian Bandy⁵, M. Anwar H. Khan⁶ , Dudley E. Shallcross⁶ , and Carl J. Percival^{1,7}

¹Centre for Atmospheric Science, School of Earth, Atmospheric and Environmental Science, University of Manchester, Manchester, UK, ²Department of Chemistry, University of Cambridge, Cambridge, UK, ³School of Chemistry, University of Leeds, Leeds, UK, ⁴National Centre for Atmospheric Science, School of Chemistry, University of Leeds, Leeds, UK, ⁵School of Environmental Sciences, University of East Anglia, Norwich Research Park, Norwich, UK, ⁶Biogeochemistry Research Centre, School of Chemistry, University of Bristol, Bristol, UK, ⁷Now at Jet Propulsion Laboratory, Pasadena, CA, USA

Abstract Nitryl chloride (ClNO₂) measurements from the Weybourne Atmospheric Observatory (WAO) are reported from March to April 2013 using a quadruple chemical ionization mass spectrometer with the I⁻ ionization scheme. WAO is a rural coastal site with generally low NO_x concentrations, a type of location poorly studied for ClNO₂ production. Concentrations of ClNO₂ exceeded that of the limit of detection (0.8 ppt) on each night of the campaign, as did concentrations of N₂O₅, which was also measured simultaneously with the Cambridge Broadband Cavity Enhanced Absorption Spectrometer. A peak concentration of 65 ppt of ClNO₂ is reported here. Vertical profiles of ClNO₂ from early- to middle-morning flights in close proximity to WAO are also reported, showing elevated concentrations at low altitude. The photolysis of observed ClNO₂ and a box model utilizing the Master Chemical Mechanism modified to include chlorine chemistry was used to calculate Cl atom concentrations. This model utilized numerous VOCs from the second Tropospheric Organic Chemistry project in 2004, at the same location and time of year. From this the relative importance of the oxidation of three groups of measured VOCs (alkanes, alkenes, and alkynes) by OH radicals, Cl atoms, and O₃ is compared. Cl atom oxidation was deemed generally insignificant at this time and location for total oxidation due to the much lower concentration of ClNO₂ observed, even following the night of greatest ClNO₂ production.

1. Introduction

Oxidation reactions in the troposphere govern the fate of primary trace gaseous pollutants and have an important influence on air quality and climate (Prinn, 2003). Recent studies have shown that Cl atoms from photolysis of nitryl chloride (ClNO₂) may contribute significantly to the total oxidizing capacity (Bannan et al., 2015; Osthoff et al., 2008; Phillips et al., 2012; Tham et al., 2014). Cl atoms are highly reactive toward VOCs, and rate coefficients for reactions with alkanes are generally 2 orders of magnitude larger than OH. Calculations show that Cl atoms from ClNO₂ photolysis were an important oxidiser in London during the summer ClearLo campaign where a maximum value of 724 ppt of ClNO₂ was observed with mean nighttime concentration of 84 ppt (Bannan et al., 2015). In that study calculations showed that Cl was responsible for up to 11% of alkane oxidation, 10% of alkyne oxidation, and was generally insignificant in terms of alkene oxidation. Tham et al. (2014) also showed that Cl production from ClNO₂ photolysis exceeded that of OH production from O¹(D) by a factor of 3 in the morning, thus having a significant influence on photochemistry during this period. Cl-induced oxidation may have a more significant global influence than initially considered, often enhancing tropospheric ozone production (Sarwar et al., 2012, 2014; Simon et al., 2009).

Heterogeneous reaction of N₂O₅ and chloride containing aerosol was first shown in laboratory to produce ClNO₂ by Finlayson-Pitts et al. (1989), and recently, field measurements in both continental and polluted coastal sites have reported concentrations ranging between a few ppt and 4 ppb (Bannan et al., 2015; Kercher et al., 2009; Mielke et al., 2013, 2015, 2011; Osthoff et al., 2008; Phillips et al., 2012; Riedel et al., 2012; Tham et al., 2014; Thornton et al., 2010; Wang et al., 2016). Global modeling studies of ClNO₂ have now shown the importance of this species with one area of predicted high production being western Europe, especially in the winter months (Sarwar et al., 2014).

As well as being a source of reactive Cl atoms, ClNO₂ production also alters the lifetime of NO_x by reducing the production of nitric acid in favor of ClNO₂ production. ClNO₂ acts to recycle the NO_x in comparison with nitric acid production that is regarded as a terminal sink (Finlayson-Pitts et al., 1989). Therefore, it is important to measure nitric acid in conjunction with N₂O₅ and ClNO₂ so that the efficiency of the production of ClNO₂ can be compared. The release of NO_x from ClNO₂ has a potentially significant effect on tropospheric ozone production in the early morning (Riedel et al., 2014), with up to 22% of NO_x cycling coming from this source alone (Osthoff et al., 2008). This may have significant implications in regions where local emissions of NO_x are minimal, an example being a remote coastal site.

As well as spatially limited ground-based measurements, with only two reported measurements in Europe (Bannan et al., 2015; Phillips et al., 2012), there are also very limited airborne data other than Young et al. (2012). Vertical profiles presented from the Los Angeles Basin show a relatively constant concentration between approximately 1 and 2 ppb within the nocturnal boundary layer (Young et al., 2012). Cl activation is less well understood in low NO_x conditions (Lawler et al., 2011) such as those that would be expected in a rural marine environment. Hence, measurements in locations including Weybourne are imperative.

In order to assess the impact that ClNO₂ has on tropospheric chemistry around the UK, measurement campaigns were set with the aim of measuring ClNO₂, N₂O₅, and other species influencing their production using a quadrupole chemical ionization mass spectrometer (CIMS). The first new set of measurements were made during a 3 week deployment at the Weybourne Atmospheric Observatory (WAO), a remote coastal site in Norfolk, and this was made in conjunction with the Cambridge Broadband Cavity Enhanced Absorption Spectrometer (BBCEAS) that measures N₂O₅ (Kennedy et al., 2011). Nitric acid, among other species, was concurrently measured with CIMS. Aircraft measurements using CIMS on board the BAe-146 research aircraft in fairly close proximity to the WAO were made also in order to provide insight into the vertical profiles of these species around this location. As in Bannan et al. (2015) study the effect that Cl from the photolysis of ClNO₂ has on the total tropospheric oxidizing capacity at WAO is evaluated.

2. Measurement Locations and Analytical Techniques

2.1. Weybourne Atmospheric Observatory

The Weybourne site is situated on the North Norfolk Coast (52.950490°N, 1.122017°E) around 150 m from the shoreline of the North Sea and more than 1 km away from the nearest small town of Weybourne. The site details are described in detail in Penkett et al. (1999). Plumes of polluted air masses from the UK and continental Europe are common with influence from the Arctic also observed, thus indicating the wide variety of air masses that can be sampled at this site. Between 14 March 2013 and 4 April 2013, an intensive observation period was undertaken where the CIMS and BBCEAS ran an intercomparison study at this site. NO_y at this site is measured by the Thermo Fisher Model 42i (NO-NO₂-NO_x) analyzer and O₃ is measured by the Thermo Fisher Model 49i ozone analyzer.

2.2. BAe-146 Airborne Measurements

Research flight B822 was undertaken on 1 January 2014, taking off from Cranfield Airport. The flight track took was first to the North Norfolk Coast at an altitude of 3,000 m, and once the coastline was reached low level runs to 30.5 m were made so that altitude profiles could be obtained. All low level runs were over the North Sea in close proximity to the East Anglian coastline.

2.3. Chemical Ionization Mass Spectrometry

A chemical ionization mass spectrometer (CIMS) was used to make measurements of ClNO₂ and N₂O₅, at 1 Hz frequency for all groups of measurements. The Manchester ground CIMS as described by Bannan et al. (2014, 2015) was used for ground-based measurements, and the Manchester flight CIMS as described by Le Breton et al. (2014) and Jones et al. (2014; 2017) was utilized for airborne measurements on board the Facility for Airborne Atmospheric Measurements (FAAM) British Aerospace 146 (BAe-146) research aircraft.

Both CIMS instruments were constructed and designed by the Georgia Institute of Technology and have been described in detail by Nowak et al. (2007), see also the schematic of Figure 1 for the ground CIMS and Figure 2 for the aircraft CIMS. Briefly, the CIMS detects trace gases in the atmosphere by selectively ionizing specific molecules and then detecting ions using mass spectrometry (Nowak et al., 2007).

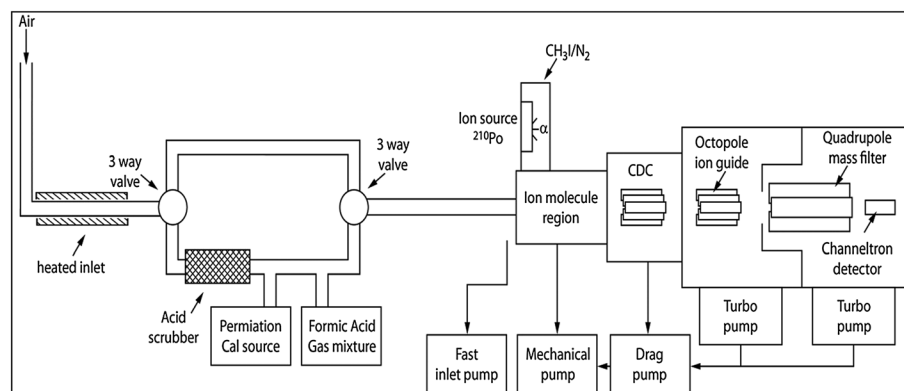

Figure 1. Schematic of the Manchester ground CIMS instrument.

The airborne measurements were made with the exact methods as described by Le Breton et al. (2014) and Jones et al. (2014, 2017). The procedures used to make the ground-based measurements with the CIMS are identical to that reported in Bannan et al. (2015) other than the inlet design. At the Weybourne atmospheric observatory there is a permanent 10 m high glass inlet with a diameter of approximately 30 cm. The flow rate within this inlet was in excess of 200 standard liters per minute (slm), from which we subsampled 18 slm by the use of the fast inlet pump illustrated in Figure 1. The glass inlet was chosen to make these measurements due to the high flow rate, and large volume of air sampled to surface area ratio in order to minimize possible surface reactions. The 3/8" PFA connection between the glass inlet and CIMS was heated to 40°C, roughly 30 cm in length and was regularly changed (approximately every 2 days).

2.3.1. Calibrations, Sensitivity, and Limit of Detection of the CIMS

The ion molecule chemistry using iodide ions (I^-) to detect N_2O_5 as NO_3^- ($m/z = 62$) has been described in detail by Le Breton et al. (2014) and was also employed for measurements of N_2O_5 in this study. $ClNO_2$ was measured at the mass $IClNO_2$ ($m/z 207.9$) as in Osthoff et al. (2008) and Bannan et al. (2015). Studies such as Wang et al. (2014) and Veres et al. (2015) have noted that measurements of N_2O_5 at $m/z 62$ are not

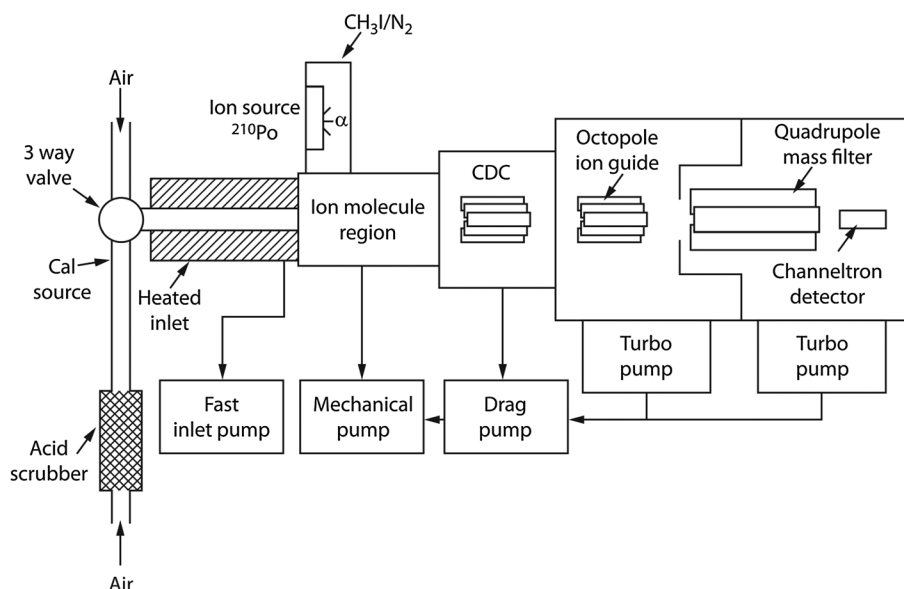

Figure 2. Schematic of the Manchester flight CIMS instrument.

interference free, with HNO_3 and HO_2NO_2 being identified as key species that could cause interference. Possible interferences from HNO_3 at both atmospherically relevant and very high concentrations m/z 62 have been extensively studied in the laboratory, and no evidence for this has been observed. Possible interferences from PAN or HO_2NO_2 at m/z 62 have not been specifically checked for this work; however, both absolute concentrations and time series against the BBCEAS show a good agreement in N_2O_5 measurements in past intercomparisons (Le Breton et al., 2014) and this study. Such interferences are therefore not deemed important in here.

Final calibration of the CIMS was completed post campaign for both N_2O_5 and ClNO_2 , relative to formic acid, which was calibrated and measured throughout the campaign. This is completed assuming the ratio between formic acid and ClNO_2 sensitivity remains constant throughout. Procedures for calibrations and determination of backgrounds for N_2O_5 and ClNO_2 are described in detail by Bannan et al. (2015). Calibration of N_2O_5 was completed by flowing dry N_2 over solid purified N_2O_5 into the CIMS and a NO_x analyzer (Thermo Fisher, model 42i NO- NO_2 - NO_x Analyzer), with the concentration determined by the stoichiometric ratio of $\text{NO}_2:\text{N}_2\text{O}_5$, in R5. There have been reported instances where NO_3 is sensitive on the NO_x analyzer, thus having the potential to influence the concentrations of N_2O_5 that are reported in this study. However, numerous intercomparisons with the BBCEAS, including this and the Le Breton et al. (2014) study, show that this calibration method works well, producing very good agreements in total concentrations reported, in part due to the high purity of N_2O_5 that was synthesized. The possible interference of NO_y on the NO_x analyzer is therefore not deemed important in terms of our reported concentrations. ClNO_2 was produced by flowing a known concentration of N_2O_5 in dry N_2 through a wetted NaCl scrubber. Conversion of N_2O_5 to ClNO_2 can be as efficient as 100% on sea salt, but it can also be lower, for example, if ClNO_2 were to convert to Cl_2 (Roberts et al., 2008). For NaCl the conversion efficiency has however been as low as 60% (Hoffman et al., 2003). In this calibration we have followed the accepted methods of Osthoff et al. (2008) and Kercher et al. (2009) that show a conversion yield of 100% and have assumed this yield in the calibrations of this study.

For the Weybourne measurement campaign the sensitivity of ClNO_2 was determined to be 3.9 counts ppt^{-1} , and for N_2O_5 15.9 counts ppt^{-1} is reported. The 3σ ClNO_2 LOD during the summer Weybourne campaign was 0.8 ppt and the 3σ LOD of N_2O_5 was 1.5 ppt. For the airborne measurements a sensitivity of 33 and 650 counts ppt^{-1} is reported with a 3σ LOD of 4 and 2 ppt for ClNO_2 and N_2O_5 , respectively. Using the error in the individual slope of the calibrations results in a total uncertainty of 30% for both N_2O_5 and ClNO_2 .

As described in Bannan et al. (2015) no normalization was required for N_2O_5 or ClNO_2 as the I^- (mean = 1.6×10^6 cps, standard deviation = 2.8×10^4 cps) and $\text{I.H}_2\text{O}^-$ (mean = 7.7×10^5 counts per second (cps), standard deviation = 3.2×10^4 cps) cps were well in excess of what is required for N_2O_5 and ClNO_2 to be independent to the small changes (<5%) in the reagent ions that were observed throughout the campaign.

The CIMS produced 1 Hz data from sampling and calibration cycles that were averaged to 30 s. Correlation with meteorological data was completed with 5 min averaged data for the ground-based campaign. Throughout the Weybourne Campaign automatic hourly mass scans were utilized in order to give a complete mass spectrum between 0 and 300 amu.

2.4. Filter Sampling

Filter samples were run at a 24 h time resolution using a high-volume sampler at a flow rate of 1 m^3 per minute. Conductively coupled plasma optical emission spectrometry (ICP-OES) was used to measure the total chloride deposited on the filter over the 24 h period.

2.5. Master Chemical Mechanism Model Runs

A zero-dimensional Facsimile box model was employed to calculate Cl atom concentrations during the campaign so that the rate of oxidation of VOCs by Cl atoms can be compared with oxidation by modeled OH (which compared well to OH observed during second Tropospheric ORganic CHEMistry (TORCH 2)) and measured ozone. The model was constrained to pressure, temperature, ClNO_2 , N_2O_5 , O_3 , SO_2 , NO, NO_2 , and HNO_3 from the field measurement made in March 2013 combined with VOC data and adapted photolysis rates measured from TORCH 2 (April–May 2004) at the same location (WAO). The TORCH 2 VOC data were representative of the time of year. It was also from an intense measurement campaign and gave measurements

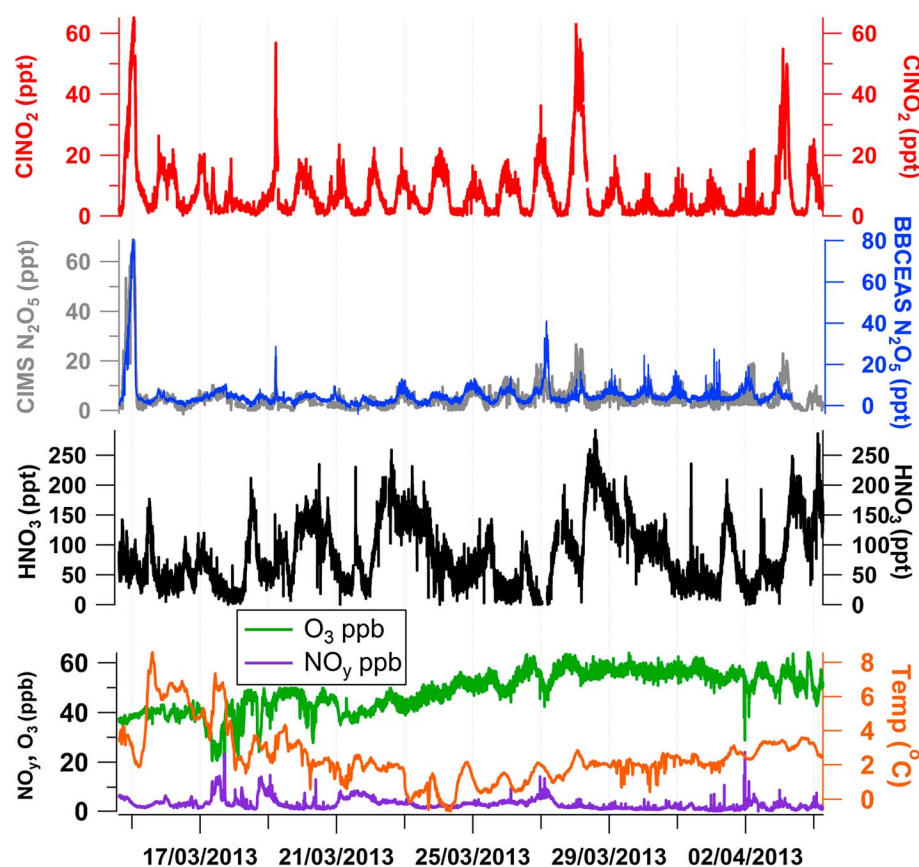

Figure 3. Time series of ClNO_2 , N_2O_5 , and HNO_3 from the Manchester ground CIMS, N_2O_5 from the BBCEAS for the complete Weybourne campaign. NO_y , O_3 , and temperature are also shown.

of 27 different C2–C10 nonmethane hydrocarbons and C2–C4 oxygenated volatile organic compounds. This allows for a more comprehensive estimate of the oxidation capacity of Cl, OH, and O_3 . The photolysis rates of key species were first calculated under clear-sky conditions and then compared with those measured in TORCH 2 to obtain a scaling factor for March 2013J(ClNO_2) was calculated using the Tropospheric Ultraviolet and Visible Radiation Model, version 4.1, neglecting any upwelling radiation, and then scaled in order to match the measured $J(\text{NO}_2)$ as has been used in previous studies such as Stone et al. (2010). Measurements of downwelling actinic flux as a function of wavelength across the full actinic range were made using a $2\text{-}\pi$ solid angle detection spectral radiometer (Edwards & Monks, 2003). The photolysis frequency for NO_2 was calculated from these measurements using laboratory data for NO_2 absorption cross sections, and photodissociation quantum yields to generate $\text{O}(^3\text{P})$ atoms.

The box model used to calculate Cl atom concentrations during the campaign contained a subset of the Master Chemical Mechanism v3.2 (Jenkin et al., 2012), including the Cl atom oxidation of seven measured alkanes (C1–C8). As previously reported in Bannan et al. (2015) the Master Chemical Mechanism (MCM) does not contain a mechanism for the Cl atom initiated oxidation of alkenes (C2–C5) or alkynes (acetylene). Reactions of Cl atoms with these measured species were added to MCM v3.2 mechanism using rate coefficients taken from the National Institute of Standards and Technology (NIST) database (Manion et al., 2014). For H-atom abstraction channels the reported yield was used to generate HCl, but for other channels the reaction was treated as a simple loss for Cl atoms.

The model does not contain an inorganic mechanism for chlorine, so similar chemistry reported by Riedel et al. (2012) and utilized in the box model of Bannan et al. (2015) was included (R1–R9).



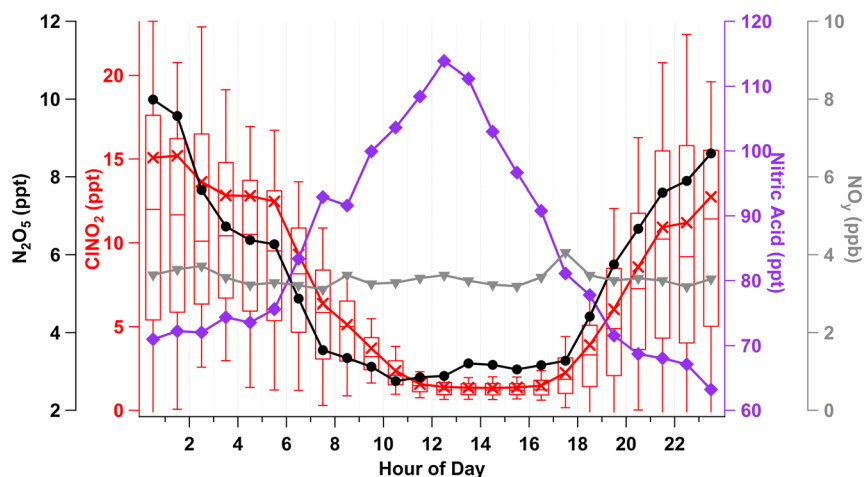
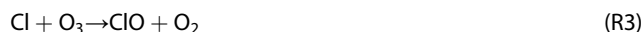

Figure 4. Average diurnal cycle of N₂O₅, ClNO₂, NO_y, and HNO₃ for the complete Weybourne campaign.



Two models were developed: one constrained to the measured ClNO₂ data with additional chlorine reactions and a chemically identical model without any Cl sources (hence, Cl atom concentrations were zero). This way a comparison was made between the rate of oxidation of VOCs by Cl atoms with the rate of oxidation by modeled OH and measured ozone.

The only source of Cl atoms considered in the model was the initial photolysis of ClNO₂, and hence, HCl and other gas-phase inorganic Cl species in the reaction mechanism described previously are only generated by

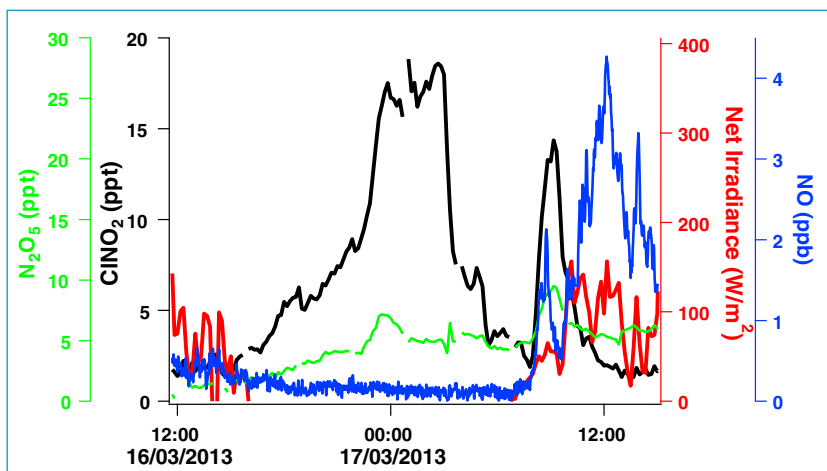

Figure 5. Postsunrise peaks of ClNO₂ on the morning of 17 March. Black trace indicates ClNO₂ concentration, and red shows solar radiation. Green shows N₂O₅ from the CIMS, and blue shows NO.

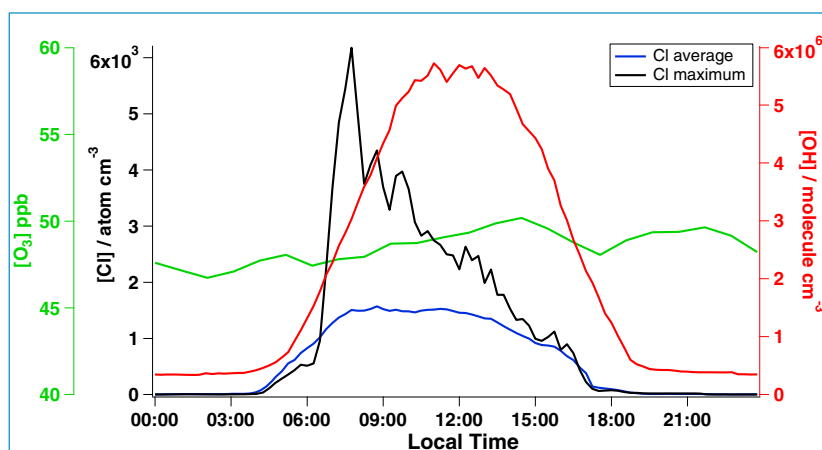

Figure 6. Cl atom concentration profile calculated for 15 March 2013 (black), during which the maximum observed concentration of ClNO₂ was observed, Cl atom concentration profile calculated as an average for the entire campaign (blue), and the modeled OH concentration averaged for the TORCH 2 campaign (red). The 2013 campaign averaged measured O₃ concentration is also included (green).

the model with an assumed initial concentration of zero. Chlorine atom concentrations were then calculated by the box model using a Facsimile integrator (Curtis & Sweetenham, 1987) and constrained with measured concentrations of VOCs, pressure, temperature, ClNO₂, N₂O₅, O₃, SO₂, NO, NO₂ and HNO₃, and photolysis frequencies with a time step of 900 s. Additional details regarding the box model methodology can be found in Whalley et al. (2010). For all unconstrained modeled intermediates a first-order loss rate (*k*) was included. This loss rate varied as a function of the average measured boundary layer height, *h*, from TORCH 2 ($k = V_d/h$), where *V_d* represents a deposition velocity that was taken to be equal to 1 cm s⁻¹ for all of the model-generated species. The average measured boundary layer height was varied within the model from 300 m at night increasing to 1,300 m in the morning as the boundary layer collapses and 1,800 m in the afternoon. The boundary layer was measured by vertical wind profile data from the Universities' Facility for Atmospheric Measurement's 1290 Megahertz (MHz) Degreane Mobile Wind Profiler.

3. Results and Discussion

3.1. Ground ClNO₂ Measurements

The complete time series of ClNO₂, N₂O₅, and HNO₃ as measured by CIMS are shown in Figure 3 for the Weybourne Campaign. ClNO₂ and N₂O₅ exceeded the limit of detection on every night of the measurement campaign during nighttime hours. A mean nighttime (sunset-sunrise) ClNO₂ concentration of 10.5 ppt was observed with a maximum peak of 65 ppt. The peak concentration of N₂O₅ is similar to that of ClNO₂ at

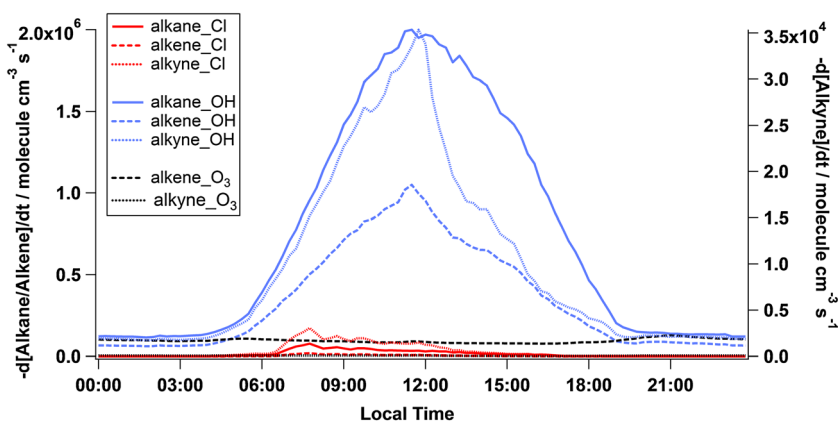

Figure 7. Rate of removal of alkanes, alkenes, and alkynes by reaction with the oxidants OH (modeled), O₃ (measured, campaign average), and Cl atoms calculated for 15 March 2013, when the calculated Cl atom concentration was at its maximum.

Table 1

Relative Importance of Cl, OH, and O₃ to the Oxidation of Three Groups of VOCs From Both London Average and Maximum (Bannan et al., 2015) and the Weybourne Average and Maximum

	London (max)	London average	Weybourne (max)	Weybourne average
Alkane Cl%	14.46	3.51	1.85	0.98
Alkane OH%	85.54	96.49	98.15	99.02
Alkane O ₃ %	-	-	-	-
Alkene Cl%	2.64	0.62	0.69	0.35
Alkene OH%	76.33	77.92	77.98	78.25
Alkene O ₃ %	21.03	21.46	21.32	21.39
Alkyne Cl%	24.95	6.96	4.99	2.58
Alkyne OH%	74.04	91.97	94.28	96.67
Alkyne O ₃ %	1.01	1.25	0.73	0.75

Note. VOC concentrations data used for the calculations for London are included as well as for Weybourne, using measured VOC data.

68.5 ppt, on the same night as the maximum ClNO₂; but the mean nighttime peak is lower at 6.7 ppt. A time series of measured chloride from filter sampling at a 24 h time resolution is presented in Figure S1.

Measured results are substantially lower than that of other reported U.K. measurements of ClNO₂ in London (Bannan et al., 2015), where a mean nighttime ClNO₂ concentration of 84 ppt was observed, together with a median value of 34 ppt and a maximum peak of 724 ppt. This seems to have been mainly caused by significantly higher NO₃ production rate (7.8×10^{-6} molecules cm⁻³ s⁻¹) in London than those in Weybourne (3.5×10^{-6} molecules cm⁻³ s⁻¹) because of the higher NO_x (~13 ppb) levels in London compared with that (~3 ppb) in Weybourne. A campaign high N₂O₅ concentration in Weybourne was ~67 ppt, as measured by the CIMS, also significantly lower than that reported for London. Intercomparison between the CIMS and BBCEAS for N₂O₅ measurements is presented in Figure 3. The R² of the relation of the CIMS to BBCEAS N₂O₅ measurements is 0.8 ([N₂O₅] CIMS = 1.06 × [N₂O₅] BBCEAS + 0.81 pptv), which can be compared with the airborne measurements of Le Breton et al. (2014) showing the reliability of the measurements made.

Comparable to the measurements in Bannan et al. (2014), a very obvious diurnal profile was observed in the ClNO₂ throughout that is representative of this species (Kercher et al., 2009; Mielke et al., 2011; Osthoff et al., 2008; Thornton et al., 2010). Concentrations of ClNO₂ above the limit of detection were measured, on average, until 11 A.M. and then built up following sunset. ClNO₂ concentrations peak, on average, at 15.1 ppt and drop below the LOD at approximately midday (Figure 4). As in the Bannan et al. (2015) study, photolysis rates and lifetimes have been calculated for each night of the measurement campaign. During the London campaign an average lifetime of 2.6 h, with respect to photolysis, was calculated. In Weybourne a very similar lifetime of 2.5 h was calculated, despite the seasonal difference. Both lifetimes with respect to photolysis are in range of the values presented by Ganske et al., (1992) (0.73–31 h, depending on solar zenith angle) and Ghosh et al. (2011). The average diurnal profile of N₂O₅ is similar to that of ClNO₂. The exception to this trend is seen in the nitric acid average diurnal trend where a daytime maximum is seen. This is as would have been expected based on nitric acid production pathways.

However, there are exceptions to the diurnal trend of ClNO₂ where morning peaks were observed, such as on 17 March (Figure 5). This is analogous to that reported in Bannan et al. (2015) where concentrations rose up to 140 ppt following sunrise. In Weybourne the daytime peak increased to a comparatively lower concentration of 15 ppt but was still significant relative to the concentrations seen at this measurement site. At the time of increased ClNO₂ during the morning of 17 March there was a very slight increase in N₂O₅, approximately 2 ppt, which was not observed in the BBCEAS time series, potentially suggesting a sensitivity change in the CIMS at this time. However, other masses such as HCN (*m/z* 154) and nitric acid (*m/z* 189.9) that were simultaneously measured with the CIMS did not show this

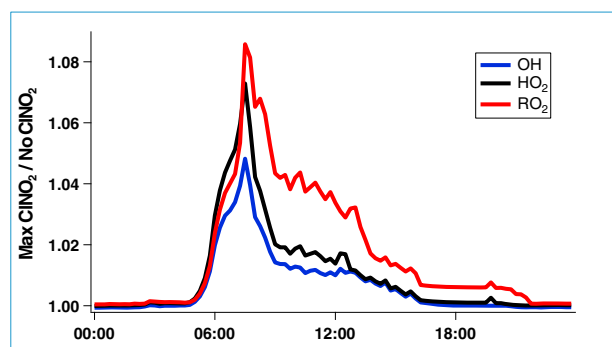

Figure 8. Enhancement of OH, HO₂, and RO₂ species observed from addition of the chemical oxidation reactions using the maximum calculated [Cl].

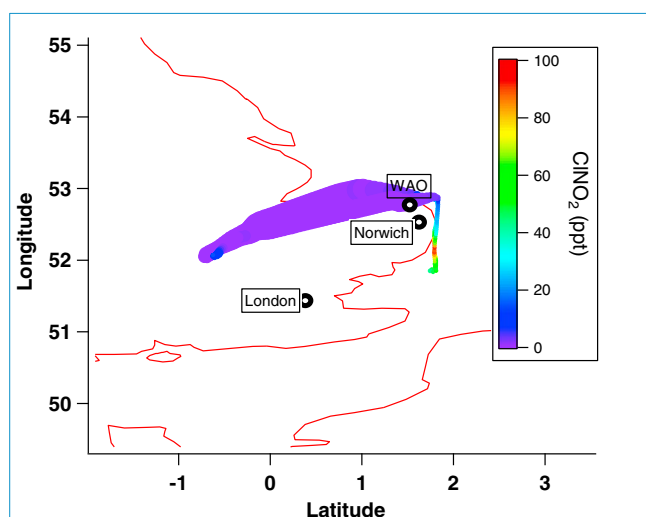

Figure 9. The FAAM BAe146 flight track on 8 January 2014 around East Anglia and its surrounding coastline. ClNO₂ mixing ratios are color coded from 0 ppt to 80 ppt.

trend, and we are therefore unsure of the source of discrepancy between BBCEAS and CIMS.

The timing of the enhancement seen in ClNO₂ correlates well with the largest NO concentration observed (up to ~2 ppb) during the measurement period (Figure 5). NO, an indicator of anthropogenic activity, increased significantly at this time indicating that a change in air mass that was being measured at the site was one with a possible urban origin. Enhancement of NO_x species from an urban environment could enhance N₂O₅ production and when mixed with chloride containing aerosol produce relatively large concentrations of ClNO₂ at this site.

Given that the average lifetime of ClNO₂ was calculated to be 2.5 h (i.e., a loss rate of $3.57 \times 10^{-4} \text{ s}^{-1}$), should the loss rate be the same as measured at the surface, a concentration of 309 ppt would have been required to see such a peak at 9:20 A.M., over 4 h after sunrise on 17 March. There are other examples, including 23 and 25 March as well as at the final day of sampling on 4 April where there is a small enhancement following sunrise but none as defined at 17 March. Of these exam-

ples it is only 17 March where a correlation with enhancing NO is observed. It is therefore possible that the early-morning enhancements could also be due to mixing down of ClNO₂ from an elevated layer, resulting in a peak in mixing ratios as surface level.

On all days where a ClNO₂ concentration enhancement was observed following sunrise, the wind direction originated from the ocean possibly indicating that production over the ocean, especially on the shore where waves are creating the particulate chloride aerosol, is more efficient. However, there are also days where the wind direction is from the sea and no daytime enhancement is observed. The height of the marine boundary layer is a parameter that was not measured throughout the campaign, but the varying height of this may have had an effect on these daytime increased in ClNO₂ concentrations.

3.2. Implications for VOC Oxidation at WAO

As in the Bannan et al. (2015) study the total rate of removal of alkanes, alkenes, and alkynes by reaction with the oxidants OH, O₃, or Cl atoms at a given time during the campaign was calculated using

$$-d[\text{alkanes}]/dt = [X] \sum_j k_{X+\text{alkane},j} [\text{alkane}, j] \tag{1}$$

$$-d[\text{alkenes}]/dt = [X] \sum_j k_{X+\text{alkene},j} [\text{alkene}, j] \tag{2}$$

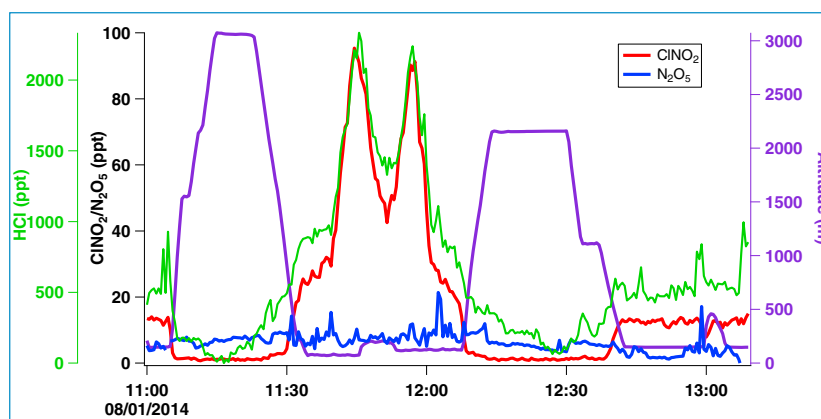

Figure 10. Time series of 30 s averaged ClNO₂, N₂O₅, and HCl observations (left axis) with altitude (right axis) from 8 January 2014 flight.

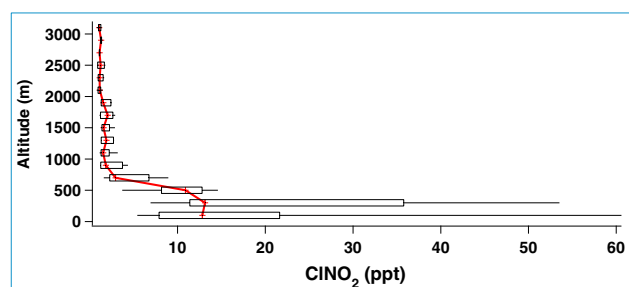

Figure 11. Altitude profile of ClNO_2 from measurements around East Anglia and its surrounding coastline.

$$-d[\text{alkynes}]/dt = [X]\sum_i k_{X+\text{alkyne},i}[\text{alkyne},i] \quad (3)$$

where $[X]$ is the concentration of modeled OH, measured O_3 , or the calculated one of Cl atoms using the MCM at a given time in the campaign, and $[\text{alkane},i]$, $[\text{alkene},i]$, and $[\text{alkyne},i]$ represent the corresponding measured speciated concentration of each alkane, alkene, and alkyne, and k_X is the individual bimolecular rate coefficient for the reaction of X with each species at the measured pressure and temperature. Rate coefficients were taken from those used in the MCM (Jenkin et al., 1997; Saunders et al., 2003) or from the NIST database (Manion et al., 2014). Two model runs were performed using this method, one with the maximum Cl atom production following the greatest night of ClNO_2 production (65 ppt) and the other using the

average diurnal variation of ClNO_2 . A baseline model was also run without the Cl chemistry being included in order to show the effect of the inclusion of Cl chemistry has to the RO_2 production and consequently O_3 production following a night of ClNO_2 production.

For both runs the campaign averaged diurnal concentrations for O_3 at the time of the ClNO_2 measurements were integrated with modeled OH and VOCs measurements from TORCH 2 to calculate the rates of oxidation. The measured O_3 concentration from this study, modeled OH concentration, and the average and maximum Cl atom concentration calculated using the MCM from ClNO_2 photolysis are shown in Figure 6.

Figure 6 shows that, as would have been expected and in agreement with other studies of this type, calculated Cl atom concentrations rise rapidly after sunrise (5 A.M. local time). For 15 March 2013, concentrations reached 6×10^3 atoms cm^3 , which is about 5 times lower than the maximum calculated for London and just under 1,000 times lower than the modeled peak concentration of OH. As in Bannan et al. (2015) study although ClNO_2 concentrations in this study are very low by noon, Cl atoms are recycled via reactions (R1–R9) and do not reach zero again until later in the afternoon.

The chemical turnover rates for the oxidation of the sum of measured alkanes, alkenes, and alkynes by reaction with OH, O_3 , or Cl atoms, as calculated by equations (1)–(3), are shown in Figure 7 for 15 March, when Cl atoms peaked. By summing the oxidation rate across this 24 h period shown in Figure 7 (maximum Cl concentration), the total percent removed by reaction with the three oxidants for each type of VOC was calculated (Table 1). The relative importance of Cl from ClNO_2 in terms of total oxidation at this site is negligible and much less important in comparison with the London study. This is also reflected in the amount of extra RO_2 , which at maximum is only 9% higher at 7:30 A.M., with only very little increase in HO_2 (7%) and OH (5%) concentrations, even following the night of greatest ClNO_2 production (Figure 8). This shows that ClNO_2 is generally insignificant in terms of the oxidation capacity at this site and time.

3.3. Airborne ClNO_2 Measurements

ClNO_2 concentrations and the flight altitude for the FAAM BAe-146 B822 flight around the East Anglian coast are illustrated in Figure 9. Figure 10 shows the flight track, altitude of measurement, and ClNO_2 , N_2O_5 , and HCl concentrations throughout the complete flight. There are no NO_x data available for this flight. The time series shows that a peak concentration of 95 ppt of ClNO_2 was observed, with Figure 11 showing the vertical profile of these species. Figures 9–11 show much elevated ClNO_2 concentrations close to the sea surface, reaching very low concentrations above 500 m in altitude. The altitude profile presented here is similar to that of Young et al. (2012), in that the highest concentrations were observed at the surface with a reduction in concentration seen after approximately 600 m in height. Altitude profiles of ClNO_2 in Young et al. (2012) were only reported between 0–1000 m and did not include measurements of N_2O_5 or other species.

The time of measurements for B822 should be noted. Concentrations of ClNO_2 up to 95 ppt were measured above the sea surface up to midday, suggesting that nighttime concentrations of this species, in a region with a large amount of ship activity and surrounding land emissions, and thus high NO_x emissions, would have been significant. Daytime peaks have already been observed in this region as illustrated in Figure 5. Very

small concentrations of N_2O_5 were observed during the flight, with only very small spikes being observed throughout, suggesting a shorter lifetime in conjunction with possibly a lower concentration of N_2O_5 during the flight.

There are two major peaks in ClNO_2 observed in this flight, Figure 10, both of which are taken in a very similar location and altitude as the return flight track mirrored the outbound (Figure 10). The first peak is observed at 11:44:30 A.M. where a peak concentration of 95 ppt was measured, and on the second leg at 11:57:30 A.M., 91 ppt was observed. The loss rate of ClNO_2 calculated, assuming the same parcel of air was sampled, resulted in a lifetime of 4.8 h, about 50% slower than that of the average calculated from the Weybourne campaign.

4. Conclusions

Concentrations of up to approximately 70 ppt of ClNO_2 have been measured simultaneously with N_2O_5 at the Weybourne Atmospheric Observatory between 14 March 2013 and 4 April 2013. An intercomparison with the Cambridge BBCEAS instrument for N_2O_5 measurements against the CIMS at m/z 62 reveals very good agreement in both trends and reported concentrations from independent calibrations, again revealing the reliability of this method. The diurnal profile of both measured ClNO_2 and N_2O_5 are similar to previous measurements (e.g., Osthoff et al., 2008), but early-morning elevations of ClNO_2 are observed in this study. This daytime elevation is consistent with a change in air mass as depicted by a sharp increase in NO at the same time and likely not daytime production of this species. Vertical profiles of ClNO_2 have also been reported here on board the Bae-146 research aircraft, showing much elevated concentrations at the surface of the East Anglian Coast.

Acknowledgments

This work was supported by NERC (NE/H003193/1 and NE/K004905/1). The data presented in this paper are stored at the British Atmospheric Data Centre (http://data.ceda.ac.uk/badc/deposited2017/cims_at_veybourne/data; <http://data.ceda.ac.uk/badc/faam/data/2014/b822-jan-08/non-core/>).

References

- Bannan, T. J., Bacak, A., Muller, J., Booth, A. M., Jones, B., Le Breton, M., ... Percival, C. J. (2014). Importance of direct anthropogenic emissions of formic acid measured by a chemical ionisation mass spectrometer (CIMS) during the Winter ClearLo Campaign in London, January 2012. *Atmospheric Environment*, 83, 301–310.
- Bannan, T. J., Booth, A. M., Bacak, A., Muller, J. B. A., Leather, K. E., Le Breton, M., ... Percival, C. J. (2015). The first U.K. measurements of nitril chloride using a chemical ionisation mass spectrometer in London, ClearLo Summer, 2012, and an investigation of the role of Cl atom oxidation. *Journal of Geophysical Research*, 120, 5638–5657.
- Curtis, A. R., & Sweetenham, W. P. (1987). FACSIMILE/CHEKMAT users manual. Rep. AERER12805, Her Majesty's Stn. Off., Norwich, England.
- Edwards, G. D., & Monks, P. S. (2003). Performance of a single-monochromator diode array spectroradiometer for the determination of actinic flux and atmospheric photolysis frequencies. *Journal of Geophysical Research*, 108(D16), 8546.
- Finlayson-Pitts, B. J., Ezell, M. J., & Pitts, J. N. (1989). Formation of chemically active chlorine compounds by reactions of atmospheric NaCl particles with gaseous N_2O_5 and ClONO_2 . *Nature*, 337(6204), 241–244.
- Ganske, J. A., Berko, N., & Finlayson-Pitts, B. J. (1992). Absorption cross sections for gaseous ClNO_2 and Cl_2 at 298K: Potential organic oxidant source in the marine troposphere. *Journal of Geophysical Research*, 97(D7), 7651–7656.
- Ghosh, B., Papanastasiou, D. K., Talukdar, R. K., Roberts, J. M., & Burkholder, J. B. (2011). Nitril chloride (ClNO_2): UV/Vis absorption spectrum between 210 and 296 K and $\text{O}(^3\text{P})$ quantum yield at 193 and 248 nm. *The Journal of Physical Chemistry. A*, 116(24), 5796–5805.
- Hoffman, R. C., Gebel, M. E., Fox, B. S., & Finlayson-Pitts, B. J. (2003). Knudsen cell studies of the reactions of N_2O_5 and ClONO_2 with NaCl: Development and application of a model for estimating available surface areas and corrected uptake coefficients. *Physical Chemistry Chemical Physics*, 5(9), 1780–1789.
- Jenkin, M. E., Saunders, S. M., & Pilling, M. J. (1997). The tropospheric degradation of volatile organic compounds: A protocol for mechanism development. *Atmospheric Environment*, 31(1), 81–104.
- Jenkin, M. E., Wyche, K. P., Evans, C. J., Carr, T., Monks, P. S., Alfarra, M. R., ... Rickard, A. R. (2012). Development and chamber evaluation of the MCM v3.2 degradation scheme for β -caryophyllene. *Atmospheric Chemistry and Physics*, 12(11), 5275–5308.
- Jones, B. T., Muller, J., O'Shea, S., Bacak, A., Allen, G., Gallagher, M., ... Percival, C. (2017). Are the Fenno-Scandinavian Arctic wetlands a significant regional source of formic acid? *Atmosphere*, 8(7), 112.
- Jones, B. T., Muller, J. B., O'Shea, S. J., Bacak, A., Le Breton, M., Bannan, T. J., ... Percival, C. J. (2014). Airborne measurements of HC(O)OH in the European Arctic: A winter–summer comparison. *Atmospheric Environment*, 99, 556–567.
- Kennedy, O. J., Ouyang, B., Langridge, J. M., Daniels, M. J. S., Bauguitte, S., Freshwater, R., ... Jones, R. L. (2011). An aircraft based three channel broadband cavity enhanced absorption spectrometer for simultaneous measurements of NO_3 , N_2O_5 and NO_2 . *Atmospheric Measurement Techniques*, 4(9), 1759–1776.
- Kercher, J. P., Riedel, T. P., & Thornton, J. A. (2009). Chlorine activation by N_2O_5 : Simultaneous, in situ detection of ClNO_2 and N_2O_5 by chemical ionization mass spectrometry. *Atmospheric Measurement Techniques*, 2(1), 193–204.
- Lawler, M. J., Sander, R., Carpenter, L. J., Lee, J. D., Glasow, R. V., Sommariva, R., & Saltzman, E. S. (2011). HOCl and Cl_2 observations in marine air. *Atmospheric Chemistry and Physics*, 11(15), 7617–7628.
- Le Breton, M., Bacak, A., Muller, J. B., Bannan, T. J., Kennedy, O., Ouyang, B., ... Percival, C. J. (2014). The first airborne comparison of N_2O_5 measurements over the UK using a CIMS and BBCEAS during the RONOCO campaign. *Analytical Methods*, 6(24), 9731–9743.
- Manion, J. A., Huie, R. E., Levin, R. D., Burgess, D. R. Jr, Orkin, V. L., Tsang, W., ... Frizzell, D. H. (2014). NIST chemical kinetics database, NIST Standard Reference Database 17, version 7.0 (web version), release 1.6.8, data version 2013.03, (pp. 20899–8320). Gaithersburg, MD: National Institute of Standards and Technology. Retrieved from: <http://kinetics.nist.gov/>

- Mielke, L. H., Furgeson, A., Odame-Ankrah, C. A., & Osthoff, H. D. (2015). Ubiquity of ClNO₂ in the urban boundary layer of Calgary, Alberta, Canada. *Canadian Journal of Chemistry*, *94*, 414–423.
- Mielke, L. H., Furgeson, A., & Osthoff, H. D. (2011). Observation of ClNO₂ in a mid-continent urban environment. *Environmental Science & Technology*, *45*(20), 8889–8896.
- Mielke, L. H., Stutz, J., Tsai, C., Hurlock, S. C., Roberts, J. M., Veres, P. R., ... Osthoff, H. D. (2013). Heterogeneous formation of nitryl chloride and its role as a nocturnal NO_x reservoir species during CalNex-LA 2010. *Journal of Geophysical Research: Atmospheres*, *118*(18), 10,638–10,652.
- Nowak, J. B., Neuman, J. A., Kozai, K., Huey, L. G., Tanner, D. J., Holloway, J. S., ... Fehsenfeld, F. C. (2007). A chemical ionization mass spectrometry technique for airborne measurements of ammonia. *Journal of Geophysical Research*, *112*, D10502.
- Osthoff, H. D., Roberts, J. M., Ravishankara, A. R., Williams, E. J., Lerner, B. M., Sommariva, R., ... Brown, S. S. (2008). High levels of nitryl chloride in the polluted subtropical marine boundary layer. *Nature Geoscience*, *1*(5), 324–328.
- Penkett, S. A., Plane, J. M. C., Comes, F. J., Clemitshaw, K. C., & Coe, H. (1999). The Weybourne atmospheric observatory. *Journal of Atmospheric Chemistry*, *33*(2), 107–110.
- Phillips, G. J., Tang, M. J., Thieser, J., Brickwedde, B., Schuster, G., Bohn, B., ... Crowley, J. N. (2012). Significant concentrations of nitryl chloride observed in rural continental Europe associated with the influence of sea salt chloride and anthropogenic emissions. *Geophysical Research Letters*, *39*, L10811. <https://doi.org/10.1029/2012GL051912>
- Prinn, R. G. (2003). The cleansing capacity of the atmosphere. *Annual Review of Environment and Resources*, *28*(1), 29–57.
- Riedel, T. P., Bertram, T. H., Crisp, T. A., Williams, E. J., Lerner, B. M., Vlasenko, A., ... Thornton, J. A. (2012). Nitryl chloride and molecular chlorine in the coastal marine boundary layer. *Environmental Science & Technology*, *46*(19), 10,463–10,470.
- Riedel, T. P., Wolfe, G. M., Danas, K. T., Gilman, J. B., Kuster, W. C., Bon, D. M., ... Thornton, J. A. (2014). An MCM modeling study of nitryl chloride (ClNO₂) impacts on oxidation, ozone production and nitrogen oxide partitioning in polluted continental outflow. *Atmospheric Chemistry and Physics*, *14*(8), 3789–3800.
- Roberts, J. M., Osthoff, H. D., Brown, S. S., & Ravishankara, A. R. (2008). N₂O₅ oxidizes chloride to Cl₂ in acidic atmospheric aerosol. *Science*, *321*(5892), 1,059–1,059.
- Sarwar, G., Simon, H., Bhave, P., & Yarwood, G. (2012). Examining the impact of heterogeneous nitryl chloride production on air quality across the United States. *Atmospheric Chemistry and Physics*, *12*(14), 6455–6473.
- Sarwar, G., Simon, H., Xing, J., & Mathur, R. (2014). Importance of tropospheric ClNO₂ chemistry across the Northern Hemisphere. *Geophysical Research Letters*, *41*(11), 4050–4058.
- Saunders, S. M., Jenkin, M. E., Derwent, R. G., & Pilling, M. J. (2003). Protocol for the development of the Master Chemical Mechanism, MCM v3 (Part A): Tropospheric degradation of non-aromatic volatile organic compounds. *Atmospheric Chemistry and Physics*, *3*(1), 161–180.
- Simon, H., Kimura, Y., McGaughey, G., Allen, D. T., Brown, S. S., Osthoff, H. D., ... Lee, D. (2009). Modeling the impact of ClNO₂ on ozone formation in the Houston area. *Journal of Geophysical Research*, *114*, D00F03. <https://doi.org/10.1029/2008JD010732>
- Stone, D., Evans, M. J., Commane, R., Ingham, T., Floquet, C. F. A., McQuaid, J. B., ... Heard, D. E. (2010). HO_x observations over West Africa during AMMA: Impact of isoprene and NO_x. *Atmospheric Chemistry and Physics*, *10*(19), 9415–9429.
- Tham, Y. J., Yan, C., Xue, L., Zha, Q., Wang, X., & Wang, T. (2014). Presence of high nitryl chloride in Asian coastal environment and its impact on atmospheric photochemistry. *Chinese Science Bulletin*, *59*(4), 356–359.
- Thornton, J. A., Kercher, J. P., Riedel, T. P., Wagner, N. L., Cozic, J., Holloway, J. S., ... Brown, S. S. (2010). A large atomic chlorine source inferred from mid-continent reactive nitrogen chemistry. *Nature*, *464*(7286), 271–274.
- Veres, P. R., Roberts, J. M., Wild, R. J., Edwards, P. M., Brown, S. S., Bates, T. S., ... de Gouw, J. (2015). Peroxynitric acid (HO₂NO₂) measurements during the UBWOS 2013 and 2014 studies using iodide ion chemical ionization mass spectrometry. *Atmospheric Chemistry and Physics*, *15*(14), 8101–8114.
- Wang, T., Tham, Y. J., Xue, L., Li, Q., Zha, Q., Wang, Z., & Luk, C. W. (2016). Observations of nitryl chloride and modeling its source and effect on ozone in the planetary boundary layer of southern China. *Journal of Geophysical Research: Atmospheres*, *121*(5), 2476–2489. <https://doi.org/10.1002/2015JD024556>
- Wang, X., Wang, T., Yan, C., Tham, Y. J., Xue, L., Xu, Z., & Zha, Q. (2014). Large daytime signals of N₂O₅ and NO₃ inferred at 62 amu in a TD-CIMS: Chemical interference or a real atmospheric phenomenon? *Atmospheric Measurement Techniques*, *7*(1), 1–12.
- Whalley, L. K., Furneaux, K. L., Goddard, A., Lee, J. D., Mahajan, A., Oetjen, H., ... Heard, D. E. (2010). The chemistry of OH and HO₂ radicals in the boundary layer over the tropical Atlantic Ocean. *Atmospheric Chemistry and Physics*, *10*(4), 1555–1576.
- Young, C. J., Washenfelder, R. A., Roberts, J. M., Mielke, L. H., Osthoff, H. D., Tsai, C., ... Brown, S. S. (2012). Vertically resolved measurements of nighttime radical reservoirs in Los Angeles and their contribution to the urban radical budget. *Environmental Science & Technology*, *46*(20), 10,965–10,973.