



**Nolan, S. and Jones, C.E. and Munro, R. and Norman, P. and Galloway, S. and Venuturumilli, S. and Sheng, J. and Yuan, W. (2017) Experimental investigation into the fault response of superconducting hybrid electric propulsion electrical power system to a DC rail to rail fault. Institute of Physics Conference Series. ISSN 0951-3248 (In Press) ,**

This version is available at <https://strathprints.strath.ac.uk/62437/>

**Strathprints** is designed to allow users to access the research output of the University of Strathclyde. Unless otherwise explicitly stated on the manuscript, Copyright © and Moral Rights for the papers on this site are retained by the individual authors and/or other copyright owners. Please check the manuscript for details of any other licences that may have been applied. You may not engage in further distribution of the material for any profitmaking activities or any commercial gain. You may freely distribute both the url (<https://strathprints.strath.ac.uk/>) and the content of this paper for research or private study, educational, or not-for-profit purposes without prior permission or charge.

Any correspondence concerning this service should be sent to the Strathprints administrator: [strathprints@strath.ac.uk](mailto:strathprints@strath.ac.uk)

# Experimental investigation into the fault response of superconducting hybrid electric propulsion electrical power system to a DC rail to rail fault

S. Nolan<sup>1,3</sup>, C.E. Jones<sup>1</sup>, R. Munro<sup>1</sup>, P. Norman<sup>1</sup>, S. Galloway<sup>1</sup>, S. Venturumilli<sup>2</sup>, J. Sheng<sup>2</sup>, W. Yuan<sup>2</sup>.

<sup>1</sup>Department of Electronic and Electrical Engineering, University of Strathclyde, Glasgow, UK.

<sup>2</sup>Department of Electronic and Electrical Engineering, Bath University, Bath, UK.

<sup>3</sup>Steven.nolan@strath.ac.uk

**Abstract.** Hybrid electric propulsion aircraft are proposed to improve overall aircraft efficiency, enabling future rising demands for air travel to be met. The development of appropriate electrical power systems to provide thrust for the aircraft is a significant challenge due to the much higher required power generation capacity levels and complexity of the aero-electrical power systems (AEPS). The efficiency and weight of the AEPS is critical to ensure that the benefits of hybrid propulsion are not mitigated by the electrical power train. Hence it is proposed that for larger aircraft (~200 passengers) superconducting power systems are used to meet target power densities. Central to the design of the hybrid propulsion AEPS is a robust and reliable electrical protection and fault management system. It is known from previous studies that the choice of protection system may have a significant impact on the overall efficiency of the AEPS. Hence an informed design process which considers the key trades between choice of cable and protection requirements is needed. To date the fault response of a voltage source converter interfaced DC link rail to rail fault in a superconducting power system has only been investigated using simulation models validated by theoretical values from the literature. This paper will present the experimentally obtained fault response for a variety of different types of superconducting tape for a rail to rail DC fault. The paper will then use these as a platform to identify key trades between protection requirements and cable design, providing guidelines to enable future informed decisions to optimise hybrid propulsion electrical power system and protection design.

## 1. Introduction

It is expected that by 2030, 32,600 new aircraft will be required to replace aging existing fleets and support the anticipated growth in demand for air travel [1]. A number of government agencies have outlined development goals that future aircraft must reach if the industry is to be able to grow while meeting regulatory stipulations [2, 3]. These goals encompass CO<sub>2</sub> emissions, noise emissions, efficiency and runway field length. To meet these targets, new and innovative design approaches are required for both the drivetrain and the aircraft body itself. One concept that has the potential to realise significant gains is turbo-electric distributed propulsion (TeDP) [3]. Unlike conventional aircraft, which utilise gas turbine engines to provide thrust, it is proposed that thrust on a TeDP aircraft is produced from electrically driven propulsor motors, with gas engine driven generators utilised to provide this electrical power. A key advantage of TeDP is the flexibility in where the propulsor motors can be placed on the aircraft which can lead to significant aerodynamic and practical advantages [3]. In order for a TeDP

architecture to be feasibly placed on an aircraft, the power densities of the components must be extremely high. For this reason, it has been suggested that superconducting materials should be used for the machines as this can improve the power density by a factor of four [4].

While the weight is a significant factor, it is also critical that the design of the electrical power system does not mitigate the overall aircraft performance benefits of TeDP. A key design choice is whether the transmission and distribution system should be AC or DC. Although it has been shown that an AC superconducting system can result in a system with lower mass [5], there are a number of advantages to DC such as allowing for more efficient electrical decoupling of the generation and propulsion sources and offering greater control opportunities. This paper considers the fault response in such a power-electronics interfaced, DC system. The TeDP electrical power system will require appropriate electrical protection methods to be in place so that in the event of an electrical fault, component damage is minimized and the wider system is able to maintain stability.

One key area identified as an issue for protection system design is the discharge of a DC link filter capacitor following a short circuit condition. Due to the lack of impedance offered by superconducting components in the initial moments of a fault, the fault current can be extremely large. Electrically, the capacitor is closer to the fault than the generators. Thus, the peak fault current is shaped in the first instance by the capacitive discharge [6]. This paper explores these initial moments of a DC link capacitor discharge experimentally through superconducting tapes and a cable section in order to assess the response of the superconducting material to a large pulse of current at a range of voltage levels. With respect to these results, this paper will discuss the implications for protection system requirements and the stability of the wider network.

## 2. Experimental Setup

The aim of the experiment was to capture the response of a capacitive unit discharging through superconducting tapes. To achieve this, the experiment proceeded in two phases. The first phase of the experiment was to charge of a 47 mF, 100V rated capacitor using a controlled voltage source. This was disconnected from the circuit using a mechanical breaker following the charging phase completion. The second phase of the experiment was the discharge of the capacitor. This was realised through the operation of three MOSFETs [7], connected in parallel to ensure that the rated current of the individual MOSFETs was never exceeded. These were controlled via LabVIEW. An inductor was embedded within the discharge circuit to ensure a smooth discharge curve. The discharge circuit was connected to the superconducting tapes through 100 A rated copper cables. All superconducting devices in this experiment used YBCO as the active material. The superconducting components were submerged in a bath of liquid nitrogen to achieve an operating temperature of 77 K. Figure 1 shows the circuit used for the experiments. To provide a baseline for comparison, Figure 2 shows the current discharge through a copper cable rated for 100 A continuous current.

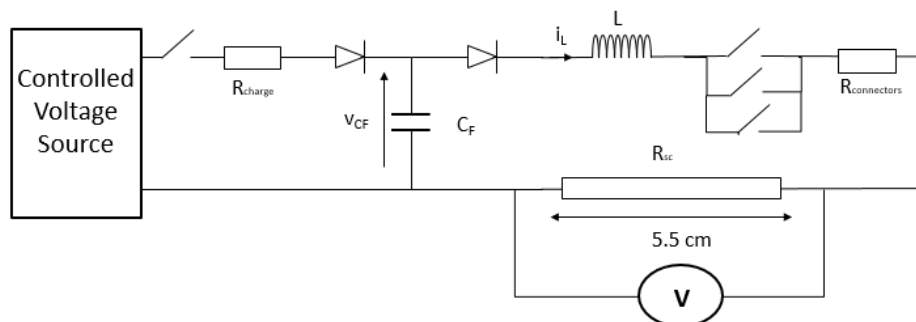

Figure 1. Circuit for Experiment

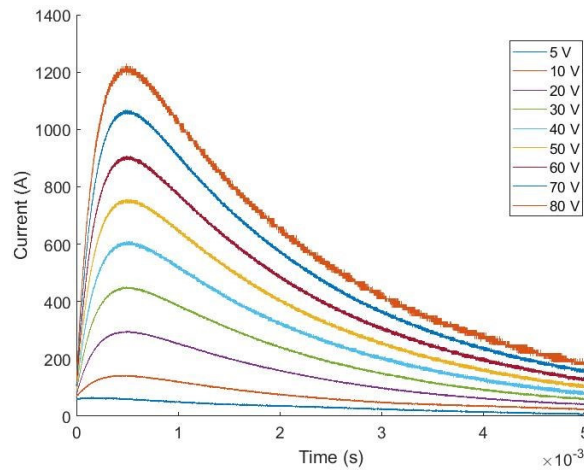

Figure 2. Discharge of capacitor through 100 A Copper Cables

### 3. Experimental Results

#### 3.1 100 A Copper-Stabilized Tape Discharge

A controlled discharge of the capacitor was carried out through a 100 A Superpower Inc. tape at a range of pre-fault voltage levels from 5V to 80V. The superconducting tape was 4 mm wide, 10 cm long with a 100  $\mu\text{m}$  copper stabilizer. Figure 3 (a) shows the discharge current for each of these tests while figure 3 (b) shows the voltage drop produced across the superconducting tapes.

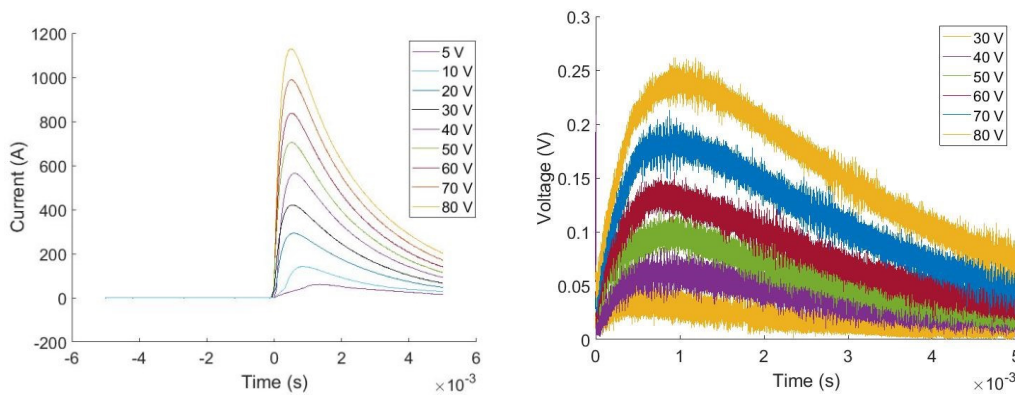

Figure 3. Stabilized Tapes (a) Current Profile and (b) Voltage Developed

It can be seen by comparing the current profile between Figures 2 and 3 (a) that a slight reduction in the peak current occurs due to the electric field generated across the tapes. From Figure 3 (b) it can be seen that above a 30 V charging voltage level, that the superconducting tape starts to produce a noticeable voltage signal between the measurement taps, which are placed across 5.5cm of the tape length. This indicated that quench had taken place. The critical current of the superconducting tape was measured before and after the discharge experiment and the results indicated that no degradation of  $I_c$  had taken place. This is because the energy dissipated in the superconductor during the experiment resulted in a temperature rise which was not high enough to cause degradation to take place, normally estimated as 400 K [8]. This demonstrates that these tapes are capable of withstanding short periods of transient overcurrents many multiples of the critical current,  $I_c$ . However, they will have a negligible effect on reducing fault current experienced by the system because of the low impedance path offered by the copper stabilizer.

### 3.2 420 A Cable Discharge

The 420 A superconducting cable was constructed of a 20 mm<sup>2</sup> copper former with 4 copper stabilized superconducting tapes wound around this core. The cable measured approximately 30 cm in length. The cable provided negligible impedance to the discharge current as evidenced by the current profile shown on Figure 4.

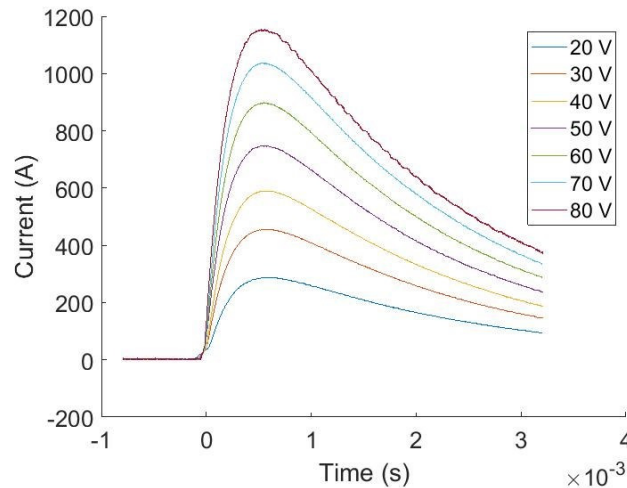

Figure 4. Current Profile of 420 A Cable Discharge.

The voltage profile is almost indiscernible from background noise, and as such is omitted from this paper. This is due to the copper former providing a very low impedance path for the excess fault current to traverse in the case of currents exceeding  $I_c$ . By inspection, neither the cable nor the stabilized tape are seen to have a significant impact on the fault current profile when compared to the discharge through the copper cable. Hence, without including additional damping, fault currents would be extremely high due to the initial discharge of DC link capacitors. A consequence of this would be that other components in the system, such as the diodes in the power electronics converters, would have to dissipate high amounts of fault energy. This potentially could result in the damage of components critical to the safe flight of the aircraft. The fast discharge of the capacitor in this very low impedance scenario could cause significant voltage depreciation throughout the system as DC-link capacitors connected across healthy branches begin to discharge into the fault. This would impact on voltage stability. To counter this, extremely fast acting protection systems may present a solution. It can be seen however that the critical current of the superconducting cable and tape does not degrade due to the high fault current, despite it being significantly above the critical threshold, indicating that these components are tolerant of large overcurrents due to the parallel paths provided by the copper materials used in each.

### 3.3 50 A Superconducting Tape Without Stabilizer Discharge

A controlled discharge was performed through a 50 A tape without a copper stabilizer, which was replaced by a thin layer (1  $\mu$ m) of silver laminated across the superconducting material of the tape. Figure 5 (a) shows the current profile resulting from the capacitor discharge, and Figure 5 (b) shows the voltage profile. In contrast to the previous results, it is shown on Figure 5 (a) that there is a reduction in the peak current when compared to the original discharge through standard copper connectors. For the 80 V discharge test this reduction was approximately 700 A. The voltage drop across the superconductor is also orders of magnitude larger in comparison to the discharge through the copper stabilized tape. The voltage signal for the 80 V test (Figure 5 (b)) rapidly drops to zero after 0.0015 s. This is because the temperature reached by the superconducting material exceeded the melting point of the solder on the connections to the voltage measurement equipment, 461 K. Unlike the results presented for the copper stabilised cable, significant critical current degradation was observed following the 70 V discharge test for the tape without a stabilizer. The 80 V discharge completely destroyed the superconducting

properties of the YBCO material. Interestingly, no physical damage was apparent upon a visual inspection.

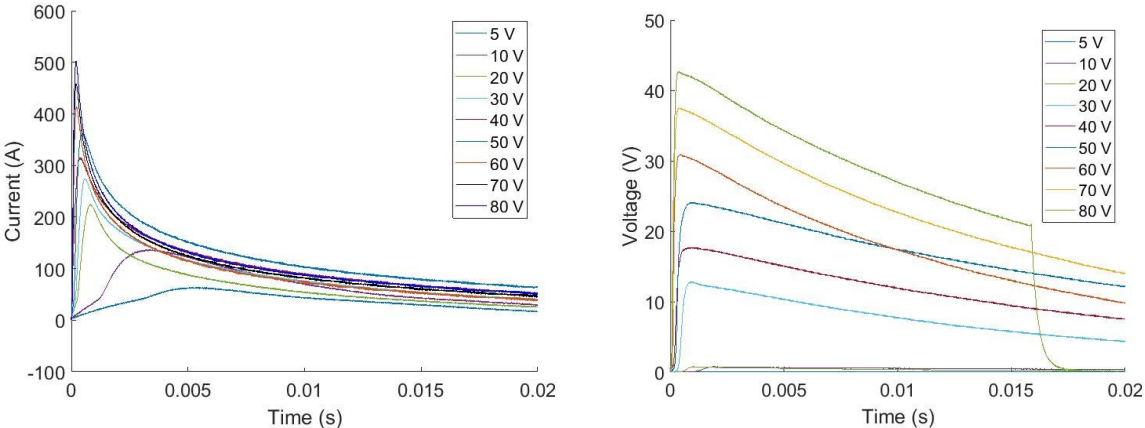

Figure 5. Non-stabilized superconducting tapes (a) Discharge current profile (b) Voltage drop.

Scanning electron microscope (SEM) analysis showed scarring of the superconducting layer at the microscopic level which indicates a possible reason for the destruction to the superconducting properties. Figure 6 shows the critical current of the superconducting tape following successive tests.

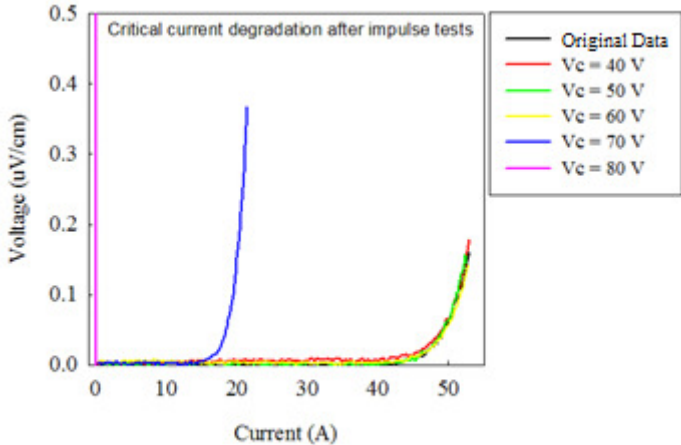

Figure 6. Critical Current Degradation of Unstabilized Tape.

This series of tests showed that the peak discharge current of the filtering capacitor is significantly reduced by using tapes that are highly resistive post quench. By consideration of Ohm’s law, this is expected. This demonstrates the potential for using superconducting materials in the design of the transmission network which are highly resistive post quench, as a means to reduce the amount of fault current experienced by components on the network. This may allow for certain components to be de-rated, reducing the weight and volume penalties they incur. Further investigation into the benefits this would bring to the overall performance of the electrical power system is required, but is out with the scope of this paper. The discharge time constant is also significantly larger than the previous experiments that utilised copper to provide shunt paths, due to the higher post quench resistance. This may have benefits for post-fault voltage stability, due to the slower discharge of DC link filters, reducing the speed of fault propagation to healthy branches of the network. However, it must be noted that during this experiment the tape experienced significant thermal and electrical stress, eventually causing the complete breakdown of superconducting properties. In order to take advantage of this potential functionality, components would have to be designed to withstand the maximum current and

temperature reached during the fault period. Temperature rise experienced will be directly related to the volume available for dissipating heat. As resistance is inversely proportional to the cable area, a trade-off between fault impedance and temperature rise is created.

*3.4 Parallel Tape Arrangement*

The parallel tape discharge test utilised 3 SuNAM tapes. Each tape was 6 mm wide, 10 cm in length, possessing a copper stabilizer with a 100 μm thickness, and with a critical current of 175 A. Above 50 V discharge voltage, the quench voltage became noticeable across the tapes. Figure 7 shows the voltage profile for a 50 V discharge test while Figure 8 shows the associated current distribution between the tapes.

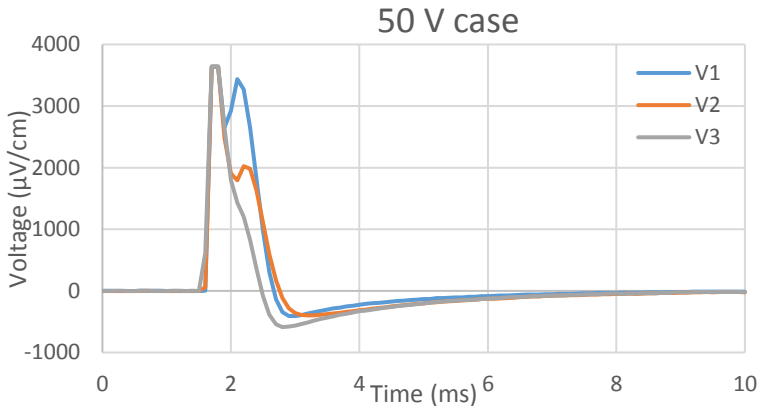

Figure 7. Voltage Across Tapes.

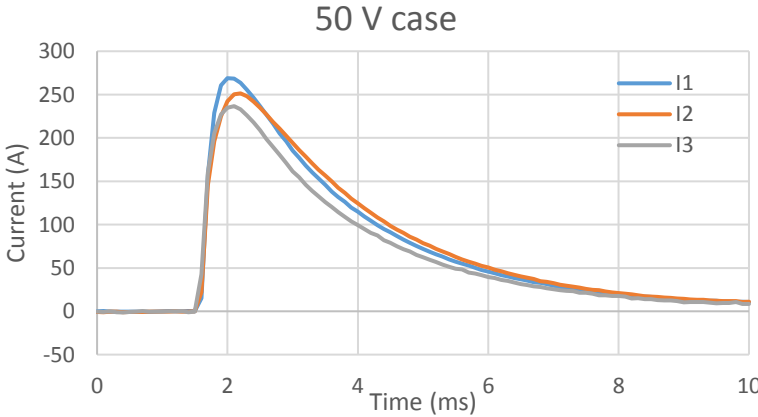

Figure 8. Current Distribution Between Tapes.

The small voltage signal highlights the difficulty of detecting the quench voltage at current levels below 1.3-1.5  $I_c$ . It is also noted that the current is not shared equally between the tapes. As the voltage of the discharge is increased the uniformity of current sharing increases and the current becomes more evenly distributed between the three tapes. This is due to the inductive voltage produced by the tapes, created by the large rate of change of current outweighs the impedance offered by the quenching process and any contact resistances present in the tapes connections. This can make it difficult to detect the quench taking place as the detection mechanism will have to compensate for the inductive voltage produced by large transients. This could be even more prominent in cables with tapes wound helically as the inductance would be significantly larger than in the small tapes considered here. Figures 9 and 10 show the voltage drop across the tapes and the current distribution during the 80 V discharge test.

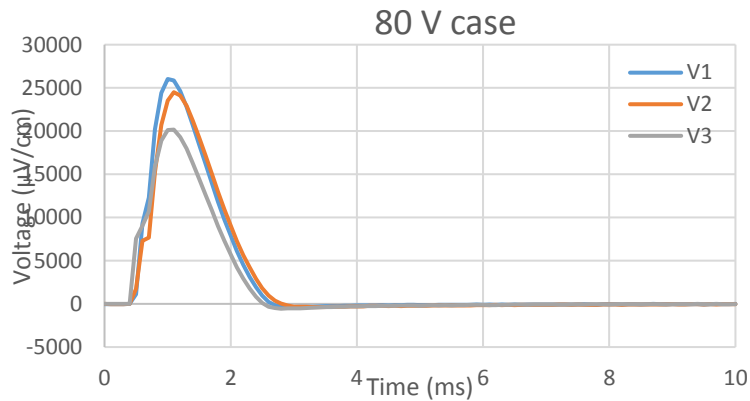

Figure 9. Voltage Drop Across the tapes for 80 V Discharge Test.

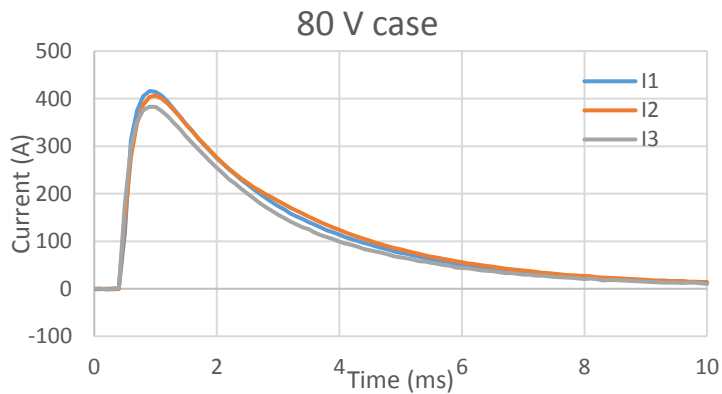

Figure 10. Current Distribution during 80 V Test

Current sharing under large transient conditions (Figure 10) can be compared to Figure 11 where the current is ramped up in a slowly controlled fashion at a rate of 10 A per second. In the load ramp case it can be seen that the current sharing between the tapes is dominated by contact impedance, causing significant differences between the currents carried by each of the three tapes, reaching a peak deviation of 30 %. This shows that under significant transients, inductance is the dominant factor in current distribution between parallel superconducting components in a DC system while contact impedance is more significant in steady state conditions.

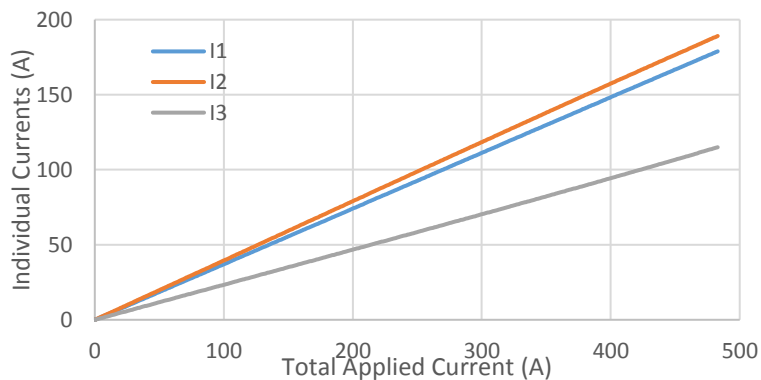

Figure 11. Current Sharing Between Tapes During Ramp Current Test.



#### 4. Conclusion

This paper has shown the resulting current and voltage profiles for a series of capacitive discharge tests conducted in laboratory conditions. It has been shown that tapes and cables that utilise low impedance parallel paths will have negligible impact on fault current, which could result in significant peak currents forming. Although these components are unlikely to suffer degradation as a result of brief transients brought about by a DC link capacitive discharge event, the lack of resistive damping could result in voltage instability throughout all branches connected across a common link. Further work will investigate this potentially hazardous system condition and how solutions such as extremely fast acting circuit breakers can mitigate its effects. Conversely, materials with a high impedance parallel path will significantly reduce the fault current peak. This is at the expense of potential cable degradation if the shunt path is not sized appropriately, creating a protection trade-off between component temperature margins and wider system stability. Current distribution in parallel tapes is also explored, with the results indicating that inductance plays a major role in this process during large transient events while contact impedance dominates steady state situations. Future work will include introducing a DC offset to the fault current such that the fault response of a converter interfaced network can be emulated and protection algorithms can be experimentally evaluated.

#### 5. Acknowledgements

This work was undertaken as part of the Rolls-Royce UTC Programme.

#### 6. References

- [1] Airbus, "Flying By Numbers", Airbus, [online] Available: <http://www.airbus.com/company/market/forecast/>, 2015, accessed on: 12th of May 2016.
- [2] European Commission, "Flightpath 2050 Europe's Vision for Aviation Report of the High Level Group on Aviation Research", European Union. Available at: <http://ec.europa.eu/transport/sites/transport/files/modes/air/doc/flightpath2050.pdf> Date Accessed: 03/05/2017
- [3] J. L. Felder, H. D. Kim, and G. V. Brown, "Turboelectric Distributed Propulsion Engine Cycle Analysis for Hybrid-Wing-Body Aircraft", 47th AIAA Aerosp. Sci. Meet. Incl. New Horizons Forum Aerosp. Expo., 2009.
- [4] Kalsi, Swarn, Singh, "Applications of High Temperature Superconductors to Electric Power Equipment" Chap 4, John Wiley & Sons Ltd, 2011
- [5] C. E. Jones, P. J. Norman, S. J. Galloway, M. J. Armstrong and A. M. Bollman, "Comparison of Candidate Architectures for Future Distributed Propulsion Aircraft," in IEEE Transactions on Applied Superconductivity, vol. 26, no. 6, pp. 1-9, Sept. 2016. doi: 10.1109/TASC.2016.2530696
- [6] S. Fletcher, "Protection of Physically compact Multiterminal DC systems", Doctoral Thesis, University of Strathclyde, Glasgow, 2013.
- [7] Semikron, "SKM 111 AR Datasheet", Semikron, [online] Available at: [http://www.gdrectifiers.co.uk/uploads/SEMIKRON\\_DataSheet\\_SKM\\_111\\_AR\\_.pdf](http://www.gdrectifiers.co.uk/uploads/SEMIKRON_DataSheet_SKM_111_AR_.pdf) Date Accessed 26/05/16.
- [8] M. J. Kim et al., "Determination of Maximum Permissible Temperature Rise Considering Repetitive Over-Current Characteristics of YBCO Coated Conductors," in IEEE Transactions on Applied Superconductivity, vol. 18, no. 2, pp. 660-663, June 2008. doi: 10.1109/TASC.2008.921397