



The 8th International Conference on
Structural Health Monitoring of Intelligent Infrastructure
Brisbane, Australia | 5-8 December 2017

Project VIMTO: a new system for the vibration and impact monitoring of tram operations

P.R.A. Fidler¹, S. Hartley², J.P. Talbot²

¹ University of Cambridge, UK, Email: praf1@cam.ac.uk, ² University of Cambridge, UK

Abstract

Disturbance to building occupants caused by tram-generated ground-borne noise and vibration presents a significant barrier to the expansion of tram networks in our cities. Furthermore, such disturbance is often an indicator of deteriorating track infrastructure. Monitoring and understanding ground-borne noise and vibration is therefore a key priority for tram operators. Project VIMTO (Vibration and Impact Monitoring of Tram Operations) is concerned with developing a new system for monitoring vibration and impact of trams, whereby the vehicles themselves are used as the primary monitoring instrument. Low-cost vehicle-mounted instrumentation is being used to record axle-box vibration signatures, along with positioning data, to ‘map’ a tram network in terms of its propensity to generate vibration. Such mapping aims to offer near real-time continuous monitoring, enabling the formulation of more efficient, optimised maintenance strategies. This paper describes the current development system and presents some initial results from trials on the Midland Metro, UK.

1. Introduction

The surface roughness of railway track increases during service. Along with other forms of deterioration, such as settlement at rail joints, this leads to an increase in the level of vibration and wheel-rail impacts generated as a vehicle runs along the track. From its origin at the wheel-rail interface, vibration propagates through the track structure, through the ground and into buildings, where it may then cause disturbance as perceptible vibration and/or re-radiated noise (Lang 1988, Howarth & Griffin 1991, Talbot 2013). A particular concern can be the development of corrugation (Figure 1), a short-wavelength irregularity (typically 20 mm to 200 mm) that forms along the rail head and leads to particularly severe, tonal noise due to the periodic wheel-rail interaction (Grassie 2009).



Figure 1: Examples of rail corrugation on mainline track
(Images: RailMeasurement Ltd. Used with permission)

There are over 290 km of modern tramway in the UK alone, the majority of which run through densely populated urban areas. Proximity to residential properties and sensitive buildings such as concert halls and hospitals means that ground-borne vibration is a major concern of tram operators, who must work continuously at track maintenance to keep noise and vibration within acceptable levels. Currently, this work relies on regular, manual track inspections to identify areas of deterioration before they become a significant source of vibration. Such inspections are time consuming and costly. There is a clear need for a more efficient monitoring method.

Vehicle-based infrastructure monitoring is not a new concept. In particular, indirect measurement of railhead irregularities using accelerometers mounted on the axle-boxes of bogies was first trialled on mainline track in the mid-to-late 1980s (Grassie, 1989 & 1996). This initial work has led to the development of at least one commercially available system (RailMeasurement Ltd) which has since been tested specifically for managing wheel/rail rolling noise with the French railway operator SNCF (Bogini et al. 2011). However, this previous work has been concerned with specialist trials on mainline track, and has so far been limited to conditions when vehicle speeds and track behaviour remain similar to those under which the system is calibrated. Despite the apparent research successes, there is little or no evidence of such monitoring being used regularly in service with either mainline trains or trams. Project VIMTO aims to develop a low-cost vehicle-based system for track monitoring that may be permanently installed on service trams running on an operational network. The focus is on monitoring the track in terms of its propensity to generate ground-borne noise and vibration. As such, the ultimate objective is to develop a system that tracks changes in the underlying roughness of the railhead, in the form of the roughness spectrum as defined in standards such as EN 15610:2009 (European Committee for Standardization, 2009).

2. The Midland Metro tram system

The Midland Metro service (Figure 2) first opened in 1999, operating on both on-street and dedicated rail sections over 20 km of track between Wolverhampton St George's and Birmingham Snow Hill stations.

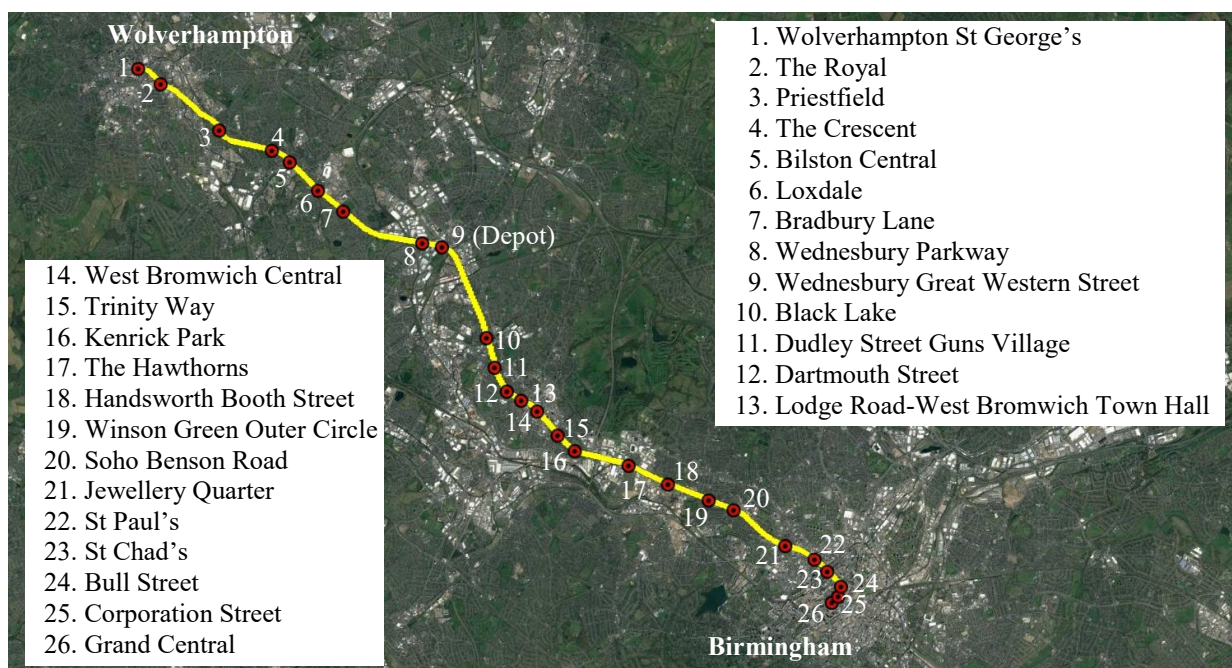

Figure 2: The Midland Metro tram network operates between Wolverhampton and Birmingham, UK (Image: Google, © 2017 Infoterra Ltd & Bluesky)

In 2016 the system was extended further into Birmingham city centre, with a new stop at St Chad's replacing the original Snow Hill terminus, and new stops added at Bull Street, Corporation Street and Grand Central Station. Further extensions to the network are planned.

Since September 2014, the system has operated a fleet of CAF Urbos 3 trams (Figure 3), providing a service of 10 trams per hour in each direction. The trams are 33 metres long and consist of five modules with four articulations, three of the modules being mounted on bogies and the other two modules being suspended. The maximum operating speed of the trams is 70 km/h.



Figure 3: A CAF Urbos 3 Tram at the Bull Street tram stop
(Image: Jennifer Schooling. Used with Permission)

3. Monitoring system overview

The aim of Project VIMTO is to develop a low-cost vehicle-based system for track monitoring that may be permanently installed on service trams running on an operational network. The system described here is the current development system. It uses a total of five accelerometers, mounted at the ends of the axle bridges – the steel beams mounted off the primary suspension that support the axle boxes of each wheelset (Figure 4). These offered the most practical locations at which to mount the accelerometers whilst being as close as possible to the wheel-rail interface, in order to minimise the mechanical filtering effect of the various axle/suspension components between the rail head and the measurements.

As indicated in Figure 5, four accelerometers (P1-P4) are located on one of the power bogies, with a fifth (T1) located on the central trailer bogie. This arrangement includes a degree of redundancy that is expected to be reduced as part of the development work. In principle, just two accelerometers should be sufficient; one for each rail. However, a significant amount of the development work involves assessing the quality of the accelerometer signals and the degree of variability between measurement locations. Although the power and trailer bogies are based on a common bogie frame, the influence of differences in unsprung mass, and the effect of the motors in the power bogies has yet to be determined.

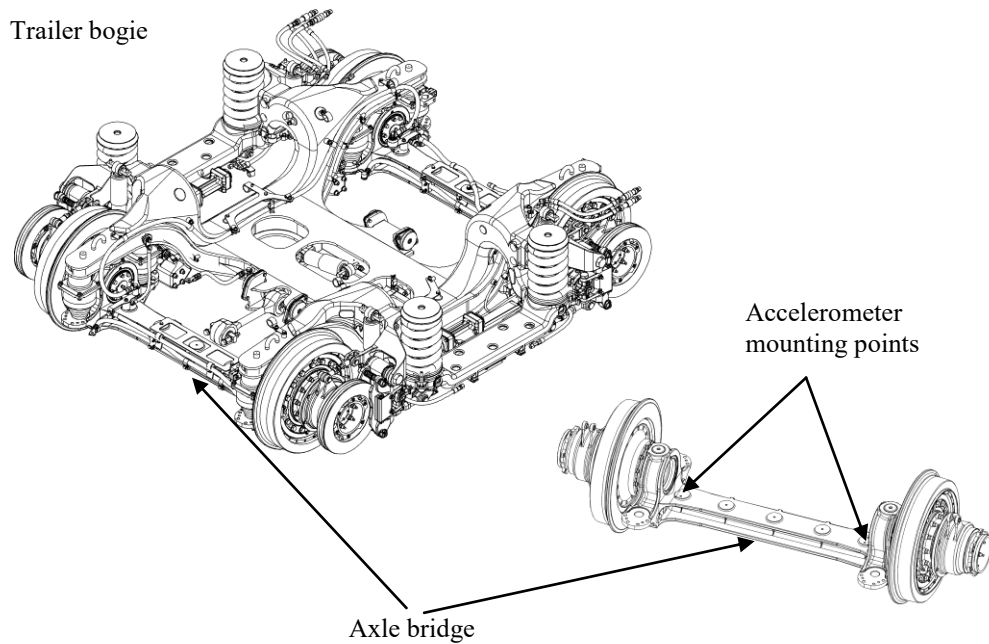

Figure 4: Accelerometer locations on the axle bridge
(Images: CAF. Used with permission)

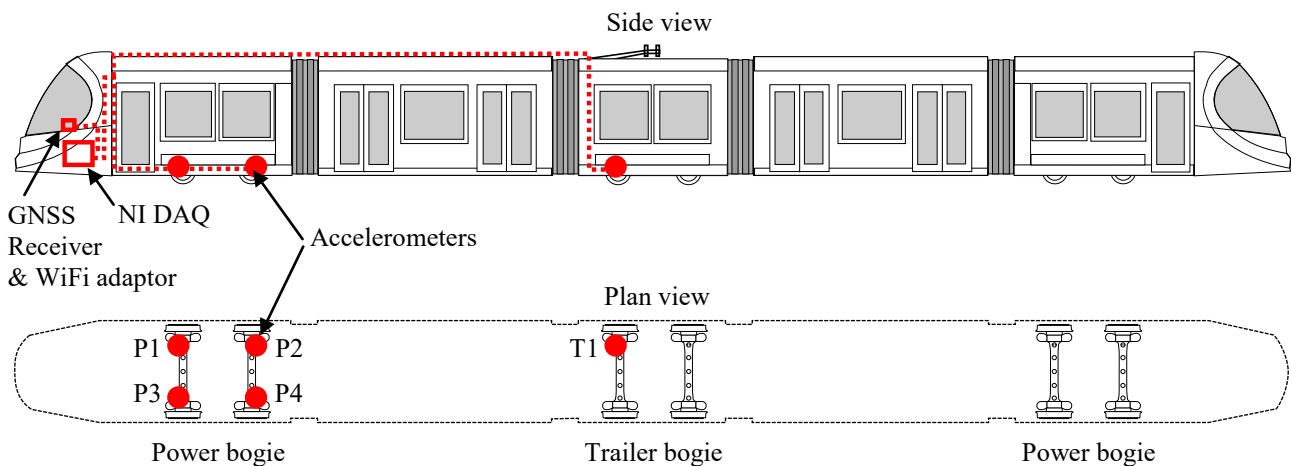

Figure 5: Diagram of system installed in the tram, showing the approximate locations of the cabling and accelerometers, P1-P4 (power bogie) and T1 (trailer bogie)

3.1 Hardware

The data acquisition (DAQ) hardware consists of: a NI CDAQ-9132 data acquisition unit, with a 128 GB SD card; two NI 9234 analogue-to-digital (ADC) modules and one NI 9401 8-channel digital I/O module; all from National Instruments. All five accelerometers are Dytran 3055D4 single-axis ICP-type piezoelectric devices, with a sensitivity of 50 mV/g and a dynamic range of 100 g. These were selected based on previous experience of axle-box vibration measurements (Degrande et al. 2006, Lees & Talbot 2014), which typically indicate peak vibration levels in the region of 50 g. The accelerometers are stud-mounted in tapped holes in the axle beams, using a proprietary thread-locking compound. Electrical connections, for the combined ICP power and accelerometer signal, are made to the ADC modules with standard RG 174 coaxial cable.

In addition to the accelerometers, the system uses a GNSS receiver to determine tram location and speed, which is connected to the data acquisition unit via USB. An additional CAF speed sensor, of the same type used on the tram to provide speed information to the driver, was also originally installed on one wheel of the central trailer bogie, and connected to the digital I/O module using 4-core cable.

To facilitate data transfer to and from the system, a Netgear WNCE2001 Ethernet to WiFi adapter was installed to allow connection to the Internet within the tram depot. WiFi Internet connectivity was provided by Centro (Transport for West Midlands).

3.2 Installation

During an initial visit to the tram depot, a cabinet in one of the two driver's cabins had been identified as a suitable location for the data acquisition unit. Installation of the monitoring system on the tram took place over a number of visits to the depot between November 2015 and July 2016. The cable installation took place on 5th November 2015, when four coaxial cables for accelerometers P1-P4 were routed to the power bogie behind the driver's cabin. A further three coaxial cables and the 4-core cable for the CAF speed sensor were routed over the roof of the tram, past the two intervening articulations and then down to the trailer bogie. All cabling was routed within fire-resistant flexible trunking (Figure 6) and is hidden from view, whether under the tram, within cable runs inside the tram cowlings or along the roof.



Figure 6: Accelerometer cabling (left) and location (right) on the axle bridge of the trailer bogie

The data acquisition unit and accelerometers were connected on 17th February 2016, along with the GPS receiver and the WiFi adapter. These were placed above the cabinet housing the data acquisition unit but hidden from view on the left-hand side of the driver's cabin. Calibration tests were performed on the accelerometers on 4th May 2016.

3.3 Hardware issues

The cable runs proved challenging, and a number of suspected cable breakages during installation necessitated a reduction in the number of sensors finally commissioned; two of the three accelerometers planned for the trailer bogie, together with the CAF speed sensor, had to be omitted. Furthermore, although data could initially be logged from the GPS receiver, there was no accurate location data – only status data indicating that no GPS fix was available. The Olimex GPS unit was

disconnected and replaced by a Navilock NL-8003P GNSS receiver on 10th August 2016, which has since proven to be reliable.

The Netgear WiFi initially failed in October 2016. The data acquisition unit continued to log data on the SD card until 11th November 2016, when the card became full. An initial attempt to reconfigure the WiFi adapter in December 2016 appeared to have been successful but the adapter failed again in January 2017 and was subsequently replaced with a TP-Link TL-WR802N device on 27th April 2017. So far, this new WiFi adapter appears to be working well.

A further lack of robustness concerns the threaded cable connectors to the accelerometers, which have demonstrated a tendency to work loose under the high-vibration levels seen on the bogies. No thread-locking compound was originally applied to these relatively delicate connectors, to allow easy disconnection in the event of a bogie change on the tram.

These hardware issues have provided valuable lessons as part of the commissioning of the development system, and will undoubtedly inform a more robust design of future installations.

3.4 Data acquisition software

The NI CDAQ-9132 data acquisition unit runs a real-time Linux distribution. A custom LabView program, compiled into a real-time Linux executable, is used to acquire and store data from the sensors. As a development system, raw data is acquired and saved permanently: no data reduction or analysis is performed on the unit, and no data is presented to any user interface. The program has a single real-time thread that records data from the five working accelerometers and from the GNSS receiver, and a non-real-time thread that saves data to log files. Acceleration data is stored in National Instruments' TDMS file format, while GNSS location data is stored in text files. A single clock is used to time-stamp each entry in both files, thereby providing a common time base.

Data are recorded from 5am to 11pm every day. Acceleration data are recorded at 1652 Hz, whereas the GNSS data are recorded at 10 Hz. These sampling frequencies were chosen to achieve the necessary compromise between spatial and frequency resolution, and without producing unmanageable quantities of data. The tram typically records 264 MB per hour, equating to 4.8 GB of data per day. Data are transferred from the tram to a server in Cambridge via Rsync over SSH. This can currently only be done while the tram is in the depot, typically overnight. Whilst this currently limits any real-time analysis or presentation that may be done, it is possible that improved communications in future may make it possible to stream acceleration data in real time.

4. Initial results and analysis

The GNSS location data along the route are usually good, but suffer from errors in areas where the tram goes through a cutting, under a bridge, or near tall buildings (Figure 7). As expected, no location data are available for the section of track between Wednesbury Great Western Street and Black Lake where the track goes through a tunnel. The GNSS location is also not accurate enough to determine which of the two running tracks the tram is using. However, although there are points at various locations along the route at which a tram could be switched to the opposite track, this only actually happens at the ends of the route, with the tram normally driving on the left-hand track with respect to the direction of travel.

Data files are currently processed using some bespoke Python scripts. These first check the location data log files to check whether there is any significant movement of the tram (on some days it remains parked in the depot) and, if there is, the acceleration data and location data are combined into a single file for ease of processing.

For the purpose of initial analysis, the route from Wolverhampton St George's station to Grand Central station in Birmingham has been divided into 50 m sections (except for the tunnel and two

under-bridge sections where the sections are longer). The root mean square (RMS) acceleration level of each of the accelerometer signals is then calculated for each 50 m section of track.

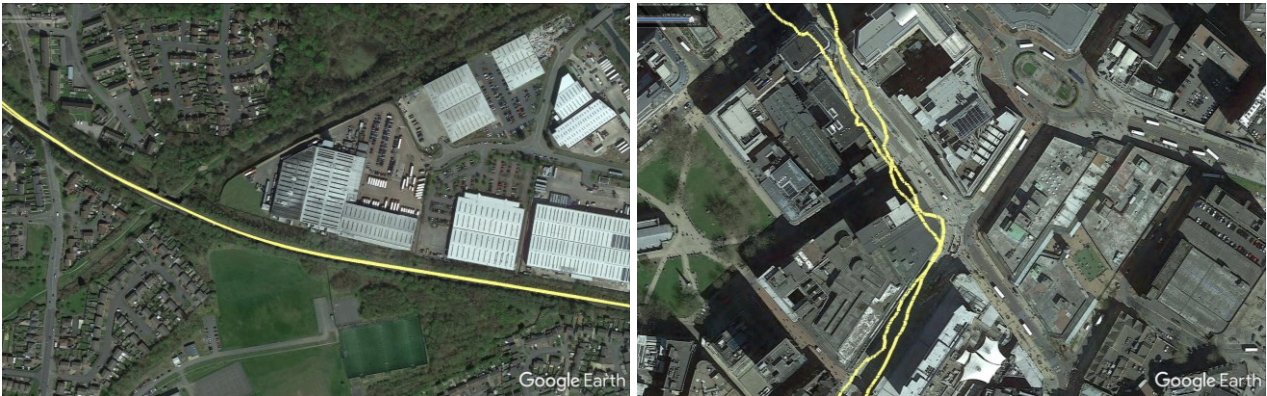

Figure 7: GNSS data from the suburban area near Wednesbury Parkway (left) and in Birmingham city centre at the corner of Bull Street and Corporation Street (right). (Images: Google)

To account for inaccuracies in the GNSS data, the tram is determined to be within a track segment if the GNSS position is within a polygon that extends 50 m along the track and approximately 35 m either side. The scripts are written to allow a customised polygon to be used where necessary, such as for sections of the track near tall buildings, under bridges or within tunnels. Journeys from Wolverhampton to Birmingham are treated separately from those from Birmingham to Wolverhampton. For simplicity, all data presented here are from journeys in the Wolverhampton-to-Birmingham direction (data acquired in the reverse direction are similar).

Figure 8 shows the RMS acceleration levels for the entire route between Wolverhampton and Birmingham on a selection of different days between August 2016 and April 2017.

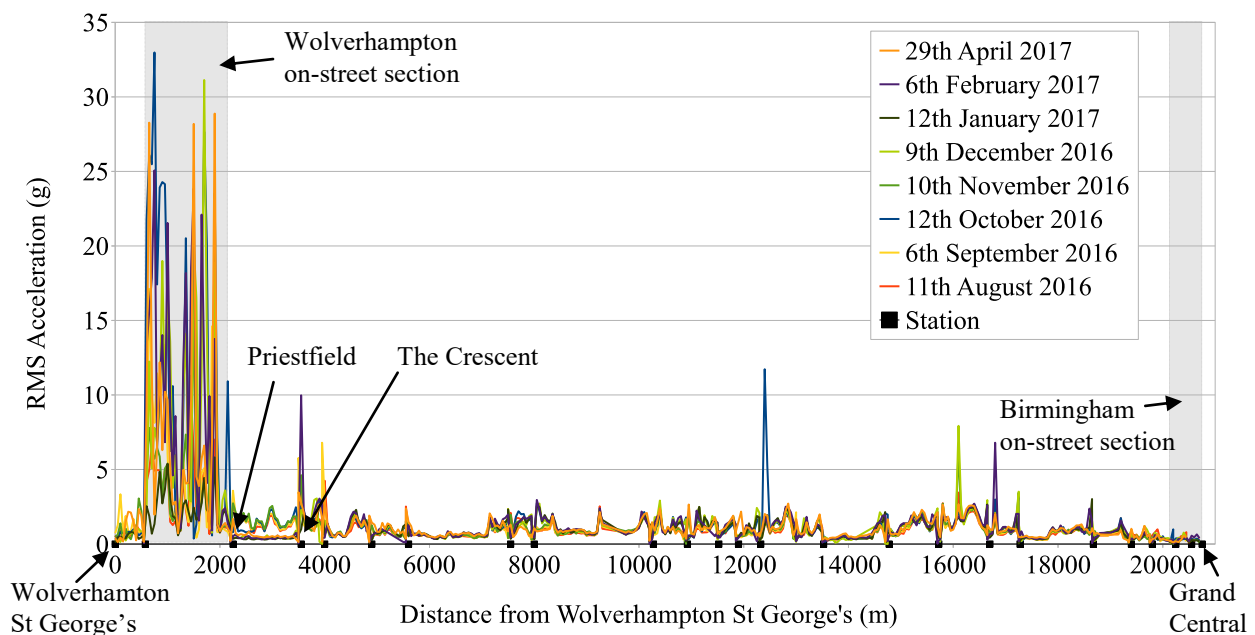

Figure 8: Graph showing RMS acceleration levels from accelerometer P1, recorded on a selection of different days for each 50 m section of the entire route between Wolverhampton and Birmingham.

The data for the track sections near Wolverhampton show considerably higher RMS accelerations than elsewhere. This is attributed to the poorer track quality between The Royal and Priestfield tram stops (600 m to 1950 m), which is an on-street section where trams must brake and accelerate more frequently than on the dedicated rail sections, as they operate in a mixed-traffic environment with other road users.

For most of the remainder of the route, from The Crescent through to Grand Central (3500 m to 21750 m), the RMS accelerations recorded from journeys on different days generally show similar values. The overall consistency and repeatability between journeys, each made several weeks apart, provides a degree of confidence that the system is responding to actual features present on the track, and is not unduly influenced by factors such as changes in weather or the driving style of individual tram drivers. Although occasional peaks are evident in the data, these are usually at or near tram stops, where braking and acceleration of the tram is required. Another peak (at 16100 m) corresponds to a set of points.

One observation from Figure 8 is that the section between the Priestfield and The Crescent stops (2250 m to 3500 m) appears to show a marked *improvement* (lower RMS accelerations) between November and December 2016. This is surprising as, without intervention, track would normally be expected to wear and deteriorate over time, and we are currently unaware of any maintenance having been undertaken over this section. Figure 9 shows an enlarged view of the data, highlighting the section between Priestfield and The Crescent; Figure 10 shows both a sample of the raw acceleration data acquired on this section and also the improvement in RMS acceleration over time, as seen on accelerometers P1 and P2. At the time of writing, there is no clear explanation for the apparent improvement.

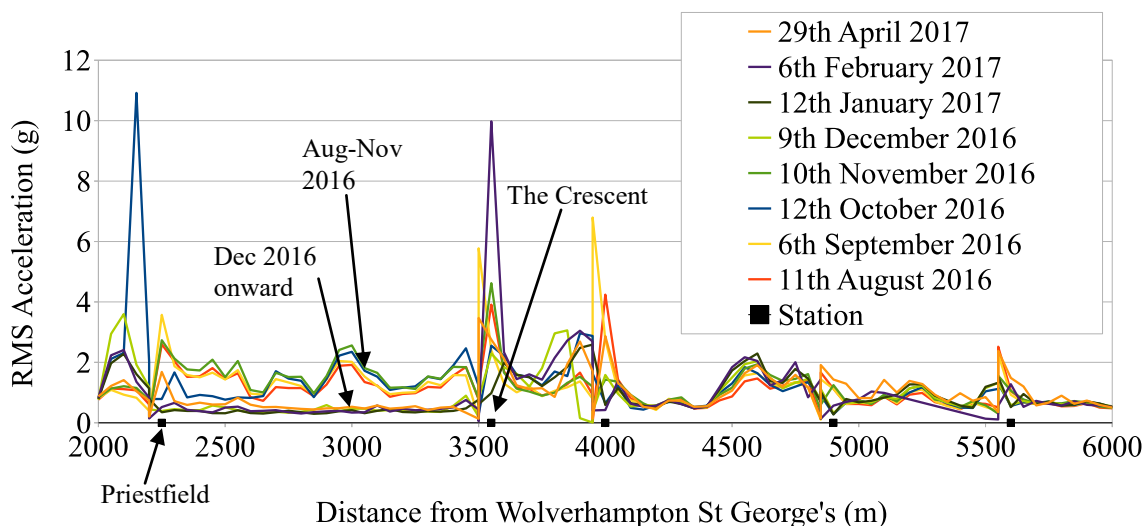

Figure 9: Graph showing the RMS accelerations recorded by P1 near the section between Priestfield and The Crescent

One key area of concern for the tram operator is the section of track at the corner of Bull Street and Corporation Street, where the tram must make a 90° turn. This places high demands on the track, and makes it a particularly sensitive section in terms of both track wear and noise generation (rail lubrication is currently being trialled by the operator over this section to reduce noise generation). The RMS acceleration levels recorded in this area are currently relatively low (< 1 g), as they are for all of the newly laid section between St Chad's and Grand Central, and the average velocity of the tram is only 15 km/h (which also contributes to low acceleration levels). It nevertheless remains an area of interest.

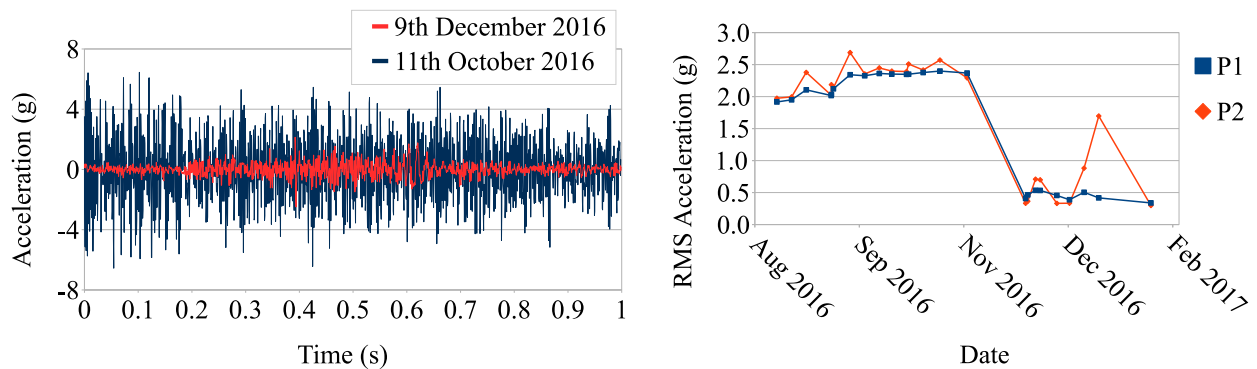

Figure 10: Plots showing the apparent improvement on the track section between Priestfield and The Crescent, showing (left) a 1 s sample of raw acceleration data from P1, and (right) the improvement as recorded by P1 and P2

5. Future work

This paper has reported on the initial development work of VIMTO. The project remains work in progress and there is considerably more research to be done, firstly in terms of understanding the quality of the data and, secondly, in terms of developing the necessary signal processing and supporting models to relate the measured accelerations to the desired rail roughness spectra. There is currently no allowance made for the effect of tram speed on the magnitude and frequency content of the measured accelerations. Better treatment of the data is also required at tram stops, as currently no attempt is made to omit acceleration data recorded while the tram is stationary.

One important piece of future work is to use a direct method of measuring surface roughness along a section of the track in order to validate and properly calibrate the data from the VIMTO system.

To achieve the goal of a near real-time monitoring system, a web-based ‘dashboard’ or reporting system is required. This will highlight those sections of track where the inferred rail roughness has changed over time, and hence highlight locations of potential wear.

6. Conclusions

Despite initial difficulties commissioning the system, axle-box acceleration data has now been collected from a tram over a period of several months. Initial analysis of the data indicates broadly consistent RMS acceleration levels for each section of track over this time. Sections of track that have exhibited differences require further investigation.

With more detailed analysis and subsequent development work, it is hoped to achieve the ultimate objective of developing a system that tracks changes in the underlying rail roughness spectrum, thereby offering near real-time continuous monitoring to enable the formulation of more efficient, optimised maintenance strategies.

Acknowledgements

This work was funded by the EPSRC Impact Acceleration Account (Grant No. EP/K503757/1) and by the Cambridge Centre for Smart Infrastructure and Construction (EP/I019308/1). The work was facilitated by Centro, the West Midlands Integrated Authority, now known as Transport for West Midlands, and by National Express. The assistance provided by Colin Robey, Sophie Allison, Khara Lakhwinder, Lee Ashmore, Tony Ross, Des Coulson and the staff at the Wednesbury Depot is gratefully acknowledged. Data supporting this paper is available from the University of Cambridge repository at: <https://doi.org/10.17863/CAM.9665>.

References

- Lang, J 1988, 'Ground-borne vibrations caused by trams, and control measures', *Journal of Sound & Vibration*, vol. 120, no. 2, pp. 407-412.
- Howarth, HVC & Griffin, MJ 1991, 'The annoyance caused by simultaneous noise and vibration from railways', *Journal of the Acoustical Society of America*, vol. 89, no. 5, pp. 2317-2323.
- Talbot, JP 2013, 'Lift-over crossings as a solution to tram-generated ground-borne vibration and re-radiated noise', *Proceedings of the Institute of Mechanical Engineers Part F – J. Rail & Rapid Transit*, vol. 228, no. 8, pp. 878–886.
- Grassie, SL 2009, 'Rail corrugation: characteristics, causes and treatments', *Proceedings of the Institution of Mechanical Engineers, Part F: Journal of Rail and Rapid Transit*. vol. 223 issue: 6. pp 581-596. DOI: 10.1243/09544097JRRT264
- Grassie, SL 1989, 'Corrugation on Australian National: cause, measurement and rectification', 4th International Heavy Haul Railway Conference, Brisbane, Australia, pp. 188-192.
- Grassie, SL 1996, 'Measurement of railhead longitudinal profiles: a comparison of different techniques', *Wear*, vol. 191, pp. 245-251.
- RailMeasurement Ltd. Corrugation measurement or "noise mapping" at line speed: HSRCA, High Speed Rail Corrugation Analyser factsheet, Cambridge. <http://railmeasurement.com/hsrca/> (accessed 22nd May 2017).
- Bongini, E, Grassie, SL & Saxon, MJ 2011, 'Noise mapping' of a railway network: validation and use of a system based on measurement of axlebox vibration in T. Maeda et al. (Eds.), *Noise and Vibration Mitigation for Rail Transport Systems*, NNFM 118, Springer-Verlag.
- European Committee for Standardization 2009, EN 15610:2009 'Railway applications - Noise emission - Rail roughness measurement related to rolling noise generation'.
- Degrande, G, Schevenelsa, M, Chatterjeet, P et al. 2006, 'Vibrations due to a test train at variable speeds in a deep bored tunnel embedded in London clay', *Journal of Sound & Vibration*, vol. 293, pp. 626–644.
- Lees, A & Talbot, JP 2014, 'Mapping of ground-borne vibrations created by trams', Fourth-year undergraduate project, Cambridge University Engineering Department.