

Motivating and Investing in the Freshmen: Paving the Way for the Future

Abstract

This paper describes an introductory freshman experience course, “Introduction to Building Systems” that was five years in the making and meets several critical goals for this engineering department. The ten-week course consists of a large group lecture and a small group activity each week and is team-taught by a tenured faculty member and the department head. Industry support from Hilti and Simpson Strong-Tie provides materials and expertise for two of the activities. University support assists with the welding, digital fabrication, and building tour activities. A review of the literature addresses how this course aligns with and differs from other existing introductory experience courses. The development of the course is described using a highly regarded systematic design of instruction process. Future changes are discussed based on assessment data from the first two iterations of this course.

Introduction

The Architectural Engineering (ARCE) program at California Polytechnic State University located in San Luis Obispo resides in the College of Architecture and Environmental Design (CAED). The program is ABET accredited and offers more structural engineering content at the undergraduate level than any other program in the nation. One reason for this is that the accreditation program criteria for civil engineering programs are too restrictive to allow civil engineering programs to have a similar emphasis on structural engineering.¹ Furthermore, most of the other 17 accredited ARCE programs have elected not to focus to the same depth on structural engineering, despite being located in colleges of engineering². The CAED also contains the Architecture (ARCH) and Construction Management (CM) programs thus offering unique opportunities for interdisciplinary collaboration. Students applying to Cal Poly are required to request a specific major; and due to a tight sequence of courses with prerequisites, enrolled students must embark on a major-specific course flowchart that is somewhat constrained.

Until recently, the ARCE freshmen did not take their first ARCE course until the beginning of their sophomore year. The freshmen spent their first year taking architecture studios, materials of construction, general education courses, and the necessary calculus and physics courses that are prerequisites for their first ARCE courses in statics and mechanics of materials. The result, as determined by exit interviews with the department head, was that ARCE freshmen did not feel like they were part of the department and were often dropping out or changing majors prior to taking their first ARCE course. Other than their ARCE faculty advisor who the freshman are required to see quarterly, these students had no contact with the ARCE faculty. The obvious solution was to include an ARCE course in the curriculum that would remedy this and inspire the freshmen for the structural engineering curriculum that laid ahead.

The ARCE program, despite a recent mandate to reduce from 203 quarter units to 196 quarter units, remained the largest four-year program at the university. The program would not be allowed to add any additional units without removing others from the curriculum. The opportunity came when the architecture department chose to discontinue the two-unit Materials of Construction course that they taught to all of the ARCE and CM freshmen students. This allowed ARCE to create a two-unit course that would tailor the course content to be more relevant to ARCE students, and better integrate the freshmen into their home department.

For a variety of reasons, it took five years to get the course approved, developed, and on the books. ARCE 106 “Introduction to Building Systems” was taught for the first time in the Fall Quarter 2015. It is offered only in the fall and the entire ARCE freshman class is block scheduled into it. The second iteration of ARCE 106 was taught during Fall 2016. This paper describes the development, execution and assessment of this course using the Dick and Carey³ model for the systematic design of instruction.

Review of the Literature

Introductory courses for freshman have become so prevalent that over two-thirds of the engineering programs in the United States have them in some form⁴. There are common reasons for needing them. Most engineering programs are tightly packed four-year experiences where, unlike medical and law school, graduates are expected to enter professional practice immediately upon graduation. As such, the freshman year is filled with calculus and physics courses that are highly theoretical and provide no logical connection to the engineering that lies ahead.⁵ The remainder of freshman courses tend to be general education or other courses even further removed from engineering because students do not yet have the prerequisites to take standard engineering courses. As a result, students do not get to interact with engineering faculty, or experience hands-on laboratories or understand engineering as a profession. The result is often a higher than desired attrition rate.

Because so many engineering courses have adopted a freshman experience, the published literature is abundant, especially through ASEE conference papers and the Journal of Engineering Education. Studies have examined the attributes of incoming freshmen that should be considered in designing freshman courses⁶ while others look at the self-efficacy that freshmen derived from such experiences⁷. Burton and White did a longitudinal study of various models for freshman engineering experience at schools such as Northern Arizona University, University of Wisconsin and Drexel University to classify the models and choose one for the University of Alaska at Fairbanks⁸.

Most of the literature is filled with case studies that relate the specifics of a freshmen experience course at schools such as Michigan State University⁹, Lehigh University¹⁰, and the Citadel⁴, to name just a few. A common theme to them all is a desire to engage freshmen in engineering,

develop more hands-on practical experiences, and reduce attrition to other fields. Some courses were deliberately designed to be engaging and fun. The freshman course at Tulane, for example, included engineering faculty lunches, research lab activities, and a visit to a local amusement park¹¹. Because students in many universities apply to engineering programs, but do not choose their actual majors until the second year, many of the freshman experiences are highly interdisciplinary and introduce students to a variety of engineering disciplines. In some cases, the activities were rotated among the different engineering departments¹². One freshman experience was designed as a hybrid course in a flipped classroom¹³.

The ARCE 106 course described herein shares many of the same purposes and motivations as the courses described in the literature particularly those designed to engage freshmen in the profession of engineering, create hands-on learn-by-doing experiences, and hopefully reduce the attrition rate early in the program. There are some differences from the previous studies. The ARCE 106 is specifically targeted to freshmen in the ARCE program with additional benefits of establishing camaraderie among a specific cohort and maintaining an emphasis on how structural engineers serve society. Also the course was designed using a well-established design of instruction methodology.

Systematic Design of Instruction

The model for Systematic Design of Instruction is reported by both Dick and Carey³ and Gagne *et. al.*¹⁴ Fig. 1 shows the various steps in the model and the order in which they occur. The formalized process was developed to ensure critical steps in the creation of a curriculum are not skipped. The methodology has been part of the American Society of Civil Engineers (ASCE) Excellence in Civil Engineering Education (ExCEED) teaching workshop curriculum since 1999.¹⁵

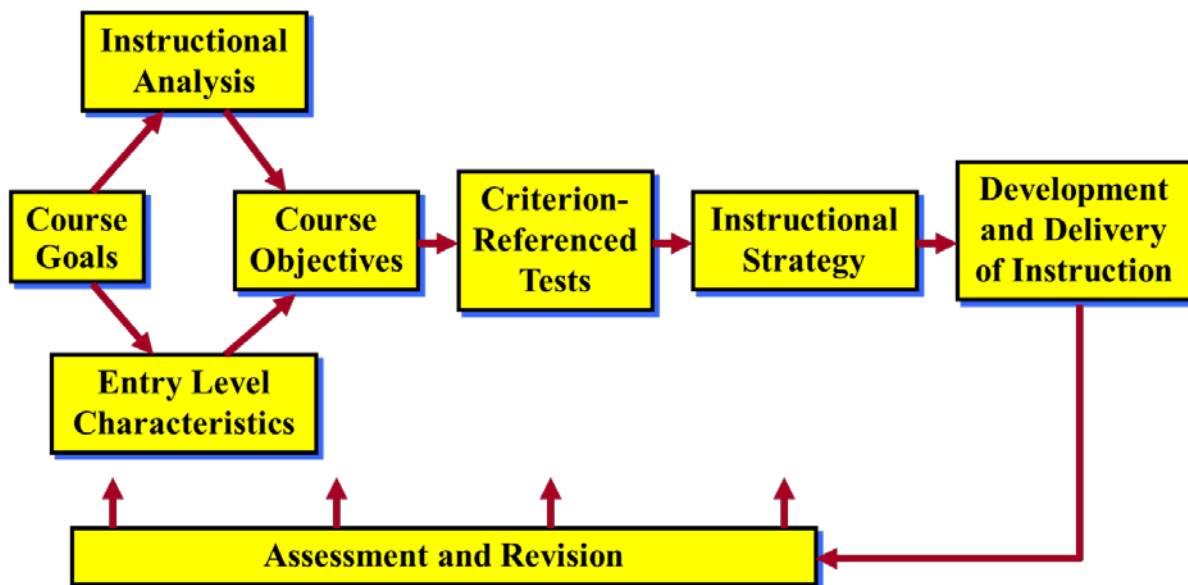

Figure 1: The Systematic Design of Instruction process³

Course Goals

The course goal is a short general statement of what students will be able to do when course is completed. This goal is often influenced by the reason for adding a new course to the curriculum. The new course might be in response to a change in technology, a mandate from the university, input from industry, accreditation changes, or internal assessment from a program review.

The course goal for ARCE 106 is to *describe the integration of various engineered building systems and explain how they relate to the profession of architectural engineering*. The goal for the course was influenced by those factors already described. The program needed a course to replace the content in a previous materials of construction course and derive the benefits associated with a freshman engineering experience. Some of the intended benefits of the course such as reduced attrition, group camaraderie, and engagement in the profession are not included in the course goal since they do not describe what students will be able to do as a result of the course. Some were able to be included in the course objectives in a later step and the instructional strategy is geared to attain some of these benefits.

Instructional Analysis

The instructional analysis includes describing how a new course fits into the rest of the curriculum, and defining the content that must be covered to meet the course goal. At the same time, the entry characteristics of the learners are examined. While there is a detailed flowchart that shows every course in the ARCE curriculum, Figure 2 shows a simplified version of how ARCE 106 fits into the existing curriculum.

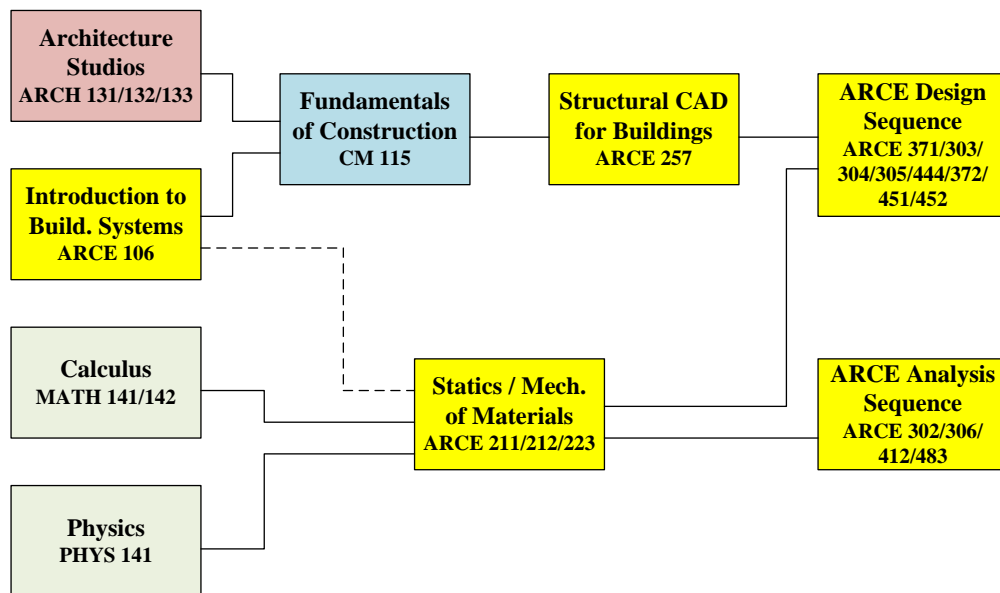

Figure 2: Simplified Flowchart showing how ARCE 106 fits into the ARCE Curriculum

ARCE 106 and the three freshman architecture studios (ARCH 131/132/133) are preparation for the fundamentals of construction management studio (CM 115). CM115 is required for the Structural CAD course (ARCE 257) which is needed to produce construction documents and constructible designs in the ARCE design sequence which, in turn, offers lecture courses and follow-on design labs in timber, masonry, reinforced concrete and steel buildings. The statics and mechanic of materials courses are preceded by necessary prerequisite calculus and physics courses. ARCE 106, while not a formal pre-requisite, provides an introduction to structures such as arches and trusses that will be covered in greater detail in those courses. The statics and mechanics of materials sequence provides a gateway to both the analysis sequence (structural analysis, structural dynamics, and seismic design) and the design sequence. A critical point is that if a new course does not have any prerequisites or follow-on requirements in the curriculum, one needs to question why it is being added to the curriculum.

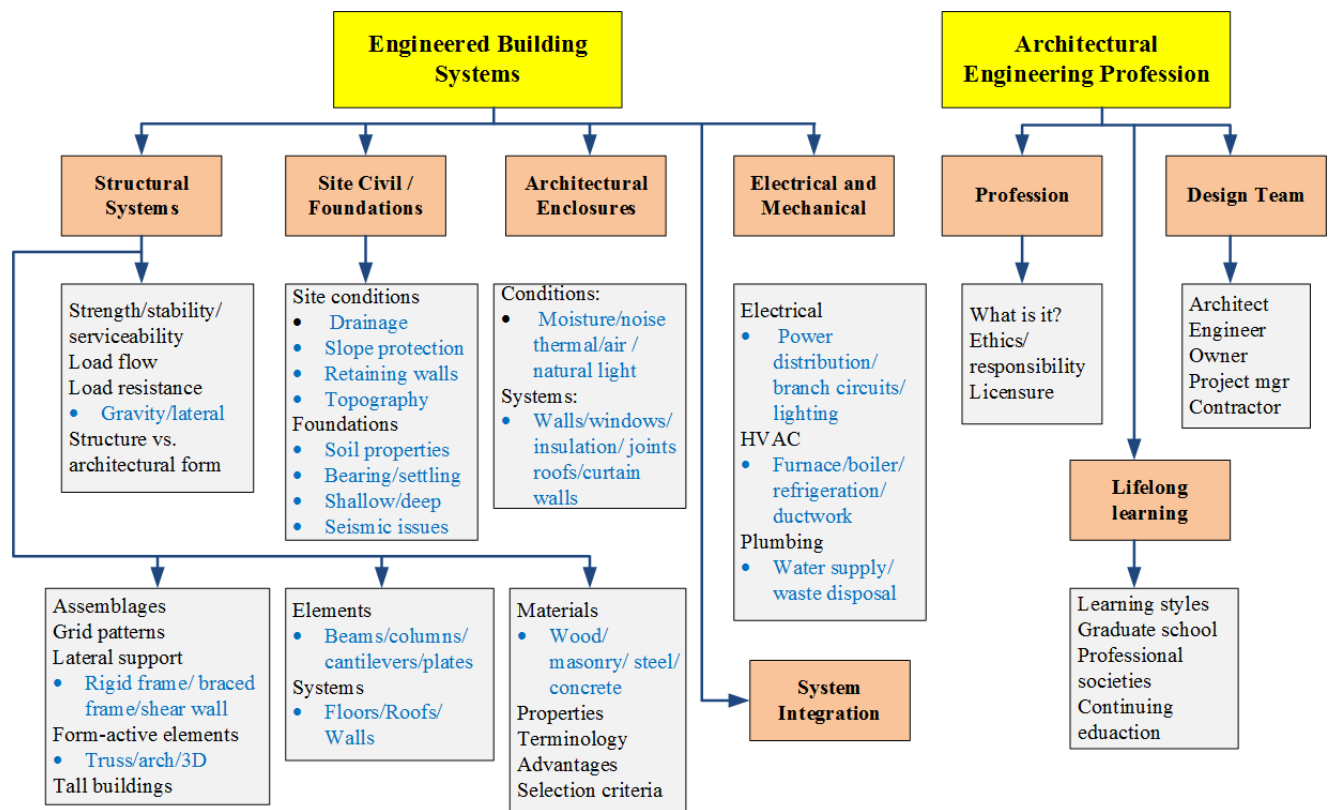

Figure 3: A Map of the Content Domain for ARCE 106

Identification of the major concepts, subordinate concepts, and skills flow from an analysis of the learning required in the course being designed. This can be depicted visually with a map of the content domain which is a diagram that shows these skills and the relationships between them. Figure 3 shows a content map for ARCE 106 based on the course goal of describing the integration

of various engineered building systems and explaining how they relate to the profession of architectural engineering.

Engineered building systems are divided into structural, architectural enclosure, earth/foundation, and mechanical/electrical/plumbing systems. These systems are further subdivided into the topics shown. The structural system is subdivided into structural principles and application of those principles using reinforced concrete, masonry, wood, and steel. The profession of architectural engineering requires coverage of what constitutes a profession, the key players on a design-construction team, and the need for lifelong learning. The content map ultimately shows a hierarchical picture of what needs to be learned to successfully meet the course goal.

Entry Level Characteristics

The entry level characteristics of the learners should identify skills that students must bring prior to beginning instruction, specify where these skills are obtained (pre-requisites) and describe the specific characteristics of the learners. The skills needed for ARCE 106 are basic reading and writing communication skills, a rudimentary ability in arithmetic, a fundamental background in science, and software skills in word processing and PowerPoint. While they come from diverse backgrounds, the educational experience of the ARCE 106 freshmen is fairly homogenous. All have met the admission requirements into the California State University system¹⁶ which includes high school math, English, and laboratory science requirements. Because of the competitiveness of entering Cal Poly, they also come with extraordinary high school grade point averages and College Board scores. The same population is taking architecture studios and at least introductory calculus during the same quarter as this course. Many are coming in with advanced placement or prior college credit. The characteristics of ARCE freshmen not only suggest that they are well prepared for this course, but additionally the content can be presented at a more rapid pace and higher cognitive level than with other populations. Conversely, most are new freshman experiencing their first quarter away from home in a college environment, which argues for a high degree of structure and frequent intermediate assignments with feedback to ensure student success.

Course Objectives

The course objectives are specific statements of what learners will be able to do at the completion of the course. These objectives are based on the course goal, instructional analysis and entry level characteristics. Ideally the course objectives use appropriate action verbs that target the desired cognitive level of attainment. Bloom's taxonomy¹⁷ is a useful platform for doing this. The course objectives for ARCE 106 are:

- Identify and illustrate building systems in our day-to-day lives and explain the functions they serve.

- Articulate the key components of different building systems with their role towards a successful building in an architectural engineering context.
- Describe how specific buildings integrate various building systems together successfully.
- Compare/Contrast when to use different structural systems and different structural materials under various scenarios.
- Describe the roles/responsibilities of the various professions involved in the creation of a building.
- Develop a sense of community with your fellow ARCE students.

Criterion-Reference Tests

While it may seem counter-intuitive, the next step is to develop criterion-referenced tests. These measure the learners' accomplishment of the objectives using absolute (not relative) standards of achievement. These might include homework, quizzes, design problems, final exam, oral presentations, group exercises, laboratory exercises, or project deliverables. This step makes sense when considering how one will measure whether the course objectives have been attained. The measures chosen should best relate to the cognitive level the objectives are attempting to achieve. Lower cognitive level tasks requiring recitation, comprehension, or application can easily be measured with a quiz or test. Higher cognitive level tasks requiring analysis, design or evaluation may necessitate a lab report, design project or research study.

Because ARCE 106 has a high volume of content presented at an introductory level, a midterm examination and final examination will adequately measure the students' attainment of the course objectives. To ensure student success through structured study and practice, weekly homework is assigned and graded. Because students can collaborate freely on the homework, it is used as a tool for exam preparation as well as an assessment tool itself. Deeper learning will come from physical understanding and student engagement provided by a series of hands-on activities. Some of the objectives require critical thinking and introspection. The course has two oral presentations and a major role-playing exercise to provide this. Finally, many of the activities are performed in groups which helps develop and assess the sense of community that the course is intended to facilitate. The variety of pedagogical approaches utilized allows this course to target the different course objectives more successfully (See Fig. 4).

Based on the above rationale, the chosen grading scheme for the ARCE 106 course is as follows:

Homework Assignments	25%
Group Projects & Activities	25%
Mid-term	20%
Final Exam	20%
Instructor Grade	10%

The instructor grade does not directly assess attainment of the lesson objectives, but does measure student engagement. The instructor grade is taken from group activities conducted during the lectures. Students typically spend one to three minutes in a group working on a specific question or activity. The results provide information on student attendance at lecture, level of engagement in an activity, and degree of critical thinking present in the solution.

Instructional Strategy

Once the entry capabilities of the students are determined, the course objectives are defined, and the methods of assessment are decided, an instructional strategy is needed to take the students from their entry into the course to successful attainment of the those objectives. This strategy considers pre-instructional activities, presentation of information, practice and feedback, testing, and any follow-up activities. The strategy is based on a knowledge of how students learn, the content to be taught, and the characteristics of the learners.



Figure 4: ARCE 106 consists of a large group lecture and a small group activity each week

In the case of ARCE 106, the strategy was also driven by the course being limited to two academic credits (two class meetings per week) and a ten-week quarter. In an effort to also maintain some efficiency of instruction, the first unit was designated as a large group lecture where the entire ARCE freshman class receives the instruction at the same time. The 50 minute lectures are PowerPoint-based and contain periodic demonstrations, videos, and small group activities. The second unit is designated as an activity period which lasts 110 minutes and contains no more than 24 students. The activity periods are more intimate, interactive and hands-on. The lecture allows the entire ARCE freshman cohort to be in the same room at the

same time once a week. The activity provides more personalized instruction and allows sufficient time for students to be more engaged in active learning.

The selected course textbook is *Building Construction Illustrated*¹⁸, which contains multiple illustrations on every page and introduces students to building materials, structural systems, and construction techniques. The book appears friendly and is very readable, yet is extremely rich with content. Furthermore, structural engineers often communicate with graphics and this text shows students how to do it effectively.

The learning strategy was to divide the course into weekly lesson blocks based on the content shown in the map of the content domain in Fig. 3. Each lesson block had its own lesson objectives that support the course learning objectives. A lesson block starts with a lecture that introduces content, a homework assignment where students use the textbook and lecture to answer questions related to the lesson objectives, and a graded hands-on activity to further build on the material. The lesson objectives associated with each lesson block are shown in Appendix A. The students are assessed with a midterm exam during the fifth week and a comprehensive final examination at the end.

Development and Delivery of Instruction

The development and delivery of instruction includes creating homework assignments, reading assignments, classroom lectures and activities. It also includes office hours, grading, creating a syllabus, writing exams, and coordinating outside support for the activities. The week-by-week lesson blocks are as follow:

Week #1

Lecture: Introduction to course and history of the college

Activity: Students scan the textbook and find a topic which piques their interest. Students present this topic to the class in a one to three minute presentation using two PowerPoint slides. The first slide covers their chosen topic and the second introduces themselves to the class and covers a personal interest or hobby. The students then take the Felder learning style survey^{19,20} and discuss how various students learn differently (See Fig. 5).

Purpose: It forces the students to scan the textbook for content, learn something about a topic on their own, practice oral and graphical communication, and start to build a sense of community. The learning style survey enhances awareness about how an individual student prefers to learn and how that style compares to the rest of their classmates.

Week #2

Lecture: An Overview of Structural Systems

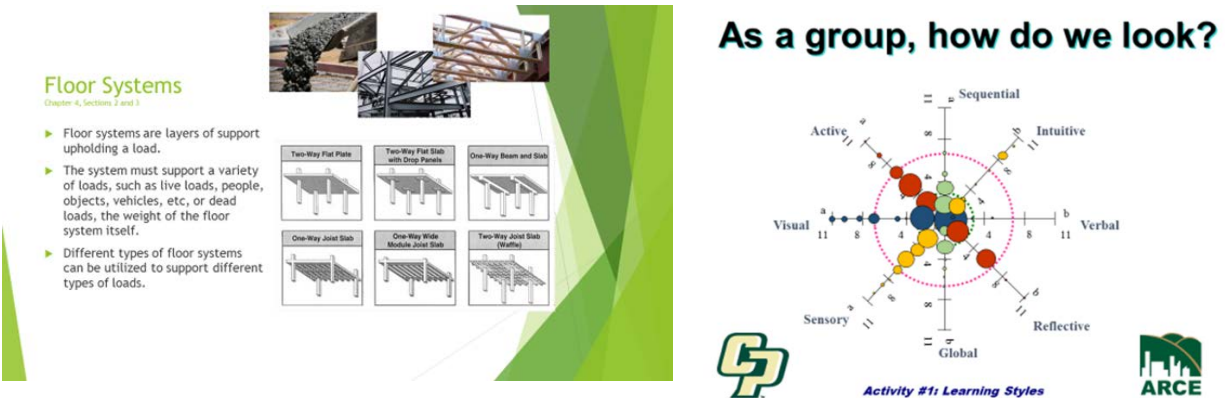

Figure 5: The first week activity included student presentations and an assessment of student learning style preferences

Activity: Students are introduced to axial force alignments and observe the relationships between tension and compression in form-active shapes using arches and cables. After an introductory presentation on funiculars and catenaries, the 24 students are divided into three teams of eight and rotate round-robin through three stations: roman arch, flat arch, and cables. Using chains and blocks, the students at each station construct an arch or cable structure and answer questions based on what is physically observed (See Fig. 6). The activity concludes with a discussion on how the same principles work in three dimensions.

Purpose: Students are able to observe non-intuitive principles using physical models. By actually observing how the axial load path must remain within the kern of an arch, students can begin to predict the constructability of form-active shapes.



Figure 6: Activity 2 featured an investigation of arch and cable structures

Week #3

Lecture: Concrete & Masonry Structural Systems

Activity: While the lecture focuses on the specific materials, the activity introduces connections. Specifically, Hilti Corporation representatives travel to campus and assist with the

activity. The 24 students are divided into two teams of twelve students where the students rotate between two stations. The first station is with the course instructor in the class room where students use Hilti technical literature to predict the tensile pullout strength of both mechanical and adhesive anchor bolts. The second station is conducted in the concrete yard where Hilti engineers supervise students as they drill holes in concrete and place the various anchor bolts (See Fig. 7). As a target of opportunity, students also use the powder activated driver to force nails into steel. Finally all 24 students are assembled as several anchor bolts are pulled from the concrete to determine actual pullout strength.

Purpose: Students are able to touch concrete and physically see how items are attached post-placement to concrete. The results introduce the concept of factor of safety, reliability, and why the actual pullout strength is greater than the literature advertised.



Figure 7: Activity was assisted by Hilti and tested the placement and pullout strength of concrete anchor bolts.

Week #4

Lecture: Wood Structural Systems

Activity: While the lecture focuses on the specific materials, the activity introduces connections. Specifically, Simpson Strong-Tie representatives travel to campus and assist with the activity. The 24 students are divided into six teams of four students where each student team assembles various joist hanger connections and uplift (hurricane) ties. Various teams use nails driven with a hammer, nails driven with a pneumatic palm nailer, or screws driven with a power drill to connect the hangars to the lumber (See Fig 8). The assembled connections are tested to

failure on the universal testing machine. Students record the ultimate load and the installation time for each connection.

Purpose: Students physically experience how difficult it can be to drive a nail in a confined space and observe the various options for connecting pieces of lumber. Students draw conclusions about the tradeoffs between ease and speed of installation versus the strength of the connection.



Figure 8: ARCE 106 students prepare and test timber connections during Activity #4

Week #5

Lecture: Steel Structural Systems

Activity: While the lecture focuses on the specific materials, the activity introduces connections. A quick classroom presentation introduces students to the concept of a stress-strain curve and a yield stress. The 24 students are divided into eight teams of three students where the students rotate between two stations. Four teams go to the American Institute of Steel Construction (AISC) structural steel teaching sculpture which shows a variety of steel welded and bolted connections. Using the sculpture and the course textbook, each team answers a series of questions regarding the connections and steel member configurations. The other four teams go to the welding shop where each student welds two pieces of plate steel together. A specialist from the college shop provides a safety orientation and oversees the grinding of the steel and the welding. Samples are created with a one-sided butt weld, butt weld on both sides, and butt weld on beveled steel with welds on both one side and two (See Fig. 9). After all teams have been through both stations, the samples are tested to failure on the universal testing machine.



Figure 9: Students examine steel connections and learn to weld during Activity #5

Purpose: Each student gets to place a bead of weld on steel and experiences the skill required to make a proper weld. Students learn about strength of steel in very physical terms and learn that a designed connection should exceed the strength of the connecting material. On the sculpture, the students get to actually observe and touch coped beams, webbed trusses, welded connections, bolted connections, standard steel shapes, seismic joints, leveling nuts, and corrugated decking.

Week #6

Lecture: Midterm exam



Figure 10: Students assemble truss structures prepared from digital fabrication equipment and test them to failure in Activity #6

Activity: The activity begins in the classroom with a presentation on truss structures, their applications and their advantages. The 24 person class takes a tour of the digital fabrication laboratory (DFAB) where they are introduced to the laser cutters and three-dimensional printers. The students are divided into four teams of six students. Each student team constructs a truss bridge whose members were produced on the laser cutter and are fastened with threaded plastic pins. Each bridge is weighed and is then tested to failure, providing a strength to weight ratio metric (See Fig. 10).

Purpose: Students visit the DFAB laboratory that they will hopefully use in the future. Students are introduced to trusses, the first structure they will actually analyze when they take a statics class. Constructing a truss reinforces the concept of long slender members connected by pins. The strength to weight ratio offers physical proof of the efficiency of the structure. The violent failure of the truss allows a discussion of stability considerations such as buckling.

Week #7

Lecture: Earth and Foundation Systems

Activity: Students trace the flow of water as it would drain across planted and paved surface areas by measuring slopes and following the predicted path of water from where it originates to the catch basins where it enters the storm sewer system. The flow pattern is drawn on a supplied map using arrows. Students also use rulers, tape measures and levels to measure the slopes on handicapped ramps to determine if they meet code requirements (See Fig. 11).

Students indicate their preference to role-play an architect/engineer, project manager or contractor for the Week #10 K'nexercise which is designed to model the design-bid-build project delivery method. The K'nexercise was developed and has been used successfully at the United States Military Academy^{20,21}.



Figure 11: Students in ARCE 106 measure slopes and analyze a drainage pattern during Activity #7. The drainage exercise was made more realistic when a truck unintentionally backed into a fire hydrant during the activity

Purpose: Students obtain a physical understanding of slope magnitude through actual measurement. The lecture emphasizes storm sewer systems, erosion protection, drainage control, and topography. The activity shows a physical example of these concepts and reinforces that water flows perpendicular to contour lines.

Week #8

Lecture: Architectural Enclosure Systems

Activity: The 24 students are divided into eight groups of three students. Each group must investigate a historic building system failure, prepare a written report and make a four to six minute presentation on the failure. The presentation must incorporate what type of building system failed, what key components of that system failed and why, who suffered from the event, which professions were involved with the cause, and what could have been done differently. A bibliography of resources is provided to the students.

The roles for the K'nexercise are identified. The architect/engineer (AE) teams are given the functional requirements for a pedestrian bridge that they will design using K'nex toys. They have a week to design the bridge and submit a set of drawings and specifications.

Purpose: The students are introduced to risks associated with the design and construction of buildings, and to the relevancy of life-long learning that occurs within the building profession. The presentation of eight failures emphasize the degree to which society depends on its engineers and the disastrous consequences that can occur when they fail. Students continue to learn on their own, practice oral, written and graphical communication, and continue to build a sense of community. In all group activities, students are randomly selected and get to know more of their classmates.

Week #9

Lecture: Electrical Systems and Lighting

Activity: The 24 students are divided into eight teams of three students. There are two stations through which the students rotate. Half of the students remain in the classroom. Each three-person team wires a specific circuit. The circuits include a switched outlet, a three-way switch, a light that is controlled by a motion sensor, and a fan with a variable resistor that plugs into an outlet. The instructor inspects the completed circuits and student teams gather as the circuit displays are plugged into an outlet. The other student teams are given the electrical drawings for the nearby Materials Demonstration laboratory. The students visit the laboratory building, attempt to read the drawings in conjunction with their visual observation, and answer questions regarding the lighting, the outlets, the computer-controlled skylights and the main panel box (See Fig. 12).

Afterwards, the project managers (PM) for the K'nexercise are provide with the AE drawings for the pedestrian bridge. The PM teams have a week to review the drawings, brief the owners, and charge the AE teams with making any corrections.

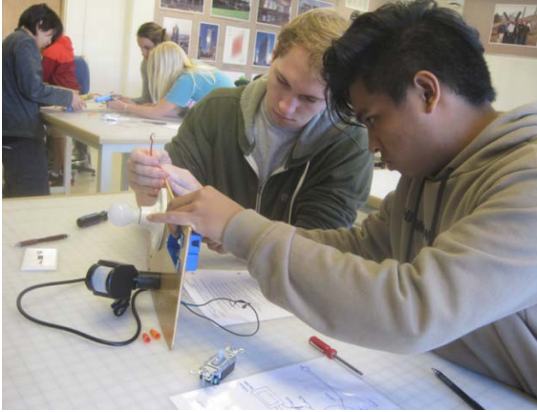

Figure 12: Activity #9 of ARCE 106 consisted of wiring circuits and reading electrical drawings

Purpose: Students gain a better understanding of how electricity flows by physically wiring a circuit to include identifying hot wires, neutrals and grounding wires. They experience the difficulty of attaching wires in a confined space and see actual electrical components such as wire, wire nuts, switches, lights and outlets. Students are introduced to electrical drawings and observe how information is communicated graphically. A greater connection is made by comparing the drawings to what is actually in the laboratory building. The concept of branch circuits and a main panel box is reinforced.

The contractor teams for the K'nexercise are presented with the approved drawings for the K'nex pedestrian bridge. Based on the plans, each contractor has a week to submit requests for information (RFI) and prepare a bid based on labor, materials, overhead and profit.

Week #10

Lecture: Mechanical and Plumbing Systems

Activity: The K'nexercise is completed. A bid opening ceremony identifies the lowest bidder. A substantial bonus is given for the low bid, but all contractor teams build the structure. The PM team oversees the construction and records the time of construction. The projects are inspected and turned over to the owners for load testing (See Fig. 13). The AE, PM and contractor teams are all graded on a set of performance measures that correlate to their assigned roles in the design-construction process. The results and lessons learned are presented during the first hour of the final exam.

Purpose: By role playing the AE, PM, or contractor on an actual project, the students gain a greater understanding of the duties and responsibilities of these participants in the design-construction process. The rules and grading for the exercise are designed to have the students display the same motivations and dynamics as their real life counterparts.



Figure 13: ARCE 106 K'nexercise stretched over several activity periods and modeled the design-bid-build project delivery method

Week #0 or Week #11

The Fall quarter contains an extra half week which provides either an additional lecture at the end of the quarter or extra activity at the beginning of the quarter. If only the additional lecture is available, the topics include ethics, professional responsibility and what constitutes a profession. If only the activity is available, the same lecture content is covered and the second hour is the Marshmallow Challenge, which was originally introduced by Peter Skillman and popularized by Tom Wujec at a TED conference in 2010.²² Teams of students compete to create the tallest structure to support a marshmallow using only spaghetti, tape and string with a given time constraint (See Fig. 14).. Besides being an interesting team-building activity, the primary purpose of this activity is to teach engineering lessons on the power of creative prototyping and folly of hidden assumptions.



Figure 14: The additional half week of fall quarter covers ethics and professionalism with a marshmallow building activity depending on when the extra week occurs.

Assessment and Revision

There were numerous assessment tools available throughout the conduct of the course. These included student engagement and enthusiasm, student performance on tasks, faculty evaluation reports from the students, and instructor assessment as to how well a lecture, activity or assignment met its intended purpose. With two instructors team-teaching the course, there was always an extra set of eyes to observe and critique.

A formal survey was given to the students at the end of the course asking them to rate their attainment of the course objectives on a Likert scale of 1 to 5 using the following definitions:

- 5 = Very confident that I have met the objective
- 4 = Somewhat confident that I have met the objective
- 3 = Not sure
- 2 = Somewhat confident that I have not met the objective
- 1 = Very confident that I have not met the objective

The survey results for the iterations taught Fall Quarter 2015 and Fall Quarter 2016 are as shown in Fig. 15.

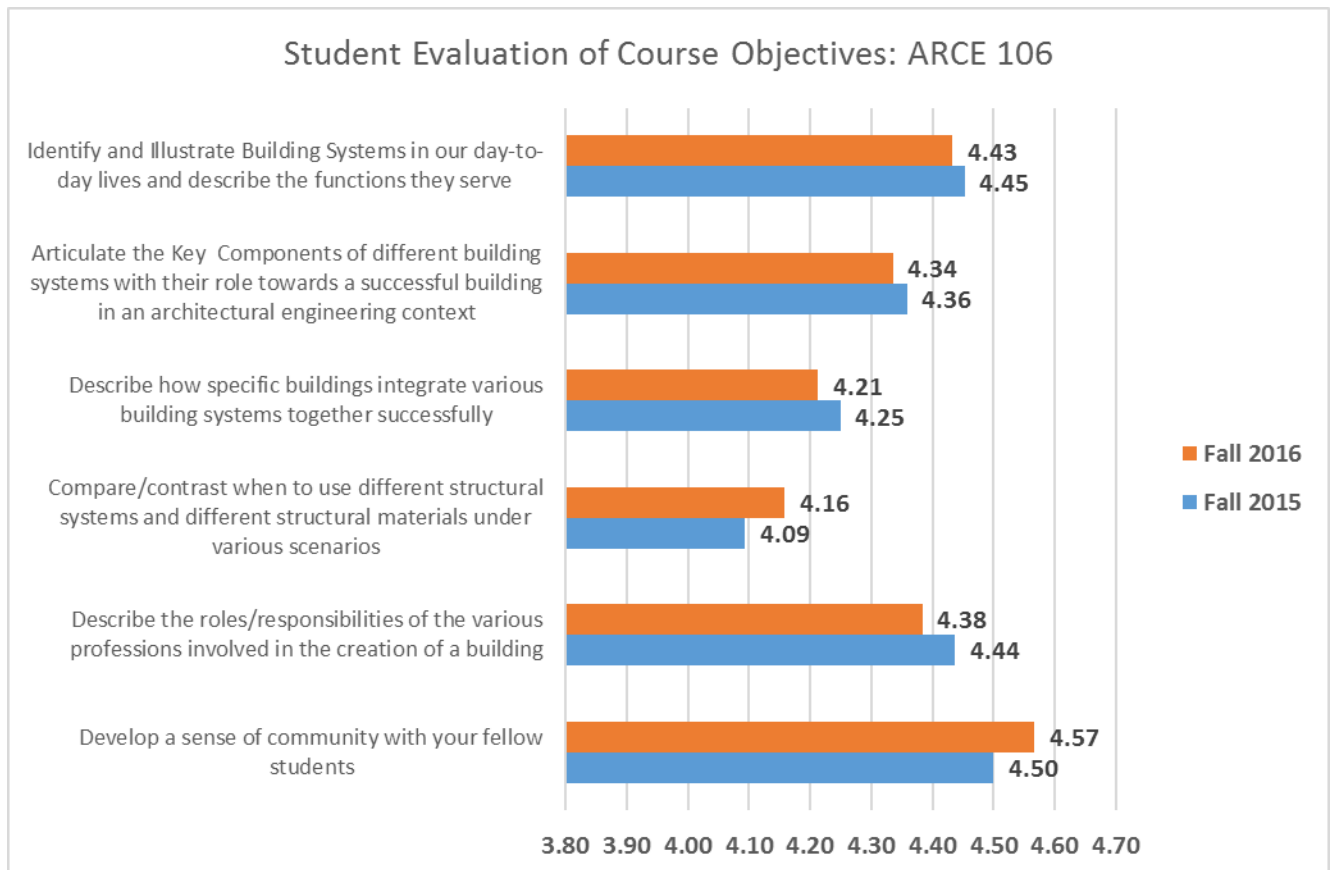

Figure 15: Results of student survey on attainment of course objectives for ARCE 106

The results show that the student's confidence in their attainment of the learning objectives was almost identical between the two iterations of the course. They felt most confident that they were developing a sense of community. They felt confident as well with the objectives that required them to identify and describe specific components or elements of items covered in the course. They felt least confident about their ability to compare or contrast building systems or describe how they are integrated. The student averages were above "somewhat confident" for all of the course objectives.

Because the activities required the major investment of effort and expense, the students were asked to rate the various activities using the following rubric:

- 5 = I really enjoyed and got a lot out of this activity.
- 4 = I sort of enjoyed the activity and got something out of it
- 3 = Neutral, I neither liked nor disliked the activity and got marginal benefit
- 2 = I sort of disliked the activity and got little from it
- 1 = I disliked this activity, or thought it was a waste of time.

The results are shown in Fig. 16. Note that the electrical activities were very different for the two iterations of the course. During the Fall Quarter 2015 iteration, the activity consisted of a tour of the engineering building led by an electrical engineer and a mechanical engineer from the university facilities department. The 24 students in an activity were divided in half and 12 students got a 40 minute electrical tour while the other 12 took a mechanical tour and then the groups switched. Despite the generous support from the university, the students rated this activity as the least interesting and effective. As a result, the Fall Quarter 2016 iteration contained the electrical activity listed earlier. The ratings for that activity were low as well, but for different reasons. Rather than being boring, the activity was described as being too confusing, especially with reading electrical drawings. The slope and drainage activity was also rated lower than the other activities. The arch activity, the laser cut truss activity and the K'nexercise received the highest ratings over both iterations of the course.

The final examination was designed to test the course concepts and objectives in a comprehensive sense. The course average for the Fall 2015 iteration of the exam was 89.1% and was 85.8% for the Fall 2016 iteration. The exam covered material from the entire course and the scores were not adjusted, so this becomes an indicator that the students successfully attained the objectives.

The Fall 2016 final examination had a question that directly tested two course objectives. The Version A of the exam directly related to the course objective, "Describe how specific buildings integrate various building systems together successfully" by asking: *Describe how the auditorium in which you now sit integrates various building systems together. Give examples.*

The Version B of the exam directly related to the course objective, “Articulate the key components of different building systems with their role towards a successful building in an architectural engineering context.” by asking: *Consider the key components of different building systems in the auditorium in which you are now sitting. Articulate their role towards a successful building in an architectural engineering context.*

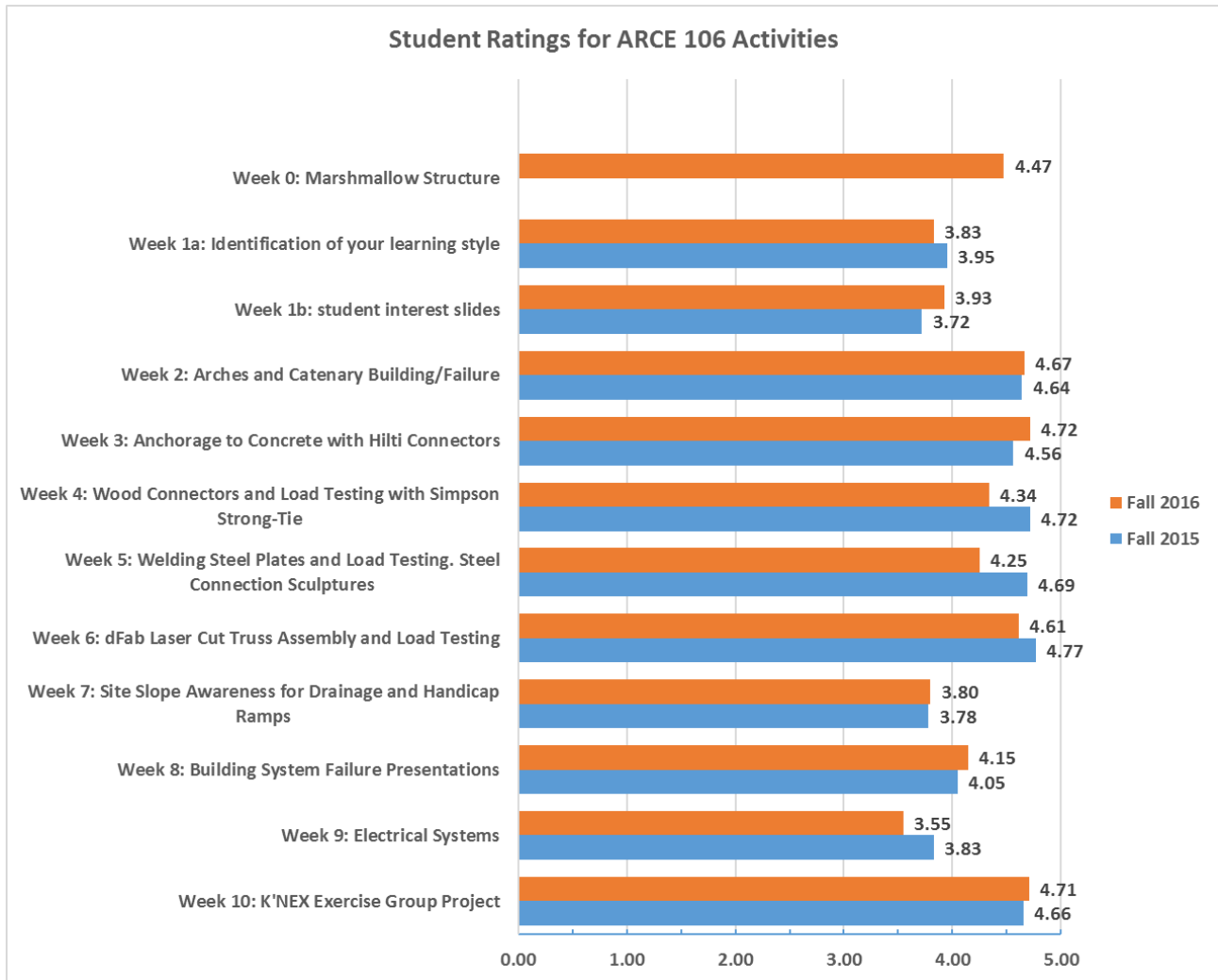

Figure 16: Results of student survey rating the activities for ARCE 106

In both cases, the question was worth 3 points using the following rubric:

3 points: Included at least two separate building systems and three good examples. Showed evidence of how systems are integrated rather than unconnected. Demonstrated critical thinking.

2 points: Fewer than three good examples. Mixed architectural concepts with architectural engineering concepts. Thought process somewhat superficial and shallow

1 point: Only considered a single building system. Single example or no examples. Significant confusion between architecture and engineering. Very superficial; demonstrates no real thought.

0 points: Did not answer or entire answer was either erroneous or too simplistic to have demonstrated any thought.

An additional element was later added to the rubric:

4 points: Totally blew us away. The answer was so much better, more complete and insightful than we would ever expect from a freshmen student taking a timed exam.

Version A		Version B	
Describe how specific buildings integrate various building systems together successfully		Articulate the key components of different building systems with their role towards a successful building in an architectural engineering context.	
Score	Number of students	Score	Number of students
4	1	4	3
3	33	3	26
2	6	2	6
1	3	1	4
0	2	0	1
Weighted Average = 2.62		Weighted Average = 2.65	
% With Score of 3 or better = 75.5%		% With Score of 3 or better = 72.5%	

Table 1: Direct measure results of student performance on two course objectives from the final exam

The expectation is that at least 70% of the students would meet the standard by getting a score of 3 or higher. The results for the 45 students who took Version A of the exam and the 40 students who took version B are shown in Table 1. For both questions, the students appear to have performed to a satisfactory standard.

Conclusions

The assessment data from two iterations of the ARCE 106 course indicate that the students are engaged and enjoy the course. The students are meeting the course objectives and feel a greater sense of belonging in the department. The common lectures allowed the presentation of a high volume of content in an efficient manner and brought the students together as an entire ARCE freshman cohort. The students especially appreciated the hands-on, physical activities and rated them most favorably. As a side benefit, the department head and at least one other faculty member know the first name and faces of the entire incoming freshman class by the end of fall quarter. Due to the lag time of data, it will take another year or two to determine if this course has any effect on early attrition from the ARCE program.

As a final aside, the ARCE 106 course is dedicated to Carson Starkey, an ARCE freshman who died in 2008. His death and the fact that none of the ARCE faculty knew him personally was an additional motivation for this course. His parents, Scott and Julia Starkey, started *Awake, Aware, Alive*²³ in response to Carson's death to help prevent loss of life to alcohol poisoning by educating teens, young adults and parents on the dangers and symptoms of alcohol overdose. The Starkeys shared in the cutting of the ribbon for this course (See Fig. 17) and talk to the freshmen about Carson's experience on the first day of class. The Starkeys have created four scholarships for ARCE freshmen.



Figure 17: Julia and Scott Starkey participate in the ARCE 106 ribbon-cutting ceremony

Future Directions

The content of the course seems to be about right. There is no room to add additional subjects and the students did not provide any insights for what could or should be eliminated. There are a couple of activities that could be improved. In the future, students will go to the DFAB lab prior to the class activity and actually use the laser cutter and 3D printer to create something themselves and use the equipment. The electrical activity where students wire a circuit and read electrical drawings is an improvement over the previous building tour. Nevertheless, it needs an adjustment. Many students commented that the plans were too confusing. Some introductory instruction will hopefully make the drawings less intimidating and will relieve that frustration. The *Building Construction Illustrated* textbook is excellent. The ARCE faculty will be encouraged to incorporate it into other courses in the curriculum.

Bibliography

- ¹ ABET Inc. "Criteria for Accrediting Engineering Programs," Effective for Evaluations During the 2016-2017 Accreditation Cycle, Engineering Accreditation Commission, Accreditation Board for Engineering and Technology,
- ² Estes, A.C. and Estrada, H. "The Nation's Architectural Engineering Programs: A Diverse Group" Proceedings of the Architectural Engineering Institute Annual Conference 2008, ASCE, Denver, CO. September 25-27, 2008.
- ³ Dick, W. and L. M. Carey, *The Systematic Design of Instruction*, Addison-Wesley, (1996).
- ⁴ Brannan, K.P., Murden, J.A., Strout, R.H., Fallon, D.J., and Davis, W.J. W. J. Davis The Citadel 101 Freshman Initiative 2000 ASEE Southeast Section Conference (<http://icee.usm.edu/ICEE/conferences/Conference%20Files/ASEE2001/2001026.pdf> accessed January 1, 2017).
- ⁵ Shepard, S.D., Macatangay, K., Colby, A., Sullivan, W. M. (2008) "Educating engineers, designing for the future of the field" Book Highlights of research published by Carnegie Foundation for Advancement of Teaching, 2008 (http://archive.carnegiefoundation.org/pdfs/elibrary/elibrary_pdf_769.pdf accessed December 31, 2016).
- ⁶ Besterfield-Sacre, M., Atman, C. J. and Shuman, L. J. (1997), Characteristics of Freshman Engineering Students: Models for Determining Student Attrition in Engineering. *Journal of Engineering Education*, 86: 139-149.
- ⁷ Mamaril, N. A., Usher, E. L., Li, C. R., Economy, D. R. and Kennedy, M. S. (2016), Measuring Undergraduate Students' Engineering Self-Efficacy: A Validation Study. *J. Eng. Educ.*, 105: 366-395.
- ⁸ Burton, J. D. and White, D. M. (1999), Selecting a Model for Freshman Engineering Design. *Journal of Engineering Education*, 88: 327-332.
- ⁹ Gunn, C., & Somerton, C., An Engineering Laboratory Experience For A Freshman Engineering Class Paper presented at 2004 ASEE Annual Conference and Exposition, June 2014 Salt Lake City, Utah.
- ¹⁰ Alava, J.D. and Gardiner, K.M. The Development of the First Year Engineering Experience. Proceedings of Fall 2010 Mid-Atlantic ASEE Conference, October 15-16, 2010, Villanova University. (<http://www.asee.org/documents/sections/middle-atlantic/fall-2010/01-The-Development-of-the-First-Year-Engineering-Experience.pdf> accessed December 31, 2016).
- ¹¹ Mullenax, C. and Walker, C. (2004). "Increasing Freshman Contact with Engineers—A Revamp of ENGR101, Tulane's Freshman Intro to Engineering Course." Proceedings of the 2004 ASEE Annual Conference and Exposition.
- ¹² Najafi, F. Jenner, K., and Jayasekaran, S. (2009). "Civil Engineering Introduction to Freshman Engineers," Proceedings of the 2009 ASEE Annual Conference and Exposition.
- ¹³ Everett, J., Morgan, J., Stanizone, J., and Mallouk, K (2014). "A Hybrid Flipped First Year Engineering Course," Proceedings of the 2014 ASEE Annual Conference and Exposition.
- ¹⁴ Gagne, R. M., L.J. Briggs and W.W. Wager, *Principles of Instructional Design*, Wadsworth Publishing, (1992)
- ¹⁵ Estes, A.C., Welch, R.W., Ressler, S.J., Dennis, N., Larson, D., Considine, C., Nilsson, T., O'Neill, R.J., O'Brien, J. and Lenox, T., "Ten Years of ExCEEEd: Making a Difference in the Profession." *The International Journal of Engineering Education*, 26(1) 2010, 141-154.
- ¹⁶ California State University. CSU Mentor, Admission Requirements, High School Subject Requirements (2017) (https://secure.csumentor.edu/planning/high_school/subjects.asp accessed January 2, 2017)
- ¹⁷ Bloom, Benjamin S., ed. *Taxonomy of Educational Objectives*. New York: Longman, 1956.
- ¹⁸ Ching, F.D., *Building Construction Illustrated* (5th ed.). Hoboken, New Jersey: Wiley and Sons, 2014.
- ¹⁹ Felder, R., *How Students Learn: Adapting Teaching Styles to Learning Styles*, *Frontiers in Education Conference Proceedings*, 489-493, (1988).
- ²⁰ Soloman, B.A. and Felder, R.M. Index of Learning Styles Questionnaire, North Carolina State University, (<https://www.webtools.ncsu.edu/learningstyles/> accessed January 2, 2017)
- ²¹ Ressler, S. "The Project Management K'nexercise: Using Role-Playing to Facilitate Learning About Design and Construction." 1998 ASEE Annual Conference and Exposition Proceedings, ASEE, 1998.
- ²² Estes, A., LaChance, E, and Ressler, S. "K'nexercise: Introducing Students to the Key Participants in the Design-Construction Process." 2002 ASEE Annual Conference and Exposition Proceedings, ASEE, 2002.
- ²³ Wujec, T. The Marshmallow Challenge, Tom Wujec, (<https://www.themarshmallowchallenge.com> accessed January 16, 2017).
- ²⁴ Awake, Aware, Alive. Austin, TX (<http://awareawakealive.org/about/aware-awake-alive> accessed January 16, 2017)

Appendix A: Learning Block Objectives

Week 1: Introduction to Architectural Engineering and Building Systems

- List the major engineered systems of a building.
- Distinguish between strength, stability and serviceability.

Activity

- Identify and illustrate building systems in our day-to-day lives and describe the functions they serve.
- Develop a sense of community with your fellow students.
- Communicate effectively.

Week 2: An Overview of Structural Systems

- Identify and illustrate structural building systems in their many varied forms and describe the functions they serve.
- Compare and contrast different structural systems and their best uses.
- Identify the creative beauty at the intersection of engineering and architecture.

Activity

- Experience the critical nature of axial force alignments.
- Learn the relationships of tension and compression forces in form-active shapes.
- Be able to predict the constructability of various form-active shapes.

Week 3: Concrete & Masonry Structural Systems

- Describe the components of masonry walls and the purpose that they serve.
- Describe the elements of reinforced concrete slabs, beams, walls and columns and how they integrate into a building system.
- Describe the constructability challenges in reinforced concrete structures.
- Describe the advantages and disadvantages of reinforced concrete relative to other common construction materials.
- List the variety of structures made out of reinforced concrete.
- Communicate clearly and effectively.

Activity

- Install anchor bolts into concrete.
- Use technical literature to compute the tensile pullout strength of an anchor bolt.
- Compare the predicted pullout strength with the actual pullout strength of an anchor bolt and discuss the reasons for the difference.

Week 4: Wood Structural Systems

- Describe the components of wood framing and the purposes they serve.
- Estimate various wood member sizes and spacings necessary to function as a structural element.
- Describe the relative advantages and disadvantages of various wood elements.
- Explain the characteristics unique to wood structures compared with other systems.
- Communicate clearly and effectively.

Activity

- Experience installing wood connections (gloves available to help protect hands).
- Compare and contrast the relative strength of different connections.
- Compare and contrast the relative labor cost efficiencies of different connections.

Week 5: Steel Structural Systems

- Describe the process for making steel.
- Describe the elements of steel beams, columns, open web joists, decking, trusses and light-gage steel studs and how they integrate into a building system.
- Describe the types of available steel connections and the relative advantages of bolts versus welding.
- Describe the advantages and disadvantages of steel relative to other common construction materials.
- List the standard shapes available for steel construction in buildings.
- Communicate clearly and effectively.

Activity

- Explain how steel is connected to other structural elements.
- Weld two pieces of steel together.
- Describe what contributes to the strength of a good weld.

Week 6: Midterm Exam and Truss activity

Activity

- Define a truss structure and lists its advantages and applications.
- Use the laser cutter in the digital fabrication laboratory (DFAB) to construct a sample truss. Introduction to the 3D printer capabilities.
- Test the strength of a sample truss.

Week 7: Earth and Foundation Systems

- Describe soil characteristics to consider when designing a foundation.
- Evaluate topography for building site suitability.
- Describe how earth grading impacts site drainage and foundation considerations.
- Describe the differences between shallow and deep foundations.
- Describe the various failure modes of retaining walls.
- Communicate clearly and effectively.

Activity

- Evaluate the drainage pattern of an existing setting.
- Describe the physical significance slope magnitudes.
- Explain the Civil Engineering work done around us.

Week 8: Architectural Enclosure Systems

- Describe how moisture is prevented from entering a building.
- Describe how buildings are protected from outside temperature extremes.
- Describe how buildings are protected from thermal expansion/contraction.
- Describe the different envelopes used to integrally provide exterior beauty, light and thermal control, and moisture protection.

- Communicate clearly and effectively.

Activity

- Describe the risks associated with the design and construction of building systems.
- Demonstrate the importance of life-long learning.
- Communicate clearly and effectively.

Week 9: Electrical Systems and Lighting

- Describe how electricity is made and delivered to a building.
- Describe the equipment used to provide electrical power to a building.
- Describe the principles and equipment for lighting an area of a building.
- Communicate clearly and effectively.

Activity

- Wire the components of a simple electrical circuit.
- Use electrical drawings to describe the electrical components of a building.

Week 10: Mechanical and Plumbing Systems / K'NEXercise

- Describe the process for heating and cooling a building.
- Describe the major equipment used for heating, venting, and air conditioning.
- Describe the principles and equipment for supplying water and removing waste water from a building.
- List various elements of a building's fire protection system.
- Communicate clearly and effectively.

Activity

- Explain the roles and responsibilities of the key players in the Design-Construction Team.
- Explain the design-bid-build contracting process.
- Analyze how the quality of a constructed product is affected by interactions between the key players.

Week 11: Professionalism and Ethics

- Discuss the characteristics of a profession.
- Discuss the importance of professional licensure.
- Discuss the canons of the ASCE code of ethics.