

LACUNA MOZAMBIQUE:  
ADDING AN IMPORTANT PIECE TO THE AFRICAN  
JIGSAW PUZZLE

Inauguraldissertation

zur

Erlangung der Würde eines Doktors der Philosophie

vorgelegt der

Philosophisch-Naturwissenschaftlichen Fakultät

der Universität Basel

von

Gabriela Bueno Bittencourt-Silva

aus Brasilien

Basel, 2017

Genehmigt von der Philosophisch-Naturwissenschaftlichen Fakultät  
auf Antrag von

Prof. Dr. Peter Nagel (Fakultätsverantwortlicher)

PD Dr. Simon P. Loader (Dissertationsleiter)

Dr. Stefan Lötters (Korreferent)

Basel, den 18 April 2017

Prof. Dr. Martin Spiess (Dekan)

# TABLE OF CONTENTS

<b>Introduction</b>	1
Abstract	2
Historical Biogeography	2
East African biogeography	5
Mozambique	9
Objectives	11
Chapters Overview	12
References	14
<b>Chapter I</b>	20
The phylogenetic position and diversity of the enigmatic mongrel frog <i>Nothophryne</i> Poynton, 1963 (Amphibia, Anura)	
<b>Chapter II</b>	35
Impact of species delimitation and sampling on niche models and phylogeographical inference: a case study of the East African reed frog <i>Hyperolius substriatus</i> Ahl 1931	
<b>Chapter III</b>	61
Phylogeny and historical biogeography of the shovel-footed squeaker <i>Arthroleptis stenodactylus</i> Pfeffer, 1893	
<b>Synthesis</b>	86
<b>Acknowledgements</b>	100
<b>Supplementary Materials</b>	102
Chapter I	102
Chapter II	124
Chapter III	136
Additional Publications	151
<b>Curriculum Vitae</b>	173





# INTRODUCTION

### Abstract

Reconstructing historical biogeography is similar to assembling a jigsaw puzzle, every piece added reveals a little bit more of the overall picture. In this thesis I present and discuss the diversity of species found on the mountains of northern Mozambique and explore the relationships between assemblages of different mountains. This study reveals a complex history of lineage diversification within species of amphibians and proposes hypotheses to explain the biogeographical patterns observed. The mountains of northern Mozambique are in the crossroads between two faunal groups, Afrotropical and Palearctic, which partially explain the complexity of this region's biota. Most of the species found on these mountains are biogeographically related to the lowland forest of East Africa, though some strictly montane species are also present. Furthermore, this thesis provides predictions regarding species potential distributions across other unexplored mountains of this region. Some of the hypotheses and predictions presented in this thesis can potentially be tested in the future. Finally, this thesis adds another piece to the African jigsaw puzzle shedding light on the complex biogeographical history of amphibians.

### Historical Biogeography

Not everything is everywhere. Different species and higher taxa of animals and plants have their own characteristic patterns of distribution in space, and, if we do not restrict ourselves to the present, in time also. This is the fundamental observation of the science of biogeography, the aim of which is to understand what determines organismal distributions in general, and how the particular distributions we can observe today came to be (de Candolle, 1855; Wallace, 1876). Decades before the emergence of the theory of plate tectonics, Alfred Wegener, puzzled by the similarity between fossils of plants and animals found on opposite sides of the Atlantic, started developing the theory of continental drift (Wegener, 1966). While the distribution of organisms gives us clues about their ecological preferences (i.e. their niches) both now and in the past from the fossil record, phylogenies provide insights into intra and interspecific relationships of species. Geological and palynological studies are fundamental for the reconstruction of past climatic conditions and landscapes. Like in a jigsaw puzzle, these pieces of information put together help biogeographers to formulate and test hypotheses and theories about the history of species distribution.

Recent technological developments in Geographical Information Systems (GIS) have provided new ways to identify and examine patterns of the distribution of species – assisting in conducting biogeographical analyses. In particular, ecological niche models (ENMs) are widely used to predict current, future and past distribution of species (Elith and Leathwick, 2009). These models combine species locality records with environmental data (e.g. elevation, temperature, precipitation) potentially relevant to the organism in question to generate maps of habitat suitability. These models’ predictions of species potential distributions have assisted in formulating and testing hypotheses of relationships between populations and an overall better framework for interpreting phylogeographic hypotheses (Chan et al., 2011; Lawson, 2013; Pearson et al., 2007). For example, Lawson (2013) modelled the distribution of the East African reed frog *Hyperolius substriatus* using locality data from Tanzania and Malawi and predicted its occurrence on mountains of Northern Mozambique. The predictions were later ground-truthed by Portik et al. (2013), highlighting the usefulness of ENMs in providing insights into biogeographical patterns, notwithstanding the numerous caveats concerning the interpretation of these models (Araújo and Guisan, 2006; Yackulic et al., 2013). Furthermore, ENMs have also been used to identify cryptic species or new allopatric populations (Raxworthy et al., 2007). Overall, ENMs have provided another useful tool for analysing historical biogeographical patterns.

Species are considered the basic unit for biogeographers (Riddle and Hafner, 1999). However, the meaning of the term “species” is probably one of the most debated topics in biology since earliest times. Although taxonomists have traditionally relied mainly on morphological characters to make inferences about species, there has been increased use of genetic characters to distinguish species. These molecular data, however, often produce discordant results (Lahr et al., 2014). Evidence for multiple genetic lineages in the absence of morphological differentiation can occur in cases of convergent evolution or stasis leading to cryptic diversity, whereas multiple morphologies but genetic homogeneity can occur in cases of phenotypic plasticity (Lahr et al., 2014). As Mayr (1963, p.24) states, “Evolution is a gradual process and, in general, so is the multiplication of species... As a consequence one finds many populations in nature that have progressed only part of the way toward species status”.

Because biogeography focuses on the distribution of species in time and space the science of biogeography is intimately linked to understanding speciation processes. The main

biogeographic processes thought to promote speciation are vicariance and dispersal, and often diversification patterns are explained by a combination of both (Ronquist, 1997). Vicariance occurs when populations become separated by the emergence of a physical barrier to gene flow (e.g. forest fragmentation due to aridification). Given enough time and absence of gene flow between these disjunct populations, allopatric speciation is likely to occur. With the disappearance of the vicariant barrier, for instance during moister periods when forest fragments coalesce, previously isolated populations/lineages can disperse. Lineages dispersing back into formerly occupied areas after isolation (referred to as secondary contact zones) may result in one of the situations described in Table 1. Such scenarios are perhaps commonplace, particularly in tropical biomes where climates have fluctuated periodically and where diversity is high.

**Table 1. Possible outcomes of secondary contact after isolation according to Haffer (1969).**

Secondary contact	Speciation process	Reproductive isolation	Ecologically compatible	Prediction
Geographic overlap	Complete	Yes	Yes	Sympatric species
Geographic exclusion	Incomplete	Yes	No	Mutual exclusion
Hybridization	Incomplete	No	-	Same species

Biogeographers endeavour to untangle vicariance and dispersal processes when looking at evidence from both phylogenetic and spatial data of species. Attempts to interpret speciation processes can be problematic and often inconclusive but by using integrative approaches with different sets of data (as applied in this thesis) it can be possible to evaluate alternatives and identify most likely scenarios. Particular study areas have been important for studying speciation processes, and these include most prominently insular systems. Typically, research has been conducted on oceanic islands, with great progress made in understanding historical biogeographical processes given the relatively simple geographical situation (known geological origin, size, and isolation of each island) (Gillespie, 2004; Simberloff, 1976; Vences et al., 2003). Because of the isolation by altitude (and thus by temperature), mountains are also often considered good, island-like systems for investigating vicariance and allopatric speciation. Montane systems, sometimes referred to as “sky islands”, have recently attracted interest as important study subject for historical biogeography (Branch et al., 2014;

Conradie et al., 2016; Morrone and Crisci, 1995; Stanley et al., 2015). This thesis focuses on mountains and therefore it offers an opportunity to both identify the biogeographical patterns of a poorly known area, and elucidate the biogeographical processes operating on insular systems.

## East African biogeography

East Africa comprises a mosaic of vegetation types, including montane forest and grassland, lowland and coastal forests, woodland, *miombo* (i.e. *Brachystegia* spp.) and savannah ( Fig. 1; White, 1983). However, in the course of history the landscape of this region has undergone substantial changes. Major tectonic events in the Late Eocene (*ca.* 46 million years ago; Ma) drastically transformed the relatively flat African landscape (Axelrod and Raven, 1978). During the Miocene (23-5 Ma), volcanism, rifting and uplift of mountain blocks culminated in the formation of the Eastern Afromontane archipelago (Fig. 2), which subsequently triggered major aridification in East Africa (Sepulchre et al., 2006). The previously widespread lowland forest became highly fragmented and restricted to montane and coastal areas (Axelrod and Raven, 1978). Climatic cycles, sea level oscillations and geological events since the Miocene resulted in recurrent expansion and retraction of the forest fragments comprising the coastal forest (Burgess et al., 1998a, and references therein). Similarly, the extension of montane forest varied with climatic changes (Axelrod and Raven, 1978). Table 1 summarises some of the main tectonic and climatic events that substantially affected the diversity and distribution of the African biota since the late Cretaceous.

It seems unquestionable that climatic cycles and tectonic events are among the causes of the high diversity and endemism observed in East Africa (e.g. Burgess et al., 1998; Menegon et al., 2014; Roy, 1997; Tolley et al., 2011; Voelker et al., 2010). The main hypotheses proposed to explain diversification and distribution patterns in East Africa are based on the refuge model initially proposed by Haffer (1969) to explain diversification of birds in the Amazon during the Pleistocene. The refuge model postulates that during dryer climatic periods, previously continuous forest became fragmented and forest-dependent organisms diversified allopatrically in the forest refuges (Haffer, 1969). At the end of the dry cycle, periods of moister climatic conditions would promote expansion and reconnection of some forest fragments allowing secondary contact among previously isolated populations.

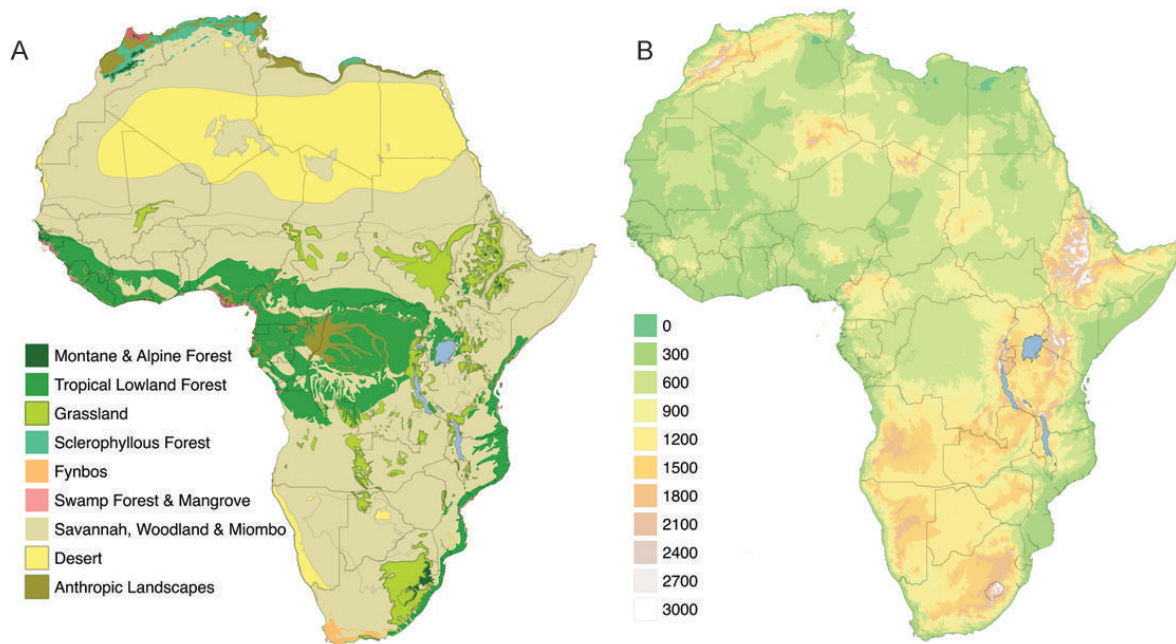

**Figure 1. (A) Vegetation map of Africa based on White (1983); (B) Elevation map.**

The Eastern Afromontane and the Coastal Forest biodiversity hotspots (Fig. 2) provided climatically stable refuges for forest-dependent taxa during repeated cycles of dryer climatic conditions in East Africa (Burgess et al., 2007, 1998; Loader et al., 2014). Throughout the Tertiary, climate-related events promoted fragmentation of forest biota culminating in long-term lineage diversification on the East Afromontane region (Bryja et al., 2014; Tolley et al., 2011; Voelker et al., 2010b). Similarly, the Coastal Forest became fragmented during cycles of drier conditions, and lineages diversified in allopatry (Burgess et al., 1998). The disparity observed between the species diversity of these biodiversity hotspots (Fig. 3) is often attributed to the ecological stability and longer-term temporal persistence of the montane forest (Burgess et al., 2007; Loader et al., 2014). In both hotspots, lineage diversification seems to have occurred throughout the Tertiary (e.g. Fjeldså and Lovett, 1997; Tolley et al., 2011), though it seems also that some groups diversified only more recently in the Pliocene and Pleistocene *ca.* 2.8 Ma (e.g. Roy, 1997). However, the general lack of biological knowledge, in particular the presence and absence of species in several parts of the Afromontane archipelago (e.g. Kenyan Highlands and Southern Islands), is hampering our understanding of the biogeographic history of this important and biologically diverse region.

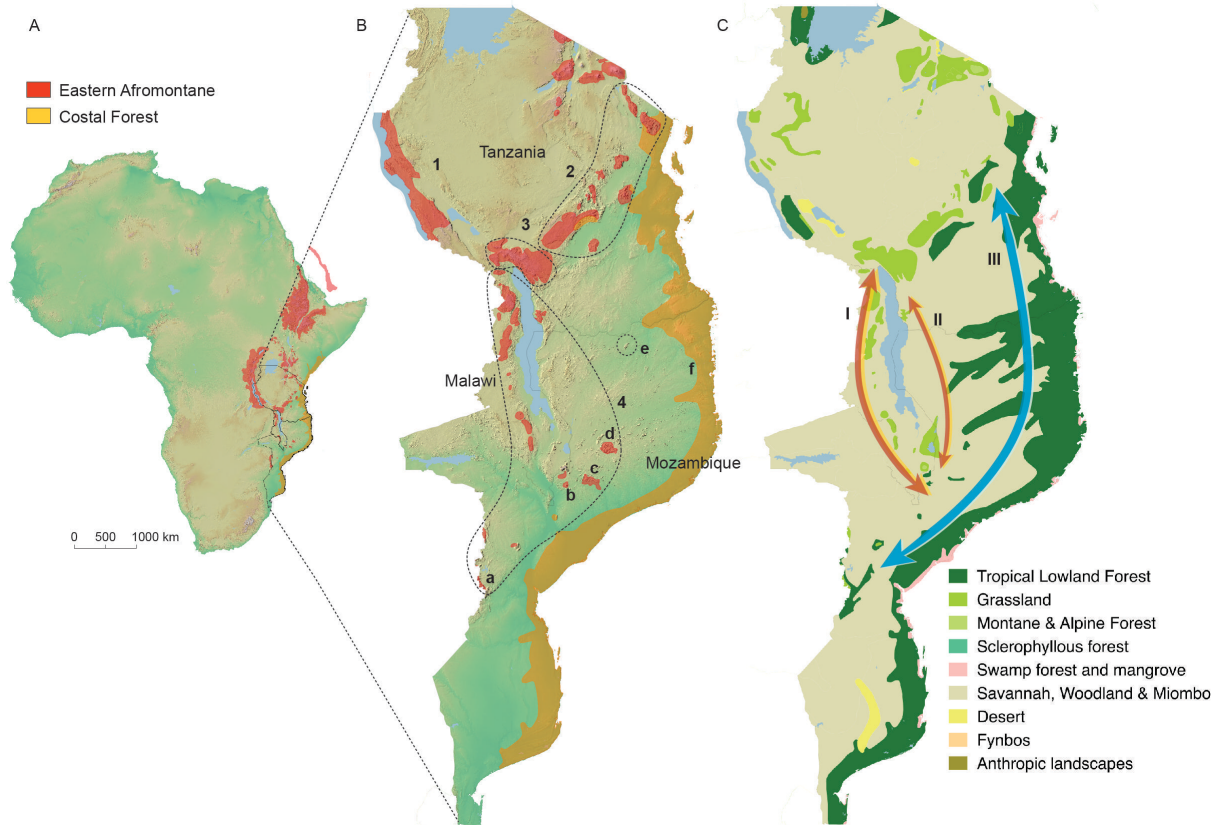
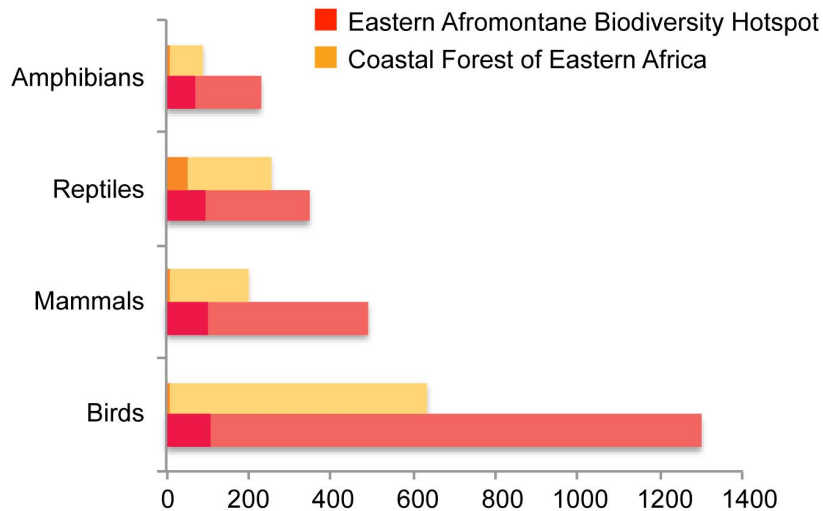

**Figure 2.** (A) East African biodiversity hotspots. (B) Part of the Eastern Afromontane archipelago including part of the Albertine Rift (1), the Eastern Arc Mountains (2), Southern Highlands of Tanzania and northern Malawian Highlands (3) and Southern Montane Islands (4). Some of the forest fragments and mountains mentioned in the text: Dombe forest (a), Mount Chipero (b), Mount Mabu (c), Mount Namuli (d) Serra Mecula (e) and Taratibu (f). (C) Blue and orange arrows indicate hypothesised dispersal routes: I. West Malawi, II. East Malawi and III. Coastal Forest.

**Table 1. Summary of the major climatic and topographic changes in Africa since the Late Cretaceous.** (Ma) Million years ago; (ka) Thousand years ago; (LGM) Last Glacial Maximum. (Axelrod and Raven, 1978; Lovett, 1993; Plana, 2004; Sepulchre et al., 2006, and references therein).

Epoch/Period	Climate	Vegetation	Topography	Effect on biota
Late Cretaceous – Early Palaeocene (77 – 55 Ma)	Stable (moister and highly equable)	Rainforest covered North of Africa extending from east to west coast	Africa was 15° South of its present latitude	Meteor impact (65 Ma) caused mass extinction worldwide
Palaeocene – Early Eocene (65 – 46 Ma)	Seasonal climate	Lowland vegetation became a mosaic of rainforest and savannah	Africa was now in its current latitude	
Late Eocene – Oligocene (46 – 25 Ma)	Sharp cooling event c. 33 Ma; Overall moister than today	Widespread forest throughout equatorial region; Contraction of subtropical forest; Montane rainforest reaching lower elevations	Rifting process starts in Southern Ethiopia and Northern Kenya	Extinction of many palms due to the cooling event; Decrease of overall species diversity
Early Miocene (23 Ma)	Warmer and more humid than Late-Eocene	Fragmentation of Pan-African forest into Guineo-Congolian and East African forests	Africa “collided” with Asia; Closure of the Tethys Sea	
Mid-Miocene (16 – 7 Ma)	Drastic cooling temperatures (c. 16 Ma) triggering an ever greater aridification process	Expansion of savannah woodland	Tanganyikan Rifting (12 Ma); Malawian Rifting (7 Ma)	Progressive loss of floristic diversity due to aridification
Late Miocene (7 Ma)	Dry climate	Forest refuges: fragmentation of lowland rainforest and retraction of montane forest to higher altitudes	Eastern Arc mountains uplifted (7 Ma)	
Early Pliocene (5 – 3.5 Ma)	Moist climate	Expansion and diversification of rainforest; Retraction of savannah	Tanzanian Rifting (5 Ma); Major uplift (5 - 2 Ma)	
Late Pliocene (3.5 – 1.5 Ma)	Marked by drier and cooling cycles (3.2 and 3.0 Ma)	Reduced expanse of grasses during arid phases	Major uplift (5 - 2 Ma)	Several regional extinctions
Quaternary (1.8 Ma – 0)	Glacial variations (9 major and 12 minor); LGM 24 – 12 ka	Expansion and retraction of forests	Maximum uplift reached	Local extinction during glacial maxima





**Figure 3.** Number of species found in the East African biodiversity hotspots. Lighter colours indicate number of endemic species. Data available at the Critical Ecosystem Partnership Fund (CEPF) webpage: <http://www.cepf.net/resources/hotspots/africa/Pages/default.aspx> (accessed on 11 March 2017).

## Mozambique

The biota of northern Mozambique is among one of the least studied in Africa. This deficiency in studies is due primarily to a long period of civil war (1977-1992) and the inaccessibility of the region. Earlier surveys in the country were limited to the southern part of the country and mainly following major transport routes (see Poynton and Boycott, 1996). Recent surveys of the northern part of Mozambique including coastal (Ohler and Frétey, 2015) and montane areas (Bayliss et al., 2014, 2010; Branch, 2004; Farooq and Conradie, 2015; Portik et al., 2013a; Timberlake et al., 2012, 2009) are beginning to reveal the diversity and biogeographical history of the Mozambican biota and its connections with adjacent areas. The landscape of northern Mozambique is characterised by sky islands covered with evergreen forest surrounded by woodland and *miombo* (Fig. 3). These Precambrian mountains (850-1100 Ma) are formed by granitic inselbergs or granitic intrusions exposed by millions of years of subsequent erosion (see Timberlake et al., 2012).

In White's (1983) classification of African vegetation, mounts Mabu, Namuli and Chipirone in Mozambique (see Fig. 2) are encompassed by enclaves of the Zanzibar-

Inhambane coastal mosaic (type 16b). However, Timberlake et al. (2007, 2009) disregard White's classification and depict the vegetation of these mountains as montane forest, following Wild and Barbosa (1968). The presence of coastal forest species of birds and molluscs on these mountains (Timberlake et al., 2012, 2009) suggests a connection between them and the Coastal Forest. The forest-dependent frog *Mertensophryne anotis* was thought to be restricted to forest patches in the Chirinda forest in eastern Zimbabwe and the adjacent Dombe forest in Mozambique, though the discovery of a disjunct population in Taratibu, northeastern coast of Mozambique (Farooq et al., 2015), supports the hypothesis of a dispersal route between the coastal forest and some of the Southern Montane Islands (see Fig. 2). However, Afromontane species, such as the mountain rodent *Praomys delectorum* and the reed frog *Hyperolius substriatus*, are also found in the mountains of northern Mozambique (Portik et al., 2013a; Timberlake et al., 2007, 2012, 2009), and recent phylogeographical studies show that these forest-dependent species have different dispersal routes between mountains of northern Mozambique and the East African biodiversity hotspots (see Fig. 1C; Bryja et al., 2014; Lawson, 2013).

Poynton and Boycott (1996) demonstrated in a study of amphibian distribution that there is a north-south species turnover in southeastern Africa where northern species become progressively excluded from highland areas southwards, while southern species become limited to highlands as they extend northwards. They attributed this change in fauna to latitudinal changes, mainly explained by temperature but also due to precipitation. Furthermore, they suggest a separation of the Afromontane faunal group into Afrotropical and Afrotropical, where the fauna of the latter group can be biogeographically related to a tropical East African lowland fauna. Despite being relatively species-poor when compared to the Eastern Afromontane and Coastal Forest biodiversity hotspots, these Mozambican mountains hold numerous endemic species of plants, vertebrates and invertebrates (Bayliss et al., 2014; Portik et al., 2013b; Timberlake et al., 2007, 2012, 2009). Considering that this region is inserted in between two main faunal groups (Afrotropical and Afrotropical) forming a complex mosaic, and large areas in northern Mozambique remain unexplored, the number of endemic species can potentially increase with intensification of surveys in the region.

## Objectives

It is widely recognised that although biodiversity is maximal in the tropics, tropical biodiversity has been subject to much less intensive study than has temperate biodiversity (Janzen, 1986). And yet, by virtue of the scale of diversity, tropical systems provide the opportunity for the most powerful, cross-taxonomic studies. With the notable exception of the cichlid fishes of the Great Lakes that have become textbook examples of adaptive radiations (Seehausen, 2006), African tropical biodiversity patterns are poorly studied compared to other tropical regions (e.g. Neotropics), and within tropical Africa, Mozambique stands out as particularly neglected, at least partly as result of a long period of civil war. This lack of research is particularly worrying given the fact that two global biodiversity hotspots overlap in northern Mozambique (Fig. 2), the Eastern Afromontane and the Coastal Forests of Eastern Africa (Mittermeier et al., 2004). Mozambican biodiversity might thus be expected to be especially high, but we have little detailed knowledge of what is present in Mozambique and how it is related to the other better known faunas and floras occurring in neighbouring regions. Without such information, Mozambique will remain a global biodiversity knowledge *coldspot* and our understanding of adjacent regions will remain incomplete.

Their age, varied dispersal capabilities and reproductive modes make amphibians a suitable taxonomic focus for this thesis (Bocxlaer et al., 2006; Haddad and Prado, 2005). Available background knowledge from adjacent regions, i.e. the highlands of southern Malawi, Eastern Arc Mountains and the Coastal Forest of Tanzania and Kenya, provides insights into the biogeographical history of the amphibian biota of East Africa (e.g. Burgess et al., 2007, 1998; Daniels and Bayliss, 2012; Dowsett-Lemaire, 1989; Poynton and Broadley, 1991). This study contributes to filling a fundamental knowledge gap in African biogeographic research.

This thesis is focused on the virtually unexplored mountains of northern Mozambique (Fig. 2). These mountains are predicted to harbour a diverse amphibian fauna including both endemics and more widespread species. Although, as mentioned above, an impoverishment of diversity in relation to other mountains further north of the Afromontane archipelago is expected (Poynton and Boycott, 1996). In this thesis I study intra- and interspecific relationships within the anuran (frog and toad) fauna of the northern Mozambican mountains. This includes looking at connections with other biogeographical regions and relationships within Mozambican and Malawian montane regions. The main questions addressed here are:

(1) What is the diversity of amphibians in the mountains of northern Mozambique? (2) Do they show patterns of isolation on each of these mountains? (3) What are the connections between the anuran species from these mountains and the Eastern Afromontane archipelago and Coastal Forest of East Africa? Dispersal among the northern Mozambique mountains is expected, though predicted to vary according to each species. Frogs with different ecological requirements (e.g. terrestrial breeders vs. aquatic breeders) consequently have distinct levels of vagility and this provides opportunities to test dispersal hypotheses and the strengths of putative vicariant barriers. To investigate these relationships I used integrative approaches combining phylogenetic analyses of molecular markers and ecological niche models to search for cross taxonomic temporal congruence in patterns of diversification, such as would be expected from substantial abiotic, extrinsic factors.

## Chapters Overview

**CHAPTER I:** The phylogenetic position and diversity of the enigmatic mongrel frog *Nothophryne* Poynton, 1963 (Amphibia, Anura)

**Authors:** Gabriela B. Bittencourt-Silva, Werner Conradie, Karen Siu-Ting, Krystal A. Tolley, Alan Channing, Michael Cunningham, Harith M. Farooq, Michele Menegon, Simon P. Loader

**Status:** Published (Molecular Phylogenetics and Evolution)

The mongrel frog *Nothophryne* Poynton, 1963 is found on Mount Mulanje in Malawi and on isolated mountains of Northern Mozambique. The taxonomic position of this frog has been a mystery since its description, hence the name (Gr. *nothus* = mongrel). Here we use a two-tiered phylogenetic approach to address issues related to the phylogenetic position of this genus. This is the first time genetic data (mitochondrial and nuclear) from *Nothophryne* was included in a phylogeny. Ecological niche models were used to identify potential areas where *Nothophryne* may occur.

**CHAPTER II:** Impact of species delimitation and sampling on niche models and phylogeographical inference: a case study of the East African reed frog *Hyperolius substriatus* Ahl, 1931

**Authors:** Gabriela B. Bittencourt-Silva, Lucinda P. Lawson, Krystal A. Tolley, Daniel M. Portik, Christopher D. Barratt, Peter Nagel, Simon P. Loader

**Status:** Manuscript under review (Molecular Phylogenetics and Evolution)

This study examines the sensitivity of ENMs to the addition of new geographically isolated populations, and the impact of applying different taxonomic delimitations. Main clades were identified on a phylogenetic tree inferred from mitochondrial and nuclear genes, and ENMs were generated for each of clade separately, as well as for all clades together. These models were used to infer the phylogeographical history of the East African reed frog *Hyperolius substriatus* Ahl, 1931.

**CHAPTER III:** Phylogeny and historical biogeography of the shovel-footed squeaker *Arthroleptis stenodactylus* Pfeffer, 1893

**Authors:** Gabriela B. Bittencourt-Silva, David C. Blackburn and Simon P. Loader

**Status:** Drafted manuscript

This chapter uses an integrative approach to investigate the relationships within the widespread African shovel-footed squeaker *Arthroleptis stenodactylus* Pfeffer, 1893. First, a phylogeny was produced using mitochondrial and nuclear markers using two approaches: maximum likelihood and Bayesian inference. Subsequently, the main clades were identified on the consensus tree and ecological niche models were generated for each of them. Morphological data of two ecologically distinct clades (forest vs. woodland) identified in the previous analyses was then compared using linear discriminant analysis.

**ADDITIONAL PUBLICATIONS RELATED TO THIS THESIS:**

Exploration into the hidden world of Mozambique's sky island forests: new discoveries of reptiles and amphibians

**Authors:** Werner Conradie, Gabriela B. Bittencourt-Silva, Hanlie M. Engelbrecht, Simon P. Loader, Michele Menegon, Cristóvão Nanvonamuquitxo, Michael Scott, Krystal A. Tolley

**Status:** Published (Zoosystematics and Evolution)

The distribution of *Mertensophryne anotis* with a new record in Northern Mozambique

**Authors:** Harith Farooq, H. Christoph Liedtke, Gabriela Bittencourt-Silva, Werner Conradie and Simon P. Loader

**Status:** Published (Herpetology Notes)

New species of Mongrel Frogs (Pyxicephalidae: *Nothophryne*) for northern Mozambique inselbergs

**Authors:** Werner Conradie, Gabriela B. Bittencourt-Silva, Harith M. Farooq, Simon P. Loader and Krystal A. Tolley

**Status:** Manuscript under review (African Journal of Herpetology)

## References

- Araújo, M.B., Guisan, A., 2006. Five (or so) challenges for species distribution modelling. *J. Biogeogr.* 33, 1677–1688. doi:10.1111/j.1365-2699.2006.01584.x
- Axelrod, D.I., Raven, P.H., 1978. Late Cretaceous and Tertiary vegetation history of Africa, in: *Biogeography and Ecology of Southern Africa*. Springer, pp. 77–130.
- Bayliss, J., Monteiro, J., Fishpool, L., Congdon, C., Bampton, I., Bruessow, C., Matimele, H., Banze, A., Timberlake, J.R., 2010. Biodiversity and Conservation of Mount Inago, Mozambique. *Rep. Prod. under Darwin Initiat. Award* 15, 36.
- Bayliss, J., Timberlake, J., Branch, W., Bruessow, C., Collins, S., Congdon, C., Curran, M., de Sousa, C., Dowsett, R., Dowsett-Lemaire, F., Fishpool, L., Harris, T., Herrmann, E., Georgiadis, S., Kopp, M., Liggitt, B., Monadjem, A., Patel, H., Ribeiro, D., Spottiswoode, C., Taylor, P., Willcock, S., Smith, P., 2014. The discovery, biodiversity and conservation of Mabu forest—the largest medium-altitude rainforest in southern Africa. *Oryx* 48, 177–185. doi:10.1017/S0030605313000720
- Bocxlaer, I. Van, Roelants, K., Biju, S.D., Nagaraju, J., Bossuyt, F., Dodson, P., Ravoavy, F., 2006. Late Cretaceous Vicariance in Gondwanan Amphibians. *PLoS One* 1, e74. doi:10.1371/journal.pone.0000074
- Branch, W.R., 2004. *Herpetological Survey of the Niassa Game Reserve, Northern Mozambique*, Sociedade para a Gestão e Desenvolvimento da Reserva do Niassa.
- Branch, W.R., Bayliss, J., Tolley, K.A., 2014. Pygmy chameleons of the *Rhampholeon*

- platyceps* complex (Squamata: Chamaeleonidae): Description of four new species from isolated “sky islands” of northern Mozambique. *Zootaxa* 3814, 1–36.
- Bryja, J., Mikula, O., Patzenhauerová, H., Oguge, N.O., Šumbera, R., Verheyen, E., 2014. The role of dispersal and vicariance in the Pleistocene history of an East African mountain rodent, *Praomys delectorum*. *J. Biogeogr.* 41, 196–208. doi:10.1111/jbi.12195
- Burgess, N.D., Butynski, T.M., Cordeiro, N.J., Doggart, N.H., Fjeldså, J., Howell, K.M., Kilahama, F.B., Loader, S.P., Lovett, J.C., Mbilinyi, B., Menegon, M., Moyer, D.C., Nashanda, E., Perkin, A., Rovero, F., Stanley, W.T., Stuart, S.N., 2007. The biological importance of the Eastern Arc Mountains of Tanzania and Kenya. *Biol. Conserv.* 134, 209–231. doi:10.1016/j.biocon.2006.08.015
- Burgess, N.D., Clarke, G.P., Rodgers, W.A., 1998. Coastal forests of eastern Africa: status, endemism patterns and their potential causes. *Biol. J. Linn. Soc.* 64, 337–367. doi:10.1111/j.1095-8312.1998.tb00337.x
- Chan, L.M., Brown, J.L., Yoder, A.D., 2011. Integrating statistical genetic and geospatial methods brings new power to phylogeography. *Mol. Phylogenet. Evol.* 59, 523–537. doi:10.1016/j.ympev.2011.01.020
- Conradie, W., Bittencourt-Silva, G., Engelbrecht, H.M., Loader, S.P., Menegon, M., Nanvonamuquitxo, C., Scott, M., Tolley, K.A., 2016. Exploration into the hidden world of Mozambique’s sky island forests: new discoveries of reptiles and amphibians. *Zoosystematics Evol.* 92, 163–180.
- Daniels, S.R., Bayliss, J., 2012. Neglected refugia of biodiversity: mountainous regions in Mozambique and Malawi yield two novel freshwater crab species (Potamonautidae: *Potamonautes*). *Zool. J. Linn. Soc.* 164, 498–509. doi:10.1111/j.1096-3642.2011.00773.x
- de Candolle, A., 1855. *Géographie botanique raisonnée; ou, Exposition des faits principaux et des lois concernant la distribution géographique des plantes de l’époque actuelle*; Paris, V. Masson; [etc., etc.].
- Dowsett-Lemaire, F., 1989. Ecological and biogeographical aspects of forest bird communities in Malawi. Ornithological Sub-Committee of the East Africa Natural History Society.
- Elith, J., Leathwick, J.R., 2009. Species distribution models: ecological explanation and prediction across space and time. *Annu. Rev. Ecol. Evol. Syst.* 40, 677–697.

- Farooq, H., Liedtke, H.C., Bittencourt-Silva, G., Conradie, W., Loader, S.P., 2015. The distribution of *Mertensophryne anotis* with a new record in Northern Mozambique. *Herpetol. Notes* 8, 305–307.
- Farooq, H.O.M., Conradie, W., 2015. Second record of a *Scolecophorus kirkii* Boulenger, 1883 (Gymnophiona: Scolecophoridae) for Mozambique. *Herpetol. Notes*.
- Fjeldså, J., Lovett, J.C., 1997. Geographical patterns of old and young species in African forest biota: the significance of specific montane areas as evolutionary centres. *Biodivers. {&} Conserv.* 6, 325–346. doi:10.1023/A:1018356506390
- Gillespie, R., 2004. Community Assembly Through Adaptive Radiation in Hawaiian Spiders. *Science* (80-. ). 303, 356–359. doi:10.1126/science.1091875
- Haddad, C.F.B., Prado, C.P.A., 2005. Reproductive Modes in Frogs and Their Unexpected Diversity in the Atlantic Forest of Brazil. *Bioscience* 55, 207. doi:10.1641/0006-3568(2005)055[0207:RMIFAT]2.0.CO;2
- Haffer, J., 1969. Speciation in Amazonian Forest Birds. *Science* (80-. ). 165, 131–137.
- Janzen, D.H., 1986. The Future of Tropical Ecology. *Annu. Rev. Ecol. Syst.* 17, 305–324. doi:10.1146/annurev.es.17.110186.001513
- Lahr, D.J.G., Laughinghouse, H.D., Oliverio, A.M., Gao, F., Katz, L.A., 2014. How discordant morphological and molecular evolution among microorganisms can revise our notions of biodiversity on Earth. *BioEssays* 36, 950–959. doi:10.1002/bies.201400056
- Lawson, L.P., 2013. Diversification in a biodiversity hot spot: landscape correlates of phylogeographic patterns in the African spotted reed frog. *Mol. Ecol.* 22, 1947–1960. doi:10.1111/mec.12229
- Loader, S.P., Ceccarelli, S.F., Menegon, M., Howell, K.M., Kassahun, R., Mengistu, A.A., Saber, S.A., Gebresenbet, F., de Sá, R., Davenport, T.R.B., Larson, J.G., Müller, H., Wilkinson, M., Gower, D.J., 2014. Persistence and stability of Eastern Afromontane forests: evidence from brevicipitid frogs. *J. Biogeogr.* 41, 1781–1792. doi:10.1111/jbi.12331
- Lovett, J.C., 1993. Climatic history and forest distribution in eastern Africa. *Eastern Arc moist flora. Biogeogr. Ecol. Rain For. East. Africa*, Cambridge Univ. Press. Cambridge 23–29.
- Mayr, E., 1963. *Animal species and evolution*. Harvard University Press; London: Oxford University Press.



- 
- Menegon, M., Loader, S.P., Marsden, S.J., Branch, W.R., Davenport, T.R.B., Ursenbacher, S., 2014. The genus *Atheris* (Serpentes: Viperidae) in East Africa: Phylogeny and the role of rifting and climate in shaping the current pattern of species diversity. *Mol. Phylogenet. Evol.* 79, 12–22. doi:10.1016/j.ympev.2014.06.007
- Mittermeier, R.A., Mittermeier, R.A., Cemex, S.A. de C.V., 2004. Hotspots revisited. *Cemex*.
- Morrone, J.J., Crisci, J. V., 1995. Historical biogeography: introduction to methods. *Annu. Rev. Ecol. Syst.* 26, 373–401.
- Ohler, A., Frétey, T., 2015. Going Back to Rovuma: The Frog Fauna of a Coastal Dry Forest, and a Checklist of the Amphibians of Mozambique. *J. East African Nat. Hist.* 103, 73–124. doi:10.2982/028.103.0203
- Pearson, R.G., Raxworthy, C.J., Nakamura, M., Townsend Peterson, A., 2007. Predicting species distributions from small numbers of occurrence records: a test case using cryptic geckos in Madagascar. *J. Biogeogr.* 34, 102–117. doi:10.1111/j.1365-2699.2006.01594.x
- Plana, V., 2004. Mechanisms and tempo of evolution in the African Guineo–Congolian rainforest. *Philos. Trans. R. Soc. London B Biol. Sci.* 359.
- Portik, D.M., Mulungu, E., Sequeira, D., McEntee, J.P., 2013a. Herpetological surveys of the Serra Jeci and Namuli massifs, Mozambique, and an annotated checklist of the southern Afromontane archipelago. *Herpetol. Rev.* 44, 394–406.
- Portik, D.M., Travers, S.L., Bauer, A.M., Branch, W.R., 2013b. A new species of *Lygodactylus* (Squamata: Gekkonidae) endemic to Mount Namuli, an isolated “sky island” of northern Mozambique. *Zootaxa* 3710, 415–435.
- Poynton, J.C., Boycott, R.C., 1996. Species turnover between Afromontane and eastern African lowland faunas: patterns shown by amphibians. *J. Biogeogr.* 23, 669–680. doi:10.1111/j.1365-2699.1996.tb00027.x
- Poynton, J.C., Broadley, D.G., 1991. Amphibia Zambesiaca 5. Zoogeography. *Ann. Natal Museum* 39, 221–277.
- Raxworthy, C.J., Ingram, C.M., Rabibisoa, N., Pearson, R.G., 2007. Applications of ecological niche modeling for species delimitation: a review and empirical evaluation using day geckos (*Phelsuma*) from Madagascar. *Syst. Biol.* 56, 907–23. doi:10.1080/10635150701775111
- Riddle, B.R., Hafner, D.J., 1999. Species as Units of Analysis in Ecology and Biogeography: Time to Take the Blinders Off. *Glob. Ecol. Biogeogr.* 8, 433–441.

- Ronquist, F., 1997. Dispersal-Vicariance Analysis: A New Approach to the Quantification of Historical Biogeography. *Syst. Biol.* 46, 195–203. doi:10.1093/sysbio/46.1.195
- Roy, M.S., 1997. Recent diversification in African greenbuls (Pycnonotidae: *Andropadus*) supports a montane speciation model. *Proc. R. Soc. London B Biol. Sci.* 264, 1337–1344.
- Seehausen, O., 2006. African cichlid fish: a model system in adaptive radiation research. *Proc. R. Soc. B Biol. Sci.* 273, 1987 LP-1998.
- Sepulchre, P., Ramstein, G., Fluteau, F., Schuster, M., Tiercelin, J.-J., Brunet, M., 2006. Tectonic Uplift and Eastern Africa Aridification. *Science* (80- ). 313, 1419–1423.
- Simberloff, D., 1976. Species Turnover and Equilibrium Island Biogeography. *Science* (80- ). 194, 572–578. doi:10.1126/science.194.4265.572
- Stanley, W.T., Hutterer, R., Giarla, T.C., Esselstyn, J.A., 2015. Phylogeny, phylogeography and geographical variation in the *Crocidura monax* (Soricidae) species complex from the montane islands of Tanzania, with descriptions of three new species. *Zool. J. Linn. Soc.* 174, 185–215. doi:10.1111/zoj.12230
- Timberlake, J., Bayliss, J., Alves, T., Baena, S., Francisco, J., Harris, T., da Sousa, C., 2007. The biodiversity and conservation of Mount Chipirone, Mozambique. *Rep. Prod. under Darwin Initiat. Award 15*, 33.
- Timberlake, J.R., Bayliss, J., Dowsett-Lemaire, F., Conghan, C., Branch, W.R., Collins, S., Curran, M., Dowsett, R.J., Fishpool, L., Francisco, J., others, 2012. Mt. Mabu, Mozambique: Biodiversity and Conservation. Report produced under the Darwin Initiative Award 15/036. Royal Botanic Gardens, Kew, London.
- Timberlake, J.R., Dowsett-Lemaire, F., Bayliss, J., Alves, T., Baena, S., Bento, C., Cook, K., Francisco, J., Harris, T., Smith, P., others, 2009. Mt Namuli, Mozambique: biodiversity and conservation. *Rep. Darwin Initiat. Award 15*, 36.
- Tolley, K.A., Tilbury, C.R., Measey, G.J., Menegon, M., Branch, W.R., Matthee, C.A., 2011. Ancient forest fragmentation or recent radiation? Testing refugial speciation models in chameleons within an African biodiversity hotspot. *J. Biogeogr.* 38, 1748–1760. doi:10.1111/j.1365-2699.2011.02529.x
- Vences, M., Vieites, D.R., Glaw, F., Brinkmann, H., Kosuch, J., Veith, M., Meyer, A., 2003. Multiple overseas dispersal in amphibians. *Proc. R. Soc. B Biol. Sci.* 270, 2435–2442. doi:10.1098/rspb.2003.2516

- Voelker, G., Outlaw, R.K., Bowie, R.C.K., 2010a. Pliocene forest dynamics as a primary driver of African bird speciation. *Glob. Ecol. Biogeogr.* 19, 111–121. doi:10.1111/j.1466-8238.2009.00500.x
- Voelker, G., Outlaw, R.K., Bowie, R.C.K., 2010b. Pliocene forest dynamics as a primary driver of African bird speciation. *Glob. Ecol. Biogeogr.* 19, 111–121. doi:10.1111/j.1466-8238.2009.00500.x
- Wallace, A.R., 1876. *The geographical distribution of animals, with a study of the relations of living and extinct faunas as elucidating the past changes of the earth's surface.* London, Macmillan and Co.,.
- Wegener, A., 1966. *Die Entstehung der Kontinente und Ozean.* Vieweg.
- White, F., 1983. *The vegetation of Africa.* Paris:Unesco.
- Wild, H., Barbosa, L.A.G., 1968. *Vegetation Map of the Flora Zambesiaca Area, with Descriptive Memoir*, in: *Supplement to Flora Zambesiaca.* Collins, Salisbury, p. 71.
- Yackulic, C.B., Chandler, R., Zipkin, E.F., Royle, J.A., Nichols, J.D., Campbell Grant, E.H., Veran, S., 2013. Presence-only modelling using MAXENT: When can we trust the inferences? *Methods Ecol. Evol.* 4, 236–243. doi:10.1111/2041-210x.12004

# CHAPTER I

The phylogenetic position and diversity of the enigmatic mongrel frog  
*Nothophryne* Poynton, 1963 (Amphibia, Anura)

Gabriela B. Bittencourt-Silva, Werner Conradie, Karen Siu-Ting, Krystal A. Tolley,  
Alan Channing, Michael Cunningham, Harith M. Farooq, Michele Menegon, Simon  
P. Loader

**Statuts:** Published (Molecular Phylogenetics and Evolution)



Contents lists available at ScienceDirect

## Molecular Phylogenetics and Evolution

journal homepage: [www.elsevier.com/locate/ympev](http://www.elsevier.com/locate/ympev)

## The phylogenetic position and diversity of the enigmatic mongrel frog *Nothophryne* Poynton, 1963 (Amphibia, Anura)



Gabriela B. Bittencourt-Silva<sup>a,\*</sup>, Werner Conradie<sup>b,c</sup>, Karen Siu-Ting<sup>d,e,f</sup>, Krystal A. Tolley<sup>g</sup>, Alan Channing<sup>h</sup>, Michael Cunningham<sup>c,i</sup>, Harith M. Farooq<sup>j</sup>, Michele Menegon<sup>k</sup>, Simon P. Loader<sup>a,l</sup>

<sup>a</sup> Department of Environmental Sciences, University of Basel, Basel 4056, Switzerland

<sup>b</sup> Port Elizabeth Museum (Bayworld), Humewood 6013, South Africa

<sup>c</sup> South African Institute for Aquatic Biodiversity, Grahamstown 6140, South Africa

<sup>d</sup> Ecological and Evolutionary Genomics Lab, IBERS, Aberystwyth University, Aberystwyth SY23 3FG, United Kingdom

<sup>e</sup> School of Biotechnology, Dublin City University, Glasnevin, Dublin 9, Ireland

<sup>f</sup> Departamento de Herpetología, Museo de Historia Natural UNMSM, Av. Arenales 1256, Jesus María, Lima, Peru

<sup>g</sup> South African National Biodiversity Institute, Rhodes Drive, Private Bag X7, Newlands, Claremont 7735, Cape Town, South Africa

<sup>h</sup> Biodiversity and Conservation Biology Department, University of the Western Cape, Bellville 7525, South Africa

<sup>i</sup> Department of Genetics, University of Pretoria, Private Bag X20, Hatfield 0028, South Africa

<sup>j</sup> Faculty of Natural Sciences, Lírio University, Pemba 958, Mozambique

<sup>k</sup> Tropical Biodiversity Section, Museo delle Scienze, Viale del Lavoro e della Scienza, 3, 38122 Trento, Italy

<sup>l</sup> University of Roehampton, London SW15 4JD, United Kingdom

## ARTICLE INFO

## Article history:

Received 25 December 2015

Revised 14 March 2016

Accepted 16 March 2016

Available online 18 March 2016

## Keywords:

Biogeography

Pyxicephalidae

Taxonomy

Ancestral reconstruction

Cryptic diversity

Mozambique

## ABSTRACT

The phylogenetic relationships of the African mongrel frog genus *Nothophryne* are poorly understood. We provide the first molecular assessment of the phylogenetic position of, and diversity within, this monotypic genus from across its range—the Afromontane regions of Malawi and Mozambique. Our analysis using a two-tiered phylogenetic approach allowed us to place the genus in Pyxicephalidae. Within the family, *Nothophryne* grouped with *Tomopterna*, a hypothesis judged significantly better than alternative hypotheses proposed based on morphology. Our analyses of populations across the range of *Nothophryne* suggest the presence of several cryptic species, at least one species per mountain. Formal recognition of these species is pending but there is a major conservation concern for these narrowly distributed populations in an area impacted by major habitat change. The phylogenetic tree of pyxicephalids is used to examine evolution of life history, ancestral habitat, and biogeography of this group.

© 2016 Elsevier Inc. All rights reserved.

## 1. Introduction

Knowledge of the African amphibian fauna is incomplete (e.g., Blackburn, 2008; Poynton, 1999), particularly in terms of taxonomic placement and delimitation across all taxonomic levels. Recent progress based on molecular data has revealed a wide-range of cryptic diversity of species (e.g., Blackburn, 2008; Channing et al., 2013; Loader et al., 2014; Tolley et al., 2010) and clarified phylogenetic relationships of many taxonomically uncertain groups (Barej et al., 2014; Frost et al., 2006; Pyron and Wiens, 2011; Scott, 2005; Siu-Ting et al., 2014; van der Meijden et al., 2011). Even though these studies have provided steps forward in our understanding of African amphibian diversity, many groups still require substantial investigation.

The mongrel frog *Nothophryne broadleyi* Poynton, 1963 is the only currently recognised member of its genus, and due to substantial threats within its restricted distribution (Mount Mulanje, Malawi and Mount Ribàué, Mozambique) is considered Endangered by the IUCN. *Nothophryne* is isolated on these inselbergs (isolated mountains), hiding under moss or other moist vegetation during the day. Eggs are laid in wet moss, and tadpoles develop in water seepages over exposed granitic outcrops. In the original diagnosis of the genus, Poynton (1963 p. 325) described the type series as presenting “a rather unexpected conglomeration of characters shown in a number of closely related genera, notably the external appearance of *Cacosternum capense*, a skeleton recalling *Anhydrophryne*, and a lingual papilla like that found in *Phrynobatrachus*. It is therefore placed in a new genus, and the odd assortment of characters gives the genus its name (Gk. *nothus* = mongrel)”. Poynton (1963) considered the phylogenetic position of his new

\* Corresponding author.

E-mail address: [gabriela.bittencourt@unibas.ch](mailto:gabriela.bittencourt@unibas.ch) (G.B. Bittencourt-Silva).

genus not altogether clear but evidently within the ranid subfamily Cacosterninae *sensu* Laurent (1961).

Scott (2005) made the first cladistic analysis of African ranids, including *Nothophryne*. In her thorough study, that combined morphological and molecular data, Scott inferred *Nothophryne* to be the sister group of *Cacosternum* Boulenger, 1887 and *Microbatrachella* Hewitt, 1926 (Cacosterninae, Ranidae). However, only morphological data were available for *Nothophryne* as well as some other taxa (i.e. *Ericabatrachus* Largen, 1991 and *Poyntonia* Channing and Boycott, 1989), and this produced some controversial relationships among groups. Since then, our understanding of the phylogenetic placement of *Nothophryne* has become further confused by the unstable phylogenetic relationships of higher taxa within ranids (e.g., Frost et al., 2006; Pyron and Wiens, 2011; van der Meijden et al., 2005). An example of this is its inclusion in Phrynobatrachidae *sensu* Dubois (1992), based exclusively on phenetic comparisons. In summary, the taxonomic placement of this enigmatic frog still remains unknown, due to the shifting taxonomy of ranids and lack of genetic data for *Nothophryne*. Hence, we expect that molecular data for *Nothophryne* will shed light on its phylogenetic placement, as has been the case with other recent examples of previously unsampled African ranids (e.g., Barej et al., 2014; Siu-Ting et al., 2014).

We obtained novel molecular data for *Nothophryne broadleyi* from recent fieldwork in the highlands of Mozambique and Malawi, including populations from several inselbergs where it had not been previously recorded. This allowed us to examine the phylogenetic placement of the genus, as well as the distribution and diversity of the populations on isolated inselbergs. We test whether these newly discovered populations represent the currently described species (i.e. *N. broadleyi*) or undescribed species, and make predictions regarding potential additional populations/species using ecological niche models. Using both the predictive modelling data and phylogenetic trees, we examine biogeographic hypotheses regarding ancient connections between the montane isolates. Lastly, our sampling of *Nothophryne* has implications for life-history evolution in pyxicephalids, and we examine this by reconstructing ancestral life history traits with respect to habitat and breeding-mode shifts over time. We tentatively suggest that pyxicephalids originated in moist forest in Central or East Africa and had a semi-terrestrial breeding mode (i.e. eggs deposited out of water and aquatic larvae).

## 2. Material and methods

### 2.1. Samples and sequencing

Samples of *Nothophryne broadleyi* were collected from northern Mozambique and Malawi (Fig. 1) between 2009 and 2014 from the following field expeditions: Mount Namuli and Mount Inago (Bayliss et al., 2010; Timberlake et al., 2009), Mount Namuli (Farooq and Conradie, 2015), Mount Namuli and Mount Ribáuê (SANBI 2014 expedition) and Taratibu (H. Farooq 2014), with topotypic material collected from Mount Mulanje (M. Cunningham 2010). Individuals were found atop rock outcrops near water seepages and patches of moss. Tissue samples from thigh muscle and liver were obtained for eight specimens. Voucher specimens are deposited in the scientific collections of South African Institute for Aquatic Biodiversity (SAIAB), Port Elisabeth Museum (PEM) and Universidade Lúrio (UniLurio; Table S1 – Appendix A).

Total genomic DNA was extracted using Qiagen DNeasy kit following the protocol for purification of total DNA from animal tissues. In order to make comparisons with other African ranid frogs (van der Meijden et al., 2011, 2005), we amplified and sequenced four widely used markers in amphibian phylogenetics,

comprising segments of two partial mitochondrial genes 12SrRNA (12S) and 16SrRNA (16S) and two nuclear genes, rhodopsin exon 1 (RHOD), and recombination activating gene 1 (RAG1). PCR was performed using Illustra PuReTaq Ready-To-Go PCR Beads (Tables S2 and S3 – Appendix A), respectively. DNA sequences of both strands were sequenced by Microsynth AG (Balgrist, Switzerland).

### 2.2. Data matrix and alignment

Despite historical uncertainty in the taxonomic position of *Nothophryne*, there is little doubt that this taxon is a member of Ranoidea. Therefore we used a two-tiered approach similar to Siu-Ting et al. (2014) in order to determine its placement within the group. We first conducted a broad phylogenetic analysis using a large-scale published alignment, followed by a second targeted analysis with a subset of the taxa for a more precise and well-supported placement. Thus, for our large-scale analysis, we used part of the Siu-Ting et al. (2014) large-scale alignment, i.e. only including the four markers that we sequenced for our *Nothophryne* samples: 12S, 16S, RHOD and RAG1 in order to minimise the amount of missing data. The alignment extracted from Siu-Ting et al. (2014) constitutes our “start alignment” containing 860 taxa, which we updated for recent taxonomic revisions (see Appendix B). For instance *Rana megalotympanum* was removed because it is a synonym of *Odorrana tiannanensis* (Yang and Li, 1980), and according to Channing et al. (2013) the sequences related to *Cacosternum platys* Rose, 1950 actually are of *Microbatrachella capensis* (Boulenger, 1910). *Rana pretiosa* Baird and Girard, 1853 was excluded because there was no sequence available for the selected markers (see below). We updated the matrix with 306 novel sequences available on GenBank (until 01 August 2015, see Appendix B). In addition to *Nothophryne*, two other taxa were added to the alignment: *Odontobatrachus natator* (Boulenger, 1905), a member of the newly described family Odontobatrachidae, and *Tomopterna cf. tandyi*. The latter was included despite its unconfirmed specific identity because it is the only member of this genus with the complete selected set of genes sequenced and available on GenBank. Finally, we included our newly sequenced sample of *Nothophryne broadleyi* collected near the type locality on Mount Mulanje, Malawi.

All new sequences were added to our start alignment using the profile alignment method in Muscle v.3.8 (Edgar, 2004) and the resulting alignments were then inspected and adjusted manually using Geneious v.7.1 (Kearse et al., 2012). TranslatorX (Abascal et al., 2010) was also used to improve and maintain the correct reading frames for the alignments of protein-encoding nuclear genes (RAG1 and RHOD). The total number of species included per marker was 786 (12S), 840 (16S), 366 (RAG1) and 419 (RHOD), with the most of our species overlap being in our 12S and 16S markers. Our final large-scale concatenated alignment included a total of 858 taxa and was 4157 bp long.

### 2.3. Phylogenetic analyses

For our large-scale phylogenetic analysis, we performed a maximum likelihood (ML) analysis with non-parametric bootstrapping in RAxML v.8.2 (Stamatakis, 2014). Phylogenetic trees were rooted at Hemisotidae + Brevicipitidae, because this node is considered basal within Ranoidea (following Frost et al., 2006; Pyron and Wiens, 2011; Siu-Ting et al., 2014; Zhang et al., 2013). PartitionFinder (Lanfear et al., 2012) was used to select the best partition scheme (according to BIC) based on predefined partitions (codon-position or gene for protein-coding and non-coding markers respectively) which was then analysed using the unlinked GTR + GAMMA (GTR + G) model implemented in RAxML. For this

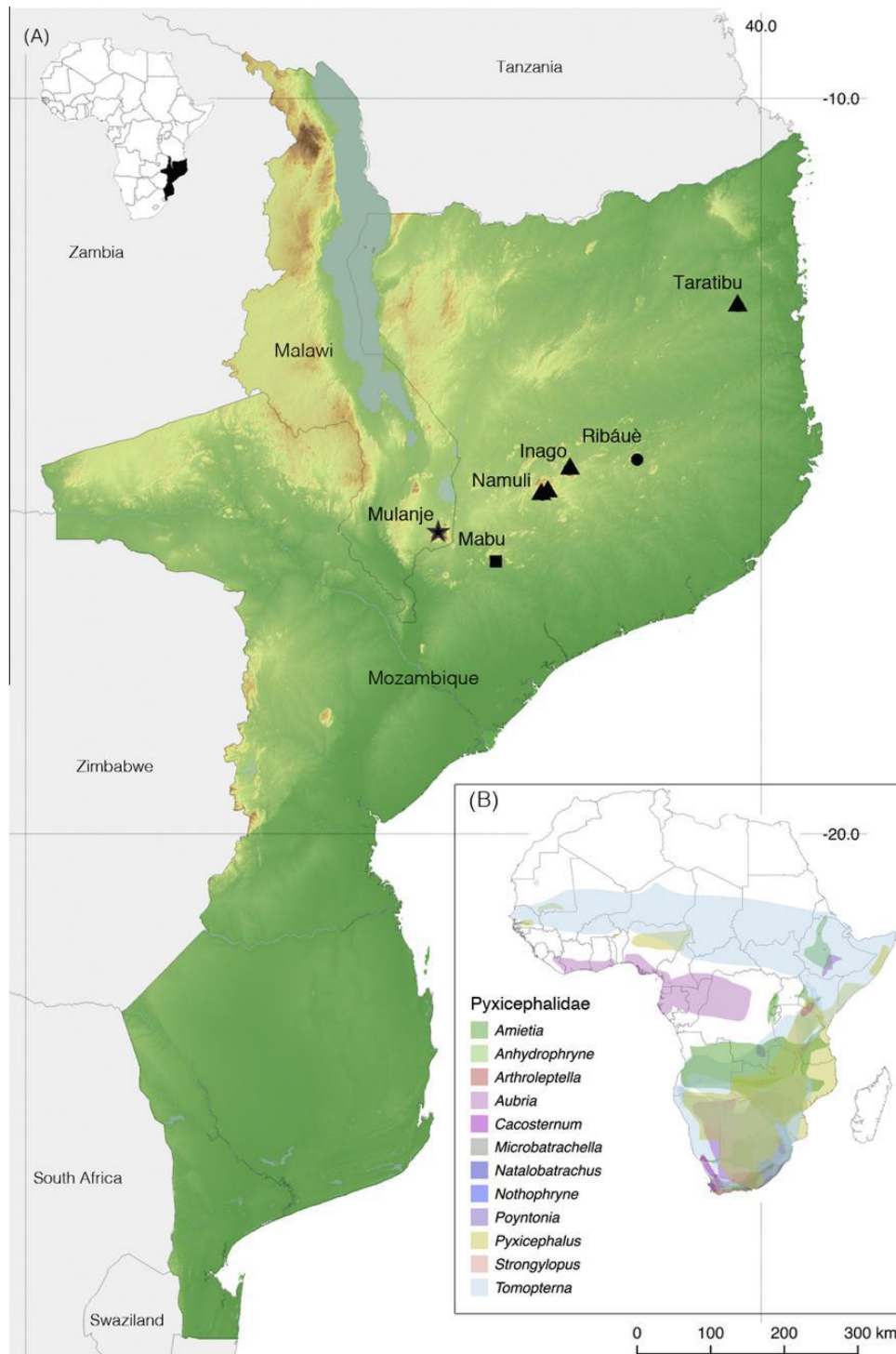

**Fig. 1.** Distribution of *Nothophryne* and *Pyxicephalidae*. (A) Star indicates the type locality (Mount Mulanje). The other previously known locality (Mount Ribáuè) is marked with a black circle and new localities are shown as black triangles. Black square represents Mount Mabu (where *Nothophryne* has been heard but not collected). (B) Distribution of pyxicephalids (downloaded from <http://www.iucnredlist.org/> in November 2015).



analysis we included *Nothophryne* sequences only from the type locality (Mount Mulanje, Malawi).

Small-scale analyses were performed using a subset of taxa chosen based on the large-scale ML analysis and their relative completeness and stability. The small-scale dataset (42 taxa and 3984 bp) included representatives of *Nothophryne* from near the type locality of *N. broadleyi* and five additional localities (in total eight samples), and all species of Pyxicephalidae from our large-scale alignment, with the exception of *Tomopterna natalensis* (Smith, 1849), which was found from the large-scale analysis to be an unstable taxon (see results). Three representatives from Petropedetidae (chosen to minimise missing data) were included as outgroup taxa. Analysing the small-scale dataset allowed us to investigate the relationships among different populations of *Nothophryne broadleyi* and to test monophyly of this taxon. A *de novo* alignment was performed for each gene using MAFFT v.7.0 (Katoh and Standley, 2013) applying the algorithm E-INS-i (recommended for less than 200 sequences with multiple conserved domains and long gaps), and nucleotide substitution models were selected using PartitionFinder. The following models were applied to each partition in the concatenated data: GTR + I + G (12S + 16S, RAG1\_p1), GTR + I (RAG1\_p2), SYM + G (RAG1\_p3), GTR + G (RHOD\_p1 + RHOD\_p2) and HKY + G (RHOD\_p3). MrBayes v.3.2 (Ronquist and Huelsenbeck, 2003) was used for the Bayesian inference (BI). Two runs were executed using four chains, and 20 million generations were sampled every 1000 generations with the initial 10% discarded as burn-in, and examination of the effective sample sizes (ESS) for convergence of parameters was done using Tracer (Rambaut et al., 2014). For comparison, a ML analysis was performed in RAxML using the GTR + G model, and support values were estimated using non-parametric bootstrap (100 replicates). Phylogenetic trees were visualised in iTOL v.2.1 (Letunic and Bork, 2011).

Approximately Unbiased (AU) tests (Shimodaira, 2002) were used to evaluate the fit of our new and Scott's (2005) previously proposed hypothesis of the relationships of *Nothophryne* to the small-scale dataset. The tree with the best overall fit was our ML GTR + G tree. This tree was then used as a backbone to generate (by manually editing the position of *Nothophryne* and other taxa) trees representing Scott's (2005) hypothesis. As explained in Siu-Ting et al. (2014), by using the tree that provided the best fit to the data, we avoided a potential bias against the contrasting hypotheses. Four trees were tested in total: our Bayesian and ML (GTR + G) trees, a tree representing Scott's (2005) proposed relationships, and a tree where we only moved *Nothophryne* to portray Scott's (2005) placement of this taxon (i.e. as sister taxon of the *Microbatrachella* + *Cacosternum* clade); see summary of tested topologies in Fig. 2. Additionally, in order to facilitate comparison, we pruned out the taxa that were not included in Scott's work, namely *Strongylopus fasciatus* (Smith, 1849), *S. bonaespei* (Dubois, 1981), *Arthroleptella villiersi* Hewitt, 1935, *A. lightfooti* (Boulenger, 1910), *A. drewesii* Channing, Hendricks, and Dawood, 1994, *A. subvoce* Turner, de Villiers, Dawood, and Channing, 2004, and *A. bicolor* Hewitt, 1926. Per-site log-likelihoods were calculated for each of the tested topologies under GTR + G model in RAxML; then, these likelihood values were used to estimate statistical significance in CONSEL v.0.2 (Shimodaira and Hasegawa, 2001).

#### 2.4. Divergence-time estimation

In order to estimate the approximate times of divergences within Pyxicephalidae, we generated an ultra-metric tree using BEAST v.2.1.3 (Bouckaert et al., 2014) with the Yule tree prior (as recommended for species-level analyses) and a lognormal relaxed molecular clock. As secondary calibration points we used two splits estimated by van der Meijden et al. (2005): the “African endemic

clade”, which was estimated to be ca. 69.9 mya (million years ago); and the “African endemic clade excluding *Pyxicephalus*” (and *Aubria*) estimated to be ca. 61.7 mya. We performed two runs of 100 million generations, sampling every 1000 generations, and ESS was examined using Tracer. The resulting trees were combined with the first 10% discarded as burn-in using LogCombiner v1.7.5, and the maximum clade credibility tree using the posterior mean node heights for the clades was obtained using TreeAnnotator v1.7.5 (both programs are part of the BEAST package). As a check on our estimates of divergence-times we used those less than 15 mya (to reduce the effects of saturation) and uncorrected p-distances between 16S sequences to compute an average rate of sequence evolution for this marker.

#### 2.5. Ancestral-state reconstruction

Pyxicephalids may have originated in Southern Africa in either savannah or forest (van der Meijden et al., 2011), but an analysis of ancestral habitat states has not been previously conducted. In addition, the ancestral breeding mode has not been previously investigated for this family. We therefore selected two ecological traits, habitat and breeding mode, and mapped them onto our Pyxicephalidae phylogeny. Because many species inhabit other biomes (e.g., fynbos, lowland and montane grasslands) that are possibly more recent than the ancestor of pyxicephalids, we assigned taxa from these biomes to one of the two habitat states: (i) moist forest (coastal forest, lowland rainforest and montane forest) and (ii) open vegetation (dry forest, grasslands, savannah and fynbos). Our coding system for habitat was based on the IUCN (IUCN, 2014) habitat description. Breeding mode, coded according to place of egg deposition and larval habitat, comprises three states: (i) fully aquatic; (ii) semi-terrestrial; and (iii) and direct development. The state fully aquatic refers to eggs deposited in water and larvae developing in aquatic environment, whereas semi-terrestrial includes species that lay eggs out of water (e.g., wet moss, nest hanging on branches) but the larvae develop in water. Pereira et al. (2015) demonstrated that multiple reversals occur between habitat states (e.g., open area versus forest formations) in leptodactylids. Similarly, there is evidence that evolution of anuran breeding modes is not an ordered and gradual process towards terrestrial reproduction (Gomez-Mestre et al., 2012), including observation of reversals from terrestrial to aquatic larval development (Pereira et al., 2015). Hence, we considered transitions between states independent for both habitat and breeding mode.

Traits were mapped onto the ultrametric tree resulting from our BEAST analysis. The tree was pruned leaving only one representative of each genus, given that traits do not vary within genera. We applied two methods, parsimony and maximum likelihood (ML), using Mesquite v. 3.03 (Maddison and Maddison, 2015). ML reconstructions were performed using the Markov k-state 1-parameter model (Mk1; Lewis, 2001), which gives equal probability for changes between any two character states. Similarly, parsimony analysis used Fitch (unordered or non-additive) optimisation, which gives equal cost to all character-state changes.

#### 2.6. Species delimitation

We explored putative species boundaries within our samples of *Nothophryne* using a Bayesian implementation of the General Mixed Yule-Coalescent (bGMYC; Reid and Carstens, 2012) model implemented in R v. 2.13.0 (R Core Team, 2014) using 100 trees randomly selected from a BEAST analysis (same settings as before but without the divergence-time constraints). We set the bGMYC simulations to 50,000 generations, discarding the first 10% as burn-in and sampling every 100th generation. The upper threshold was set to 42 (number of tips on the tree), and a cut-off value was



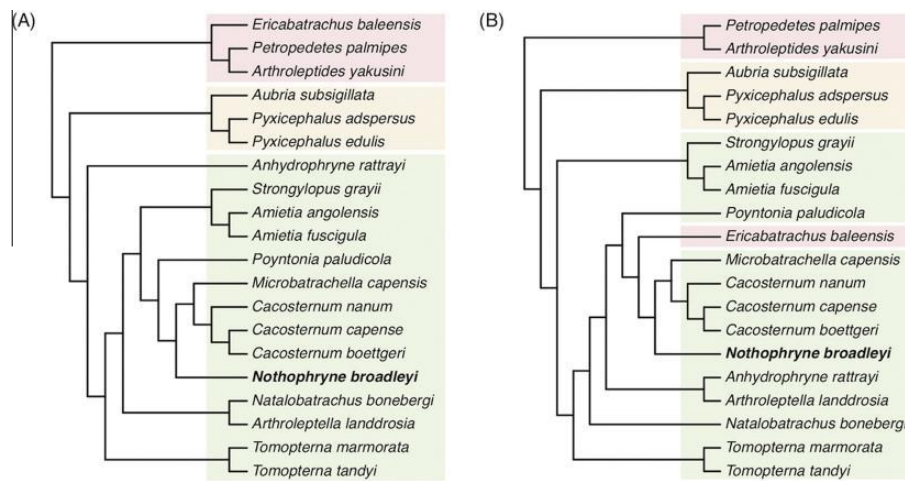

**Fig. 2.** Alternative hypothesis of the relationship of *Nothophryne* and its putative sister groups. (A) Scott (2005) hypothesis, which represents the full set of relationships for that area of the tree; (B) Scott (2005) *Nothophryne* hypothesis represents only the phylogenetic relationship for *Nothophryne* in Scott's work. For more details about how this test was performed, refer to Section 2.

set as 0.8 in order to determine the lineages. Additionally, we calculated the pairwise distance between 16S sequences for 41 species included in the small-scale analysis using MEGA6 (Tamura et al., 2013). *Tomopterna* cf. *tandyi* was excluded because it overlapped only with five other sequences. A final dataset of 508 bp was produced after eliminating all positions with less than 5% site coverage.

### 2.7. Ecological niche model (ENM)

Historically, *Nothophryne* has been reported only from two localities: Mount Mulanje, Malawi (type locality) and Mount Ribáuè in Mozambique (Blake, 1965; Poynton, 1963), both higher than 1200 m above sea level (asl). Our recent fieldwork expeditions revealed the occurrence of members of this taxon in three new sites (Fig. 1), including one that is 500 km away from the type locality and at considerably lower elevation (Taratibu, Mozambique, 450 m asl). In order to identify regions with similar environmental conditions to where *Nothophryne* has been found, we developed an ENM using MaxEnt version 3.3.3k (Phillips et al., 2006). Given the small sample size ( $n = 8$ ), we set the replication mode to cross-validation, which uses all the samples leaving one out in each run. All parameters were set as default.

Environmental variables were selected based on the authors understanding about the species habitat requirements. We assembled a total of seven environmental variables related to temperature (mean diurnal range, temperature seasonality and mean temperature of coldest quarter), precipitation (precipitation of driest quarter and precipitation of warmest quarter) and topography (digital elevation model and slope) on a 30 s grid (ca. 1 km<sup>2</sup> resolution). Climatic data were obtained from the WorldClim database (Hijmans et al., 2005) and the digital elevation model from HydroSHEDS (Lehner et al., 2006). Slope was calculated using the digital elevation model. All variables were treated using R packages “raster” (Hijmans, 2015) and “rgdal” (Bivand et al., 2015). In order to produce a binary map (presence-absence) of habitat suitability, we applied the minimum training presence (MTP) threshold, which uses the lowest predicted value associated with any of the observed presence records.

## 3. Results

### 3.1. Phylogenetic analyses

The large-scale ML analysis (Fig. 3) supported monophyly of Pyxicephalidae and of the two sub-families of this group (Cacosterninae and Pyxicephalinae) with high bootstrap values (99%, 96% and 100%, respectively), corroborating previous studies (e.g., Scott, 2005; van der Meijden et al., 2011). A clade comprising *Nothophryne broadleyi* and all *Tomopterna* Duméril and Bibron, 1841 was recovered with bootstrap support of 94%. Additionally, we found that *Tomopterna natalensis* was unstable, and that pruning this taxon from the bootstrap trees increased the support of the association of *Nothophryne* and the remaining *Tomopterna* to 100%.

The focused small-scale analysis with ML and BI also recovered *Nothophryne* as the sister taxon of *Tomopterna* with maximum support values for both non-parametric bootstrap and posterior probability (Fig. 4). AU tests do not distinguish between the ML and Bayesian trees, whereas both trees displaying Scott's (2005) placement of *Nothophryne* were rejected as having a significantly worse fit to the data ( $p$ -values < 0.005, see Table 1). This further supports our phylogenetic placement of *Nothophryne* obtained in both our Bayesian and ML analyses.

### 3.2. Divergence-time estimation

Based on secondary calibration points and the assumption that Pyxicephalidae originated around 70 mya, we inferred that the split between *Nothophryne* and *Tomopterna* occurred approximately 36 mya (Fig. 5). Within *Nothophryne* there are substantial divergences between the lineage from Taratibu and the rest (estimated ca. 22 mya, Fig. 5). Using uncorrected  $p$ -distances (Table S1 – Appendix C) and estimated divergence-times (Table S2 – Appendix C) we computed an average rate of sequence evolution for 16S of approximately 0.16% per million years (see Table S3 – Appendix C3), which is comparable with the rate reported in Guo et al. (2011) for lacertid lizards.

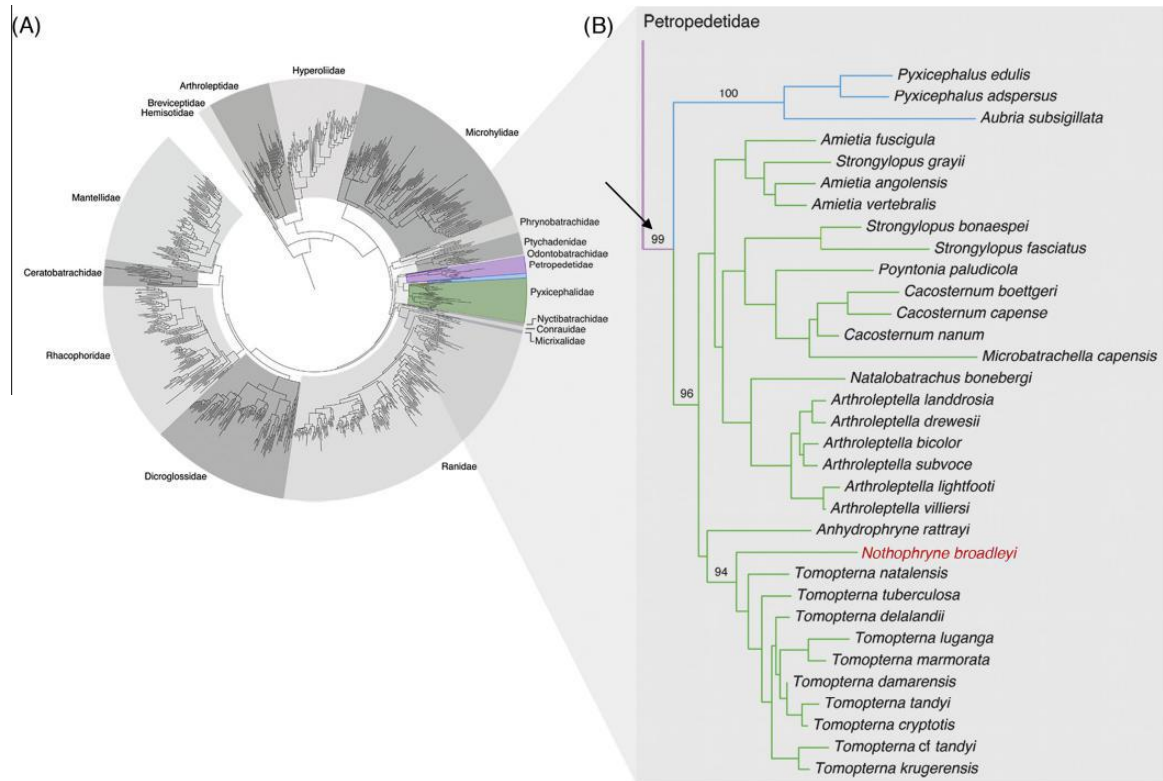

**Fig. 3.** Phylogenetic relationships of *Nothophryne broadleyi*. (A) ML tree from the large-scale phylogeny of Ranoidea. (B) Close up view of the clade Pyxicephalidae and the position of *Nothophryne broadleyi*. Arrow indicates the high bootstrap support for Pyxicephalidae.

### 3.3. Ancestral-state reconstruction

The result for the ancestral habitat reconstruction using parsimony reveals a forest ancestor for pyxicephalids (Fig. 6). However, the ML method shows equivocal results regarding the ancestral habitat of Pyxicephalidae. Multiple transitions between habitat types occurred in the evolution of the family. Reconstructions of ancestral breeding mode using both methods show equivocal results. The parsimony method suggests either a fully or semi-aquatic ancestor of pyxicephalids.

### 3.4. Species delimitation

The bGMYC analysis recovered six putative species of *Nothophryne*, one from Malawi (*N. broadleyi*) and five from Mozambique (Fig. 7). Two separate putative species of *Nothophryne* were identified from Mount Namuli (one from Namuli dome and another from Pese dome). However, these findings should be interpreted with caution given that bGMYC is prone to over-splitting lineages (Carstens et al., 2013). Hence, addition of morphological and acoustic data would be crucial to confirm the hypothesis of multiple species on the Namuli massif. The pairwise distance matrix shows that the differences within our *Nothophryne* samples (excepting the samples from the Namuli massif) are equivalent to the differences observed within species from other pyxicephalid genera (Table S1 – Appendix C).

### 3.5. Ecological niche models

The ecological niche model shows a number of areas outside the known distribution that might be suitable for *Nothophryne* (Fig. 8).

Of note is that slope (46.2%) and elevation (34.9%) contributed highly to the total variation in the model, with temperature seasonality (13%) and precipitation of the driest quarter (5.8%) also important. Because *Nothophryne* is typically found in moss and shrub on high granite domes on inselbergs, slope and elevation might be expected to have a strong contribution.

Regardless, some areas identified as suitable by the model are actually sloped areas (e.g., edges of plateaus and densely forested mountains), which when overlapped with satellite images do not appear to be suitable *Nothophryne* habitat, suggesting that the model over-predicts based on this suite of environmental variables. It is important to note that our aim with this model is merely to identify areas with habitats similar to that where *Nothophryne* has been found in order to propose biogeographical scenarios, and to guide future surveys for this group. For example, Mount Mabu is one of the areas predicted as suitable for *Nothophryne*, and in November 2014 several individuals of *Nothophryne* were heard calling on the granite dome summit but were not captured (Bittencourt-Silva, Conradie, Loader, Pers. Obs.).

## 4. Discussion

### 4.1. Phylogeny

Our results corroborate Scott's (2005) hypothesis that *Nothophryne* is a member of the subfamily Cacosteninae of the African family Pyxicephalidae. Differently we recover *Nothophryne* as the sister taxon to the genus *Tomopterna*, a finding not previously suggested. This conclusion contrasts with the previous hypothesis that

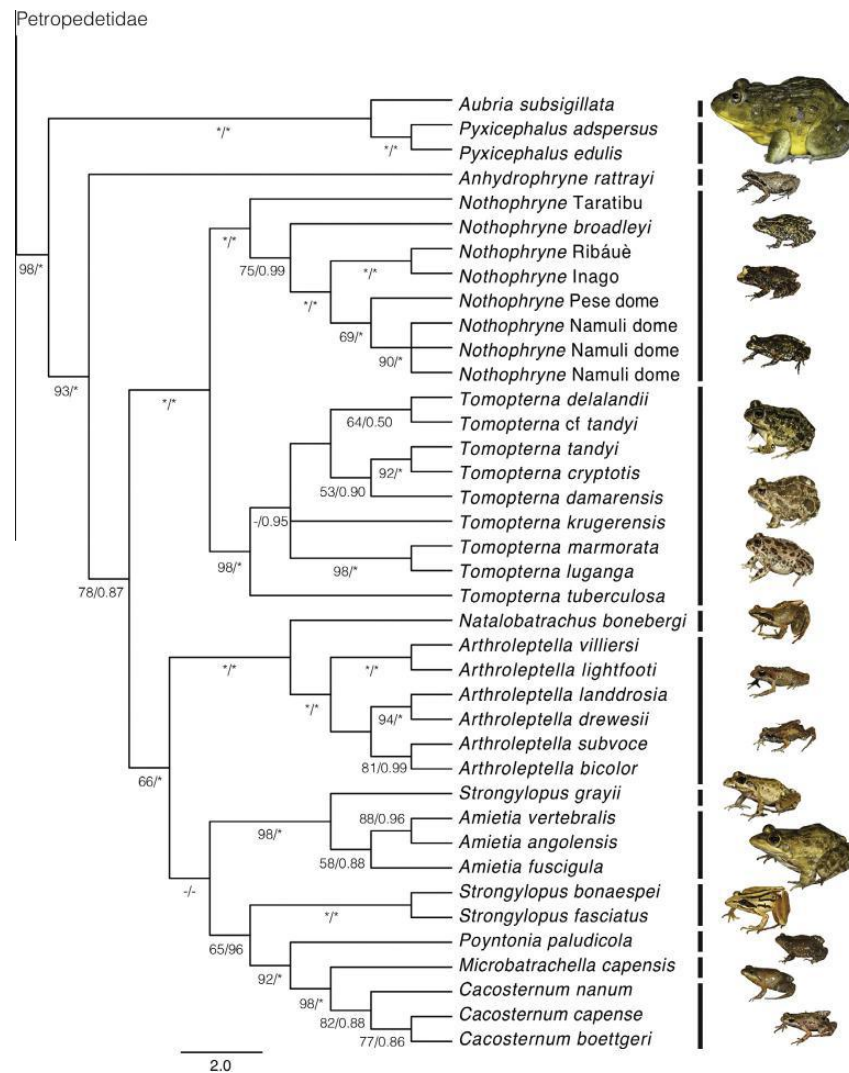

**Fig. 4.** Phylogenetic relationships of Pyxicephalidae. Consensus tree (ML and BI) with branch support values corresponding to non-parametric bootstraps (left) and posterior probabilities (right). Maximum support values are represented by "\*" and values equal or below 50/0.50 are denoted by "-".

**Table 1**

Hypothesis-testing results. Values shown refer to the Approximately Unbiased test (AU test) from CONSEL. Scott (2005) hypothesis represents the full set of relationships for that area of the tree proposed in Scott's work. Scott (2005) Nothophryne hypothesis represents only the phylogenetic relationship for Nothophryne in Scott's work.

Rank	Item	AU test
1	Present work, Bayesian tree	0.507
2	Present work, small-scale ML tree	0.500
3	Scott (2005) hypothesis	9e-05
4	Scott (2005) Nothophryne hypothesis	6e-05

*Nothophryne* is the sister group to *Cacosternum* and *Microbatrachella* (Scott, 2005). Presently, there are no known unique morphological synapomorphies (though many non-unique ones) that unite *Nothophryne* and *Tomopterna* (Scott, 2005), but constrained trees including the grouping of *Nothophryne*, *Cacosternum* and

*Microbatrachella* have significantly worse fits to the molecular data. Thus we agree with Scott (2005) that the placement of *Nothophryne* in her study might be an artefact caused by the lack of molecular data.

With the molecular sampling of *Nothophryne*, our study is the first to include representatives of all pyxicephalid genera. The addition of genetic data from *Nothophryne* is effective not only in the placement of this taxon but also provides an alternative phylogenetic hypothesis amongst other pyxicephalids. In previous studies (Bossuyt et al., 2006; Frost et al., 2006; van der Meijden et al., 2011, 2005) *Tomopterna* is the sister taxon to all other members of Cacosterninae, whereas in the present study and in Pyron and Wiens' (2011) phylogeny, *Anhydrophryne* Hewitt, 1919 is placed in this position. However, this part of the pyxicephalid tree is relatively poorly supported and will require further sampling of genes and species to resolve the precise positions of genera within Cacosterninae with confidence. We caution that the grouping of

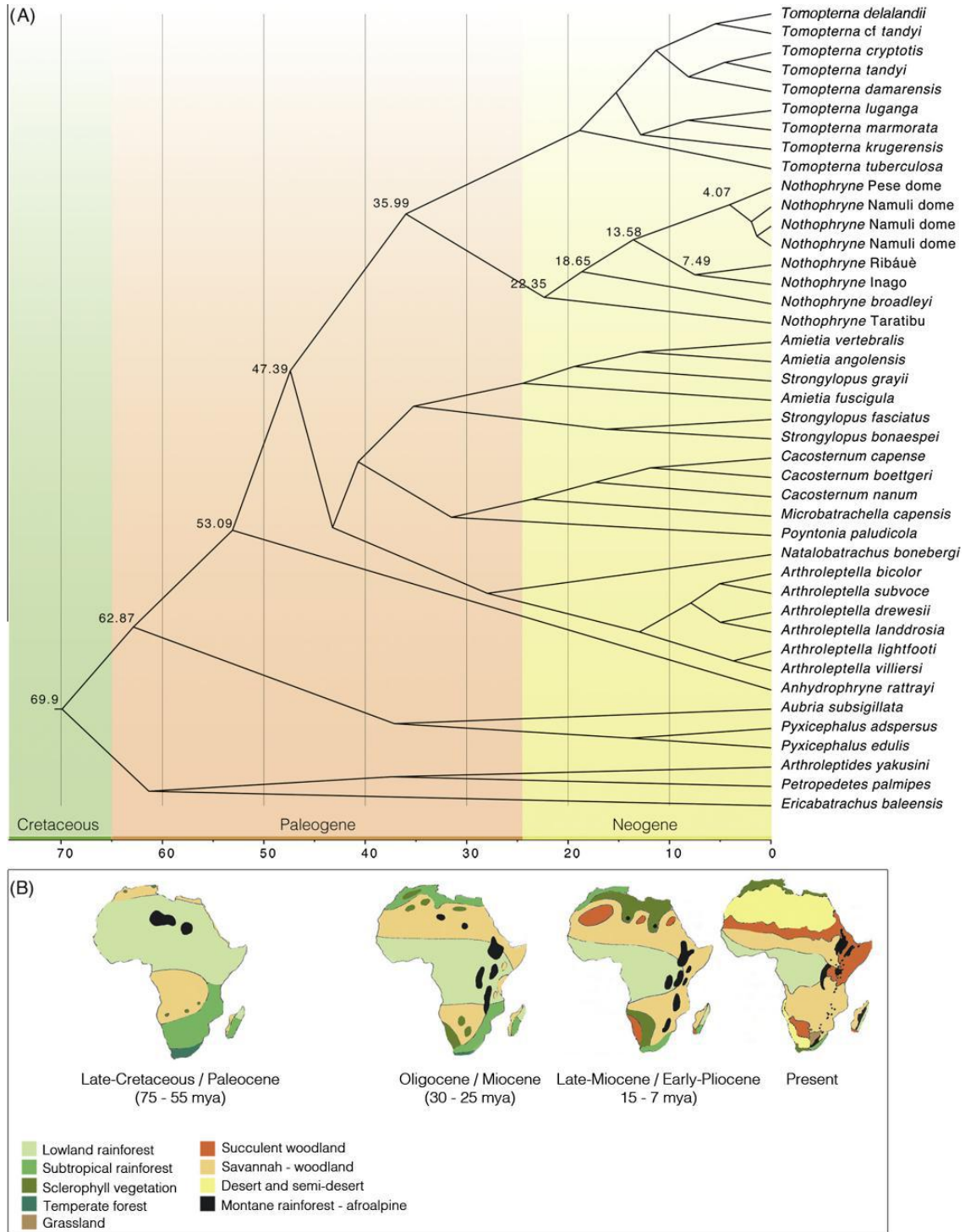

Fig. 5. Divergence-time estimation for pyxicephalids and vegetation map for Africa. (A) Calibrated tree based on secondary-calibration derived from van der Meijden et al. (2011) estimations. (B) Schematic vegetation map of Africa adapted from Axelrod and Raven (1978).



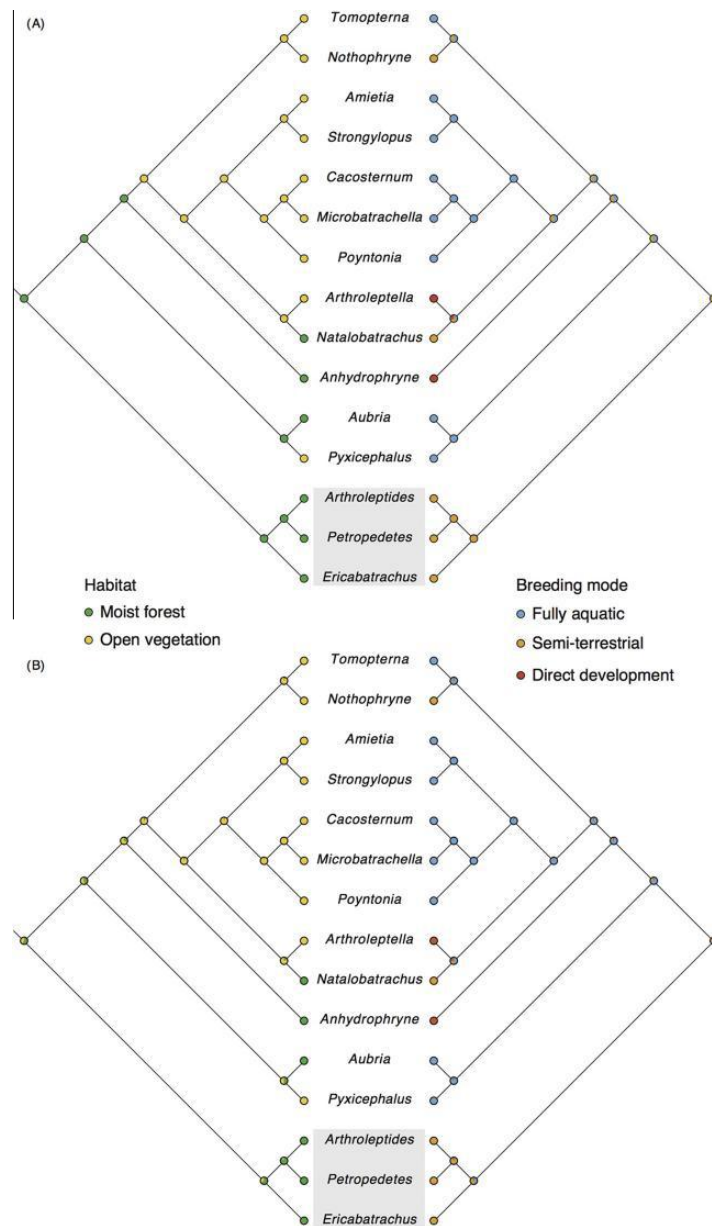

Fig. 6. Reconstructed ancestral habitat and breeding mode of pyxicephalids. (A) Parsimony method and (B) Maximum likelihood method. Grey box indicates outgroup.

*Strongylopus grayii* with *Amietia*, which implies non-monophyly of *Strongylopus*, should not be accepted uncritically (see comments in Frost, 2015).

The previously unsuspected grouping of *Nothophryne* with *Tomopterna* has interesting implications in terms of shifts in niches, evolution of breeding strategies, morphological parallelism, and biogeography of Pyxicephalidae. The genus *Tomopterna* comprises 15 species of medium-sized frogs, and is widespread throughout sub-Saharan Africa. *Tomopterna* lives in both moist and arid savannah, whereas *Nothophryne* is a relatively small frog that occurs in isolated patches of Afromontane environments,

more precisely in areas with exposed granitic rocks. It has been hypothesised that pyxicephalids originated in Southern Africa where medium to large sized ancestors resembling some extant genera (i.e. *Pyxicephalus* and *Tomopterna*) occupied savannah and lowland forests (van der Meijden et al., 2011, 2005). Our habitat-reconstruction analyses (Fig. 6) suggest that the ancestor of pyxicephalids may have inhabited moist forested habitats similar to those currently restricted to montane environments. This conclusion remains speculative, however, because there are theoretical and practical shortcomings when reconstructing ancestral habitats for species (Hardy, 2006). One caveat is that our findings are based

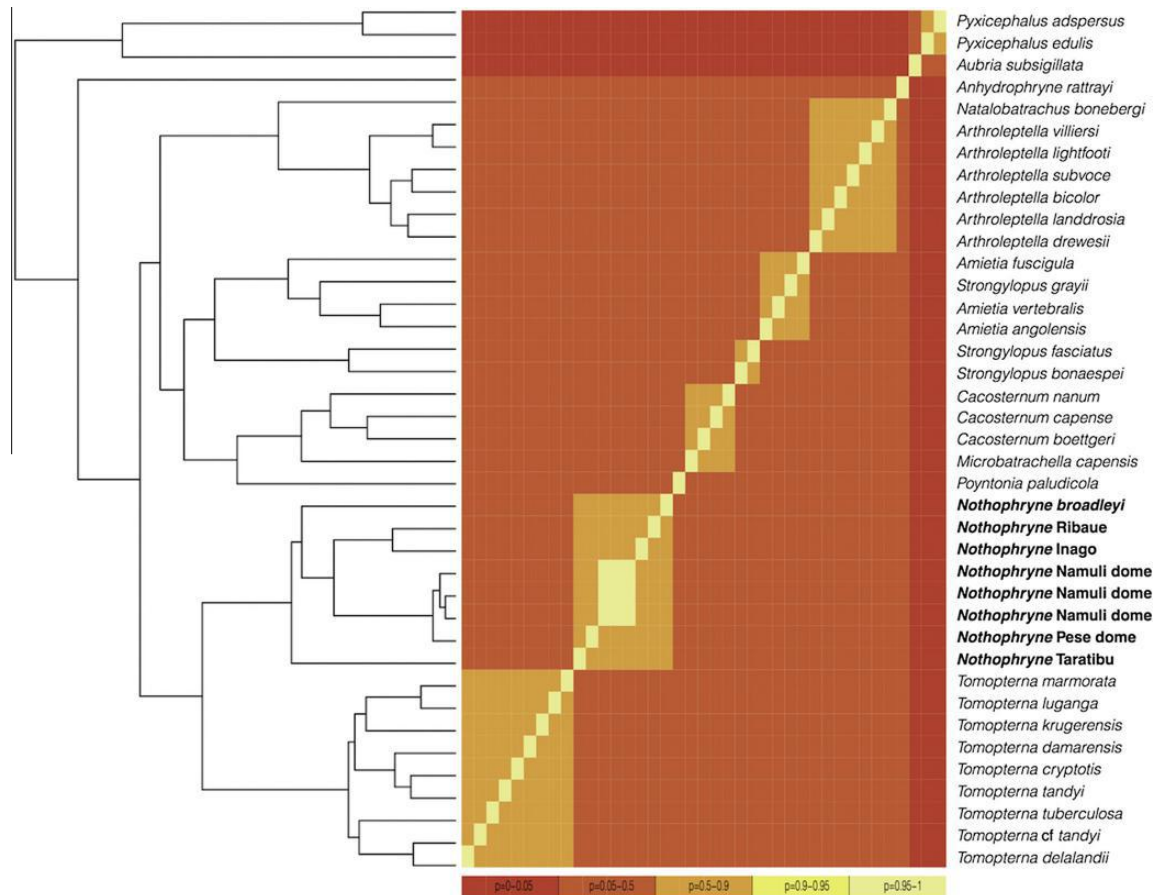
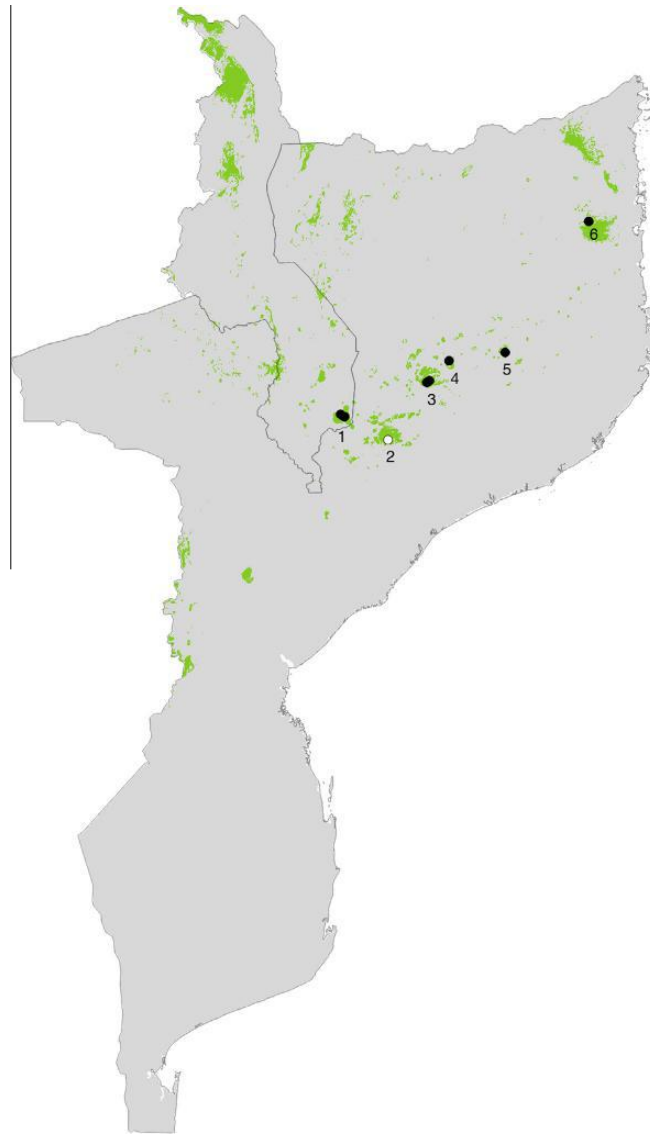

Fig. 7. Species delimitation using bGMYC. Heat map shows six putative species of *Nothophryne* (in bold).

on only 32 of the 77 species currently recognised in Pyxicephalidae. It is known that taxon sampling can affect ancestral state reconstruction (see Hardy, 2006), and hence the addition of the remaining taxa would be crucial to test hypotheses of the type of habitat occupied by the ancestor of pyxicephalids.

The evolution of terrestrialised breeding forms in pyxicephalids (i.e. eggs laid out of water) was first investigated by van der Meijden et al. (2011), and they inferred that direct development evolved independently twice in this group (*Arthroleptella* and *Anhydrophryne*). However, no comparative approaches were applied to examine these transitions. Our ancestral-state reconstruction corroborates independent terrestrialisation of breeding in *Arthroleptella* and *Anhydrophryne*. Additionally, semi-terrestrial breeding modes also evolved independently during the evolution of this family (i.e. *Nothophryne* and *Natalobatrachus*). The diversity of habitats and reproductive modes exhibited by pyxicephalids and their evolutionary lability might be the result of changes driven by geography. Climatic and geological changes across the African continent have been of crucial importance in explaining evolution in many groups (e.g., Ceccarelli et al., 2014; Couvreur et al., 2008; Loader et al., 2014; Matthee et al., 2004). Wider taxonomic sampling within Pyxicephalidae and a comprehensive understanding of their habitats are required before any firm conclusions can be made on the correlated evolution of breeding biology and geographic distribution.

Phylogenetic relationships of pyxicephalids provide an interesting insight into biogeographic patterns in sub-Saharan Africa, and in particular, connections between specific regions across large distances. The population of *Nothophryne* in coastal forest (Taratibu) inselbergs in northeastern Mozambique is a geographic outlier, nearly 600 km from Mount Mulanje and more than 200 km from the nearest isolate (Mount Ribáuè). Our discovery of this population suggests that there may have been a connection between the coastal forest and the Afromontane isolates from southern Malawi and north/central Mozambique (e.g., Mulanje, Mabu, Namuli) that no longer exists. Indeed, it has been suggested that subtropical forest was once widespread along the eastern margin of Africa, from Kenya to South Africa, during the Oligocene-Miocene (e.g., Axelrod and Raven, 1978). The aridification of East Africa, triggered by the formation of the East African Rift System, retracted the forested areas, which became confined to higher elevations (i.e. mountains and inselbergs) or coastal areas. Such changes might have been important in driving the isolation of populations of *Nothophryne*. Other taxa have similar distribution scattered across montane inselbergs and East African coastal forest, including frogs in the genus *Mertensophryne* (Poynton, 1991), caecilians in *Scolecophorus* (Farooq and Conradie, 2015) and chameleons in the genus *Rhampholeon* (Branch et al., 2014). Similar evidence from multiple taxa may strengthen biogeographic



**Fig. 8.** Modelled distribution of *Nothophryne broadleyi* using Maxent. Green areas represent habitat suitability when applying the minimum presence threshold. Data points used to generate the model are shown as black circles. The white circle represents the locality where *Nothophryne* was heard but not collected. (1) Mount Mulanje, (2) Mount Mabu, (3) Mount Namuli, (4) Mount Inago, (5) Mount Ribáuè and (6) Taratibu. (For interpretation of the references to colour in this figure legend, the reader is referred to the web version of this article.)

hypotheses regarding connections between these inselbergs and the timing of diversification events.

The phylogenetic position of *Tomopterna* and its grouping with the morphologically dissimilar *Nothophryne* provides an interesting example of divergence in form, also highlighting the problems of understanding evolutionary relationships based largely on morphology (Scott, 2005). In fact, the genus *Tomopterna* was previously thought to have disjunct distribution in continental Africa, Madagascar and Asia. *Laliostoma labrosum* (Cope, 1868), from Madagascar and *Sphaerotheca breviceps* (Schneider, 1799), from Sri Lanka, were previously included in *Tomopterna* based on their shared characters involved in burrowing (see Bossuyt and Milinkovitch,

2000 and references therein, e.g., Glaw et al., 1998). This example shows how parallelism in morphological traits can cause taxonomic confusion. In addition, *Nothophryne* provides yet another example of morphological parallelism—with similar tadpoles to other rock-dwellers with semi-terrestrial larvae in the family Petropedetidae). Other species of rock-dwellers with semi-terrestrial larvae, such as *Nothophryne*, are also found in Asia (*Nannophrys* Günther, 1869) and South America (*Cycloramphus* Tschudi, 1838).

The substantial genetic divergence observed between populations of *Nothophryne* could be predicted given their limited dispersal capabilities (considering their specialised habitat and

breeding). It is also interesting that the basal divergences within *Nothophryne* split the lineage at the edge of the distribution, at Taratibu, from all others. This might reflect a formerly more extensive distribution of subtropical forest across the region that became increasingly isolated and restricted to moist areas (i.e. Afromontane and coastal forest) over time (Axelrod and Raven, 1978; Brenan, 1978). The biogeographic interpretations of these patterns merits further investigation, particularly if additional populations are discovered on other inselbergs.

#### 4.2. Taxonomy and conservation

Our molecular-based analyses suggest that *Nothophryne* is not a monotypic genus and that there are likely multiple species distributed among isolated inselbergs as shown by large genetic differences between populations. In addition to the strong genetic differentiation, there are some obvious morphological differences (Fig. 9) that support the hypothesis that each mountain block has a distinct, unique species. For example, the populations from Taratibu are slightly flattened dorso-ventrally and have smooth skin on the dorsum, whereas the other populations have warty (Malawi) or spiky (Namuli, Inago and Ribáuè) dorsal skin. More comprehensive studies of these populations are required to document their morphological distinctiveness.

Additional populations are also likely to be present across this region given the paucity of study. For example, based on recent fieldwork in Mount Mabu, Mozambique, we suspect that *Nothophryne* is present there based on call records. Furthermore, this record could potentially confirm the ENM predictions about the suitability of that area for *Nothophryne*. The suggestion of multiple species of *Nothophryne* on Mount Namuli is not unprecedented; Poynton and Broadley (1985, p. 172) suggested the possible presence of two species on Mount Mulanje, based on a morphologically distinct specimen collected by Stevens at a much lower elevation and in a different situation to those from the type locality and

adjacent plateau. Overall, our work suggests that the distribution of *Nothophryne* is not yet well known. Future targeted fieldwork should explore these areas of predicted occurrence, providing additional tests for these predictions.

Recognition of more than one species of *Nothophryne* has conservation implications. The narrow ranges of these putative species—so far only known from a single mountain block each—draw our attention to their susceptibility. Furthermore, their specific habitat requirements and breeding biology means that they are likely to be susceptible to any changes in habitat quality. With the continuing practice of slash-and-burn agriculture on forests in Mozambique (Temudo and Silva, 2012), and on-going clearing due to population pressure, which impacts also upon inselbergs (Porembski and Barthlott, 2000), these species face serious risk of disappearing. Targeted surveys and studies are crucial to understand population trends and their precise distribution and habitat requirements.

#### Acknowledgements

We would like to thank various people and institutions for their contribution to this project. The Natural History Museum of Maputo provided collecting and export permits for Mozambique material. Forestry provided research permits and Mount Mulanje Conservation Trust (MMCT) provided logistical support to MJC and colleagues; Roger Bills from the South African Institute for Aquatic Biodiversity (SAIAB) facilitated the loan of topotypic genetic material. Julian Bayliss collected the first material from Mount Namuli and Mount Inago during the Darwin Initiative Project. SANBI 2014 expedition was funded by National Geographic Society (granted to KTH). Mike Scott (Khangela Safaris) provided field logistics. Cliff and Suretha Dorse provided for the photos of *Arthroleptella*. We also thank the Swiss-African Kick-Start Funding, the Freiwillige Akademische Gesellschaft (FAG) and the University of Basel for funding contributions. GBBS PhD is funded by

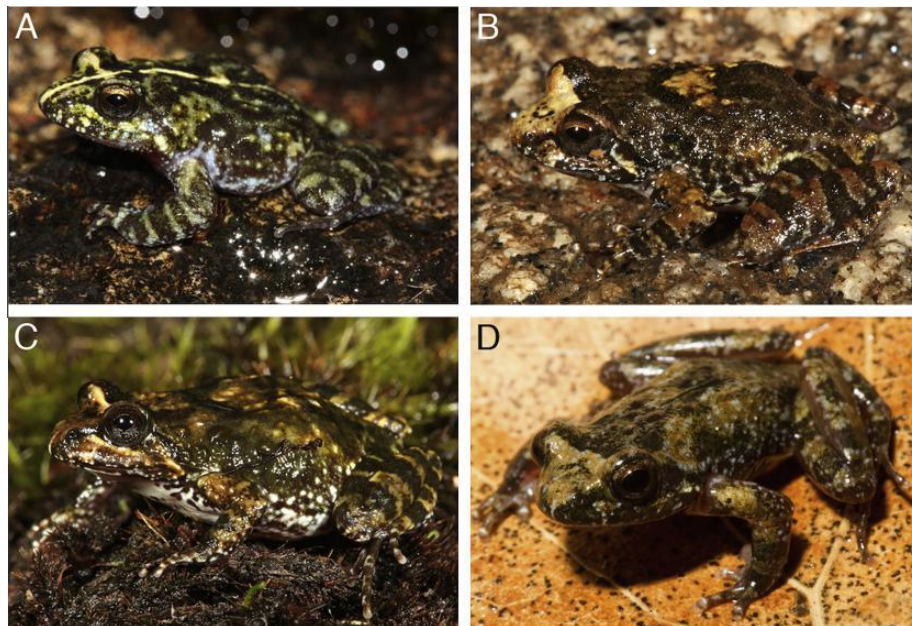

Fig. 9. *Nothophryne* populations from Malawi and Mozambique. (A) Mount Mulanje, (B) Mount Ribáuè, (C) Mount Namuli and (D) Taratibu. Photos A, B and C by W Conradie, and photo D by HM Farooq.



Eidgenössische Stipendienkommission für Ausländische Studierende (ESKAS). KST work is funded by an ELEVATE IRC fellowship. Mark Wilkinson, Christoph Liedtke, André Luiz Gomes de Carvalho, Lucinda Lawson and Chris Creevey provided valuable comments on the manuscript. We also thank the editor, Allan Larson, and two anonymous reviewers for their constructive comments on our manuscript. We dedicate this paper to Don Broadley, who sadly passed away on 10th March 2016. He was a driving force in African Herpetology in whose honour John Poynton named the first species of *Nothophryne*.

#### Appendix A. Supplementary material

Supplementary data associated with this article can be found, in the online version, at <http://dx.doi.org/10.1016/j.ympcv.2016.03.021>.

#### References

- Abascal, F., Zardoya, R., Telford, M.J., 2010. TranslatorX: multiple alignment of nucleotide sequences guided by amino acid translations. *Nucl. Acids Res.* 38, W7–W13. <http://dx.doi.org/10.1093/nar/gkq291>.
- Axelrod, D.L., Raven, P.H., 1978. Late Cretaceous and Tertiary vegetation history of Africa. In: *Biogeography and Ecology of Southern Africa*. Springer, pp. 77–130.
- Barej, M.F., Schmitz, A., Günther, R., Loader, S.P., Mahlow, K., Rödel, M.-O., 2014. The first endemic West African vertebrate family – a new anuran family highlighting the uniqueness of the Upper Guinean biodiversity hotspot. *Front. Zool.* 11, 8. <http://dx.doi.org/10.1186/1742-9994-11-8>.
- Bayliss, J., Monteiro, J., Fishpool, L., Congdon, C., Bampton, I., Bruessow, C., Matimele, H., Banze, A., Timberlake, J.R., 2010. Biodiversity and conservation of Mount Inago, Mozambique. *Rep. Prod. Darwin Initiat.* Award 15, 36.
- Bivand, R., Keitt, T., Rowlingson, B., 2015. rgdal: Bindings for the Geospatial Data Abstraction Library.
- Blackburn, D.C., 2008. Biogeography and evolution of body size and life history of African frogs: phylogeny of squeakers (*Arthroleptis*) and long-fingered frogs (*Cardioglossa*) estimated from mitochondrial data. *Mol. Phylogenet. Evol.* 49, 806–826. <http://dx.doi.org/10.1016/j.ympcv.2008.08.015>.
- Blake, D.K., 1965. The fourth Umtali museum expedition to Mozambique: November–December, 1964. *J. Herpetol. Assoc. Rhod.* 23–24, 31–46. <http://dx.doi.org/10.1080/0440730X.1965.9650549>.
- Bossuyt, F., Brown, R.M., Hillis, D.M., Cannatella, D.C., Milinkovitch, M.C., 2006. Phylogeny and biogeography of a cosmopolitan frog radiation: Late cretaceous diversification resulted in continent-scale endemism in the family ranidae. *Syst. Biol.* 55, 579–594. <http://dx.doi.org/10.1080/10635150600812551>.
- Bossuyt, F., Milinkovitch, M.C., 2000. Convergent adaptive radiations in Madagascan and Asian ranid frogs reveal covariation between larval and adult traits. *Proc. Natl. Acad. Sci.* 97, 6585–6590. <http://dx.doi.org/10.1073/pnas.97.12.6585>.
- Bouckaert, R., Heled, J., Kühnert, D., Vaughan, T., Wu, C.-H., Xie, D., Suchard, M.A., Rambaut, A., Drummond, A.J., 2014. BEAST 2: a software platform for Bayesian evolutionary analysis. *PLoS Comput. Biol.* 10, e1003537. <http://dx.doi.org/10.1371/journal.pcbi.1003537>.
- Branch, W.R., Bayliss, J., Tolley, K.A., 2014. Pygmy chameleons of the *Rhampholeon platyceps* complex (Squamata: Chamaeleonidae): description of four new species from isolated “sky islands” of northern Mozambique. *Zootaxa* 3814, 1–36.
- Brenan, J.P.M., 1978. Some aspects of the phytogeography of tropical Africa. *Ann. Missouri Bot. Gard.* 65, 437–478.
- Carstens, B.C., Pelletier, T.A., Reid, N.M., Satler, J.D., 2013. How to fail at species delimitation. *Mol. Ecol.* 22, 4369–4383. <http://dx.doi.org/10.1111/mec.12413>.
- Ceccarelli, F.S., Menegon, M., Tolley, K.A., Tilbury, C.R., Gower, D.J., Laserna, M.H., Kasahun, R., Rodriguez-Prieto, A., Haggmann, R., Loader, S.P., 2014. Evolutionary relationships, species delimitation and biogeography of Eastern Afrotropical horned chameleons (Chamaeleonidae: Trioceros), doi:<http://dx.doi.org/10.1016/j.ympcv.2014.07.023>.
- Channing, A., Schmitz, A., Burger, M., Kielgast, J., 2013. A molecular phylogeny of African Dainty Frogs, with the description of four new species (Anura: Pyxicephalidae: *Cacosternum*). *Zootaxa* 3701, 518–550.
- Couvreur, T.L.P., Chatrou, L.W., Sosef, M.S.M., Richardson, J.E., 2008. Molecular phylogenetics reveal multiple tertiary vicariance origins of the African rain forest trees. *BMC Biol.* 6, 54. <http://dx.doi.org/10.1186/1741-7007-6-54>.
- Dubois, A., 1992. Notes sur la classification des Ranidae (Amphibiens Anoures). *Bull. Mens. Soc. Linn. Lyon* 61, 305–352.
- Edgar, R.C., 2004. MUSCLE: multiple sequence alignment with high accuracy and high throughput. *Nucl. Acids Res.* 32, 1792–1797. <http://dx.doi.org/10.1093/nar/gkh340>.
- Farooq, H.O.M., Conradie, W., 2015. Second record of a *Scolecormorphus kirkii* Boulenger, 1883 (Gymnophiona: Scolecormorphidae) for Mozambique. *Herpetol. Notes*.
- Frost, D.R., 2015. Amphibian Species of the World: an Online Reference. Version 6.0 (Accessed on 20 December 2015). Electronic Database accessible at <<http://research.amnh.org/herpetology/amphibia/index.html>>. American Museum of Natural History, New York, USA.
- Frost, D.R., Grant, T., Faivovich, J., Bain, R.H., Haas, A., Haddad, C.F.B., De Sá, R.O., Channing, A., Wilkinson, M., Donnellan, S.C., Raxworthy, C.J., Campbell, J.A., Blotto, B.L., Moler, P., Drewes, R.C., Nussbaum, R.A., Lynch, J.D., Green, D.M., Wheeler, W.C., 2006. The amphibian tree of life. *Bull. Am. Museum Nat. Hist.* 297, 1–291. [http://dx.doi.org/10.1206/0003-0090\(2006\)297\[0001:TATOL\]2.0.CO;2](http://dx.doi.org/10.1206/0003-0090(2006)297[0001:TATOL]2.0.CO;2).
- Glau, F., Vences, M., Böhme, W., 1998. Systematic revision of the genus *Aglyptodactylus* Boulenger, 1919 (Amphibia: Ranidae), and analysis of its phylogenetic relationships to other Madagascan ranid genera (*Tomopterna*, *Boophis*, *Mantidactylus*, and *Mantella*). *J. Zool. Syst. Evol. Res.* 36, 17–37. <http://dx.doi.org/10.1111/j.1439-0469.1998.tb00775.x>.
- Gomez-Mestre, I., Pyron, R.A., Wiens, J.J., 2012. Phylogenetic analyses reveal unexpected patterns in the evolution of reproductive modes in frogs. *Evolution* 66, 3687–3700. <http://dx.doi.org/10.1111/j.1558-5646.2012.01715.x>.
- Guo, X., Dai, X., Chen, D., Papenfuss, T.J., Ananjeva, N.B., Melnikov, D.A., Wang, Y., 2011. Phylogeny and divergence times of some racerunner lizards (Lacertidae: *Eremias*) inferred from mitochondrial 16S rRNA gene segments. *Mol. Phylogenet. Evol.* 61, 400–412.
- Hardy, C.R., 2006. Reconstructing ancestral ecologies: challenges and possible solutions. *Divers. Distrib.* 12, 7–19. <http://dx.doi.org/10.1111/j.1366-9516.2006.00207.x>.
- Hijmans, R.J., 2015. raster: Geographic Data Analysis and Modeling.
- Hijmans, R.J., Cameron, S.E., Parra, J.L., Jones, P.G., Jarvis, A., 2005. Very high resolution interpolated climate surfaces for global land areas. *Int. J. Clim.* 25, 1965–1978. <http://dx.doi.org/10.1002/joc.1276>.
- IUCN, 2014. The IUCN Red List of Threatened Species. Version 2015-4. Downloaded on 15 November 2015.
- Katoh, K., Standley, D.M., 2013. MAFFT multiple sequence alignment software version 7: improvements in performance and usability. *Mol. Biol. Evol.* 30, 772–780. <http://dx.doi.org/10.1093/molbev/mst010>.
- Kearse, M., Moir, R., Wilson, A., Stones-Havas, S., Cheung, M., Sturrock, S., Buxton, S., Cooper, A., Markowitz, S., Duran, C., Thierer, T., Ashton, B., Meintjes, P., Drummond, A., 2012. Geneious Basic: an integrated and extendable desktop software platform for the organization and analysis of sequence data. *Bioinformatics* 28, 1647–1649. <http://dx.doi.org/10.1093/bioinformatics/bts199>.
- LANFEAR, R., Calcott, B., Ho, S.Y.W., Guindon, S., 2012. Partitionfinder: combined selection of partitioning schemes and substitution models for phylogenetic analyses. *Mol. Biol. Evol.* 29, 1695–1701. <http://dx.doi.org/10.1093/molbev/mss020>.
- Lehner, B., Verdin, K., Jarvis, A., 2006. Hydrological data and maps based on Shuttle elevation derivatives at multiple scales (HydroSHEDS)-Technical Documentation. World Wildl Fund US, Washington, DC.
- Letunic, I., Bork, P., 2011. Interactive Tree Of Life v2: online annotation and display of phylogenetic trees made easy. *Nucl. Acids Res.* 39, W475–W478. <http://dx.doi.org/10.1093/nar/gkr201>.
- Lewis, P.O., 2001. A likelihood approach to estimating phylogeny from discrete morphological character data. *Syst. Biol.* 50, 913–925. <http://dx.doi.org/10.1080/106351501753462876>.
- Loader, S.P., Sara Ceccarelli, F., Menegon, M., Howell, K.M., Kassahun, R., Mengistu, A.A., Saber, S.A., Gebresenbet, F., de Sá, R., Davenport, T.R.B., Larson, J.G., Müller, H., Wilkinson, M., Gower, D.J., 2014. Persistence and stability of Eastern Afrotropical forests: evidence from brevicipitid frogs. *J. Biogeogr.* 41, 1781–1792. <http://dx.doi.org/10.1111/jbi.12331>.
- Maddison, W.P., Maddison, D.R., 2015. Mesquite: a modular system for evolutionary analysis. Version 2.75. 2011 <<http://mesquiteproject.org>>.
- Matthee, C.A., Tilbury, C.R., Townsend, T., 2004. A phylogenetic review of the African leaf chameleons: genus *Rhampholeon* (Chamaeleonidae): the role of vicariance and climate change in speciation. *Proc. Biol. Sci.* 271, 1967–1975. <http://dx.doi.org/10.1098/rspb.2004.2806>.
- Pereira, E.B., Collevatti, R.G., Kokubun, M.N.de C., Miranda, N.E.de O., Maciel, N.M., 2015. Ancestral reconstruction of reproductive traits shows no tendency toward terrestriality in leptodactyline frogs. *BMC Evol. Biol.* 15, 91. <http://dx.doi.org/10.1186/s12862-015-0365-6>.
- Phillips, S.J., Anderson, R.P., Schapire, R.E., 2006. Maximum entropy modeling of species geographic distributions. *Ecol. Modell.* 190, 231–259. <http://dx.doi.org/10.1016/j.ecolmodel.2005.03.026>.
- Porembski, S., Barthlott, W. (Eds.), 2000. Inselbergs: biotic diversity of isolated rock outcrops in tropical and temperate regions. *Ecological studies*, vol. 146. Springer-Verlag, Heidelberg, Germany, 524 pp. ISBN 3540672699.
- Poynton, J.C., 1991. Amphibians of Southeastern Tanzania, with special reference to *Stephopaedes* and *Mertensophryne* (Bufonidae). *Bull. Mus. Comp. Zool., Harvard* 152, 451–472.
- Poynton, J.C., 1999. Distribution of amphibians in sub-Saharan Africa, Madagascar and Seychelles. *Patterns Distrib. Amphib. a Glob. Perspect.* Johns Hopkins Univ. Press, Balt., pp. 483–539.
- Poynton, J.C., 1963. Descriptions of southern African amphibians. *Ann. Natal Museum* 14, 319–332.
- Poynton, J.C., Broadley, D.G., 1985. Amphibia Zambeziaca 2. Ranidae. *Ann. Natal Mus.* 27, 115–181.
- Pyron, R.A., Wiens, J.J., 2011. A large-scale phylogeny of Amphibia including over 2800 species, and a revised classification of extant frogs, salamanders, and caecilians. *Mol. Phylogenet. Evol.* 61, 543–583. <http://dx.doi.org/10.1016/j.ympcv.2011.06.012>.

- Rambaut, A., Suchard, M., Xie, D., Drummond, A., 2014. Tracer v1. 6 <<http://beast.bio.ed.ac.uk>>.
- Reid, N.M., Carstens, B.C., 2012. Phylogenetic estimation error can decrease the accuracy of species delimitation: a Bayesian implementation of the general mixed Yule-coalescent model. *BMC Evol. Biol.* 12, 196. <http://dx.doi.org/10.1186/1471-2148-12-196>.
- Ronquist, F., Huelsenbeck, J.P., 2003. MrBayes 3: Bayesian phylogenetic inference under mixed models. *Bioinformatics* 19, 1572–1574. <http://dx.doi.org/10.1093/bioinformatics/btg180>.
- Scott, E., 2005. A phylogeny of ranid frogs (Anura: Ranoidea: Ranidae), based on a simultaneous analysis of morphological and molecular data. *Cladistics* 21, 507–574. <http://dx.doi.org/10.1111/j.1096-0031.2005.00079.x>.
- Shimodaira, H., 2002. An approximately unbiased test of phylogenetic tree selection. *Syst. Biol.* 51 (3), 492–508. <http://dx.doi.org/10.1080/10635150290069913>.
- Shimodaira, H., Hasegawa, M., 2001. CONSEL: for assessing the confidence of phylogenetic tree selection. *Bioinformatics* 17, 1246–1247. <http://dx.doi.org/10.1093/bioinformatics/17.12.1246>.
- Siu-Ting, K., Gower, D.J., Pisani, D., Kassahun, R., Gebresenbet, F., Menegon, M., Mengistu, A.A., Saber, S.A., de Sá, R., Wilkinson, M., Loader, S.P., 2014. Evolutionary relationships of the critically endangered frog *Ericabatrachus baleensis* Largen, 1991 with notes on incorporating previously unsampled taxa into large-scale phylogenetic analyses. *BMC Evol. Biol.* 14, 44. <http://dx.doi.org/10.1186/1471-2148-14-44>.
- Stamatakis, A., 2014. RAxML version 8: a tool for phylogenetic analysis and post-analysis of large phylogenies. *Bioinformatics* 30, 1312–1313. <http://dx.doi.org/10.1093/bioinformatics/btu033>.
- Tamura, K., Stecher, G., Peterson, D., Filipiński, A., Kumar, S., 2013. MEGA6: molecular evolutionary genetics analysis version 6.0. *Mol. Biol. Evol.* 30, 2725–2729. <http://dx.doi.org/10.1093/molbev/mst197>.
- Temudo, M.P., Silva, J.M.N., 2012. Agriculture and forest cover changes in post-war Mozambique. *J. Land Use Sci.* 7, 425–442. <http://dx.doi.org/10.1080/1747423X.2011.595834>.
- Timberlake, J.R., Dowsett-Lemaire, F., Bayliss, J., Alves, T., Baena, S., Bento, C., Cook, K., Francisco, J., Harris, T., Smith, P., et al., 2009. Mt Namuli, Mozambique: biodiversity and conservation. *Rep. Darwin Initiat. Award* 15, 36.
- Tolley, K.A., De Villiers, A.L., Cherry, M.L., Measey, G.J., 2010. Isolation and high genetic diversity in dwarf mountain toads (*Capensibufo*) from South Africa. *Biol. J. Linn. Soc.* 100, 822–834. <http://dx.doi.org/10.1111/j.1095-8312.2010.01469.x>.
- van der Meijden, A., Crottini, A., Tarrant, J., Turner, A., Vences, M., 2011. Multi-locus phylogeny and evolution of reproductive modes in the Pyxicephalidae, an African endemic clade of frogs. *Afr. J. Herpetol.* 60, 1–12. <http://dx.doi.org/10.1080/21564574.2010.523904>.
- van der Meijden, A., Vences, M., Hoegg, S., Meyer, A., 2005. A previously unrecognized radiation of ranid frogs in Southern Africa revealed by nuclear and mitochondrial DNA sequences. *Mol. Phylogenet. Evol.* 37, 674–685. <http://dx.doi.org/10.1016/j.ympev.2005.05.001>.
- Zhang, P., Liang, D., Mao, R.-L., Hillis, D.M., Wake, D.B., Cannatella, D.C., 2013. Efficient sequencing of Anuran mtDNAs and a mitogenomic exploration of the phylogeny and evolution of frogs. *Mol. Biol. Evol.* 30, 1899–1915. <http://dx.doi.org/10.1093/molbev/mst091>.

# CHAPTER II

Impact of species delimitation and sampling on niche models  
and phylogeographical inference: a case study of the East

African reed frog *Hyperolius substriatus* Ahl 1931

Gabriela B. Bittencourt-Silva, Lucinda P. Lawson, Krystal A. Tolley, Daniel M. Portik,  
Christopher D. Barratt, Peter Nagel, Simon P. Loader

**Status:** Under Review (Molecular Phylogenetics and Evolution)

**Impact of species delimitation and sampling on niche models and phylogeographical inference: a case study of the East African reed frog *Hyperolius substriatus* Ahl 1931**

Gabriela B. Bittencourt-Silva<sup>1</sup>, Lucinda P. Lawson<sup>2,3,4</sup>, Krystal A. Tolley<sup>5,6</sup>, Daniel M. Portik<sup>7</sup>, Christopher D. Barratt<sup>1</sup>, Peter Nagel<sup>1</sup>, Simon P. Loader<sup>1,8</sup>

1- Department of Environmental Sciences, University of Basel, Basel 4056, Switzerland

2- Committee on Evolutionary Biology, University of Chicago, 1025 E. 57th St. Culver Hall 402. Chicago, IL 60637, USA

3- Field Museum of Natural History, 1400 S. Lake Shore Dr. Chicago, IL 60605, USA

4- University of Cincinnati, 614 Rieveschl Hall. Cincinnati, OH 45221, USA

5- South African National Biodiversity Institute, Rhodes Drive, Private Bag X7, Newlands, Claremont 7735, Cape Town, South Africa

6- Department of Botany & Zoology, Stellenbosch University, Private Bag X1, Matieland 7602, Stellenbosch, South Africa

7- Museum of Vertebrate Zoology and Department of Integrative Biology, 3101 Valley Life Sciences Building, University of California, Berkeley, California 94720, United States

8- University of Roehampton, Department of Life Sciences, London, SW15 4JD, United Kingdom

**Abstract**

Ecological niche models (ENMs) have been used in a wide range of ecological studies. In biogeographic studies these models have, among other things, helped in the discovery of new allopatric populations, and even new species. However, small sample sizes and unclear taxonomic delimitation can impose many challenges to the models, often decreasing their accuracy. Herein we examine the sensitivity of ENMs to the addition of new geographically isolated populations, and the impact of applying different taxonomic delimitations. The East African reed frog *Hyperolius substriatus* Ahl, 1931 was used as a case study based on previous ENMs predictions and its genetic structure. Our results suggest that addition of new data and reanalysis of *H. substriatus* operational taxonomic units (OTUs) improved our understanding about the evolutionary history of this group of frogs. ENMs provided robust predictions, even when some populations were deliberately excluded from the models. Splitting the lineages based on genetic relationships and analysing the ENMs separately provided insights about the biogeographical processes that lead to the current distribution of *H. substriatus*.

**Keywords:** Aridification; biogeography; Hyperoliidae; Mozambique; operational taxonomic units; vicariance

### 1. Introduction

Ecological Niche Models (ENMs; *sensu* Peterson and Soberón, 2012) have become an important part of phylogeographical studies (Chan et al., 2011). This approach provides a basis for estimating current, past, and future distributions of species. ENMs have provided major insights across many fields of biology, but their results can also be difficult to interpret and quantifying their uncertainty can be difficult (e.g. Araújo and Guisan, 2006). Evaluating predictions of species distributions based on ENMs in African ecosystems, which are often characterized by incomplete information and uncertain evolutionary and taxonomic statuses, is still a major challenge. An important step for ameliorating these difficulties is to identify potential cryptic diversity present in species, which allows the correct treatment of taxonomic units and thus appropriate selection of occurrence data necessary for producing more accurate models.

Raxworthy et al. (2007) demonstrated how the accuracy of niche models can be improved by defining different taxonomic units from species complexes. They generated ENMs for putative species of day geckos (*Phelsuma madagascariensis* species group) and concluded that ENMs based on the new species limits provided a better fit to the known distribution of the geckos than models treating all lineages as a single species. Likewise, (Aguar et al., 2015) showed that the addition of new samples from geographically distinct populations improved the precision of ENMs for leaf-nosed bats from South America.

The East African reed frog *Hyperolius substriatus* Ahl, 1931 is found in moist and dry forests, from 300–2000 m above sea level (asl), across the Eastern Afromontane region of East Africa. This includes Eastern Arc Mountains (EAM), Southern Highlands and Livingstone Mountains of Tanzania, and Highlands of Malawi and northern Mozambique (see Fig. 1; IUCN SSC Amphibian Specialist Group, 2013). The degree of isolation or connectivity between forest-restricted communities throughout this region (such as those containing *H. substriatus*) is poorly known, but it is hypothesised that riverine corridors and watershed relationships may have maintained gene flow between some forest fragments in montane amphibians (Blackburn and Measey, 2009; Measey et al., 2007; Measey and Tolley, 2011).

In the past 10 million years, the landscape of East Africa has undergone substantial changes, including the uplift of the East African Rift System (Sepulchre et al., 2006), aridification (Maslin et al., 2014; Sepulchre et al., 2006), expansion of savannah ecosystems,

and fragmentation of forests (deMenocal, 1995; Maslin et al., 2014). These changes were followed by large-scale shifts in faunal communities as species either adapted to newly emerging niches of open savannah areas, or shifted distributions to maintain their ecological niches (moved into or out of the region). Communities of forest-restricted taxa became isolated in fragments scattered along the coast or at higher elevations (e.g. Maslin et al., 2014) as most lowland forested areas were converted to savannah.

Phylogenetic relationships and population structure within *H. substriatus* were investigated by Lawson (2013), who found that population genetic differentiation was best explained by major and minor hydrological basins acting as barriers to dispersal and their historical population matched corridors of suitable habitat areas predicted from ENMs. Three allopatric clades were identified: northern/central Malawian Highlands, EAM, and southern Malawian Highlands. Newly discovered populations from Mozambique (Mt. Mabu, Mt. Namuli and Serra Jeci - Bayliss et al., 2014; Portik et al., 2013) found after the completion of Lawson's (2013) analyses, were predicted to cluster with populations from either the EAM or the southern Malawi Highlands on the basis of belonging to the same major hydrological basin.

In this study, we investigate the impact of expanded phylogenetic sampling and improved phylogenetic resolution on ENM predictions. The recent discovery of new populations of *H. substriatus* outside of the previously described range offers a unique opportunity to assess how robust ENM predictions are by examining how the inclusion of new locality data affects the models. We also examine how ENMs are impacted by the definition of different operational taxonomic units (OTUs), given that the genetic variation uncovered in phylogeographic studies can be interpreted using different criteria. We examine ENMs generated from splitting the dataset into distinct OTUs to investigate whether these allopatric lineages occupy similar niches (niche conservatism) or if they have different ecological requirements (ecological speciation). In case of niche conservatism, we would expect that a vicariant barrier to dispersal is maintaining their non-overlapping geographic ranges. However, if they occupy significantly different niches, ecological speciation is the most likely scenario.

Our overall aim is to examine the sensitivity of ENMs to sample completeness and to the definition of taxonomic units, and its impact on phylogeographic studies. This may be particularly relevant in ecosystems where there is great uncertainty in the distribution or

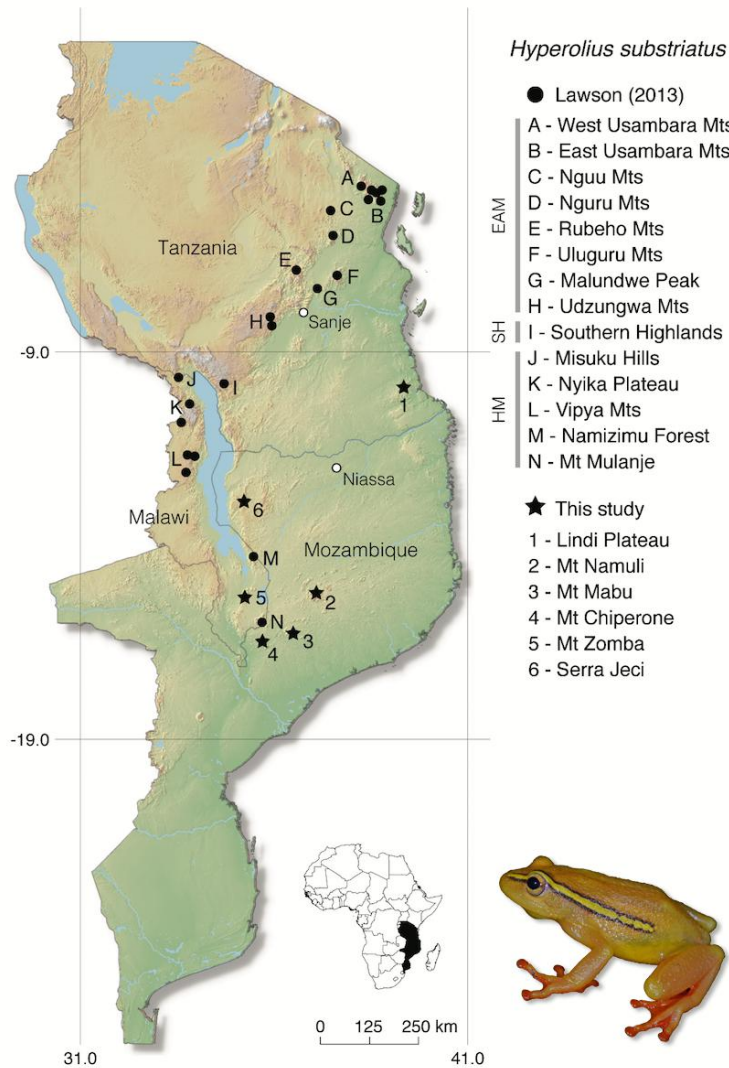

**FIGURE 2. Distribution map of *Hyperolius substriatus*.** Black circles represent populations included in Lawson’s (2013) study. Stars indicate newly discovered populations. White circles indicate populations recorded but without molecular data available. Eastern Arc Mountains (EAM); Southern Highlands and Livingstone Mountains (SH); Highlands of Malawi (HM).

uniqueness of lineages – such as in a tropical environment where sampling is often incomplete and potentially regionally biased due to international borders.

## 2. Material and methods

### 2.1. Samples and sequencing

Our sampling includes 28 populations of *Hyperolius substriatus*, six of which are newly discovered. Four of the new populations are from northern Mozambique (Mts. Chipirone, Mabu, Namuli, and Serra Jeci), one from southern Malawi (Mt. Zomba), and one from coastal



Tanzania (Lindi Plateau). Locality data, voucher numbers and GenBank accession numbers are presented in Table A.1 in Supporting Information.

We extracted and sequenced DNA from liver and muscle of freshly collected specimens preserved in 95% ethanol following Bittencourt-Silva et al. (2016). In order to compare our newly collected samples with the ones presented in Lawson (2013), we sequenced the entire mitochondrial NADH dehydrogenase subunit 2 gene (*ND2*), and the nuclear genes pro-opiomelanocortin (*POMC*) and cellular myelocytomatosis proto-oncogene (*C-myc*). In addition, we also sequenced the mitochondrial 16S rRNA gene (*16S*) using primers and PCR conditions described in Bittencourt-Silva et al. (2016). Summary statistics of selected molecular markers are shown in Table 1.

**TABLE 2. Summary of variable and constant sites of selected molecular markers.**

Locus	N° sites	N° variable sites	N° parsimony-informative sites
16S	527	53	33
ND2	1152	142	242
C-myc	1303	48	48
POMC	628	20	43

## 2.2. Data matrix and alignment

We combined sequences of *Hyperolius substriatus* from Lawson's (2010, 2013) studies, available on GenBank, with our newly sequenced samples. The total number of sequences included in the matrix per marker was 152 (*ND2*: 1152 bp), 155 (*POMC*: 628 bp), 152 (*C-myc*: 1303 bp), and 22 (*16S*: 527 bp). Sequences were aligned in Geneious v.7.1 (Kearse et al., 2012) using MAFFT v.7 (Kato and Standley, 2013) applying the algorithm E-INS-i, and subsequently aligned by eye. The combined dataset represents 172 individuals (3083 bp) of *H. substriatus*, plus an outgroup (*H. mitchelli*), selected based on currently hypothesised relationships between these taxa and availability of sequences on GenBank.

## 2.3. Phylogenetic analyses

Phylogenetic relationships were inferred for mitochondrial and nuclear genes using maximum likelihood (ML) and Bayesian inference (BI) approaches. We used PartitionFinder v.1.1.1 (Lanfear et al., 2012) to select the best-fit models of nucleotide substitution and partition schemes using the Bayesian information criterion (BIC; see Table B.1). ML analyses were performed with RAxML v.8 (Stamatakis, 2014) using the GTR+GAMMA model, and support values were estimated using non-parametric bootstrap (auto-MRE). BI analyses were performed in BEAST v.2.4.1 (Bouckaert et al., 2014) where time-calibrated trees were inferred using estimated substitution rates: *16S* = 0.00277/lineage/my (Lemmon et al., 2007), *ND2* = 0.00957/lineage/my (Crawford, 2003), *C-myc* = 0.0006334/lineage/my and *POMC* = 0.000721/lineage/my (Lawson, 2010). We used a strict clock model, a constant population size coalescent tree prior, and the MCMC chains were run for 50 million generations, sampling every 5000 generations with the first 10% discarded as burn-in. A species tree was estimated using a multilocus coalescent approach implemented in \*BEAST v.2.4.1. (Bouckaert et al., 2014) to account for incomplete lineage sorting and avoid overestimation of divergence times. \*BEAST was run for 100 million generations, sampling every 1000 with the same substitution models, strict clocks, and rates as in BEAST analyses. A Yule species tree with piecewise lineage and constant root prior was used with a random starting tree. Convergence for both the BEAST and \*BEAST analyses were examined by checking the effective sample size (ESS) values in Tracer v.1.6 (Rambaut et al., 2014) using a threshold of >200. The program TreeAnnotator (Bouckaert et al., 2014) was used to create the maximum clade credibility (MCC) tree for each analyses.

#### *2.4. Identification of operational taxonomic units (OTUs)*

We used the three allopatric clades identified by Lawson (2013), which were upheld in this expanded dataset, as a basis for lineage delimitation. We calculated the inter-clade average and minimum uncorrected pairwise distance (p-distance) between *16S* sequences using MEGA v.7 (Kumar et al., 2016). Lawson (2013) included populations from the Udzungwa Mountains in the Eastern Arc Mountain clade (clade 3) despite low support for association with clade 3. Given the high number of endemic species in this mountain block (e.g. Menegon and Salvidio, 2005; Rovero et al., 2009) we consider the populations from the Udzungwa Mountains as a separate clade when considering genetic distances. However,

---

because of the reduced number of points compared to other groups, we grouped this clade with clade 3 for ENMs and niche analyses.

### 2.5. *Ecological niche models*

We generated ENMs for the three main clades recovered by our species tree (clades 1, 2, 3 + Udzungwa) to investigate if there is a separation of ecological niches among the clades. For comparison, a niche model using all samples (“lumped”) was also generated. ENMs were generated using present and past (Last Glacial Maximum; LGM and Mid-Holocene) climatic conditions to account for possible past connections between current forest fragments. Nine bioclimatic variables were downloaded from the WorldClim database (Global Climate Model: CCSM4; Hijmans et al., 2005) for current climate and Mid-Holocene (*ca.* 1 km resolution), and LGM (*ca.* 5 km resolution). The selection of variables follows Lawson (2013). ENMs were generated in MaxEnt v.3.3.3k (Phillips et al., 2006) using logistic outputs and the default settings from the program. The models were validated using a k-fold cross-validation algorithm to account for the small sample size of each clade (see Pearson et al., 2007). The area of analysis was limited to Tanzania, Malawi and Mozambique. In order to facilitate the comparison between models we created binary presence/absence maps by applying a conservative threshold of the minimum training presence (Pearson et al., 2007).

*Hyperolius substriatus* populations have also been found at Sanje in the northeastern end of the Udzungwa Mountains (M. Menegon, pers. comm.) and in the Niassa Game Reserve of northern Mozambique (Branch, 2004). However, given the lack of molecular data, and hence the uncertainty regarding their phylogenetic position, these locality records were not included in the niche analyses.

### 2.6. *Test for niche conservatism/divergence*

The three clades of *H. substriatus* are allopatrically distributed, which could lead to misleading conclusions about niche divergence simply because of disjunct geographic ranges (i.e., spatial autocorrelation). To account for this issue we conducted a background test, which determines whether the ENMs of two allopatrically distributed populations are more or less similar than expected by chance given the geographical region where they occur (see Warren et al., 2010, 2008). For each clade, a minimum convex polygon of the occurrence area was created and used as “background area” (i.e. environmental background where the species

occur). Because of the proximity and small number of points (especially clades 1 and 3) a buffer zone of 10 km was created around each point before drawing the polygons. The population from Lindi, in the coastal region of Tanzania, occurs in an isolated patch of coastal forest considered to be a sub-centre of endemism containing *c.* 30 km<sup>2</sup> of forest (Burgess et al., 2007). This locality was excluded from the polygon because its inclusion would add a large area of unsuitable habitat (i.e. the surrounding *miombo* woodland) for *H. substriatus*.

To account for niche similarities among clades, niche overlap between each pair of clades was calculated using Schoener's *D* metric. If the observed value of the niche similarity among clades (Schoener's *D*) is significantly higher (niche conservatism) or lower (niche divergence) than expected from the null distribution, the null hypothesis is rejected (i.e. niche conservatism/divergence between clades is no more than expected based on the availability of habitat). For comparison, the test was conducted in two ways, (i) using continuous probabilities of habitat suitability generated by the ENMs, and (ii) applying a minimum training presence threshold (MTP). When this threshold is applied, the minimum value for habitat suitability (presence) corresponds to the lowest occurrence point and every cell with a greater or equal value is treated as suitable (presence). Hence, it would be expected that the background area is less likely to include unsuitable areas for *H. substriatus*. Both niche similarity analysis and background tests were conducted using ENMTools (Warren et al., 2010).

### **3. Results**

#### *3.1. Phylogenetic analyses*

The topology of our estimated multilocus coalescent species tree agrees with the topology presented by Lawson (2013) with respect to the position of the three main clades: northern/central Malawian Highlands (clade 1), southern Malawian Highlands (clade 2) and Eastern Arc Mountain clade (clade 3 + Udzungwa; see Figs. 1 and 2). However, the support for the sister relationship of Udzungwa Mountains and the rest of the EAM was weak (\*BEAST) or unresolved (RAxML) in both our study and in Lawson (2013). Herein we consider the populations from the Udzungwa Mountains as a separate clade, and the remaining populations of the Eastern Arc Mountains as part of clade 3. In the \*BEAST tree, the six newly discovered populations of *Hyperolius substriatus* grouped within clade 2. The estimated divergence time between clade 1 and the two other clades is *c.* 6 mya (million years

ago), in the late Miocene, and the split between clade 2 and clade 3 was estimated to have occurred in the late Pliocene, *c.* 3 mya. Tree topologies from multilocus, nuclear and mitochondrial genes are provided in the supplementary material (see Fig. A.1).

Both multilocus and mitochondrial trees show two sympatric populations in Serra Jeci (see Fig. B.1), one grouping with populations from southern Malawi (Serra Jeci 1), and the other with Lindi (Serra Jeci 2). The *I6S* p-distance between Serra Jeci 1 (including the Southern Highlands and southern Malawi clade) and Serra Jeci 2 (including Lindi) is 3.8%, whereas the difference between the latter and the clade comprising Mts. Mabu, Namuli and Chipirone (Mozambican clade) is only 1.6%. Despite the short distance separating them, the difference between the clade including Mt. Mulanje and the Mozambican clade is more than twice (4.3 %) the one observed between the latter and the Serra Jeci 2 + Lindi. Figure B.2 shows the topology of the mitochondrial tree and the average *I6S* p-distance between clades.

### 3.2. Ecological niche models

Mean temperature of coldest quarter was the main constraint to clades 1, 2 and the “lumped” model, whereas for clade 3 this variable was the second most important. Precipitation of driest quarter was the main constraint to clade 3. Table B.2 shows the AUC values and the contributions of the bioclimatic variables that contributed the most to each model. Figure 3 shows the ENMs for the “lumped” and separated lineages of *H. substriatus*. When we considered *H. substriatus* as one species (“lumped”), the coastal region (Lindi) was predicted as suitable by the ENM. This area was not predicted in Lawson’s (2013) ENM for current climate (see Fig. 4 in Lawson 2013). Even when the Lindi point was removed, the area was still predicted as suitable by our new models, suggesting that some of the other newly added populations share some ecological niche characteristics with the coastal population and are contributing to the accuracy of the ENM.

As expected, the area of habitat suitable for *H. substriatus* reduced substantially since the LGM (*ca.* 22 ka) in all models, especially for clades 1 and 2. When considering the ENMs from separate clades, the connection between the isolated coastal population and other populations most likely occurred through the past distribution of the coastal forest in northern Mozambique (Coastal Forest belt; *sensu* Burgess et al., 2000), which extended inland towards the southern highlands of Malawi. Alternatively, the “lumped” ENM suggests a historical dispersal corridor between the coastal region and the Udzungwa Mountains.

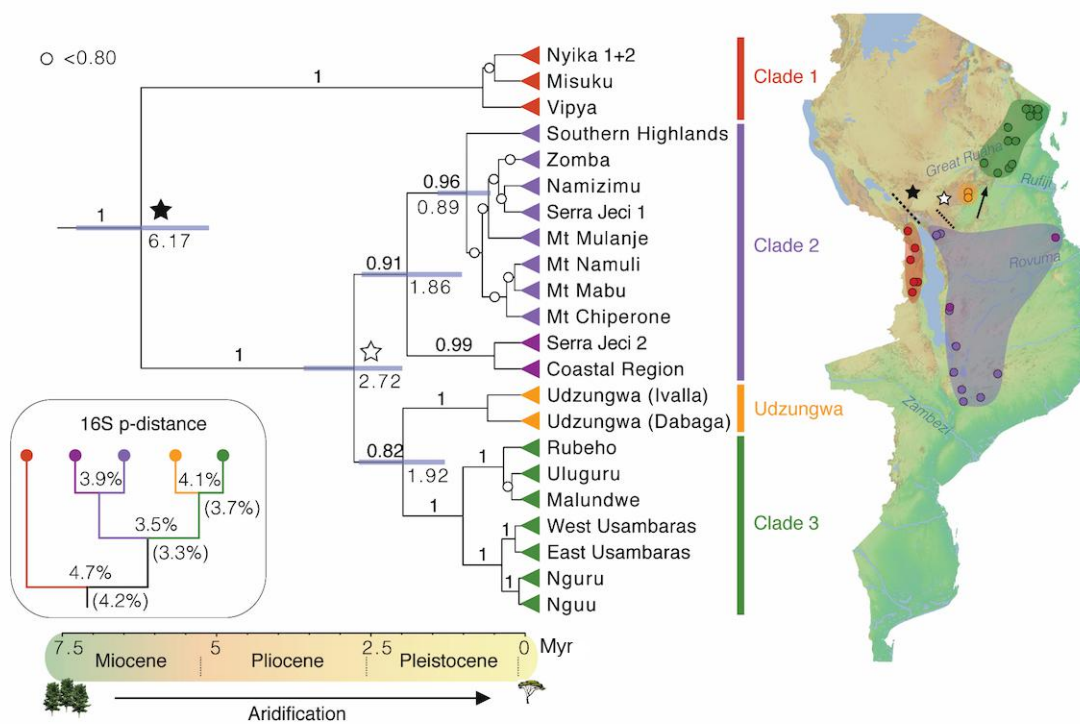

**FIGURE 3. StarBEAST (\*BEAST) gene tree of populations of *Hyperolius substriatus* with branch lengths proportional to time.** Values above the nodes are posterior probabilities, below are ages in millions years. Terminals are colour-coded according to each clade (refer to Methods section for further information on clade selection). Bottom-left box shows average and minimum (in parenthesis) inter-clade pairwise distances between 16S sequences. Map shows the distribution of each clade (colour-coded).

### 3.3. Test for niche conservatism/divergence

Background test shows sensitivity to the threshold applied (Fig. 4), especially when we compared niches of clades 1 and 3. When we used the continuous probability of habitat suitability the results were non-significant (i.e. the similarity/difference between clades is no more than expected based on the habitats where they occur). However, when the minimum presence threshold was applied the results are significant and the observed niche similarity is greater than the null distribution, indicating niche conservatism (Fig. 4 d). In the case of clades 1 and 2, and clades 2 and 3, with and without the threshold (Fig. 4), niches are more similar (niche conservatism) than expected by chance.

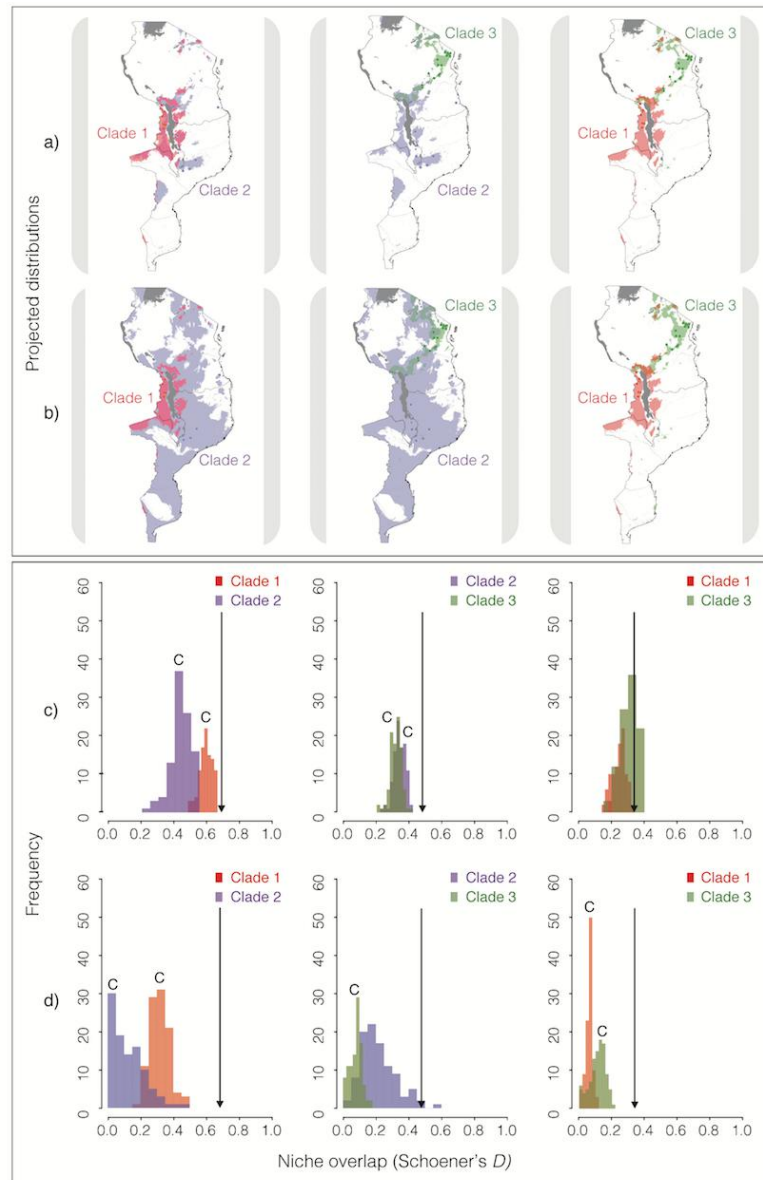

**FIGURE 4. Ecological niche models of *Hyperolius substriatus* using past and present bioclimatic data.** Ecological niche models (ENMs) show the distribution of suitable habitats when treating each clade from our phylogeny (clades 1, 2, and 3 + Udzungwa) as a different operational taxonomic unit (OTU). The “lumped” model treats all populations as the same OTU. Warmer colours (towards red) indicate areas with suitable habitat for *H. substriatus*, and cooler colours (towards blue) indicate unsuitable habitats.

## 4. Discussion

### 4.1. Ecological niche analyses

The newly discovered populations from northern Mozambique were found in areas predicted as suitable by Lawson’s (2013) ENM. Lindi, where the coastal population was found, was not predicted as suitable for *H. substriatus* in Lawson’s current climate ENM, but

in her predictions for the LGM it appears as suitable. The addition of the new populations improved the accuracy of both the “lumped” and independent the ENMs because, even excluding the population from Lindi, the ENMs are now able to predict the coastal area as suitable for *H. substriatus*. The finding of the new population from Lindi strengthens the idea that this area represents a sub-centre of endemism, which is defined by Burgess et al. (1998) as an area possessing at least 10 species of endemic plants, or three endemic vertebrates or more than three species of butterflies. This population is a relict that was probably connected to populations from northern Mozambique via the Coastal Forest belt (see LGM model in Fig. 4). A combination of climate fluctuations, human activity and sea-level changes provide a plausible explanation for the fragmentation of the coastal populations (Burgess et al., 1998).

The population from Niassa, in northern Mozambique (Fig. 1), was not included in this study because it lacks molecular data and hence could not be assigned to any lineage. When all locality points were used for the ENM (“lumped”), Niassa is not shown as a suitable area for *H. substriatus*. However, the ENMs for clade 2 predicts the Niassa area as suitable, both in past and current predictions and for that reason this population is expected to group with the other populations from clade 2, especially Lindi and Serra Jeci.

The predictions for past climate revealed another advantage of splitting the lineages before generating the ENMs. In the case of clade 2, a connection between populations from northern Mozambique and Lindi via the Coastal Forest belt seems to have existed during the LGM but disappeared after this period. This might explain why the coastal population is more closely related to the populations from Mozambique than to the more close lying Uluguru Mountains. Two other species of frogs have similar distribution through the Coastal Forest belt, occurring from the northern coast of Mozambique (Taratibu) to the west, towards Mt. Mulanje and some coastal forest fragments in eastern Zimbabwe (Bittencourt-Silva et al., 2016; Farooq et al., 2015). We therefore agree with Raxworthy et al. (2007) that accuracy of niche models are impacted by the species concept applied given that phylogeographic studies deal with cases above and below species level. Taking account of genetic variation and associated appropriate locality data will produce more reliable ecological niche models.

Wiens and Graham (2005) consider niche conservatism in sister clades as an important signal of allopatric speciation. This scenario involves a formerly widespread ancestor having had its distribution bisected (via some vicariant process), with each daughter



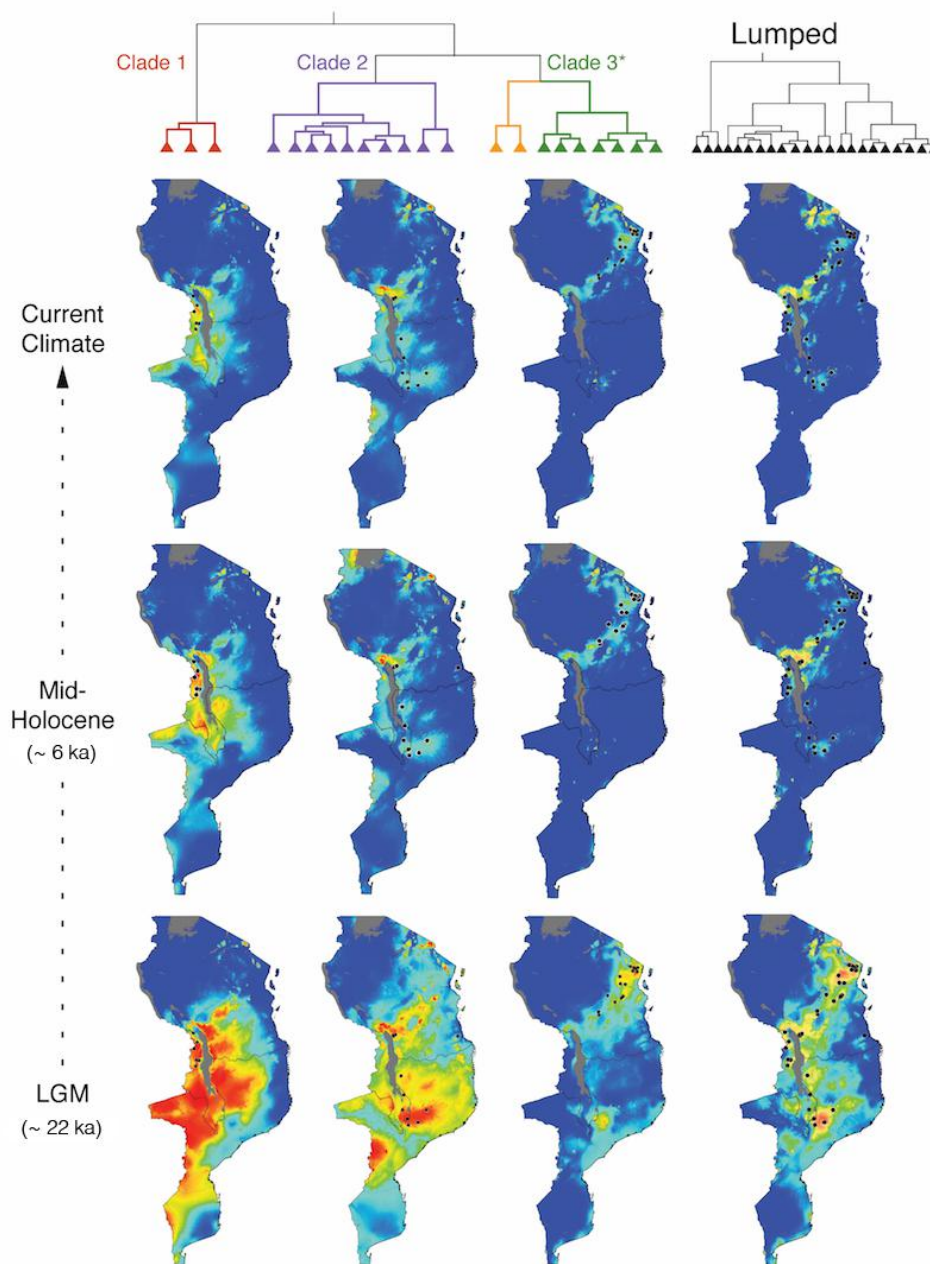

**FIGURE 5. Projected distribution of clades and test of niche conservatism and divergence.** Top box: shaded areas represent the projected distributions of clades (a) without threshold, and (b) when applying the minimum training presence threshold (MTP). Lower box: Background test used to determine whether ENMs from any two clades are more similar than expected by chance based on the geographical region in which they occur. (c) Using continuous measures of habitat suitability. (d) Applying MTP threshold. Niche conservatism (“C”) is supported when the observed niche overlap (indicated by black arrow) is higher than expected under the null hypothesis.

current clade remaining ecologically similar. The ENM predictions for the split lineages (clades 1, 2, and 3 + Udzungwa) allowed us to compare niches for each lineage and test whether they show signals of niche conservatism or divergence. As we identified potential niche conservatism in these allopatrically distributed lineages, it is likely that physical barriers have caused these divergences. Within clade 1, the intervening areas between populations are predicted as suitable for dispersal, suggesting that dispersal and gene flow may occur. However, some areas separating populations within clades 2 and 3 respectively are predicted as unsuitable (see Fig. 3), indicating a climatic barrier for gene flow exists among some populations.

There are important caveats concerning ecological niche analyses. McCormack et al. (2010) suggests that using only ENMs to study niche divergence could be misleading because local-scale ecological differences might be overlooked. It is also possible that the environmental variables used for the ENMs did not capture the niche divergences between different clades.

#### 4.2. Genetic structure and biogeography of the three major phylogenetic clades

We identified three allopatrically distributed lineages of *Hyperolius substriatus* (clade 1, clade 2 and clade 3 + Udzungwa). These lineages occupy very similar niches (niche conservatism), which supports the idea that barriers interrupted gene flow between them leading to an allopatric speciation process.

The genetic analyses show considerable structure within and among the three main clades (Fig. 2). Inter-clade differences observed for the *16S* mitochondrial gene range from 3.5–4.5%, which is considered high among conspecific populations, though not substantial between sibling species of amphibians (Vences et al., 2005; Vieites et al., 2009). For *H. substriatus*, these distinct clades could represent candidate species though additional lines of evidence (e.g. morphological, bioacoustics) will be required to confirm their taxonomic status. This complex level of population structure, also noted by Lawson (2013), is similar to other amphibian species within the fragmented Eastern Arc Mountains (e.g. Burgess et al., 2007; Lawson et al., 2015; Loader et al., 2014).

The two sympatric populations from Serra Jeci, despite being morphologically indistinguishable, have a genetic signature of isolation ( $p$ -distance = 4%). In the mitochondrial tree, Serra Jeci 1 groups with the Southern Highlands in Tanzania, and

---

populations from southern Malawi, which occurs in areas classified as montane forest-grassland mosaic (Fig. B.2; Burgess et al., 1998). In contrast, Serra Jeci 2 groups with Lindi, and with Mts. Mabu, Namuli and Chipirone. These areas are encompassed by the Coastal Forest belt (see Fig. B.2), which is composed by a different vegetation type from the EAM and the highlands of Malawi (Burgess et al., 1998). This difference in vegetation types could not be fully explored here because modelling the niches of the two clades separately would result in a reduced number of data points in each clade, consequently compromising the accuracy of the models. Targeted surveys could potentially solve this issue and should be considered for future studies with this group.

The estimations of divergence times among the three lineages correspond to two main vicariant events, the southern rift formation and the aridification process in East Africa.

*Southern rift formation* - The divergence time between clade 1 (northern Malawi) and the other clades coincide with the formation of the southern rift in northern Malawi, estimated to have started in this region *c.* 8 Ma (Foster et al. 1997). This tectonic event had considerable effect on the hydrological system of East Africa, when some rivers had their flow direction reversed by geological processes (Banister and Clarke, 1980; Stankiewicz and de Wit, 2006). Hence, the rift formation is one plausible explanation for the cessation of gene flow between clade 1 and the remaining clades, as it would have changed the boundaries of the major drainage basins and altered potential gene flow between populations. This rifting event is also recognised as responsible for promoting cladogenesis in the Tanzanian mole rats *Fucomys* (Faulkes et al., 2010).

*Aridification process* - Climate fluctuations might have also played a role in divergence between lineages as corridors of wetter/forested habitat between highland areas expanded during warm/humid climate cycles and contracted in cool/dry cycles (deMenocal, 1995). Variation in habitat connectivity potentially reinforced the effects of the rifting event, further isolating lineages. The estimated divergence time between the EAM lineage (clade 3 + Udzungwa) and clade 2, which includes the mountains of northern Mozambique, is *c.* 3 Ma. This might have been driven by the gradual aridification of East Africa during the last 4.5 Myr (Sepulchre et al., 2006; Trauth et al., 2005). This forest-dependent species would have experienced a loss of mid- and low-elevation habitat as forests transitioned to open habitats (e.g. savannah and grasslands) over this time period (Kissling et al., 2012). Similarly, Bryja

et al. (2014) estimates the separation between the EAM clade and the Mulanje + Mozambique clade of the forest-dependent mountain rodent *Praomys* to have occurred in the early Pleistocene. The bat species complex *Rhinolophus hildebrandtii* also diverged during this period (Taylor et al., 2012). Temporal congruence of divergence among these organisms might suggest a common biogeographic event driving these patterns. In contrast, some species such as the pygmy chameleons (*Rhampholeon* spp) have been isolated on the Mozambican mountains since the mid-Miocene (Branch et al., 2014). Complex biogeographic patterns might be expected given differences in vagility of organisms, and the many climatic fluctuations impacting East Africa's habitats (deMenocal, 1995; Maslin et al., 2014). Broader biogeographic studies focussed on multiple lineages will be required to better understand the biogeography of Mozambican mountains relative to other East African Afromontane areas.

#### 4.3. Impact of waterways on gene flow

The role of rivers as dispersal barriers is still controversial as studies with different groups of fauna show contrasting results (e.g. Da Silva and Patton, 1998; Gascon et al., 2000). In the present study, there are potentially contrasting patterns: first where a river seems to impose a barrier to dispersal, and second when the river seems to serve as a corridor connecting distant populations. In particular, the high genetic differentiation between the Udzungwa clade (Dabaga and Ivala) with respect to the EAM clade (clade 3) suggests limited gene flow between them (p-distance between clades = 4%; see Fig. 2). One plausible explanation is the position of the Great Ruaha River, which could be a barrier hindering gene flow between populations from these clades (Fig. 2). Stanley and Esselstyn (2010) suggest that the Great Ruaha separates two lineages of mouse shrew: *Myosorex geata* occurs in the EAM to the northeast of the river, and *M. kishaulei* in the Udzungwa and Southern Highlands to the southwest. If this river imposes a barrier between the Udzungwa to the south and the other mountains to the northeast, the *H. substriatus* population from Sanje, would be expected to form a clade with the other Udzungwa populations despite the closer proximity with Malundwe (see Fig. 1).

Conversely, populations from clade 2, which are separated by approximately 500 km (Lindi-Serra Jeci), are distributed both north and south of the Rovuma River (Fig. 2). The as-yet-genetically-unsampled population from Niassa, in northern Mozambique, may represent a connection between the coastal region (Lindi) and Serra Jeci, near Lake Malawi, which awaits

---

future testing. The riverine forest along the Rovuma River connecting Lindi to Serra Jeci might have facilitated dispersal, connecting these populations. Bryja et al. (2016) presents evidence of a connection between the East African coastal forest and the highlands in Malawi (Mt. Mulanje) possibly via riverine forest.

River width, flow speed and seasonality are some of the factors that could determine whether the river works as a barrier or a corridor for *H. substriatus*. Because these factors are affected by geological and climatic changes, reconstructing biogeographic history is a complex challenge. It is important to remember that tectonic events had considerable effects on the hydrological system of East Africa, when some rivers had their flow direction reversed or buried by geological processes (Banister and Clarke, 1980; Stankiewicz and de Wit, 2006). Our results show the differential impact of hydrological basins on phylogeographic patterns.

## **5. Conclusions**

Our study confirmed predictions of previous niche models by adding new locality data. This improved our understanding about the population structuring in this group of frogs. Modelling the niches for separated OTUs based on genetic relationships improved the accuracy of the models and provided new insights about the phylogeographical history of *Hyperolius substriatus*.

## **Acknowledgements**

We thank the Natural History Museum of Maputo provided collecting and export permits for Mozambique material. Specimens collected by DMP in 2011 followed the regulations of a research permit administered by the Universidade Eduardo Mondlane Natural History Museum of Maputo (No. 04/2011 and 05/2011) and a credential administered by the Ministry of Agriculture. Herpetological specimens were exported under CITES Permit No. MZ-0354/2011 provided by the Ministry for the Coordination of Environmental Action. CDB thanks the Humer-Stiftung zur Förderung des wissenschaftlichen Nachwuchses, Freiwillige Akademische Gesellschaft Basel, and The Centre for African Studies Basel for support and funding. Permits for research and export in Tanzania were obtained via COSTECH (research permit 2013-341-NA-2013-121). GBBS is grateful for financial support from the Eidgenössische Stipendienkommission für Ausländische Studierende (ESKAS) and Freiwillige Akademische Gesellschaft Basel. The expedition to Mozambique in 2014 was

funded by National Geographic Society (CRE9281-13) and the Competitive Program for Rated Researchers: National Research Foundation of South Africa (92776; both grants to KAT). Mike Scott (Khangela Safaris) provided field logistics support during the 2014 expedition. Hanlie Engelbrecht, Werner Conradie, Michele Menegon and Cristóvão Nanvonamuquitxo provided field assistance and Bill Branch and Harith Farooq provided support for the 2014 expedition. Laura Nunes helped interpreting some of the ecological niche analyses. Mark Wilkinson provided valuable comments on the manuscript. We also thank António Carlos Neves for making our fieldwork in Namuli possible by lending us cash when all ATM machines were out of money and all banks were closed.

---

**References**

- Aguiar, L.M. de S., da Rosa, R.O.L., Jones, G., Machado, R.B., 2015. Effect of chronological addition of records to species distribution maps: The case of *Tonatia saurophila maresi* (Chiroptera, Phyllostomidae) in South America. *Austral Ecol.* 40, 836–844. doi:10.1111/aec.12261
- Araújo, M.B., Guisan, A., 2006. Five (or so) challenges for species distribution modelling. *J. Biogeogr.* 33, 1677–1688. doi:10.1111/j.1365-2699.2006.01584.x
- Banister, K.E., Clarke, M.A., 1980. A revision of the large *Barbus* (Pisces, Cyprinidae) of Lake Malawi with a reconstruction of the history of the southern African Rift Valley lakes. *J. Nat. Hist.* 14, 483–542.
- Bayliss, J., Timberlake, J., Branch, W., Bruessow, C., Collins, S., Congdon, C., Curran, M., de Sousa, C., Dowsett, R., Dowsett-Lemaire, F., Fishpool, L., Harris, T., Herrmann, E., Georgiadis, S., Kopp, M., Liggitt, B., Monadjem, A., Patel, H., Ribeiro, D., Spottiswoode, C., Taylor, P., Willcock, S., Smith, P., 2014. The discovery, biodiversity and conservation of Mabu forest—the largest medium-altitude rainforest in southern Africa. *Oryx* 48, 177–185. doi:10.1017/S0030605313000720
- Bittencourt-Silva, G.B., Conradie, W., Siu-Ting, K., Tolley, K.A., Channing, A., Cunningham, M., Farooq, H.M., Menegon, M., Loader, S.P., 2016. The phylogenetic position and diversity of the enigmatic mongrel frog *Nothophryne* Poynton, 1963 (Amphibia, Anura). *Mol. Phylogenet. Evol.* 99, 89–102. doi:10.1016/j.ympev.2016.03.021
- Blackburn, D.C., Measey, G.J., 2009. Dispersal to or from an African biodiversity hotspot? *Mol. Ecol.* 18, 1904–1915. doi:10.1111/j.1365-294X.2009.04156.x
- Bouckaert, R., Heled, J., Kühnert, D., Vaughan, T., Wu, C.-H., Xie, D., Suchard, M.A., Rambaut, A., Drummond, A.J., 2014. BEAST 2: a software platform for Bayesian evolutionary analysis. *PLoS Comput. Biol.* 10, e1003537. doi:10.1371/journal.pcbi.1003537
- Branch, W.R., 2004. Herpetological Survey of the Niassa Game Reserve (article), Northern Mozambique, Sociedade para a Gestão e Desenvolvimento da Reserva do Niassa.
- Branch, W.R., Bayliss, J., Tolley, K.A., 2014. Pygmy chameleons of the *Rhampholeon platyceps* complex (Squamata: Chamaeleonidae): Description of four new species from isolated “sky islands” of northern Mozambique. *Zootaxa* 3814, 1–36.

- Bryja, J., Mikula, O., Patzenhauerová, H., Oguge, N.O., Šumbera, R., Verheyen, E., 2014. The role of dispersal and vicariance in the Pleistocene history of an East African mountain rodent, *Praomys delectorum*. *J. Biogeogr.* 41, 196–208. doi:10.1111/jbi.12195
- Bryja, J., Šumbera, R., Kerbis Peterhans, J.C., Aghová, T., Bryjová, A., Mikula, O., Nicolas, V., Denys, C., Verheyen, E., 2016. Evolutionary history of the thicket rats (genus *Grammomys*) mirrors the evolution of African forests since late Miocene. *J. Biogeogr.* doi:10.1111/jbi.12890
- Burgess, N.D., Butynski, T.M., Cordeiro, N.J., Doggart, N.H., Fjeldså, J., Howell, K.M., Kilahama, F.B., Loader, S.P., Lovett, J.C., Mbilinyi, B., Menegon, M., Moyer, D.C., Nashanda, E., Perkin, A., Rovero, F., Stanley, W.T., Stuart, S.N., 2007. The biological importance of the Eastern Arc Mountains of Tanzania and Kenya. *Biol. Conserv.* 134, 209–231. doi:10.1016/j.biocon.2006.08.015
- Burgess, N.D., Clarke, G.P., others, 2000. Coastal forests of eastern Africa. IUCN.
- Burgess, N.D., Clarke, G.P., Rodgers, W.A., 1998. Coastal forests of eastern Africa: status, endemism patterns and their potential causes. *Biol. J. Linn. Soc.* 64, 337–367. doi:10.1111/j.1095-8312.1998.tb00337.x
- Chan, L.M., Brown, J.L., Yoder, A.D., 2011. Integrating statistical genetic and geospatial methods brings new power to phylogeography. *Mol. Phylogenet. Evol.* 59, 523–537. doi:10.1016/j.ympev.2011.01.020
- Crawford, A.J., 2003. Relative rates of nucleotide substitution in frogs. *J. Mol. Evol.* 57, 636–641. doi:10.1007/s00239-003-2513-7
- Da Silva, M.N.F., Patton, J.L., 1998. Molecular phylogeography and the evolution and conservation of Amazonian mammals. *Mol. Ecol.* 7, 475–486. doi:10.1046/j.1365-294x.1998.00276.x
- deMenocal, P.B., 1995. Plio-Pleistocene African climate. *Science* 270, 53–59. doi:10.1126/science.270.5233.53
- Farooq, H., Liedtke, H.C., Bittencourt-Silva, G., Conradie, W., Loader, S.P., 2015. The distribution of *Mertensophryne anotis* with a new record in Northern Mozambique. *Herpetol. Notes* 8, 305–307.
- Faulkes, C.G., Mgode, G.F., Le Comber, S.C., Bennett, N.C., 2010. Cladogenesis and endemism in Tanzanian mole-rats, genus *Fukomys*: (Rodentia Bathyergidae): a role for tectonics? *Biol. J. Linn. Soc.* 100, 337–352. doi:10.1111/j.1095-8312.2010.01418.x



- 
- Gascon, C., Malcolm, J.R., Patton, J.L., da Silva, M.N.F., Bogart, J.P., Lougheed, S.C., Peres, C.A., Neckel, S., Boag, P.T., 2000. Riverine barriers and the geographic distribution of Amazonian species. *Proc. Natl. Acad. Sci.* 97, 13672–13677. doi:10.1073/pnas.230136397
- Gereau, R.E., Cumberlidge, N., Hemp, C., Hochkirch, A., Jones, T., Kariuki, M., Lange, C.N., Loader, S.P., Malonza, P.K., Menegon, M., Ndong'ang'a, P.K., Rovero, F., Shirk, P., 2016. Globally Threatened Biodiversity of the Eastern Arc Mountains and Coastal Forests of Kenya and Tanzania. *J. East African Nat. Hist.* 105, 115–201. doi:10.2982/028.105.0104
- Hijmans, R.J., Cameron, S.E., Parra, J.L., Jones, P.G., Jarvis, A., 2005. Very high resolution interpolated climate surfaces for global land areas. *Int. J. Climatol.* 25, 1965–1978.
- IUCN SSC Amphibian Specialist Group, 2013. *Hyperolius substriatus*. The IUCN Red List of Threatened Species [WWW Document]. URL <http://dx.doi.org/10.2305/IUCN.UK.2013-2.RLTS.T136152A18367261.en> (accessed 10.10.16).
- Katoh, K., Standley, D.M., 2013. MAFFT multiple sequence alignment software version 7: improvements in performance and usability. *Mol. Biol. Evol.* 30, 772–80. doi:10.1093/molbev/mst010
- Kearse, M., Moir, R., Wilson, A., Stones-Havas, S., Cheung, M., Sturrock, S., Buxton, S., Cooper, A., Markowitz, S., Duran, C., Thierer, T., Ashton, B., Meintjes, P., Drummond, A., 2012. Geneious Basic: an integrated and extendable desktop software platform for the organization and analysis of sequence data. *Bioinformatics* 28, 1647–9. doi:10.1093/bioinformatics/bts199
- Kissling, W.D., Eiserhardt, W.L., Baker, W.J., Borchsenius, F., Couvreur, T.L.P., Balslev, H., Svenning, J.-C., 2012. Cenozoic imprints on the phylogenetic structure of palm species assemblages worldwide. *Proc. Natl. Acad. Sci.* 109, 7379–7384. doi:10.1073/pnas.1120467109
- Kumar, S., Stecher, G., Tamura, K., 2016. MEGA7: Molecular Evolutionary Genetics Analysis Version 7.0 for Bigger Datasets. *Mol. Biol. Evol.* doi:10.1093/molbev/msw054
- Lanfear, R., Calcott, B., Ho, S.Y.W., Guindon, S., 2012. Partitionfinder: combined selection of partitioning schemes and substitution models for phylogenetic analyses. *Mol. Biol. Evol.* 29, 1695–701. doi:10.1093/molbev/mss020
- Lawson, L.P., 2013. Diversification in a biodiversity hot spot: landscape correlates of

- phylogeographic patterns in the African spotted reed frog. *Mol. Ecol.* 22, 1947–1960. doi:10.1111/mec.12229
- Lawson, L.P., 2010. The discordance of diversification: evolution in the tropical-montane frogs of the Eastern Arc Mountains of Tanzania. *Mol. Ecol.* 19, 4046–4060. doi:10.1111/j.1365-294X.2010.04788.x
- Lawson, L.P., Bates, J.M., Menegon, M., Loader, S.P., 2015. Divergence at the edges: peripatric isolation in the montane spiny throated reed frog complex. *BMC Evol. Biol.* 15, 1–15. doi:10.1186/s12862-015-0384-3
- Lemmon, E.M., Lemmon, A.R., Cannatella, D.C., 2007. Geological and climatic forces driving speciation in the continentally distributed trilling chorus frogs (*Pseudacris*). *Evolution* (N. Y). 61, 2086–2103. doi:10.1111/j.1558-5646.2007.00181.x
- Loader, S.P., Ceccarelli, S.F., Menegon, M., Howell, K.M., Kassahun, R., Mengistu, A.A., Saber, S.A., Gebresenbet, F., de Sá, R., Davenport, T.R.B., Larson, J.G., Müller, H., Wilkinson, M., Gower, D.J., 2014. Persistence and stability of Eastern Afromontane forests: evidence from brevipitid frogs. *J. Biogeogr.* 41, 1781–1792. doi:10.1111/jbi.12331
- Maslin, M.A., Brierley, C.M., Milner, A.M., Shultz, S., Trauth, M.H., Wilson, K.E., 2014. East African climate pulses and early human evolution. *Quat. Sci. Rev.* 101, 1–17. doi:10.1016/j.quascirev.2014.06.012
- McCormack, J.E., Zellmer, A.J., Knowles, L.L., 2010. Does niche divergence accompany allopatric divergence in *Aphelocoma* jays as predicted under ecological speciation?: Insights from tests with niche models. *Evolution* (N. Y). 64, 1231–1244. doi:10.1111/j.1558-5646.2009.00900.x
- Measey, G.J., Galbusera, P., Breyne, P., Matthysen, E., 2007. Gene flow in a direct-developing, leaf litter frog between isolated mountains in the Taita Hills, Kenya. *Conserv. Genet.* 8, 1177–1188. doi:10.1007/s10592-006-9272-0
- Measey, G.J., Tolley, K.A., 2011. Sequential fragmentation of pleistocene forests in an East Africa biodiversity hotspot: chameleons as a model to track forest history. *PLoS One* 6, 1–9. doi:10.1371/journal.pone.0026606
- Menegon, M., Salvidio, S., 2005. Amphibian and reptile diversity in the southern Udzungwa scarp forest reserve, south-eastern Tanzania, in: *African biodiversity*. Springer US, Boston, MA, pp. 205–212. doi:10.1007/0-387-24320-8\_18

- 
- Pearson, R.G., Raxworthy, C.J., Nakamura, M., Townsend Peterson, A., 2007. Predicting species distributions from small numbers of occurrence records: a test case using cryptic geckos in Madagascar. *J. Biogeogr.* 34, 102–117. doi:10.1111/j.1365-2699.2006.01594.x
- Peterson, A.T., Soberón, J., 2012. Species distribution modeling and ecological niche modeling: getting the concepts right. *Nat. Conserv.* 10, 102–107.
- Phillips, S.J., Anderson, R.P., Schapire, R.E., 2006. Maximum entropy modeling of species geographic distributions. *Ecol. Modell.* 190, 231–259. doi:10.1016/j.ecolmodel.2005.03.026
- Portik, D.M., Mulungu, E., Sequeira, D., McEntee, J.P., 2013. Herpetological surveys of the Serra Jeci and Namuli massifs, Mozambique, and an annotated checklist of the southern Afromontane archipelago. *Herpetol. Rev.* 44, 394–406.
- Rambaut, A., Suchard, M., Xie, D., Drummond, A., 2014. Tracer v1. 6 <http://beast.bio.ed.ac.uk>.
- Raxworthy, C.J., Ingram, C.M., Rabibisoa, N., Pearson, R.G., 2007. Applications of ecological niche modeling for species delimitation: a review and empirical evaluation using day geckos (*Phelsuma*) from Madagascar. *Syst. Biol.* 56, 907–23. doi:10.1080/10635150701775111
- Rovero, F., Marshall, A.R., Jones, T., Perkin, A., 2009. The primates of the Udzungwa Mountains: diversity, ecology and conservation. *J. Anthropol. Sci. = Riv. di Antropol. JASS* 87, 93–126.
- Sepulchre, P., Ramstein, G., Fluteau, F., Schuster, M., Tiercelin, J.-J., Brunet, M., 2006. Tectonic Uplift and Eastern Africa Aridification. *Science* (80). 313, 1419–1423.
- Stamatakis, A., 2014. RAxML version 8: a tool for phylogenetic analysis and post-analysis of large phylogenies. *Bioinformatics* 30, 1312–3. doi:10.1093/bioinformatics/btu033
- Stankiewicz, J., de Wit, M.J., 2006. A proposed drainage evolution model for Central Africa—Did the Congo flow east? *J. African Earth Sci.* 44, 75–84. doi:10.1016/j.jafrearsci.2005.11.008
- Stanley, W.T., Esselstyn, J.A., 2010. Biogeography and diversity among montane populations of mouse shrew (Soricidae: *Myosorex*) in Tanzania. *Biol. J. Linn. Soc.* 100, 669–680. doi:10.1111/j.1095-8312.2010.01448.x
- Taylor, P.J., Stoffberg, S., Monadjem, A., Schoeman, M.C., Bayliss, J., Cotterill, F.P.D., 2012. Four new bat species (*Rhinolophus hildebrandtii* complex) Reflect Plio-

- Pleistocene divergence of dwarfs and giants across an Afromontane archipelago. *PLoS One* 7, 1–23. doi:10.1371/journal.pone.0041744
- Trauth, M.H., Maslin, M.A., Deino, A., Strecker, M.R., 2005. Late Cenozoic moisture history of East Africa. *Science* (80). 309, 2051 LP-2053.
- Vences, M., Thomas, M., van der Meijden, A., Chiari, Y., Vieites, D.R., 2005. Comparative performance of the 16S rRNA gene in DNA barcoding of amphibians. *Front. Zool.* 2, 1–12. doi:10.1186/1742-9994-2-5
- Vieites, D.R., Wollenberg, K.C., Andreone, F., Köhler, J., Glaw, F., Vences, M., 2009. Vast underestimation of Madagascar's biodiversity evidenced by an integrative amphibian inventory. *Proc. Natl. Acad. Sci.* 106, 8267–8272. doi:10.1073/pnas.0810821106
- Warren, D.L., Glor, R.E., Turelli, M., 2010. ENMTools: a toolbox for comparative studies of environmental niche models. *Ecography (Cop.)*. 33, 607–611. doi:10.1111/j.1600-0587.2009.06142.x
- Warren, D.L., Glor, R.E., Turelli, M., 2008. Environmental niche equivalency versus conservatism: quantitative approaches to niche evolution. *Evolution* 62, 2868–83. doi:10.1111/j.1558-5646.2008.00482.x
- Wiens, J.J., Graham, C.H., 2005. Niche conservatism: Integrating evolution, ecology, and conservation biology. *Annu. Rev. Ecol. Evol. Syst.* 36, 519–539.

# CHAPTER III

Phylogeny and historical biogeography of the shovel-footed  
squeaker *Arthroleptis stenodactylus* Pfeffer, 1893

Gabriela B. Bittencourt-Silva, David C. Blackburn & Simon P. Loader

**Status:** Drafted Manuscript

**Phylogeny and historical biogeography of the shovel-footed squeaker *Arthroleptis stenodactylus* Pfeffer, 1893**

Gabriela B. Bittencourt-Silva<sup>1</sup>, David C. Blackburn<sup>2</sup> and Simon P. Loader<sup>1,3</sup>,

1- University of Basel, Basel 4056, Switzerland

2- Florida Museum of Natural History, University of Florida, Gainesville, Florida 32611, USA

3- Natural History Museum, Cromwell Road, London SW5 5BD, UK

**Abstract**

*Arthroleptis stenodactylus* is a widespread species of African frog and as in several widespread taxa, it is likely to be comprised of cryptic species. Evidence from literature suggests at least two ecologically and morphologically distinct forms of *A. stenodactylus*, one from the forest/mountain and one from the savannah/lowland. We investigated this case with an integrative approach combining molecular (mitochondrial and nuclear DNA), ecological and morphological data. Our results shows geographically, ecologically and morphologically structured clades of *A. stenodactylus* corroborating the literature suggestions. We propose a tectonic and climate-driven vicariant scenario to explain the historical biogeography of *A. stenodactylus* based on the Vanishing refuge model.

**Keywords:** Cryptic diversity, East Africa, Vicariance, Anura, Biogeography

## 1. Introduction

The shovel-footed squeaker frog, *Arthroleptis stenodactylus* Pfeffer, 1893, is widespread across East, Central and Southern Africa, and found in many different types of habitats. *Arthroleptis stenodactylus* is a relatively large frog for its genus and, like its congeners species, it breeds through direct development (Blackburn, 2008). For amphibians, independence from water bodies for reproduction is usually associated with life in humid environments, i.e. forests (Müller et al., 2013). Typically *A. stenodactylus* is known from humid environments including low and highland forests in East Africa (e.g. Blackburn, 2008; Pickersgill, 2007; Poynton and Broadley, 1985). However, according to Schmidt and Inger (1959; and references within) based on work in the Democratic Republic of Congo, *A. stenodactylus* occurs in dry forest and open areas but never in rainforest. Furthermore, some records from East Africa include *miombo* (i.e. *Brachystegia* spp.) and woodland habitats (e.g. Blackburn, 2008; Pickersgill, 2007; Poynton and Broadley, 1985). *Arthroleptis stenodactylus* therefore has a broad niche, occurring from forest to savannah.

As with many other widespread species (Angulo and Icochea, 2010), *A. stenodactylus* is expected to be comprised of cryptic species (Loader et al., 2011; Pickersgill, 2007) which might explain some of the varied but specialized habitat types of particular populations. There are six names listed as junior synonyms of *A. stenodactylus* (Frost, 2016), four of them from montane forests in the Eastern Arc Mountains of Tanzania (*A. lonnbergi* Nieden, 1915; *A. s. uluguruensis* Loveridge, 1932; *A. vagus* Ahl, 1939 “1938”; and *A. ukamiensis* Ahl, 1939 “1938”), one from the highlands of Malawi (*A. whytii* Boulenger, 1897) and one from coastal Tanzania (*A. methneri* Ahl, 1924). The plethora of synonyms may be related to some overlooked ecological segregation within *A. stenodactylus*. Loveridge (1953, pp. 389-390) mentioned that there are “mountain and lowland races” unquestionably distinct, differing greatly in size, and suggested that all synonyms (except the coastal *A. methneri*) should be referred to the synonymy of *A. whytii* – the “mountain race”. Loveridge (1953) was therefore implying that *A. methneri* is the only synonym of *A. stenodactylus* and together they form the “lowland race”. It is relevant to note that the type locality of *A. stenodactylus* is “Kihengo”, on the foothills of the Nguru Mountains in Tanzania (Pfeffer, 1893). Similarly, Pickersgill (2007) suggested that *A. stenodactylus*, as currently known, represents a species complex and at least two forms are identified in East Africa, a forest and a savannah form. He assigned the forest form to *A. lonnbergi* Nieden, 1915 providing evidence of “strikingly different” call



---

from lowland *A. stenodactylus* (Pickersgill 2007). However, Pickersgill's (2007) resurrection of *A. lonnbergi* was done without reference to the type and ignores the first available name (i.e. *A. whytii*). Thus, in summary, literature suggests the existence of two ecologically and morphologically distinct forms of *A. stenodactylus*, one occurring in mountain/forest and the other in lowland/savannah.

Different mechanisms can give rise to ecologically diverse sister taxa, both in sympatry or allopatry (Graham et al., 2004; Rundle and Nosil, 2005). Ecological speciation occurs when barriers to gene flow evolve between populations as a result of ecologically-based divergent (or disruptive) selection (Rundle and Nosil, 2005). The “vanishing refuge model” (VRM) proposed by Vanzolini and Williams (1981) explains the distribution of sister species in adjacent yet contrasting biomes (see Fig. 1). “Some populations of forest-restricted species may be pre-adapted to life in open formations. If, during the dry part of a climatic cycle, they happen to be confined to a refuge that eventually vanishes, they may, in the process, become completely adapted to open formation conditions and constitute a full ecological vicariant” (Vanzolini and Williams, 1981). The VRM builds on the climate-driven vicariance-based Pleistocene refuge hypothesis proposed by Haffer (1969) but differs in that the former focuses on divergence across distinct habitat types rather than isolated patches of similar habitats (e.g. forest refugia). Secondary contact zones occur when climatic conditions favour forest expansion and base on variation of differentiation rates, Haffer's (1969) refuge model, predicts the following situations: (1) Speciation process is completed before contact and species (no longer populations) are reproductively isolated and ecologically compatible (“Geographic overlap”); (2) Speciation process not fully completed before contact and species (no longer populations) are reproductively isolated but ecologically incompatible (“Geographic exclusion”); (3) Speciation process not fully completed before contact and populations (not species) can generate viable offspring (“Hybridization”). Figure 1 (steps 5 and 6) illustrates some of the situations mentioned above.

Footprints left by VRM are similar to the ones produced by peripatric speciation in terms of geographic patterns of distribution, gene flow, phylogenetic relationships and genetic isolation (e.g. Lawson et al., 2015) and could easily lead to misinterpretation of the mode of speciation. However, while peripatric speciation usually results in severely reduced populations, under the VRM ecotone-adapted forms can potentially have widespread distributions. Species pre-adapted to broad environmental conditions (e.g. anthropogenic

areas) are more compliant to VRM diversification (Vanzolini and Williams, 1981). The occurrence of *A. stenodactylus* in anthropogenic environments indicates that this species is ecotone-adapted and hence a good candidate to succeed in vanishing refuges.

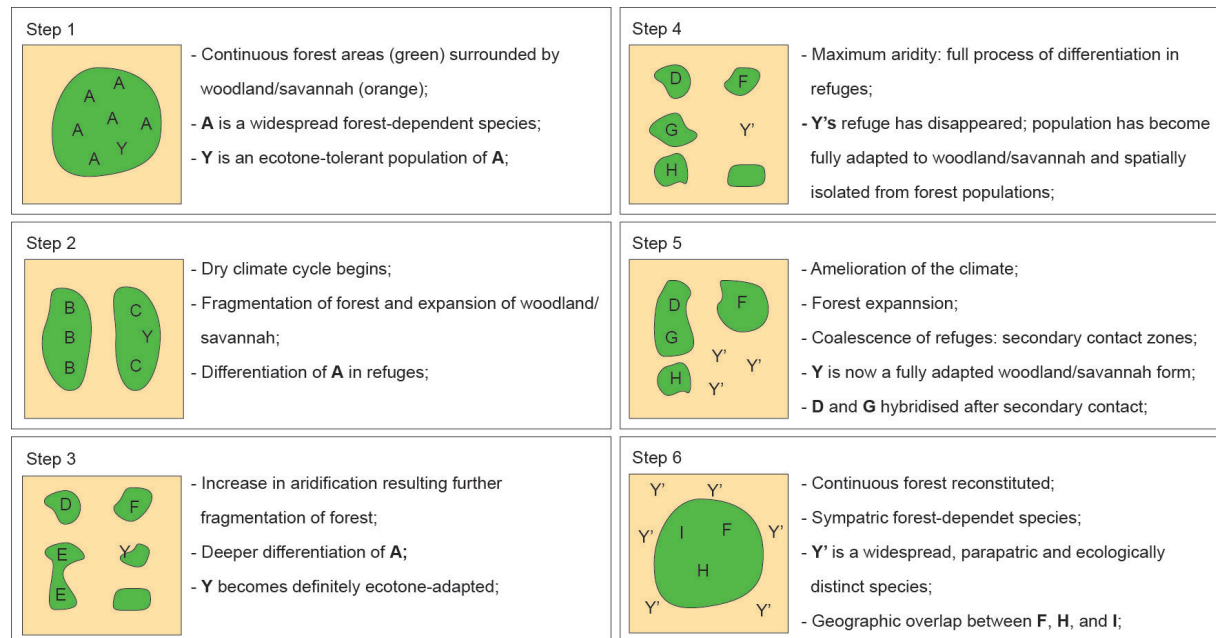

**FIGURE 6. Schematic representation of the vanishing refuge model (VRM).** Adapted from Vanzolini and Williams (1981).

Africa is relatively poorly understood from a biogeographic perspective (Richardson and Pennington, 2016), though recent studies are providing new insights into the origins of African biodiversity (Couvreur et al., 2008; Linder, 2014; Masters et al., 2017; Tolley et al., 2011; Zimkus et al., 2016). What seems clear is that Africa has been subjected to major climatic changes, which has led to recurrent expansion and contraction of habitats (Axelrod and Raven, 1978; Maslin et al., 2014; Sepulchre et al., 2006; Trauth et al., 2005). These environmental changes resulted in frequent isolation and reconnection of populations (e.g. Blackburn and Measey, 2009; Bryja et al., 2014b; Couvreur et al., 2008). Hence, allopatric speciation has often been used to explain diversification patterns of African fauna (Bryja et al., 2014a, 2014b; Faulkes et al., 2010; Taylor et al., 2012; Tolley et al., 2011), though see Lawson et al. (2015) for an example of peripatric speciation.

In this study we applied different approaches to investigate ecological and morphological divergence within *A. stenodactylus*. Molecular data were used to produce a robust phylogeny including populations of *A. stenodactylus* sampling most of its range.

Ecological niche models (ENMs) were generated to provide insights into the diversification/speciation modes and shed light in the biogeographic history of the group. Lastly, morphological data were used to examine whether differences, if detectable, corresponded to genetics and ecology.

## **2. Material and methods**

### *2.1. Samples and sequencing*

Our sampling includes 218 samples of *Arthroleptis stenodactylus* from seven African countries collected during different surveys (Fig. 2). Samples were collected from both forest (montane, coastal and lowland) and non-forest (woodland and *miombo*) environments. We present data for populations from outside of the currently known distribution range of the species (IUCN, 2016).

Locality data, voucher numbers and GenBank accession numbers are presented in Table S1 (Appendix A) in the Supporting Information. Total genomic DNA was extracted using Qiagen DNeasy kit following the protocol for purification of total DNA from animal tissues. Four markers were amplified and sequenced comprising segments of three partial mitochondrial genes 12SrRNA (*12S*), 16SrRNA (*16S*) and cytochrome c oxidase I (*COXI*), and one nuclear gene recombination-activating gene 1 (*RAG1*). PCR was performed using Illustra PuReTaq Ready-To-Go PCR Beads (details in Tables S2 and S3 – Appendix A). DNA sequences of both strands were sequenced by Microsynth AG (Balgrist, Switzerland). Summary statistics of selected molecular markers are shown in Table 1.

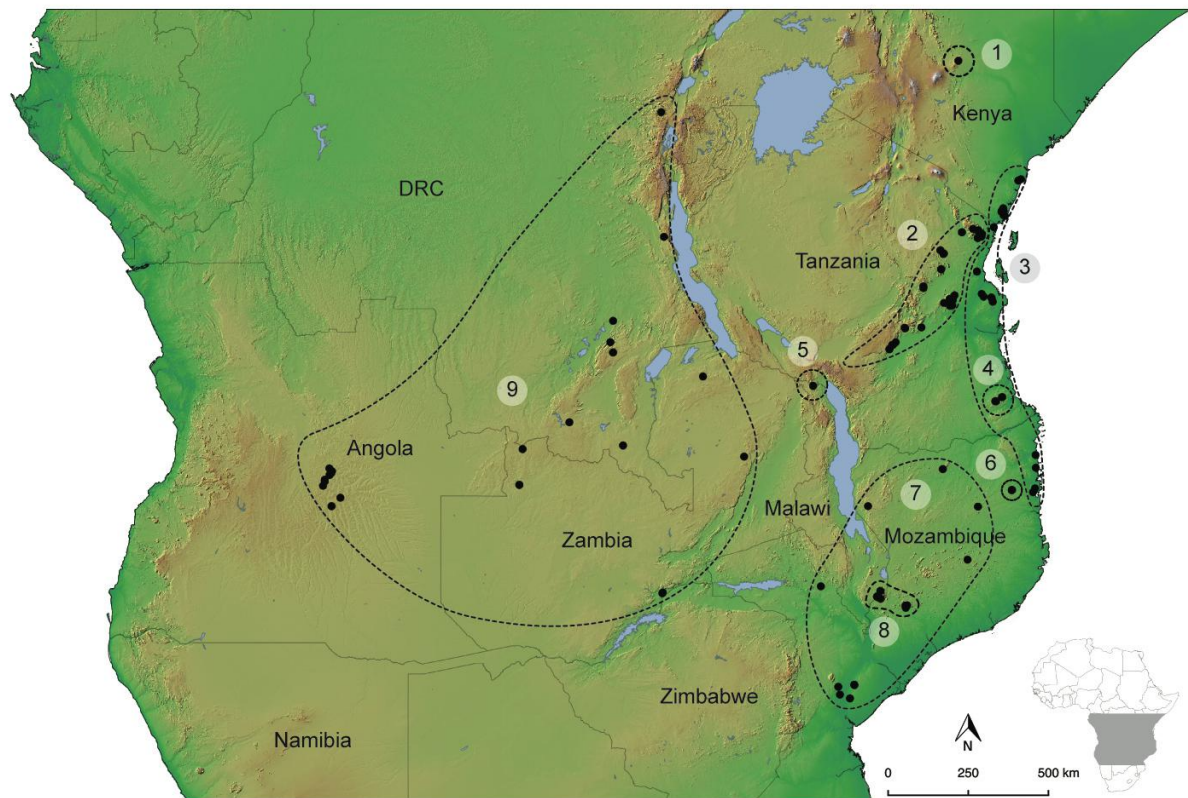

**FIGURE 7.** Study area including sampling localities of *Arthroleptis stenodactylus*. Dotted lines demarcate regions or localities mentioned in the text. (1) Nyambene Hills; (2) Eastern Arc Mountains; (3) Coastal region; (4) Lindi (5) Misuku Hills; (6) Taratibu; (7) Northern Mozambique; (8) Mts. Mulanje and Mabu; (9) Central Africa.

**TABLE 3.** Statistics of the genetic markers used for the molecular analyses.

Loci	Taxa	Characters	Constant characters	Variable Parsimony uninformative	Parsimony informative
12S	119	355	267	32	56
16S	215	513	396	41	76
CO1	62	858	560	36	262
RAG1	37	810	751	36	23

## 2.2. Data matrix and alignment

Sequences were aligned in Geneious v.7.1 (Kearse et al., 2012) using MAFFT v.7 (Kato and Standley, 2013) applying the algorithm E-INS-i, and checked by eye for obvious mistakes. Posteriorly, poorly aligned regions from non-coding markers (12S and 16S) were removed in

---

GBlocks (Castresana, 2000), and for coding markers (*COX1* and *RAG1*) in TranslatorX (Abascal et al., 2010). *Arthroleptis poecilonotus* Peters, 1863 and *A. variabilis* Matschie, 1893 were used as outgroups, following Blackburn (2008). The total number of sequences included in the matrix per marker is 119 (*12S*: 355 bp), 215 (*16S*: 513 bp), 62 (*COX1*: 858 bp), and 37 (*RAG1*: 810 bp). The final dataset contains 216 individuals (2536 bp) of *A. stenodactylus*, plus outgroup (*A. poecilonotus* and *A. variabilis*). In order to test the monophyly of *A. stenodactylus*, a second set of alignments were prepared including seven additional species of large *Arthroleptis* (see Blackburn 2008), and *Cardioglossa gracilis* Boulenger, 1900 as outgroup. List of specimens included in the alignments is provided in Table S1 (Appendix A).

### 2.3. Phylogenetic analyses

The monophyly of *A. stenodactylus* was tested using maximum likelihood (ML) for two sets of concatenated alignments (mitochondrial and multilocus). Trees and split frequencies were analysed using PAUP (Swofford, 2001) and SplitLogic (Hill and Wilkinson, available at <http://splitlogic.org/>). Phylogenetic relationships within the group were inferred using maximum likelihood and Bayesian inference (BI) approaches. Mitochondrial and multilocus concatenated alignments including only *A. poecilonotus* and *A. variabilis* were used for these analyses. PartitionFinder v.1.1.1 (Lanfear et al., 2012) was used to select the best-fit models of nucleotide substitution and partition schemes applying the Bayesian information criterion (BIC; Table S4 in Appendix A). All ML analyses were performed in RAxML v.8 (Stamatakis, 2014) using the GTR+GAMMA model, and support values were estimated using non-parametric bootstrapping (auto-MRE). BI analyses were performed in MrBayes v.3.2 (Ronquist and Huelsenbeck, 2003). Two runs of 50 million generations each were executed using four chains (one cold and three heated) and sampled every 1000 generations with the initial 10% discarded as burn-in. Examination of the effective sample sizes (ESS) for convergence of parameters was done using Tracer (Rambaut et al., 2014) using a threshold of >200. Uncorrected pairwise distances for *16S* sequences were calculated from multiple sequence alignment in PAUP.

### 2.4. Ecological niche models (ENMs)

Models were generated to investigate possible differences in niches occupied by the main clades recovered in our phylogenetic analyses. Selection of the study region for each model followed Anderson and Raza's approach (2010), which consists in calibrating the model in a smaller area and then projecting it into a larger area. ENMs were generated in Maxent v.3.3 (Phillips et al., 2006) using the default settings and evaluated using the cross-validation method. Four bioclimatic variables derived from temperature and precipitation were downloaded from the WorldClim database (Hijmans et al., 2005): Temperature Seasonality, Mean Temperature of Warmest Quarter, Precipitation of Wettest Month and Precipitation of Driest Month. The digital elevation model was downloaded from HydroSHEDS (Lehner et al., 2006). All environmental variables have 30-arc second resolution.

### *2.5. Morphological analyses*

Morphological differentiation of forest and woodland specimens (based on results from the phylogenetic analyses) was investigated using a linear discriminant analysis (LDA). Nine body measurements from 54 specimens (Table S5, Appendix A) were log-transformed to account for differences in sex and stage (i.e. adult or juvenile). A cross-validation test was conducted to check for over fitting of the LDAs. All analyses were executed in R (R Core Team, 2014) using the MASS package (Venables and Ripley, 2002).

## **3. Results**

### *3.1. Phylogenetic analyses*

Multilocus and mitochondrial ML analyses including other large species of *Arthroleptis* and *Cardioglossa* (outgroup) corroborate, albeit weakly, the monophyly of *A. stenodactylus* with bootstrap support values of 76% and 71%, respectively (Fig. 3). Analysis of split frequencies of the multilocus ML trees reveals that the next best hypothesis is supported by only 10% of the trees, less than half of the 24% of the trees in which *A. stenodactylus* is not monophyletic. This indicates that there is no strong signal contradicting the hypothesis of monophyly of *A. stenodactylus*. *Arthroleptis poecilonotus*, *A. adelphus* and *A. variabilis* were recovered as sister group of *A. stenodactylus* with 65% bootstrap support in both analyses.

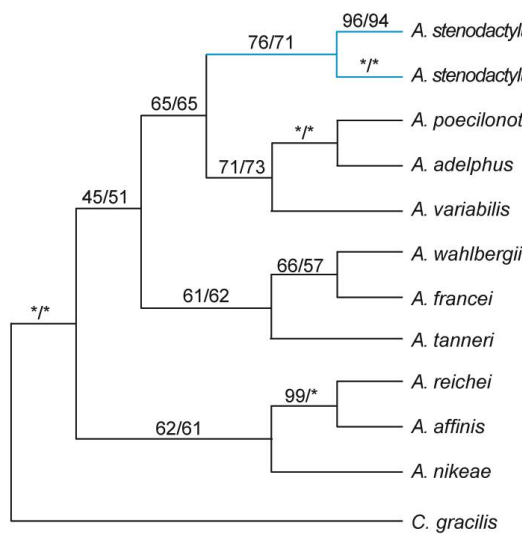

**FIGURE 8. Monophyly test of *Arthroleptis stenodactylus*.** Numbers above branches are bootstrap support values from multilocus and mitochondrial ML analyses, respectively. Star indicates maximum support.

ML and Bayesian inference (BI) analyses using only *A. stenodactylus* and the sister group (*A. poecilonotus* and *A. variabilis*) recovered four ecologically and geographically structured clades. One clade, referred to here as the “Forest clade” (see Fig. 4), occurs mainly in montane but also coastal forests and is restricted to East Africa (including southern Malawi and northern Mozambique). The other main group is comprised of three clades, Lindi (coastal Tanzania), Nyambene Hills (Northern Kenya) and a widespread clade referred to as “Woodland clade”. While the first two clades occur in forest, the latter inhabits woodland, *miombo* and dry forests of Eastern and central Africa (Fig. 4).

The Forest clade (see Fig. 4) is restricted to East Africa and occurs mainly in montane or coastal forest above 400 m above sea level (asl), though the Arabuko-Sokoke assemblage in coastal Kenya occurs below 100 m asl. Two other clades occur in forest, the Lindi plateau (coastal forest, Tanzania) and Nyambene Hills (montane forest, northern Kenya). The Woodland clade is distributed across East and Central Africa, and occurs in woodland and *miombo* habitats. ML and BI phylogenies showing all included samples are presented in the Appendix B of Supplementary materials. Figure 5 shows the average and minimum uncorrected pairwise distances between *16S* sequences. Despite the large geographical distance within assemblages from the Woodland clade, the average pairwise distance is 2.4%, whereas in the Forest clade the distance is 4.5%. The assemblage from Lindi, coastal Tanzania, is non-monophyletic.

Figure 4C shows the three non-monophyletic assemblages from Lindi. Specimens from the Woodland clade (Lindi 3; see Fig. 4 C) were found in the lowland below 300 m asl, while specimens from the plateau (> 800 m asl) group either with the group within the Forest clade



(Lindi 1) or in the main clade including Northern Kenya (Nyambene Hills) and the Woodland clade (Lindi 2) Other non-monophyletic assemblages were identified occurring in sympatry at Mt. Mulanje, Mt. Mabu, Kazizumbwe, Shimba Hills (coastal Kenya) and Taratibu.

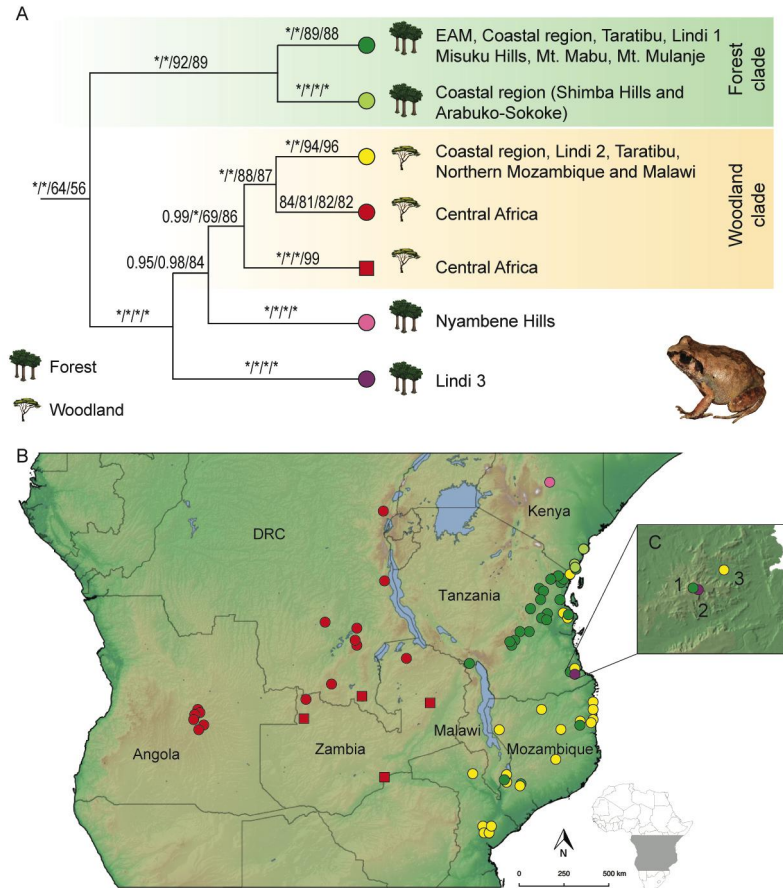

**FIGURE 9. Phylogenetic relationships and distribution map of *Arthroleptis stenodactylus*.** (A) Consensus topology of Bayesian and maximum likelihood trees. Branch values refer to posterior probabilities (multilocus/mitochondrial) and bootstrap support (multilocus/mitochondrial). Main habitat types indicated with tree icons. (B) Map showing distribution of each clade (colour-coding matching tree). (C) Sympatric assemblages on Lindi plateau (1, 2) and lowland (3).

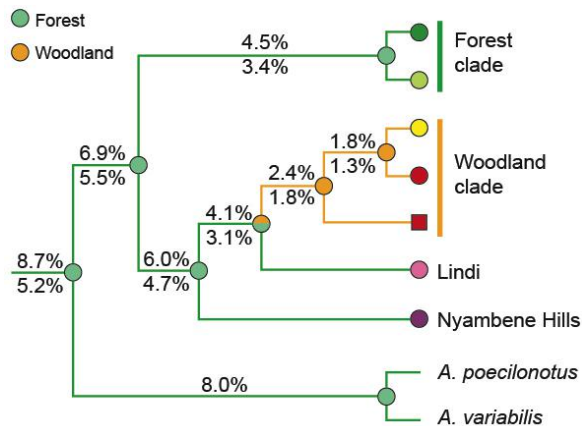

**FIGURE 10. Uncorrected pairwise distance between multiple 16S sequences of *Arthroleptis stenodactylus*.** Values above and below branches represent average and minimum distances, respectively. Circles on nodes indicate ancestral habitat based on maximum parsimony reconstruction.



### 3.2. Ecological niche models (ENMs)

Table 2 summarises the contribution of each variable and Area Under the Curve (AUC) values for each model. As expected for a frog, precipitation was the limiting factor in all models, accounting for 65% (Forest) and 64% (Woodland) of total variable contribution. The AUC for the Forest clade model is 0.93 but for the Woodland clade (WCE) is 0.74 (values below 0.85 are considered low). However, this low AUC value is not unexpected given the wide distribution of the Woodland clade (see Lobo et al. 2008). This also explains the low AUC for the Woodland Central-African sub-clade (WC; AUC = 0.65). Populations from the Nyambene Hills and Lindi clades were excluded from this analysis because of they represent single localities, though the specimens belonging to the Lindi assemblage nested within the Forest and Woodland clades were included in the respective models.

Figure 6 shows probability maps of predicted habitat suitability for each clade as well as presence-absence maps created applying the minimum presence threshold. While Forest clade populations from Mts. Mulanje and Mabu are apparently isolated from the other populations further north by large areas of unsuitable habitat, all populations from the Woodland clade are somehow connected. This isolation of Mts. Mulanje and Mabu populations may be reflected in the BI phylogeny (see Figs. S1-S2, Appendix B).

**TABLE 4. Ecological niche model results.** Percentage of variable contribution and AUC values for each model. Woodland clade; Woodland East African sub-clade (WE); Woodland Central African sub-clade.

AUC/ Variable	Description	Forest	WEC	WE	WC
<b>AUC</b>	<b>Area under the curve</b>	<b>0.93</b>	<b>0.74</b>	<b>0.85</b>	<b>0.65</b>
BIO4	Temperature Seasonality	16	12	4	1
BIO10	Mean Temperature of Warmest Quarter	14	3	0	1
BIO13	Precipitation of Wettest Month	10	42	26	10
BIO14	Precipitation of Driest Month	55	22	49	50
DEM	Digital elevation model	4	22	22	38

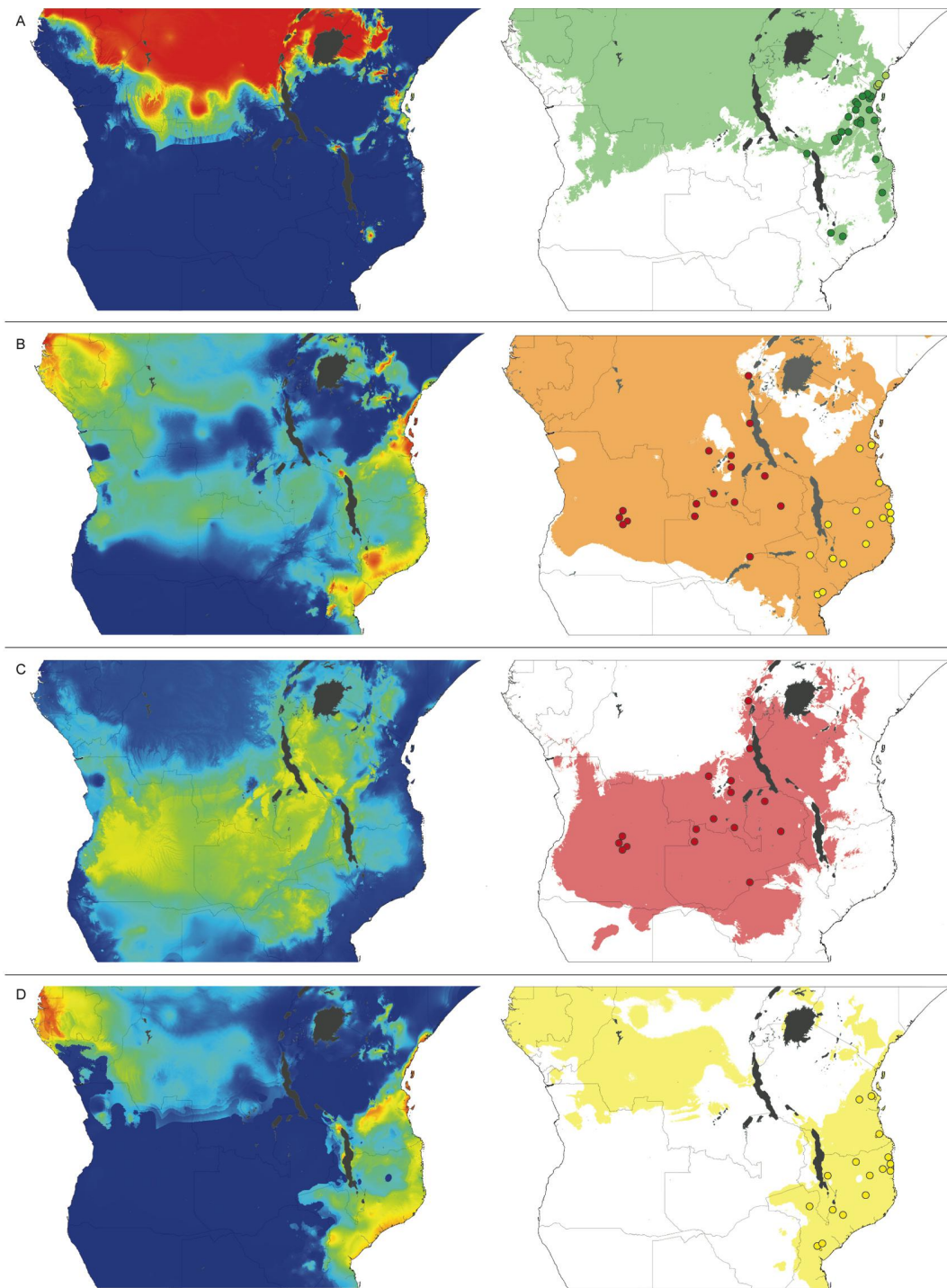

**FIGURE 11. Ecological niche models showing habitat suitability for different clades of *Arthroleptis stenodactylus*.** Left-side models show probabilities of habitat suitability (warm colours = high, cold colours = low); Right-side models show presence-absence predictions using the minimum presence threshold. Models were generated for the main clades recovered in our phylogeny: (A) Forest clade and (B) Woodland clade. Two sub-clades nested within the Woodland clade were modelled separately: (C) Central African, and (D) Eastern African.

### 3.3. Morphological analyses

Results from our linear discriminant analysis (LDA) reveal morphological separation between the two clades of *Arthroleptis stenodactylus* (Fig. 7). Overall accuracy of the model is 91% and the two clades were correctly predicted 93% and 88% of the time for the Forest and Woodland clades, respectively. Average snout-vent length of males and females suggest that Forest clade specimens are larger than the Woodland specimens (Table 3). Confusion matrices reporting the predictions success using LDAs are depicted in Table S6 (Appendix A).

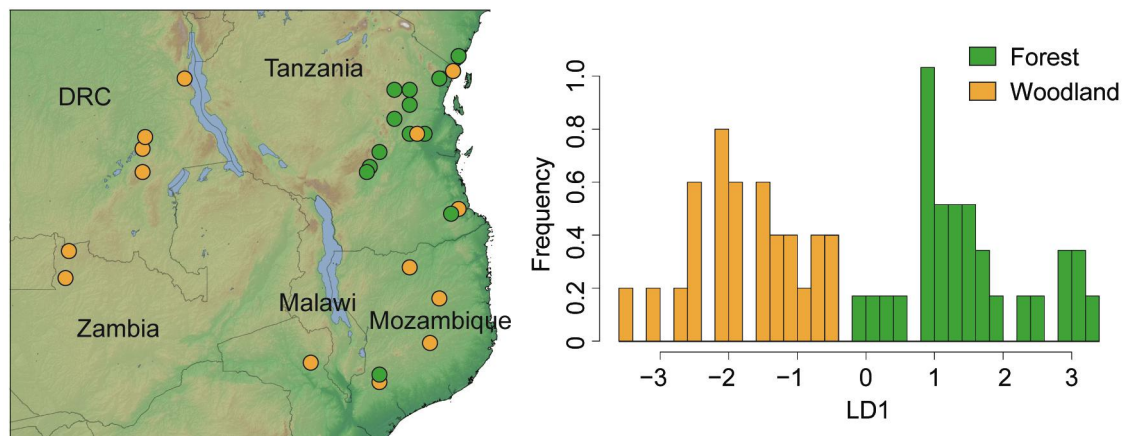

**FIGURE 12.** Linear discriminant analyses (LDA) of *Arthroleptis stenodactylus*. Right: Map showing the distribution of the specimens measured. Left: LDA of Woodland and Forest clades.

**Table 5.** Mean of snout-vent length of Forest and Woodland specimens of *Arthroleptis stenodactylus*. Number of specimens measured indicated in parentheses.

	Male	Female
Woodland	(3) 25.1 ± 1.5	(8) 30.0 ± 3.9
Forest	(11) 27.6 ± 4.2	(19) 33.1 ± 5.8

#### 4. Discussion

##### 4.1. Phylogenetic relationships within *Arthroleptis stenodactylus*

Our combined molecular topology reveals deep genetic structure within what is currently conceived as *A. stenodactylus*. This finding combined with the ecological and morphological data presented here demonstrates that there are in fact at least two forms of *A. stenodactylus* – a forest and a woodland form – corroborating the suspicion from the literature (Loveridge, 1953; Pickersgill, 2007). Four main clades were identified, three from forest and one from woodland: the Forest clade (montane and coastal forest), Lindi (coastal forest), Nyambene Hills (montane forest) and the Woodland clade (lowland woodland *miombo*). This result supports Pickersgill's idea that there are two forms (forest and savannah) being referred to as *A. stenodactylus*, considering that his definition of savannah includes woodland and *miombo* vegetation. Support for the mountain and lowland races mentioned by Loveridge (1953) is less convincing because some assemblages from the Forest clade occur in lowland forest (e.g. coastal region, except Lindi) and some from the Woodland clade are found in mountains (i.e. Mts. Mabu and Mulanje). Nonetheless, the morphological analysis shows that the Forest form is larger than the Woodland form. This result agrees with Loveridge's observation that the mountain form is larger than the lowland (Loveridge, 1953, pp. 389-390). Unfortunately the type of *A. stenodactylus* was presumably destroyed during the World War II and no neotype has been designated. To solve this taxonomic conundrum a thorough review of all synonyms associated with the name *A. stenodactylus* is required and the designation of a neotype for *A. stenodactylus* is overdue. Our phylogeny, coupled with the ecological and morphological findings, can provide guidance regarding the relationships within the assemblages.

##### 4.2. Historical Biogeography

The development of the East African rift system during the Eocene-Oligocene coupled with the sharp cooling events (Zachos et al., 2001) induced drier conditions which is thought to have started the fragmentation of the pan-African rain forest (Axelrod and Raven, 1978; Coetzee, 1993; Sepulchre et al., 2006). Climatic and geological events occurred during the Miocene (23-5 million years ago; from now on "Ma") are considered crucial to explain the current biotic composition in Africa (see Plana, 2004 and references therein). A study with caecilians reveals that at least two different vicariant events lead to the current distribution of sister taxa between the Guineo-Congolian and the East African forests (Loader et al., 2007).

Similarly, the plant family Annonaceae suggests multiple reconnections between East and West Africa since the Oligocene (Couvreur et al., 2008). The split between *A. stenodactylus* and its sister-group is estimated to have occurred *c.* 32 Ma (Hedges et al., 2015) which coincides with the beginning of the rifting process (see Fig. 7). While the putative sister-group of *A. stenodactylus* is found in the Guineo-Congolian forest ((*A. poecilonotus*, *A. adelphus*) *A. variabilis*), the forest-dependent clades of *A. stenodactylus* (i.e. Forest, Lindi and Nyambene Hills) are restricted to East Africa. The Woodland clade, which is adapted to drier conditions, is widely spread across East and Central Africa. Considering that the most recent common ancestor of *A. stenodactylus* and its sister-group was supposedly a forest dweller (see Fig. 5), adaptation to drier environments would have allowed the Woodland clade to disperse across East Africa and colonize open areas in Central Africa.

The diversification pattern observed within *A. stenodactylus* is pertinent with the predictions of the VRM (Fig. 1). The formation of the Tanganyikan and Malawian rifts during the Miocene (*c.* 12 Ma and 7 Ma, respectively) intensified the aridification process in East Africa leading to the increase of open “savannah-mosaic” at the expense of the rainforest (Sepulchre et al., 2006). As the East African forest became increasingly fragmented, populations of *A. stenodactylus* would have been isolated in forest patches in upland areas and along riverine forests in the lowlands and coastal region (i.e. refuges). This has been shown in lineages of forest robins (*Sheppardia*), which Voelker et al. (2010) speculated became isolated in the East African montane region during an aridification event in the Late-Pliocene. Other studies have also linked isolation of taxa across upland and coastal regions (Carleton and Stanley, 2012; Fjeldså et al., 2006; Mathee et al., 2004).

The transition between Late-Miocene (10-5 Ma) and Early-Pliocene (5-3.5 Ma) was marked by drastic changes in moisture levels resulting in expansion of rainforest and the retraction of savannah (Couvreur et al., 2008; Plana, 2004). Populations previously fragmented would have been reconnected via riparian corridors (Bryja et al., 2014a; Measey and Tolley, 2011). This plausibly explains how *A. stenodactylus* populations from the Forest clade could have maintained gene flow irrespective of geographical distances. Sympatric assemblages from the Lindi plateau (see Fig. 4; Forest and Lindi clades) could have accumulated mutations during the isolation period and later secondary contact reinforced the signal (instead of eliminating it), though additional data (e.g. call, diet) may be necessary to clarify this case. The Lindi plateau possibly represents a zone of secondary contact, and in

this particular case, geographic overlap (*sensu* Haffer, 1969) seems like a reasonable explanation for the presence of sympatric lineages. Investigation of gene flow between lineages is one way to test this hypothesis. A third lineage, belonging to the Woodland clade, also occurs in Lindi but in the lowland (< 300 m asl) where the forest is dryer resembling more woodland and miombo environments. The Lindi regions comprises a series of plateaux that together are regarded as a local centre of endemism for plants and vertebrates (Burgess et al., 1998; Clarke, 2001), though the reason for this high endemism remains unknown (Clarke, 2001).

The VRM (Vanzolini and Williams, 1981) postulates that during periods of dryer climatic conditions when forest become fragmented some patches does not last the whole cycle and vanishes. Ecotone-adapted populations would become fully adapted to the drier habitat (i.e. savannah or woodland). The original forest-dependent species will have allopatric (disjunct) populations in forest refuges and an isolated population in open habitat. Forest fragments are not homogeneous, having different sizes, resource availability and precipitation levels. These factors imply that refuge assemblages are under unique selective pressures, though the population from open formation would be undergoing very different selection pressure. If this population thrives it will give rise to an ecologically distinct sister-species with potential to become widespread, given the extension of the new habitat (Vanzolini and Williams, 1981). Accordingly, the VRM explains the ecological differentiation and the widespread distribution of the Woodland clade of *A. stenodactylus* across East and Central Africa. The dwarf chameleon *Bradypodion* provides a similar example where recent radiations are found in open habitat while the ancient lineages are restricted to forest (Tolley et al., 2008). Despite several other examples of ecotone-adapted lineages with plants (Fjeldså and Lovett, 1997; Plana, 2004), frogs (Lawson et al., 2015), birds (Smith et al., 1997) and mammals (Bryja et al., 2014b) showing diversification patterns congruent with the VRM, except for Burgess et al. (1998) and Fjeldså and Lovett (1997) who briefly mention the VRM as a plausible explanation for diversification patterns in East Africa, it is fair to state that this model has been overlooked by African biogeographers.

Pulses of climatic changes also occurred during the Pleistocene repeatedly transforming the African landscape (Maslin et al., 2014; Trauth et al., 2005). Currently in East Africa, forests are restricted to mountains and plateaus where orographic rainfall secure climatic stability, riverine corridors or to small patches of coastal forest. The latter, in addition

to the climatic changes that impacted the whole continent, was also affected by sea-level changes, which flooded areas below 100 m asl near the coastal region (see Burgess et al., 1998). Like the tectonic events and climatic changes in Oligocene-Miocene, these Quaternary vicariant events played an important role promoting cladogenesis. For instance, small mammals show intensive diversification rates during the Pliocene-Pleistocene (Bryja et al., 2014b), whereas chameleons seem to have diversified in the Tertiary (Tolley et al., 2011, 2008). Begonias also had their peak of diversification more recently but older lineages are estimated to have diversified in the Oligocene-Miocene (Plana, 2004).

## **5. Conclusions**

As suspected in the literature, *Arthroleptis stenodactylus* is a species complex with at least two ecologically and morphologically distinct forms, a forest and a woodland form. A thorough taxonomic review is necessary to correctly allocate these distinct forms. The isolated population from Nyambene Hills and the *A. stenodactylus* assemblage from the Lindi plateau deserve further attention. Additional data such as morphology, call and diet may reveal other cryptic species within this group.

The biogeographic pattern associated with *A. stenodactylus* seems to be the result of vicariant events leading to fragmentation of a forest-dependent species and adaptation of one population to the ecotone (i.e. woodland). While the forest-dependent form remained allopatrically and sympatrically (Lindi) distributed in fragments in East Africa, the woodland form became widespread across the landscape in East and Central Africa. The diversification pattern observed in *A. stenodactylus* conforms to the vanishing refuge model. Hence, we suggest that this model should be considered for other widespread species adapted to broad environmental conditions.

### Acknowledgements

We would like to thank Beryl Bwong, Christopher Barratt, Hendrik Mueller and Eli Greenbaum for providing tissue samples. The expedition to Mozambique was funded by Krystal Tolley's grant awarded by National Geographic Society, and Richard Smith funded GBBS expedition to Zambia. GBBS PhD is funded by *Eidgenössische Stipendienkommission für ausländische Studierende* (ESKAS) and *Freiwillige Akademische Gesellschaft* (FAG) Basel.

### References

- Abascal, F., Zardoya, R., Telford, M.J., 2010. TranslatorX: multiple alignment of nucleotide sequences guided by amino acid translations. *Nucleic Acids Res.* 38, W7-13. doi:10.1093/nar/gkq291
- Anderson, R.P., Raza, A., 2010. The effect of the extent of the study region on GIS models of species geographic distributions and estimates of niche evolution: preliminary tests with montane rodents (genus *Nephelomys*) in Venezuela. *J. Biogeogr.* 37, 1378–1393. doi:10.1111/j.1365-2699.2010.02290.x
- Angulo, A., Icochea, J., 2010. Cryptic species complexes, widespread species and conservation: lessons from Amazonian frogs of the *Leptodactylus marmoratus* group (Anura: Leptodactylidae). *Syst. Biodivers.* 8, 357–370.
- Axelrod, D.I., Raven, P.H., 1978. Late Cretaceous and Tertiary vegetation history of Africa, in: *Biogeography and Ecology of Southern Africa*. Springer, pp. 77–130.
- Blackburn, D.C., 2008. Biogeography and evolution of body size and life history of African frogs: phylogeny of squeakers (*Arthroleptis*) and long-fingered frogs (*Cardioglossa*) estimated from mitochondrial data. *Mol. Phylogenet. Evol.* 49, 806–26. doi:10.1016/j.ympev.2008.08.015
- Blackburn, D.C., Measey, G.J., 2009. Dispersal to or from an African biodiversity hotspot? *Mol. Ecol.* 18, 1904–1915. doi:10.1111/j.1365-294X.2009.04156.x
- Bryja, J., Mikula, O., Patzenhauerová, H., Oguge, N.O., Šumbera, R., Verheyen, E., 2014a. The role of dispersal and vicariance in the Pleistocene history of an East African mountain rodent, *Praomys delectorum*. *J. Biogeogr.* 41, 196–208. doi:10.1111/jbi.12195
- Bryja, J., Mikula, O., Šumbera, R., Meheretu, Y., Aghová, T., Lavrenchenko, L.A., Mazoch, V., Oguge, N., Mbau, J.S., Welegerima, K., Amundala, N., Colyn, M., Leirs, H.,



- 
- Verheyen, E., 2014b. Pan-African phylogeny of *Mus* (subgenus *Nannomys*) reveals one of the most successful mammal radiations in Africa. *BMC Evol. Biol.* 14, 1–20. doi:10.1186/s12862-014-0256-2
- Burgess, N.D., Clarke, G.P., Rodgers, W.A., 1998. Coastal forests of eastern Africa: status, endemism patterns and their potential causes. *Biol. J. Linn. Soc.* 64, 337–367. doi:10.1111/j.1095-8312.1998.tb00337.x
- Carleton, M.D., Stanley, W.T., 2012. Species limits within the *Praomys delectorum* group (Rodentia: Muridae: Murinae) of East Africa: a morphometric reassessment and biogeographical implications. *Zool. J. Linn. Soc.* 165, 420–469. doi:10.1111/j.1096-3642.2012.00817.x
- Castresana, J., 2000. Selection of Conserved Blocks from Multiple Alignments for Their Use in Phylogenetic Analysis. *Mol. Biol. Evol.* 17, 540–552. doi:10.1093/oxfordjournals.molbev.a026334
- Clarke, G.P., 2001. The Lindi Local Centre of Endemism in SE Tanzania. *Syst. Geogr. Plants* 71, 1063. doi:10.2307/3668738
- Coetsee, J.A., 1993. African flora since the terminal Jurassic, in: *Biological Relationships between Africa and South America*. Yale University Press, pp. 37–61.
- Couvreur, T.L.P., Chatrou, L.W., Sosef, M.S.M., Richardson, J.E., 2008. Molecular phylogenetics reveal multiple tertiary vicariance origins of the African rain forest trees. *BMC Biol.* 6, 54. doi:10.1186/1741-7007-6-54
- Faulkes, C.G., Mgode, G.F., Le Comber, S.C., Bennett, N.C., 2010. Cladogenesis and endemism in Tanzanian mole-rats, genus *Fukomys*: (Rodentia Bathyergidae): a role for tectonics? *Biol. J. Linn. Soc.* 100, 337–352. doi:10.1111/j.1095-8312.2010.01418.x
- Fjeldså, J., Bowie, R.C.K., Kiure, J., 2006. The forest batis, *Batis mixta*, is two species: description of a new, narrowly distributed *Batis* species in the Eastern Arc biodiversity hotspot. *J. Ornithol.* 147, 578–590. doi:10.1007/s10336-006-0082-4
- Fjeldså, J., Lovett, J.C., 1997. Geographical patterns of old and young species in African forest biota: the significance of specific montane areas as evolutionary centres. *Biodivers. {&} Conserv.* 6, 325–346. doi:10.1023/A:1018356506390
- Frost, D.R., 2016. *Amphibian Species of the World: an Online Reference [WWW Document]*. Am. Museum Nat. Hist. New York, USA. URL <http://research.amnh.org/vz/herpetology/amphibia/index.html> (accessed 1.1.16).

- Graham, C.H., Ron, S.R., Santos, J.C., Schneider, C.J., Moritz, C., 2004. Integrating phylogenetics and environmental niche models to explore speciation mechanisms in dendrobatid frogs. *Evolution* (N. Y). 58, 1781–1793. doi:10.1111/j.0014-3820.2004.tb00461.x
- Haffer, J., 1969. Speciation in Amazonian Forest Birds. *Science* (80-.). 165, 131–137.
- Hedges, S.B., Marin, J., Suleski, M., Paymer, M., Kumar, S., 2015. Tree of Life Reveals Clock-Like Speciation and Diversification. *Mol. Biol. Evol.* 32, 835–845. doi:10.1093/molbev/msv037
- Hijmans, R.J., Cameron, S.E., Parra, J.L., Jones, P.G., Jarvis, A., 2005. Very high resolution interpolated climate surfaces for global land areas. *Int. J. Clim.* 25, 1965–1978. doi:10.1002/joc.1276
- IUCN, 2016. The IUCN Red List of Threatened Species. Version 2016-3. Downloaded on 07 December 2016.
- Katoh, K., Standley, D.M., 2013. MAFFT multiple sequence alignment software version 7: improvements in performance and usability. *Mol. Biol. Evol.* 30, 772–80. doi:10.1093/molbev/mst010
- Kearse, M., Moir, R., Wilson, A., Stones-Havas, S., Cheung, M., Sturrock, S., Buxton, S., Cooper, A., Markowitz, S., Duran, C., Thierer, T., Ashton, B., Meintjes, P., Drummond, A., 2012. Geneious Basic: an integrated and extendable desktop software platform for the organization and analysis of sequence data. *Bioinformatics* 28, 1647–9. doi:10.1093/bioinformatics/bts199
- Lanfear, R., Calcott, B., Ho, S.Y.W., Guindon, S., 2012. Partitionfinder: combined selection of partitioning schemes and substitution models for phylogenetic analyses. *Mol. Biol. Evol.* 29, 1695–701. doi:10.1093/molbev/mss020
- Lawson, L.P., Bates, J.M., Menegon, M., Loader, S.P., 2015. Divergence at the edges: peripatric isolation in the montane spiny throated reed frog complex. *BMC Evol. Biol.* 15, 1–15. doi:10.1186/s12862-015-0384-3
- Lehner, B., Verdin, K., Jarvis, A., 2006. Hydrological data and maps based on Shuttle elevation derivatives at multiple scales (HydroSHEDS)-Technical Documentation. World Wildl. Fund US, Washington, DC.
- Linder, H.P., 2014. The evolution of African plant diversity. *Front. Ecol. Evol.* 2, 38. doi:10.3389/fevo.2014.00038

- 
- Loader, S.P., Pisani, D., Cotton, J.A., Gower, D.J., Day, J.J., Wilkinson, M., 2007. Relative time scales reveal multiple origins of parallel disjunct distributions of African caecilian amphibians. *Biol. Lett.* 3, 505 LP-508.
- Loader, S.P., Poynton, J.C., Lawson, L.P., Blackburn, D.C., Menegon, M., 2011. Herpetofauna of Montane Areas of Tanzania. 3. Amphibian Diversity in the Northwestern Eastern Arc Mountains, with the Description of a New Species of *Arthroleptis* (Anura: Arthroleptidae).
- Lobo, J.M., Jiménez-Valverde, A., Real, R., 2008. AUC: a misleading measure of the performance of predictive distribution models. *Glob. Ecol. Biogeogr.* 17, 145–151. doi:10.1111/j.1466-8238.2007.00358.x
- Loveridge, A., 1953a. Zoological results of a fifth expedition to East Africa. IV. Amphibians from Nyasaland and Tete. *Bull. Museum Comp. Zool.* 110, 325–406.
- Loveridge, A., 1953b. Zoological results of a fifth expedition to East Africa. IV. Amphibians from Nyasaland and Tete. *Bull. Museum Comp. Zool.* 110, 325–406.
- Maslin, M.A., Brierley, C.M., Milner, A.M., Shultz, S., Trauth, M.H., Wilson, K.E., 2014. East African climate pulses and early human evolution. *Quat. Sci. Rev.* 101, 1–17. doi:10.1016/j.quascirev.2014.06.012
- Masters, J.C., Génin, F., Couette, S., Groves, C.P., Nash, S.D., Delpero, M., Pozzi, L., 2017. A new genus for the eastern dwarf galagos (Primates: Galagidae). *Zool. J. Linn. Soc.* 1–13. doi:10.1093/zoolinnean/zlw028
- Matthee, C.A., Tilbury, C.R., Townsend, T., 2004. A phylogenetic review of the African leaf chameleons: genus *Rhampholeon* (Chamaeleonidae): the role of vicariance and climate change in speciation. *Proc. Biol. Sci.* 271, 1967–75. doi:10.1098/rspb.2004.2806
- Measey, G.J., Tolley, K.A., 2011. Sequential Fragmentation of Pleistocene Forests in an East Africa Biodiversity Hotspot: Chameleons as a Model to Track Forest History. *PLoS One* 6, 1–9. doi:10.1371/journal.pone.0026606
- Müller, H., Liedtke, H.C., Menegon, M., Beck, J., Ballesteros-Mejia, L., Nagel, P., Loader, S.P., 2013. Forests as promoters of terrestrial life-history strategies in East African amphibians. *Biol. Lett.* 9, 20121146. doi:10.1098/rsbl.2012.1146
- Pfeffer, G., 1893. Ostafrikanische Reptilien und Amphibien, gesammelt von Herrn Dr. F. Stuhlmann im Jahre 1888 und 1889. *Jahrb. der Hambg. Wissenschaftlichen Anstalten* 10, 69–105.

- 
- Phillips, S.J., Anderson, R.P., Schapire, R.E., 2006. Maximum entropy modeling of species geographic distributions. *Ecol. Modell.* 190, 231–259. doi:10.1016/j.ecolmodel.2005.03.026
- Pickersgill, M., 2007. Frog Search, Results of Expeditions to Southern and Eastern Africa, Chimaira. ed.
- Plana, V., 2004. Mechanisms and tempo of evolution in the African Guineo–Congolian rainforest. *Philos. Trans. R. Soc. London B Biol. Sci.* 359.
- Poynton, J.C., Broadley, D.G., 1985. Amphibia Zambesiaca 2. Ranidae. *Ann. Natal Museum.*
- R Core Team, 2014. R: A Language and Environment for Statistical Computing.
- Richardson, J.E., Pennington, R.T., 2016. Editorial: Origin of Tropical Diversity: From Clades to Communities. *Front. Genet.* 7, 186. doi:10.3389/fgene.2016.00186
- Ronquist, F., Huelsenbeck, J.P., 2003. MrBayes 3: Bayesian phylogenetic inference under mixed models. *Bioinformatics* 19, 1572–1574. doi:10.1093/bioinformatics/btg180
- Rundle, H.D., Nosil, P., 2005. Ecological speciation. *Ecol. Lett.* 8, 336–352. doi:10.1111/j.1461-0248.2004.00715.x
- Schmidt, K.P., Inger, R.F., 1959. Amphibians exclusive of the genera *Afrivalus* and *Hyperolius*, in: *Exploration Du Parc National de l'Upemba*. Mission G.F. de Witte. Institut des Parcs Nationaux du Congo Belge, Bruxelles, pp. 1–264.
- Sepulchre, P., Ramstein, G., Fluteau, F., Schuster, M., Tiercelin, J.-J., Brunet, M., 2006. Tectonic Uplift and Eastern Africa Aridification. *Science* (80-. ). 313, 1419–1423.
- Smith, T.B., Wayne, R.K., Girman, D.J., Bruford, M.W., 1997. A Role for Ecotones in Generating Rainforest Biodiversity. *Science* (80-. ). 276, 1855 LP-1857.
- Stamatakis, A., 2014. RAxML version 8: a tool for phylogenetic analysis and post-analysis of large phylogenies. *Bioinformatics* 30, 1312–3. doi:10.1093/bioinformatics/btu033
- Swofford, D.L., 2001. PAUP\*: Phylogenetic Analysis Using Parsimony (and other methods) 4.0.b5.
- Taylor, P.J., Stoffberg, S., Monadjem, A., Schoeman, M.C., Bayliss, J., Cotterill, F.P.D., 2012. Four New Bat Species (*Rhinolophus hildebrandtii* Complex) Reflect Plio-Pleistocene Divergence of Dwarfs and Giants across an Afromontane Archipelago. *PLoS One* 7, 1–23. doi:10.1371/journal.pone.0041744
- Tolley, K.A., Chase, B.M., Forest, F., 2008. Speciation and radiations track climate transitions since the Miocene Climatic Optimum: a case study of southern African

- 
- chameleons. *J. Biogeogr.* 35, 1402–1414. doi:10.1111/j.1365-2699.2008.01889.x
- Tolley, K.A., Tilbury, C.R., Measey, G.J., Menegon, M., Branch, W.R., Matthee, C.A., 2011. Ancient forest fragmentation or recent radiation? Testing refugial speciation models in chameleons within an African biodiversity hotspot. *J. Biogeogr.* 38, 1748–1760. doi:10.1111/j.1365-2699.2011.02529.x
- Trauth, M.H., Maslin, M.A., Deino, A., Strecker, M.R., 2005. Late Cenozoic Moisture History of East Africa. *Science (80-. )*. 309, 2051 LP-2053.
- Vanzolini, P.E., Williams, E.E., 1981. The vanishing refuge: a mechanism for ecogeographic speciation. *Pap. Avulsos Zool.* 34, 251–255.
- Venables, W.N., Ripley, B.D., 2002. *Modern Applied Statistics with S*, Fourth. ed. Springer, New York.
- Voelker, G., Outlaw, R.K., Bowie, R.C.K., 2010. Pliocene forest dynamics as a primary driver of African bird speciation. *Glob. Ecol. Biogeogr.* 19, 111–121. doi:10.1111/j.1466-8238.2009.00500.x
- Zachos, J., Pagani, M., Sloan, L., Thomas, E., Billups, K., 2001. Trends, Rhythms, and Aberrations in Global Climate 65 Ma to Present. *Science (80-. )*. 292, 686 LP-693.
- Zimkus, B.M., Lawson, L.P., Barej, M., Barratt, C.D., Channing, A., Dash, K.M., Dehling, J.M., Du Preez, L., Gehring, P.-S., Greenbaum, E., Gvoždík, V., Harvey, J., Kielgast, J., Kusamba, C., Nagy, Z.T., Pabijan, M., Penner, J., Rödel, M.-O., Vences, M., Lötters, S., 2016. Leapfrogging into new territory: How Mascarene ridged frogs diversified across Africa and Madagascar to maintain their ecological niche. *Mol. Phylogenet. Evol.* doi:10.1016/j.ympev.2016.09.018

# SYNTHESIS

## Discussion

*“As a result of various historical forces, a fauna is composed of unequal elements, and no fauna can be fully understood until it is segregated into its elements and until one has succeeded in explaining the separate history of each of these elements.”* – Mayr, 1965; p. 474.

The biogeographical history of East Africa has been attracting the attention of numerous scientists not least because of the links with human evolution history (deMenocal, 1995; Maslin et al., 2014). As a consequence, this region has been studied in detail in terms of its geological and climatological history (e.g. Chorowicz, 2005; deMenocal, 1995; Sepulchre et al., 2006). Furthermore, the high levels of endemism observed in plants and vertebrate species prompted biogeographers to investigate the patterns and processes involved in the diversification of the East African biota (Burgess et al., 2007, 1998; Lovett and Wasser, 2008). Hence there has been numerous bio- and phylogeographical studies concerning East Africa in the last decades (e.g. Bowie et al., 2004; Burgess et al., 2007; Ceccarelli et al., 2014; Faulkes et al., 2011; Lawson, 2013; Lovett and Wasser, 2008; Stanley and Esselstyn, 2010; Stanley and Olson, 2005). The mountains of northern Mozambique, however, despite being part of the Eastern Afromontane archipelago have long been a neglected area of research. Though, the recent increase in studies from montane areas in northern Mozambique is starting to shed light on the biogeographical history of this region. (e.g. Branch et al., 2014; Conradie et al., 2016; Daniels and Bayliss, 2012; Farooq et al., 2015; Van Noort et al., 2007).

### *Montane amphibians from northern Mozambique*

One of the main objectives of the research reported in this thesis was to describe the diversity of amphibians found on the mountains of northern Mozambique. In general, the amphibian fauna of this region is a subset (28 species) of the East African montane and lowland forest fauna (Branch, 2004; Conradie et al., 2016; Portik et al., 2013). So far, the only endemic amphibians found in northern Mozambique belong to the genus *Nothophryne*, different populations of which are currently being described as distinct taxonomic species based on genetic and morphological characters (Conradie et al. submitted). They are found on Mount

Mulanje in Malawi and on isolated mountains and inselbergs of northern Mozambique. The only caecilian recorded in this region is the montane species *Scolecophorus kirkii*, found on Mount Mabu (Conradie et al., 2016), Mount Namuli (Farooq and Conradie, 2015) and Serra Mecula (Branch, 2004). However, because of their cryptic nature, fossorial species such as caecilians can be easily overlooked (e.g. Gower et al., 2004). The same is valid for canopy dwellers and explosive breeders. Hence, it is expected that with additional surveys in this region the number of species would probably increase. It has been demonstrated before that comprehensive species lists depend on multiple surveys conducted over long periods of time and including different seasons and methods of collection (Silva et al., 2008).

In this thesis I also aimed to elucidate the level of intraspecific diversity among the montane amphibian fauna of northern Mozambique and Malawi. Using phylogeographical approaches, the specific goal was to investigate the level of genetic differentiation and therefore how biogeographically distinct each montane area is. It is expected that species with similar ecology and dispersal abilities have similar biogeographic patterns. Although the amphibians found on the mountains of northern Mozambique displayed substantially different levels of isolation between mountains (chapters 1, 2 and 3), their differences appear coherent with the ecology of each species and the temporal scale of their intraspecific diversification events. For example, *Nothophryne* is a small frog found on granitic rock outcrops, usually associated with mossy patches near water seepages where eggs are laid. The larvae are also found on wet patches of steep granitic slopes. Given the high level of habitat specialisation and isolation, dispersal between mountains, even during wetter periods, seems a less likely event, preventing any type of secondary contact between mountain assemblages. A time-calibrated phylogeny of *Nothophryne* shows that lineage diversification within this genus dates from the Early Miocene *ca.* 22 million years ago (Ma) (chapter 1), which coincides with the beginning of the aridification process that resulted in fragmentation of the previously widespread lowland forest in East Africa (Axelrod and Raven, 1978). The low vagility due to restrictive ecology potentially explains the high genetic diversity observed between mountain assemblages in *Nothophryne* (chapter 1). Species with low density and reduced dispersal abilities are expected to have higher speciation rates (Gavrilets et al., 2000).

In contrast, the reed frog, *Hyperolius substriatus*, has a less specialised habitat and hence its broader distribution across the East African mountains (chapter 2). This species is found in a range of habitats, from montane forest to humid woodland, and reproduction



occurs in permanent and temporary pools (Harper et al., 2010). Genetic diversity between montane lineages in this group was not as great as within the lineages of *Nothophryne* and much more recent (chapters 1 and 2). Estimations based on genetic data suggest that diversification within lineages of *H. substriatus* occurred in the Early Pliocene-Pleistocene (*ca.* 6-2 Ma), which coincides with the Malawian rifting and the climatic cycles of the Pleistocene (chapter 2). Riverine forests seems to provide corridors connecting mountains and forest patches allowing gene flow between populations, as evidenced in other studies of reptiles and amphibians (e.g. Blackburn and Measey, 2009; Measey and Tolley, 2011). Evidence suggest that *H. substriatus* uses riparian forests to disperse between East and Southeast Africa (chapter 2; Lawson, 2013).

In contrast to aquatic breeders that depend on water bodies, terrestrial breeders use moist leaf litter or other humid places like rotten logs to lay their eggs. Difference in availability of these breeding sites is likely to affect dispersal abilities of amphibians. *Arthroleptis stenodactylus* is a direct developer commonly found on forest leaf litter, from montane and lowland forest to savannah, also occurring in anthropogenic environments such as gardens and cultivated areas. The vast availability of terrestrial breeding sites (e.g. leaf litter) compared to aquatic sites (e.g. ponds), combined with its broad environmental niche, plausibly explain why this species has a widespread distribution with low genetic differentiation across East Africa (chapter 3). However, a combination of molecular, ecological and morphological evidence revealed a more complex diversification pattern within *A. stenodactylus* (chapter 3). Three forest-dependent lineages were identified in East African, and a fourth one adapted to drier environments is found across East and Central Africa. The latter, not surprisingly, shows low levels of genetic variation between populations. Although no dated phylogeny is available for this group, the hypothesis of Miocene lineage diversification (chapter 3) seems to be a plausible explanation based on diversification patterns of other groups of vertebrates (Faulkes et al., 2011; Menegon et al., 2014; Tolley et al., 2011, 2008).

In summary, the distribution of amphibians on the montane region of northern Mozambique seems to be regulated by individual biotic (i.e. species ecologies) rather than by general abiotic factors affecting multiple lineages. The level of habitat specialisation and species biology limits the dispersal abilities of amphibians, and this explains the variation in genetic diversity among these montane assemblages. One way to test this hypothesis is by

comparing the level of genetic diversity of multiple other species with similar ecologies. Finally, differences on the temporal scale of diversification events must be taken into account. The same climatic changes and geological events affected these species, however, they responded differently depending on their biology and this indicated by the different ages and levels of lineage diversity observed in this study.

*Connections with the Eastern Afromontane Archipelago and the Coastal Forest of East Africa*

According to the terminology suggested by Poynton and Boycott (1996), the Afromontane species are divided into two latitudinally distributed faunal groups: Afrotropical (includes East African lowland and montane fauna) and Afrotropical (Southeast African montane fauna). It is predicted that the Afrotropical fauna can be related biogeographically to a tropical East African lowland fauna through a complex pattern of species turnover (Poynton and Boycott, 1996). The only strictly montane species of amphibians found in northern Mozambique are the caecilian *Scolecophorus kirkii* and the anurans *Strongylopus fuelleborni* and *Arthroleptis francei* (Branch, 2004; Conradie et al., 2016). Despite the patchiness of sampling in northern Mozambique, evidence indicates that there are different dispersal routes for amphibians connecting the mountains of northern Mozambique with the Coastal Forest and the Eastern Afromontane archipelago (chapters 1, 2 and 3; Farooq et al., 2015; Lawson, 2013). There are examples of Coastal Forest species of birds and amphibians that occur on mountains further inland in northern Mozambique, southern Malawi and eastern Zimbabwe (Conradie et al., 2016; Farooq et al., 2015; Timberlake et al., 2009). For instance, *Nothophryne* is found across a chain of mountains and inselbergs that extends from southern Malawi to Taratibu, in the northern coast of Mozambique (see Fig. 1) (chapter 1). The frog *Mertensophryne anotis* was previously thought to be restricted to two forest patches on the border between Mozambique and Zimbabwe, though a disjunct population has been discovered in Taratibu (Farooq et al., 2015). This distribution pattern roughly overlaps with the enclaves of coastal forest vegetation described by White (1983). These disjunct populations of amphibians could represent relicts of a previously widespread fauna that became fragmented due to the aridification of this region (see Fig. 1). These findings substantiate the hypothesis that there is a dispersal route connecting the Coastal Forest to the mountains of northern Mozambique, southern Malawi and eastern Zimbabwe.

An alternative dispersal route connecting the Afrotropical fauna of East Africa to mountains from Malawi and northern Mozambique possibly exists across the highlands of southern Tanzania and Malawi (see Fig. 1 and Lawson, 2013). This route seems more likely to be the path used by strictly montane species, such as *Scolecormorphus kirkii* and *Strongylopus fuelleborni*, which are also found on the Eastern Arc Mountains but not in lowland forest. Hydrological basins seem to play an important role providing dispersal routes for aquatic breeders in this region (chapter 2; Lawson, 2013). Unfortunately the taxonomic sampling in northern Mozambique is still too patchy to provide more phylogeographical information. Future surveys focused on these strictly montane species may provide important insights into the biogeographical history of this region.

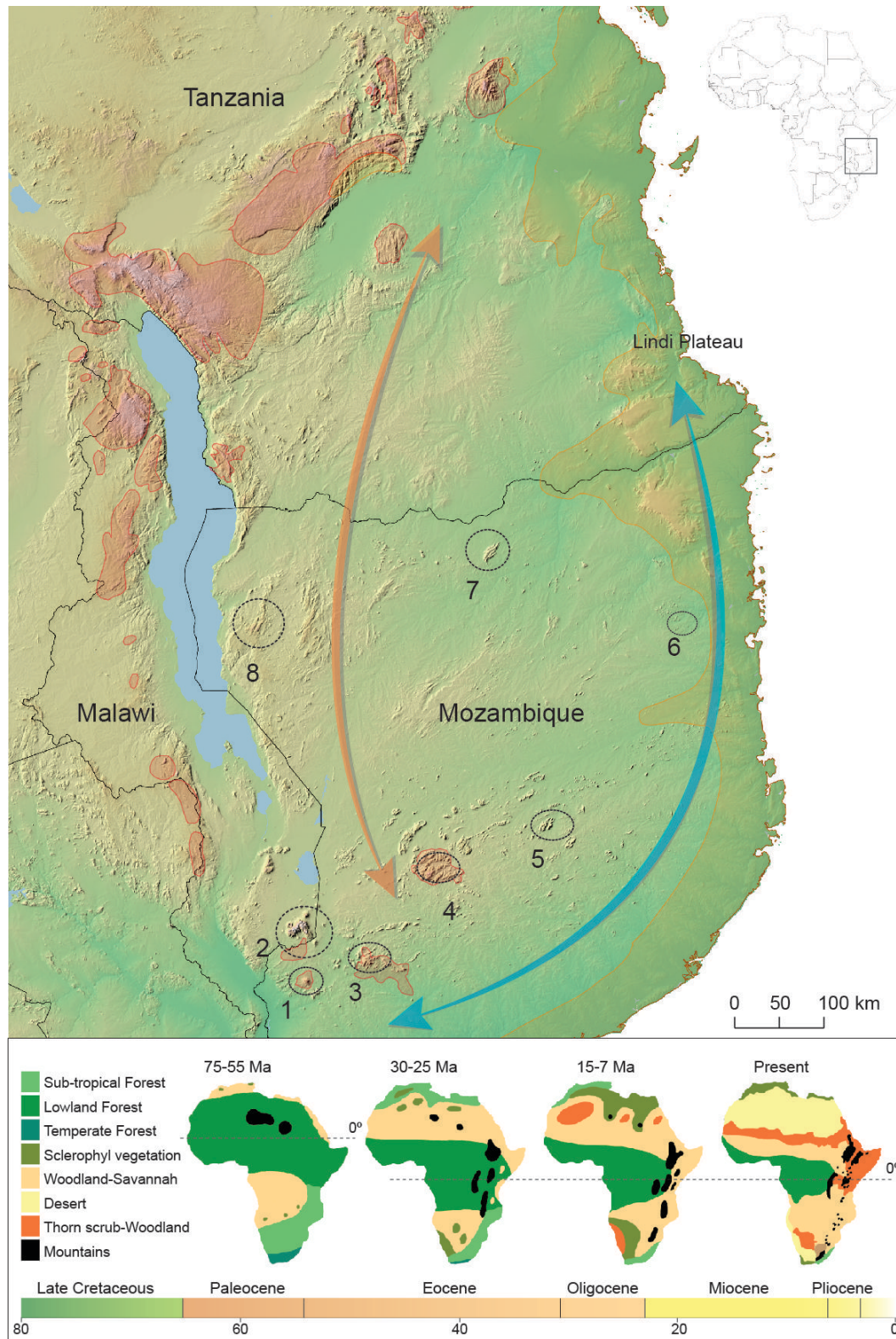

**FIGURE 13. Hypothesised dispersal routes through the mountains of northern Mozambique Mountains and inselbergs: (1) Gorongosa, (2) Chiperone, (3) Mabu, (4) Mulanje, (5) Namuli, (6) M'paluwè, (7) Taratubu, (8) Serra Mecula. Biodiversity hotspots: Eastern Afromontane (red) and Coastal Forest (orange). Blue and orange arrows indicate possible dispersal routes. Lower box: Reconstruction of past vegetation of Africa adapted from Axelrod and Raven (1978).**

## Caveats

One of the foremost limitations for African biogeography is the poor state of knowledge of African amphibian taxonomy. Given that species are the taxonomic units of biogeography, molecular-based species delimitation methods are becoming popular among biogeographers. In the first two chapters of this thesis I used the Bayesian version of the general mixed Yule-coalescent model (bGMYC) to distinguish between populations and species. A study published after the completion of those chapters reveals that the all current methods used to delimit species confound population structure with species boundaries (Sukumaran and Knowles, 2017). In fact what is diagnosed is genetic structure, with no distinction between structure due to populations or due to species. The authors advise a complementary approach, i.e. use of additional evidence to corroborate the hypothesis proposed based on the species delimitation method (i.e. ecological and morphological data). Although this seems to be the ideal approach to follow, limited time and financial resources imposed some constraints to this study. Access to the mountains of northern Mozambique is difficult because of numerous factors including the poor structure and political instability of the country, high travel expenses and the complex bureaucracy to get sampling permits. Furthermore, access to material for morphological data would require visits to collections that are spread across three different continents.

Finally, some of the diversification patterns observed in this study may be due to sampling artefact. There are myriads of mountains and inselbergs in northern Mozambique yet to be explored and it is possible that they may work as stepping-stones connecting this virtually unexplored montane system. For instance, in the case of *Nothophryne* the high genetic diversity observed between mountains could decrease if new populations are found on the adjacent mountains (see Kimura and Weiss, 1964).

## Future Directions

### **Taxonomy**

The thesis has contributed to understanding the complex taxonomic problems in a small subset of the Mozambican montane fauna. Data suggests that numerous species await description and this will require further detailed morphological study. This includes work on case study groups (*Nothophryne*, *Hyperolius substriatus*, and *Arthroleptis stenodactylus*). For each of these groups much work and further sampling is required to resolve taxonomic issues beyond the scope of this thesis. Beyond the studied groups, our preliminary data indicates

other new taxa (e.g. specimens currently referred to *Scolecormorphus kirkii*, *Arthroleptis francei*) that await further taxonomic investigation.

The literature suggests that *Arthroleptis stenodactylus* should perhaps be placed in a different genus (*Coracodichus*) based on skeletal morphology (Laurent, 1941, 1940) although this taxonomic proposal has never been adopted by modern researchers, at least partly due to a lack of detailed studies of osteology. This taxonomic conundrum can therefore be elucidated using e.g. high-resolution x-ray images. This method has been proved efficient in resolving taxonomic problems in amphibians (Piemnta et al., 2009; Verdade and Rodrigues, 2008) and should be further explored to support hypotheses about morphologically cryptic diversity and whether this corresponds to the genetic diversity uncovered in this research.

### **Biogeography**

The various problems and limitations discussed above point to directions in which our understanding can be improved and some of the hypothesis proposed here can be tested. Thus this thesis provides a basis for formulating numerous additional questions regarding the biogeographic history of the Mozambican fauna. Predictions of potential distribution of species generated in this study can be ground-truthed with targeted fieldwork, which also can potentially optimise the time and resources spent in the field. Additionally, checking the areas predicted as suitable for species would provide valuable information regarding the accuracy of these models, and perhaps will reveal new populations or even species. Further fieldwork surveys will be crucial to improve our understanding of the biota of this region. Areas already surveyed should be re-visited during different periods to account for seasonality.

### **Education**

Finally, one important point that should be addressed is the involvement of locally based researchers in Mozambique. Development of projects to train Mozambican nationals (e.g. students, museum researchers and school teachers) to identify species, take photos and gather basic ecological data could produce invaluable data at lower costs, in addition to raising awareness concerning the importance of forest conservation in Mozambique and building scientific capacity in this unjustly neglected but biologically fascinating and important country.

---

## Conclusion

Reconstructing historical biogeography is similar to assembling a jigsaw puzzle, every piece added reveals a little bit more of the overall picture. In this thesis I present and discuss the diversity of species found on the mountains of northern Mozambique and explore the relationships between assemblages of different mountains. This study reveals a complex history of lineage diversification, highly influenced by biotic factors, and proposes hypothesis to explain the biogeographical patterns observed. The mountains of northern Mozambique seem to be in the crossroads between two faunal groups, Afrotperate and Afrotropical. Most of the species found on these mountains are biogeographically related to the lowland forest of East Africa. Furthermore, this thesis provides predictions regarding species potential distributions across other unexplored mountains of this region. Some of the hypotheses and predictions suggested in this thesis can potentially be tested in the future. Finally, this thesis shed light on the complex biogeographical history of African amphibians.

## References

- Axelrod, D.I., Raven, P.H., 1978. Late Cretaceous and Tertiary vegetation history of Africa, in: *Biogeography and Ecology of Southern Africa*. Springer, pp. 77–130.
- Blackburn, D.C., Measey, G.J., 2009. Dispersal to or from an African biodiversity hotspot? *Mol. Ecol.* 18, 1904–1915. doi:10.1111/j.1365-294X.2009.04156.x
- Bowie, R.C.K., Fjeldså, J., Hackett, S.J., Crowe, T.M., 2004. Molecular evolution in space and through time: mtDNA phylogeography of the Olive Sunbird (*Nectarinia olivacea/obscura*) throughout continental Africa. *Mol. Phylogenet. Evol.* 33, 56–74. doi:10.1016/j.ympev.2004.04.013
- Branch, W.R., 2004. Herpetological Survey of the Niassa Game Reserve, Northern Mozambique, Sociedade para a Gestão e Desenvolvimento da Reserva do Niassa.
- Branch, W.R., Bayliss, J., Tolley, K.A., 2014. Pygmy chameleons of the *Rhampholeon platyceps* complex (Squamata: Chamaeleonidae): Description of four new species from isolated “sky islands” of northern Mozambique. *Zootaxa* 3814, 1–36.
- Burgess, N.D., Butynski, T.M., Cordeiro, N.J., Doggart, N.H., Fjeldså, J., Howell, K.M., Kilahama, F.B., Loader, S.P., Lovett, J.C., Mbilinyi, B., Menegon, M., Moyer, D.C., Nashanda, E., Perkin, A., Rovero, F., Stanley, W.T., Stuart, S.N., 2007. The biological

- importance of the Eastern Arc Mountains of Tanzania and Kenya. *Biol. Conserv.* 134, 209–231. doi:10.1016/j.biocon.2006.08.015
- Burgess, N.D., Clarke, G.P., Rodgers, W.A., 1998. Coastal forests of eastern Africa: status, endemism patterns and their potential causes. *Biol. J. Linn. Soc.* 64, 337–367. doi:10.1111/j.1095-8312.1998.tb00337.x
- Ceccarelli, F.S., Menegon, M., Tolley, K.A., Tilbury, C.R., Gower, D.J., Laserna, M.H., Kasahun, R., Rodriguez-Prieto, A., Haggmann, R., Loader, S.P., 2014. Evolutionary relationships, species delimitation and biogeography of Eastern Afrotropical horned chameleons (Chamaeleonidae: *Trioceros*). *Mol. Phylogenet. Evol.* 80, 125–136. doi:10.1016/j.ympev.2014.07.023
- Chorowicz, J., 2005. The East African rift system. *J. African Earth Sci.* 43, 379–410. doi:10.1016/j.jafrearsci.2005.07.019
- Conradie, W., Bittencourt-Silva, G., Engelbrecht, H.M., Loader, S.P., Menegon, M., Nanvonamuquitxo, C., Scott, M., Tolley, K.A., 2016. Exploration into the hidden world of Mozambique's sky island forests: new discoveries of reptiles and amphibians. *Zoosystematics Evol.* 92, 163–180.
- Daniels, S.R., Bayliss, J., 2012. Neglected refugia of biodiversity: mountainous regions in Mozambique and Malawi yield two novel freshwater crab species (Potamonautidae: *Potamonautes*). *Zool. J. Linn. Soc.* 164, 498–509. doi:10.1111/j.1096-3642.2011.00773.x
- deMenocal, P.B., 1995. Plio-Pleistocene African climate. *Science* 270, 53–59. doi:10.1126/science.270.5233.53
- Farooq, H., Liedtke, H.C., Bittencourt-Silva, G., Conradie, W., Loader, S.P., 2015. The distribution of *Mertensophryne anotis* with a new record in Northern Mozambique. *Herpetol. Notes* 8, 305–307.
- Farooq, H.O.M., Conradie, W., 2015. Second record of a *Scolecophorus kirkii* Boulenger, 1883 (Gymnophiona: Scolecophoridae) for Mozambique. *Herpetol. Notes*.
- Faulkes, C.G., Bennett, N.C., Cotterill, F.P.D., Stanley, W., Mgode, G.F., Verheyen, E., 2011. Phylogeography and cryptic diversity of the solitary-dwelling silvery mole-rat, genus *Heliophobius* (family: Bathyergidae). *J. Zool.* 285, 324–338. doi:10.1111/j.1469-7998.2011.00863.x
- Gavrilets, S., Li, H., Vose, M.D., 2000. Patterns of Parapatric Speciation. *Evolution* (N. Y).



---

54, 1126–1134.

- Gower, D.J., Loader, S.P., Wilkinson, M., 2004. Assessing the conservation status of soil-dwelling vertebrates: Insights from the rediscovery of *Typhlops uluguruensis* (Reptilia: Serpentes: Typhlopidae). *Syst. Biodivers.* 2, 79–82. doi:10.1017/S1477200004001343
- Harper, E.B., Measey, G.J., Patrick, D.A., Menegon, M., Vonesh, J.R., Swilla, I., 2010. Field guide to the amphibians of the Eastern Arc Mountains and Coastal Forests of Tanzania and Kenya. Nairobi, Kenya Camerapix Publ. Int. 114.
- Kimura, M., Weiss, G.H., 1964. The Stepping Stone Model of Population Structure and the Decrease of Genetic Correlation with Distance. *Genetics* 49, 561–576.
- Laurent, R.F., 1941. Contribution à l'ostéologie et à la systématique des ranides africains. Première note. *Rev. Zool. Bot. Africaines. Tervuren* 34, 192–235.
- Laurent, R.F., 1940. Contribution à l'ostéologie et à la systématique des ranides africains. Première note. *Rev. Zool. Bot. Africaines. Tervuren* 34, 74–96.
- Lawson, L.P., 2013. Diversification in a biodiversity hot spot: landscape correlates of phylogeographic patterns in the African spotted reed frog. *Mol. Ecol.* 22, 1947–1960. doi:10.1111/mec.12229
- Lovett, J.C., Wasser, S.K., 2008. Biogeography and ecology of the rain forests of Eastern Africa. Cambridge University Press.
- Maslin, M.A., Brierley, C.M., Milner, A.M., Shultz, S., Trauth, M.H., Wilson, K.E., 2014. East African climate pulses and early human evolution. *Quat. Sci. Rev.* 101, 1–17. doi:10.1016/j.quascirev.2014.06.012
- Measey, G.J., Tolley, K.A., 2011. Sequential Fragmentation of Pleistocene Forests in an East Africa Biodiversity Hotspot: Chameleons as a Model to Track Forest History. *PLoS One* 6, 1–9. doi:10.1371/journal.pone.0026606
- Menegon, M., Loader, S.P., Marsden, S.J., Branch, W.R., Davenport, T.R.B., Ursenbacher, S., 2014. The genus *Atheris* (Serpentes: Viperidae) in East Africa: Phylogeny and the role of rifting and climate in shaping the current pattern of species diversity. *Mol. Phylogenet. Evol.* 79, 12–22. doi:10.1016/j.ympev.2014.06.007
- Piemnta, B.V.S., Napoli, M.F., Haddad, C.F.B., 2009. A new species of casque-headed tree frog, genus *Aparasphenodon* Miranda-Ribeiro (Amphibia: Anura: Hylidae), from the Atlantic Rainforest of southern Bahia, Brazil. *Zootaxa* 2123, 46–54.
- Portik, D.M., Mulungu, E., Sequeira, D., McEntee, J.P., 2013. Herpetological surveys of the

- Serra Jeci and Namuli massifs, Mozambique, and an annotated checklist of the southern Afromontane archipelago. *Herpetol. Rev.* 44, 394–406.
- Poynton, J.C., Boycott, R.C., 1996. Species turnover between Afromontane and eastern African lowland faunas: patterns shown by amphibians. *J. Biogeogr.* 23, 669–680. doi:10.1111/j.1365-2699.1996.tb00027.x
- Sepulchre, P., Ramstein, G., Fluteau, F., Schuster, M., Tiercelin, J.-J., Brunet, M., 2006. Tectonic Uplift and Eastern Africa Aridification. *Science* (80-. ). 313, 1419–1423.
- Silva, H.R. da, Carvalho, A.L.G. de, Bittencourt-Silva, G.B., 2008. Frogs of Marambaia: a naturally isolated Restinga and Atlantic Forest remnant of southeastern Brazil. *Biota Neotrop.* 8, 0–0. doi:10.1590/S1676-06032008000400017
- Stanley, W.T., Esselstyn, J.A., 2010. Biogeography and diversity among montane populations of mouse shrew (Soricidae: *Myosorex*) in Tanzania. *Biol. J. Linn. Soc.* 100, 669–680. doi:10.1111/j.1095-8312.2010.01448.x
- Stanley, W.T., Olson, L.E., 2005. Phylogeny, phylogeography, and geographic variation of *Sylvisorex howelli* (Soricidae), an endemic shrew of the Eastern Arc Mountains, Tanzania. *J. Zool.* 266, 341–354. doi:10.1017/S0952836905007016
- Sukumaran, J., Knowles, L.L., 2017. Multispecies coalescent delimits structure, not species. *Proc. Natl. Acad. Sci.* 201607921. doi:10.1073/pnas.1607921114
- Timberlake, J.R., Dowsett-Lemaire, F., Bayliss, J., Alves, T., Baena, S., Bento, C., Cook, K., Francisco, J., Harris, T., Smith, P., others, 2009. Mt Namuli, Mozambique: biodiversity and conservation. *Rep. Darwin Initiat. Award* 15, 36.
- Tolley, K.A., Chase, B.M., Forest, F., 2008. Speciation and radiations track climate transitions since the Miocene Climatic Optimum: a case study of southern African chameleons. *J. Biogeogr.* 35, 1402–1414. doi:10.1111/j.1365-2699.2008.01889.x
- Tolley, K.A., Tilbury, C.R., Measey, G.J., Menegon, M., Branch, W.R., Matthee, C.A., 2011. Ancient forest fragmentation or recent radiation? Testing refugial speciation models in chameleons within an African biodiversity hotspot. *J. Biogeogr.* 38, 1748–1760. doi:10.1111/j.1365-2699.2011.02529.x
- Van Noort, S., Gardiner, A.J., Tolley, K.A., 2007. New records of *Ficus* (Moraceae) species emphasize the conservation significance of inselbergs in Mozambique, South African *Journal of Botany.* doi:10.1016/j.sajb.2007.04.063
- Verdade, V.K., Rodrigues, M.T., 2008. On the Identity of *Cycloramphus jordanensis* Heyer,

1983 (Anura: Cycloramphidae). *Herpetologica* 64, 452–457. doi:10.1655/08-011R2.1

White, F., 1983. *The vegetation of Africa*. Paris:Unesco.

# ACKNOWLEDGEMENTS

I am immensely grateful for the support I have received from colleagues, friends and family throughout my PhD. From the beginning to the end of this study I have encountered numerous challenges that helped me grow as a scientist and as a person.

I really appreciate the great opportunity that was given to me by my supervisor and friend Dr. Simon Loader. Thank you introducing me to African biogeography. You have encouraged me when needed and allowed me to explore my own ideas. I cannot leave out that fieldwork in Africa can (many times) be stressful and dangerous so it is vital to keep the spirit up. Thank you Simon sharing that awful journey back to Tanzania with me and for making me laugh on the way. You saved that day!

Thank you Prof. Peter Nagel for accepting me in your group and for sharing with me your vast knowledge of Africa and biogeography.

I would like to thank all my colleagues at the Biogeography group, especially Chris Liedtke, Reto Hagmann, Beryl Bwong, Chris Barratt, Robert Tropek, Jan Beck, Julian Hafner, Aleksandra Obrist, Stefan Leiser, Tobias Heini. Thank you Dr. Stefanie von Fumetti for your help. Ruth Kirmser, thank you for the coffees during lab work and for all the times you have helped me. Thank you all my friends and colleagues from 3<sup>rd</sup> and 4<sup>th</sup> floors of Klingelbergstrasse 27 (and the Botany Department) for making my life in Basel so joyful. You guys are amazing! A special thanks goes to my great friends from Mordor, Vladimir Wingate, Juliane Krenz, Brice Prudat.

I am also grateful to Krystal A. Tolley and Michelle Menegon who part funded my fieldwork in Mozambique and were excellent companions in the field. Big thanks to my other fieldwork colleagues Werner Conradie, Hanlie Engelbrecht and Mike Scott. It was a great experience! I would like to thank Richard Smith for funding my fieldwork in Zambia and, Hitoshi Takano, Lydia Smith and Lucia Chmurova for companionship on that campaign. Thank are due to André Luiz G. de Carvalho and Dave Gower for insightful comments and fruitful discussions over the years. I also want to thank my co-authors for their contributions with tissues and comments. I especially thank Lucinda Lawson for helping me with some tricky analyses. My sincere thanks go to Prof. Walter Salzburger for his friendship and unwavering support.

I thank Stefan Lötters for reading and opposing my thesis, and Prof. Eberhard Parlow for chairing my defence.

Thank you to my family who supported me at all times. And finally, last but by no means least, thank you Mark Wilkinson, my best friend and husband (!), for standing by my side all these years and for helping to grow as a scientist and as person.

### **Funding**

This PhD was funded by the Swiss Government and the Freiwilligen Akademischen Gesellschaft Basel.

# SUPPLEMENTARY MATERIALS

Chapter I

Appendix A

Appendix B

Appendix C

Appendix A

**TABLE S1. Specimens data and GenBank accession numbers for the *Nothophryne* sequences generated in the present study.** Mozambique (MZ); Malawi (MW); Mount (Mt). Collections: (HF) Universidade Lúrio; (WC and PEM) Port Elisabeth Museum; (QQ) South African Institute of Biodiversity, (NA) not available.

N° Tissue sample	Collection N° / Field N°	Locality	Latitude	Longitude	12S	16S	RAG1	RHOD
AC769	NA	Mt Inago, MZ	-15.045000	37.396111	KU761268	KU761276	KU761284	KU761292
AC770	NA	Mt Namuli dome, MZ	-15.361540	37.072110	KU761269	KU761277	KU761285	KU761293
AC776	NA	Mt Namuli dome, MZ	-15.361540	37.072110	KU761270	KU761278	KU761286	KU761294
T5638	HF 21	Taratibu, MZ	-12.821783	39.686578	KU761271	KU761279	KU761287	KU761295
T5786	PEM A11343	Pese dome, Mt Namuli, MZ	-15.387418	37.031650	KU761272	KU761280	KU761288	KU761296
T5791	PEM A11320	Mt Namuli dome, MZ	-15.361540	37.072110	KU761273	KU761281	KU761289	KU761297
T5795	PEM A11369	Mt Ribáuè, MZ	-14.911860	38.316230	KU761274	KU761282	KU761290	KU761298
T6469	QQ 0710	Mt Mulanje, MW	-15.892307	35.614891	KU761275	KU761283	KU761291	KU761299

**TABLE S2. Primers used in this study.**

Gene	Primer	Study/Source
12S	12S L1091: AAAAAGCTTCAAACCTGGGATTAGATACCCCACTAT	Kosher et al., 1989
	12S H1478: TGA CTGCAGAGGGTGACGGGCGGTGTGT	Kosher et al., 1989
16S	16S H3062: CCGGTTTGA ACTCAGATCA	16sbr-H modified Palumbi et al., 1991
	16SB FROG: CGCCTGTTACCAAAAACAT	16sar-L modified Palumbi et al., 1991
RAG1	RAG1.Mart.FL1: AGCTGCAGYCARTAYCAYAARATGTA	Pramuk et al., 2008
	RAG1.AMP.R1: AACTCAGCTGCATTKCCAATRTCA	Pramuk et al., 2008
RHOD	Rhod-1A: ACCATGAACGGAACAGAAGGYCC	Bossuyt and Milinkovitch, 2000
	Rhod-1D: GTAGCGAAGAARCCTTCAAMGTA	Bossuyt and Milinkovitch, 2000

**TABLE S3. PCR protocols.**

Gene	Annealing temperature	Time	Cycles
12S	51°C	1 min	35
16S	51°C	1 min	35
RAG1	50°C	25 s	45
RHOD	51°C	1 min	35

**References**

- Bossuyt, F., Milinkovitch, M.C. 2000. Convergent adaptive radiations in Madagascan and Asian ranid frogs reveal covariation between larval and adult traits. *Proc. Nat. Acad. Sci. USA*, 97, 6585–6590.
- Kocher, T.D., Thomas, W.K., Meyer, A., Edwards, S.V., Pääbo, S., Villablanca, F.X. and Wilson, A.C., 1989. Dynamics of mitochondrial DNA evolution in animals: amplification and sequencing with conserved primers. *Proc. Nat. Acad. Sci., USA*, 86, 6196-6200.
- Palumbi, S.R., Martin, A., Romano, S., McMillan, W.O., Stice, L., Grabowski, G. 1991. *The simple fool's guide to PCR*. Department of Zoology and Kewalo Marine Laboratory, Hawai, 47 pp.
- Pramuk, J.B., Robertson, T., Sites Jr., J.W. Nooan, B.P. 2008. Around the world in 10 million years: biogeography of the nearly cosmopolitan true toads (Anura: Bufonidae). *Global Ecol. Biogeogr.*, 17, 72–8.



Appendix B

**TABLE S1. GenBank accession numbers for the species included in the phylogenetic analysis of *Nothophryne broadleyi*.** Sequences added to the original alignment from Siu-Ting et al. (2014) are marked in bold. Previous names are those used in Siu-Ting et al. (2014).

Species	Previous name	12S	16S	RAG1	RHOD
" <i>Hylarana</i> " <i>lateralis</i>	<i>Rana lateralis</i>	AF206098	AF206479	EF088273	-
" <i>Hylarana</i> " <i>latouchii</i>	<i>Rana latouchii</i>	AB058862	AB058880	-	-
" <i>Theلودerma</i> " <i>moloch</i>	<i>Theلودerma moloch</i>	GQ285679	GQ285679	GQ285753	GQ285782
<i>Abavorana luctuosa</i>	<i>Rana luctuosa</i>	<b>KF477635</b>	DQ861315	-	-
<i>Acanthixalus sonjae</i>		-	AF465437	-	-
<i>Acanthixalus spinosus</i>		AF215214	AF215427	-	-
<i>Afrixalus delicatus</i>		AF215215	AF215428	-	-
<i>Afrixalus dorsalis</i>		DQ347002	DQ347296	DQ347236	DQ347355
<i>Afrixalus forasini</i>		DQ283401	DQ283401	-	DQ284013
<i>Afrixalus knysnae</i>		AF215216	AF215429	-	-
<i>Afrixalus laevis</i>		AF215217	AF215430	-	-
<i>Afrixalus paradorsalis</i>		FJ151068	FJ151068	-	-
<i>Afrixalus stuhlmanni</i>		DQ283233	DQ283234	-	-
<i>Aglyptodactylus laticeps</i>		AY454349	AF215329	-	-
<i>Aglyptodactylus madagascariensis</i>		DQ346997	AB325874	AY571640	DQ283785
<i>Alcalus baluensis</i>	<i>Ingerana baluensis</i>	DQ347044	DQ283142	DQ347270	DQ283843
<i>Alexteroon obstetricans</i>		-	DQ283344	-	DQ283864
<i>Amietia angolensis</i>		DQ347029	DQ347318	DQ347257	DQ347377
<i>Amietia fuscigula</i>		DQ347065	DQ283069	DQ347290	DQ283794
<i>Amietia vertebralis</i>		DQ283402	AY255097	<b>FJ411449</b>	-
<i>Amnirana albolabris</i>		DQ022317	DQ283369	<b>KR264435</b>	DQ283989
<i>Amnirana galamensis</i>		DQ347032	DQ283058	DQ347260	AY322238
<i>Amnirana lepus</i>		DQ019584	AY014377	AY571641	<b>DQ019561</b>
<i>Amnirana nicobariensis</i>	<i>Hylarana nicobariensis</i>	AY326062	AY326062	DQ347274	DQ347393
<i>Amolops archotaphus</i>	<i>Rana archotaphus</i>	-	<b>FJ417125</b>	EF088234	-
<i>Amolops bellulus</i>		DQ204429	DQ204473	<b>FJ417267</b>	-
<i>Amolops chungangensis</i>		AB211454	DQ204476	-	-
<i>Amolops compotrix</i>	<i>Rana compotrix</i>	-	FJ417142	EF088235	-
<i>Amolops cremnobatus</i>		AB211460	AF206458	EF088236	-
<i>Amolops cucae</i>	<i>Rana cucae</i>	-	FJ417146	EF088237	-
<i>Amolops daiyunensis</i>		AB211451	DQ204479	-	-
<i>Amolops daorum</i>	<i>Rana daorum</i>	AF206101	AF206482	EF088238	-
<i>Amolops granulosis</i>		AB211458	DQ204480	-	-
<i>Amolops hainanensis</i>		EF453725	DQ204481	DQ019495	-
<i>Amolops hongkongensis</i>		AF206072	AF206453	-	-
<i>Amolops iriodes</i>	<i>Rana iriodes</i>	-	FJ417154	EF088239	-
<i>Amolops jinjiangensis</i>		EF453726	EF453741	-	-
<i>Amolops kangtingensis</i>		EF453727	EF453742	-	-
<i>Amolops larutensis</i>		DQ347053	EU604191	DQ347279	DQ347398
<i>Amolops liangshanensis</i>		EF453728	EF453743	-	-
<i>Amolops lifanensis</i>		DQ359981	DQ204482	-	DQ360034
<i>Amolops loloensis</i>		AF206112	AF206493	-	DQ360008
<i>Amolops mantzorum</i>		DQ359970	DQ204484	EF088240	DQ360023
<i>Amolops marmoratus</i>		AB211463	DQ204485	EF088241	-
<i>Amolops panhai</i>		AB211465	AB211487	-	-
<i>Amolops ricketti</i>		AB211452	AF206454	EF088242	DQ360009
<i>Amolops spinasectoralis</i>		AF206076	AF206457	EF088243	-
<i>Amolops torrentis</i>		EF453729	EF453744	-	-
<i>Amolops viridimaculatus</i>		AB211457	DQ204490	-	-
<i>Amolops vitreus</i>	<i>Rana vitrea</i>	-	FJ417165	EF088244	-
<i>Amolops wuyiensis</i>		AB211453	DQ204491	<b>KP191587</b>	<b>KP191584</b>
<i>Anhydrophryne rattrayi</i>		DQ022319	AF215504	<b>HQ014429</b>	-

SUPPLEMENTARY MATERIALS: CHAPTER I

Species	Previous name	12S	16S	RAG1	RHOD
<i>Anodonthyla bouleengerii</i>		EU341091	EU341091	EF396072	-
<i>Anodonthyla hutchisoni</i>		<b>GU177074</b>	FJ559110	-	-
<i>Anodonthyla montana</i>		EU341088	EU341088	EF396071	-
<i>Anodonthyla moramora</i>		EU341090	EU341090	-	-
<i>Anodonthyla nigrigularis</i>		EU341089	EU341089	-	-
<i>Anodonthyla rouxae</i>		EU341086	EU341086	-	-
<i>Aphantophryne pansa</i>		DQ283195	DQ283195	-	DQ283879
<i>Arthroleptella bicolor</i>		DQ283070	AY205285	-	DQ283795
<i>Arthroleptella drewesii</i>		AY453276	AY454341	-	-
<i>Arthroleptella landdrosia</i>		AF330244	AY205276	-	-
<i>Arthroleptella lightfooti</i>		AF330242	AY205282	<b>HQ014425</b>	<b>HQ014442</b>
<i>Arthroleptella subvoce</i>		AY205267	AY454343	-	-
<i>Arthroleptella villiersi</i>		DQ347062	DQ347344	DQ347287	DQ347408
<i>Arthroleptides martiensseni</i>	<i>Petropedetes martiensseni</i>	DQ347064	DQ347346	DQ347289	DQ347410
<i>Arthroleptides yakusini</i>		DQ283415	DQ283415	<b>KF693621</b>	-
<i>Arthroleptis adelphus</i>		FJ151141	FJ151141	-	-
<i>Arthroleptis affinis</i>		FJ151155	FJ151154	-	-
<i>Arthroleptis aureoli</i>		FJ151118	EF640990	-	-
<i>Arthroleptis francei</i>		FJ151101	FJ151101	-	-
<i>Arthroleptis krokosua</i>		-	EU350211	-	-
<i>Arthroleptis nikeae</i>		FJ151160	FJ151160	-	-
<i>Arthroleptis poecilnotus</i>		FJ151114	FJ151053	-	-
<i>Arthroleptis reichei</i>		FJ151161	FJ151161	-	-
<i>Arthroleptis schubotzi</i>		DQ347006	FJ151116	DQ347238	DQ283910
<i>Arthroleptis stenodactylus</i>		FJ151099	DQ022343	-	-
<i>Arthroleptis sylvaticus</i>		DQ022314	DQ022349	-	DQ283801
<i>Arthroleptis taeniatus</i>		DQ283232	DQ283232	-	DQ283907
<i>Arthroleptis tanneri</i>		DQ022308	FJ151056	-	DQ284028
<i>Arthroleptis variabilis</i>		DQ347003	FJ151091	AY364210	AY322226
<i>Arthroleptis wahlbergii</i>		FJ151052	FJ151052	-	-
<i>Arthroleptis xenodactyloides</i>		FJ151103	FJ151103	-	DQ284030
<i>Arthroleptis xenodactylus</i>		FJ151157	FJ151156	-	-
<i>Asterophrys turpicola</i>		EU100110	EU100226	EF396074	-
<i>Astylosternus batesi</i>		FJ151071	FJ151071	-	-
<i>Astylosternus diadematus</i>		DQ022309	AY341691	-	AY341810
<i>Astylosternus schioetzi</i>		DQ283349	AF124108	-	DQ283976
<i>Aubria subsigillata</i>		DQ283350	DQ283173	<b>KF991337</b>	DQ283865
<i>Babina adenopleura</i>	<i>Rana adenopleura</i>	DQ359957	DQ283117	-	DQ283829
<i>Babina chapaensis</i>	<i>Rana chapaensis</i>	AF206079	AF206460	EU076752	DQ283987
<i>Babina holsti</i>	<i>Rana holsti</i>	AY043047	AY147943	-	-
<i>Babina okinavana</i>	<i>Rana okinavana</i>	AB058861	AB058879	-	-
<i>Babina pleuraden</i>	<i>Rana pleuraden</i>	DQ359958	DQ359989	-	DQ360011
<i>Barygenys exsul</i>		EU100119	EU100235	-	-
<i>Barygenys flavigularis</i>		-	AY948767	AY948943	-
<i>Blommersia blommersae</i>		AY341584	AF317688	-	AY341770
<i>Blommersia domerguei</i>		AY341582	AY341636	<b>JF314332</b>	AY341768
<i>Blommersia grandisonae</i>		AF215149	AY341640	-	AY341771
<i>Blommersia kely</i>		AY341583	AY341637	-	AY341769
<i>Blommersia sarotra</i>		AY341588	AY341643	-	<b>AY341773</b>
<i>Blommersia wittei</i>		AY880536	AY880490	AY323774	AY880667
<i>Boehmantis microtypanum</i>		DQ235455	DQ235451	-	DQ235445
<i>Boophis albilabris</i>		DQ283033	DQ283033	-	DQ283762
<i>Boophis boehmei</i>		AY341612	DQ792471	<b>HQ380172</b>	AY341798
<i>Boophis doulioti</i>		AY341608	AY341663	AY571643	AY341792
<i>Boophis goudotii</i>		AY341611	GU205768	-	AY341797
<i>Boophis idae</i>		AY341609	AY341666	-	AY341795
<i>Boophis luteus</i>		AY341614	AF261265	-	AY341800
<i>Boophis madagascariensis</i>		AF261248	AF261266	-	-

## SUPPLEMENTARY MATERIALS: CHAPTER I

Species	Previous name	12S	16S	RAG1	RHOD
<i>Boophis marojezensis</i>		AY341617	AY341674	<b>JX863583</b>	AY341803
<i>Boophis microtympanum</i>		AY341613	AY341670	-	AY341799
<i>Boophis occidentalis</i>		AY341620	AY341677	-	AY341806
<i>Boophis pauliani</i>		-	EF100469	-	EF100482
<i>Boophis rappiodes</i>		AY341618	AY341675	-	AY341804
<i>Boophis sibilans</i>		AY341615	AY341672	-	AY341801
<i>Boophis tephraeomystax</i>		DQ347000	DQ283032	DQ347234	AF249105
<i>Boophis viridis</i>		AY341619	AY341676	-	AY341805
<i>Boophis vittatus</i>		AY341616	AY341673	-	AY341802
<i>Boophis xerophilus</i>		DQ346999	AF249038	AY364209	-
<i>Breviceps fichus</i>		AY787035	-	-	-
<i>Breviceps fuscus</i>		DQ019578	AF215365	EF396075	-
<i>Breviceps mossambicus</i>		DQ283155	EF017947	EF396076	DQ284023
<i>Buergeria buergeri</i>		AY880478	AY880444	AY948921	AY880623
<i>Buergeria japonica</i>		DQ283055	AY880491	GQ285754	AY880624
<i>Buergeria oxycephalus</i>		<b>EU215524</b>	<b>AF458124</b>	GQ285758	EU215556
<i>Buergeria robusta</i>		U22083	AF026370	-	-
<i>Cacosternum boettgeri</i>		DQ347007	DQ347299	AY571645	DQ347358
<i>Cacosternum capense</i>		DQ022323	DQ022354	-	-
<i>Cacosternum nanum</i>		DQ022321	DQ022353	-	-
<i>Callulina kisiwamsitu</i>		DQ283429	DQ283429	-	-
<i>Callulina krefftii</i>		DQ347056	AY326068	EF396077	DQ347400
<i>Callulops robustus</i>		EU100135	EU100251	-	-
<i>Cardioglossa elegans</i>		FJ151072	FJ151072	-	-
<i>Cardioglossa gracilis</i>		DQ022310	DQ022345	-	-
<i>Cardioglossa gratiosa</i>		DQ283176	DQ283176	-	DQ283868
<i>Cardioglossa leucomystax</i>		FJ151122	AF124110	-	DQ283982
<i>Cardioglossa manengouba</i>		FJ151149	FJ151149	-	-
<i>Cardioglossa occidentalis</i>		FJ151115	FJ151115	-	-
<i>Cardioglossa oreas</i>		FJ151137	FJ151137	-	-
<i>Cardioglossa pulchra</i>		FJ151135	FJ151134	-	-
<i>Cardioglossa schioetzi</i>		FJ151136	FJ151136	-	-
<i>Chalcorana chalconota</i>	<i>Rana chalconota</i>	AB200932	DQ283139	DQ347220	AY322232
<i>Chalcorana eschatia</i>	<i>Rana eschatia</i>	-	EF487514	-	-
<i>Chalcorana labialis</i>	<i>Rana labialis</i>	-	EF487522	-	-
<i>Chalcorana megalonesa</i>	<i>Rana megalonesa</i>	<b>KF477629</b>	EF487497	-	-
<i>Chalcorana mocquardi</i>	<i>Rana mocquardii</i>	-	EF487530	EF088275	-
<i>Chalcorana parvaccola</i>	<i>Rana parvaccola</i>	-	EF487450	-	-
<i>Chalcorana raniceps</i>	<i>Rana raniceps</i>	-	DQ835337	-	-
<i>Chaperina fusca</i>		<b>AB781451</b>	DQ283145	-	-
<i>Chiasmocleis hudsoni</i>		<b>JF836937</b>	EU201100	EF396079	<b>JF837039</b>
<i>Chiasmocleis shudikarensis</i>		-	<b>KM509113</b>	EF396080	-
<i>Chiromantis doriae</i>		<b>AB813159</b>	<b>KC357618</b>	EU924511	DQ347379
<i>Chiromantis marginis</i>	<i>Chiromantis vittatus</i>	AY880579	AY880493	EU924512	AY880626
<i>Chiromantis rufescens</i>		DQ347004	AF458126	DQ347237	DQ347356
<i>Chiromantis xerampelina</i>		AY880540	AY880495	-	DQ284012
<i>Choerophryne laurini</i>	<i>Albericus laurini</i>	EU100107	EU100222	-	-
<i>Choerophryne rostellifer</i>		EU100138	EU100254	-	-
<i>Clinotarsus alticola</i>	<i>Rana alticola</i>	AB200937	AB200961	EU076751	-
<i>Clinotarsus curtipes</i>	<i>Rana curtipes</i>	DQ346968	GU136111	DQ347209	AF249117
<i>Conraua crassipes</i>		DQ347015	DQ347305	DQ347244	DQ347364
<i>Conraua goliath</i>		DQ022325	DQ283132	<b>KF693604</b>	DQ283833
<i>Conraua robusta</i>		DQ283347	DQ283347	<b>KF693605</b>	DQ283973
<i>Cophixalus balbus</i>		EU100146	EU100262	-	-
<i>Cophixalus humicola</i>		EU100148	EU100264	-	-
<i>Cophixalus sphagnicola</i>		DQ283206	DQ283206	-	-
<i>Cophixalus tridactylus</i>		EU100150	EU100267	-	-
<i>Cophyla barbouri</i>	<i>Platypelis barbouri</i>	EU341097	EU341097	-	-

SUPPLEMENTARY MATERIALS: CHAPTER I

Species	Previous name	12S	16S	RAG1	RHOD
<i>Cophyla berara</i>		EU341113	EU341113	-	-
<i>Cophyla grandis</i>	<i>Platypelis grandis</i>	EU341099	EU341099	EF396101	-
<i>Cophyla mavomavo</i>	<i>Platypelis mavomavo</i>	-	FJ559285	-	-
<i>Cophyla milloti</i>	<i>Platypelis milloti</i>	EU341094	EU341094	-	-
<i>Cophyla phyllodactyla</i>		EU341112	EU341112	EU341122	-
<i>Cophyla pollicaris</i>	<i>Platypelis pollicaris</i>	EU341098	EU341098	-	-
<i>Cophyla tuberifera</i>	<i>Platypelis tuberifera</i>	EU341093	EU341093	-	-
<i>Copiula derongo</i>	<i>Austrochaperina derongo</i>	EU100116	EU100232	-	-
<i>Copiula major</i>		EU100153	EU100269	-	-
<i>Copiula obsti</i>		EU100156	EU100273	-	-
<i>Copiula pipiens</i>		EU100158	EU100274	-	-
<i>Cornufer bimaculatus</i>	<i>Platymantis bimaculatus</i>	EU004640	-	-	-
<i>Cornufer cryptotis</i>	<i>Platymantis cryptotis</i>	EU004634	-	-	-
<i>Cornufer guentheri</i>	<i>Ceratobatrachus guentheri</i>	DQ347046	DQ283198	DQ019496	DQ347391
<i>Cornufer guppyi</i>	<i>Discodeles guppyi</i>	DQ283200	DQ283200	-	DQ283883
<i>Cornufer papuensis</i>	<i>Platymantis papuensis</i>	DQ347042	DQ347326	DQ347268	DQ347387
<i>Cornufer pelewensis</i>	<i>Platymantis pelewensis</i>	DQ283104	DQ283104	-	DQ283819
<i>Cornufer punctatus</i>	<i>Platymantis punctatus</i>	EU004650	-	-	-
<i>Cornufer vertebralis</i>	<i>Batrachylodes vertebralis</i>	DQ283210	DQ283210	-	DQ283891
<i>Cornufer vitiensis</i>	<i>Platymantis vitiensis</i>	<b>KM247363</b>	Y11978	-	-
<i>Cornufer weberi</i>	<i>Platymantis weberi</i>	DQ283196	DQ283196	-	DQ283880
<i>Cornufer wuenscheorum</i>	<i>Platymantis wuenscheorum</i>	EU004642	-	-	-
<i>Cryptothylax greshoffii</i>		FJ594102	DQ283170	-	DQ283863
<i>Ctenophryne aequatorialis</i>	<i>Nelsonophryne aequatorialis</i>	AY326067	AY326067	-	-
<i>Ctenophryne geayi</i>		DQ283383	DQ283383	-	-
<i>Dasylops schirchi</i>		DQ283095	DQ283095	-	DQ283811
<i>Dermatonotus muelleri</i>		DQ283329	DQ283330	EF396082	-
<i>Dyscophus antongilii</i>		EU341120	EU341120	EF396084	<b>DQ019558</b>
<i>Dyscophus guineti</i>		DQ283434	DQ283434	-	-
<i>Dyscophus insularis</i>		EU341119	EU341119	EF396083	-
<i>Elachistocleis ovalis</i>		DQ347057	DQ283405	EF396085	DQ347401
<i>Ericabatrachus baleensis</i>		KF938362	KF938365	KF938370	-
<i>Euphlyctis cyanophlyctis</i>		DQ346962	AY014366	DQ347205	AF249111
<i>Euphlyctis ehrenbergii</i>		-	AY014367	-	-
<i>Euphlyctis hexadactylus</i>		AB273172	AF215389	-	-
<i>Feihyla palpebralis</i>		<b>GQ285681</b>	<b>JQ621936</b>	EU924513	EU215576
<i>Fejervarya cancrivora</i>		EU435300	EU979849	<b>HM163581</b>	DQ458259
<i>Fejervarya caperata</i>		AB355830	AB355845	<b>AB488946</b>	<b>AB489031</b>
<i>Fejervarya granosa</i>		AB355826	AB355838	<b>AB488947</b>	<b>AB489032</b>
<i>Fejervarya greenii</i>		-	AY014378	<b>AB488944</b>	<b>AB489029</b>
<i>Fejervarya iskandari</i>		AB277287	AB277303	<b>AB488954</b>	<b>AB489021</b>
<i>Fejervarya kirtisinghei</i>		<b>AB488867</b>	AY014380	<b>AB488943</b>	-
<i>Fejervarya kudremukhensis</i>		AB355828	AB355841	<b>AB488950</b>	<b>AB489035</b>
<i>Fejervarya limnocharis</i>		AB277282	AF206466	<b>HM163580</b>	DQ458271
<i>Fejervarya mudduraja</i>		AB355822	AB355835	<b>AB488948</b>	<b>AB489033</b>
<i>Fejervarya orissaensis</i>		AB277289	AB277304	<b>AB500222</b>	<b>AB500259</b>
<i>Fejervarya rufescens</i>		AB167917	AB167945	<b>AB488949</b>	<b>AB489034</b>
<i>Fejervarya syhadrensis</i>		DQ346960	AY141843	DQ347203	AF249107
<i>Fejervarya triora</i>		-	DQ860095	<b>AB488939</b>	<b>AB489022</b>
<i>Fejervarya vittigera</i>		AY313683	AY313683	-	-
<i>Gastrophryne carolinensis</i>		AY819349	X86278	EF396086	-
<i>Gastrophryne elegans</i>		DQ283426	<b>JQ268517</b>	-	-
<i>Gastrophryne olivacea</i>		DQ347055	AY326066	DQ347280	DQ283932
<i>Genyophryne thomsoni</i>		DQ283209	DQ283209	-	DQ283890
<i>Gephyromantis ambohitra</i>		<b>JN664354</b>	DQ987512	-	-
<i>Gephyromantis asper</i>		AY341598	AY454378	<b>JN664487</b>	AY341783
<i>Gephyromantis azzurrae</i>		<b>JN664387</b>	EF222305	-	-
<i>Gephyromantis blanci</i>		<b>JN664385</b>	AY848324	<b>JN936076</b>	-

SUPPLEMENTARY MATERIALS: CHAPTER I

Species	Previous name	12S	16S	RAG1	RHOD
<i>Gephyromantis boulengeri</i>		DQ901389	DQ235450	<b>KR537836</b>	<b>DQ901396</b>
<i>Gephyromantis cornutus</i>		AY454358	AY454381	<b>JN664482</b>	EF100483
<i>Gephyromantis corvus</i>		AF215161	AF215320	-	-
<i>Gephyromantis decaryi</i>		<b>JN664380</b>	AY848332	<b>JN936072</b>	-
<i>Gephyromantis eiselti</i>		<b>JN664379</b>	FJ559165	<b>JN936045</b>	-
<i>Gephyromantis enki</i>		<b>JN664378</b>	AY848333	<b>KR537866</b>	-
<i>Gephyromantis granulatus</i>		AY341594	AY341649	<b>JN664475</b>	AY341779
<i>Gephyromantis horridus</i>		AY341596	AY454385	<b>JN664474</b>	AY341781
<i>Gephyromantis klemmeri</i>		AY454363	AY454386	-	<b>JN132835</b>
<i>Gephyromantis leucocephalus</i>		<b>JN664377</b>	FJ559171	<b>JN936081</b>	-
<i>Gephyromantis leucomaculatus</i>		<b>JN664376</b>	AY848352	-	-
<i>Gephyromantis luteus</i>		<b>JN664375</b>	AJ314800	-	-
<i>Gephyromantis malagasius</i>		AY454365	AY454390	<b>JN664469</b>	EF100484
<i>Gephyromantis moseri</i>		<b>JN664374</b>	AY848414	-	-
<i>Gephyromantis plicifer</i>		<b>JN664373</b>	AY848420	-	-
<i>Gephyromantis pseudoasper</i>		DQ926892	DQ926891	<b>JN664466</b>	DQ926893
<i>Gephyromantis redimitus</i>		AY341593	AF261259	<b>JN664465</b>	AY341778
<i>Gephyromantis rivicola</i>		DQ901388	DQ235449	-	<b>DQ901395</b>
<i>Gephyromantis salegy</i>		<b>JN664371</b>	AY848425	-	-
<i>Gephyromantis sculpturatus</i>		AY341597	AY341652	<b>JN664460</b>	AY341782
<i>Gephyromantis silvanus</i>		<b>EF100479</b>	EF100472	-	EF100485
<i>Gephyromantis striatus</i>		AY341595	AY341650	<b>JN664447</b>	AY341780
<i>Gephyromantis tandroka</i>		<b>JN664359</b>	FJ559199	-	-
<i>Gephyromantis tschenki</i>		<b>JN664357</b>	GU975156	-	-
<i>Gephyromantis ventrimaculatus</i>		<b>JN664356</b>	FJ559200	-	-
<i>Gephyromantis webbi</i>		-	DQ235448	-	-
<i>Gephyromantis zavona</i>		<b>JN664355</b>	AJ315925	-	-
<i>Ghatixalus variabilis</i>		EU178099	EU178092	-	-
<i>Glandirana emeljanovi</i>	<i>Rana emeljanovi</i>	AF205561	AF315155	-	AY322218
<i>Glandirana minima</i>	<i>Rana minima</i>	DQ359968	AF315153	-	DQ360021
<i>Glandirana rugosa</i>	<i>Rana rugosa</i>	AB430352	AB430352	-	-
<i>Glandirana tientaiensis</i>	<i>Rana tientaiensis</i>	DQ359954	DQ359985	-	DQ360007
<i>Glyphoglossus guttulatus</i>	<i>Calluella guttulata</i>	DQ283144	DQ283144	EF396078	DQ283845
<i>Glyphoglossus molossus</i>		AB201182	AB201193	EF396087	-
<i>Gracixalus carinensis</i>	<i>Philautus carinensis</i>	AY880549	AY880503	-	GQ285788
<i>Gracixalus gracilipes</i>		AY880550	AY880504	GQ285764	DQ283780
<i>Gracixalus jinxiuensis</i>	<i>Kurixalus jinxiuensis</i>	-	EU215525	GQ285763	EU924543
<i>Gracixalus quyeti</i>	<i>Philautus quyeti</i>	-	EU871429	-	-
<i>Guibemantis albolineatus</i>		AY341580	AY454376	-	AY341766
<i>Guibemantis bicalcaratus</i>		EF468023	EF472522	<b>JX535534</b>	DQ235443
<i>Guibemantis depressiceps</i>		AY341590	AY341645	-	AY341775
<i>Guibemantis liber</i>		EF468028	EF472527	-	AY341774
<i>Guibemantis tornieri</i>		AY454369	AY454394	-	-
<i>Hamptophryne boliviana</i>		DQ283438	DQ283438	EF396088	-
<i>Hemisis marmoratus</i>		DQ347033	DQ283430	AY364216	DQ347380
<i>Heterixalus alboguttatus</i>		EF646724	AF215433	-	<b>EF646539</b>
<i>Heterixalus andrakata</i>		EF646715	EF646680	EF646563	<b>EF646530</b>
<i>Heterixalus betsileo</i>		EF646707	AF215503	EF646555	<b>EF646518</b>
<i>Heterixalus boettgeri</i>		EF646725	EF646690	-	<b>EF646540</b>
<i>Heterixalus carbonei</i>		EF646726	EF646656	-	-
<i>Heterixalus luteostriatus</i>		EF646720	AF215436	EF646568	<b>EF646535</b>
<i>Heterixalus madagascariensis</i>		EF646717	EF646682	EF646565	<b>EF646532</b>
<i>Heterixalus punctatus</i>		EF646718	FJ594071	EF646566	<b>EF646520</b>
<i>Heterixalus rutenbergi</i>		EF646708	EF646638	EF646556	<b>EF646517</b>
<i>Heterixalus tricolor</i>		EF646728	EF646693	AY323768	<b>EF646525</b>
<i>Heterixalus variabilis</i>		EF646723	EF646649	EF646552	<b>EF646538</b>
<i>Hildebrandtia ornata</i>		AF261243	AF261261	<b>KF991335</b>	-
<i>Hoplobatrachus crassus</i>		DQ346972	AF249044	DQ347211	AF249109

SUPPLEMENTARY MATERIALS: CHAPTER I

Species	Previous name	12S	16S	RAG1	RHOD
<i>Hoplobatrachus occipitalis</i>		DQ346979	DQ283059	DQ347217	DQ283787
<i>Hoplobatrachus rugulosus</i>		DQ346985	AF206465	DQ347222	DQ458257
<i>Hoplobatrachus tigerinus</i>		AB290422	FJ008057	<b>AB488958</b>	<b>AB489039</b>
<i>Hoplophryne rogersi</i>		AY531857	DQ283419	EF396089	-
<i>Hoplophryne uluguruensis</i>		AY531858	AY531835	-	-
<i>Huia cavitympanum</i>		AB211466	AB211489	EF088246	-
<i>Huia masonii</i>		DQ347021	DQ347313	EF088247	DQ347372
<i>Huia melasma</i>		-	-	EF088248	-
<i>Huia sumatrana</i>		AB211468	AB211491	EF088249	-
<i>Humerana miopus</i>	<i>Rana miopus</i>	AB200938	EU604196	-	-
<i>Hydrophylax gracilis</i>	<i>Rana gracilis</i>	DQ019583	AY014376	DQ019499	-
<i>Hydrophylax malabaricus</i>	<i>Rana malabarica</i>	AB167908	AB167936	-	-
<i>Hylarana erythraea</i>	<i>Rana erythraea</i>	AF206094	AF206475	EF088268	AY322228
<i>Hylarana macrodactyla</i>	<i>Rana macrodactyla</i>	AF206108	AF206489	-	DQ360025
<i>Hylarana taipehensis</i>	<i>Rana taipehensis</i>	DQ283396	AF206495	-	DQ360036
<i>Hylophorbus nigrinus</i>		EU100160	EU100276	-	-
<i>Hylophorbus picoides</i>		EU100166	EU100282	-	-
<i>Hylophorbus rufescens</i>		<b>JX119263</b>	EF017958	EF018047	-
<i>Hylophorbus tetraphonus</i>		EU100173	EU100289	-	-
<i>Hylophorbus wondiwoi</i>		EU100177	EU100291	-	-
<i>Hyperolius acuticeps</i>		<b>JQ863600</b>	FJ594074	-	-
<i>Hyperolius argus</i>		X86239	AF215439	-	-
<i>Hyperolius baumanni</i>		-	FJ594075	-	-
<i>Hyperolius castaneus</i>		FJ151059	FJ151059	-	-
<i>Hyperolius chlorosteus</i>		-	FJ594076	-	-
<i>Hyperolius cinnamomeoventris</i>		AY603985	AY603985	-	-
<i>Hyperolius concolor</i>		-	FJ594078	-	-
<i>Hyperolius cystocandicans</i>		-	FJ594079	-	-
<i>Hyperolius discodactylus</i>	<i>Hyperolius alticola</i>	AY603984	DQ283225	-	DQ283902
<i>Hyperolius frontalis</i>		AY603986	AY603986	-	-
<i>Hyperolius fusciventris</i>		-	FJ594080	-	-
<i>Hyperolius glandicolor</i>		<b>AF282445</b>	FJ594081	-	-
<i>Hyperolius guttulatus</i>		AF494065	FJ594082	-	-
<i>Hyperolius horstockii</i>		AF282438	-	-	-
<i>Hyperolius kivuensis</i>		AF282437	GQ183575	-	-
<i>Hyperolius lateralis</i>		AF494070	AY323924	-	-
<i>Hyperolius marmoratus</i>		<b>AF282449</b>	FJ594084	-	-
<i>Hyperolius molleri</i>		AY603990	AY603990	-	-
<i>Hyperolius montanus</i>		-	FJ594085	-	-
<i>Hyperolius mosaicus</i>		-	AY323923	-	-
<i>Hyperolius nasutus</i>		AF215224	AF215442	-	-
<i>Hyperolius ocellatus</i>		AY603988	AY603988	-	-
<i>Hyperolius parallelus</i>	<i>Hyperolius angolensis</i>	AF282439	<b>JQ513622</b>	-	-
<i>Hyperolius pardalis</i>		AF494072	AY323922	-	-
<i>Hyperolius phantasticus</i>		-	FJ594088	-	-
<i>Hyperolius picturatus</i>		-	FJ594090	-	-
<i>Hyperolius puncticulatus</i>		DQ283389	DQ283390	-	-
<i>Hyperolius pusillus</i>		AF494073	-	-	-
<i>Hyperolius semidiscus</i>		AF215225	-	-	-
<i>Hyperolius thomensis</i>		DQ283231	DQ283231	<b>KJ865941</b>	DQ283906
<i>Hyperolius torrentis</i>		-	FJ594093	-	-
<i>Hyperolius tuberculatus</i>		-	AY323921	-	-
<i>Hyperolius tuberilinguis</i>		DQ283399	DQ283400	-	-
<i>Hyperolius viridiflavus</i>		AY330901	AF215440	AY323769	<b>AY323740</b>
<i>Hyperolius zonatus</i>		-	FJ594096	-	-
<i>Hypopachus variolosus</i>		<b>JF836907</b>	<b>KM509146</b>	EF396090	<b>JF837036</b>
<i>Indosylvirana aurantiaca</i>	<i>Rana aurantiaca</i>	AB167909	AB167937	-	-
<i>Indosylvirana milleti</i>	<i>Rana milleti</i>	AF206109	AF206490	-	-

## SUPPLEMENTARY MATERIALS: CHAPTER I

Species	Previous name	12S	16S	RAG1	RHOD
<i>Indosylvirana temporalis</i>	<i>Rana temporalis</i>	DQ346963	GU136113	DQ347206	AF249118
<i>Ingerana borealis</i>	<i>Occidozyga borealis</i>	-	DQ283236	-	DQ283909
<i>Ingerana tenasserimensis</i>		AY322308	AY322302	DQ347258	AY322236
<i>Kalophrynus baluensis</i>		-	EF017953	EF018042	-
<i>Kalophrynus intermedius</i>		-	EF017952	EF018041	-
<i>Kalophrynus pleurostigma</i>		DQ283146	DQ283146	AY948919	DQ283846
<i>Kaloula conjuncta</i>		AY326064	AY326064	-	-
<i>Kaloula pulchra</i>		AF315130	AF315162	EF396091	DQ284011
<i>Kaloula taprobanica</i>		DQ346970	AF249057	AY948915	AF249100
<i>Kassina maculata</i>		AF215229	AF215444	AY571651	-
<i>Kassina senegalensis</i>		FJ151067	AF215445	-	-
<i>Kurixalus banaensis</i>	<i>Philautus banaensis</i>	GQ285667	GQ285667	GQ285752	GQ285781
<i>Kurixalus bisacculus</i>	<i>Kurixalus hainanus</i>	<b>KC465810</b>	<b>KC465813</b>	GQ285749	EU215578
<i>Kurixalus eiffingeri</i>		AY880538	AY880492	-	AY880625
<i>Kurixalus idiootocus</i>		<b>AB933306</b>	<b>DQ283054</b>	GQ285751	DQ283783
<i>Kurixalus odontotarsus</i>		AY880553	AY880507	GQ285750	EU924538
<i>Laliostoma labrosum</i>		DQ346998	AB325875	AY948923	AF249106
<i>Lankanectes corrugatus</i>		DQ346971	AF215393	AY948916	AF249115
<i>Leptodactylodon bicolor</i>		DQ283364	DQ283364	<b>KF991325</b>	DQ283986
<i>Leptopelis argenteus</i>		U22075	DQ283226	-	DQ283903
<i>Leptopelis bocagii</i>		DQ283418	DQ283418	-	-
<i>Leptopelis brevirostris</i>		-	AY702652	-	-
<i>Leptopelis concolor</i>		U22079	-	-	-
<i>Leptopelis kivuensis</i>		DQ347005	FJ151060	AY364211	AY322214
<i>Leptopelis modestus</i>		AF215230	AJ437013	-	-
<i>Leptopelis natalensis</i>		AY341626	AY341692	AY571654	AY341811
<i>Leptopelis palmatus</i>		AY603992	AY603992	-	-
<i>Leptopelis vermiculatus</i>		DQ022312	DQ022347	-	-
<i>Limnonectes acanthi</i>		AY313724	AY313724	<b>JF744603</b>	-
<i>Limnonectes arathooni</i>		AY313744	AY313744	<b>JF744589</b>	-
<i>Limnonectes asperatus</i>		AF183127	HM067241	-	-
<i>Limnonectes bannaensis</i>		NC_012837	AY899242	<b>AB568580</b>	-
<i>Limnonectes blythii</i>		AF206082	AF206463	-	-
<i>Limnonectes dabanus</i>		AF206115	AF206496	-	-
<i>Limnonectes deinodon</i>	<i>Limnonectes laticeps</i>	AF183125	AB277306	-	<b>AB489041</b>
<i>Limnonectes finchi</i>		AY322306	AY322295	-	AY322230
<i>Limnonectes fragilis</i>		AY703867	AY703854	<b>HM163611</b>	DQ458270
<i>Limnonectes fujianensis</i>		AY703865	DQ118518	<b>HM163582</b>	DQ458260
<i>Limnonectes grunniens</i>		EU979643	U66125	-	DQ283885
<i>Limnonectes gyldestolpei</i>		AY880453	AY880440	-	-
<i>Limnonectes hascheanus</i>		AY880488	AY880449	-	-
<i>Limnonectes heinrichi</i>		AY313749	AY313749	<b>JF744600</b>	-
<i>Limnonectes ibanorum</i>		U66122	U66123	-	-
<i>Limnonectes ingeri</i>		U55268	U55275	-	-
<i>Limnonectes kadarsani</i>		AY313693	AY313693	-	-
<i>Limnonectes kuhlii</i>		AY703869	DQ283370	DQ347232	AF249116
<i>Limnonectes leporinus</i>		AY313691	AY313691	<b>JF744447</b>	-
<i>Limnonectes leytenis</i>		AY313702	AY313695	<b>JF744594</b>	-
<i>Limnonectes limborgi</i>		DQ347061	AF261269	DQ347286	DQ347407
<i>Limnonectes macrocephalus</i>		AY880472	AY313713	<b>JF744592</b>	-
<i>Limnonectes macrodon</i>		U66132	U66133	-	-
<i>Limnonectes magnus</i>		DQ347022	AY313706	<b>JF744593</b>	DQ347373
<i>Limnonectes malesianus</i>		AY313692	AY313692	-	-
<i>Limnonectes microdiscus</i>		AY313688	AY313688	-	-
<i>Limnonectes microtypanum</i>		AY313746	AY313746	<b>JF744587</b>	-
<i>Limnonectes modestus</i>		AY313766	AY313766	<b>JF744601</b>	EU979930
<i>Limnonectes palavanensis</i>		U55266	U55273	<b>JF744602</b>	-
<i>Limnonectes paramacrodon</i>		AY882574	AY313690	-	-

SUPPLEMENTARY MATERIALS: CHAPTER I

Species	Previous name	12S	16S	RAG1	RHOD
<i>Limnonectes parvus</i>		AY313694	AY313694	<b>JF744446</b>	-
<i>Limnonectes poilani</i>		DQ283378	DQ283378	-	DQ283997
<i>Limnonectes shompenorum</i>		EU979734	EU979794	<b>HM163583</b>	EU979931
<i>Limnonectes visayanus</i>		AY313720	AY313720	<b>JF744596</b>	-
<i>Limnonectes woodworthi</i>		AY313709	AY313712	<b>JF744597</b>	-
<i>Liophryne dentata</i>		EU100178	EU100294	-	-
<i>Liophryne rhododactyla</i>		DQ283199	DQ283199	-	DQ283882
<i>Liophryne schlaginhaufeni</i>		EU100179	EU100295	-	-
<i>Lithobates areolatus</i>	<i>Rana areolata</i>	AY779229	AY779229	-	-
<i>Lithobates berlandieri</i>	<i>Rana berlandieri</i>	AY779235	AY779235	DQ019510	<b>DQ019571</b>
<i>Lithobates blairi</i>	<i>Rana blairi</i>	AY779237	AY779237	-	-
<i>Lithobates brownorum</i>	<i>Rana brownorum</i>	AY115122	-	-	-
<i>Lithobates bwana</i>	<i>Rana bwana</i>	AY779212	AY779212	-	-
<i>Lithobates capito</i>	<i>Rana capito</i>	DQ283187	DQ283187	-	DQ283874
<i>Lithobates catesbeianus</i>	<i>Rana catesbeiana</i>	DQ283257	DQ283257	EF493448	DQ283926
<i>Lithobates chiricahuensis</i>	<i>Rana chiricahuensis</i>	DQ283270	DQ283270	-	DQ283934
<i>Lithobates clamitans</i>	<i>Rana clamitans</i>	AY779204	DQ283185	DQ347262	DQ347381
<i>Lithobates dunni</i>	<i>Rana dunni</i>	AY779222	AY779222	-	-
<i>Lithobates forreri</i>	<i>Rana forreri</i>	DQ283103	DQ283103	-	DQ283818
<i>Lithobates grylio</i>	<i>Rana grylio</i>	DQ283186	DQ283186	-	DQ283873
<i>Lithobates heckscheri</i>	<i>Rana heckscheri</i>	DQ283191	DQ283191	-	DQ283878
<i>Lithobates juliani</i>	<i>Rana juliani</i>	AY779215	AY779215	-	-
<i>Lithobates macroglossa</i>	<i>Rana macroglossa</i>	AY779243	AY779243	-	-
<i>Lithobates maculatus</i>	<i>Rana maculata</i>	DQ283303	DQ283303	-	DQ283951
<i>Lithobates magnaocularis</i>	<i>Rana magnaocularis</i>	AY779239	AY779239	-	-
<i>Lithobates montezumae</i>	<i>Rana montezumae</i>	AY779223	AY779223	-	-
<i>Lithobates neovolcanicus</i>	<i>Rana neovolcanica</i>	AY779236	AY779236	-	-
<i>Lithobates okaloosae</i>	<i>Rana okaloosae</i>	AY779203	AY779203	-	-
<i>Lithobates omiltemanus</i>	<i>Rana omiltemana</i>	AY779238	AY779238	-	-
<i>Lithobates onca</i>	<i>Rana onca</i>	AY779249	AY779249	-	-
<i>Lithobates palmipes</i>	<i>Rana palmipes</i>	DQ347037	DQ283384	DQ347263	DQ347382
<i>Lithobates palustris</i>	<i>Rana palustris</i>	AY779228	AY779228	DQ347264	DQ347383
<i>Lithobates pipiens</i>	<i>Rana pipiens</i>	DQ347039	Y10945	DQ347265	DQ347384
<i>Lithobates psilonota</i>	<i>Rana psilonota</i>	AY779217	AY779217	-	-
<i>Lithobates pustulosus</i>	<i>Rana pustulosa</i>	AY779220	AY779220	-	-
<i>Lithobates septentrionalis</i>	<i>Rana septentrionalis</i>	AY779200	AY779200	-	-
<i>Lithobates sevosus</i>	<i>Rana sevosus</i>	AY779230	AY779230	-	-
<i>Lithobates sierramadrensis</i>	<i>Rana sierramadrensis</i>	AY779216	AY779216	-	-
<i>Lithobates spectabilis</i>	<i>Rana spectabilis</i>	AY779232	AY779232	-	-
<i>Lithobates sphenocephalus</i>	<i>Rana sphenocephala</i>	DQ347040	AY779252	DQ347266	DQ347385
<i>Lithobates sylvaticus</i>	<i>Rana sylvatica</i>	DQ347052	DQ283387	DQ019511	DQ347397
<i>Lithobates tarahumarae</i>	<i>Rana tarahumarae</i>	DQ347041	AY779218	DQ347267	DQ347386
<i>Lithobates taylori</i>	<i>Rana taylori</i>	AY779244	AY779244	-	-
<i>Lithobates tlaloci</i>	<i>Rana tlaloci</i>	AY779234	AY779234	-	-
<i>Lithobates vaillanti</i>	<i>Rana vaillanti</i>	AY779214	AY779214	-	-
<i>Lithobates vibicarius</i>	<i>Rana vibicaria</i>	AY779208	AY779208	-	-
<i>Lithobates virgatipes</i>	<i>Rana virgatipes</i>	AY779202	AY779202	-	-
<i>Lithobates warszewitschii</i>	<i>Rana warszewitschii</i>	DQ283256	DQ283256	-	DQ283925
<i>Lithobates yavapaiensis</i>	<i>Rana yavapaiensis</i>	DQ283272	DQ283272	-	DQ283936
<i>Lithobates zweifeli</i>	<i>Rana zweifeli</i>	AY779219	AY779219	-	-
<i>Liuixalus hainanus</i>	<i>Philautus hainanus</i>	GQ285671	GQ285671	GQ285757	GQ285785
<i>Liuixalus ocellatus</i>	<i>Philautus ocellatus</i>	GQ285672	GQ285672	GQ285755	GQ285784
<i>Liuixalus romeri</i>		<b>EF564463</b>	EU215528	GQ285756	EU215559
<i>Mantella aurantiaca</i>		DQ283035	DQ283035	AY723530	AY263281
<i>Mantella baroni</i>		AB239568	AB239568	AY723518	AY263285
<i>Mantella bernhardi</i>		AB239570	AB239570	AY723531	AY263277
<i>Mantella betsileo</i>		AY880574	AY880531	AY723519	AY263280
<i>Mantella cowanii</i>		AY454360	AY454383	-	AY263289



SUPPLEMENTARY MATERIALS: CHAPTER I

Species	Previous name	12S	16S	RAG1	RHOD
<i>Mantella crocea</i>		AF215169	AF215309	AY723521	AY263278
<i>Mantella ebenaui</i>		-	FJ559221	-	-
<i>Mantella expectata</i>		AF215173	EF674848	AY723522	AY263287
<i>Mantella haraldmeieri</i>		<b>AY263274</b>	<b>AJ438904</b>	AY723515	AY263290
<i>Mantella laevigata</i>		AY454352	AF124130	AY723523	AY263276
<i>Mantella madagascariensis</i>		<b>AF261234</b>	AF124131	DQ019500	AY263284
<i>Mantella manery</i>		-	FJ559225	-	-
<i>Mantella milotympanum</i>		AY263273	FJ559226	AY723525	AY263286
<i>Mantella nigricans</i>		DQ283034	DQ283034	AY723527	DQ283764
<i>Mantella pulchra</i>		AY454353	FJ559228	AY723528	AY263282
<i>Mantella viridis</i>		AF215148	FJ559230	AY723529	AY263288
<i>Mantidactylus ambreensis</i>		AY341603	AY341659	-	AY341788
<i>Mantidactylus argenteus</i>		DQ235454	AY454377	-	DQ235444
<i>Mantidactylus biporus</i>		AY341599	AY341655	-	AY341784
<i>Mantidactylus charlotteae</i>		AY341605	AY341661	-	AY341790
<i>Mantidactylus femoralis</i>		AY843698	AY843698	-	AY341787
<i>Mantidactylus grandidieri</i>		AY341604	AF026371	<b>KF991332</b>	AY341789
<i>Mantidactylus lugubris</i>		AY341600	AY454388	<b>JN664440</b>	AY341785
<i>Mantidactylus mocquardi</i>		AF215151	AF215317	-	-
<i>Mantidactylus opiparis</i>		AY341606	AF261258	-	AY341791
<i>Mantidactylus ulcerosus</i>		<b>AF215164</b>	<b>AY848233</b>	AY948922	-
<i>Melanobatrachus indicus</i>		-	EF017964	EF018053	-
<i>Meristogenys jerboa</i>		AB360044	AB211493	AB360202	<b>AB526690</b>
<i>Meristogenys kinabaluensis</i>		DQ346983	AB526618	EF088250	AY322233
<i>Meristogenys orphnocnemis</i>		AB262545	AB211494	EF088251	DQ283847
<i>Meristogenys phaeomerus</i>		-	EU604210	-	-
<i>Meristogenys poecilus</i>		<b>AB526610</b>	<b>AB526610</b>	EF088252	<b>AB526692</b>
<i>Meristogenys whiteheadi</i>		<b>AB526708</b>	<b>FJ417119</b>	EF088253	<b>AB526699</b>
<i>Metamagnusia slateri</i>	<i>Callulops slateri</i>	AF095339	<b>KM509160</b>	-	-
<i>Metaphrynella sundana</i>		<b>AB634635</b>	EF017954	EF018043	-
<i>Micrixalus fuscus</i>		DQ346959	GU136106	<b>KF991333</b>	AF249120
<i>Micrixalus kottigeharensis</i>		AF249025	AF249041	-	AF249121
<i>Microbatrachella capensis</i>		DQ022329	DQ022357	<b>HQ014427</b>	<b>HQ014443</b>
<i>Microhyla borneensis</i>		<b>AB598304</b>	EF017951	EF018040	-
<i>Microhyla butleri</i>		AB201178	AB201189	EF396094	-
<i>Microhyla fissipes</i>		AB201175	AB201185	-	-
<i>Microhyla heymonsi</i>		DQ283382	DQ283382	EF396095	-
<i>Microhyla okinavensis</i>		AB201173	AB201184	-	-
<i>Microhyla ornata</i>		DQ346965	DQ512876	AY364198	AY364383
<i>Microhyla pulchra</i>		AB201180	AB201191	EF396093	-
<i>Microhyla rubra</i>		AB201181	AB201192	-	-
<i>Micryletta inornata</i>		<b>KC822494</b>	AF285207	EF396096	-
<i>Morerella cyanophthalma</i>		FJ594106	FJ594100	-	-
<i>Nannophrys ceylonensis</i>		DQ346975	AF215394	AY948917	AF249112
<i>Nannophrys marmorata</i>		AY141798	AF215395	-	-
<i>Nanorana aenea</i>	<i>Chaparana aenea</i>	AF206093	AF206474	<b>HM163609</b>	EU979895
<i>Nanorana aenea</i>	<i>Chaparana fansipani</i>	AY880476	AY880443	-	-
<i>Nanorana arnoldi</i>	<i>Paa arnoldi</i>	EU979711	EU979838	-	EU979854
<i>Nanorana bourreti</i>	<i>Paa bourreti</i>	EU979689	EU979827	-	EU979882
<i>Nanorana chayuensis</i>	<i>Paa chayuensis</i>	FJ588650	FJ588651	-	EU979852
<i>Nanorana conaensis</i>	<i>Paa conaensis</i>	EU979774	EU979834	-	EU979874
<i>Nanorana liebigii</i>	<i>Paa liebigii</i>	EU979701	DQ118500	-	EU979863
<i>Nanorana maculosa</i>	<i>Paa maculosa</i>	EU979707	EU979835	-	EU979860
<i>Nanorana medogensis</i>	<i>Paa medogensis</i>	EU979705	DQ118507	-	EU979861
<i>Nanorana parkeri</i>		AF206110	AF206491	DQ019501	EU979873
<i>Nanorana pleskei</i>		DQ346988	AF206492	DQ347225	AY322235
<i>Nanorana quadranus</i>	<i>Chaparana quadranus</i>	GQ225906	GQ225932	<b>HM163591</b>	EU979886
<i>Nanorana taihangnica</i>	<i>Paa taihangnicus</i>	GQ225973	GQ225986	-	EU979894

SUPPLEMENTARY MATERIALS: CHAPTER I

Species	Previous name	12S	16S	RAG1	RHOD
<i>Nanorana unculuanus</i>	<i>Chaparana unculuanus</i>	EU979699	DQ118491	-	DQ458262
<i>Nanorana ventripunctata</i>		EU979717	EU979839	<b>HM163585</b>	EU979866
<i>Nanorana yunnanensis</i>	<i>Paa liui</i>	DQ118449	DQ118493	-	-
<i>Nanorana yunnanensis</i>	<i>Paa yunnanensis</i>	GQ225869	GQ225873	DQ347223	DQ458263
<i>Natalobatrachus bonebergi</i>		DQ347011	DQ347302	DQ019502	DQ347361
<i>Nothophryne broadleyi</i>		KU761275	KU761283	KU761291	KU761299
<i>Nyctibates corrugatus</i>		DQ022313	DQ022348	-	DQ283983
<i>Nyctibatrachus major</i>		AB167907	AY341687	AY571655	AF249113
<i>Nyctixalus pictus</i>		AY880547	AY880502	GQ285761	AY880634
<i>Nyctixalus spinosus</i>		DQ283114	DQ283114	-	DQ283827
<i>Occidozyga baluensis</i>		DQ283143	DQ283143	-	DQ283844
<i>Occidozyga laevis</i>		DQ347024	AY322300	DQ347254	AY322227
<i>Occidozyga lima</i>		DQ283224	AF206497	DQ019503	DQ283901
<i>Occidozyga magnapustulosa</i>		AF161030	-	-	-
<i>Occidozyga martensii</i>		DQ283357	DQ283357	-	DQ458266
<i>Odontobatrachus natator</i>		<b>KF693287</b>	<b>KF693391</b>	<b>KF693611</b>	-
<i>Odorrana absita</i>		-	EU861542	EF088245	-
<i>Odorrana amamiensis</i>	<i>Rana amamiensis</i>	AB200923	AB200947	-	-
<i>Odorrana andersonii</i>	<i>Rana andersonii</i>	DQ359965	EF453745	-	DQ360018
<i>Odorrana aureola</i>		-	DQ650568	-	-
<i>Odorrana bacboensis</i>	<i>Rana bacboensis</i>	AF206099	DQ650569	EF088254	-
<i>Odorrana banaorum</i>	<i>Rana banaorum</i>	AF206106	AF206487	-	-
<i>Odorrana chapaensis</i>		DQ283372	EU861553	EF088255	DQ283992
<i>Odorrana chloronota</i>	<i>Rana chloronota</i>	AF206104	AF206485	EF088256	DQ284008
<i>Odorrana grahami</i>	<i>Rana grahami</i>	DQ283241	EU861555	EF088257	DQ360016
<i>Odorrana hejiangensis</i>	<i>Rana hejiangensis</i>	DQ359984	EF453747	-	DQ360037
<i>Odorrana hosii</i>	<i>Rana hosii</i>	AB200933	AB200958	EF088259	-
<i>Odorrana ishikawae</i>	<i>Rana ishikawae</i>	AB200921	AB200945	-	-
<i>Odorrana jingdongensis</i>		AF206102	AF206483	-	-
<i>Odorrana jingdongensis</i>	<i>Rana hmongorum</i>	-	EU861559	EF088258	-
<i>Odorrana junlianensis</i>		<b>KF185022</b>	EU861564	-	-
<i>Odorrana khalam</i>	<i>Rana khalam</i>	-	-	EF088272	-
<i>Odorrana livida</i>	<i>Rana livida</i>	DQ359969	DQ650613	EF088260	DQ360022
<i>Odorrana margaretae</i>	<i>Rana margaretae</i>	DQ359964	EU861566	EF088261	DQ360017
<i>Odorrana morafkai</i>	<i>Rana morafkai</i>	AF206103	AF206484	EF088263	-
<i>Odorrana narina</i>	<i>Rana narina</i>	AB200924	AB200948	-	-
<i>Odorrana nasica</i>		DQ283345	AF206461	EF088264	DQ283971
<i>Odorrana schmackeri</i>		AB200935	AB200959	-	DQ360020
<i>Odorrana supranarina</i>	<i>Rana supranarina</i>	AB200926	AB200950	-	-
<i>Odorrana swinhoana</i>	<i>Rana swinhoana</i>	AB200929	AB200953	-	-
<i>Odorrana tiannanensis</i>	<i>Rana megatympnum</i>	-	-	EF088262	-
<i>Odorrana tiannanensis</i>	<i>Rana tiannanensis</i>	AF206105	AF206486	EF088262	-
<i>Odorrana tormota</i>		EF453739	EF453754	EU076750	-
<i>Odorrana utsunomiyaorum</i>	<i>Rana utsunomiyaorum</i>	AB200928	AB200952	-	-
<i>Odorrana versabilis</i>	<i>Rana versabilis</i>	DQ359962	EF453752	-	DQ360015
<i>Opisthoxylax immaculatus</i>		DQ283174	DQ283174	-	DQ283866
<i>Oreophryne asplenicola</i>		EU100181	EU100297	-	-
<i>Oreophryne atrigularis</i>		EU100188	EU100304	-	-
<i>Oreophryne brachypus</i>		DQ283194	DQ283194	-	-
<i>Oreophryne clamata</i>		EU100190	EU100306	-	-
<i>Oreophryne pseudasplenicola</i>		EU100193	EU100309	-	-
<i>Oreophryne sibilans</i>		EU100198	EU100314	-	-
<i>Oreophryne unicolor</i>		EU100199	EU100315	-	-
<i>Oreophryne waira</i>		EU100203	EU100319	-	-
<i>Oreophryne wapoga</i>		EU100206	EU100322	-	-
<i>Otophryne pyburni</i>		-	-	EF396097	-
<i>Oxydactyla crassa</i>		EU100207	EU100323	-	-
<i>Papurana arfaki</i>	<i>Rana arfaki</i>	DQ283203	DQ283203	-	DQ283886

SUPPLEMENTARY MATERIALS: CHAPTER I

Species	Previous name	12S	16S	RAG1	RHOD
<i>Papurana daemeli</i>	<i>Rana daemeli</i>	DQ283201	DQ283201	-	DQ283884
<i>Papurana jimienis</i>	<i>Rana jimienis</i>	EU004610	<b>KR264053</b>	-	-
<i>Paradoxophyla palmata</i>		EU341121	EU341121	EF396098	-
<i>Paradoxophyla tiarano</i>		-	AY834186	-	-
<i>Pelophylax bedriagae</i>	<i>Rana bedriagae</i>	AY043033	AY147937	-	<b>AY148008</b>
<i>Pelophylax cerigensis</i>	<i>Rana cerigensis</i>	-	AY147979	-	<b>AY148009</b>
<i>Pelophylax cretensis</i>	<i>Rana cretensis</i>	AJ318087	AY147980	-	<b>AY148010</b>
<i>Pelophylax epeiroticus</i>	<i>Rana epeirotica</i>	AJ002595	DQ474207	-	<b>AY148011</b>
<i>Pelophylax hubeiensis</i>	<i>Rana hubeiensis</i>	AF205547	AF315137	-	-
<i>Pelophylax kurtmuelleri</i>	<i>Rana kurtmuelleri</i>	AJ222655	DQ474228	-	-
<i>Pelophylax lessonae</i>	<i>Rana bergeri</i>	AJ222650	<b>JN689222</b>	-	-
<i>Pelophylax lessonae</i>	<i>Rana lessonae</i>	AB023395	AY147982	-	AY322243
<i>Pelophylax nigromaculatus</i>	<i>Rana nigromaculata</i>	DQ283137	DQ283137	AB360184	<b>AB360212</b>
<i>Pelophylax perezi</i>	<i>Rana perezi</i>	AY332763	AY147985	-	<b>AY148015</b>
<i>Pelophylax plancyi</i>	<i>Rana plancyi</i>	<b>AF218720+</b>	NC_009264	-	-
<i>Pelophylax ridibundus</i>	<i>Rana ridibunda</i>	FJ595208	AY147983	-	<b>AY148013</b>
<i>Pelophylax saharicus</i>	<i>Rana saharica</i>	AY332765	AY147984	-	<b>AY148014</b>
<i>Pelophylax shqipericus</i>	<i>Rana shqiperica</i>	AJ222651	<b>NC_026896</b>	-	-
<i>Petropedetes cameronensis</i>		DQ022335	DQ022363	<b>KF693629</b>	DQ283800
<i>Petropedetes euskircheni</i>		<b>KF693312</b>	GU256024	<b>KF693634</b>	-
<i>Petropedetes johnstoni</i>		<b>KF693316</b>	GU256029	<b>KF693636</b>	-
<i>Petropedetes johnstoni</i>	<i>Petropedetes newtoni</i>	DQ022334	<b>DQ283177</b>	-	DQ283869
<i>Petropedetes juliawurstnerae</i>		<b>KF693328</b>	GU256030	<b>KF693637</b>	-
<i>Petropedetes palmipes</i>		DQ283074	DQ283074	<b>KF693640</b>	DQ283799
<i>Petropedetes parkeri</i>		DQ022336	DQ022364	AY571656	AY364394
<i>Petropedetes perreti</i>		<b>KF693347</b>	GU256035	<b>KF693644</b>	-
<i>Petropedetes vulpiae</i>		<b>KF693368</b>	GU256042	<b>KF693647</b>	-
<i>Philautus abditus</i>		GQ285673	GQ285673	GQ285775	GQ285794
<i>Philautus acutirostris</i>		AY326059	AY326059	-	-
<i>Philautus aurifasciatus</i>		AY141805	AY141851	-	-
<i>Philautus ingeri</i>		AY880541	AY880496	<b>GQ204588</b>	AY880629
<i>Philautus mjobergi</i>		AF026348	AF026365	<b>GQ204590</b>	<b>GQ204644</b>
<i>Philautus petersi</i>		AF026349	AF026366	-	-
<i>Philautus surdus</i>		AF458138	AF458138	-	-
<i>Phlyctimantis leonardi</i>		DQ283355	DQ283356	-	-
<i>Phlyctimantis verrucosus</i>		U22081	<b>KF667388</b>	-	-
<i>Phrynobatrachus acridoides</i>		DQ022330	DQ022358	<b>GU457594</b>	-
<i>Phrynobatrachus africanus</i>		DQ347031	DQ347319	DQ347259	DQ347378
<i>Phrynobatrachus auritus</i>		DQ022333	DQ022362	<b>KF693601</b>	-
<i>Phrynobatrachus calcaratus</i>		EU075281	EU075281	GU457634	DQ283912
<i>Phrynobatrachus cricogaster</i>		DQ022331	<b>FJ769101</b>	<b>GU457650</b>	-
<i>Phrynobatrachus dendrobates</i>		EU075287	EU075287	-	DQ283904
<i>Phrynobatrachus dispar</i>		EU075276	EU075276	<b>GU457651</b>	DQ283900
<i>Phrynobatrachus kreffti</i>		DQ347059	FJ829274	DQ347284	DQ347403
<i>Phrynobatrachus leveleve</i>		EU075279	EU075279	<b>GU457693</b>	-
<i>Phrynobatrachus mababiensis</i>		EU075294	EU075294	GU457700	DQ284026
<i>Phrynobatrachus natalensis</i>		DQ347012	EU718726	DQ019507	DQ347362
<i>Phrynobatrachus sandersoni</i>		DQ283083	DQ283083	<b>GU457749</b>	DQ283804
<i>Phrynomantis annectens</i>		-	AF215377	EF396099	-
<i>Phrynomantis bifasciatus</i>		DQ283154	DQ283154	EF396100	-
<i>Phrynomantis microps</i>		AY531855	AY531832	-	<b>JF837041</b>
<i>Platymantis corrugatus</i>		EU004643	-	-	-
<i>Platymantis dorsalis</i>		DQ347199	DQ347308	DQ347246	DQ347367
<i>Platymantis hazelae</i>		DQ347019	DQ347310	DQ347248	DQ347369
<i>Platymantis mimulus</i>		EU004644	-	-	-
<i>Platymantis montanus</i>		-	DQ347309	DQ347247	DQ347368
<i>Platymantis naomii</i>		DQ347201	DQ347311	DQ347249	DQ347370
<i>Plethodontohyla bipunctata</i>		EU341068	EU341068	-	-

SUPPLEMENTARY MATERIALS: CHAPTER I

Species	Previous name	12S	16S	RAG1	RHOD
<i>Plethodontohyla brevipes</i>		EU341063	EU341063	EF396103	-
<i>Plethodontohyla fonetana</i>		EU341058	EU341058	-	-
<i>Plethodontohyla guentheri</i>		EU341059	EU341059	-	-
<i>Plethodontohyla inguinalis</i>		EU341057	EU341057	-	-
<i>Plethodontohyla mihanika</i>		EU341056	EU341056	-	-
<i>Plethodontohyla notosticta</i>		EU341061	EU341061	EU341128	-
<i>Plethodontohyla ocellata</i>		EU341062	EU341062	-	-
<i>Plethodontohyla tuberata</i>		EU341064	EU341064	-	-
<i>Polypedates colletti</i>		<b>AB728189</b>	EF624065	<b>GQ204579</b>	<b>AB728285</b>
<i>Polypedates cruciger</i>		AF249028	AF249045	DQ347212	AF249124
<i>Polypedates leucomystax</i>		AY880563	AF215343	<b>GQ204583</b>	AY880649
<i>Polypedates maculatus</i>		AY880607	AY880520	AY323777	<b>AB728284</b>
<i>Polypedates megacephalus</i>		AY880564	AY880519	EU924517	EU924545
<i>Polypedates mutus</i>		AY880565	AY880521	GQ285770	EU215581
<i>Poyntonia paludicola</i>		DQ347058	DQ347341	DQ347283	DQ347402
<i>Probreviceps durirostris</i>		DQ438127	DQ438131	-	-
<i>Probreviceps macrodactylus</i>		AY531875	DQ283420	-	-
<i>Probreviceps uluguruensis</i>		AY531869	AY531845	-	-
<i>Pseudocallulops eurydactylus</i>	<i>Callulops eurydactylus</i>	EU100120	EU100236	-	-
<i>Pseudocallulops pullifer</i>	<i>Callulops pullifer</i>	EU100129	EU100245	-	-
<i>Pseudophilautus asankai</i>	<i>Philautus asankai</i>	FJ788141	FJ788160	-	-
<i>Pseudophilautus cavirostris</i>	<i>Philautus cavirostris</i>	FJ788137	FJ788156	-	<b>GQ204622</b>
<i>Pseudophilautus decoris</i>	<i>Philautus decoris</i>	FJ788144	FJ788163	-	-
<i>Pseudophilautus femoralis</i>	<i>Philautus femoralis</i>	AY141787	AY141833	-	-
<i>Pseudophilautus hoffmanni</i>	<i>Philautus hoffmanni</i>	FJ788142	FJ788161	-	<b>GQ204619</b>
<i>Pseudophilautus leucorhinus</i>	<i>Philautus leucorhinus</i>	AY763796	AY753559	-	-
<i>Pseudophilautus lunatus</i>	<i>Philautus lunatus</i>	FJ788150	FJ788169	-	<b>GQ204621</b>
<i>Pseudophilautus microtypanum</i>	<i>Philautus microtypanum</i>	DQ346974	AF249046	DQ019506	AF249126
<i>Pseudophilautus mittermeieri</i>	<i>Philautus mittermeieri</i>	FJ788143	FJ788162	-	<b>GQ204626</b>
<i>Pseudophilautus mooreorum</i>	<i>Philautus mooreorum</i>	FJ788134	FJ788153	-	-
<i>Pseudophilautus ocellaris</i>	<i>Philautus ocellaris</i>	FJ788145	FJ788164	-	-
<i>Pseudophilautus papillosus</i>	<i>Philautus papillosus</i>	FJ788151	FJ788170	-	-
<i>Pseudophilautus pleurotaenia</i>	<i>Philautus pleurotaenia</i>	FJ788146	FJ788165	-	-
<i>Pseudophilautus poppiae</i>	<i>Philautus poppiae</i>	FJ788136	FJ788155	-	-
<i>Pseudophilautus popularis</i>	<i>Philautus popularis</i>	FJ788149	FJ788168	-	-
<i>Pseudophilautus schmarda</i>	<i>Philautus schmarda</i>	AY880617	AY880530	-	<b>GQ204615</b>
<i>Pseudophilautus simba</i>	<i>Philautus simba</i>	FJ788148	FJ788167	-	<b>GQ204624</b>
<i>Pseudophilautus steineri</i>	<i>Philautus steineri</i>	FJ788138	FJ788157	-	-
<i>Pseudophilautus stuarti</i>	<i>Philautus stuarti</i>	FJ788140	FJ788159	-	<b>GQ204618</b>
<i>Pseudophilautus tanu</i>	<i>Philautus tanu</i>	FJ788152	FJ788171	-	-
<i>Pseudophilautus wynaadensis</i>	<i>Philautus wynaadensis</i>	DQ346966	AB167930	AY364199	AF249127
<i>Pseudophilautus zorro</i>	<i>Philautus zorro</i>	FJ788147	FJ788166	-	<b>GQ204617</b>
<i>Pseudorana weiningensis</i>	<i>Rana weiningensis</i>	DQ359966	DQ359996	-	DQ360012
<i>Ptychadena aequiplicata</i>		<b>KF991255</b>	AY517618	<b>KF991336</b>	-
<i>Ptychadena anchietae</i>		AF261249	AF261267	-	-
<i>Ptychadena bibroni</i>		<b>AF215203</b>	AY517602	-	-
<i>Ptychadena cooperi</i>		AF122007	DQ283067	<b>KF380597</b>	DQ283792
<i>Ptychadena longirostris</i>		-	AY517606	-	-
<i>Ptychadena mahnerti</i>		-	DQ525918	-	-
<i>Ptychadena mascareniensis</i>		AF122007	DQ283031	AY571658	AY880662
<i>Ptychadena newtoni</i>		-	DQ525935	<b>GU457784</b>	-
<i>Ptychadena oxyrhynchus</i>		AF215205	AF215409	-	-
<i>Ptychadena porosissima</i>		-	AF215411	-	-
<i>Ptychadena pumilio</i>		-	DQ525942	-	-
<i>Ptychadena subpunctata</i>		AF215206	AF215410	-	-
<i>Ptychadena taenioscelis</i>		-	DQ525943	-	-
<i>Ptychadena tellinii</i>		-	AY517608	-	-
<i>Pulchrana banjarana</i>	<i>Rana banjarana</i>	<b>KF477645</b>	DQ835319	-	-

SUPPLEMENTARY MATERIALS: CHAPTER I

Species	Previous name	12S	16S	RAG1	RHOD
<i>Pulchrana baramica</i>	<i>Rana baramica</i>	<b>AB719217</b>	DQ835353	EF088265	-
<i>Pulchrana glandulosa</i>	<i>Rana glandulosa</i>	<b>AB719210</b>	EU604188	EF088270	-
<i>Pulchrana laterimaculata</i>	<i>Rana laterimaculata</i>	<b>AB719213</b>	EU604195	-	-
<i>Pulchrana picturata</i>	<i>Rana picturata</i>	<b>AB719219</b>	EU604171	-	-
<i>Pulchrana siberu</i>	<i>Rana siberu</i>	<b>KF477744</b>	EU604198	-	-
<i>Pulchrana signata</i>	<i>Rana signata</i>	DQ346980	EU604157	DQ347218	AY322237
<i>Pyxicephalus adspersus</i>		DQ022340	AF215505	<b>DQ019508</b>	<b>DQ019569</b>
<i>Pyxicephalus edulis</i>		DQ022341	DQ022366	<b>KF991338</b>	DQ283853
<i>Quasipaa boulengeri</i>	<i>Paa boulengeri</i>	EU979791	EU979851	-	EU979918
<i>Quasipaa boulengeri</i>	<i>Paa robertingeri</i>	EU979671	GQ225876	-	DQ458265
<i>Quasipaa delacouri</i>	<i>Chaparana delacouri</i>	EU979666	EU979812	-	EU979900
<i>Quasipaa exilispinosa</i>	<i>Paa exilispinosa</i>	EU979647	EU979799	-	DQ283916
<i>Quasipaa fasciculispina</i>	<i>Paa fasciculispina</i>	-	-	HM163614	HM163651
<i>Quasipaa jiulongensis</i>	<i>Paa jiulongensis</i>	EU979651	DQ118485	-	EU979927
<i>Quasipaa shini</i>	<i>Paa shini</i>	EU979654	DQ118487	-	EU979908
<i>Quasipaa spinosa</i>	<i>Paa spinosa</i>	AF206088	AF206469	-	EU979891
<i>Quasipaa verrucospinosa</i>	<i>Paa verrucospinosa</i>	EU979790	EU979813	DQ019504	EU979896
<i>Quasipaa yei</i>	<i>Paa yei</i>	DQ118445	DQ118488	-	EU979905
<i>Rana amurensis</i>		DQ359979	<b>AB058886</b>	-	DQ360032
<i>Rana arvalis</i>		AB058865	AB058883	<b>KC799032</b>	<b>AY147988</b>
<i>Rana asiatica</i>		AB058866	AB058884	-	-
<i>Rana aurora</i>		DQ283189	DQ283189	DQ019509	DQ283876
<i>Rana boylei</i>		DQ347051	AY779192	DQ347277	DQ347396
<i>Rana cascadae</i>		AY779197	AY779197	-	-
<i>Rana chaochiaoensis</i>		DQ359975	DQ289107	-	DQ360028
<i>Rana chensinensis</i>		DQ359977	DQ289118	-	DQ360030
<i>Rana coreana</i>	<i>Rana kunyuensis</i>	DQ359980	DQ289111	-	DQ360033
<i>Rana dalmatina</i>	<i>Rana dalmatina</i>	AY043038	AY147941	<b>KC798654</b>	<b>AY147992</b>
<i>Rana dybowskii</i>	<i>Rana dybowskii</i>	DQ289100	DQ289125	-	-
<i>Rana graeca</i>		AY043040	AY147942	-	<b>AY147993</b>
<i>Rana huanrensis</i>		DQ359978	DQ289122	-	DQ360031
<i>Rana iberica</i>		AY043043	AY147944	<b>KC798670</b>	<b>AY147995</b>
<i>Rana italica</i>		AY043044	AY147945	<b>KC798680</b>	<b>AY147996</b>
<i>Rana japonica</i>		AB058859	AB058877	<b>KR264358</b>	DQ283837
<i>Rana johnsi</i>		AF206096	DQ283214	EF088271	DQ283894
<i>Rana kukunoris</i>		<b>KC465786</b>	<b>KC465786</b>	GQ285780	GQ285798
<i>Rana latastei</i>		AY043039	AY147946	<b>KC798687</b>	<b>AY147997</b>
<i>Rana longicrus</i>		AB058863	AB058881	-	-
<i>Rana luteiventris</i>		AY779194	AY779194	-	-
<i>Rana macrocnemis</i>		AY043048	AY147940	-	<b>AY147990</b>
<i>Rana muscosa</i>		DQ283190	AY779195	-	DQ283877
<i>Rana omeimontis</i>		DQ289083	DQ289108	-	-
<i>Rana ornativentris</i>		AB058857	AB058875	-	-
<i>Rana pirica</i>		AB058854	AB058872	-	-
<i>Rana pyrenaica</i>		EU746401	AY147950	-	<b>AY148001</b>
<i>Rana shuchinae</i>		DQ359973	DQ289126	-	DQ360026
<i>Rana tagoi</i>		AF218714	<b>AB639580</b>	<b>AB779848</b>	-
<i>Rana temporaria</i>		AY326063	AY326063	AY323776	AF249119
<i>Rana tsushimensis</i>		AB058860	AB058878	-	-
<i>Rana zhengi</i>		DQ359974	DQ289104	-	DQ360027
<i>Rana zhenhaiensis</i>		AY322318	AF315136	-	AY322217
<i>Raorchestes anili</i>	<i>Philautus anili</i>	<b>JX092729</b>	EU450024	-	<b>JX092984</b>
<i>Raorchestes beddomii</i>	<i>Philautus beddomii</i>	<b>JX092731</b>	EU449998	-	-
<i>Raorchestes bobingeri</i>	<i>Philautus bobingeri</i>	<b>JX092733</b>	EU450014	-	-
<i>Raorchestes bombayensis</i>	<i>Philautus bombayensis</i>	-	EU450019	-	<b>JX092986</b>
<i>Raorchestes charius</i>	<i>Philautus charius</i>	DQ346967	AY141840	DQ347208	AF249128
<i>Raorchestes glandulosus</i>	<i>Philautus glandulosus</i>	<b>JX092744</b>	EU450020	-	<b>JX092995</b>
<i>Raorchestes graminirupes</i>	<i>Philautus graminirupes</i>	<b>JX092772</b>	EU450015	-	-

SUPPLEMENTARY MATERIALS: CHAPTER I

Species	Previous name	12S	16S	RAG1	RHOD
<i>Raorchestes griet</i>	<i>Philautus griet</i>	AY706108	AF536203	-	<b>JX092997</b>
<i>Raorchestes gryllus</i>	<i>Philautus gryllus</i>	GQ285674	GQ285674	GQ285777	GQ285796
<i>Raorchestes longchuanensis</i>	<i>Philautus longchuanensis</i>	GQ285675	GQ285675	GQ285776	GQ285795
<i>Raorchestes luteolus</i>	<i>Philautus neelanethrus</i>	AY763797	AY753560	-	-
<i>Raorchestes menglaensis</i>	<i>Philautus menglaensis</i>	GQ285676	GQ285676	GQ285778	EU924544
<i>Raorchestes nerostagona</i>	<i>Philautus nerostagona</i>	<b>JX092760</b>	EU450012	-	<b>JX093009</b>
<i>Raorchestes ponnudi</i>	<i>Philautus ponnudi</i>	<b>JX092762</b>	EU450026	-	<b>JX093011</b>
<i>Raorchestes signatus</i>	<i>Philautus signatus</i>	AY141795	AY141841	-	<b>JX093014</b>
<i>Raorchestes tinniensi</i>	<i>Philautus tinniensi</i>	AY706112	EU450001	-	-
<i>Raorchestes travancoricus</i>	<i>Philautus travancoricus</i>	<b>JX092776</b>	EU450029	-	<b>JX093019</b>
<i>Raorchestes tuberothumerus</i>	<i>Philautus tuberothumerus</i>	-	EU450004	-	-
<i>Rhacophorus annamensis</i>		DQ283047	DQ283047	<b>GQ204598</b>	DQ283776
<i>Rhacophorus arboreus</i>		AY880567	AY880523	-	AY880653
<i>Rhacophorus bipunctatus</i>		AY843750	AY843750	EU924518	EU924546
<i>Rhacophorus burmanus</i>	<i>Rhacophorus taronensis</i>	EU215537	EU215537	EU924533	EU215567
<i>Rhacophorus calcaneus</i>		DQ283380	DQ283380	<b>GQ204600</b>	DQ283999
<i>Rhacophorus chenfu</i>		<b>JX219432</b>	<b>EU215534</b>	EU924519	EU924547
<i>Rhacophorus dennysi</i>		AY880568	AY880524	DQ019512	AY880654
<i>Rhacophorus dugritei</i>		EF564471	EF564541	GQ285768	EU215571
<i>Rhacophorus feae</i>		<b>EU215544</b>	<b>KJ802927</b>	EU924522	EU924550
<i>Rhacophorus hui</i>		<b>JN688878</b>	<b>JN688878</b>	EU924523	EU215570
<i>Rhacophorus hungfuensis</i>		EU215538	EU215538	-	EU215568
<i>Rhacophorus kio</i>		EU215532	EU215532	GQ285766	EU215562
<i>Rhacophorus lateralis</i>		AY880569	AY880525	-	<b>AY880655</b>
<i>Rhacophorus malabaricus</i>		DQ346957	AF249050	AY948912	AF249125
<i>Rhacophorus maximus</i>		<b>JX219411</b>	<b>JX219411</b>	EU924524	EU924552
<i>Rhacophorus minimus</i>		<b>EU215539</b>	<b>EU215539</b>	EU924525	EU215569
<i>Rhacophorus moltrechti</i>		AF118477	DQ468676	-	EU215573
<i>Rhacophorus nigropunctatus</i>		<b>JX219430</b>	<b>JX219429</b>	GQ285767	EU924554
<i>Rhacophorus omeimontis</i>		<b>LC010595</b>	<b>JX219421</b>	EU924528	EU215565
<i>Rhacophorus orlovi</i>		DQ283049	DQ283049	-	DQ283778
<i>Rhacophorus puerensis</i>		EU215542	EU215542	-	EU215572
<i>Rhacophorus reinwardtii</i>		AY880571	AY880527	EU924531	EU924559
<i>Rhacophorus rhodopus</i>		<b>JX219441</b>	<b>JX219442</b>	EU924532	EU215560
<i>Rhacophorus schlegelii</i>		AY880572	AY880528	-	AY880658
<i>Rhombophryne alluaudi</i>		EU341105	EU341105	EF396102	<b>DQ019568</b>
<i>Rhombophryne coronata</i>		EU341103	EU341103	-	-
<i>Rhombophryne coudreaui</i>		AY594034	AY594072	-	-
<i>Rhombophryne gimmeli</i>	<i>Stumpffia gimmeli</i>	EU341084	EU341084	-	-
<i>Rhombophryne grandis</i>	<i>Stumpffia grandis</i>	EU341078	AF215386	-	-
<i>Rhombophryne helenae</i>	<i>Stumpffia helenae</i>	EU341070	EU341070	EU341125	-
<i>Rhombophryne laevipes</i>		EU341104	EU341104	-	-
<i>Rhombophryne minuta</i>		EU341108	EU341108	EU341127	-
<i>Rhombophryne psologlossa</i>	<i>Stumpffia psologlossa</i>	EU341066	EU341066	EF396107	-
<i>Rhombophryne pygmaea</i>	<i>Stumpffia pygmaea</i>	EU341065	EU341065	EF396108	-
<i>Rhombophryne roseifemoralis</i>	<i>Stumpffia roseifemoralis</i>	EU341072	EU341072	-	-
<i>Rhombophryne serratopalpebrosa</i>		<b>EU341111</b>	EU341111	-	-
<i>Rhombophryne testudo</i>		EU341110	EU341110	EF396105	-
<i>Rhombophryne tetradactyla</i>	<i>Stumpffia tetradactyla</i>	EU341077	EU341077	-	-
<i>Rhombophryne tridactyla</i>	<i>Stumpffia tridactyla</i>	EU341080	EU341080	-	-
<i>Sanguirana igorota</i>	<i>Rana igorota</i>	-	-	EU076754	-
<i>Sanguirana luzonensis</i>	<i>Rana luzonensis</i>	DQ346990	DQ347293	EU076755	DQ347351
<i>Sanguirana sanguinea</i>	<i>Rana sanguinea</i>	DQ347047	DQ347331	DQ347273	DQ347392
<i>Scaphiophryne boribory</i>		EU341114	EU341114	-	-
<i>Scaphiophryne brevis</i>		EU341117	EU341117	-	-
<i>Scaphiophryne calcarata</i>		EU341118	EU341118	EF396106	-
<i>Scaphiophryne gottlebei</i>		AF026356	EF674851	-	-
<i>Scaphiophryne madagascariensis</i>		EU341115	EU341115	-	-

## SUPPLEMENTARY MATERIALS: CHAPTER I

Species	Previous name	12S	16S	RAG1	RHOD
<i>Scaphiophryne marmorata</i>		EU341116	EU341116	AY364205	AY364390
<i>Scaphiophryne menabensis</i>		-	AY834189	-	-
<i>Scaphiophryne spinosa</i>		-	DQ787111	-	-
<i>Scotobleps gabonicus</i>		DQ022315	DQ283367	-	DQ283988
<i>Semnodactylus wealii</i>		AF215232	AF215450	-	-
<i>Spelaophryne methneri</i>		AY531862	EF107167	EF107290	-
<i>Sphaerotheca breviceps</i>		AF161039	AF249042	-	AF249110
<i>Sphaerotheca dobsonii</i>		AB277290	AB277305	<b>AB488959</b>	<b>AB489040</b>
<i>Sphenophryne cornuta</i>		EU100210	EU100326	AY948942	-
<i>Spinomantis aglavei</i>		AF215167	AF261254	-	EF100486
<i>Spinomantis elegans</i>		<b>EF100481</b>	EF100475	-	EF100487
<i>Spinomantis peraccae</i>		AY341592	AY454391	-	DQ283767
<i>Stauroids latopalatus</i>		DQ346984	AB200966	EF088277	AY322239
<i>Stauroids natator</i>		DQ347020	DQ347312	DQ347250	DQ347371
<i>Stauroids parvus</i>		AB259717	AB259722	-	-
<i>Stauroids tuberilinguis</i>		AB259718	DQ283140	EF088278	DQ283841
<i>Strongylopus bonaespei</i>		DQ347063	DQ347345	DQ347288	DQ347409
<i>Strongylopus fasciatus</i>		DQ019594	AF215412	DQ019513	<b>DQ019574</b>
<i>Strongylopus grayii</i>		DQ347028	DQ283068	DQ347256	DQ283793
<i>Sylvirana cubitalis</i>	<i>Rana cubitalis</i>	-	DQ650392	EF088267	-
<i>Sylvirana faber</i>	<i>Rana faber</i>	-	KR827803	EF088269	-
<i>Sylvirana guentheri</i>	<i>Rana guentheri</i>	DQ283266	AF206476	-	DQ360024
<i>Sylvirana maosonensis</i>	<i>Rana maosonensis</i>	DQ283373	EU754859	EF088274	DQ283993
<i>Sylvirana nigrovittata</i>	<i>Rana nigrovittata</i>	DQ283371	EU754851	EF088276	AY322242
<i>Sylvirana spinulosa</i>	<i>Rana spinulosa</i>	DQ359982	DQ360004	-	DQ360035
<i>Synapturanus mirandaribeiroi</i>		DQ283064	<b>KC180018</b>	-	-
<i>Tachycnemis seychellensis</i>		DQ283451	<b>KJ551608</b>	EF646572	AY341814
<i>Taruga eques</i>	<i>Polypedates eques</i>	AY880489	AY141847	<b>GQ204571</b>	AY880647
<i>Taruga fastigo</i>	<i>Polypedates fastigo</i>	AY880562	AY880518	<b>GQ204572</b>	AY880648
<i>Theloderma asperum</i>		<b>LC012858</b>	<b>LC012858</b>	EU924534	EU924562
<i>Theloderma bicolor</i>		AY880573	AY880529	<b>KF991342</b>	AY880659
<i>Theloderma corticale</i>		DQ283050	AF268256	-	DQ283779
<i>Theloderma rhododiscus</i>		<b>LC012842</b>	<b>LC012842</b>	GQ285759	EU215555
<i>Tomopterna cf. tandyi</i>		<b>DQ347009</b>	<b>DQ347009</b>	<b>DQ347240</b>	<b>DQ347360</b>
<i>Tomopterna cryptotis</i>		AF371199	AY255090	-	-
<i>Tomopterna damarensis</i>		-	AY255091	-	-
<i>Tomopterna delalandii</i>		DQ283403	AY255086	-	DQ284014
<i>Tomopterna krugerensis</i>		AF371208	AY255098	-	-
<i>Tomopterna luganga</i>		<b>HQ700695</b>	DQ017056	-	-
<i>Tomopterna marmorata</i>		AF371204	AY255084	-	-
<i>Tomopterna natalensis</i>		AY205274	AY255089	-	-
<i>Tomopterna tandyi</i>		AF371190	AF436071	-	-
<i>Tomopterna tuberculosa</i>		AF371214	AY255100	-	-
<i>Trichobatrachus robustus</i>		DQ347010	FJ151076	EF396109	AY322215
<i>Uperodon obscurus</i>	<i>Ramanella obscura</i>	<b>KC822504</b>	AF215382	-	-
<i>Uperodon systoma</i>		-	EF017960	EF018049	-
<i>Uperodon variegatus</i>	<i>Ramanella variegata</i>	GU136098	EF017963	EF018052	-
<i>Wakea madinika</i>		AY341587	AY341642	-	AY341772
<i>Xenorhina bowwensi</i>		EU100214	EU100330	-	-
<i>Xenorhina lanthanites</i>		EU100215	EU100331	-	-
<i>Xenorhina obesa</i>		-	EF017959	EF018048	-
<i>Xenorhina oxycephala</i>		EU100216	EU100332	-	-
<i>Xenorhina varia</i>		EU100219	EU100335	-	-

**TABLE 6. GenBank accession numbers for the species included in the small-scale phylogenetic analysis of *Nothophryne broadleyi*.**

Species	12S	16S	RAG1	RHOD
<i>Amietia angolensis</i>	DQ347029	DQ347318	DQ347257	DQ347377
<i>Amietia fuscigula</i>	DQ347065	DQ283069	DQ347290	DQ283794
<i>Amietia vertebralis</i>	DQ283402	AY255097	<b>FJ411449</b>	-
<i>Anhydrophryne rattrayi</i>	DQ022319	AF215504	<b>HQ014429</b>	-
<i>Arthroleptella bicolor</i>	DQ283070	AY205285	-	DQ283795
<i>Arthroleptella drewesii</i>	AY453276	AY454341	-	-
<i>Arthroleptella landrosia</i>	AF330244	AY205276	-	-
<i>Arthroleptella lightfooti</i>	AF330242	AY205282	<b>HQ014425</b>	<b>HQ014442</b>
<i>Arthroleptella subvoce</i>	AY205267	AY454343	-	-
<i>Arthroleptella villiersi</i>	DQ347062	DQ347344	DQ347287	DQ347408
<i>Aubria subsigillata</i>	DQ283350	DQ283173	<b>KF991337</b>	DQ283865
<i>Cacosternum boettgeri</i>	DQ347007	DQ347299	AY571645	DQ347358
<i>Cacosternum capense</i>	DQ022323	DQ022354	-	-
<i>Cacosternum nanum</i>	DQ022321	DQ022353	-	-
<i>Ericabatrachus baleensis</i>	KF938362	KF938365	KF938370	-
<i>Microbatrachella capensis</i>	DQ022329	DQ022357	<b>HQ014427</b>	<b>HQ014443</b>
<i>Natalobatrachus bonebergi</i>	DQ347011	DQ347302	DQ019502	DQ347361
<i>Nothophryne cf. broadleyi</i>	KU761268	KU761276	KU761284	KU761292
<i>Nothophryne cf. broadleyi</i>	KU761269	KU761277	KU761285	KU761293
<i>Nothophryne cf. broadleyi</i>	KU761270	KU761278	KU761286	KU761294
<i>Nothophryne cf. broadleyi</i>	KU761271	KU761279	KU761287	KU761295
<i>Nothophryne cf. broadleyi</i>	KU761272	KU761280	KU761288	KU761296
<i>Nothophryne cf. broadleyi</i>	KU761273	KU761281	KU761289	KU761297
<i>Nothophryne cf. broadleyi</i>	KU761274	KU761282	KU761290	KU761298
<i>Nothophryne broadleyi</i>	KU761275	KU761283	KU761291	KU761299
<i>Poyntonia paludicola</i>	DQ347058	DQ347341	DQ347283	DQ347402
<i>Petropedetes palmipes</i>	DQ283074	DQ283074	<b>KF693640</b>	DQ283799
<i>Petropedetes yakusini</i>	DQ283415	DQ283415	<b>KF693621</b>	-
<i>Pyxicephalus adspersus</i>	DQ022340	AF215505	<b>DQ019508</b>	<b>DQ019569</b>
<i>Pyxicephalus edulis</i>	DQ022341	DQ022366	<b>KF991338</b>	DQ283853
<i>Strongylopus bonaespei</i>	DQ347063	DQ347345	DQ347288	DQ347409
<i>Strongylopus fasciatus</i>	DQ019594	AF215412	DQ019513	<b>DQ019574</b>
<i>Strongylopus grayii</i>	DQ347028	DQ283068	DQ347256	DQ283793
<i>Tomopterna cf. tandyi</i>	<b>DQ347009</b>	<b>DQ347009</b>	<b>DQ347240</b>	<b>DQ347360</b>
<i>Tomopterna cryptotis</i>	AF371199	AY255090	-	-
<i>Tomopterna damarensis</i>	-	AY255091	-	-
<i>Tomopterna delalandii</i>	DQ283403	AY255086	-	DQ284014
<i>Tomopterna krugerensis</i>	AF371208	AY255098	-	-
<i>Tomopterna luganga</i>	<b>HQ700695</b>	DQ017056	-	-
<i>Tomopterna marmorata</i>	AF371204	AY255084	-	-
<i>Tomopterna tandyi</i>	AF371190	AF436071	-	-
<i>Tomopterna tuberculosa</i>	AF371214	AY255100	-	-





**TABLE S2. Diversification time calculated from a concatenated alignment (12S, 16S, RAG1, RHOD), using secondary calibration from Meijden et al. (2005).** Refer to the Material and Methods section for analysis details. Only taxa that are estimated to have diverged within the past 15 million years were included to reduce effects of saturation.

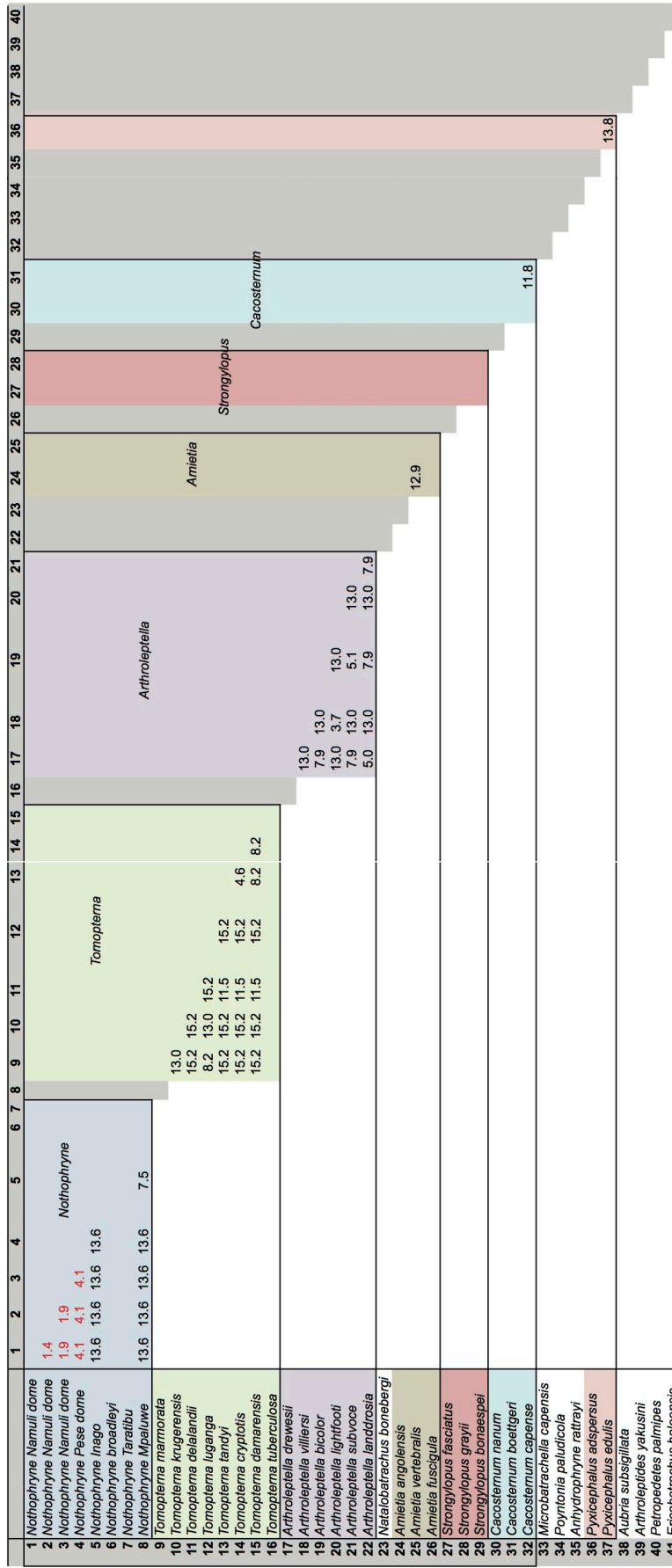



# SUPPLEMENTARY MATERIALS

Chapter II

Appendix A

Appendix B

Appendix A

TABLE A1. *Hyperolius substriatus* locality data, specimen voucher and GenBank accession numbers. MOZ (Mozambique), MWI (Malawi), TNZ (Tanzania).

Species	ID	Population	Locality	Country	Latitude	Longitude	16S	ND2	c-Myc	POMC
<i>H. substriatus</i>	FMNH 274262	Mafwomero	Rubeho	TNZ	-6.892500	36.572830	-	HM772735	HM772601; HM772602	HM772929; HM772930
<i>H. substriatus</i>	FMNH 274263	Mafwomero	Rubeho	TNZ	-6.892500	36.572830	+	HM772736	HM772603; HM772604	HM772933; HM772934
<i>H. substriatus</i>	FMNH 274264	Mafwomero	Rubeho	TNZ	-6.892500	36.572830	-	HM772737	HM772605; HM772606	HM772935; HM772936
<i>H. substriatus</i>	FMNH 274265	Mafwomero	Rubeho	TNZ	-6.892500	36.572830	-	HM772738	HM772607; HM772608	HM772935; HM772936
<i>H. substriatus</i>	FMNH 274266	Mafwomero	Rubeho	TNZ	-6.892500	36.572830	-	HM772739	HM772609; HM772610	HM772937; HM772938
<i>H. substriatus</i>	FMNH 274267	Mafwomero	Rubeho	TNZ	-6.892500	36.572830	-	-	HM772611; HM772612	HM772939; HM772940
<i>H. substriatus</i>	FMNH 274268	Mafwomero	Rubeho	TNZ	-6.892500	36.572830	-	-	HM772613; HM772614	HM772941; HM772942
<i>H. substriatus</i>	FMNH 274269	Mafwomero	Rubeho	TNZ	-6.892500	36.572830	-	-	HM772615; HM772616	HM772943; HM772944
<i>H. substriatus</i>	FMNH 274270	Mafwomero	Rubeho	TNZ	-6.892500	36.572830	-	-	HM772617; HM772618	HM772945; HM772946
<i>H. substriatus</i>	FMNH 274273	U. South	Uluguru	TNZ	-7.084240	37.577750	-	HM772745	HM772629; HM772630	HM772903; HM772904
<i>H. substriatus</i>	FMNH 274277	U. South	Uluguru	TNZ	-7.084240	37.577750	+	HM772747	-	HM772905; HM772906
<i>H. substriatus</i>	FMNH 274291	Ivalla River	Udzungwa	TNZ	-8.329500	35.939983	+	HM772730	HM772585; HM772586	HM772879; HM772880
<i>H. substriatus</i>	FMNH 274292	Ivalla River	Udzungwa	TNZ	-8.329500	35.939983	-	HM772731	HM772587; HM772588	HM772881; HM772882
<i>H. substriatus</i>	FMNH 274293	Ivalla River	Udzungwa	TNZ	-8.329500	35.939983	-	HM772732	HM772589; HM772590	HM772883; HM772884
<i>H. substriatus</i>	FMNH 274294	Ivalla River	Udzungwa	TNZ	-8.329500	35.939983	-	HM772733	HM772591; HM772592	HM772885; HM772886
<i>H. substriatus</i>	FMNH 274295	Ivalla River	Udzungwa	TNZ	-8.329500	35.939983	-	HM772734	HM772593; HM772594	HM772887; HM772888
<i>H. substriatus</i>	FMNH 274296	Ivalla River	Udzungwa	TNZ	-8.329500	35.939983	-	-	HM772595; HM772596	HM772889; HM772890
<i>H. substriatus</i>	FMNH 274297	Ivalla River	Udzungwa	TNZ	-8.329500	35.939983	-	-	HM772597; HM772598	HM772891; HM772892
<i>H. substriatus</i>	FMNH 274298	Ivalla River	Udzungwa	TNZ	-8.329500	35.939983	-	-	HM772599; HM772600	-
<i>H. substriatus</i>	FMNH 274338	Dabaga	Udzungwa	TNZ	-8.099550	35.898480	-	HM772697	-	HM772813; HM772814
<i>H. substriatus</i>	FMNH 274339	Dabaga	Udzungwa	TNZ	-8.099550	35.898480	-	HM772700	-	HM772819; HM772820
<i>H. substriatus</i>	FMNH 274340	Dabaga	Udzungwa	TNZ	-8.099550	35.898480	-	HM772698	-	HM772815; HM772816
<i>H. substriatus</i>	FMNH 274341	Dabaga	Udzungwa	TNZ	-8.099550	35.898480	-	HM772699	HM772537; HM772538	HM772817; HM772818
<i>H. substriatus</i>	FMNH 274342	Dabaga	Udzungwa	TNZ	-8.099550	35.898480	-	HM772701	HM772539; HM772540	HM772821; HM772822
<i>H. substriatus</i>	FMNH 274343	Dabaga	Udzungwa	TNZ	-8.120580	35.899700	-	HM772702	HM772541; HM772542	HM772825; HM772826
<i>H. substriatus</i>	FMNH 274344	Dabaga	Udzungwa	TNZ	-8.120580	35.899700	-	HM772703	HM772545; HM772546	HM772827; HM772828
<i>H. substriatus</i>	FMNH 274345	Dabaga	Udzungwa	TNZ	-8.120580	35.899700	-	HM772704	HM772547; HM772548	HM772829; HM772830
<i>H. substriatus</i>	FMNH 274346	Dabaga	Udzungwa	TNZ	-8.120580	35.899700	-	HM772705	HM772549; HM772550	-
<i>H. substriatus</i>	FMNH 274347	Dabaga	Udzungwa	TNZ	-8.120580	35.899700	-	HM772706	HM772551; HM772552	HM772831; HM772832
<i>H. substriatus</i>	FMNH 274351	Malundwe	Malundwe	TNZ	-7.370050	37.117217	-	HM772707	HM772553; HM772554	HM772833; HM772834
<i>H. substriatus</i>	FMNH 274352	Malundwe	Malundwe	TNZ	-7.370050	37.117217	+	HM772708	HM772555; HM772556	HM772835; HM772836
<i>H. substriatus</i>	FMNH 274353	Malundwe	Malundwe	TNZ	-7.370050	37.117217	-	HM772709	HM772557; HM772558	HM772837; HM772838
<i>H. substriatus</i>	FMNH 274354	Malundwe	Malundwe	TNZ	-7.370050	37.117217	-	HM772710	HM772559; HM772560	HM772839; HM772840
<i>H. substriatus</i>	FMNH 274355	Malundwe	Malundwe	TNZ	-7.370050	37.117217	-	HM772711	HM772561; HM772562	HM772841; HM772842

SUPPLEMENTARY MATERIALS: CHAPTER II

Species	ID	Population	Locality	Country	Latitude	Longitude	16S	ND2	c-Myc	POMC
<i>H. substriatus</i>	FMNH 274356	Malundwe	Malundwe	TNZ	-7.370050	37.117217	-	HM772712	-	HM772843; HM772844
<i>H. substriatus</i>	FMNH 274357	Malundwe	Malundwe	TNZ	-7.370050	37.117217	-	HM772713	HM772563; HM772564	HM772845; HM772846
<i>H. substriatus</i>	FMNH 274358	Malundwe	Malundwe	TNZ	-7.370050	37.117217	-	HM772714	HM772565; HM772566	HM772847; HM772848
<i>H. substriatus</i>	FMNH 274359	Malundwe	Malundwe	TNZ	-7.370050	37.117217	-	HM772715	HM772567; HM772568	HM772849; HM772850
<i>H. substriatus</i>	FMNH 274370	Dabaga	Udzungwa	TNZ	-8.099550	35.898480	-	-	HM772543; HM772544	HM772823; HM772824
<i>H. substriatus</i>	FMNH 274405	Shume Magamba	West Usambaras	TNZ	-4.726000	38.249450	-	HM772723	-	HM772865; HM772866
<i>H. substriatus</i>	FMNH 274441	Mtai	East Usambaras	TNZ	-4.826450	38.788220	-	HM772682	HM772507; HM772508	HM772781; HM772782
<i>H. substriatus</i>	FMNH 274442	Mtai	East Usambaras	TNZ	-4.826450	38.788220	-	HM772683	HM772509; HM772510	HM772783; HM772784
<i>H. substriatus</i>	FMNH 274443	Mtai	East Usambaras	TNZ	-4.826450	38.788220	-	HM772684	HM772511; HM772512	HM772785; HM772786
<i>H. substriatus</i>	FMNH 274444	Mtai	East Usambaras	TNZ	-4.826450	38.788220	-	HM772685	HM772513; HM772514	HM772787; HM772788
<i>H. substriatus</i>	FMNH 274445	Mtai	East Usambaras	TNZ	-4.826450	38.788220	-	HM772686	HM772515; HM772516	HM772789; HM772790
<i>H. substriatus</i>	FMNH 274446	Mtai	East Usambaras	TNZ	-4.826450	38.788220	+	HM772687	HM772517; HM772518	HM772791; HM772792
<i>H. substriatus</i>	FMNH 274447	Mtai	East Usambaras	TNZ	-4.826450	38.788220	-	HM772688	HM772519; HM772520	HM772793; HM772794
<i>H. substriatus</i>	FMNH 274448	Mtai	East Usambaras	TNZ	-4.826450	38.788220	-	HM772689	HM772521; HM772522	HM772795; HM772796
<i>H. substriatus</i>	FMNH 274449	Mtai	East Usambaras	TNZ	-4.826450	38.788220	-	HM772690	HM772523; HM772524	HM772797; HM772798
<i>H. substriatus</i>	FMNH 274450	Mtai	East Usambaras	TNZ	-4.826450	38.788220	-	HM772691	-	HM772799; HM772800
<i>H. substriatus</i>	FMNH 274459	Magorotto	East Usambaras	TNZ	-5.113300	38.752570	+	HM772692	HM772525; HM772526	HM772801; HM772802
<i>H. substriatus</i>	FMNH 274460	Magorotto	East Usambaras	TNZ	-5.113300	38.752570	-	HM772693	HM772527; HM772528	HM772803; HM772804
<i>H. substriatus</i>	FMNH 274461	Magorotto	East Usambaras	TNZ	-5.113300	38.752570	-	HM772694	HM772529; HM772530	HM772805; HM772806
<i>H. substriatus</i>	FMNH 274462	Magorotto	East Usambaras	TNZ	-5.113300	38.752570	-	HM772695	HM772531; HM772532	HM772807; HM772808
<i>H. substriatus</i>	FMNH 274463	Magorotto	East Usambaras	TNZ	-5.113300	38.752570	-	HM772696	HM772533; HM772534	HM772809; HM772810
<i>H. substriatus</i>	FMNH 274464	Magorotto	East Usambaras	TNZ	-5.113300	38.752570	+	+	+	+
<i>H. substriatus</i>	FMNH 274466	Nilo	East Usambaras	TNZ	-4.895950	38.641350	-	HM772677	HM772497; HM772498	HM772771; HM772772
<i>H. substriatus</i>	FMNH 274467	Nilo	East Usambaras	TNZ	-4.895950	38.641350	-	HM772678	HM772499; HM772500	HM772773; HM772774
<i>H. substriatus</i>	FMNH 274468	Nilo	East Usambaras	TNZ	-4.895950	38.641350	-	HM772679	HM772501; HM772502	HM772775; HM772776
<i>H. substriatus</i>	FMNH 274469	Nilo	East Usambaras	TNZ	-4.895950	38.641350	-	HM772680	HM772503; HM772504	HM772777; HM772778
<i>H. substriatus</i>	FMNH 274470	Nilo	East Usambaras	TNZ	-4.895950	38.641350	-	HM772681	HM772505; HM772506	HM772779; HM772780
<i>H. substriatus</i>	FMNH 274473	Nguru South	Nguru/Nguu	TNZ	-5.999850	37.520933	-	HM772748	HM772641; HM772642	HM772951; HM772952
<i>H. substriatus</i>	FMNH 274475	Bunduki	Uluguru	TNZ	-7.029035	37.627190	-	HM772740	HM772619; HM772620	HM772893; HM772894
<i>H. substriatus</i>	FMNH 274476	Bunduki	Uluguru	TNZ	-7.029035	37.627190	-	HM772741	HM772621; HM772622	HM772895; HM772896
<i>H. substriatus</i>	FMNH 274477	Bunduki	Uluguru	TNZ	-7.029035	37.627190	-	HM772742	HM772623; HM772624	HM772897; HM772898
<i>H. substriatus</i>	FMNH 274478	Bunduki	Uluguru	TNZ	-7.029035	37.627190	-	HM772743	HM772625; HM772626	HM772899; HM772900
<i>H. substriatus</i>	FMNH 274479	Bunduki	Uluguru	TNZ	-7.029035	37.627190	-	HM772744	HM772627; HM772628	HM772901; HM772902
<i>H. substriatus</i>	FMNH 274506	Shume Magamba	West Usambaras	TNZ	-4.726000	38.249450	-	HM772721	-	HM772861; HM772862
<i>H. substriatus</i>	FMNH 274507	Shume Magamba	West Usambaras	TNZ	-4.726000	38.249450	-	HM772722	HM772573; HM772574	HM772863; HM772864
<i>H. substriatus</i>	FMNH 274508	Shume Magamba	West Usambaras	TNZ	-4.726000	38.249450	-	HM772724	-	HM772867; HM772868
<i>H. substriatus</i>	FMNH 274526	Mazumbai	West Usambaras	TNZ	-4.829116	38.512730	-	HM772716	HM772569; HM772570	HM772851; HM772852
<i>H. substriatus</i>	FMNH 274527	Mazumbai	West Usambaras	TNZ	-4.829116	38.512730	-	HM772717	-	HM772853; HM772854

Species	ID	Population	Locality	Country	Latitude	Longitude	16S	ND2	c-Myc	POMC
<i>H. substriatus</i>	FMNH 274528	Mazumbai	West Usambaras	TNZ	-4.829116	38.512730	-	HM772718	-	HM772855; HM772856
<i>H. substriatus</i>	FMNH 274529	Mazumbai	West Usambaras	TNZ	-4.829116	38.512730	-	HM772719	-	HM772857; HM772858
<i>H. substriatus</i>	FMNH 274530	Mazumbai	West Usambaras	TNZ	-4.829116	38.512730	-	HM772720	HM772571; HM772572	HM772859; HM772860
<i>H. substriatus</i>	FMNH 274888	Namizimu Reserve	Namizimu	MWI	-14.243920	35.392160	-	KC257273	KC257214	KC257153
<i>H. substriatus</i>	FMNH 274951	Vipya, dam1	Vipya Plateau	MWI	-12.113860	33.724570	-	KC257244	KC257184	KC257125
<i>H. substriatus</i>	FMNH 274952	Vipya, dam1	Vipya Plateau	MWI	-12.113860	33.724570	-	KC257246	KC257186	KC257127
<i>H. substriatus</i>	FMNH 274953	Vipya, dam1	Vipya Plateau	MWI	-12.113860	33.724570	-	-	KC257187	KC257128
<i>H. substriatus</i>	FMNH 274954	Vipya, dam1	Vipya Plateau	MWI	-12.113860	33.724570	-	KC257247	KC257188	-
<i>H. substriatus</i>	FMNH 274955	Vipya, dam1	Vipya Plateau	MWI	-12.113860	33.724570	-	KC257251	KC257192	KC257132
<i>H. substriatus</i>	FMNH 274956	Vipya, dam3	Vipya Plateau	MWI	-11.665650	33.761300	-	KC257264	KC257205	KC257144
<i>H. substriatus</i>	FMNH 275001	Ambangulu	West Usambaras	TNZ	-5.072730	38.433517	-	HM772725	HM772575; HM772576	HM772869; HM772870
<i>H. substriatus</i>	FMNH 275002	Ambangulu	West Usambaras	TNZ	-5.072730	38.433517	-	HM772726	HM772577; HM772578	HM772871; HM772872
<i>H. substriatus</i>	FMNH 275003	Ambangulu	West Usambaras	TNZ	-5.072730	38.433517	-	HM772727	HM772579; HM772580	HM772873; HM772874
<i>H. substriatus</i>	FMNH 275004	Ambangulu	West Usambaras	TNZ	-5.072730	38.433517	-	HM772728	HM772581; HM772582	HM772875; HM772876
<i>H. substriatus</i>	FMNH 275005	Ambangulu	West Usambaras	TNZ	-5.072730	38.433517	-	HM772729	HM772583; HM772584	HM772877; HM772878
<i>H. substriatus</i>	FMNH 275101	Misuku Hills	Misuku Hills	MWI	-9.662250	33.531050	-	HM772761	HM772661; HM772662	HM772913; HM772914
<i>H. substriatus</i>	FMNH 275102	Nyika valley 1	Nyika Plateau	MWI	-10.347100	33.816860	-	KC257232	KC257172	KC257113
<i>H. substriatus</i>	FMNH 275103	Nyika valley 1	Nyika Plateau	MWI	-10.347100	33.816860	-	KC257233	KC257173	KC257114
<i>H. substriatus</i>	FMNH 275104	Nyika valley 2	Nyika Plateau	MWI	-10.825200	33.602830	-	KC257236	KC257176	KC257117
<i>H. substriatus</i>	FMNH 275105	Nyika valley 2	Nyika Plateau	MWI	-10.825200	33.602830	-	KC257238	KC257178	KC257119
<i>H. substriatus</i>	FMNH 275106	Vipya, dam3	Vipya Plateau	MWI	-11.665650	33.761300	-	KC257261	KC257202	KC257141
<i>H. substriatus</i>	FMNH 275107	Misuku Hills	Misuku Hills	MWI	-9.662250	33.531050	-	HM772758	HM772655; HM772656	HM772907; HM772908
<i>H. substriatus</i>	FMNH 275108	Misuku Hills	Misuku Hills	MWI	-9.662250	33.531050	-	HM772760	HM772659; HM772660	HM772911; HM772912
<i>H. substriatus</i>	FMNH 275109	Misuku Hills	Misuku Hills	MWI	-9.662250	33.531050	-	HM772762	HM772663; HM772664	HM772915; HM772916
<i>H. substriatus</i>	FMNH 275110	Misuku Hills	Misuku Hills	MWI	-9.662250	33.531050	-	HM772763	HM772665; HM772666	HM772917; HM772918
<i>H. substriatus</i>	FMNH 275111	Misuku Hills	Misuku Hills	MWI	-9.662250	33.531050	-	HM772765	HM772669; HM772670	HM772921; HM772922
<i>H. substriatus</i>	FMNH 275112	Misuku Hills	Misuku Hills	MWI	-9.662250	33.531050	-	HM772766	HM772671; HM772672	HM772923; HM772924
<i>H. substriatus</i>	FMNH 275113	Misuku Hills	Misuku Hills	MWI	-9.662250	33.531050	-	HM772767	HM772673; HM772674	HM772925; HM772926
<i>H. substriatus</i>	FMNH 275153	Mt Mulanje	Mulanje	MWI	-16.013660	35.651750	-	KC257275	KC257217	KC257156
<i>H. substriatus</i>	FMNH 275154	Mt Mulanje	Mulanje	MWI	-16.013660	35.651750	-	-	KC257215	KC257154
<i>H. substriatus</i>	FMNH 275155	Vipya, dam3	Vipya Plateau	MWI	-11.665650	33.761300	-	KC257259	KC257200	KC257139
<i>H. substriatus</i>	FMNH 275156	Nyika valley 1	Nyika Plateau	MWI	-10.347100	33.816860	-	KC257226	KC257166	KC257107
<i>H. substriatus</i>	FMNH 275157	Vipya, dam3	Vipya Plateau	MWI	-11.665650	33.761300	-	KC257256	KC257197	KC257137
<i>H. substriatus</i>	FMNH 275158	Vipya, dam3	Vipya Plateau	MWI	-11.665650	33.761300	-	KC257260	KC257201	KC257140
<i>H. substriatus</i>	FMNH 275159	Mt Mulanje	Mulanje	MWI	-16.013660	35.651750	-	KC257277	KC257219	KC257158
<i>H. substriatus</i>	FMNH 275160	Vipya, dam3	Vipya Plateau	MWI	-11.665650	33.761300	-	KC257258	KC257199	-
<i>H. substriatus</i>	FMNH 275161	Mt Mulanje	Mulanje	MWI	-16.013660	35.651750	-	KC257274	KC257216	KC257155
<i>H. substriatus</i>	FMNH 275162	Vipya, dam3	Vipya Plateau	MWI	-11.665650	33.761300	-	KC257262	KC257203	KC257142

SUPPLEMENTARY MATERIALS: CHAPTER II

Species	ID	Population	Locality	Country	Latitude	Longitude	16S	ND2	c-Myc	POMC
<i>H. substriatus</i>	FMNH 275163	Misuku Hills	Misuku Hills	MWI	-9.66250	33.531050	-	-	HM772675; HM772676	HM772927; HM772928
<i>H. substriatus</i>	FMNH 275164	Vipya, dam3	Vipya Plateau	MWI	-11.665650	33.761300	-	KC257263	KC257204	KC257143
<i>H. substriatus</i>	FMNH 275165	Nyika valley 2	Nyika Plateau	MWI	-10.825200	33.602830	-	KC257234	KC257174	KC257115
<i>H. substriatus</i>	FMNH 275166	Mt Mulanje	Mulanje	MWI	-16.013660	35.651750	-	KC257278	KC257220	KC257159
<i>H. substriatus</i>	FMNH 275167	Vipya, dam1	Vipya Plateau	MWI	-12.113860	33.724570	-	KC257245	KC257185	KC257126
<i>H. substriatus</i>	FMNH 275169	Mt Mulanje	Mulanje	MWI	-16.013660	35.651750	-	KC257281	KC257222	KC257162
<i>H. substriatus</i>	FMNH 275170	Mt Mulanje	Mulanje	MWI	-16.013660	35.651750	+	KC257276	KC257218	KC257157
<i>H. substriatus</i>	FMNH 275171	Vipya, dam3	Vipya Plateau	MWI	-11.665650	33.761300	-	KC257257	KC257198	KC257138
<i>H. substriatus</i>	FMNH 275172	Namizimu Reserve	Namizimu	MWI	-14.243920	35.392160	-	KC257270	KC257211	KC257150
<i>H. substriatus</i>	FMNH 275173	Mt Mulanje	Mulanje	MWI	-16.013660	35.651750	-	KC257279	KC257221	KC257160
<i>H. substriatus</i>	FMNH 275174	Mt Mulanje	Mulanje	MWI	-16.013660	35.651750	-	KC257280	-	KC257161
<i>H. substriatus</i>	FMNH 275175	Vipya, dam2	Vipya Plateau	MWI	-11.698090	33.949800	-	KC257253	KC257194	KC257134
<i>H. substriatus</i>	FMNH 275176	Vipya, dam2	Vipya Plateau	MWI	-11.698090	33.949800	-	KC257255	KC257196	KC257136
<i>H. substriatus</i>	FMNH 275177	Vipya, dam1	Vipya Plateau	MWI	-12.113860	33.724570	-	KC257248	KC257189	KC257129
<i>H. substriatus</i>	FMNH 275178	Vipya, dam1	Vipya Plateau	MWI	-12.113860	33.724570	-	KC257250	KC257191	KC257131
<i>H. substriatus</i>	FMNH 275179	Namizimu Reserve	Namizimu	MWI	-14.243920	35.392160	+	KC257265	KC257206	KC257145
<i>H. substriatus</i>	FMNH 275180	Mt Mulanje	Mulanje	MWI	-16.013660	35.651750	-	-	KC257223	KC257163
<i>H. substriatus</i>	FMNH 275181	Vipya, dam2	Vipya Plateau	MWI	-11.698090	33.949800	-	KC257254	KC257195	KC257135
<i>H. substriatus</i>	FMNH 275182	Vipya, dam1	Vipya Plateau	MWI	-12.113860	33.724570	-	KC257243	KC257183	KC257124
<i>H. substriatus</i>	FMNH 275183	Vipya, dam1	Vipya Plateau	MWI	-12.113860	33.724570	-	KC257249	KC257190	KC257130
<i>H. substriatus</i>	FMNH 275184	Namizimu Reserve	Namizimu	MWI	-14.243920	35.392160	-	KC257268	KC257209	KC257148
<i>H. substriatus</i>	FMNH 275185	Namizimu Reserve	Namizimu	MWI	-14.243920	35.392160	-	KC257267	KC257208	KC257147
<i>H. substriatus</i>	FMNH 275186	Namizimu Reserve	Namizimu	MWI	-14.243920	35.392160	-	KC257269	KC257210	KC257149
<i>H. substriatus</i>	FMNH 275188	Namizimu Reserve	Namizimu	MWI	-14.243920	35.392160	-	KC257266	KC257212	KC257146
<i>H. substriatus</i>	FMNH 275189	Misuku Hills	Misuku Hills	MWI	-9.66250	33.531050	-	-	KC257207	HM772909; HM772910
<i>H. substriatus</i>	FMNH 275190	Nyika valley 2	Nyika Plateau	MWI	-10.825200	33.602830	-	KC257239	KC257179	KC257120
<i>H. substriatus</i>	FMNH 275191	Misuku Hills	Misuku Hills	MWI	-9.66250	33.531050	-	-	-	HM772919; HM772920
<i>H. substriatus</i>	FMNH 275192	Namizimu Reserve	Namizimu	MWI	-14.243920	35.392160	-	KC257272	KC257213	KC257152
<i>H. substriatus</i>	FMNH 275194	Vipya, dam2	Vipya Plateau	MWI	-11.698090	33.949800	-	KC257252	KC257193	KC257133
<i>H. substriatus</i>	FMNH 275216	Nyika valley 2	Nyika Plateau	MWI	-10.825200	33.602830	-	KC257240	KC257180	KC257121
<i>H. substriatus</i>	FMNH 275217	Nyika valley 2	Nyika Plateau	MWI	-10.825200	33.602830	-	KC257235	KC257175	KC257116
<i>H. substriatus</i>	FMNH 275218	Nyika valley 1	Nyika Plateau	MWI	-10.347100	33.816860	-	KC257231	KC257171	KC257112
<i>H. substriatus</i>	FMNH 275219	Nyika valley 1	Nyika Plateau	MWI	-10.347100	33.816860	-	KC257230	KC257170	KC257111
<i>H. substriatus</i>	FMNH 275220	Nyika valley 1	Nyika Plateau	MWI	-10.347100	33.816860	-	KC257229	KC257169	KC257110
<i>H. substriatus</i>	FMNH 275222	Nyika valley 1	Nyika Plateau	MWI	-10.347100	33.816860	-	KC257225	KC257165	KC257106
<i>H. substriatus</i>	FMNH 275223	Nyika valley 2	Nyika Plateau	MWI	-10.825200	33.602830	-	KC257237	KC257177	KC257118
<i>H. substriatus</i>	FMNH 275224	Nyika valley 1	Nyika Plateau	MWI	-10.347100	33.816860	-	KC257228	KC257168	KC257109
<i>H. substriatus</i>	FMNH 275225	Nyika valley 2	Nyika Plateau	MWI	-10.825200	33.602830	-	KC257241	KC257181	KC257122



Species	ID	Population	Locality	Country	Latitude	Longitude	16S	ND2	c-Myc	POMC
<i>H. substriatus</i>	FMNH 275226	Nyika valley 2	Nyika Plateau	MWI	-10.825200	33.602830	-	KC257242	KC257182	KC257123
<i>H. substriatus</i>	FMNH 275227	Nyika valley 1	Nyika Plateau	MWI	-10.347100	33.816860	+	KC257227	KC257167	KC257108
<i>H. substriatus</i>	KMH36219	Ukwiva	Rubebo	TNZ	-7.045000	36.650000	+	HM772769	HM772631; HM772632	HM772947; HM772948
<i>H. substriatus</i>	KMH36220	Ukwiva	Rubebo	TNZ	-7.045000	36.650000	-	HM772770	HM772633; HM772634	HM772949; HM772950
<i>H. substriatus</i>	IMSN 7454	Sakara Nyumo FR	Southern Highlands	TNZ	-9.838898	34.607815	-	KC257282	KC257224	KC257164
<i>H. substriatus</i>	IMSN 8197	Nguru South	Nguru/Nguu	TNZ	-6.030439	37.525642	-	HM772749	HM772635; HM772636	-
<i>H. substriatus</i>	IMSN 8438	Nguru South	Nguru/Nguu	TNZ	-6.030439	37.525642	-	HM772750	HM772637; HM772638	-
<i>H. substriatus</i>	IMSN 8442	Nguru South	Nguru/Nguu	TNZ	-6.030439	37.525642	-	HM772751	HM772639; HM772640	HM772957; HM772958
<i>H. substriatus</i>	MVZ 265976	Serra Jeci	Serra Jeci	MOZ	-12.840110	35.184500	+	+	+	+
<i>H. substriatus</i>	MVZ 265977	Serra Jeci	Serra Jeci	MOZ	-12.840110	35.184500	+	+	+	+
<i>H. substriatus</i>	MVZ 265978	Serra Jeci	Serra Jeci	MOZ	-12.840110	35.184500	+	+	+	+
<i>H. substriatus</i>	MVZ 266026	Mount Namuli	Mount Namuli	MOZ	-15.384200	37.071900	+	+	+	+
<i>H. substriatus</i>	MVZ 266027	Mount Namuli	Mount Namuli	MOZ	-15.384200	37.071900	+	+	+	+
<i>H. substriatus</i>	MVZ 266031	Mount Namuli	Mount Namuli	MOZ	-15.384200	37.071900	+	+	+	+
<i>H. substriatus</i>	MW 06599 BMNH	Nguu	Nguru/Nguu	TNZ	-5.480278	37.475278	-	HM772753	HM772645; HM772646	-
<i>H. substriatus</i>	MW 06608 BMNH	Nguu	Nguru/Nguu	TNZ	-5.480278	37.475278	-	HM772754	HM772647; HM772648	-
<i>H. substriatus</i>	MW 07104 BMNH	Nguru South	Nguru/Nguu	TNZ	-6.051220	37.882300	-	HM772755	HM772649; HM772650	HM772959; HM772960
<i>H. substriatus</i>	MW 07212 BMNH	Nguru South	Nguru/Nguu	TNZ	-6.051220	37.882300	-	HM772756	HM772651; HM772652	HM772963; HM772964
<i>H. substriatus</i>	MW 07214 BMNH	Nguru South	Nguru/Nguu	TNZ	-6.051220	37.882300	-	HM772757	HM772653; HM772654	HM772965; HM772966
<i>H. substriatus</i>	HM 1783	Zomba plateau, trout farm	Zomba	MWI	-15.354160	35.301286	+	+	+	+
<i>H. substriatus</i>	CB 13.227	Noto Plateau, Lindi, TNZ	Coastal Region	TNZ	-9.895320	39.374090	+	+	+	+
<i>H. substriatus</i>	WC 3008	Mount Mabu	Mount Mabu	Moz	-16.281528	36.443778	+	+	+	+
<i>H. substriatus</i>	WC 3253	Mount Namuli	Mount Namuli	MOZ	-15.389944	37.067361	+	+	+	+
<i>H. substriatus</i>	SL 2305	Chiperone	Chiperone	MOZ	-16.480944	35.729472	+	+	+	+
<i>H. mitchelli</i>	FMNH 275030	Uluguru North	Uluguru	TNZ	-6.941436	37.719200	-	HM772487	HM772426; HM772427	HM772356; HM772357

Appendix B

TABLE B1. Best partition scheme and substitution model selected using BIC.

Marker	Analysis	Partition scheme	Substitution model
Mitochondrial	RAxML	3 partitions: (16S, ND2_p1) (ND2_p2) (ND2_p3)	P1-3: GTR+G
Mitochondrial	BEAST	3 partitions: (16S, ND2_p1) (ND2_p2) (ND2_p3)	P1, P2: HKY+G; P3: GTR+G
C-myc	RAxML	1 partition	P1: GTR+G
C-myc	BEAST	2 partitions: (cmyc_p1, p2) (cmyc_p3-p7)	P1: K80; P2: K80+I
POMC	RAxML	1 partition	GTR+G
POMC	BEAST	2 partitions: (POMC_p1, p3) (POMC_p2)	P1: TrNef+I+G; P2: HKY
Multilocus	RAxML	5 partitions: (16S, ND2_p1) (ND2_p2) (ND2_p3) (cmyc_p1, p2, p4, p5, p6, pome_p1, p2) (cmyc_p3, p7, pomc_p3)	GTR+G
Multilocus	BEAST	6 partitions: (16S, ND2_p1) (ND2_p2) (ND2_p3) (cmyc_p1, p2, p5, p6, pomc_p1, p2) (cmyc_p3, p7, pomc_p3) (cmyc_p4)	P1: HKY+G; P2: HKY+I; P3: GTR+G; P4, P5: TrN+I+G; P6: TrNef+I+G
Multilocus	*BEAST		

**FIGURE B1. Tree topologies from analyses using maximum likelihood (RAxML) and Bayesian inference (BEAST and \*BEAST) of nuclear (a), mitochondrial genes (b), and multilocus trees (c).**

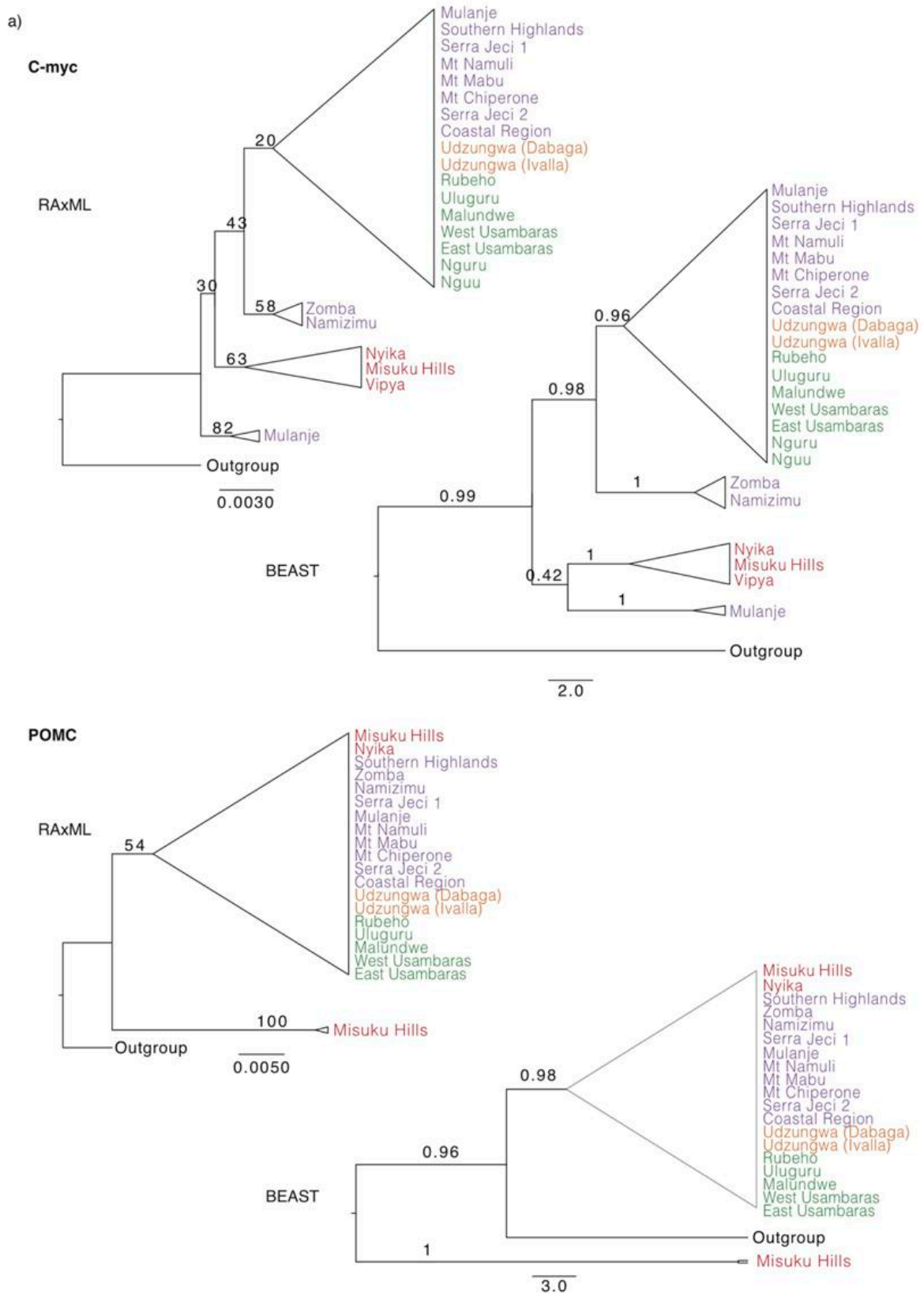

b)

**Mitochondrial**

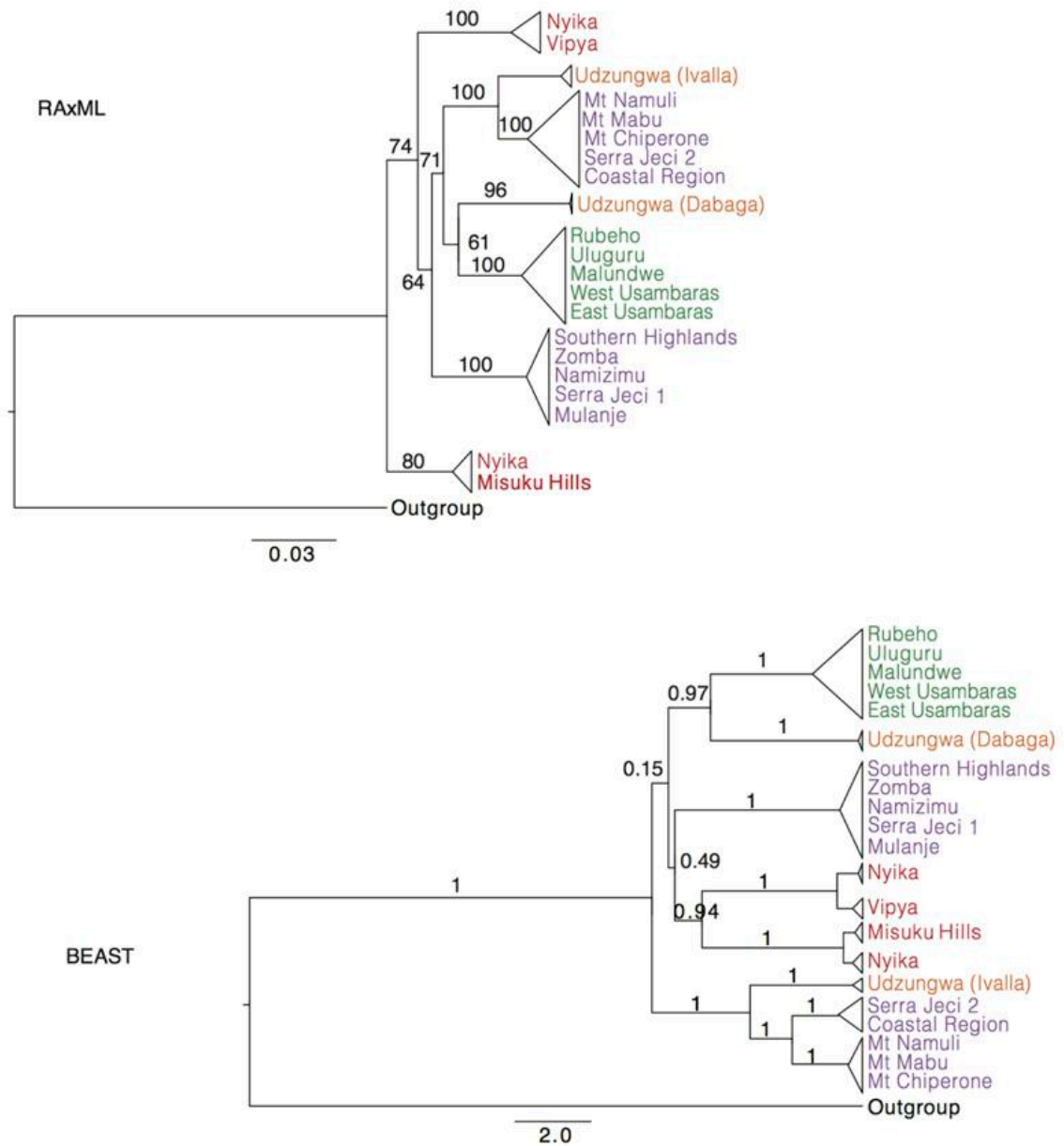

c)

Multilocus

\*BEAST

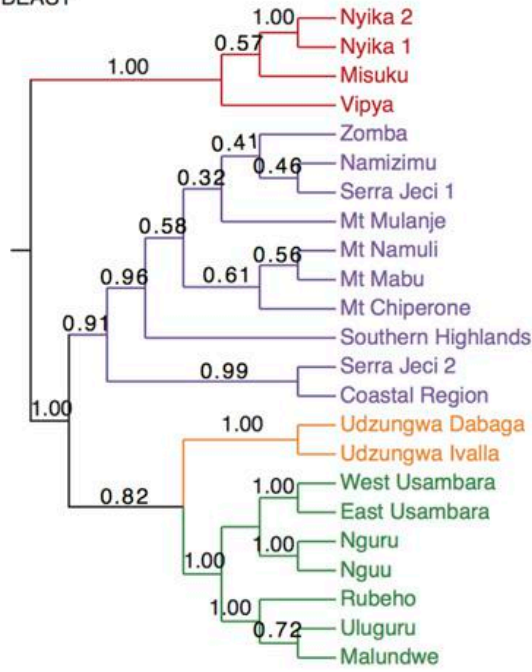

BEAST

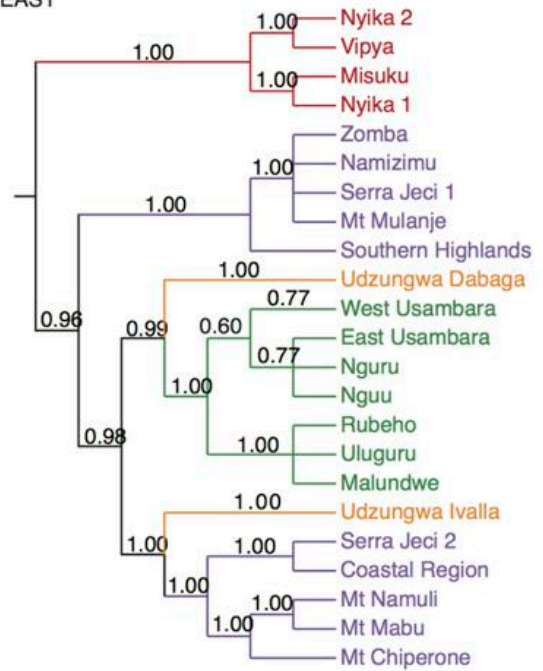

RAxML

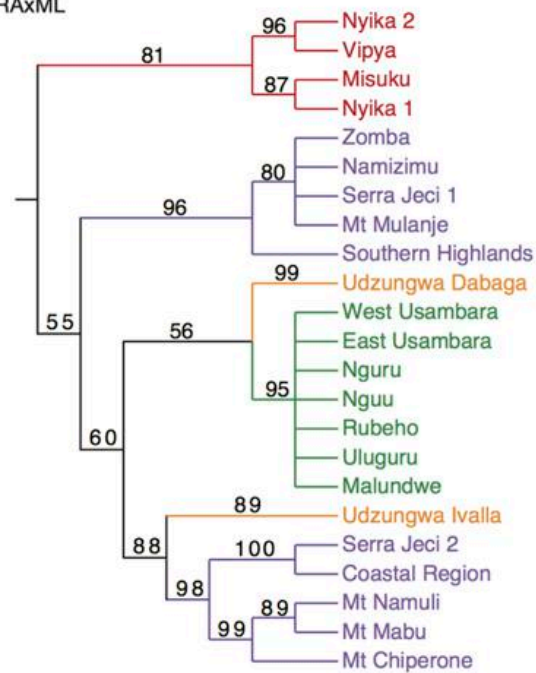

**TABLE B2 Contribution of bioclimatic variables to ENMs and AUC values. Clade 3\* - all populations from clade 3 and the two populations from the Udzungwa Mountains.**

<b>Bioclimatic Variables /AUC</b>	<b>Clade 1</b>	<b>Clade 2</b>	<b>Clade 3*</b>	<b>Lumped</b>
AUC	0.96	0.92	0.97	0.96
Bio 11 - Mean Temperature of Coldest Quarter	<b>65.4</b>	<b>67.7</b>	27.1	<b>49.8</b>
Bio 17 - Precipitation of Driest Quarter	12.4	1.1	<b>39.2</b>	18.4
Bio 13 - Precipitation of Wettest Month	0.1	26.0	0.9	3.8
Bio 4 - Temperature Seasonality (standard deviation *100)	1.3	0.1	13.9	17.9
Bio 2 - Mean Diurnal Range (Mean of monthly: max temp - min temp)	11.5	0.1	0	0.1
Bio 7 - Temperature Annual Range (max warmest month - min coldest month)	9.1	0	12.8	6.0
Bio 18 - Precipitation of Warmest Quarter	0.3	4.9	0.1	0.8
Bio 15 - Precipitation Seasonality (Coefficient of Variation)	0	0	5.8	1.8
Bio 19 - Precipitation of Coldest Quarter	0	0.1	0.1	1.4

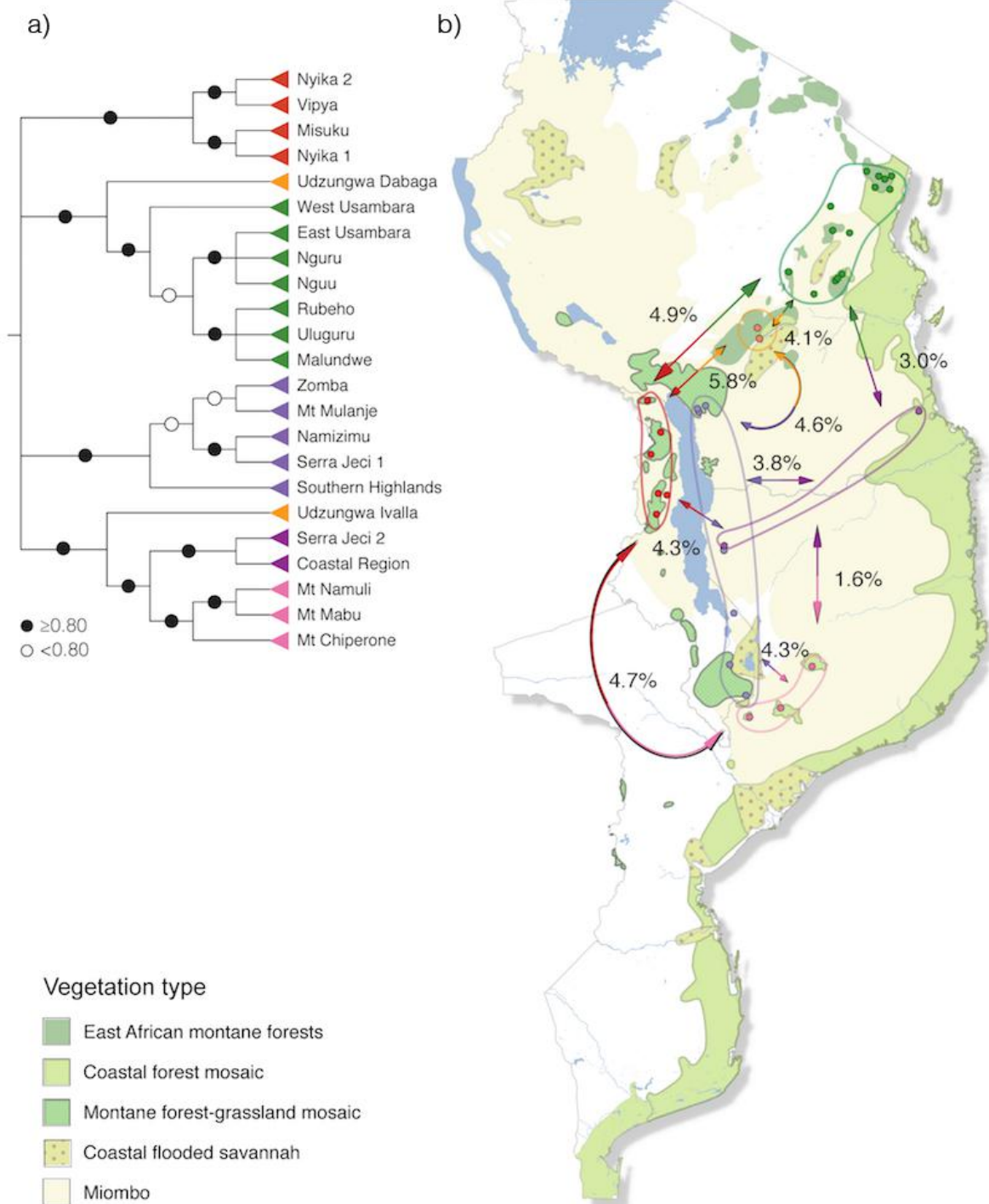

**FIGURE B2.** Tree topology of mitochondrial genes (a), and map showing the distribution of vegetation types and average of uncorrected pairwise-distance of 16S sequences between clades\* (b). The map of vegetation types is derived from the Terrestrial Ecoregions of the World map available at [www.worldwildlife.org/science](http://www.worldwildlife.org/science). (\*) Only one sample from the Udzungwa Mountains (Ivala) was sequenced for the 16S gene.

# SUPPLEMENTARY MATERIALS

Chapter III

Appendix A

Appendix B



Appendix A

**TABLE S1. Samples tissue numbers, vouchers, locality data and GenBank accession numbers.** Specimens included in the morphometric analysis are shown in the last column. *Arthroleptis (A); Cardioglossa (C).*

Species	Tissue ID	Voucher	Country	Locality	Latitude	Longitude	125	16S	COXI	RAG1	Measured
<i>A. stenodactylus</i>	T6769	WC 3866	Angola	Cuito Source 1	-12.300400	18.620700	1	1	1	1	0
<i>A. stenodactylus</i>	T6768	WC 3864	Angola	Cuito Source 2	-12.250500	18.637300	1	1			0
<i>A. stenodactylus</i>	T6772	WC 3870	Angola	Cuito Source 2	-12.505842	18.413816	1	1			0
<i>A. stenodactylus</i>	T6773	WC 3871	Angola	Cuito Source 2	-12.551514	18.414332	1	1			0
<i>A. stenodactylus</i>	T6774	WC 3872	Angola	Cuito Source 2	-12.551514	18.414332	1	1	1	1	0
<i>A. stenodactylus</i>	T6777	WC 4040	Angola	Moxico, Cuonavale source	-13.050844	18.897258	1	1	1	1	0
<i>A. stenodactylus</i>	T6770	WC 3867	Angola	Moxico, Cuito Source 3	-12.359200	18.562800	1	1			0
<i>A. stenodactylus</i>	T6771	WC 3868	Angola	Moxico, Cuito Source 3	-12.359200	18.562800	1	1			0
<i>A. stenodactylus</i>	T6775	WC 3874	Angola	Moxico, Cuito Source 4	-12.689351	18.360115	1	1			0
<i>A. stenodactylus</i>	T6778	WC 4074	Angola	Moxico, Sombanana	-13.307000	18.623500	1	1	1	1	0
<i>A. stenodactylus</i>	T6779	WC 4075	Angola	Moxico, Sombanana	-13.307000	18.623500	1	1			0
<i>A. stenodactylus</i>	T6780	WC 4127	Angola	Moxico, Sombanana	-13.307000	18.623500	1	1			0
<i>A. stenodactylus</i>	T6767	WC 3862	Angola	Munhango Village	-12.163100	18.554300	1	1	1	1	0
<i>A. stenodactylus</i>	ELI137	ELI137	DRC	Kabongo	-7.325600	25.594300					0
<i>A. stenodactylus</i>	EBG2221	EBG2221	DRC	Katanga, Force Benders	-5.064610	28.917020	1	1			1
<i>A. stenodactylus</i>	T6202	CT 606.1	DRC	Katanga, Miombo	-10.760417	25.989783	1	1			0
<i>A. stenodactylus</i>	ELI181	ELI181	DRC	Katanga, Mitwaba	-8.626700	27.339220	1	1			1
<i>A. stenodactylus</i>	ELI182	ELI182	DRC	Katanga, Mitwaba	-8.626700	27.339220	1	1			1
<i>A. stenodactylus</i>	ELI311	ELI311	DRC	Katanga, Mulongo	-7.65509	27.34027	1	1			1
<i>A. stenodactylus</i>	ELI242	ELI242	DRC	Kibara Mtns	-8.310806	27.255167	1	1			0
<i>A. stenodactylus</i>	T2543	SL 1102	DRC	Lubumbashi, Mikembo Sanctuary	-11.466600	27.650000	1	1			0
<i>A. stenodactylus</i>	T2544	SL 1103	DRC	Lubumbashi, Mikembo Sanctuary	-11.466600	27.650000	1	1	1	1	0
<i>A. stenodactylus</i>	T2616	DRC 9981	DRC	Lwana	-1.203053	28.829603	1	1	1	1	0
<i>A. stenodactylus</i>	ELI375	ELI375	DRC	Manono	No Coordinates	No Coordinates	1	1			1
<i>A. stenodactylus</i>	ELI310	ELI310	DRC	Moss Forest	No Coordinates	No Coordinates	1	1			1
<i>A. stenodactylus</i>	T6307	SL 2827	Kenya	Arabuko Sokoke Forest	-3.323556	39.890694	1	1	1	1	0
<i>A. stenodactylus</i>	T6308	SL 2828	Kenya	Arabuko Sokoke Forest	-3.323556	39.890694	1	1	1	1	0
<i>A. stenodactylus</i>	T6309	SL 2829	Kenya	Arabuko Sokoke Forest	-3.323556	39.890694	1	1	1	1	0

SUPPLEMENTARY MATERIALS: CHAPTER III

Species	Tissue ID	Voucher	Country	Locality	Latitude	Longitude	12S	16S	COX1	RAG1	Measured
<i>A. stenodactylus</i>	T6325	SL 2864	Kenya	Arabuko Sokoke Forest	-3.281444	39.971667		1			0
<i>A. stenodactylus</i>	T5322	SL 1206	Kenya	Kwale, Mukurumudzi Dam	-4.392000	39.429217		1			1
<i>A. stenodactylus</i>	T5319	SL 1117	Kenya	Kwale, Ngongoni	-4.415567	39.473383		1			0
<i>A. stenodactylus</i>	T6670	SL 1338	Kenya	Mukurumudzi River	-4.375200	39.425483		1			0
<i>A. stenodactylus</i>	T6356	SL 2726	Kenya	Mwadambara swamp	-4.180900	39.419300		1			0
<i>A. stenodactylus</i>	T6363	SL 2771	Kenya	Mwele forest	-4.286633	39.362767	1	1	1		0
<i>A. stenodactylus</i>	T2451	MW 07929	Kenya	Ngaia FR, Nyambene Hills	0.391900	38.033100	1	1	1	1	0
<i>A. stenodactylus</i>	T6337	SL 1441	Kenya	Pengo forest	-4.249111	39.383861	1	1	1		0
<i>A. stenodactylus</i>	T6397	SL 1440	Kenya	Scheldrick's Falls	-4.275530	39.430960	1	1	1		0
<i>A. stenodactylus</i>	T5162	SL 1165	Kenya	Shimba Hills, Longomwangadi Forest	-4.231167	39.425056		1	1		0
<i>A. stenodactylus</i>	T5323	SL 1243	Kenya	Shimba Hills, Longomwangadi Forest	-4.231167	39.425056		1			0
<i>A. stenodactylus</i>	T5154	SL 1122	Kenya	Shimba Hills, Mkadara Forest	-4.237556	39.395639		1			0
<i>A. stenodactylus</i>	T5155	SL 1123	Kenya	Shimba Hills, Mkadara Forest	-4.237556	39.395639		1			0
<i>A. stenodactylus</i>	T5156	SL 1124	Kenya	Shimba Hills, Mkadara Forest	-4.237556	39.395639		1			0
<i>A. stenodactylus</i>	T5157	SL 1125	Kenya	Shimba Hills, Mkadara Forest	-4.237556	39.395639		1			0
<i>A. stenodactylus</i>	T5161	SL 1164	Kenya	Shimba Hills, Mkadara Forest	-4.237556	39.395639		1			0
<i>A. stenodactylus</i>	T5320	SL 1161	Kenya	Shimba Hills, Mkadara Forest	-4.237556	39.395639		1	1		1
<i>A. stenodactylus</i>	T5321	SL 1172	Kenya	Shimba Hills, Sheldricks Falls	-4.275530	39.430960		1			1
<i>A. stenodactylus</i>	T5324	SL 1294	Kenya	Shimba Hills, lodge	-4.237500	39.395639		1		1	1
<i>A. stenodactylus</i>	QQ0698	QQ0698	Malawi	Chisangoli	No Coordinates	No Coordinates	1				0
<i>A. stenodactylus</i>	QQ0723	QQ0723	Malawi	KaraOMula	-16.020210	35.518320	1	1			0
<i>A. stenodactylus</i>	QQ0830	QQ0830	Malawi	KaraOMula	-16.020210	35.518320	1	1			0
<i>A. stenodactylus</i>	T5125	HM 1629	Malawi	KaraOMula	-16.012104	35.514867		1			0
<i>A. stenodactylus</i>	QQ0622	QQ0622	Malawi	Mimosa Tea	-16.084080	35.625410		1			0
<i>A. stenodactylus</i>	QQ0784	QQ0784	Malawi	Mimosa Tea	-16.084080	35.625410		1			0
<i>A. stenodactylus</i>	MCZ A-137060	MCZ FS-A34289	Malawi	Misuku Mtns, Mughese Forest	-9.650000	33.533330	FJ151104	FJ151104			0
<i>A. stenodactylus</i>	MCZ A-137061	MCZ FS-A34290	Malawi	Misuku Mtns, Mughese Forest	-9.650000	33.533330	FJ151105	FJ151105			0
<i>A. stenodactylus</i>	T2067	HM 1580	Malawi	Mt Mulanje, MMCT	-16.021900	35.515600	1	1	1	1	0

Species	Tissue ID	Voucher	Country	Locality	Latitude	Longitude	12S	16S	COX1	RAG1	Measured
<i>A. stenodactylus</i>	T5116	HM 1574	Malawi	Mt Mulanje, MMCT	-16.021860	35.515595		1			0
<i>A. stenodactylus</i>	T5117	HM 1576	Malawi	Mt Mulanje, MMCT	-16.021860	35.515595		1			0
<i>A. stenodactylus</i>	T5118	HM 1577	Malawi	Mt Mulanje, MMCT	-16.021860	35.515595		1			0
<i>A. stenodactylus</i>	T5119	HM 1578	Malawi	Mt Mulanje, MMCT	-16.021860	35.515595		1			0
<i>A. stenodactylus</i>	T5120	HM 1579	Malawi	Mt Mulanje, MMCT	-16.021860	35.515595		1			0
<i>A. stenodactylus</i>	T5121	HM 1581	Malawi	Mt Mulanje, MMCT	-16.021860	35.515595		1			0
<i>A. stenodactylus</i>	T5122	HM 1587	Malawi	Mt Mulanje, MMCT	-16.021860	35.515595		1			0
<i>A. stenodactylus</i>	T5123	HM 1599	Malawi	Mt Mulanje, MMCT	-16.020280	35.516326		1			0
<i>A. stenodactylus</i>	T5124	HM 1602	Malawi	Mt Mulanje, MMCT	-16.021860	35.515595		1			0
<i>A. stenodactylus</i>	MCZ A-137021	MCZ FS-A34250	Malawi	Mt Mulanje, Thuchila Plateau	-15.850000	35.616667	FJ151098	FJ151098			0
<i>A. stenodactylus</i>	MCZ A-137022	MCZ FS-A34251	Malawi	Mt Mulanje, Thuchila Plateau	-15.850000	35.616667	FJ151099	FJ151099			0
<i>A. stenodactylus</i>	T761	M 238	Malawi	Mulanje	No Coordinates	No Coordinates	1	1	1		0
<i>A. stenodactylus</i>	T789	M 108	Malawi	Mulanje	No Coordinates	No Coordinates	1	1	1		0
<i>A. stenodactylus</i>	T5110	ENI 03	Mozambique	Airstrip Quiterjo	-11.755558	40.424107	1	1	1		0
<i>A. stenodactylus</i>	T2944	GPN 001	Mozambique	Gorongosa 1	-18.643640	34.814220	1	1	1		0
<i>A. stenodactylus</i>	T2945	GPN 011	Mozambique	Gorongosa 1	-18.632360	34.809390	1	1	1		0
<i>A. stenodactylus</i>	T2946	GPN 012	Mozambique	Gorongosa 1	-18.632360	34.809390	1	1	1		0
<i>A. stenodactylus</i>	T2947	GPN 013	Mozambique	Gorongosa 1	-18.632360	34.809390	1	1	1		0
<i>A. stenodactylus</i>	T2948	GPN 014	Mozambique	Gorongosa 1	-18.632360	34.809390	1	1	1		0
<i>A. stenodactylus</i>	T2949	GPN 022	Mozambique	Gorongosa 1	-18.632360	34.809390	1	1	1		0
<i>A. stenodactylus</i>	T3350	GPN 026	Mozambique	Gorongosa 1	-18.632360	34.809390	1	1	1		0
<i>A. stenodactylus</i>	T3351	GPN 027	Mozambique	Gorongosa 1	-18.632360	34.809390	1	1	1		0
<i>A. stenodactylus</i>	T3352	GPN 059	Mozambique	Gorongosa 1	-18.632360	34.809390	1	1	1		0
<i>A. stenodactylus</i>	T3354	GPN 104	Mozambique	Gorongosa 2	-18.690361	34.313599	1	1	1		0
<i>A. stenodactylus</i>	T3355	GPN 105	Mozambique	Gorongosa 2	-18.690361	34.313599	1	1	1		0
<i>A. stenodactylus</i>	T3357	GPN 120	Mozambique	Gorongosa 3	-19.030870	34.676350	1	1	1		0
<i>A. stenodactylus</i>	T3358	GPN 128	Mozambique	Gorongosa 3	-19.030870	34.676350	1	1	1		0
<i>A. stenodactylus</i>	T3359	GPN 178	Mozambique	Gorongosa TL	-18.921409	34.365764	1	1	1		0
<i>A. stenodactylus</i>	RB10A201	RB10A201	Mozambique	Lichinga	-13.304440	35.234170	1	1	1		0
<i>A. stenodactylus</i>	T5780	WC 2832	Mozambique	Mpaluwe, Oasis water	-14.915986	38.316500	1	1	1		1
<i>A. stenodactylus</i>	PEMA9396	PEMA 9396	Mozambique	Mt Mabu, forest camp	-16.305584	36.424583	1	1	1		1
<i>A. stenodactylus</i>	PEMA9397	PEMA 9397	Mozambique	Mt Mabu, forest camp	-16.305584	36.424583	1	1	1		1
<i>A. stenodactylus</i>	PEMA9400	PEMA 9400	Mozambique	Mt Mabu, forest camp	-16.287889	36.412445	1	1	1		1
<i>A. stenodactylus</i>	PEMA9406	PEMA 9406	Mozambique	Mt Mabu, forest camp	-16.354555	36.403111	1	1	1		1
<i>A. stenodactylus</i>	T5762	WC 3086	Mozambique	Mt Mabu, forest camp	-16.286222	36.400056	1	1	1	1	1
<i>A. stenodactylus</i>	T5771	WC 3186	Mozambique	Mt Mabu, Miombo	-16.289200	36.404230	1	1	1		0
<i>A. stenodactylus</i>	T5745	WC 3032	Mozambique	Mt Mabu, river camp	-16.281528	36.443778	1	1	1		1
<i>A. stenodactylus</i>	T5746	WC 3033	Mozambique	Mt Mabu, river camp	-16.281528	36.443778	1	1	1		1
<i>A. stenodactylus</i>	T5759	WC 3150	Mozambique	Mt Mabu, way to summit	-16.289100	36.392500	1	1	1		1
<i>A. stenodactylus</i>	Niassa_136	Niassa_136	Mozambique	Niassa NR	No Coordinates	No Coordinates		1			0
<i>A. stenodactylus</i>	Niassa_84	ZMB 79114	Mozambique	Niassa NR	-12.183333	37.551944					0
<i>A. stenodactylus</i>	Niassa_86	ZMB 79113	Mozambique	Niassa NR	-12.183333	37.551944					1

SUPPLEMENTARY MATERIALS: CHAPTER III

Species	Tissue ID	Voucher	Country	Locality	Latitude	Longitude	12S	16S	COX1	RAG1	Measured
<i>A. stenodactylus</i>	T5114	WC-DNA-1395	Mozambique	Pemba dry forest 1	-12.766667	40.406478		1		1	0
<i>A. stenodactylus</i>	T5115	WC-DNA-1420	Mozambique	Pemba dry forest 2	-12.883333	40.341992		1			0
<i>A. stenodactylus</i>	T5111	ENI 21	Mozambique	Quirimbas	-12.142686	40.432120	1		1		0
<i>A. stenodactylus</i>	T5113	WC-DNA-1350	Mozambique	Revubo	-15.714972	33.774694		1			1
<i>A. stenodactylus</i>	T5112	WC-DNA-1119	Mozambique	Syráh Balama Camp	-13.320000	38.640100		1			1
<i>A. stenodactylus</i>	T5632	HF 15	Mozambique	Taratibu	-12.821783	39.686578		1			0
<i>A. stenodactylus</i>	T5637	HF 20	Mozambique	Taratibu	-12.821783	39.686578		1			0
<i>A. stenodactylus</i>	T5655	HF 38	Mozambique	Taratibu	-12.821783	39.686578		1			0
<i>A. stenodactylus</i>	T5656	HF 39	Mozambique	Taratibu	-12.821783	39.686578		1			0
<i>A. stenodactylus</i>	T6223	SL 2545	Mozambique	Taratibu	-12.816400	39.691300	1		1	1	0
<i>A. stenodactylus</i>	T6224	SL 2546	Mozambique	Taratibu	-12.816400	39.691300	1		1	1	0
<i>A. stenodactylus</i>	T6225	SL 2547	Mozambique	Taratibu	-12.816400	39.691300	1		1		0
<i>A. stenodactylus</i>	T6226	SL 2548	Mozambique	Taratibu	-12.816400	39.691300	1		1		0
<i>A. stenodactylus</i>	T6227	SL 2572	Mozambique	Taratibu	-12.816400	39.691300	1		1		0
<i>A. stenodactylus</i>	T2720	MCZ 148779	Tanzania	Dar es Salaam, Dondwe Forest	-7.064294	39.096969		1	1		0
<i>A. stenodactylus</i>	T2727	MCZ 148832	Tanzania	Dar es Salaam, Dondwe Forest	-7.064294	39.096969	1		1		0
<i>A. stenodactylus</i>	T2728	MCZ 148833	Tanzania	Dar es Salaam, Dondwe Forest	-7.064294	39.096969	1		1	1	0
<i>A. stenodactylus</i>	CAS168455	CAS 168455	Tanzania	East Usambara	-5.100000	38.633330	FJ151054.1				1
<i>A. stenodactylus</i>	CAS168456	CAS 168456	Tanzania	East Usambara	-5.100000	38.633330	1				0
<i>A. stenodactylus</i>	CAS168457	CAS 168457	Tanzania	East Usambara	-5.100000	38.633330	1				0
<i>A. stenodactylus</i>	CAS168605	CAS 168605	Tanzania	East Usambara	-5.100000	38.633330	1				0
<i>A. stenodactylus</i>	CAS168606	CAS 168606	Tanzania	East Usambara	-5.100000	38.633330	1				0
<i>A. stenodactylus</i>	CAS168662	CAS 168662	Tanzania	East Usambara	-5.100000	38.633330	1				0
<i>A. stenodactylus</i>	T2313	BM 2002.324	Tanzania	Mlinga FR	-5.059417	38.747806	1				1
<i>A. stenodactylus</i>	BMNH 2002.595	BMNH 2002.595	Tanzania	East Usambara, Nilo FR	-4.908417	38.662722					0
<i>A. stenodactylus</i>	T2318	BM 2002.593	Tanzania	East Usambara, Nilo FR	-4.928472	38.693306	1				0
<i>A. stenodactylus</i>	T2319	BM 2002.594	Tanzania	East Usambara, Nilo FR	-4.863111	38.651139	1		1		0
<i>A. stenodactylus</i>	T4450	BM 2002.595	Tanzania	East Usambara, Nilo FR	-4.908417	38.662722					0
<i>A. stenodactylus</i>	T2492	MTSN 9510	Tanzania	East Usambara, Segoma	-4.980940	38.758250	1				0
<i>A. stenodactylus</i>	T4930	MTSN 9512	Tanzania	East Usambara, Segoma	-4.980940	38.758250	1				0
<i>A. stenodactylus</i>	T4933	MTSN 9515	Tanzania	East Usambara, Segoma	-4.980940	38.758250	1				1
<i>A. stenodactylus</i>	T4934	MTSN 9516	Tanzania	East Usambara, Segoma	-4.980940	38.758250	1				0
<i>A. stenodactylus</i>	T4939	MTSN 9525	Tanzania	East Usambara, Segoma	-4.980940	38.758250	1				0

SUPPLEMENTARY MATERIALS: CHAPTER III

Species	Tissue ID	Voucher	Country	Locality	Latitude	Longitude	12S	16S	COX1	RAG1	Measured
<i>A. stenodactylus</i>	T4940	MTSN 9526	Tanzania	Segoma East Usambara, Segoma	-4.980940	38.758250		1			0
<i>A. stenodactylus</i>	T4943	MTSN 9529	Tanzania	Segoma East Usambara, Segoma	-4.980940	38.758250		1			1
<i>A. stenodactylus</i>	T4945	MTSN 9535	Tanzania	Segoma East Usambara, Segoma	-4.976430	38.761500		1			1
<i>A. stenodactylus</i>	T4946	MTSN 9536	Tanzania	Segoma East Usambara, Segoma	-4.976430	38.761500		1			1
<i>A. stenodactylus</i>	T4950	MTSN 9540	Tanzania	Segoma East Usambara, Segoma	-4.976430	38.761500		1			1
<i>A. stenodactylus</i>	T4964	MTSN 9556	Tanzania	Segoma East Usambara, Segoma	-4.976430	38.761500		1			1
<i>A. stenodactylus</i>	T2334	BM 2005.923	Tanzania	Kazumbwi FR	-6.955417	39.062000	1	1	1		0
<i>A. stenodactylus</i>	T4442	BM 2002.357	Tanzania	Kazumbwi FR	-6.932306	39.053444		1	1		0
<i>A. stenodactylus</i>	T4443	BM 2005.918	Tanzania	Kazumbwi FR	-6.942528	39.053472		1			0
<i>A. stenodactylus</i>	T5142	MUSE 11050	Tanzania	Kilombero Valley, Mgeta Dam	-8.311798	36.091327		1	1	1	0
<i>A. stenodactylus</i>	T4269	CB 13.923	Tanzania	Kilulu, Tanga	-4.765000	39.129680	1	1			1
<i>A. stenodactylus</i>	T2991	CB 13.002	Tanzania	Lindi, Makangala FR	-9.994180	39.388030	1	1	1	1	1
<i>A. stenodactylus</i>	T3143	CB 13.166	Tanzania	Lindi, Makangala FR	-9.989900	39.387150	1	1	1		1
<i>A. stenodactylus</i>	T3253	CB 13.261	Tanzania	Lindi, Rondo Forest	-10.11922	39.199990		1			0
<i>A. stenodactylus</i>	T3255	CB 13.262	Tanzania	Lindi, Rondo Forest	-10.118710	39.199040	1	1	1	1	1
<i>A. stenodactylus</i>	T3256	CB 13.263	Tanzania	Lindi, Rondo Forest	-10.117950	39.177740	1	1		1	0
<i>A. stenodactylus</i>	T3257	CB 13.264	Tanzania	Lindi, Rondo Forest	-10.117950	39.177740	1	1		1	0
<i>A. stenodactylus</i>	T3258	CB 13.265	Tanzania	Lindi, Rondo Forest	-10.117950	39.177740	1	1		1	0
<i>A. stenodactylus</i>	T3259	CB 13.266	Tanzania	Lindi, Rondo Forest	-10.117950	39.177740	1	1	1		0
<i>A. stenodactylus</i>	T2722	MCZ 148794	Tanzania	Lindi, Rondo Forest	-10.117957	39.177740	1	1	1		0
<i>A. stenodactylus</i>	T2723	MCZ 148801	Tanzania	Lindi, Rondo Forest	-10.117957	39.177740	1	1			0
<i>A. stenodactylus</i>	T2726	MCZ 148817	Tanzania	Lindi, Rondo Forest	-10.117957	39.177740	1	1			0
<i>A. stenodactylus</i>	T695	LC 013	Tanzania	Malundwe Hill	No Coordinates	No Coordinates	1	1			0
<i>A. stenodactylus</i>	T5706	MTSN 9592	Tanzania	Maskati, Nguru	-6.066302	37.498027	1	1	1	1	1
<i>A. stenodactylus</i>	T5708	MCZ FS-A32223	Tanzania	Maskati, Nguru	-6.066302	37.498027		1			0
<i>A. stenodactylus</i>	T5710	MCZ FS-A32213	Tanzania	Maskati, Nguru	-6.066302	37.498027		1			0
<i>A. stenodactylus</i>	T5711	MCZ FS-A32222	Tanzania	Maskati, Nguru	-6.066302	37.498027		1			0
<i>A. stenodactylus</i>	T5712	MCZ FS-A32211	Tanzania	Maskati, Nguru	-6.066302	37.498027	1	1	1		0
<i>A. stenodactylus</i>	T5713	MCZ FS-A32212	Tanzania	Maskati, Nguru	-6.066302	37.498027		1			0
<i>A. stenodactylus</i>	T5402	MVZ:Herp:233788	Tanzania	Mlandizi	-6.825410	38.753751		1			0
<i>A. stenodactylus</i>	T2377	MTSN 5147	Tanzania	Nguu North FR	-5.480278	37.475278	1	1			1
<i>A. stenodactylus</i>	T2378	MTSN 5150	Tanzania	Nguu North FR	-5.480278	37.475278	1	1	1	1	1
<i>A. stenodactylus</i>	T2379	MTSN 5152	Tanzania	Nguu North FR	-5.480278	37.475278	1	1		1	1
<i>A. stenodactylus</i>	T2364	MTSN 7523	Tanzania	Nguu, Kilindi	-5.582639	37.581444	1	1	1		1
<i>A. stenodactylus</i>	T2396	MTSN 7525	Tanzania	Nguu, Kilindi	-5.596600	37.566600	1	1	1		1
<i>A. stenodactylus</i>	T2397	MTSN 7524	Tanzania	Nguu, Kilindi	-5.582639	37.581444	1	1			1
<i>A. stenodactylus</i>	T2398	MTSN 7526	Tanzania	Nguu, Kilindi	-5.582639	37.581444	1	1		1	1

SUPPLEMENTARY MATERIALS: CHAPTER III

Species	Tissue ID	Voucher	Country	Locality	Latitude	Longitude	12S	16S	COX1	RAG1	Measured
<i>A. stenodactylus</i>	T4440	BM 2002.379	Tanzania	Ruvu South FR	-6.908556	38.814278		1			0
<i>A. stenodactylus</i>	T4441	BM 2002.383	Tanzania	Ruvu South FR	-6.908556	38.814278		1			0
<i>A. stenodactylus</i>	T2732	MCZ 148848	Tanzania	Tanga, Mafi Hill	-4.923429	38.140926	1	1	1		0
<i>A. stenodactylus</i>	T2733	MCZ 148849	Tanzania	Tanga, Mafi Hill	-4.923429	38.140926	1	1	1		0
<i>A. stenodactylus</i>	T2734	MCZ 148850	Tanzania	Tanga, Mafi Hill	-4.923429	38.140926	1	1	1		0
<i>A. stenodactylus</i>	T5095	MUSE 12317	Tanzania	Udzungwa Scarp	No Coordinates	No Coordinates		1	1		0
<i>A. stenodactylus</i>	T5100	MUSE 12322	Tanzania	Udzungwa Scarp	No Coordinates	No Coordinates		1	1		0
<i>A. stenodactylus</i>	T5101	MUSE 12323	Tanzania	Udzungwa Scarp	No Coordinates	No Coordinates		1	1		0
<i>A. stenodactylus</i>	T2362	MTSN 5666	Tanzania	Udzungwa, Chita	-8.527925	35.894589	1	1	1		1
<i>A. stenodactylus</i>	T3327	ET 002	Tanzania	Udzungwa, Funo	-8.510850	35.906780		1			0
<i>A. stenodactylus</i>	T2381	MTSN 5228	Tanzania	Udzungwa, Mkalazi	-8.397500	35.978611	1	1	1		1
<i>A. stenodactylus</i>	T2735	MCZ 148890	Tanzania	Udzungwa, Morogoro	-7.857300	36.887300	1	1	1		0
<i>A. stenodactylus</i>	T2736	MCZ 148891	Tanzania	Udzungwa, Morogoro	-7.857300	36.887300	1	1	1		0
<i>A. stenodactylus</i>	T6078	ET 080	Tanzania	Kilola	-8.391030	36.010210		1			0
<i>A. stenodactylus</i>	T2331	BM 2005.669	Tanzania	Udzungwa, West Kilombero	-7.866667	36.366667	1	1	1		1
<i>A. stenodactylus</i>	T2332	BM 2005.670	Tanzania	Udzungwa, West Kilombero	-7.883333	36.383333	1	1	1		0
<i>A. stenodactylus</i>	T2333	BM 2005.672	Tanzania	Udzungwa, West Kilombero	-7.883333	36.383333	1	1	1		0
<i>A. stenodactylus</i>	T2684	SL 809	Tanzania	Ukaguru, Mamiwa	-6.616264	36.946645	1	1	1		0
<i>A. stenodactylus</i>	T2689	SL 840	Tanzania	Kisara South Ukaguru, Mamiwa	-6.591981	36.949184	1	1	1		1
<i>A. stenodactylus</i>	T2690	SL 841	Tanzania	Ukaguru, Mamiwa	-6.591981	36.949184	1	1	1		0
<i>A. stenodactylus</i>	T2373	MTSN 9503	Tanzania	Kisara South Ukaguru, Mikuvi	-6.641447	36.948796	1	1	1		1
<i>A. stenodactylus</i>	T5709	MTSN 9502	Tanzania	Ukaguru, Mikuvi	-6.64091	36.95029	1	1	1		0
<i>A. stenodactylus</i>	T2322	BM 2005.033	Tanzania	Uluguru	-7.191166	37.773925	1	1	1		0
<i>A. stenodactylus</i>	T2323	BM 2005.034	Tanzania	Uluguru	-7.191166	37.773925	1	1	1		0
<i>A. stenodactylus</i>	T2325	BM 2005.036	Tanzania	Uluguru	-6.868611	37.915000	1	1	1		0
<i>A. stenodactylus</i>	T2326	BM 2005.037	Tanzania	Uluguru	-7.179167	37.837500	1	1	1		0
<i>A. stenodactylus</i>	T2327	BM 2005.038	Tanzania	Uluguru	-7.179167	37.837500	1	1	1		0
<i>A. stenodactylus</i>	T2328	BM 2005.042	Tanzania	Uluguru	-6.984722	37.764167	1	1	1		0
<i>A. stenodactylus</i>	T4282	MTSN 7796	Tanzania	Uluguru	-7.103861	37.586917	1	1	1		1
<i>A. stenodactylus</i>	T4453	BM 2005.032	Tanzania	Uluguru, Kasanga FR	-7.191166	37.773925	1	1	1		0
<i>A. stenodactylus</i>	T4454	BM 2005.039	Tanzania	Uluguru, Mvuha, FR	-7.179167	37.837500	1	1	1		1
<i>A. stenodactylus</i>	T4455	BM 2005.040	Tanzania	Uluguru, Mvuha, FR	-7.179167	37.837500	1	1	1		0
<i>A. stenodactylus</i>	T4456	BM 2005.041	Tanzania	Uluguru, Mvuha, FR	-7.180000	37.836944	1	1	1		1
<i>A. stenodactylus</i>	T4457	BM 2005.045	Tanzania	Uluguru, Ruvu South	-7.008056	37.862500	1	1	1		0
<i>A. stenodactylus</i>	T4458	BM 2005.046	Tanzania	Uluguru, Ruvu South West Usambara,	-7.008056	37.862500	1	1	1		0
<i>A. stenodactylus</i>	T2712	MCZ 138370	Tanzania	Mazumbai FR	-4.816667	38.483333	1	1	1		0
<i>A. stenodactylus</i>	T2540	AC 1265	Tanzania	Zaraninge	-6.136940	38.607550	1	1	1		0

Species	Tissue ID	Voucher	Country	Locality	Latitude	Longitude	12S	16S	COX1	RAG1	Measured
<i>A. stenodactylus</i>	T2541	AC 1266	Tanzania	Zaranninge	-6.136940	38.607550	1	1	1		0
<i>A. stenodactylus</i>	T6200	WC 3492	Zambia	Chiawa	-15.898147	28.881741		1			0
<i>A. stenodactylus</i>	T6201	WC no voucher	Zambia	Chiawa	-15.922520	28.866556		1			0
<i>A. stenodactylus</i>	T3528	SL 2109	Zambia	Lukwakwa	-12.660840	24.436970	1	1	1	1	1
<i>A. stenodactylus</i>	T3529	SL 2121	Zambia	Lukwakwa	-12.660840	24.436970	1	1			1
<i>A. stenodactylus</i>	T3531	SL 2123	Zambia	Lukwakwa	-12.660840	24.436970	1	1			1
<i>A. stenodactylus</i>	T3534	SL 2128	Zambia	Lukwakwa	-12.660840	24.436970	1	1			0
<i>A. stenodactylus</i>	RB11B405	RB11B405	Zambia	Mpika	-11.804370	31.398650	1	1			0
<i>A. stenodactylus</i>	RB11B099	RB11B099	Zambia	Mporokoso	-9.362420	30.123650	1	1			0
<i>A. stenodactylus</i>	T3535	SL 2221	Zambia	Nkwaji	-11.577280	24.539600	1	1	1	1	1
<i>A. adelphus</i>	-	<b>CAS 207922</b>	-	-	-	-	<b>FJ151055</b>	<b>FJ151055</b>	-	-	-
<i>A. affinis</i>	-	<b>BMNH2005.664</b>	-	-	-	-	<b>FJ151078</b>	<b>FJ151078</b>	-	-	-
<i>A. nikaie</i>	-	<b>MTSN 9178</b>	-	-	-	-	<b>FJ151159</b>	<b>FJ151159</b>	-	-	-
<i>A. wahlbergii</i>	-	<b>TM&lt;ZAF&gt;-84361</b>	-	-	-	-	<b>FJ151052</b>	<b>FJ151052</b>	-	-	-
<i>A. poecilnotus</i>	-	<b>MVZ:Herp:249261</b>	-	-	-	-	<b>JX564853</b>	<b>JX564853</b>	-	-	-
<i>A. variabilis</i>	-	<b>ZFMK68794</b>	-	-	-	-	-	<b>AB612012</b>	<b>AB612010</b>	<b>EF396073</b>	-
<i>C. gracilis</i>	-	<b>MVZ:Herp:234675</b>	-	-	-	-	<b>FJ151065</b>	<b>FJ151065</b>	-	-	-

TABLE S2. Primers used in this study.

Gene	Primer	Study/Source
12S	12S L1091: AAAAAGCTTCAAACCTGGATTAGATACCCCACTAT	Kosher et al., 1989
	12S H1478: TGACTGCAGAGGGTGACGGGGCGGTGTGT	Kosher et al., 1989
16S	16S H3062: CCGGTTTGAACCTCAGATCA	16sbr-H modified Palumbi et al., 1991
	16SB FROG: CGCCTGTTACC AAAACAT	16sar-L modified Palumbi et al., 1991
COX1	P3F: CAATACCAAACCCCTTRTTYGTWTGATC	Ducroz et al., 2001
	P3R: GCTTCTCARATAATAAATATYATA	San Mauro et al., 2004
RAG1	RAG1-Mart.FL1: AGCTGCAGYCARTAYCAY AARATGTA	Pramuk et al., 2008
	RAG1-AMP.R1: AACTCAGCTGCATTKCCAA TRTCA	Pramuk et al., 2008

TABLE S3. Polymerase chain reaction (PCR) protocols.

Gene	Annealing temperature	Time	Cycles
12S	51°C	1 min	35
16S	51°C	1 min	35
COX1	45°C	1 min	35
RAG1	50°C	25 s	45



**References**

- Ducroz, J.F., Volobouev, V., Granjon, L., 2001. An Assessment of the Systematics of Arvicanthine Rodents Using Mitochondrial DNA Sequences: Evolutionary and Biogeographical Implications. *J. Mamm. Evol.* 8, 173–206. doi:10.1023/A:1012277012303
- Kocher, T.D., Thomas, W.K., Meyer, A., Edwards, S.V., Pääbo, S., Villablanca, F.X. and Wilson, A.C., 1989. Dynamics of mitochondrial DNA evolution in animals: amplification and sequencing with conserved primers. *Proc. Nat. Acad. Sci., USA*, 86, 6196-6200.
- Palumbi, S.R., Martin, A., Romano, S., McMillan, W.O., Stice, L., Grabowski, G. 1991. *The simple fool's guide to PCR*. Department of Zoology and Kewalo Marine Laboratory, Hawaii, 47 pp.
- Pramuk, J.B., Robertson, T., Sites Jr., J.W. Nooan, B.P. 2008. Around the world in 10 million years: biogeography of the nearly cosmopolitan true toads (Anura: Bufonidae). *Global Ecol. Biogeogr.*, 17, 72–8
- San Mauro, D., Gower, D.J., Oommen, O. V., Wilkinson, M., Zardoya, R., 2004. Phylogeny of caecilian amphibians (Gymnophiona) based on complete mitochondrial genomes and nuclear RAG1. *Mol. Phylogenet. Evol.* 33, 413–427. doi:10.1016/j.ympev.2004.05.014

**TABLE S4. Partition schemes and substitution models used in Bayesian analyses (BI). Best** partitions schemes and models were inferred using the Bayesian information criterion in PartitionFinder v.1.1.1. Models were translated to their respective versions in BEAUti. Condon position indicated by “p”.

Partition	BI model	Base frequencies
12S	GTR+G	Estimated
16S	GTR+I+G	Estimated
CO1 p1	TN93+I	All equal
CO1 p2, RAG1 p3	HKY+I	Estimated
CO1 p3	TN93+G	Estimated
RAG1 p1, p2	HKY+I	All equal

**TABLE S5. Snout-vent length average and standard deviation (std) of Forest and Woodland clades of *Arthroleptis stenodactylus*.** Numbers of specimens measured is parenthesis.

	Average Male	std	Average Female	std
Woodland	25.1 (3)	1.5	30.0 (8)	3.9
Forest	27.6 (11)	4.2	33.1 (19)	5.8

**TABLE S6. Confusion matrices showing prediction success of linear discriminant analysis (LDA) used to distinguish two clades based on body measurements of *Arthroleptis stenodactylus* (actual rows by predicted columns).** Bottom matrix shows results of the cross-validation test. Numbers in bold indicate misclassifications.

	Woodland	Forest
Woodland	22	<b>3</b>
Forest	<b>1</b>	28

	Woodland	Forest
Woodland	21	<b>3</b>
Forest	<b>2</b>	28



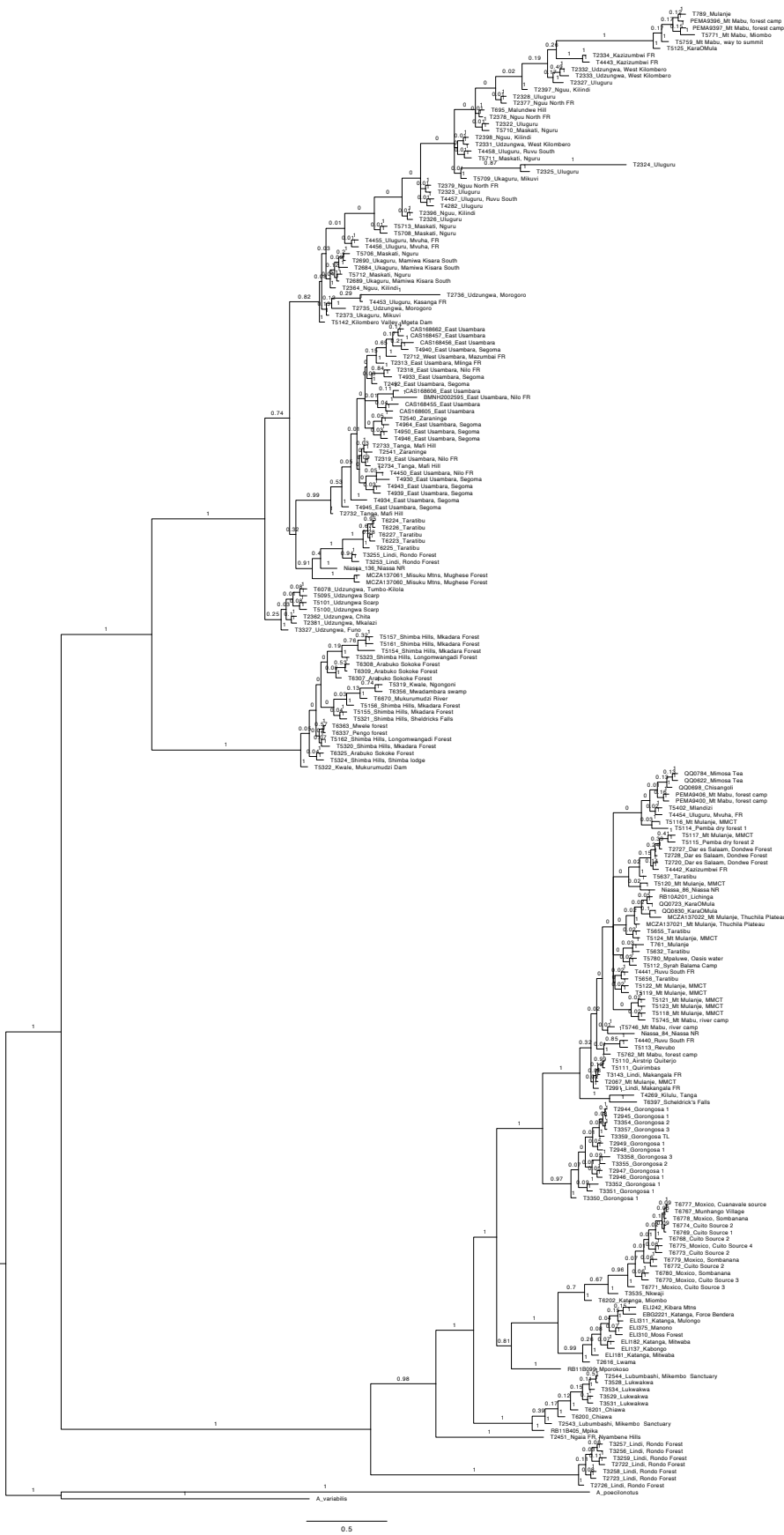

FIGURE S2. Mitochondrial Bayesian phylogram for *Arthroleptis stenodactylus*.





SUPPLEMENTARY

MATERIALS

Additional Publications

## The distribution of *Mertensophryne anotis* with a new record in Northern Mozambique

Harith Farooq<sup>1</sup>, H. Christoph Liedtke<sup>2</sup>, Gabriela Bittencourt-Silva<sup>2</sup>, Werner Conradie<sup>3</sup>  
and Simon P. Loader<sup>2,\*</sup>

Northern Mozambique (Nampula, Niassa and Cabo Delgado provinces) is biologically one of the most poorly known areas in Africa. In recent years several biodiversity surveys have been conducted in northern Mozambique (e.g. Branch et al., 2005; Timberlake et al., 2007; Timberlake et al., 2009; Bayliss et al., 2014; Pascal, 2011; Portik et al., 2013a) but large areas still remain completely unknown. The expeditions thus far have resulted in the discovery of several new species of reptiles and mammals (e.g. Branch and Bayliss, 2009; Daniels and Bayliss, 2012; Taylor et al., 2012; Portik et al., 2013b), but no amphibians. Amphibians have not received much attention with the only substantial review of the area dating from Poynton and Broadley's opus *Amphibia Zambesiaca* (1985a; 1985b; 1987; 1991). The number and distribution of species is likely to be greatly underestimated given the lack of taxonomic study and basic field surveys across the region (Portik et al., 2013a).

One species known from Mozambique is *Mertensophryne anotis* (Boulenger 1907), which is known from Dombe Forest (see Figure 1) and in the adjacent Chirinda Forest in eastern Zimbabwe (Poynton and Broadley, 1988). The species is a bufonid, distinguished by a combination of characters including: absence of a tarsal fold, a pointed snout,

absent tympanum, large parotid glands, granular throat, and short webbed toes (Boulenger, 1907; Poynton and Broadley, 1988; Channing, 2001). In the Chirinda Forest it occurs at approximately 900-1,300 m asl. The species lives in the leaf-litter of evergreen forests, mainly hiding inside or beneath rotten logs. The Dombe forest specimen was collected by T.W. Coffin-Grey on 5 March 1970 (Broadley pers. comm.). Dombe forest is a small patch of coastal forest in the eastern foothills of the Chimanimani escarpment at an altitude of ca. 640 m



**Figure 1.** IUCN redlist expert distribution range of *Mertensophryne anotis* (red) in Zimbabwe and Mozambique, triangles are previously known records from GBIF.org and the star is the new record from Taratibu.

<sup>1</sup> Faculty of Natural Sciences, Lúrio University, Caixa Postal 958, Pemba, Mozambique.

<sup>2</sup> University of Basel, Biogeography Research Group, Department of Environmental Sciences, Basel 4056, Switzerland.

<sup>3</sup> Port Elizabeth Museum (Bayworld), P.O. Box 13147, Humewood, Port Elizabeth 6013, South Africa.

\* Corresponding Author. E-mail: simon.loader@unibas.ch





**Figure 2.** Picture in life of *Mertensophryne anotis* from Taratibu.

(35 km north of Dombe town; Broadley pers. comm.; see Figure 1).

The breeding biology of the species has been described by Channing (1978), which included the description of the remarkable tadpole, which was used as part of the evidence to elevate it to its own genus (*Stephopaedes*) from *Bufo*. Frost's recent taxonomic changes now place it in the Southern and East African genus *Mertensophryne* (Frost *et al.*, 2006), several species of which share a similar, characteristic tadpole morphology (Müller *et al.*, 2005). Channing (1978) documented that eggs are laid in pockets of water between the buttress roots of *Chrysophyllum gorungosanum* trees, or in water-filled grooves on the trunks of fallen trees. The species has never been found outside forests (Poynton and Broadley, 1988). According to the IUCN Red List (Poynton and Channing, 2004), it is an endangered species due to its Extent of Occurrence being less than 5,000 km<sup>2</sup>, only being known from fewer than five locations, and because the quality and extent of its forest habitat in Zimbabwe and Mozambique is declining.

During a three day survey of the inselbergs of Taratibu, Quirimbas National Park (-12.816 S, 39.695 E, alt. 331 m; see Figure 1), a female (snout vent length of 44 mm) specimen of *Mertensophryne* cf. *anotis* (Boulenger 1907) were collected on 21 December 2014. This is more than 1,000 km from its known distribution of eastern Zimbabwe and adjacent Mozambique. The heavy rains had not yet started in the area, although light rainfall at nightfall was registered. The specimen was collected at around 8 pm in grass around the Taratibu's Lodge huts, which is at the base of a mountain surrounded by Southern Zanzibar-Inhambane coastal forest mosaic.

The specimen can be readily identified as this species on the basis of morphological (see Figure 2: and according to diagnosis in Poynton and Broadley, 1988, p.483) and genetic similarity.

The Taratibu specimen was barcoded using the 16S mtDNA (Genbank Accession Number to be release upon completion) and compared with other bufonids and showed nearest genetic similarity (p distance of 1.6%) to *Mertensophryne anotis* (Genbank Accession number: AF220910) from Zimbabwe. Other *Mertensophryne* species barcodes were compared ruling out the possibility of the sample being another species apart from: *M. mocquardi* (Angel 1924), *M. nairobiensis* (Loveridge 1932), *M. schmidtii* (Grandison 1972), *M. lonnbergi* (Andersson 1911), and *M. melanopleura* (Schmidt and Inger 1959), for which no data were available. However these species are morphologically different from the specimen collected in Taratibu.

The genetic difference between the new Taratibu population and *M. anotis* from the type locality raises the question of whether this sample represents a new species or not. Because we only have a single sample to compare we are unable to determine morphological variation in the Taratibu population. Given the large geographic distance, and likely long term isolated nature of the habitats both in Taratibu and the previous records in Dombe (Mozambique) and Chirinda (Zimbabwe; Figure 1), it might be possible these are two distinct, non-interbreeding populations. If *M. anotis* represents two species there are important conservation implications, as both populations with restricted distributions are threatened by continued deforestation (e.g. Magalhães, 2014). Rapid surveying of these habitats is urgently required to assess the diversity of the amphibian fauna of the isolated inselbergs in Mozambique to facilitate their protection.

**Acknowledgments.** We acknowledge permission to conduct research in Taratibu from the Quirimbas National Park, and Jakubu Johannes (Taratibu Lodge). Furthermore, for exporting specimens we acknowledge permits given by Museu de Historia Natural, Universidade Eduardo Mondlane, Maputo (N/ref 02/ MHN/E.27/2015). Funding from University of Basel, Kick Start Grant is acknowledged for funding co-operation and travel costs for S. Loader and H. Farooq. Part of this work was also funded by Freiwillige Akademische Gesellschaft Basel and ESKAS Foreign Scholarship Program (to G. Bittencourt-Silva). The University of Lurio, Pemba helped fund the fieldwork and travel costs of H. Farooq. Joana Martins for helping in the collection of specimens in Taratibu and Jakubu Johannes owner of the Area for allowing us to do this research. Reto Hagmann, and Don Broadley are thanked for assistance in the lab and advice.

## Literature Cited

- Andersson, L.G. (1911): Batrachians. In: Lönnberg, E., and L.G. Andersson, Reptiles, batrachians and fishes collected by the Swedish Zoological Expedition to British East Africa, 1911. Kongliga Svenska Vetenskaps-Akademiens Handlingar **47**: 25–36.
- Angel, F. (1924): Note préliminaire sur deux batraciens nouveaux, des genres *Rappia* et *Bufo*, provenant d'Afrique orientale anglaise (Mission Alluaud et Jeannel, 1911–1912). Bulletin du Museum National d'Histoire Naturelle, Paris **30**: 269–270.
- Bayliss, J., Timberlake, J.R., Branch, W.R., Bruessow, C., Collins, S., Congdon, C., Curran, M., de Sousa, C., Dowsett, R.J., Dowsett-Lemaire, F., Fishpool, L.D.C., Harris, T., Georgiandis, S., Kopp, K., Liggitt, B., Monadjem, A., Patel, H., Ribeiro, D., Spottiswoode, C., Taylor, P., Willcock, S., Smith, P. (2014): The discovery, biodiversity and conservation of Mabu forest – the largest mid-altitude rainforest in southern Africa. *Oryx* **48**: 177–185.
- Boulenger, G.A. (1907): Descriptions of a new toad and a new amphisbaenid from Mashonaland. *Annals and Magazine of Natural History, Series 7*: 47–49.
- Branch, W.R., Rödel, M., Marais, J. (2005): Herpetological survey of the Niassa Game Reserve, northern Mozambique-Part I: Reptiles. *Salamandra* **41**: 195–214.
- Branch, W.R., Bayliss, J. (2009): A new species of *Atheris* (Serpentes: Viperidae) from northern Mozambique. *Zootaxa* **2113**: 41–54.
- Branch, W.R., Tolley, K.A. (2010): A new species of chameleon (Sauria: Chamaeleonidae: *Nadzikambia*) from Mount Mabu, central Mozambique. *African Journal of Herpetology* **59**: 157–172.
- Branch, W.R., Bayliss, J., Tolley, K.A. (2014): Pygmy chameleons of the *Rhampholeon platyceps* complex (Squamata: Chamaeleonidae): Description of four new species from isolated 'sky islands' of northern Mozambique. *Zootaxa* **3814**: 1–36.
- Channing, A. (1978): A new bufonid genus (Amphibia: Anura) from Rhodesia. *Herpetologica* **34**: 394–397.
- Channing, A. (2001): Amphibians of Central and Southern Africa. Ithaca, USA, Cornell University Press.
- Daniels, S.R., Bayliss, J. (2012): Neglected refugia of biodiversity: Mountainous regions in Mozambique and Malawi yield two novel freshwater crab species (Potamonautidae: *Potamonantes*). *Zoological Journal of the Linnean Society* **164**: 498–509.
- Frost, D.R., Grant, T., Faivovich, J., Bain, R. H., Haas, A., Haddad, C.F.B., de Sá, R.O., Channing, A., Wilkinson, M., Donnellan, S.C., Raxworthy, C.J., Campbell, J.A., Blotto, B.L., Moler, P.E., Drewes, R.C., Nussbaum, R.A., Lynch, J.D., Green, D.M., Wheeler, W.C. (2006): The amphibian tree of life. *Bulletin of the American Museum of Natural History* **297**: 1–370.
- Grandison, A.G.C. (1972): The status and relationships of some East African earless toads (Anura, Bufonidae) with a description of a new species. *Zoologische Mededelingen. Leiden* **47**: 30–48.
- Loveridge, A. (1932): Eight new toads of the genus *Bufo* from East and Central Africa. *Occasional Papers of the Boston Society of Natural History* **8**: 43–54.
- Magalhães, T. (2014): Análise do Sistema de Exploração dos Recursos Florestais em Moçambique. Justiça Ambiental, Maputo.
- Müller, H., Measey, G.J., Malonza, P.K. (2005): Tadpole of *Bufo taitanus* (Anura: Bufonidae) with notes on its systematic significance and life history. *Journal of Herpetology* **39**: 138–141.
- Pascal, O. (2011): The Coastal Forests of Northern Mozambique, 2008–2009 expeditions. «Our Planet Reviewed» Programme report n°1. Pro-Natura international/Muséum national d'Histoire naturelle, Paris. 160 pp.
- Portik, D.M., Mulungu, E., Sequeira, D., McEntee, J.P. (2013a): Herpetological surveys of the Serra Jeci and Namuli massifs, Mozambique, and an annotated checklist of the southern Afromontane archipelago. *Herpetological Review* **44**: 394–406.
- Portik, D.M., Travers, S.L., Bauer, A.M., Branch, W.R. (2013b): A new species of *Lygodactylus* (Squamata: Gekkonidae) endemic to Mount Namuli, an isolated 'sky island' of northern Mozambique. *Zootaxa* **3710**: 415–435.
- Poynton, J.C., Broadley, D.G. (1985a): Amphibia Zambesiaca 1. Scolecomorphidae, Pipidae, Microhylidae, Hemisidae, Arthroleptidae. *Annals of the Natal Museum* **26**: 503–553.
- Poynton, J.C., Broadley, D.G. (1985b): Amphibia Zambesiaca 2. Ranidae. *Annals of the Natal Museum* **27**: 115–181.
- Poynton, J.C., Broadley, D.G. (1987): Amphibia Zambesiaca 3. Rhacophoridae and Hyperoliidae. *Annals of the Natal Museum* **28**: 161–229.
- Poynton, J.C., Broadley, D.G. (1988): Amphibia Zambesiaca, 4. Bufonidae. *Annals of the Natal Museum* **29**: 447–490.
- Poynton, J.C., Broadley, D.G. (1991): Amphibia Zambesiaca, 5. Zoogeography. *Annals of the Natal Museum* **32**: 221–277.
- Poynton, J.C., Channing, A. (2004): *Mertensophryne anotis*. The IUCN Red List of Threatened Species. Version 2014.3. <www.iucnredlist.org>. Downloaded on 06 February 2015.
- Schmidt, K.P., Inger, R.F. (1959): Amphibians exclusive of the genera *Afrivalus* and *Hyperolius*. Exploration du Parc National de l'Upemba. Mission G.F. de Witte, en Collaboration avec W. Adam ... [et al.] (1946–1949). Bruxelles **56**: 1–264.
- Taylor, P.J., Stoffberg, S., Monadjem, A., Schoeman, M.C., Bayliss, J., Cotterill, F.P. (2012): Four new bat species (*Rhinolophus hildebrandtii* complex) reflect Plio-Pleistocene divergence of dwarfs and giants across an Afromontane archipelago. *PLoS One* **7**: e41744.
- Timberlake, J.R., Bayliss, J., Alves, T., Baena, S., Francisco, J., Harris, T., de Sousa, C. (2007): The biodiversity and conservation of Mount Chipere, Mozambique. Unpublished report of Darwin Initiative project. Royal Botanic Gardens, Kew. 33pp.
- Timberlake, J.R., Dowsett-Lemaire, F., Bayliss, J., Alves, T., Baena, S., Bento, C., Cook, K., Francisco, J., Harris, T., Smith, P., de Sousa, C. (2009): Mt Namuli, Mozambique: biodiversity and conservation. Report produced under Darwin Initiative Award 15/036. Royal Botanic Gardens, Kew, London. 115pp.

Accepted by Raffael Ernst



## Exploration into the hidden world of Mozambique's sky island forests: new discoveries of reptiles and amphibians

Werner Conradie<sup>1,2</sup>, Gabriela B. Bittencourt-Silva<sup>3</sup>, Hanlie M. Engelbrecht<sup>4,5</sup>, Simon P. Loader<sup>6</sup>, Michele Menegon<sup>7</sup>, Cristóvão Nanvonamuquitxo<sup>8</sup>, Michael Scott<sup>9</sup>, Krystal A. Tolley<sup>4,5</sup>

1 Port Elizabeth Museum (Bayworld), P.O. Box 13147, Humewood 6013, South Africa

2 South African Institute for Aquatic Biodiversity, P/Bag 1015, Grahamstown, 6140, South Africa

3 University of Basel, Biogeography Research Group, Department of Environmental Sciences, Basel 4056, Switzerland

4 South African National Biodiversity Institute, Private Bag X7, Claremont, 7735, South Africa

5 Department of Botany and Zoology, Stellenbosch University, Matieland 7602, Stellenbosch, South Africa

6 University of Roehampton, Department of Life Sciences, London, SW15 4JD, United Kingdom

7 MUSE, Museo delle Scienze, Viale del Lavoro e delle Scienze, 3 Trento 38122, Italy

8 Faculty of Natural Sciences, Lúrio University, Pemba, 958, Mozambique

9 Khangela Safaris, www.khangelasafaris.com, Bulawayo, Zimbabwe

<http://zoobank.org/9DA068DA-B881-4091-99FE-252D31DDC7D1>

Corresponding author: Werner Conradie (werner@bayworld.co.za)

### Abstract

Received 27 July 2016

Accepted 9 September 2016

Published 26 September 2016

Academic editor:

Peter Bartsch

### Key Words

Amphibia  
Reptilia  
conservation  
diversity  
new species

We carried out a survey of reptiles and amphibians within Afromontane forest and woodland slopes of three inselbergs in northern Mozambique (Mount Mabú, Mount Namuli, and Mount Ribáuè). A total of 56 species (22 amphibians and 34 reptiles) were recorded during the current survey. Our findings substantially increase the number of herpetofaunal species recorded from these mountains (Mount Ribáuè 59%, Mount Mabú 37%, and Mount Namuli 11% of the total species), including one new country record and several putative new species. An updated checklist of the herpetofauna of these mountains is presented.

### Introduction

Northern Mozambique (north of the Zambezi River and south of the Rovuma River) is biologically one of the most poorly known areas in Africa (see Tolley et al. 2016). This is a consequence of the limited infrastructure in the region as well as the protracted civil war (1977–1992), which made travel and exploration problematic. In recent years, several biodiversity surveys have been conducted in northern Mozambique (e.g. Branch et al. 2005a & b, Timberlake et al. 2007, Bayliss 2008, Spottiswoode et al. 2008, Timberlake et al. 2009 & 2012, Bayliss et al. 2010,

Pascal 2011, Portik et al. 2013a, Bayliss et al. 2014, Ohler and Frétey 2014, Farooq and Conradie 2015, Farooq et al. 2015). These expeditions resulted in the discovery of several new species of reptiles (Branch and Bayliss 2009, Branch and Tolley 2010, Portik et al. 2013b, Branch et al. 2014), crustaceans (Daniels and Bayliss 2012, Daniels et al. 2014), butterflies (Congdon et al. 2010, Congdon and Bayliss 2012), and bats (Monadjem et al. 2010, Taylor et al. 2012, Taylor et al. 2015).

The topography of northern Mozambique is characterised by isolated mountains ('inselbergs'), mainly in the west closer to Mt. Mulanje in Malawi, where the highest

peaks are found, but also by chains of smaller inselbergs extending eastwards towards the coast. These montane isolates form an important link between the better studied Eastern Arc Mountains (EAM) and the East African Coastal Forest (EACF). White (1983) classified the vegetation from Mts. Chipirone, Mabu, and Namuli as being associated with the East African Coastal Mosaic (EACM; type 16b). However, Timberlake et al. (2007, 2009, 2012) disregard White's classification and describe the vegetation from these mountains (especially at above 1600 m altitude) as more similar to the moist montane forests from the EAM. The presence of species from both, EAM and EACM, in Mts. Namuli (e.g. Timberlake et al. 2009) and Mabu (e.g. Timberlake et al. 2012) suggests that these mountains form a mosaic of biodiversity from two different ecoregions.

Findings from previous surveys suggest the Mozambican montane sky island forests contain high levels of biodiversity, particularly in terms of single site endemics (e.g. Ryan et al. 1999, Congdon et al. 2010, Portik et al. 2013b, Branch et al. 2014). In particular, high diversity is predicted in less vagile groups because these forests are isolated, and forest species are likely to have speciated *in situ* resulting in a suite of narrow endemics per mountain (Congdon et al. 2010, Branch et al. 2014, Bittencourt-Silva et al. 2016). The biological diversity of these poorly sampled montane forests is expected to be underestimated. This is particularly worrying as these, as yet undescribed, narrow endemics are at risk of extinction because of the substantial land use changes in the region. It is therefore critical that these poorly sampled forests receive attention towards documenting their biological diversity before they disappear.

Through targeted fieldwork, we explored three poorly known montane isolates (Mts. Mabu, Namuli, and Ribáuè), to document their herpetofaunal diversity. We conducted intensive surveys on these mountains across several habitats and over an altitudinal gradient searching for amphibians and reptiles. Although some herpetological surveys have been done recently on Mt. Namuli (Timberlake et al. 2009, Portik et al. 2013a, Farooq and Conradie 2015) and Mt. Mabu (Timberlake et al. 2012, Bayliss et al. 2014), Mt. Ribáuè has not been explored for its herpetofauna since 1964 (Blake 1965). The Ribáuè massif consists of two adjacent inselbergs covered with dry miombo and separated by a narrow valley (ca. 3km) with miombo woodland. We only surveyed the eastern part of the massif known as Mt. M'páluwé. We suspect that Blake (1965, p.37 & 38) previously surveyed the M'páluwé section of Mt. Ribáuè and at that time only found seven species from the lower slopes and the forest was not visited. Poynton (1966) later reviewed the amphibians collected by Blake (1965) and recorded a total of ten amphibian species from M'páluwé section of Mt. Ribáuè. Herein we present an annotated checklist of reptiles and amphibians from Mts. Mabu, Namuli, and M'páluwé. Additionally, we provide a summary of all herpetological surveys carried out to date, on these sky island forests of northern Mozambique.

## Material and methods

### Study area

The study area comprises of two mountain blocks in the Zambezia province and one in the Nampula province in northern Mozambique (Fig. 1, Table 1). The landscape in this part of the country is scattered with inselbergs surrounded by miombo woodland forest. Some of these mountains are covered with dense moist forest (e.g. Mt. Chipirone and Mt. Mabu) whereas others are just exposed granitic rocks with isolated shrubs.

For both Mt. Mabu (Fig. 2A) and Mt. Namuli (Fig. 2B), the vegetation type at low and mid-elevation, i.e. below 800 m above sea level (asl), is dominated by cultivated areas and secondary forest, which gradually changes to denser and moister forests with the increase of elevation (>1000 m asl). On Mt. M'páluwé (Fig. 2C), cultivated areas (called 'shamba' or 'machamba' locally in East Africa) dominate the lower part of the mountain, and at mid and high elevation the forest is drier – possibly due to progressive deforestation in the area as a result of the

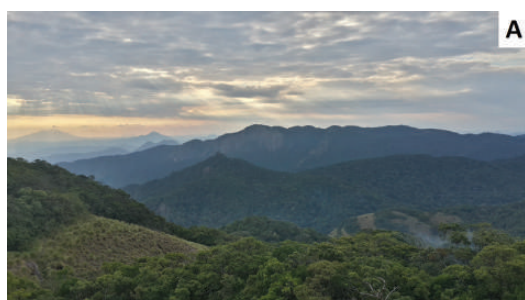

**Figure 1.** Map of localities surveyed in northern Mozambique. Black triangles indicate the mountains sampled during this study and grey triangles show other areas previously sampled in northern Mozambique and southern Malawi. Numbers indicate the following localities: (1) Mt. Chipirone, (2) Mt. Mulanje, (3) Mt. Inago, (4) Serra Jaci, (5) Serra Mecula.



**Table 1.** Localities surveyed in northern Mozambique.

Mountain	Locality	Province	Latitude	Longitude	Elevation (m)
Mabu	River Camp	Zambezia	-16.281528	36.443778	429
	Forest Base Camp	Zambezia	-16.286222	36.400056	987
	Summit Camp	Zambezia	-16.296817	36.392433	1609
Namuli	Pese dome	Zambezia	-15.386420	37.033520	1892
	Ukalini dome	Zambezia	-15.369367	37.061417	1616
	Muretha Plateau	Zambezia	-15.387194	37.044611	1892
	Satellite Camp	Zambezia	-15.397972	37.019778	1633
M'pàluwé	Oasis Water Camp	Nampula	-14.915220	38.316450	588
	Miombo area	Nampula	-14.902583	38.323306	714
	Summit area	Nampula	-14.889306	38.316139	1366

**Figure 2.** Study area, northern Mozambique sky islands. **A** – Mount Mabu, **B** – Mount Namuli, **C** – Mount M'pàluwé to the left.

internal fragmentation of the forest due to slash and burn clearing. The summits are characterised by bare granitic rocks with isolated patches of montane heath vegetation. Temporary streams are found in all three mountains but no permanent stream was found in Mt. M'pàluwé.

In northern Mozambique, the average temperature in the warmest months (December–February) varies between 20–25 °C, and in the cooler months between 15–20 °C.

The wet season lasts from November–April when the average rainfall per month is 150–300 mm (McSweeney et al. 2010a & b). During our survey we experienced a total of 36 hours of non-stop heavy rain at Mt. Mabu from 17 to 18 November 2014. The remaining time of the survey was dry and warm with no further rain.

#### Data collection

We conducted herpetofaunal surveys in the study area, between 15 November and 4 December 2014, using a combination of visual encounter survey and standard drift fences with pitfalls (each trap array consisted of 3 × 10 m long and 50 cm high fences positioned in a Y-shape with four pitfall traps at the ends and middle, and two one-way funnels per fence – only employed at Mts. Mabu and Namuli). Diurnal searches were done by actively looking for specific microhabitats including underneath rocks and logs. Nocturnal surveys were carried out with the use of headlamps or flashlights. Specimens were captured by hand, hook stick, noosing or net (e.g. tadpoles), and euthanized, according to ethically approved methods (Conroy et al. 2009), after which they were fixed in 4% buffered formalin for 48 hours and transferred to 70% alcohol for long-term storage in the herpetological collections of the Port Elizabeth Museum (PEM), South Africa, Museo delle Scienze (MUSE), Italy, and Natural History Museum of Maputo, Mozambique. Prior to formalin fixing DNA samples were collected (thigh muscle or liver), and stored in 99% ethanol for future genetic analysis.

Specimens were identified using field guides (Broadley 1990, Branch 1998, Channing 2001, Marais 2004, Du Preez and Carruthers 2009) and morphological comparison to material in the Port Elizabeth Museum. A number of specimens collected were difficult to assign to currently recognised species. In some species, e.g. *Arthroleptis* spp., *Lygodactylus* spp., specimens presented a variety of characters shared with known species and the present assignment is provisional pending ongoing studies. In some cases, further genetic and morphometric analyses will be carried out to confirm species identifications and will be presented elsewhere. We follow Frost (2016) for taxonomy of amphibians, Uetz and Hošek (2016) for reptiles, and were further updated where appropriate. In

addition to our survey findings the following literature was consulted to compile historical records for the study area: Poynton (1996), Branch and Ryan (2001), Timberlake et al. (2009, 2012), Portik et al. (2013a), and Farooq and Conradie (2015). To compile species accounts, specimens were measured for body size: snout-urostyle length (SUL) for anurans and snout-vent length (SVL) and tail length (TL) for reptiles. Measurements were taken using a digital calliper to the nearest 0.1 mm.

### Results and discussion

A total of 27 amphibian species representing 10 families and 14 genera (Table 2), and 45 reptile species (19 snakes, 25 lizards, one tortoise) representing 12 families and 31 genera (Table 3) have been recorded from the three mountains. The current survey contributed numerous additional amphibian and reptile species to the checklist of northern Mozambique inselbergs (13 for Mt. Mabu, five for Mt. Namuli and 19 for Mt. M'páluwé).

During the current survey we recorded four species of reptiles endemic to Mozambique (*Nadzikambia baylissi*, *Rhampholeon maspictus*, *Rhampholeon tilburyi*, and *Lygodactylus regulus*), and four putative new species of *Nothophryne* (Bittencourt-Silva et al. 2016). We also documented one new country record, the snake *Duberria shirana* (see account below). *Acanthocercus atricollis* was omitted from the final checklist of Mt. Namuli. It was erroneously reported by Portik et al. (2013a) to be recorded from Mt. Namuli, although they only listed specimens collected from Serra Jeci, more than 300 km to the northwest of Mt. Namuli. This record was followed in error by Farooq and Conradie (2015). Portik et al. (2013a) also reported a few species from the low-lying Gurué village and surroundings (*Breviceps mossambicus*, *Sclerophrys gutturalis*, *S. pusilla*, *Lygodactylus capensis*, *Naja melanoleuca*, and *Boaedon capensis*) and included them in their checklist for the inselbergs. As the focus of this study is to record the herpetological diversity of the sky island forests we omitted the above records, including *Agama mossambica* (current study – see species account).

**Table 2.** Updated species lists for amphibians based on historical records as well as data from the current surveys. Parentheses in the totals given denote the number of new species recorded during the current surveys. Literature records are indicated with L and new records with N.

ORDER/Family	Species	Mount Mabu	Mount Namuli	Mount M'páluwé
<b>ANURA</b>				
<b>Arthroleptidae</b>	<i>Arthroleptis francei</i>	L,N	L,N	
	<i>Arthroleptis stenodactylus</i>	L,N	N	L,N
	<i>Arthroleptis xenodactyloides</i>	L,N	L	L,N
	<i>Leptopelis broadleyi</i>			L,N
	<i>Leptopelis flavomaculatus</i>	L,N	N	
<b>Brevicipitidae</b>	<i>Breviceps mossambicus</i>		L,N	N
<b>Bufonidae</b>	<i>Sclerophrys gutturalis</i>		L,N	
	<i>Sclerophrys pusilla</i>	L,N	L	N
<b>Hyperoliidae</b>	<i>Afraxalus brachycnemis</i>	L,N	L	N
	<i>Afraxalus fornasini</i>	N		
	<i>Hyperolius nasutus</i> complex		L	
	<i>Hyperolius marmoratus albofasciatus</i>		L,N	
	<i>Hyperolius spinigularis</i>		L	
	<i>Hyperolius substriatus</i>	L,N	L,N	
<b>Phrynobatrachidae</b>	<i>Phrynobatrachus natalensis</i>			L
	<i>Phrynobatrachus acridoides</i>			L,N
	<i>Phrynobatrachus mababiensis</i>		L	L,N
<b>Pipidae</b>	<i>Xenopus laevis</i>	N		
<b>Ptychadenidae</b>	<i>Ptychadena anchietae</i>			L,N
	<i>Ptychadena taenioscellis</i>			N
	<i>Ptychadena guibei</i>			L
	<i>Ptychadena cf. porossisima</i>		L,N	
<b>Pyxicephalidae</b>	<i>Amietia quecketti</i>	N	L,N	L,N
	<i>Nothophryne cf. broadleyi</i>		L,N	L,N
	<i>Strongylopus fuelleborni</i>	N	L,N	
<b>Rhacophoridae</b>	<i>Chiromantis xerampelina</i>			L
<b>GYMNOPHIONA</b>				
<b>Scolecophoridae</b>	<i>Scolecophorus kirkii</i>	N	L	
		<b>12 (5)</b>	<b>18 (2)</b>	<b>15 (4)</b>

SUPPLEMENTARY MATERIALS: ADDITIONAL PUBLICATIONS

Zoosyst. Evol. 92 (2) 2016, 163–180

167

**Table 3.** Updated species lists for reptiles based on historical records as well as data from the current surveys. Parentheses in the totals given denote the number of new species recorded during the current surveys. Literature records are indicated with L and new records with N.

ORDER/Family	Species	Mount Mabou	Mount Namuli	Mount M'pâluwé
<b>CHELONIA</b>				
Testudinidae	<i>Kinixys belliana</i>		L	
<b>SQUAMATA</b>				
Agamidae	<i>Agama kirkii</i>		L,N	N
	<i>Agama mossambica</i>	L	L	
Chamaeleonidae	<i>Chamaeleo dilepis</i>		L,N	
	<i>Nadzikambia baylissi</i>	L,N	N	
	<i>Rhampholeon tilburyi</i>		L,N	
	<i>Rhampholeon maspictus</i>	L,N		
	<i>Rhampholeon</i> sp.			N
	<i>Trioceros melleri</i>	L		
Cordylidae	<i>Platysaurus maculatus</i>			L,N
Gekkonidae	<i>Chondrodactylus turneri</i>			N
	<i>Hemidactylus mabouia</i>	N	L	
	<i>Hemidactylus platycephalus</i>	L		N
	<i>Lygodactylus grotei</i>	N		
	<i>Lygodactylus regulus</i>		L,N	
	<i>Lygodactylus</i> cf. <i>rex</i>	N		
	<i>Lygodactylus</i> sp.			N
Lacertidae	<i>Holaspis laevis</i>	N		
Scincidae	<i>Melanoseps</i> cf. <i>ater</i>	L,N	L	
	<i>Mochlus afer</i>	L		
	<i>Panaspis wahlbergi</i>		L	
	<i>Trachylepis boulengeri</i>			N
	<i>Trachylepis maculilabris</i>	N		
	<i>Trachylepis margaritifera</i>	L	L	N
	<i>Trachylepis striata</i>		L,N	
Colubridae	<i>Trachylepis varia</i>	L,N	L,N	N
	<i>Dispholidus typus</i>		N	L,N
	<i>Dipsadoboa</i> cf. <i>shrevei shrevei</i>	L,N		N
	<i>Philothamnus angolensis</i>		L,N	
	<i>Philothamnus</i> cf. <i>carinatus</i>	L		
	<i>Philothamnus hoplogaster</i>	N		N
Elapidae	<i>Thelotornis mossambicanus</i>	N	L	N
	<i>Naja melanoleuca</i>	L,N	L	
Lamprophiidae	<i>Naja mossambica</i>			N
	<i>Boaedon capensis</i>		L	N
	<i>Duberria shirana</i>		N	
	<i>Gonionotophis capensis</i>	N		
	<i>Lycophidion acutirostre</i>		L	
	<i>Psammophis orientalis</i>			N
Natricidae	<i>Psammophylax variabilis</i>		L,N	
	<i>Natriciteres sylvatica</i>	L	L	
Viperidae	<i>Atheris mabuensis</i>	L	L	
	<i>Bitis arietans</i>		L	N
	<i>Bitis gabonica</i>	L	L	
	<i>Causus defilippi</i>			L
		<b>23 (8)</b>	<b>27 (3)</b>	<b>17 (15)</b>

zse.pensoft.net

**Selected species accounts**

**Amphibia**

**Anura**

**Arthroleptidae**

***Arthroleptis francei* Loveridge, 1953**

**Material.** Mt. Mabu (PEM A11180, male, 25.5 mm SUL; PEM A11181, male, 21.4 mm SUL; PEM A11182, male, 22.9 mm SUL; PEM A11183, male, 19.0 mm SUL; PEM A11192, female, 34.5 mm SUL; PEM A11193, female, 24.6 mm SUL; PEM A11194, male, 20.6 mm SUL; PEM A11195, juvenile, 12.1 mm SUL; PEM A11196, juvenile, 14.7 mm SUL; PEM A11197, juvenile, 17.3 mm SUL; PEM A11198, male, 23.16 mm SUL; PEM A11199, female, 34.7 mm SUL; PEM A11200, male, 24.7 mm SUL; PEM A11201, female, 21.5 mm SUL; PEM A11202, male, 21.4 mm SUL; PEM A11204, male, 25.7 mm SUL; PEM A11205, juvenile, 18.5 mm SUL; PEM A11206, female, 23.2 mm SUL; PEM A11207, male, 23.6 mm SUL; PEM A11208, male, 22.8 mm SUL; PEM A11209, female, 31.3 mm SUL; PEM A11268, female, 31.0 mm SUL; PEM A11292, female, 36.2 mm SUL; PEM A11294, juvenile, 15.1 mm SUL; PEM A11403, female, 31.8 mm SUL), Mt. Namuli (PEM A11296, juvenile, 13.0 mm SUL; PEM A11297, juvenile, 16.6 mm SUL; PEM A11298, female, 32.6 mm SUL; PEM A11299, male, 20.4 mm SUL; PEM A11303, female, 32.0 mm SUL; PEM A11304, male, 24.8 mm SUL; PEM A11305, juvenile, 17.4 mm SUL; PEM A11306, juvenile, 17.8 mm SUL; PEM A11307, female, 35.4 mm SUL; PEM A11308, juvenile, 18.4 mm SUL; PEM A11341, juvenile, 15.0 mm SUL; PEM A11398, male, 24.0 mm SUL; PEM A11404, female, 35.5 mm SUL). **Comments:** Specimens were collected from moist leaf litter in closed-canopy forest (Fig. 3A). Some individuals were found sitting on low vegetation (<1 m). All mature males exhibit extended third finger and dark throat.

***Arthroleptis stenodactylus* Pfeffer, 1893**

**Material.** Mt. Mabu (PEM A11203, male, 25.5 mm SUL; PEM A11249, male, 31.6 mm SUL; PEM A11266, female, 30.4 mm SUL; PEM A11267, male, 23.4 mm SUL; PEM A11277, male, 22.1 mm SUL; PEM A11293, male, 23.0 mm SUL), Mt. M'páluwé (PEM female, 26.1 mm SUL). **Comments:** Found in both dry transitional miombo woodland and montane forest (Fig. 3C). This species is very similar to *A. francei*, which seems to be more abundant in these forests. One feature that helps to separate these two species is the hind limbs, being shorter in *A. stenodactylus*.

***Arthroleptis xenodactyloides* Hewitt, 1933**

**Material.** Mt. Mabu (PEM A11210, female, 16.3 mm SUL; PEM A11211, male, 16.1 mm SUL; PEM

A11212, male, 16.8 mm SUL; PEM A11213, female, 18.3 mm SUL; PEM A11214, male, 15.3 mm SUL; PEM A11215, male, 12.1 mm SUL; PEM A11216, female, 15.2 mm SUL; PEM A11217, male, 13.9 mm SUL; PEM A11218, male, 13.2 mm SUL; PEM A11219, male, 13.1 mm SUL; PEM A11220, male, 15.4 mm SUL; PEM A11221, female, 17.4 mm SUL; PEM A11222, female, 17.1 mm SUL; PEM A11223, male, 15.8 mm SUL; PEM A11224, male, 12.9 mm SUL; PEM A11225, male, 14.2 mm SUL; PEM A11226, male, 15.9 mm SUL; PEM A11227, male, 13.5 mm SUL; PEM A11228, male, 17.7 mm SUL; PEM A11229, female, 15.0 mm SUL; PEM A11230, female, 16.7 mm SUL; PEM A11231, female, 17.4 mm SUL; PEM A11232, female, 16.3 mm SUL; PEM A11233, female, 15.2 mm SUL; PEM A11234, female, 17.6 mm SUL; PEM A11269, male, 15.6 mm SUL; PEM A11270, female, 18.8 mm SUL; PEM A11271, female, 22.1 mm SUL; PEM A11272, female, 19.9 mm SUL; PEM A11273, male, 17.4 mm SUL; PEM A11274, male, 18.3 mm SUL; PEM A11275, female, 19.0 mm SUL; PEM A11276, female, 16.8 mm SUL; PEM A11278, female, 17.5 mm SUL; PEM A11279, female, 17.6 mm SUL; PEM A11280, male, 14.8 mm SUL; PEM A11295, male, 15.4 mm SUL; PEM A11401, male, 17.8 mm SUL; PEM A11402, female, 17.2 mm SUL), Mt. M'páluwé (PEM A11377, male, 15.0 mm SUL; PEM A11378, male, 15.5 mm SUL; PEM A11379, female, 17.6 mm SUL; PEM A11380, female, 19.3 mm SUL; PEM A11386, female, 17.8 mm SUL; PEM A11387, female, 17.5 mm SUL; PEM A11388, female, 16.3 mm SUL; PEM A11389, male, 15.2 mm SUL). **Comments:** In Mt. Mabu it was common on the forest floor, and at Mt. M'páluwé it was found in moist leaf litter at lower elevations (Fig. 3B). Mature males exhibit extended third finger and dark throat.

***Leptopelis broadleyi* Poynton, 1985**

**Material.** Mt. M'páluwé (PEM A11367, male, 30.9 mm SUL). **Comments:** Sub-adult male specimen was collected from mid-elevation slopes while calling from low vegetation. This species is part of the *L. argenteus* group. Some authors regard this as a valid species (Poynton and Broadley 1987, Schiøtz 1999, Channing and Howell 2006, Pickersgill 2007, Du Preez and Carruthers 2009, Mercurio 2011, Ohler and Frétey 2014), while Frost (2016) considers it as a junior synonym of *L. argenteus* based on similar calls. Herein we consider *L. broadleyi* as a valid species pending further investigation.

***Leptopelis flavomaculatus* (Günther, 1864)**

**Material.** Mt. Mabu (PEM A11240, male, 50.3 mm SUL; PEM A11241, male, 38.1 mm SUL; PEM A11242, female, 72.0 mm SUL; PEM A11243, male, 48.1 mm



SUL; PEM A11244, male, 39.2 mm SUL; PEM A11245, female, 71.0 mm SUL; PEM A11246, female, 35.1 mm SUL; PEM A11247, male, 41.0 mm SUL; PEM A11290, male, 42.8 mm SUL), Mt. Namuli (PEM A11309, female, 65.2 mm SUL). **Comments:** Common along streams at both Mt. Mabu and Mt. Namuli. In most cases, the males of this species are much smaller and have a uniform lime-green dorsum with yellow spots. All the males have well developed pectoral glands. Females are much larger with dull brown dorsum with scattered green spots or patterns.

#### Brevicipitidae

##### *Breviceps mossambicus* Peters, 1882

**Material.** Mt. Namuli (PEM A11310, male, 25.4 mm SUL), Mt. M'páluwé (PEM A11362, male, 23.0 mm SUL). **Comments:** Both specimens are males, based on the presence of a very dark throat and small size. The specimen from Mt. M'páluwé was collected at night in a shamba at mid-elevation (ca. 1000 m).

#### Bufonidae

##### *Sclerophrys gutturalis* (Power, 1927)

**Material.** Mt. Namuli (PEM A11348, female, 68.8 mm SUL). **Comments:** One adult female collected from Muretha Plateau at night. No red infusions on the thighs or side of the body were observed, but the well-elevated parotid glands exclude it from being *S. pusilla*.

##### *Sclerophrys pusilla* (Mertens, 1937)

**Material.** Mt. Mabu (PEM A11260, male 64.6 mm SUL; PEM A11261, male 55.3 mm SUL; PEM A11262, male 63.1 mm SUL; PEM A11263, male 60.3 mm SUL; PEM A11264, male 54.8 mm SUL; PEM A11265, male 63.1 mm SUL), Mt. M'páluwé (PEM A11364, male 63.1 mm SUL; PEM A11365 male, 53.2 mm SUL, PEM A11384, male 64.9 mm SUL). **Comments:** Specimens were found calling along low-elevation streams at dusk.

#### Hyperoliidae

##### *Afrixalus brachynemis* (Boulenger, 1896)

**Material.** Mt. Mabu (PEM A11250, male, 19.5 mm SUL), Mt. M'páluwé (PEM A11392, female, 317.8 mm SUL; PEM A11393, female, 21.2 mm SUL). **Comments:** Adult male was collected during the day sitting on a leaf in an open area at lower slopes of Mt. Mabu. Two females were collected sheltering in sugarcane fronds at the base of Mt. M'páluwé. Species identification was based on the absence of dorsal patterning and transverse tibial bands (Pickersgill 2007). Others also reported this species to be present in northern Mozambique (Branch 2004, Portik et al. 2013a, Ohler and Frétey 2014).

##### *Afrixalus fornasinii* (Bianconi, 1849)

**Material.** Mt. Mabu (PEM A11251, female, 36.5 mm SUL; PEM A11252, female, 38.3 mm SUL; PEM A11253, female, 31.7 mm SUL). **Comments:** Three females were collected along a low-elevation forest stream. One female (PEM A11252) was gravid (collected 15 November 2014).

##### *Hyperolius marmoratus albofasciatus* (Hoffman, 1944)

**Material.** Mt. Namuli (PEM A11311, male, 27.8 mm SUL; PEM A11312, female, 26.5 mm SUL; PEM A11313, female, 33.6 mm SUL; PEM A11349, juvenile, 15.8 mm SUL; PEM A11350, juvenile, 18.8 mm SUL; PEM A11354, male, 30.6 mm SUL; PEM A11355, male, 33.7 mm SUL; PEM A11356, male, 34.2 mm SUL; PEM A11360, juvenile, 26.2 mm SUL). **Comments:** Found to be abundant on the grassland of the Muretha Plateau at Mt. Namuli. Males were found calling from very low vegetation close to water level. Adult males and females exhibit the same dorsal pattern indicating no sexual dichromatism. The *H. marmoratus* group consists of many regional colour patterns and this population conforms to that of *H. marmoratus albofasciatus* (Schlötz 1999). We believe that the two juvenile *H. marmoratus* reported from Mt. Namuli by Portik et al. (2013a) belongs to the same species group.

##### *Hyperolius substriatus* Ahl, 1931

**Material.** Mt. Mabu (PEM A11235, female, 27.7 mm SUL; PEM A11236, female, 30.4 mm SUL; PEM A11237, female, 28.0 mm SUL; PEM A11238, female, 27.3 mm SUL; PEM A11239, female, 29.0 mm SUL; PEM A11281, female, 29.7 mm SUL; PEM A11282, female, 29.6 mm SUL; PEM A11283, female, 23.4 mm SUL; PEM A11284, female, 35.3 mm SUL; PEM A11285, female, 22.5 mm SUL; PEM A11286, female, 22.1 mm SUL; PEM A11287, female, 29.1 mm SUL; PEM A11288, female, 27.2 mm SUL; PEM A11289, female, 26.9 mm SUL), Mt. Namuli (PEM A11314, female, 27.3 mm SUL; PEM A11315, female, 27.4 mm SUL; PEM A11316, female, 23.4 mm SUL; PEM A11317, female, 32.4 mm SUL; PEM A11318, female, 32.4 mm SUL; PEM A11361, female, 24.8 mm SUL). **Comments:** Found in abundance at low, mid (ca. 920 m asl) and high elevations along forested streams at both Mts. Mabu and Namuli. All material showed typical adult coloration, similar to that reported by Portik et al. (2013a) from Mt. Namuli.

#### Phrynobatrachidae

##### *Phrynobatrachus acridoides* (Cope, 1867)

**Material.** Mt. M'páluwé (PEM A11366, male, 26.6 mm SUL; PEM A1375, male, 26.4 mm SUL). **Comments:** Found moving near stagnant pools at a low-elevation

(544 m asl) streams. Species identification was based on extensive webbing and swollen toe tips. Poynton (1966) records both *P. natalensis* and *P. acridoides* from Mt. M'páluwé area. We only found the latter.

***Phrynobatrachus mababiensis* FitzSimons, 1932**

**Material.** Mt. M'páluwé (PEM A11381, male, 14.6 mm SUL; PEM A11382, male, 13.5 mm SUL; PEM A11383, male, 12.7 mm SUL; PEM A11390, male, 14.0 mm SUL; PEM A11391, male, 14.8 mm SUL; PEM A11394, female, 14.5 mm SUL). **Comments:** Specimens were found in dry leaf litter at low elevation, and two individuals were collected in the same microhabitat as *Nothophryne* cf. *broadleyi* (in water seepage over rocks).

**Pipidae**

***Xenopus laevis* (Daudin, 1802)**

**Material.** Mt. Mabu (PEM A11291, female, 45.8 mm SUL). **Comments:** One specimen was collected from a low-elevation stream below an old hydroelectricity dam. Poynton and Broadley (1991) report no records of *X. laevis* for northern Mozambique, but do report it from southern Malawi. The Malawi population has been confirmed by molecular analyses to be *X. laevis* (Furman et al. 2015). On the other hand, *X. muelleri* is common in lowland Mozambique. Ohler and Frétey (2014) reported the first record of *X. petersii* for Mozambique. Based on a low number of plaques (17 plaques around the eye and 20 from eye to vent) their assignment of the specimen to *X. petersii* is doubtful and most likely represents *X. laevis* (which shows the same level of variation in plaque counts).

**Ptychadenidae**

***Ptychadena anchietae* (Bocage, 1868)**

**Material.** Mt. M'páluwé (PEM A11376, male, 35.0 mm SUL). **Comments:** Was found on dry leaf litter at low elevation.

***Ptychadena* cf. *porosissima* (Steindachner, 1867)**

**Material.** Mt. Namuli (PEM A11351, female, 31.8 mm SUL). **Comments:** Collected from grassland on Muretha Plateau. This specimen is tentatively identified as *Ptychadena* cf. *porosissima* using the key provided in Poynton and Broadley (1985). The specimen lacks the characteristic tibial white line.

***Ptychadena taenioscelis* Laurent, 1954**

**Material.** Mt. M'páluwé (PEM A11368, female, 31.7 mm SUL). **Comments:** Found on dry leaf litter at low

slopes of Mt. M'páluwé. Identification was based on the key provided in Poynton and Broadley (1985).

**Pyxicephalidae**

***Amietia delalandii* (Duméril & Bibron, 1841)**

**Material.** Mt. Mabu (PEM A11188, male, 77.2 mm SUL; PEM A11189, juvenile, 27.3 mm SUL; PEM A11190, male 58.3 mm SUL; PEM A11191, female, 75.5 mm SUL; PEM A11254, male, 52.8 mm SUL; PEM A11255, juvenile, 29.3 mm SUL; PEM A11256, female, 63.3 mm SUL; PEM A11257, female, 73.3 mm SUL; PEM A11258, female, 74.7 mm SUL; PEM A11259, juvenile, 32.5 mm SUL), Mt. Namuli (PEM A11300, female, 83.7 mm SUL; PEM A11301, female, 44.0 mm SUL; PEM A11302, male, 74.6 mm SUL; PEM A11319, male, 86.4 mm SUL; PEM A11397, female, 50.3 mm SUL, PEM T692-3), Mt. M'páluwé (PEM A11363, male, 57.0 mm SUL; PEM A11373; male, 32.0 mm SUL; PEM A11374, juvenile, 29.8 mm SUL; PEM A11395, juvenile, 29.3 mm SUL; PEM A11396, juvenile, 26.4 mm SUL). **Comments:** Channing and Baptista (2013) revised southern African river frogs and restrict *A. angolensis* to Angola and assign southern populations of *A. angolensis* to either *A. quecketti* or *A. poyntoni*. Channing et al. (2016) re-instated *A. delalandii* as a senior synonym of *A. quecketti*. More recently, Larson et al. (2016) identified several well-supported cryptic lineages of river frogs previously assigned to *A. angolensis* in the Albertine Rift region, which refer that further cryptic diversity can be expected in East Africa. The phylogenetic affinities of our newly sampled population are unknown and additional work will be necessary to clarify its taxonomic status. Commonly found at both low and high elevation in forested streams (Fig. 3D).

***Nothophryne* cf. *broadleyi* Poynton, 1963**

**Material.** Mt. Namuli (PEM A11320, male, 17.9 mm SUL; PEM A11321, female, 22.7 mm SUL; PEM A11322, male, 18.1 mm SUL; PEM A11322, PEM A11323, female, 23.4 mm SUL; PEM A11324, male, 18.0 mm SUL; PEM A11325, juvenile, 19.0 mm SUL; PEM A11326, male, 17.5 mm SUL; PEM A11327, male, 18.7 mm SUL; PEM A11328, female, 25.3 mm SUL; PEM A11329, male, 19.5 mm SUL; PEM A11330, female, 20.7 mm SUL; PEM A11331, male, 18.2 mm SUL; PEM A11332, juvenile, 17.1 mm SUL; PEM A11333, male, 17.4 mm SUL; PEM A11334, male, 18.2 mm SUL; PEM A11335, male, 17.5 mm SUL; PEM A11336, juvenile, 13.9 mm SUL; PEM A11337, juvenile, 13.3 mm SUL; PEM A11338, juvenile, 15.7 mm SUL; PEM A11339, female, 25.9 mm SUL; PEM A11340, male, 17.5 mm SUL; PEM A11342, male, 18.1 mm SUL; PEM A11343, female, 22.0 mm SUL; PEM A11344, male, 18.4 mm SUL; PEM A11345, male, 18.0 mm SUL; PEM A11346, male,

17.7 mm SUL; PEM A11347, male, 17.4 mm SUL), Mt. M'pàluwé (PEM A11369, female, 21.7 mm SUL; PEM A11370, female, 23.8 mm SUL; PEM A11371, male, 19.2 mm SUL; PEM A11372, male, 18.1 mm SUL). **Comments:** Specimens were collected both during the day and at night from rocky outcrops in water seepages (Fig. 3E, 3F). Historically, *Nothophryne* has only been reported from two localities: Mt. Mulanje, Malawi (type locality) and Mt. M'pàluwé in Mozambique (Poynton 1962 & 1966, Blake 1965), both higher than 1200 m asl. Timberlake et al. (2009) were the first to report this species from Mt. Namuli. Some calls similar to *Nothophryne* were heard from the summit of Mt. Mabu, but no frog was visually located to confirm the species occurrence in this mountain. Genetic analyses suggest a cryptic diversity in this genus (Bittencourt-Silva et al. 2016) and additional work is underway to update its taxonomy. Based on its small distribution these nominotypical species is listed as Endangered (Mazibuko and Poynton 2004). Referring to that the undescribed species will receive similar red list status.

#### *Strongylopus cf. fuelleborni* (Nieden, 1911)

**Material.** Mt. Mabu (PEM A11184, male, 35.5 mm SUL; PEM A11185, male, 36.3 mm SUL; PEM A11186, male, 35.3 mm SUL; PEM A111857, male, 37.3 mm SUL, PEM T691), Mt. Namuli (PEM 11352, juvenile, 27.9 mm SUL; PEM A11353, female, 49.8 mm SUL; PEM A11357, female, 49.1 mm SUL; PEM A11358, female, 49.9 mm SUL; PEM A11359, female, 43.6 mm SUL). **Comments:** Part of the *Strongylopus faciatus* group that has seen two newly described species in recent years (Channing and Davenport 2002, Clarke and Poynton 2005). Mercurio (2011) assign *Strongylopus* from Mt. Mulanje to *S. merumontanus*. While Poynton (2004) don't list them from southern Malawi and rather refer to them as *S. fuelleborni*. The phylogenetic affinities of our newly sampled population are unknown and additional work will be necessary to clarify its taxonomic status. For now, we assign them to *S. fuelleborni*. Adult specimens and tadpoles were found along a high-elevation stream in a patch of Afromontane forest at Mt. Mabu (Fig. 3G). Specimens from Mt. Namuli were collected along marshy areas in montane grassland.

#### Gymnophiona Scolecomorphidae

#### *Scolecomorphus cf. kirkii* Boulenger, 1883

**Material.** Mt. Mabu (PEM A11248). **Comments:** A single specimen was found under a log in the closed canopy forest of Mt. Mabu after 36 hours of heavy rain (Fig. 3H). The specimen (probably a young female) measures 210 mm total length, 6.3 mm body width and has 142 pri-

mary annuli. The olive-brown dorsal colouration of the preserved specimen is dorsally restricted and the venter is light yellowish (pinkish in life), agreeing with the description of Nussbaum (1985). This new record represents the southernmost distribution of *Scolecomorphus kirkii*, and for all African caecilians. Branch (2004) reported the first ever caecilian record for Mozambique from dry transitional miombo vegetation at the edge of Serra Mecula, while Farooq and Conradie (2015) recorded a second record from Mt. Namuli.

#### Reptilia Squamata Agamidae

#### *Agama kirkii* Boulenger, 1885

**Material.** Mt. Namuli (PEM R21169, male, 93.0 mm SVL; PEM R21171, female, 81.5 mm SVL), Mt. M'pàluwé (PEM R21159, female, 77.2 mm SVL; PEM R21211, male, 106.9 mm SVL). **Comments:** Collected at the lower slopes on the rocky outcrops of both Mt. Namuli and Mt. M'pàluwé. Both males brightly coloured, while females are dull in overall colouration.

#### *Agama mossambica* Peters, 1854

**Material.** Mt. Namuli (PEM R21114, female, 95.7 mm SVL). **Comments:** One specimen collected in Gurúè town. This record was omitted from our final checklist of the inselbergs, as it was collected from the low lying town (see Results and Discussion).

#### Chamaeleonidae

#### *Chamaeleo dilepis* Leach, 1819

**Material.** Mt. Namuli (PEM R21170, female, 104.7 mm SVL). **Comments:** One specimen donated by a local, presumably obtained from near the village just below the Muretha Plateau.

#### *Nadzikambia baylissi* Branch & Tolley, 2010

**Material.** Mt. Mabu (PEM R21128, male, 73.7 mm SVL; PEM R21129, female, 64.8 mm SVL; PEM R21130, female, 66.4 mm SVL; PEM R21131, male, 68.3 mm SVL; PEM R21132, female, 57.9 mm SVL), Mt. Namuli (PEM R21164, female, 79.9 mm SVL; PEM R21165, male, 71.4 mm SVL; PEM R21166, female, 75.5 mm SVL; PEM R21167, female, 79.3 mm SVL; PEM R21188, female, 74.3 mm SVL; PEM R21189, female, 72.0 mm SVL; PEM R21190, female, 80.1 mm SVL). **Comments:** Collected from canopy forest, in Afromontane forest above 600 m asl. Historically, *Nadzikambia* was considered a



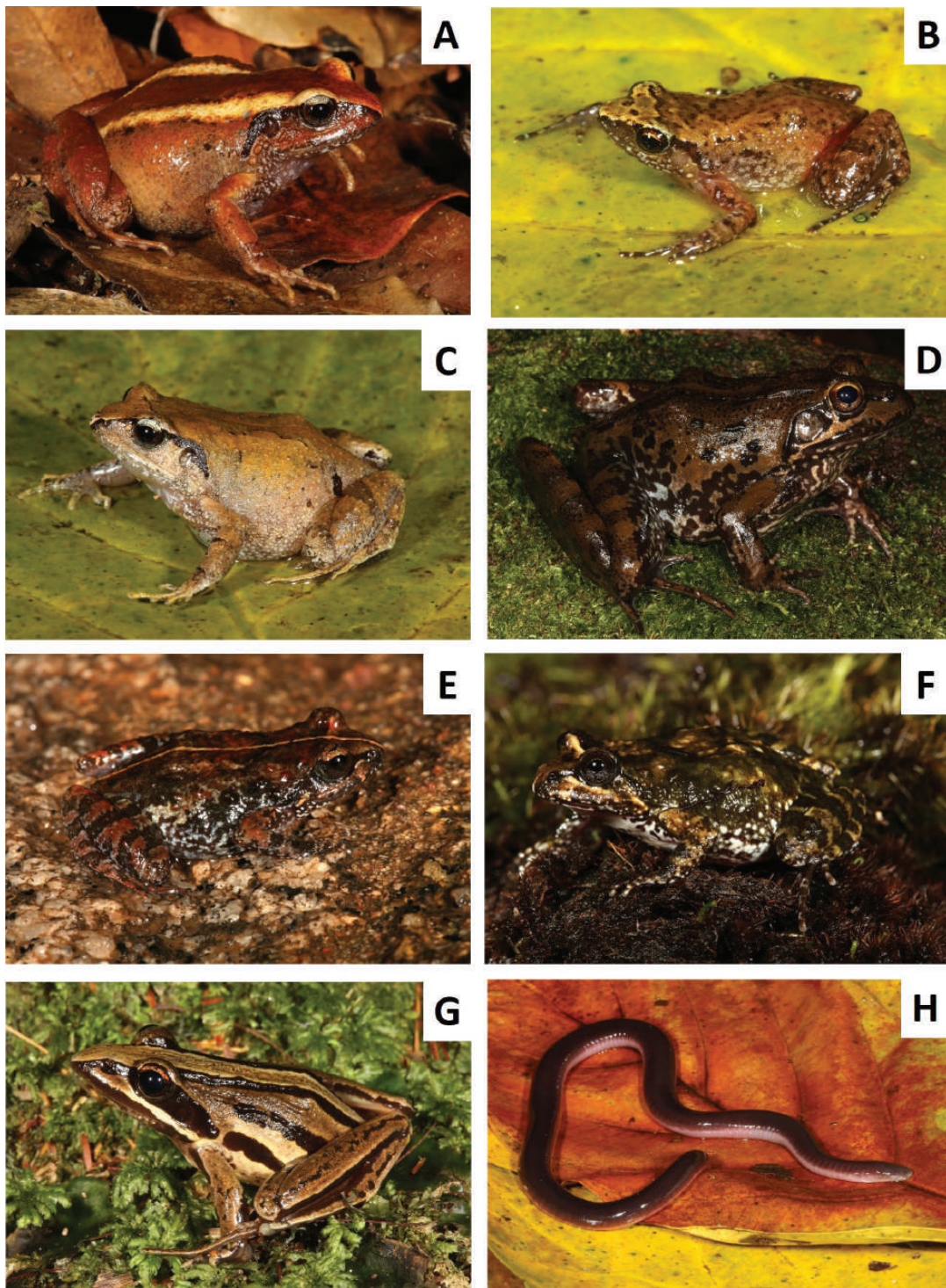

**Figure 3.** A selection of amphibians from northern Mozambique inselbergs. **A** – *Arthroleptis franciei* (Mt. Namuli, PEM A11303), **B** – *Arthroleptis xenodactyloides* (Mt. Mabu), **C** – *Arthroleptis stenodactylus* (Mt. Mabu), **D** – *Amietia delalandii* (Mt. Namuli, PEM A11319), **E** – *Nothophryne* cf. *broadleyi* (Mt. M'páluwé, PEM A11370), **F** – *Nothophryne* cf. *broadleyi* (Mt. Namuli), **G** – *Strongylopus* cf. *fuelleborni* (Mt. Mabu, PEM A11184), **H** – *Scolecormorphus* cf. *kirkii* (Mt. Mabu, PEM A11248).

monotypic genus endemic to Mt. Mulanje (Broadley 1965a), but recently Branch and Tolley (2010) described a second species from Mt. Mabu. We here report the first record for Mt. Namuli (Fig. 4A).

***Rhampholeon tilburyi* Branch, Bayliss & Tolley, 2014**

**Material.** Mt. Namuli (PEM R21155, female, 58.7 mm SVL; PEM R21156, female, 53.2 mm SVL; PEM R21157, male, 62.2 mm SVL; PEM R21158, male, 65.4 mm SVL; PEM R21160, male, 62.7 mm SVL; PEM R21161, male, 61.4 mm SVL; PEM R21162, male, 66.5 mm SVL; PEM R21163, female, 69.7 mm SVL; PEM R21174, female, 61.1 mm SVL; PEM R21175; PEM R21176, female, 57.6 mm SVL; PEM R21177, juvenile, 26.6 mm SVL; PEM R21178, female, 52.3 mm SVL; PEM R21191, female, 60.6 mm SVL; PEM R21192, male, 45.4 mm SVL; PEM R21193, juvenile male, 28.2 mm SVL; PEM R21194, female, 58.2 mm SVL). **Comments:** This newly described species of pygmy chameleon was collected from Mt. Namuli at both the Ukalini forest and the forest patches on the Muretha Plateau (Fig. 4B). Considerable morphological differences, e.g. well-developed dorsal crenulations, continues and well developed temporal ridge, and reduced rostral and supraocular processes, were observed between the two sub-populations of Mt. Namuli.

***Rhampholeon maspictus* Branch, Bayliss & Tolley, 2014**

**Material.** Mt. Mabu (PEM R21117, male, 53.8 mm SVL; PEM R21118, male, 62.4 mm SVL; PEM R21119, juvenile male, 31.7 mm SVL; PEM R21120, juvenile female, 30.6 mm SVL; PEM R21121, juvenile female, 35.8 mm SVL; PEM R21133, juvenile female, 36.7 mm SVL; PEM R21134, juvenile male, 41.9 mm S; PEM R21135, female, 39.0 mm SVL; PEM R21136, female, 60.5 mm SVL; PEM R21136, female, 60.5 mm SVL; PEM R21137, male, 64.5 mm SVL; PEM R21138, male, 65.8 mm SVL; PEM R21139, female, 47.0 mm SVL; PEM R21140, juvenile female, 36.5 mm SVL; PEM R2141, juvenile male, 42.0 mm SVL). **Comments:** Specimens were found in Afromontane forest above 1900 m asl. This species is restricted to Mt. Mabu.

***Rhampholeon* sp.**

**Material.** Mt. M'pàluwé (PEM R21202, female, 45.8 mm SVL; PEM R21203, female, 57.3 mm SVL; PEM R21204, female, 44.1 mm SVL; PEM R21205, female, 65.1 mm SVL; PEM R21206, female, 56.2 mm SVL; PEM R21207, female, 40.7 mm SVL; PEM R21208, male, 34.0 mm SVL; PEM R21209, female, 61.9 mm SVL; PEM R21210, male, 37.5 mm SVL). **Comments:** This is the first record of a pygmy chameleon from Mt. Ribuaùè insulates forests (Fig. 4C). Based on the isola-

tion of all the northern Mozambique inselbergs and high genetic differences reported by Branch et al. (2014), it is highly plausible that this new population represents an undescribed species. Most similar to *R. tilburyi* in external morphology.

**Cordylidae**

***Platysaurus maculatus* (Broadley, 1965)**

**Material.** Mt. M'pàluwé (PEM R21220, subadult female, 62.7 mm SVL; PEM R21221, male, 79.5 mm SVL; PEM R21222, female, 62.9 mm SVL; PEM R21223, male, 81.7 mm SVL; PEM R21224, male, 75.8 mm SVL). **Comments:** Collected from the lower slopes of Mt. M'pàluwé where they were found in abundance running on rocky slopes. Previously, collected from Mt. M'pàluwé [=Ribuaùè] by Blake (1965), which formed part of the type series of this species (Broadley 1965b). This species is now regarded as widespread in northern Mozambique (Broadley 1965b, Branch et al. 2005) and southern Tanzania (Broadley 1995).

**Gekkonidae**

***Chondrodactylus turneri* (Gray, 1864)**

**Material.** Mt. M'pàluwé (PEM R21199, juvenile, 35.3 mm SVL; PEM R21200, juvenile, 39.5 mm SVL; PEM R21213, juvenile, 47.7 mm SVL). **Comments:** Collected at night on rock surface at lower slopes.

***Hemidactylus mabouia* (Moreau De Jonnès, 1818)**

**Material.** Mt. Mabu (PEM R21124, female, 62.5 mm SVL; PEM R21143, male, 48.5 mm SVL; PEM R21144, male, 51.9 mm SVL), Mt. M'pàluwé (PEM R21215, female, 51.6 mm SVL; PEM R21216, male, 59.4 mm SVL). **Comments:** Collected at Mt. Mabu from rock surface and under tree bark in low to mid-elevation. At Mt. M'pàluwé specimens were collected in sympatry with *H. platycephalus* on derelict buildings of the Oasis Water Camp.

***Hemidactylus platycephalus* Peters, 1854**

**Material.** Mt. M'pàluwé (PEM R21217, female, 81.4 mm SVL; PEM R21218, male, 72.9 mm SVL). **Comments:** Collected from derelict buildings and mango trees around the Oasis Water Camp.

***Lygodactylus grotei* Sternfeld, 1911**

**Material.** Mt. Mabu (PEM R21125, female, 30.7 mm SVL). **Comments:** Collected at the base of a tree in dry miombo woodland.



***Lygodactylus regulus* Portik, Travers, Bauer & Branch, 2013**

**Material.** Mt. Namuli (PEM R21168, female, 33.8 mm SVL). **Comments:** Recently described gecko related to the larger *L. rex* from Mt. Mulanje (see Portik et al. 2013b). Only known from three specimens collected from Mt. Namuli. Our specimen was collected from a fallen tree in a shamba.

***Lygodactylus cf. rex* Broadley, 1963**

**Material.** Mt. Mabu (PEM R21147, male, 48.1 mm SVL; PEM R21148, male, 42.1 mm SVL). **Comments:** Specimens were collected from tree trunks in transitional miombo at lower slopes (Fig. 4D). These large geckos are morphologically similar to *L. rex* from Mt. Mulanje in that they share the large size of typical *L. rex* (up to 55 SVL: Portik et al. 2013b), the mental scale is very shallow with lateral slits, and the conspicuous ocellus (spot) above the shoulder. Given the high level of genetic diversity in montane species of this genus (Portik et al. 2013b, Travers et al. 2014) this could either represent an extension of its distribution or a new species. For that reason, we tentatively assign it to *L. rex*.

***Lygodactylus* sp.**

**Material.** Mt. M'páluwé (PEM R21196, female, 41.0 mm SVL). **Comments:** One individual collected from a tree trunk in a newly cleared shamba at the top of Mt. M'páluwé at night. Specimen from Mt. M'páluwé differs from *L. cf. rex* from Mt. Mabu, and *L. regulus* from Mt. Namuli in that they lack the conspicuous ocellus above the shoulder. It closely resembles *L. angularis* in general throat markings and that the mental is entire and not split with shallow lateral slits as in the *L. rex* group.

**Lacertidae**

***Holaspis laevis* Werner, 1895**

**Material.** Mt. Mabu (PEM R21145, male, 48.8 mm SVL; PEM R21146, male, 48.0 mm SVL). **Comments:** Found on tree trunks in transitional miombo woodland at lower slopes (Fig. 4E). This secretive species is only known from Amatongas, in central Mozambique (Cotts 1934) and numerous unpublished records from other localities in Mozambique: Marromeu area (Branch pers. obs. in Branch 2000), Moebase (Branch pers. obs. in Branch 2000), Cavallo near Gorongosa Mountain (Broadley pers. obs. in Branch 2000), Dondo Inhamitanga Forests (Broadley pers. obs. in Branch 2000), Quiterajo (Conradie pers. obs.), Italthai (Verburgt pers. obs.), and Palma (Verburgt pers. obs.). It has also been recorded from southern Malawi from the Ruo River Gorge (Branch and Cunningham 2006).

**Scincidae**

***Melanoseps cf. ater* (Günther, 1873)**

**Material.** Mt. Mabu (PEM R21126, 93 mm SVL, 28.6 mm TL; PEM R21127, 121 SVL, 39.9 mm TL). **Comments:** Broadley et al. (2006) assigned the northern Mozambique specimens to *M. loveridgei*, while specimens from southern Malawi are referred to as *M. ater*. We used the key from Broadley et al. (2006) to identify the specimens based on number mid-body scale rows (24). Timberlake et al. (2012) were the first to report this species from Mt. Mabu and this was only the second record for this genus in Mozambique. Farooq and Conradie (2015) recorded *M. cf. loveridgei* from Mt. Namuli. This identification was tentative, as material got lost in a motor vehicle accident and could not be examined. Based on the close proximity to Mt. Mabu the Mt. Namuli record should be regarded as *M. cf. ater*.

***Trachylepis boulengeri* (Sternfeld, 1911)**

**Material.** Mt. M'páluwé (PEM R21225, male, 75.4 mm SVL). **Comments:** Only one specimen was collected in dry bamboo leaves from the eastern slopes of Mt. M'páluwé. This species is known from only a handful of records from northern Mozambique, e.g. Niassa (Branch et al. 2005), and Marrupula (Blake 1965, Broadley 1974).

***Trachylepis maculilabris* (Gray, 1845)**

**Material.** Mt. Mabu (PEM R21150, female, 88.6 mm SVL). **Comments:** One adult female was collected from a transition woodland. Branch et al. (2005) were the first to record this species from northern Mozambique and indicate, based on material used from coastal northern Mozambique (Carranza et al. 2001) towards the presence of a cryptic species in the north of Mozambique. Our record is the first for Mt. Mabu and fills a large gap between the northern (Lipumbulo floodplain) and the Zambezi Valley records. Records from north of the Zambezi remains scattered to only a handful of records, e.g. Lipumbulo floodplain, Moebase, and Moma (Branch et al. 2005).

***Trachylepis margaritifera* (Peters, 1854)**

**Material.** Mt. M'páluwé (PEM R21226, female, 97.1 mm SVL; PEM R21227, female, 101.7 mm SVL). **Comments:** Two adult females were collected from the Oasis Water Camp running among outbuildings and on rocky slopes. Broadley and Bauer (1998) recorded this species from a handful of records from the northern Mozambique, presumably based on records collected by Blake (1965). Our record from Mt. M'páluwé just fills in the gap between Blake's (1965) Morrumbala and Nampula

records. Portik et al. (2013a) also recorded this species from Lichinga further north and Branch et al. (2005) recorded them from Niassa Game Reserve.

***Trachylepis striata* (Peters, 1844)**

**Material.** Mt. Namuli (PEM R21172, male, 71.1 mm SVL; PEM R21173, male, 67.7 mm SVL). **Comments:** Specimen was collected from the lower slopes of Mt. Namuli running on granite rocky outcrops. Common and widespread species in southern Africa, but only recorded from Niassa (Branch et al. 2005), Namuli and Lichinga (Portik et al. 2013a), Mossuril and Mozambique Island (Blake 1965) in northern Mozambique.

***Trachylepis varia* (Peters, 1867)**

**Material.** Mt. Mabu (PEM R21151, male, 58.6 mm SVL), Mt. Namuli (PEM R21179, female, 52.7 mm SVL; PEM R21180, female, 51.1 mm SVL; PEM R21181, female, 59.4 mm SVL; PEM R21182, female, 60.7 mm SVL; PEM R21183, male, 49.3 mm SVL; PEM R21185, male, 53.8 mm SVL), Mt. M'páluwé (PEM R21198, male, 57.6 mm SVL). **Comments:** Specimens from Mts. Mabu and M'páluwé represent the plain tan brown dorsum coloration with dark-edged white lateral line and uniform beige ventrum, while the montane grassland population of the Murteha Plateau of Mt. Namuli have the dorsum greenish with five finely striped white lines, and ventrally a bluish darker colouration. Broadley (2000) also refers to the fact that montane populations differs in size, scalation, and colour. Further taxonomical work is needed to resolve the status of these montane populations.

**Colubridae**

***Dispholidus typus* (Smith, 1828)**

**Material.** Mt. M'páluwé (PEM R21214, a juvenile female, 518 mm SVL + 20 mm TL). **Comments:** Juvenile dislodged by a Southern Shrike (*Lanius* sp.) from the branches of a mango tree at the Oasis Water Camp. This specimen can be assigned to the northern race *D. typus viridis* (Smith, 1828).

***Dipsadoboa cf. shrevei shrevei* (Loveridge, 1932)**

**Material.** Mt. Mabu (PEM R21115, juvenile 312 mm SVL + 91 mm TL; PEM R21116, juvenile, 271 mm SVL + 77 mm SVL; PEM R21122, male, 802 mm SVL + 255 mm TL; PEM R21123, male, 681 mm SVL + 243 mm TL), Mt. M'páluwé (PEM R21195, juvenile, 381 mm SVL + 106 mm SVL). **Comments:** Specimens collected from forest floor or in low growing trees along streams (Fig. 4F). Except for Mt. M'páluwé specimen, which was

collected from low growing scrubs in the forest, far from any water. Based on the identification key provided by Spawls et al. (2002) the Mozambique species keys out as *D. shrevei shrevei*, from which it differs on ventral and subcaudal counts. First collected in 2008 (Timberlake et al. 2012, Bayliss et al. 2014) from Mt. Mabu.

***Philothamnus angolensis* Bocage, 1882**

**Material.** Mt. Namuli (PEM R21187, female, 641 mm SVL + 254 mm TL). **Comments:** One specimen collected from mid-elevation forested stream, swimming across the stream at the base of the two Namuli granite domes when disturbed.

***Philothamnus hoplogaster* (Günther, 1863)**

**Material.** Mt. Mabu (PEM R21154, female, 390 mm SVL 165 mm TL), Mt. M'páluwé (PEM R21219, male, 406 mm SVL + 188 TL). **Comments:** Specimen collected from Mt. Mabu has 10 black spots anterior on the dorsum, while the Mt. M'páluwé specimen has uniform lime-green colouration. The Mt. Mabu specimen was collected from an overhanging tree along a well vegetated low-elevation stream at night, while the Mt. M'páluwé was collected around a water tank at the Oasis Water Camp.

***Thelotornis mossambicanus* (Bocage, 1895)**

**Material.** Mt. Mabu (PEM R21142, juvenile, 312 SVL+163 mm TL; PEM R21149, male, 650 mm SVL + 400 mm TL), M'páluwé (PEM R21228, female, 706 mm SVL + 419 mm TL). **Comments:** At Mt. Mabu one specimen was collected from closed-canopy forest while the other was collected in transitional miombo woodland. A male and female specimen donated by a local presumably obtained from near Ribáuè town. The juvenile collected from closed-canopy forest had a juvenile *Rhampholeon maspictus* in its stomach.

**Elapidae**

***Naja mossambica* Peters, 1854**

**Material.** Mt. M'páluwé (PEM R21201, female, 715 mm SVL + 146 mm TL). **Comments:** Collected at night on the lower slopes near the shambas.

**Lamprophiidae**

***Boaedon capensis* Duméril & Bibron, 1854**

**Material.** Mt. M'páluwé (PEM R21229, male 147 SVL + 98 mm TL). **Comments:** A female specimen donated by a local, presumably obtained from near Ribáuè town.

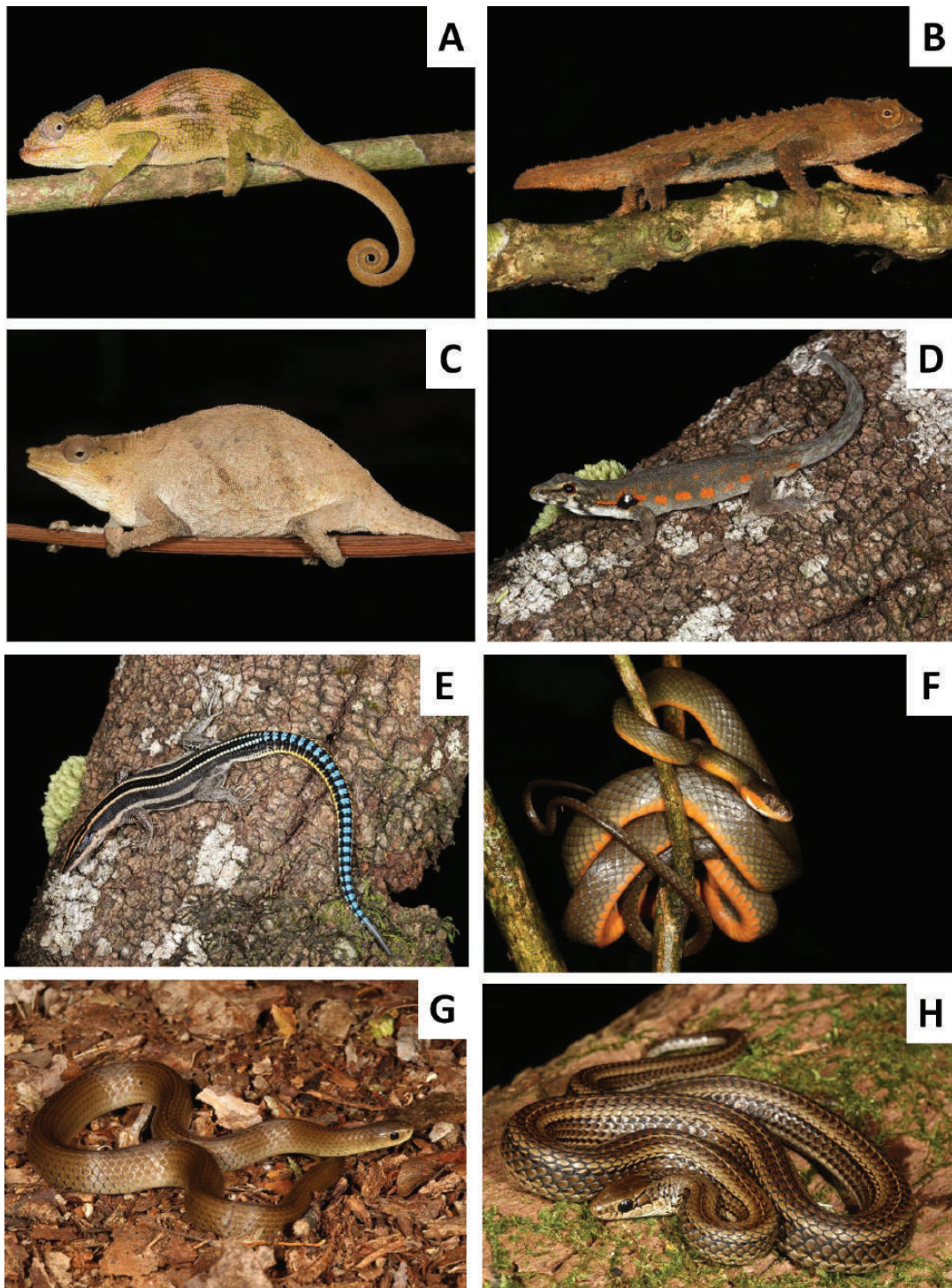

**Figure 4.** A selection of reptiles from northern Mozambique inselbergs. **A** – *Nadzikambia baylissi* (Mt. Namuli, PEM R21165), **B** – *Rhampholeon tilburyi* (Mt. Namuli, PEM R21157), **C** – *Rhampholeon* sp. (Mt. M'páluwé, PEM R21209), **D** – *Lygodactylus* cf. *rex* (Mt. Mabu, PEM R21147), **E** – *Holaspis laevis* (Mt. Mabu, PEM R21146), **F** – *Dipsadoboa* cf. *shrevei shrevei* (Mt. Mabu, PEM R21123), **G** – *Duberria shirana* (Mt. Namuli, PEM R21184), **H**– *Psammophylax variabilis* (Mt. Namuli, PEM R21186).



We follow Portik et al. (2013a) and refer to this specimen as *capensis*, rather than *fuliginosus*, based on general colouration.

#### *Duberria shirana* (Boulenger, 1894)

**Material.** Mt. Namuli (PEM R21184, male, 193 mm SVL + 49 mm TL). **Comments:** Collected in a funnel trap situated in montane grassland of the Muretha Plateau (Fig. 4G). This represents the first known record of this species for the whole of Mozambique.

#### *Gonionotophis capensis* (Smith, 1847)

**Material.** Mt. Mabu (PEM R21152, male, 965 mm SVL + 160 mm TL; PEM R21153, female, 993 mm SVL + 143 mm TL). **Comments:** Two specimens were collected on the same night (15 November 2014) from the same locality near a stream at the base of Mt. Mabu. It is possible that the male was following the female, as they were collected minutes apart.

#### *Psammophis orientalis* Broadley, 1977

**Material.** Mt. M'páluwé (PEM R21197, female, 475 mm SVL + 243 mm TL). **Comments:** One specimen collected at night, one meter from the ground in a low growing shrub in transitional miombo.

#### *Psammophylax variabilis* Günther, 1893

**Material.** Mt. Namuli (PEM R21186, female, 329 mm SVL + 77 mm TL). **Comments:** Collected in montane grassland on the Muretha Plateau (Fig. 4H). This represents only the third record of this species for the whole of Mozambique (Timberlake et al. 2009; Farooq and Conradie 2015).

#### Viperidae

##### *Bitis arietans* Merren, 1820

**Material.** Mt. M'páluwé (PEM R21212, female, 573 mm SVL + 51 mm TL). **Comments:** One specimen collected at night on the path near the shambas.

## Conclusions

We have found eight putative new species through field identification, added additional species known from northern inselbergs (13 species to Mt. Mabu, five species to Mt. Namuli, and 19 species to Mt. M'páluwé), and one new

country record. Additional analyses are necessary, including barcoding and phylogenetic analyses, to determine whether these mountains are exceptionally high in species richness. We now know there are at least 30–40 species of reptiles and amphibians on each of these sky islands, many of which are montane endemics. Although the state of knowledge is growing for Mt. Mabu and Mt. Namuli and can be considered to be relatively well sampled, it is clear that Mt. Ribáuè isolates requires more work given the brevity of our survey. In addition, several other sky islands in the area have received little or no attention in terms of the herpetofaunal survey (e.g. Mt. Inago and Mt. Chiperone).

The present collection is essentially a preliminary assessment of amphibian and reptile diversity in the region and does not account for seasonal variation in activity of herpetofauna. Future surveys that are more comprehensive in space and over time should considerably increase our understanding of the regional diversity, endemism, and richness of these inselbergs. Although the state of biodiversity knowledge has grown for Mts. Mabu and Namuli, there is an urgent need for a clear understanding of the nature of threats, and mitigation measures that will directly improve protection of habitat. At Mt. Ribáuè additional surveys are imperative, given the comparatively limited exploration on that mountain coupled with the apparent high rate of forest clearing. Overall, the sky islands of Mozambique clearly require additional surveys to quantify species richness and endemism for a broad range of taxonomic groups. Ultimately, a better understanding of the threats to biodiversity will allow for prioritisation of conservation interventions.

## Acknowledgments

We thank the Natural History Museum of Maputo who endorsed and provided permits to carry out this work, National Geographic Society Committee for Research and Exploration (CRE 9281-13), the South African National Biodiversity Institute, and the National Research Foundation of South Africa (Grant #92776) for providing funding and logistical support for the 2014 survey, and Khangela Safaris for camp logistics in 2014. We also thank Bill Branch and Harith Farooq for their support for this survey, and the Swiss-African Kick-Start Funding, the Freiwillige Akademische Gesellschaft and the University of Basel for funding contributions to SPL and GBBS. We thank the two reviewers and editor whose comments improved the quality of this paper.

## References

- Bayliss J (2008) Danger and discoveries in northern Mozambique. *Lep-soc News Africa* 4(2008): 3–6.
- Bayliss J, Monteiro J, Fishpool L, Congdon C, Bampton I, Bruessow C, Matimele H, Banze A, Timberlake J (2010) Biodiversity and

- Conservation of Mount Inago, Mozambique. Report produced under Darwin Initiative Award 15/036. Royal Botanic Gardens, Kew, London, UK, 32 pp. Available from: [http://www.kew.org/sites/default/files/Inago%20report%20Nov%202010\\_low.pdf](http://www.kew.org/sites/default/files/Inago%20report%20Nov%202010_low.pdf) [accessed 22 August 2016]
- Bayliss J, Timberlake J, Branch WR, Bruessow C, Collins S, Congdon C, Curran M, De Sousa C, Dowsett R, Dowsett-Lemaire F, Fishpool L, Harris T, Herrmann E, Georgiadis S, Kopp M, Liggitt B, Monadjem A, Patel H, Ribeiro D, Spottiswoode C, Taylor P, Willcock S, Smith P (2014) The discovery, biodiversity and conservation of Mabu forest—the largest mid-elevation rainforest in southern Africa. *Oryx* 48: 177–185. doi: 10.1017/S0030605313000720
- Bittencourt-Silva G, Conradie W, Siu-Ting K, Tolley KA, Channing A, Cunningham M, Farooq HM, Menegon M, Loader SP (2016) The phylogenetic position and diversity of the enigmatic mongrel frog *Nothophryne* Poynton, 1963 (Amphibia, Anura). *Molecular Phylogenies and Evolution* 99: 89–102. doi: 10.1016/j.ympev.2016.03.021
- Blake DK (1965) The fourth Umtali Museum expedition to Mozambique: November–December 1964. *The Journal of the Herpetological Association of Rhodesia* 23: 31–46. doi: 10.1080/0440730X.1965.9650549
- Branch WR (1998) Field guide to the snakes and other reptiles of Southern Africa. Struik Publishers, Cape Town, 399 pp.
- Branch WR (2000) Survey of the reptiles and amphibians of the Zambezi Delta. In: Timberlake JR (Ed.) *Biodiversity of the Zambezi Basin Wetlands*, Consultancy report for IUCN ROSA. Biodiversity Foundation of Africa, Bulawayo/The Zambezi Society, Harare, 377–392.
- Branch WR (2004) Herpetological survey of the Niassa Game Reserve. Technical report prepared for Sociedade para a Gestão e Desenvolvimento da Reserva do Niassa Moçambique, 59 pp.
- Branch WR, Bayliss J (2009) A new species of *Atheris* (Serpentes: Viperidae) from northern Mozambique. *Zootaxa* 2113: 41–54. doi: 10.11646/zootaxa.3710.5.2
- Branch WR, Bayliss J, Tolley KA (2014) Pygmy chameleons of the *Rhampholeon platyceps* complex (Squamata: Chamaeleonidae): Description of four new species from isolated ‘sky islands’ of northern Mozambique. *Zootaxa* 3814: 1–36. doi: 10.11646/zootaxa.3814.1.1
- Branch WR, Cunningham M (2006) Herpetological survey of Mount Mulanje, Malawi. Report for Mount Mulanje Conservation Trust, Blantyre, Malawi, 74 pp.
- Branch WR, Rödel M-O, Marais J (2005a) Herpetological survey of the Niassa Game Reserve, northern Mozambique – Part I: Reptiles. *Salamandra* 41: 195–214.
- Branch WR, Rödel M-O, Marais J (2005b) A new species of rupicolous *Cordylus* Laurenti 1768 (Sauria: Cordylidae) from Northern Mozambique. *African Journal of Herpetology* 54: 131–138. doi: 10.1080/21564574.2005.9635526
- Branch WR, Ryan PG (2000) Additions to the Mozambique Herpetofauna: Two new lizards from the Namuli Massif, Mozambique. *Herpetological Review* 32: 281–282.
- Branch WR, Tolley KA (2010) A new species of chameleon (Sauria: Chamaeleonidae: *Nadzikambia*) from Mount Mabu, central Mozambique. *African Journal of Herpetology* 59: 157–172. doi: 10.1080/21564574.2010.516275
- Broadley DG (1965a) A new chameleon from Malawi. *Arnoldia* 32: 1–3.
- Broadley DG (1965b) A new species of *Platysaurus* from northern Mozambique. *Arnoldia* 33: 1–4.
- Broadley DG (1974) A review of the *Mabuya maculilabris* group in southeastern Africa (Sauria: Scincidae). *Arnoldia* 6: 1–15.
- Broadley DG (1990) FitzSimons’ Snakes of Southern Africa (Revised Edition). 84 colour pl. + Addendum. Jonathan Ball and Ad. Donker, Parklands, 387 pp.
- Broadley DG (1995) Geographical Distribution. Sauria: Cordylidae: *Platysaurus maculatus maculatus* Broadley, 1965. *African Herp News* 22: 52–53.
- Broadley DG (2000) A review of the genus *Mabuya* in southeastern Africa (Sauria: Scincidae). *African Journal of Herpetology* 49: 87–110. doi: 10.1080/21564574.2000.9635437
- Broadley DG, Bauer AM (1998) A review of the *Mabuya quinqueteniata* complex in East Africa (Sauria: Scincidae). *African Journal of Herpetology* 47: 43–58. doi: 10.1080/21564574.1998.9650002
- Broadley DG, Whiting SA, Bauer AM (2006) A revision of East Africa species of *Melanoseps* Boulenger (Sauria: Scincidae: Feylininae). *African Journal of Herpetology* 55: 95–112. doi: 10.1080/21564574.2006.9635543
- Carranza S, Arnold EN, Mateo JA, Lopez-Jurado LF (2001) Parallel gigantism and complex colonisation patterns in the Cape Verde scincid lizards *Mabuya* and *Macroscincus* (Reptilia: Scincidae) revealed by mitochondrial DNA sequences. *Proceedings of the Royal Society of London* 268: 1595–1603. doi: 10.1098/rspb.2001.1699
- Channing A (2001) *Amphibians of Central and Southern Africa*. Cornell University Press, Ithaca, New York, 470 pp.
- Channing A, Baptista N (2013) *Amietia angolensis* and *A. fuscigula* (Anura: Pyxicephalidae) in southern Africa: A cold case reheated. *Zootaxa* 3640: 501–520. doi: 10.11646/zootaxa.3640.4.1
- Channing A, Dehling JM, Lötters S, Ernst R (2016) Species boundaries and taxonomy of the African river frogs (Amphibia: Pyxicephalidae: *Amietia*). *Zootaxa* 4155(1): 001–076. doi: 10.11646/zootaxa.4155.1.1
- Channing A, Davenport TRB (2002) A new stream frog from Tanzania (Anura: Ranidae: *Strongylopus*). *African Journal of Herpetology* 51: 135–142. doi: 10.1080/21564574.2002.9635469
- Channing A, Howell KM (2006) *Amphibians of East Africa*. Cornell University Press, New York, 418 pp.
- Clarke BT, Poynton C (2005) A new species of stream frog, *Strongylopus* (Anura: Ranidae) from Mount Kilimanjaro, Tanzania, with comments on a ‘northern volcanic mountains group’ within the genus. *African Journal of Herpetology* 54: 53–60. doi: 10.1080/21564574.2005.9635517
- Congdon TCE, Bayliss JL (2012) Butterflies of Mt Mecula and Mt Yao, Niassa Province, Northern Mozambique. *Metamorphosis* 23: 26–34.
- Congdon TCE, Collins S, Bayliss J (2010) Butterflies of south east Africa’s mountains (Mozambique and Malawi). *Metamorphosis* 21(2): 45–107.
- Conroy CJ, Papenfuss T, Parker J, Hahn NE (2009) Use of Tricaine Methanesulfonate (MS222) for euthanasia of reptiles. *Journal of the American Association for Laboratory Animal Science* 48: 28–32.
- Cott HN (1934) The Zoological Society’s expedition to the Zambesi, 1927: No.5. On a collection of lizards, mainly from Portuguese East Africa, with description of new species of *Zonurus*, *Monopeltis* and *Chirindia*. *Proceedings of the Zoological Society of London* 1934: 145–173. doi: 10.1111/j.1469-7998.1934.tb06228.x
- Daniels SR, Bayliss J (2012) Neglected refugia of biodiversity: mountainous regions in Mozambique and Malawi yield two novel fresh-

- water crab species (Potamonautidae: *Potamonautes*). Zoological Journal of the Linnean Society 164: 498–509. doi: 10.1111/j.1096-3642.2011.00773.x
- Daniels S, Phiri E, Bayliss J (2014) Renewed sampling of inland aquatic habitats in southern Africa yields two novel freshwater crab species (Decapoda: Potamonautidae: *Potamonautes*). Zoological Journal of the Linnean Society 171: 356–369. doi: 10.1111/zoj.12139
- Du Preez LH, Carruthers VC (2009) A Complete Guide to the Frogs of Southern Africa. Struik Nature, Cape Town. doi: 10.1111/j.1096-3642.2011.00773.x
- Farooq HOM, Conradie W (2015) A second record of *Scolecophorus kirkii* Boulenger, 1883 (Gymnophiona: Scolecophoridae) for Mozambique. Herpetology Notes 8: 59–62.
- Farooq H, Liedtke HC, Bittencourt-Silva G, Conradie W, Loader S (2015) The distribution of *Mertensophryne anotis* with a new record in Northern Mozambique. Herpetology Notes 8: 305–307.
- Frost DR (2016) Amphibian Species of the World: an Online Reference, Version 6.0. American Museum of Natural History, New York. Available from: <http://research.amnh.org/herpetology/amphibia/index.html> [accessed 1 April 2016]
- Furman BJS, Bewick AJ, Harrison TL, Greenbaum E, Gvoždík V, Kusamba C, Evans BJ (2015) Pan-African phylogeography of a model organism, the African clawed frog '*Xenopus laevis*'. Molecular Ecology 24: 909–925. doi: 10.1111/mec.13076
- Larson TR, Catros D, Behangana M, Greenbaum E (2016) Evolutionary history of the river frog genus *Amietia* (Anura: Pyxicephalidae) reveals extensive diversification in Central African highlands. Molecular Phylogenetics and Evolution 99: 168–181. doi: 10.1016/j.ympev.2016.03.017
- Marais J (2004) A complete guide to the snakes of Southern Africa. Struik, Cape Town, 312 pp.
- Mazibuko L, Poynton J (2004) *Nothophryne broadleyi*. The IUCN Red List of Threatened Species 2004: e.T58077A11714410. doi: 10.2305/IUCN.UK.2004.RLTS.T58077A11714410.en
- McSweeney C, New M, Lizcano G (2010a) UNDP climate change country profiles: Mozambique. <http://country-profiles.geog.ox.ac.uk/> [accessed 15 May 2016]
- McSweeney C, New M, Lizcano G, Lu X (2010b) The UNDP climate change country profiles improving the accessibility of observed and projected climate information for studies of climate change in developing countries. Bulletin of the American Meteorological Society 91: 157–166. doi: 10.1175/2009BAMS2826.1
- Mercurio V (2011) Amphibians of Malawi, an analysis of their richness and community diversity in a changing landscape. Edition Chimaira, Frankfurt/M.
- Monadjem A, Schoeman MC, Reside A, Pio DV, Stoffberg S, Bayliss J, Cotterill FPD, Curran M, Kopp M, Taylor PJ (2010) A recent inventory of the bats of Mozambique with documentation of seven new species for the country. Acta Chiropterologica 12(2): 371–391. doi: 10.3161/150811010X537963
- Nussbaum RA (1985) Systematics of caecilians (Amphibia: Gymnophiona) of the family Scolecophoridae. Occasional Papers of the Museum Zoology, University of Michigan 713: 1–49.
- Ohler A, Frétey T (2014) Going back to Rovuma: the frog fauna of a coastal dry forest, and a checklist of the amphibians of Mozambique. Journal of East African Natural History 103: 73–124. doi: 10.2982/028.103.0203
- Pascal O (2011) The coastal forests of northern Mozambique, 2008–2009 expeditions. Our Planet Reviewed. Programme report n°1. Pro-Natura international / Muséum national d'Histoire naturelle, Paris. [http://www.laplaneterevisitee.org/ressources/pdfs/Rapport\\_de\\_Mission\\_Mozambique\\_23.pdf](http://www.laplaneterevisitee.org/ressources/pdfs/Rapport_de_Mission_Mozambique_23.pdf) [accessed 20 July 2016]
- Pickersgill M (2007) Frog search. Results of expeditions to Southern and Eastern Africa from 1993–1999. Frankfurt Contributions to Natural History Volume 28. Edition Chimaira, Frankfurt am Main.
- Portik DM, Mulungu EA, Sequeira D, McEntee JP (2013a) Herpetological surveys of the Serra Jeci and Namuli massifs, Mozambique, and an annotated checklist of the southern Afromontane archipelago. Herpetological Review 44: 394–406.
- Portik DM, Travers SL, Bauer AM, Branch WR (2013b) A new species of *Lygodactylus* (Squamata: Gekkonidae) endemic to Mount Namuli, an isolated 'sky island' of northern Mozambique. Zootaxa 3710: 415–435. doi: 10.11646/zootaxa.3710.5.2
- Poynton JC (1963) Descriptions of southern African amphibians. Annals of the Natal Museum 15: 319–332.
- Poynton JC (1966) Amphibia of northern Mozambique. Memoirs de Instituto de Investigação Científica de Moçambique Ser. A. Ciências B 8: 13–34.
- Poynton JC (2004) Stream frogs in Tanzania (Ranidae: *Strongylopus*): The case of *S. merumontanus* and *S. fuelleborni*. African Journal of Herpetology 53: 29–34. doi: 10.1080/21564574.2004.9635496
- Poynton JC, Broadley DG (1985) Amphibia Zambeziaca 2. Ranidae. Annals of the Natal Museum 27: 115–181.
- Poynton JC, Broadley DG (1987) Amphibia Zambeziaca 3. Rhacophoridae and Hyperoliidae. Annals of the Natal Museum 28: 161–229.
- Poynton JC, Broadley DG (1991) Amphibia Zambeziaca 5. Zoogeography. Annals of the Natal Museum 32: 221–277.
- Ryan PG, Bento C, Cohen C, Graham J, Parker V, Spottiswoode C (1999) The avifauna and conservation status of the Namuli Massif, northern Mozambique. Bird Conservation International 9: 315–331. doi: 10.1017/S0959270900003518
- Schiötz A (1999) Treefrogs of Africa. Edition Chimaira, Frankfurt am Main, 350 pp.
- Spawls S, Howell K, Drewes R, Ashe J (2002) A Field Guide to the Reptiles of East Africa. Academic Press, London, 543 pp.
- Spottiswoode CN, Patel IH, Herrmann E, Timberlake J, Bayliss J (2008) Threatened bird species on two little-known mountains (Chiperone and Mabu) in northern Mozambique. Ostrich 79(1): 1–7. doi: 10.2989/OSTRICH.2008.79.1.1.359
- Taylor PJ, Richards LR, Bayliss J, Cotterill FPD (2015) Rediscovery of the Transvaal free-tailed bat (*Tadarida ventralis africana*) in South Africa, with an additional record of the Malagasy free-tailed bat (*T. fulminans*) from Northern Mozambique. Durban Natural Science Museum Novitates 38: 50–55.
- Taylor PJ, Stoffberg S, Monadjem A, Schoeman MC, Bayliss J, Cotterill FPD (2012) Four new bat species (*Rhinolophus hildebrandtii* complex) reflect Plio-Pleistocene divergence of dwarfs and giants across an afromontane archipelago. PLoS ONE 7: e41744. doi: 10.1371/journal.pone.0041744
- Timberlake J, Bayliss J, Alves T, Baena S, Francisco J, Harris T, da Sousa C (2007) Biodiversity and Conservation of Mount Chiperone, Mozambique. Technical Report: Darwin Initiative Award 15/036: Monitoring and Managing Biodiversity Loss in South-East Africa's Montane Ecosystems. Available from: [http://www.kew.org/sites/default/files/kppcont\\_046092\\_0.pdf](http://www.kew.org/sites/default/files/kppcont_046092_0.pdf) [accessed 20 July 2016]
- Timberlake J, Dowsett-Lemaire F, Bayliss J, Alves T, Baena S, Bento C, Cook K, Francisco J, Harris T, Smith P, de Sousa C (2009) Mt.

- Namuli. Mozambique: Biodiversity and Conservation. Technical Report: Darwin Initiative Award 15/036: Monitoring and Managing Biodiversity Loss in South-East Africa's Montane Ecosystems. [http://www.kew.org/science/directory/projects/annex/Namuli\\_report\\_FINAL.pdf](http://www.kew.org/science/directory/projects/annex/Namuli_report_FINAL.pdf) [accessed 20 July 2016]
- Timberlake JR, Bayliss J, Dowsett-Lemaire F, Conghan C, Branch WR, Collins S, Curran M, Dowsett RJ, Fishpool L, Francisco J, Harris T, Kopp M, de Sousa C (2012) Mt. Mabu, Mozambique: Biodiversity and Conservation. Report produced under the Darwin Initiative Award 15/036. Royal Botanic Gardens, Kew, London. [http://www.kew.org/sites/default/files/kppcont\\_067897.pdf](http://www.kew.org/sites/default/files/kppcont_067897.pdf) [accessed on 26 January 2015]
- Travers SL, Jackman TR, Bauer AM (2014) A molecular phylogeny of Afromontane dwarf geckos (*Lygodactylus*) reveals a single radiation and increased species diversity in a South African montane center of endemism. *Molecular Phylogenetics and Evolution* 80: 31–42. doi: 10.1016/j.ympev.2014.07.017
- Tolley KA, Alexander GJ, Branch WR, Bowles P, Maritz B (2016) Conservation status and threats for African reptiles. *Biological Conservation*, In Press. doi: 10.1016/j.biocon.2016.04.006
- Uetz P, Hošek J (Eds) (2016) The Reptile Database. <http://www.reptile-database.org> [accessed on 17 April 2016]
- White F (1983) The Vegetation of Africa. A Descriptive Memoir to Accompany the Unesco/AETFAT/UNSO Vegetation Map of Africa. UNESCO, Paris.
-

# CURRICULUM VITAE

## Gabriela Bueno Bittencourt-Silva

### Personal data

**Born:** 05/09/1982, Niterói, RJ, Brazil

**Home:** Reservoirstrasse 201, CH-4059 Basel, Switzerland

**Work:** University of Basel, Department of Environmental Sciences. Klingelbergstrasse 27, CH-4056 Basel, Switzerland

**Contact:** gabriela.bittencourt@unibas.ch / gabrielabitt.ufrrj@gmail.com

**Languages:** English, Portuguese, Spanish

---

### Formal Education/Degree

09/2013 – present: PhD “Lacuna Mozambique: Adding An Important Piece To The African Jigsaw Puzzle”. University of Basel, Switzerland. Advisor: Dr. Simon P. Loader.

03/2009 – 04/2011: Master’s degree in Animal Biology. Universidade Federal Rural do Rio de Janeiro, UFRRJ, Brazil. Advisor: Dr. Hélio Ricardo da Silva.

09/2001 – 09/2006: Bachelor’s degree in Animal Biology. Universidade Federal Rural do Rio de Janeiro, UFRRJ, Brazil. Advisor: Dr. Hélio Ricardo da Silva.

09/2001 – 09/2005: Licenciante’s degree in Biological Sciences. Universidade Federal Rural do Rio de Janeiro, UFRRJ, Brazil.

---

### Editorial Duties and Society Fellows

**Reviewer/Referee:** *Herpetological Journal*, *Salamandra*

**Fellow:** Swiss Zoological Society, The Systematics Association

---

### Fellowships, Grants, and Awards

1. CAPES (Coordenação de Aperfeiçoamento de Pessoal de Nivel Superior) Fellowship, Universidade Federal Rural do Rio de Janeiro, Brazil, 2009-2011

2. ESKAS (Swiss Government Excellence Scholarships for Foreign Scholars) Fellowship, University of Basel, Switzerland, 2013-2016
  3. FAG (Freiwillige Akademische Gesellschaft Basel), 2013 - CHF 3.800
  4. Young Systematist's Forum Award for best poster (3<sup>rd</sup> place), 2015
  5. FAG (Freiwillige Akademische Gesellschaft Basel), 2016 - CHF 12.000
- 

## Academic training and workshops attended during PhD

2014 – Workshop: Ecological Niche Modelling, 27<sup>th</sup>-30<sup>th</sup> January, Azores, Portugal.

2014 – Poster presentation: African Amphibian Working Group (AAWG), 28<sup>th</sup>-30<sup>th</sup> May, Bwindi, Uganda.

2014 – PhD Course: “Modelling species distributions under climate change”, University of Copenhagen, 25<sup>th</sup>-29<sup>th</sup> August, Copenhagen, Denmark.

2015 – Poster presentation: International Biogeography Society meeting, 08<sup>th</sup>-12<sup>th</sup> January, Bayreuth, Germany.

2015 – Oral presentation: German Biogeography Working Group (Arbeitskreis Biogeographie), 7<sup>th</sup>-9<sup>th</sup> May, Basel, Switzerland.

2015 – Poster presentation: Young Systematist's Forum, 20<sup>th</sup> November, London, UK.

2016 – Practical Course: “Phylogenetics in the ‘-omics’ era”, EMBO, 10<sup>th</sup>-17<sup>th</sup> January, Iquitos, Peru.

2016 – Oral presentation: Naturhistorisches Museum Bern Journal Club Systematics, 18<sup>th</sup> April, Bern, Switzerland.

---

## Publication List

1. Barratt, C.D., Lawson, L.P., **Bittencourt-Silva, G.B.**, Dognart, N., Morgan-Brown, T., Nagel, P. and Loader, S.P. (2017). A new, narrowly distributed, and critically endangered species of spiny-throated reed frog (Anura: Hyperoliidae) from a highly threatened coastal forest reserve in Tanzania. *Herpetological Journal*, (26) pp.13-24.

2. Conradie, W., **Bittencourt-Silva, G.**, Engelbrecht, H.M., Loader, S.P., Menegon, M., Nanvonamuquitxo, C., Scott, M. and Tolley, K.A., **(2016)**. Exploration into the hidden world of Mozambique's sky island forests: new discoveries of reptiles and amphibians. *Zoosystematics and Evolution*, 92, p.163.
3. **Bittencourt-Silva, G.B.**, Conradie, W., Siu-Ting, K., Tolley, K.A., Channing, A., Cunningham, M., Farooq, H.M., Menegon, M., Loader, S.P. **(2016)**. The phylogenetic position and diversity of the enigmatic mongrel frog *Nothophryne* Poynton, 1963 (Amphibia, Anura). *Molecular Phylogenetics and Evolution* (in press). DOI:10.1016/j.ympev.2016.03.021.
4. Conradie, W., **Bittencourt-Silva, G.B.**, Loader, S.P., Menegon, M., Nanvonamuquitxo, C., Kotzé, A., Dalton, D.L., Engelbrecht, H.M. And Tolley, K.A., **(2016)**. *Batrachochytrium dendrobatidis* Survey of Amphibians in the Northern Mozambique "Sky Islands" and Low-lying Areas. *Herpetological Review*, 47(1), p. 42-46.
5. Rendle, M.E., Tapley, B., Perkins, M., **Bittencourt-Silva, G.**, Gower, D.J. and Wilkinson, M. **(2015)**. Itraconazole treatment of *Batrachochytrium dendrobatidis* (Bd) infection in captive caecilians (Amphibia: Gymnophiona) and the first case of Bd in a wild neotropical caecilian. *Journal of Zoo and Aquarium Research*, 3(4): 137-140.
6. Chambouvet, A., Gower, D.J., Jirků, M., Yabsley, M.J., Davis, A.K., Leonard, G., Maguire, F., Doherty-Bone, T.M., **Bittencourt-Silva, G.B.**, Wilkinson, M., Richards, T.A. **(2015)**. Cryptic infection of a broad taxonomic and geographic diversity of tadpoles by Perkinsea protists. *Proceedings of the National Academy of Sciences*, 112(34), E4743-E4751.
7. Farooq, H., Liedtke, H.C., **Bittencourt-Silva, G.**, Conradie, W., Loader, S.P. **(2015)**. The distribution of *Mertensophryne* cf. *anotis* with a new record in Northern Mozambique. *Herpetology Notes* 8: 305-307.
8. **Bittencourt-Silva, G.B.** **(2014)**. Notes on the reproductive behaviour of *Amietophrynus lemairii* (Boulenger, 1901). *Herpetology Notes* (7) 611-614.
9. **Bittencourt-Silva, G.B.** & Silva, H.R. **(2014)**. Effects of fragmentation and sea-level changes upon frog communities of land-bridge islands off the southeastern coast of Brazil. *PLoS ONE* 9(7). DOI: 10.1371/journal.pone.0103522.
10. Moraes, F.; Amorim, G.; **Bittencourt-Silva, G.B.**; Silva, H.R.; Baptista, R.; Couri, M.; Passos, P. **(2013)**. Fauna terrestre do Monumento Natural das Ilhas Cagarras. In: Fernando Moraes;



Áthila Bertoncini; Aline Aguiar. (Org.). História, Pesquisa e Biodiversidade do Monumento Natural das Ilhas Cagarras. 1ª ed. Rio de Janeiro: v. , p. 163-205.

11. **Bittencourt-Silva, G.B.**, & Silva, H.R. (2013). Insular Anurans (Amphibia: Anura) of the coast of Rio de Janeiro, Southeast, Brazil. *Check List*, 9(2), 225-234. DOI: <http://dx.doi.org/10.15560/9.2.225>.
12. Silva, H.R., Carvalho, A.L.G., **Bittencourt-Silva, G.B.** (2011). Selecting a Hiding Place: Anuran Diversity and the use of Bromeliads in a Threatened Coastal Sand Dune Habitat in Brazil. *Biotropica*, (43): 218-227. DOI: 10.1111/j.1744-7429.2010.00656.x.
13. Silva, H.R.; Carvalho, A.L.G.; **Bittencourt-Silva, G.B.** (2011). Coastal sand-dune habitats, frog-bromeliad relationship and conservation in Rio de Janeiro, Brazil. *Froglog*, (97):53-54, 28 Jul.
14. Silva, H.R., Carvalho, A.L.G., **Bittencourt-Silva, G.B.** (2008). Frogs of Marambaia: A naturally isolated Restinga and Atlantic Forest remnant of southeastern Brazil. *Biota Neotropica*, (8): 167-174. DOI: 10.1590/S1676-06032008000400017.