

## DEVELOPMENT OF LONG PULSED Nd:YAG LASER SYSTEM

Muhamad Fakaruddin Sidi Ahmad, Noriah Bidin\*

Laser Center, IBNU SINA INSTITUTE for Scientific and Industrial Research (ISI-SIR), Universiti Teknologi Malaysia, 81310 UTM Johor Bahru, Johor, Malaysia

### Article history

Received

15 August 2015

Received in revised form

15 November 2015

Accepted

30 December 2015

\*Corresponding author  
noriah@utm.my

### Graphical abstract

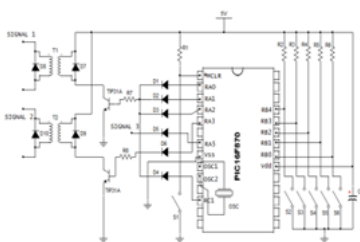

### Abstract

The Nd:YAG laser with long pulse duration can be produce by using an appropriate pumping scheme. The purpose of this study is to construct a high voltage power supply for laser system. In this attempt multiple-mesh pulse forming technique was performed to obtain electrical pump pulses with a more rectangular shape and long normal-mode laser pulses at constant power. The flashlamp driver was designed with variable input energy. The developed flashlamp driver composes of five major electronic circuits. There are comprised of signal controller device, simmer power supply (SPS), trigger pulse ignition circuit, capacitor charging power supply (CCPS) and multiple-mesh LC pulse forming network (MPFN). The construction of the flashlamp driver is started by designing a signal controller. The controller generated a small voltage to activate the electronic components such as silicon controlled rectified (SCR) and transistor. The ignition circuit was used to ignite xenon gases which responsible to form ionized spark streamer between the two electrodes of flashlamp. A Low dc current was induced by the simmer power supply to sustain the flashlamp in simmering mode. The capacitor charging power supply was used to supply electrical power to capacitor bank within specific time. Nd:YAG laser oscillator was aligned and pumping by the new developed flashlamp radiation. As a result Nd:YAG laser beam was generated having fundamental wavelength of 1064 nm and 650 microsecond of pulse duration with maximum output energy of 250 mJ.

Keyword: Long pulse laser, multiple-mesh discharge network, Nd:YAG laser

### Abstrak

Laser Nd:YAG yang mempunyai tempoh denyutan tinggi dapat dijana dengan teknik pengujaan tertentu. Matlamat kajian adalah untuk menghasilkan pembekal kuasa bervoltan tinggi untuk laser sistem. Dalam kajian ini, teknik rangkaian pembentuk denyut berganda telah dibina bagi menghasilkan bentuk denyut segi empat and laser berdenyutan panjang pada kuasa yang malar. Pemacu lampu kilat yang dihasilkan mempunyai lima litar elektronik utama iaitu litar pengawal isyarat, pembekal kuasa simmer, litar pencetus penyalaan, pembekal kuasa pengecas kapasitor dan litar pembentuk denyut berganda. Pembinaan pemacu lampu kilat dimulakan dengan menghasilkan litar pengawal isyarat. Litar ini menghasilkan isyarat bervoltan rendah bagi mengaktifkan beberapa komponen elektronik seperti silicon controlled rectified (CPS) dan transistor. Litar pencetus penyalaan digunakan untuk mencetus nyalaan bagi gas xenon dalam lampu kilat. Arus elektrik rendah dibekalkan kepada lampu kilat oleh pembekal kuasa simmer supaya lampu kilat berada dalam keadaan simmering mode. Pembekal kuasa pengecas kapasitor digunakan untuk membekal kuasa elektrik kepada capacitor pada tempoh tertentu. Sistem penjana laser Nd:YAG dibina dan radiasi sinaran dari pemacu lampu kilat telah digunakan untuk menguja Nd:YAG Kristal. Hasilnya, cahaya laser Nd:YAG yang mempunyai panjang gelombang 1064 nm,

tempoh denyutan selama 650 mikro saat dan berkuasa 250 mili Joule telah berjaya dijanakan.

*Kata kunci:* Long pulse laser, multiple-mesh discharge network, Nd:YAG laser

© 2016 Penerbit UTM Press. All rights reserved

## 1.0 INTRODUCTION

A single or multiple-mesh LC network are commonly employ as pulse forming network (PFN) for flashlamp power supply [1]. Pulse shaper is designed with combination of capacitor and inductor. The values of inductance ( $L$ ), capacitance ( $C$ ), and capacitor charging voltage ( $V$ ) are chosen to give a critically damped pulse of the desired duration and energy with a given flashlamp impedance ( $K_0$ ) [2-3].

The network stores the discharge energy and delivers it to the lamp in the desired current pulse shape. The input energy,  $E_0$  the pulse width  $t_p$ , and the lamp dimensions have been determined before the PFN is designed. Markiewicz & Emmett was first invented the model of a pulse discharge circuit using single mesh of PFN. The circuit composes of capacitor  $C$  as energy storage element which charge by DC voltage,  $V_0$ . the inductor,  $L$  acts as a discharge pulse shaper and flashlamp represent by a non-linear load,  $R$ . The discharging energy from  $C$  is controlled by switch,  $S$ . This switch could be a spark gap, thyatron, and a semiconductor switch such as thyristor, transistor, and IGBT [4]. The type of switches use were depended on the charging voltage,  $V_0$  and discharging [5].

A multiple-mesh network can be employed for generating pump pulses with a more rectangular and flat top electrical pulse shape. Commonly the configuration consists of two or more LC networks in series. Switching an open-ended charged transmission line into a resistor equal to its characteristic impedance yields a rectangular pulse across the resistor. The width of the pulse equals twice the propagation time of the line. This same technique can be applied to a lumped parameter line. The principal advantage of the lumped-parameter delay line as an energy-storage PFN is its nearly constant output over the length of the pulse. This property is especially useful in producing long normal-mode laser pulses of constant power [7].

## 2.0 METHODOLOGY

Construction of flashlamp driver and function of circuit is stated clearly. Figures and schematic diagram of circuits is present to visualize the real connection of the laser system. Generally, the research progress can be divided into three main phase which are development of flashlamp driver (FLD), development of laser oscillator and characterization of flashlamp driver and Nd:YAG

laser system. Figure 1 shows the overall block of the research.

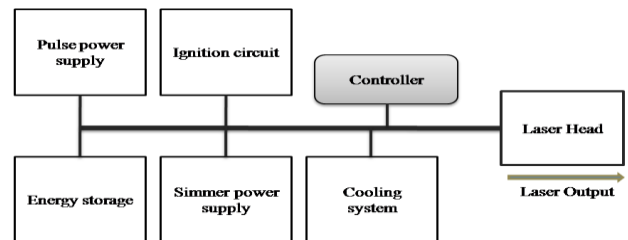

Figure 1 Block diagram of long pulse Nd:YAG laser

The controller for FLD is build to control three semiconductor switches in system (Figure 2). The controller supplies a typically low voltage of output signal which approximately 5 volts for the switches to be ON mode. If there are no voltage supplies to the switches, thus they are in OFF mode. Three different circuits employ semiconductor switch which is cooperated in the FLD operation. The semiconductor switches are silicon control rectifier (SCR) inside ignition circuit, SCR inside PFN, and also triac inside capacitor charging circuit. All the components in the circuit are listed in Table 1.

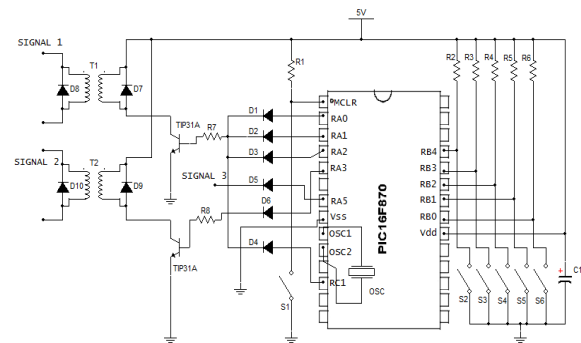
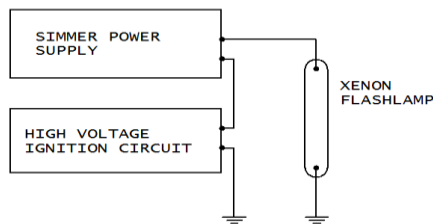

Figure 2 Signal control for FLD

**Table 1** List of electronic components for controller circuit

No	Symbol	Value /Part no.	Description
1	PIC 16F870	PIC16F870	Microcontroller
2	T1, T2	1:1 ratio	Pulse transformer
3	TIP31A	TIP31A	NPN transistor
4	C1	0.47 $\mu$ F	Decoupling capacitor
5	OSC	4 MHz	XT crystal oscillator
6	D1,D2,D3,D4,D5,D6	1000 V, 1 Amps (1N4007)	Forward-bias diode
7	R7,R8	150 Ohm	Base resistor
8	D7,D8,D9,D10	1000 V, 1 Amps (1N4007)	Free-wheeling diode
9	S1,S2,S3,S4,S5,S6	No	Push button switch
10	R1,R2,R3,R4,R5, R6	2 KOhm	Pull-up resistor

The ignition circuit and simmer power supply are important for flashlamp driver which operate using simmer mode triggering method (Figure 3). Ignition circuit will initiate the ionization of gases inside flashlamp and simmer power supply will provide a low dc current keep small steam across flashlamp. This technique will yield a better formation of arc during the main capacitor discharging process

**Figure 3** Block diagram of simmer power supply and ignition circuit

The ignition circuit is designed using series step-up transformer connection. This circuit is designed to produce a high voltage pulse with very short duration to ensure sufficient energy is provided to breakdown xenon gas inside flashlamp. Figure 4 shows a schematic diagram of ignition circuit that has been built and a dc simmer power supply is connected to flashlamp through secondary winding of step-up transformer. The ignition circuit is supplied with 350 volt dc power supply and ignition switch is controlled by an SCR thyristor. In this project, the ignition circuit consists of pull-up resistor, R2, small filter capacitor, C2, discharger capacitor, C1, SCR thyristor as a switch, and a step-up pulse transformer to amplify the high voltage pulse. Additional components are also provided such as free-wheeling diode to protect the SCR and current limiting resistor, R2 at SCR gate terminal. This transformer was built using a ferrite core

to ensure the high coupling efficiency between the input and the output at a very high frequency pulses. The winding ratio between primary and secondary is 1 to 30 turns which is capable to amplify the voltage up to 30 times.

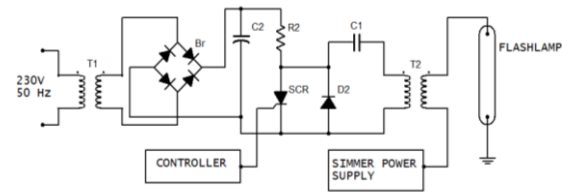
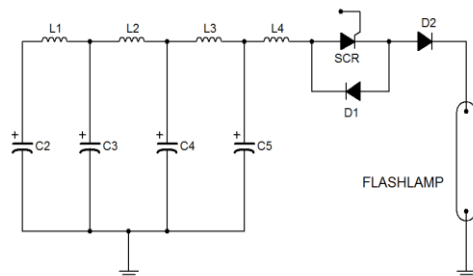
**Figure 4** Schematic diagrams for ignition circuit**Figure 5** Multiple-mesh pulse forming network (mPFN) circuit diagram

The flashlamp pulse shaper device in this work is designed using multiple-mesh pulse forming network (mPFN). Basically the mPFN composed of energy storage capacitor (C) as energy storage element, inductor (L) as pulse shaper, SCR as semiconductor switch, and xenon flashlamp as a load. In designing the mPFN, four mesh of LC network was built. Each mesh has same capacitance and inductance value. The mPFN is developed and is shown in Figure 5. In this circuit, a high voltage and high current silicon controller rectifier (SCR) thyristor are used as a switch to control discharging process from energy storage capacitor into the flashlamp. High power blocking diodes D2 are also required for this PFN to prevent the high voltage from the ignition circuit and also from the simmer power supply flow into PFN. While for SCR protection, freewheeling diode (D1) is connected between anode and cathode of SCR.

### 3.0 RESULTS AND DISCUSSION

Discharging waveform of pulse power supply which employs multiple mesh pulse forming network is measured by high voltage probe and oscilloscope. The pulse duration is 356.9  $\mu$ s corresponding to 250 volt of charging voltage. Figure 6 shows the waveform of discharging voltage through flashlamp.

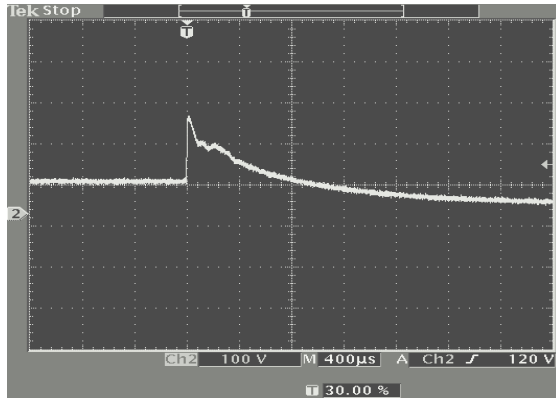

Figure 6 Voltage waveform of discharging process

The radiation emitted from Nd:YAG crystal once pumping with optical energy is observed. Figure 7 shows the spectrum of Nd:YAG crystal. Several new wavelengths are generated after pumping process. The emission beam comprised of 938.5, 946, 1061.1, 1061.5, 1063.87, 1071.30, and others which cannot be detected due to limitation of the spectrum analyzer. Although the major line seem to be 946 nm, but due to available mirror in the laser resonator only 1064 nm will be amplified and the rest will suppressed.

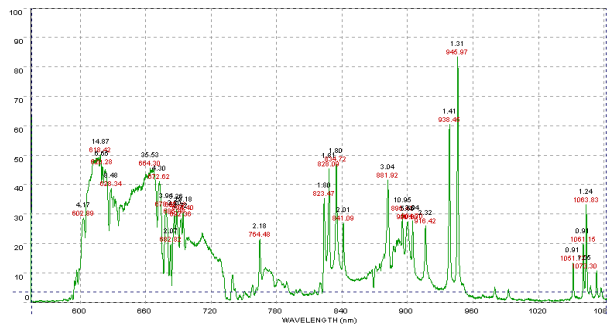

Figure 7 Emission spectrum of Nd:YAG

The developed laser oscillator was able to generate laser beam and it is detected by spectrum analyzer as shown in Figure 8. Spectrum shows a single wavelength radiation of Nd:YAG laser beam which have fundamental wavelength of 1064 nm.

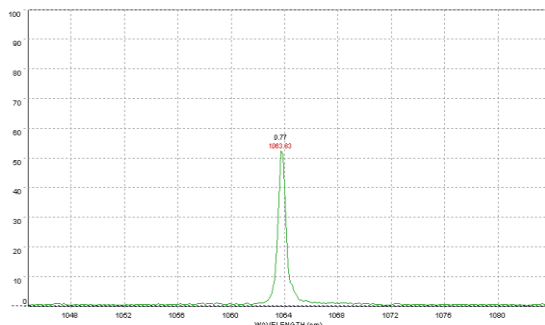

Figure 8 Spectrum of Nd:YAG laser

## 4.0 CONCLUSION

Flashlamp driver based on multiple-mesh technique of pulse forming networks (PFN) was successfully developed. A 600 volt simmer power supply was constructed and was used to maintain a low current across flashlamp. Ignition circuit which has 30 times of voltage amplifier was able to produce 10.5 kV pulse voltage. This high voltage will initiate the electric spark between two electrodes of xenon flashlamp. The developed pulse power supply was able to deliver electrical input energy up to 70 J. Charging power supply which has maximum charging voltage of 1000 V was constructed and used to energize the storage capacitor inside multiple pulse forming network. All power systems are controlled via a programmable controller. The controller produced 3 output signals. These triggering signals will be used to activate semiconductor switch such SCR and transistor. The operation setting of flashlamp driver is programmed in the microcontroller. Flashlamp driver was assembled with laser oscillator to form a complete pulse Nd:YAG laser system. Laser system was able to generate laser light with fundamental wavelength of 1064 nm. The Nd:YAG laser produced maximum power of 250 mJ with pulse duration of 650  $\mu$ s.

## Acknowledgement

This research is fully supported by FRGS grant, R.J130000.7809.4F543. The authors fully acknowledged Ministry of Higher Education (MOHE) and Universiti teknologi Malaysia for the approved fund which makes this important research viable and effective.

## References

- [1] Arya, R., Thomas, J. M., Bhujle, A. G. and Bhawalkar, D. D. 2000. Effect of Simmer Current on Flashlamp Impedance and Their Combined Influence on the Output of a Quasi-CW Nd:YAG Laser. *IEEE Journal of Quantum Electronics*. 36(7): 872-878.
- [2] Markiewicz, J. P. and Emmett, J.L. 1966. Design of Flashlamp Driving Circuits. *IEEE Journal of Quantum Electronics*. 2(11): 707-711.
- [3] Dishington, R. H. 1977. Flashlamp Drive Circuit Optimization For Laser. *Applied Optics*. 16(6): 1578-1583.
- [4] Brown, A. J. W., Fisher, C. H. 1993. A 6.5-J Flashlamp-Pumped Ti:Al<sub>2</sub>O<sub>3</sub> Laser. *IEEE Journal of Quantum Electronics*. 29(9): 2513-2517.
- [5] Marotta, A., Argüello, C. A. 1976. A Simmered Pre-Pulsed Flashlamp Dye Laser. *J. Phys. E: Sci. Instrum.* 9(6): 478-481.
- [6] Knight, R. C., Dewhurst, R. J., Ramsden, S. A. 1980. Efficient Burst-Mode Operation Of A Very High Repetition-Rate Nd:YAG Laser. *J. Phys. E: Sci. Instrum.* 13: 1339-1342.
- [7] Koechner W. 2006. *Solid State Laser Engineering*. 6<sup>th</sup> Edition. New York: Springer-Verlag.