

Summer 1995

Focal Spot, Summer 1995

Follow this and additional works at: http://digitalcommons.wustl.edu/focal_spot_archives

Recommended Citation

Focal Spot, Summer 1995, July 1995. Bernard Becker Medical Library Archives. Washington University School of Medicine.

This Book is brought to you for free and open access by the Focal Spot at Digital Commons@Becker. It has been accepted for inclusion in Focal Spot Archives by an authorized administrator of Digital Commons@Becker. For more information, please contact engeszer@wustl.edu.

FOCAL SPOT

SUMMER, 1995

VOLUME 26, NUMBER 2

MALLINCKRODT INSTITUTE OF RADIOLOGY

VERB

RESEARCH
NOUN

IMAGING BRAIN FUNCTION

STE

FRONTAL
CORTEX

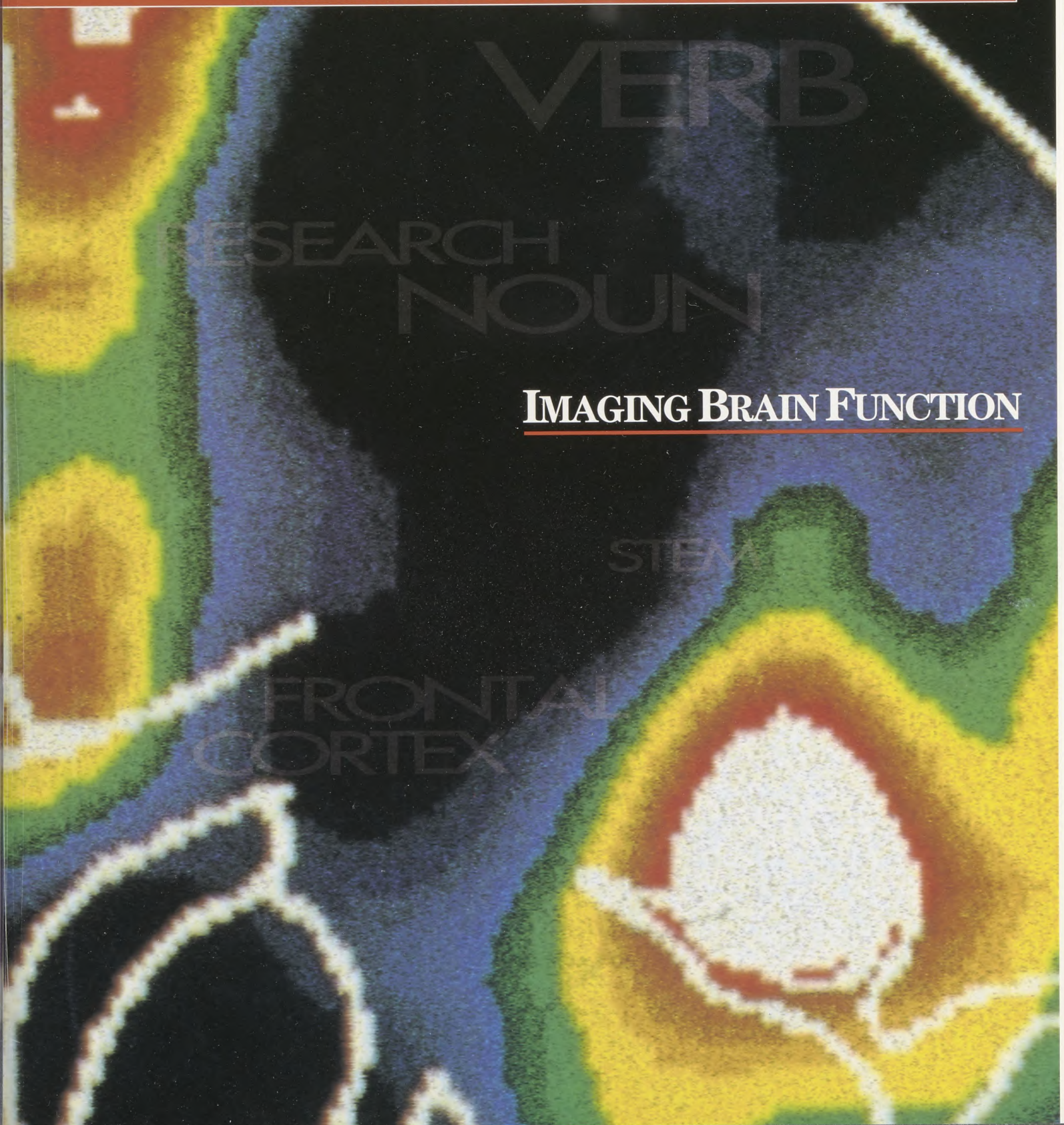



Gary Shackelford, MD, professor of radiology, (shown with Gary Luker, MD, a pediatric radiology fellow) is the 1995 recipient of the Annual Senior Residents' Distinguished Teaching Award. Now in its twelfth year, the award is presented to the "MIR faculty member who has made the greatest contribution to resident education."

Shackelford, a pediatric radiologist at St. Louis Children's Hospital, joined the Institute faculty in 1972, after completing three years of diagnostic radiology training at MIR (chief resident, 1971-1972). He was director of the diagnostic radiology resident training program (1981 to 1988) and served on the Diagnostic Radiology Resident Selection Committee (1976 to 1991).

2



BRAIN FUNCTION: GENDER SIMILARITIES? GENDER DIFFERENCES?

Neuroimaging scientists are using positron emission tomography to answer the recurrent question of whether or not the brain functions differently in men and women.

7 STEP BY STEP

Spiral computed tomography and a three-dimensional surface scanner promise to provide better fitting prostheses for the thousands of patients who undergo lower limb amputation.

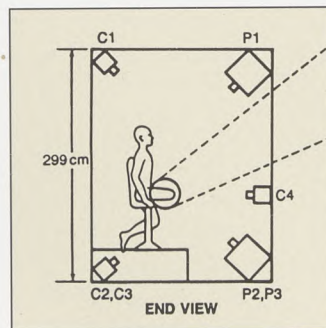

11

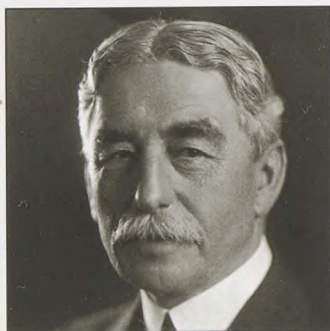

RENEWING MALLINCKRODT TIES

Mallinckrodt family members from near and far visit one of their internationally known namesakes: The Edward Mallinckrodt Institute of Radiology at Washington University.

17 FYI

ON THE COVER:

By mapping the brain circuits with positron emission tomography (PET), MIR researchers discovered that the left frontal cortex is used by both men and women during language functions. Positrons emitted by a low-dose radiopharmaceutical produce a "gleam" on the PET scan that clearly designates areas of brain activity.



During the study, patients are fitted with a special mask to help reduce any movement that might cause a misregistration on the PET scan.

STUDY

BRAIN FUNCTION

GENDER SIMILARITIES?
GENDER DIFFERENCES?

Marcus E. Raichle, MD, is often invited to talk about studies conducted at Mallinckrodt Institute of Radiology (MIR) that use an exciting neuroimaging tool—positron emission tomography (PET)—to examine human brain function, especially in the areas of language and memory. After his lectures, the same question often comes up. “Somebody will ask if I have ever seen any differences in brain function between men and women,” says Raichle, codirector of MIR’s Division of Radiological Sciences.

The results of a new MIR study, to be published later this year in the *Journal of Neurophysiology*, suggests that the answer to that question is a qualified “no.” The study, led by Washington University graduate student Randy Buckner under the direction of Raichle and Steven E. Petersen, PhD, compared PET images from 61 subjects, male and female, who were given two different speech production tasks.

C A N D A C E O ’ C O N N O R

WOMEN

MEN

BRAIN FUNCTION

The PET results indicated no gender differences in the areas of the brain required to perform these two specific tasks. “On the PET scans, we found very striking and reliable activations on the left side of the frontal cortex, both in men and women, but practically nothing on the right side,” says Buckner.

Petersen, an associate professor of neurology and neurological surgery with a joint appointment in radiology, says he is not surprised by these results. “It’s difficult for me to imagine that evolution would have two sexes within the same species solving the problem of language in two different ways,” he says. “My guess is that as researchers continue their studies, they’ll find more gender similarities than differences.”

The MIR study has taken place against a backdrop of long-standing questions about gender differences in the brain’s organization. In the late 1970s and early 1980s, research focused on brain function in patients with brain damage or disease. Some researchers found that men whose left side of the brain had been affected by a stroke were more likely to have speech problems than women with damage in the same area. The implication: A man’s speech function may exist only on the left side of his brain, while a woman’s may exist bilaterally.



Marcus Raichle, MD.

The PET results indicated no gender differences in the areas of the brain required to perform two specific tasks.

That data proved controversial, however, and several subsequent studies failed to corroborate these findings. With the arrival of more sophisticated neuroimaging techniques, such as PET and functional magnetic resonance imaging (MRI), researchers now have a renewed interest in the question of gender differences.

“For the first time, we have a way to actually see which areas of the brain are used by healthy subjects,” says Buckner. “So, naturally, we want to see whether these supposed gender differences pan out.”

MIR is particularly well-positioned to do a study of this kind. Since 1980, with funding from the MacArthur Foundation of Chicago, the Institute has amassed a database containing some three thousand subjects and dozens of studies related to brain organization. By combining data from various studies performed over a seven-year period, Buckner and the other researchers had information from a large number of subjects, both male and female, to use in examining the gender differences issue.

STRING

VERB NOUN

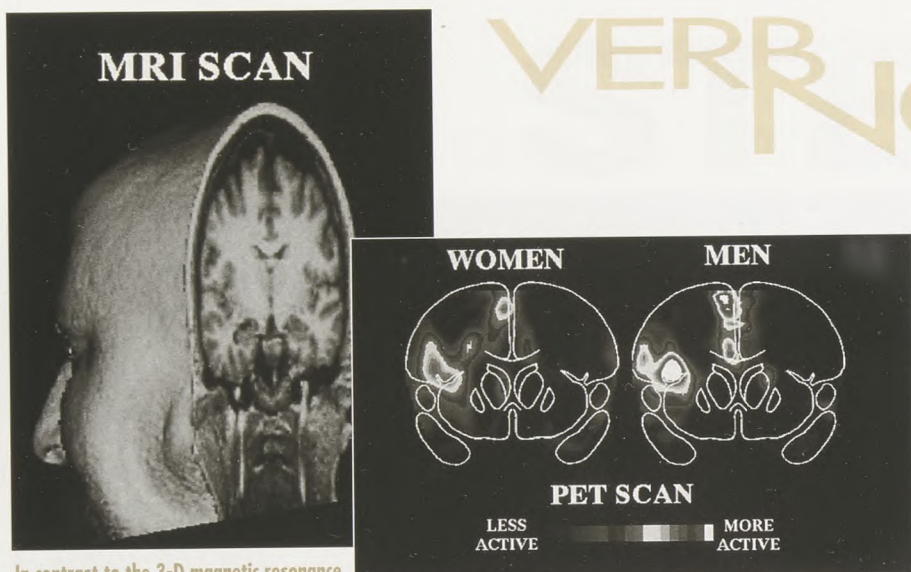

In contrast to the 3-D magnetic resonance image, which reveals the physical composition of the brain, the positron emission tomography scans show the brain's physiology. As indicated by the bright spots on the PET scans, similar areas of the brain were activated in both the male and the female patient during a common language task.

The scientists looked at results from two speech tasks: The first—and more complex—was a “verb generation” task, in which the subject was given a noun, such as “dog,” and asked to think of a related verb, such as “walk.” In the second, a “stem completion” task, the research patient was given the first few letters of a word, such as “str,” and asked to complete it with any word, as in “string” or “strike.”

Meanwhile, MIR researchers mapped the brain circuits needed to accomplish these tasks. They injected the research patient with a low-dose radiopharmaceutical (or radionuclide) and monitored the brain function, using the PET-VI scanner. The radionuclide traveled through the patient's bloodstream, serving as a tracer or measurement of normal physiological activity. The positrons emitted by the tracer were displayed as a “gleam” on the PET scan and clearly delineated areas of activity in the brain.

“Blood flow is increased in areas of the brain that are being used,” says Buckner. “In turn, more active areas also increase their output of radiation. So, if we want to know which part of the brain is being used during language functions, we study the PET scan to see where the blood is flowing and where the radiation is increasing. Then we know which area of the brain the patient is using.”

To understand the way this mapping works, it is important to think of the brain in terms of circuits—and the many combinations of nerve cells—needed to accomplish various tasks. “The analogy I like to use is that of a symphony orchestra,” says Raichle. “It has a finite number of players but an infinite variety of sounds. The violin player plays at one time; the piccolo player at another time, and so on. Our task is to identify the brain's players and the specific functions they perform in relation to a given task.”

On the stem completion task—the less complex of the two tasks in this particular study—the MIR researchers followed the step-by-step activation of the brain circuit needed to complete this exercise. The first area activated was the visual cortex, which handled the visual processing of the “str” stem. The next area was in the left frontal cortex, perhaps the brain area used to hold these letters while the patient thought about them. And the final areas were in the motor cortex and supplementary motor area, both known to help produce speech.

The pathway needed for the verb generation task was similar but also included some striking differences. The activations in the frontal cortex were much more extensive, and there were areas of the frontal cortex needed for this task that had not been required for the stem completion exercise.

“While both tasks required word retrieval, the verb generation task also involved accessing the meaning of the words and then using that information,” says Buckner. “Perhaps these more extensive regions of the frontal cortex are helping to supply the needed information and bring it online to complete the task. Common pathways appear to be used across these tasks, but depending on the specific flavor of the task, the brain recruits another player to get the necessary information.”

When they compared results by gender, the researchers found no differences in the areas of activation. Both men and women showed activation in the left frontal cortex; in contrast to the earlier stroke studies, women showed no signs of bilateral operation.

BRAIN FUNCTION

FRONTAL CORTEX

Surprisingly, the scientists did find that activations on the verb generation task were larger in the male subjects than in the females. Although it is difficult to know why this occurred, “one very weak clue is that it may be a little easier, or may take less time, for women to generate a verb,” says Petersen.

The MIR team discovered another interesting point. They asked a patient whose frontal cortex had been damaged by a stroke to attempt the stem-completion task performed by earlier study patients. To the researchers’ surprise, and as reported to the Cognitive Neuroscience Society earlier this year, the stroke patient performed the task well — without the use of the brain area needed to complete the tasks by the non-stroke subjects.

“We decided that maybe this patient was using different brain areas—new areas,” says Buckner. “We placed the patient in the PET scanner and found there was a very robust activation on the brain’s right side. We believe this is actually a brain area being used to compensate for damage following a stroke.”

In November of 1994, the MIR researchers announced their study results with non-stroke patients at a press conference called by the Society for Neuroscience. Coincidentally, shortly thereafter, a team from Yale University also announced the results of a large-scale study, using functional MRI, in which they found differences between men and women in lateralization of language function. This study, which involved rhyming tasks, pointed to activation bilaterally in women but only on the left side in men.



Steven Petersen, PhD, (left) and Randy Buckner.

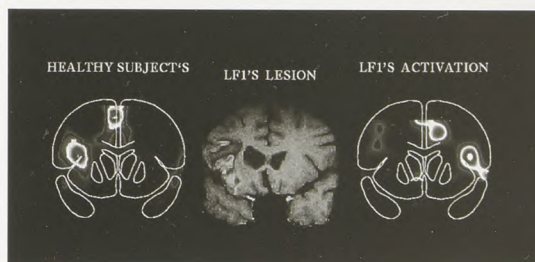

Certain language functions originating in the left frontal (LF) cortex of a “healthy” patient (PET scan on left) are transferred to other brain areas (right) in a patient with an LF lesion (middle).

Although the results of the MIR and Yale studies appear to be in conflict, future research may prove that both are accurate. “I’d be willing to suggest that their results are as valid as ours,” says Raichle. “I think this points to a very important issue. In some tasks we may not see a difference between males and females while in other tasks we may. It could be simply a matter of what you ask them to do.”

Apparent differences between men and women in the area of basic language processing may also have more to do with the ways in which men and women solve language problems. “When you ask men and women to perform the

same complicated cognitive task,” says Petersen, “it’s possible that women and men might adopt different strategies and then use different parts of their brains.”

Right now, all of these studies are providing basic information about the brain that will eventually help physicians treat patients with diseased or damaged nervous systems. “We want to understand everything — from patients who acquire language disturbances as a result of stroke to children who can’t learn to read and speak properly,” adds Raichle. “Then, by knowing how the brain works, we will be in a much better position to help our patients in their recovery.” **MIR**

STEP BY STEP

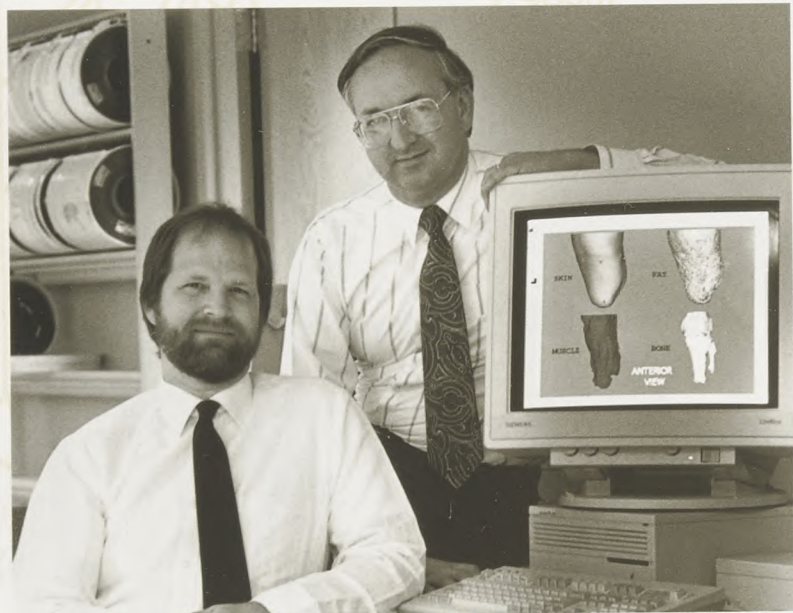

Kirk Smith (left) and Michael Vannier, MD.

Each year in the United States more than 40,000 patients undergo lower limb amputation. Some have lost their legs and feet because of diseases, like diabetes; others, due to trauma. While these patients differ in age, gender, race, and socioeconomic background, many amputees eventually share the same problem: an uncomfortable prosthesis (or artificial limb) that does not fit.

The portion of the limb remaining after amputation (called the residuum) consists of skin, fat, muscle, and fibrous tissue in a soft tissue envelope surrounding a bone remnant. Swelling, inadequate blood circulation, muscle contraction, atrophy, and weight gain or loss cause short- and long-term changes in the soft tissue envelope that, in turn, affect the fit of the prosthesis — more specifically, the fit of the prosthetic socket that surrounds the residuum. At Mallinckrodt Institute of Radiology, researchers are using X-ray images produced by spiral computed tomography and optical images from a three-dimensional surface scanner to measure the quality of socket fit and to provide better fitting artificial limbs.

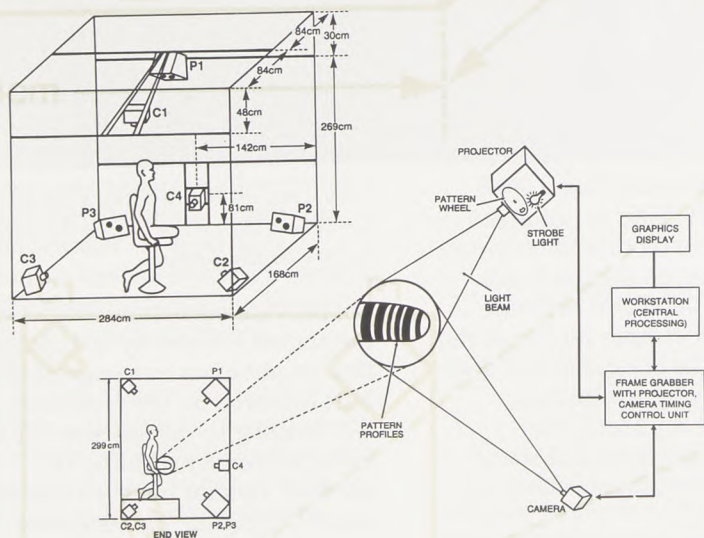

STEP BY STEP

Immediately after surgery the patient receives a temporary, adjustable prosthesis that is worn for approximately six months while the leg is healing. Following stabilization, measurements are taken of the residual limb, either manually or with a computer-aided design and manufacture (CAD/CAM) system running on a personal computer. These measurements provide specifications for modifying a plaster replica of the residuum, a model for creating the socket for the patient's permanent prosthesis.

With the manual method, the prosthetist uses a measuring tape, calipers, or a digitizer to obtain surface measurements of the residuum. After integrating all computations, the prosthetist fashions a plaster cast that is modified by adding or removing plaster until the resulting shape closely matches that of the residual limb and provides the patient with a comfortable fit.

Computers have been used since the mid-1980s to automate the design and fabrication of prostheses. Based on digitized measurements, CAD/CAM software creates an electronic replica of the residuum. The computerized specifications are fed to a milling machine that replicates the residuum shape from a block of plaster, silicone, foam rubber, or polyurethane.

The design of an effective prosthesis socket is hampered by insufficient data on the residual limb's shape, volume, or tissue characteristics provided by both the manual and CAD/CAM method. Although a better prosthetic fit usually can be achieved with the CAD/CAM system, CAD/CAM is incapable of fit evaluation and can-

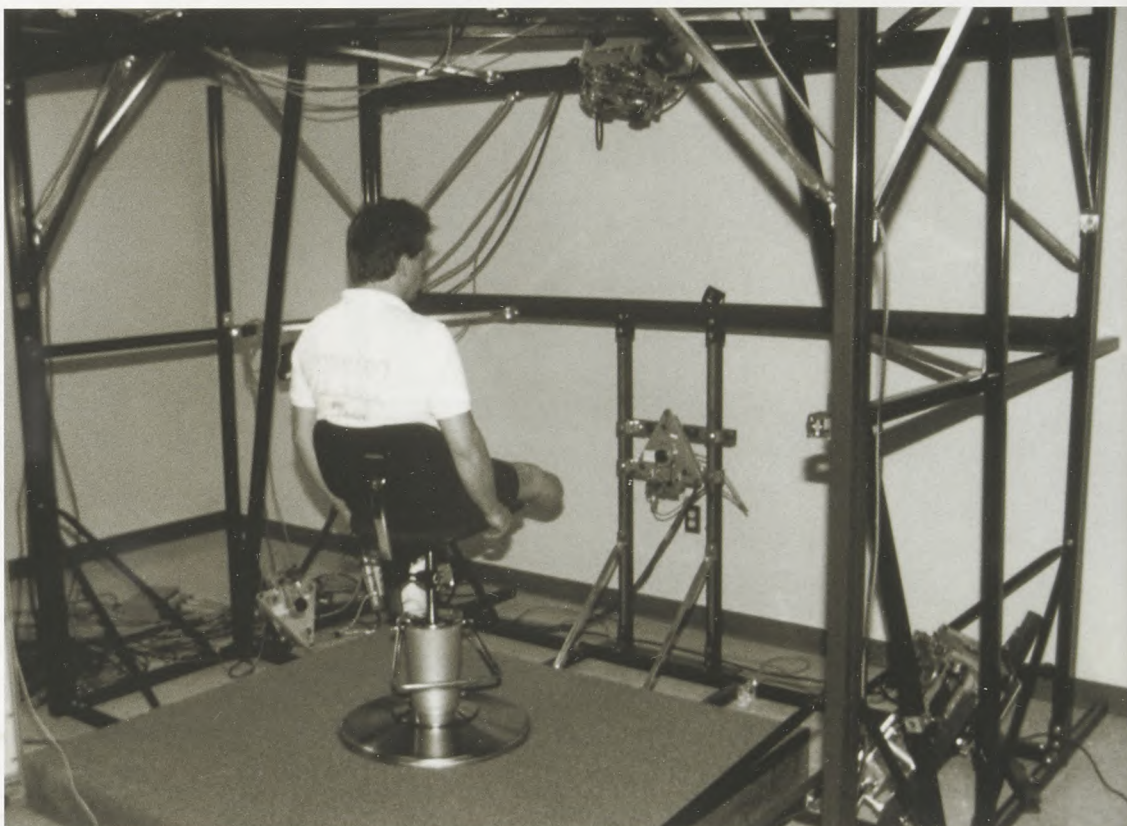

Cameras and projectors comprising the Optical Surface Scanning (OSS) system can view the residual limb in overlapping segments.

not provide measurements when the socket is worn by the patient. But, as principal investigator of MIR research on the application of 3-D imaging to the assessment of lower extremity residua, Dr. Michael Vannier believes that medical 3-D imaging "can improve objective assessment of prostheses fit and provide quantifiable measures necessary to achieve the ideal socket shape."

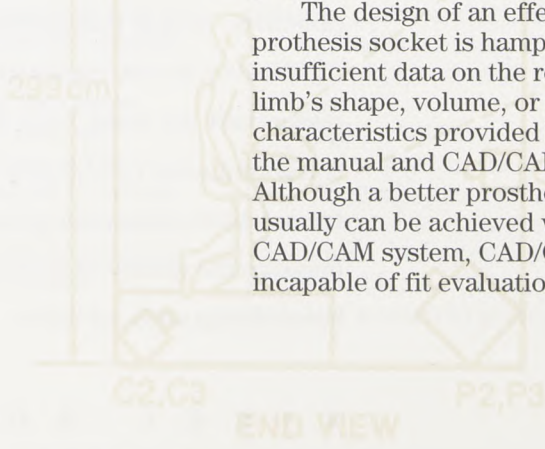

Funded by the National Institutes of Health's National Center for Medical Rehabilitation Research, Vannier, professor of radiology and director of the Institute's 3-D image processing laboratory, and coinvestigators Gulab Bhatia, instructor in radiology, and Paul Commean and Kirk Smith, senior research engineers, designed and constructed a special optical surface scanner for the project. The MIR scanner is the third generation of technology that was developed in 1983 by a small St. Louis company called Cencit to produce replicated portrait sculptures sold in shopping malls.

In 1990, Cencit scientists contacted Vannier, a pioneer in 3-D imaging, to help create a new market for their scanner. MIR-designed software and techniques converted Cencit's existing sensing device into a medical facial-surface scanner that is now used successfully by reconstructive surgeons in the pre- and postoperative evaluation of their patients. From that facial scanner evolved the residuum Optical Surface Scanning (OSS) system used in the MIR evaluation of prosthetic fitting methods.

At first glance, the surface scanner resembles a model constructed from a child's erector set: metal struts held together with nuts and bolts, a skeletal frame with no outer covering. The patient sits in an adjustable chair near the entrance to the structure. A closer look reveals four cameras and three projector sensors. Geometrically positioned around the

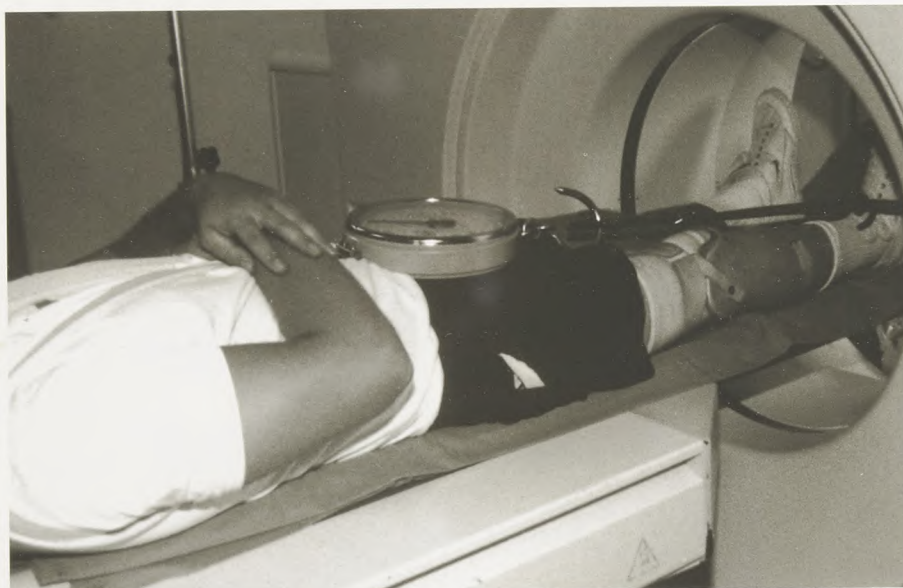

During spiral CT scanning, up to one-half of the patient's body weight can be simulated by attaching the axial loading device to the prosthesis.

frame, the cameras and projectors scan the residual limb in overlapping segments, achieving 360-degree coverage of the entire residual surface — including the distal end that cannot be viewed

Technology for the optical surface scanner initially produced portrait sculptures in shopping malls.

with other optical scanning systems. Using ordinary white light (instead of lasers as in other systems) and a patterned light concept, the scanner produces 48 images of the residuum in less than one second. The images are processed into 3-D data that can be viewed on a nearby computer screen.

While surface scanning combined with a CAD/CAM system is an improvement over the traditional socket fabrication, the technology cannot image internal tissue morphology or a residual limb with a prosthesis in place. A diagnostic modality called helical or spiral computed tomography (CT) fills that gap by providing volumetric, cross-sectional information about the residual limb's hard and soft tissue. A noninvasive procedure, spiral CT operates on a slip-ring technology. The X-ray tube and detector rotate continuously in a 360-degree spiral motion around the patient. The patient takes only a single breath-hold, virtually eliminating the risk of respiratory misregistration and motion artifacts on the scan. Total scanning time ranges from a few seconds up to one-half minute.

STEP BY STEP

In the past 18 months, in collaboration with a St. Louis orthotic and prosthetic company called O&P Lab, 14 patients with below-the-knee amputations have worked with the MIR team in measuring the accuracy and suitability of the imaging devices in designing and evaluating prosthesis fit. With a few months remaining in the first phase of the project, the research

The scanner produces 48 images of the residuum in less than one second.

team has shown that the OSS system and spiral CT are feasible modalities for prosthesis design: Volumetric measurements of a solid model were within two percent of the same measurements on surface models.

The next phase of the project includes a giant step in prosthesis design — evaluating the fit of an in situ prosthesis and determining physical parameters affecting the quality of fit. In order to simulate the force of weight and gravity on the prosthesis while a patient is standing or walking, each patient will use an MIR-designed and constructed axial loading device to apply weight to the prosthesis during spiral CT scanning. The CT scan will assess change in the residuum tissue shape caused by the loading condition.

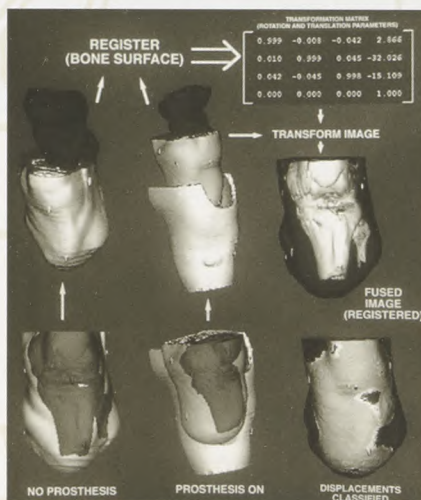

A panel of area prosthetists working in conjunction with the Jefferson Barracks Veterans Administration Medical Center in St. Louis will evaluate the prosthetic socket fit. Coinvestigators for this segment of research are

These 3-D images of the residuum (above) and the residuum with and without the prosthesis provide valuable information for determining good versus poor fit.

Virginia Swanson, MD, chief of Rehabilitation Service at the VA Medical Center and Jack Engsborg, PhD, an expert in prosthetics research who is program director of the Motion Analysis Laboratory at St. Louis Children's Hospital.

Wayne Sprouse, a certified prosthetist and president and CEO of Southern Illinois Prosthetic & Orthotic, Ltd., which is the only prosthetic facility in the St. Louis area with a CAD/CAM system, is excited about his company's participation in the project: "This research is very important for the patients and the prosthetists. With a faster, better system for fitting a prosthesis, our patients will be ambulatory sooner and more comfortably." **MIR**

RENEWING MALLIN&KRODT T I E S



In early June of this year, the population of Augusta, Missouri — 293 residents — was nearly doubled as some 200 members of the Mallinckrodt family held a four-day, international gathering or *familien fest*. Representing 23 generations of Mallinckrodt's and traveling from 16 states and six countries, they came to Augusta to renew old family ties and to meet European cousins, to introduce the younger generations to their ancestral roots and to establish a family communication so that future generations would always know about their beginnings. BY VICKI KUNKLER



The Mallinckrodt family coat of arms.



MALLINCKRODT

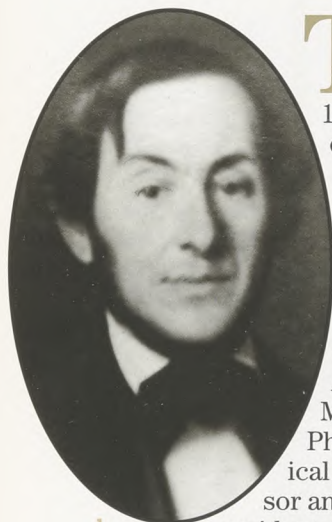

The reunion was prompted by the 1994 publication of *From Knights to Pioneers*, the first documented history of the Missouri Mallinckrodt who emigrated from Germany. Author Anita Mallinckrodt, PhD, a retired political science professor and journalist and a

resident of Augusta, organized the celebration that included visits to several Mallinckrodt name-sakes: the plant at Mallinckrodt Chemical, Mallinckrodt Center at Washington University, and Mallinckrodt Institute of Radiology.

The majority of the “reunion” Mallinckrodt descended from the first permanent German settlers in Augusta, then known as Mount Pleasant: three brothers (Julius, Conrad, and Hermann) and their cousin (Emil), emigrants from the city of Dortmund, province of Westphalia, kingdom of Prussia (now Germany). The early Mallinckrodt were prominent Dortmunders whose ancestors were 13th-century knights. They owned large farms and thriving businesses, were well-educated, and actively participated in local government. But in the early 1800s, financial problems and political restraints — a result of the Napoleonic Wars — affected most Westphalians, including the Mallinckrodt.



1 Emil Mallinckrodt, one of the first family members who settled in Missouri. Photo reproduced by permission of the Missouri Historical Society.

2 (left to right) Ronald Evens, MD, director of the Institute; Betsy Mallinckrodt Bryden, a descendant of Emil who now lives in New York; William Peck, MD, executive vice chancellor for medical affairs and dean of Washington University School of Medicine; and William Danforth, MD, recently retired chancellor of Washington University.



3 (left to right) Doctors Stephen Grampp, who is on faculty at the University of California San Francisco Medical Center; Ronald Evens; and Hermann Mallinckrodt from Bamberg, Germany.

4 (left to right) Virginia Trent, coordinator of the MIR tour; Anita Mallinckrodt, a descendant of Conrad and organizer of the family reunion; and Sue Day, an abdominal radiology staff member and a tour guide for the event.

5 Arnold Mallinckrodt — father of Emil, grandfather of Edward Sr., and great-grandfather of Edward Jr.

By the 1830s, large numbers of Germans were immigrating to America, seeking social, political, and individual freedom. Influenced by reports of the fertile soil in what is now western St. Charles County, Emil and Julius arrived in St. Louis in February of 1832 and made their way to Mount Pleasant. Within six years, Conrad and Hermann and several other relatives also immigrated to the New World.

Julius and Conrad remained in the St. Charles County area and became community leaders. Hermann eventually settled in Colorado. Emil later moved to St. Louis and was a well-known real estate developer. Through Emil's branch of the family came the connection between Washington University and the Mallinckrodt family.





MALLINCKRODT

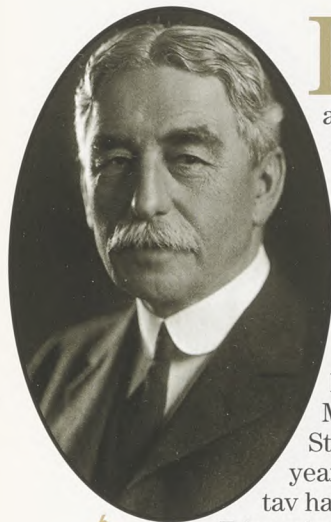

In 1867, Emil's three sons — Otto, Gustav, and Edward — started the Mallinckrodt Chemical Works in a small, one-story, stone building situated on a dirt road that was later named Mallinckrodt Street. Within 10 years Otto and Gustav had died and

Edward alone controlled the chemical plant. Railroads soon criss-crossed the United States, opening up trade to all areas of the country and establishing St. Louis as the "Gateway to the West." As the country became more industrialized, the chemical market expanded and Edward's company flourished.

In 1923, Mallinckrodt Chemical Works entered the medical arena. Washington University researchers and Mallinckrodt Company chemists developed a contrast media that, used with an X ray, produced the first visualization of a human gallbladder, a cholecystogram. This successful collaboration was an important stepping-stone in the establishment of a radiological facility at Washington University School of Medicine.



6 Edward Mallinckrodt, Sr.

7 In the neurological PET research area, Lennis Lich, technical supervisor, explained the technology of positron emission tomography.

8 Glenn Foster, a special procedures technologist in the magnetic resonance research lab, led the way to The Mallinckrodt Institute of Radiology at Washington University Imaging Center.



10

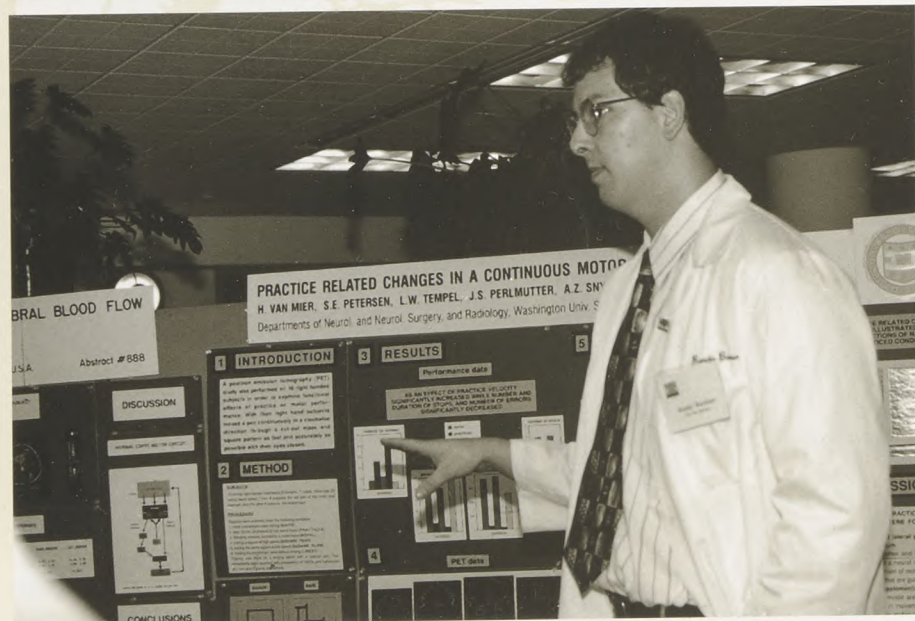

11

9 Edward Mallinckrodt, Jr.

10 A cameraman from television station WDR in Dortmund, Germany, accompanied a tour group in the Imaging Center as Shantanu Kaushikkar, MS, a research assistant and programmer, discussed research conducted in the MR physics laboratory.

11 Randy Buckner, a graduate student in the neuroimaging laboratory, spoke about the application of positron emission tomography to the study of the human brain.

Recognizing that radiology would become an important medical specialty, Washington University administrators were determined that the University would establish one of the world's highest quality radiology departments. In 1926 Doctors Evarts Graham and Sherwood Moore, two of the researchers who developed cholecystography, and Dr. McKim Marriott, dean of the University's medical school, met with representatives of the Rockefeller Foundation. They successfully arranged an endowment for a department of radiology, but the endowment would be awarded only if St. Louis benefactors funded a building to house the department.

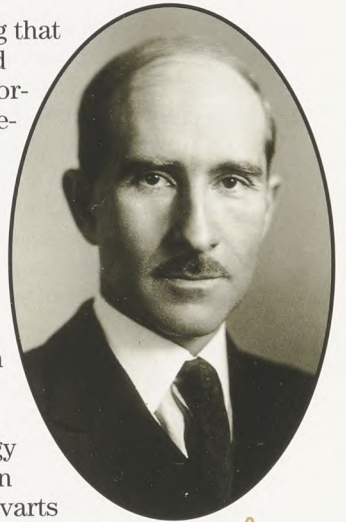

9



MALLINCKRODT

Edward Mallinckrodt was one of St. Louis' most benevolent philanthropists. He donated to charities and educational and cultural organizations, including large contributions to Harvard University for establishing and housing a department of chemistry and to Washington University for building a cultural center on the Hilltop campus.

In 1927 the University turned to Edward Mallinckrodt and received his support to build an "Institute of Radiology." Edward Sr. died in 1928, but Edward Jr., who succeeded his father as head of the chemical company, honored his father's pledge and provided additional funding to increase the size of the proposed building. On October 2, 1930, Edward Jr. laid the cornerstone of the nine-story Edward Mallinckrodt Institute of Radiology at Washington University. ■■■■

12 (left to right) Claudine Mallinckrodt-Reese from Amenia, New York, and Ellen Mallinckrodt Black from Portland, Oregon, both descendants of Emil; and Cheryl Knapp from Escondido, California; Gayle Knapp from Oak Park, Illinois; Keith Knapp from El Cajon, California; and Joan Knapp Enyeart from Olympia, Washington. The Knapp family are descendants of Julius. ■■■■



13 A twenty-third generation Mallinckrodt — 10-month-old Maximilian, son of Udo and Christine Voss Mallinckrodt of Glen Ellyn, Illinois.

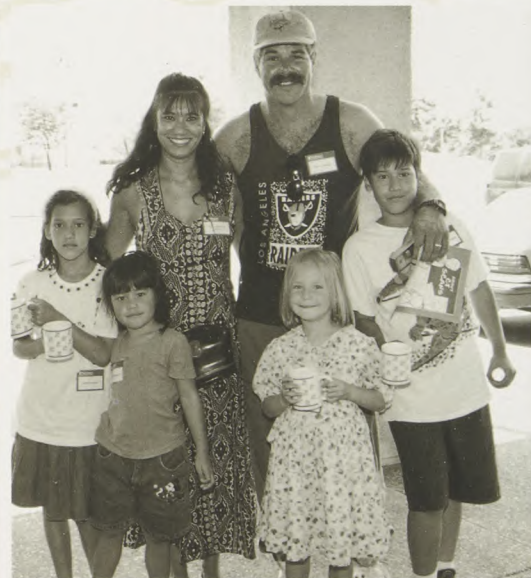

14 Robert and Maya Mallinckrodt Campbell of Apple Valley, California. (front, left to right) the Campbell's daughter, Caroline van Laack; Maya Mallinckrodt of Christchurch, New Zealand; Hannah Mallinckrodt of Turnbridge Wells, England; and the Campbell's son Christian van Laack

THE DIRECTOR'S OFFICE REPORT

PROMOTIONS

G. James Blaine, DSc, associate professor of radiology, was promoted to professor of radiology, Division of Diagnostic Radiology.

Walter R. Bosch, DSc, research associate in radiology, was promoted to instructor in radiology, Radiation Oncology Center.

James A. Brink, MD, assistant professor of radiology, was promoted to associate professor of radiology, Division of Diagnostic Radiology.

Harvey S. Glazer, MD, associate professor of radiology, was promoted to professor of radiology, Division of Diagnostic Radiology.

Eric E. Klein, MS, instructor in radiology, was promoted to assistant professor of radiology, Radiation Oncology Center.

Daniel A. Low, PhD, instructor in radiology, was promoted to assistant professor of radiology, Radiation Oncology Center.

Robert S. Malyapa, MD, PhD, research associate in radiology, was promoted to instructor of radiology, Radiation Oncology Center.

Jeff M. Michalski, MD, instructor in radiology, was promoted to assistant professor of radiology, Radiation Oncology Center.

Edward Muka, MSE, scientific coordinator, was promoted to research associate in radiology, Division of Diagnostic Radiology.

Daniel Picus, MD, associate professor of radiology, was promoted to professor of radiology, Division of Diagnostic Radiology.

Cary L. Siegel, MD, instructor in radiology, was promoted to assistant professor of radiology, Division of Diagnostic Radiology.

Celette S. Skinner, PhD, research instructor in radiology, was promoted to assistant professor of radiology, Division of Radiological Sciences.

O. Clark West, MD, instructor in radiology, was promoted to assistant professor of radiology, Division of Diagnostic Radiology.

Jeffrey F. Williamson, PhD, associate professor of radiology, was promoted to professor of radiology, Radiation Oncology Center.

CHANGE IN STATUS

Jay P. Heiken, MD, professor of radiology, has accepted the position of section chief, abdominal radiology, Division of Diagnostic Radiology.

Teresa J. Jones-Wilson, PhD, research assistant in radiology, was named NHLBI fellow in radiology, Division of Radiological Sciences.

JOINT APPOINTMENTS

Joseph J. H. Ackerman, PhD, professor of chemistry, received a joint appointment as professor of radiology.

Gary E. Christensen, DSc, research assistant professor of surgery, received a joint appointment as assistant professor of radiology.

James R. Duncan, MD, PhD, assistant professor of radiology, received a joint appointment as assistant professor of cell biology and physiology.

Bahman Emami, MD, professor of radiology, received a joint appointment as professor of otolaryngology.

Louis A. Gilula, MD, professor of radiology, received a joint appointment as professor of surgery.

Roberto Pacifici, MD, associate professor of medicine, received a joint appointment as assistant professor of radiology.

Milorad M. Rogic, PhD, associate director, organic chemistry, at Mallinckrodt Medical, Inc. received an appointment as adjunct assistant professor of radiology.

William R. Reinus, MD, associate professor of radiology, received a joint appointment as assistant professor of medicine.

Keith M. Rich, MD, associate professor of neurological surgery, received a joint appointment as associate professor of radiology.

Marilyn J. Siegel, MD, professor of radiology, received a joint appointment as professor of radiology in pediatrics.

NEW STAFF

Robert W. Brown, PhD, visiting professor of radiology, Division of Radiological Sciences.

Laurent Buffatt, PhD, visiting research associate, Radiation Oncology Center.

Cathy S. Cutler, PhD, research associate in radiology, Division of Radiological Sciences.

Osama L. Elshafei, MD, visiting research fellow in radiology, Division of Diagnostic Radiology.

Thomas L. Lakanen, MEM, MBA, research associate in radiology, Radiation Oncology Center.

Jurgen R. Reichenbach, PhD, visiting research associate in radiology, Division of Radiological Sciences.

Michael R. Thompson, MS, graduate research assistant in radiology, Division of Radiological Sciences.

Mai Xu, MD, PhD, research associate in radiology, Radiation Oncology Center.

THE DIRECTOR'S OFFICE REPORT

continued from page 17

FIRST-YEAR POST-GRADUATES

George W. Brown, MD, received his undergraduate degrees from the University of Utah and Harvard University and medical degree from the University of Utah. He is a member of Alpha Omega Alpha.

Denise J. Iuliano, MD, received her undergraduate degree from Duke University and medical degree from the University of Pennsylvania. She is a member of Alpha Omega Alpha.

Lawrence S. Kaskowitz, MD, received his undergraduate and medical degrees from Washington University.

Kraig R. Kirkpatrick, MD, received his undergraduate degree from Graceland College and medical degree from Washington University.

Todd L. Knapp, MD, received his undergraduate degree from Brigham Young University and medical degree from the University of Utah. He is a member of Alpha Omega Alpha.

Stephen P. Loehr, MD, received his undergraduate degree from the University of North Carolina and medical degree from Bowman Gray Medical College.

Christine O. Menias, MD, received her undergraduate degree from Marquette University and medical degree from George Washington University. She is a member of Alpha Omega Alpha.

Michael J. Naylor, MD, received his undergraduate degree from Providence College and medical degree from Washington University. He is a member of Alpha Omega Alpha.

Theodore J. Passe, MD, received his undergraduate degree from the University of Notre Dame and medical degree from Duke University.

Perry J. Pickhardt, MD, received his undergraduate degree from the University of Wisconsin, Madison, and medical degree from the University of Michigan. He is a member of Alpha Omega Alpha.

Joshua S. Shimony, MD, received his undergraduate degree from the University of Tennessee and medical degree from the University of Illinois.

FIRST-YEAR DIAGNOSTIC RADIOLOGY RESIDENTS

Sanjeev Bhalla, MD, received his undergraduate degree from Yale University and medical degree from Columbia University College of Physicians and Surgeons. He completed an internal medicine internship at Columbia Presbyterian, New York City, New York.

R. Michael Boerner, MD, PhD, received his undergraduate and medical degrees from the University of North Carolina, Chapel Hill.

Dallas D. Peck, MD, received his undergraduate and medical degrees from the University of Utah. Peck completed an internship at the LDS Hospital, Salt Lake City, Utah. He is a member of Alpha Omega Alpha.

Sean D. Pierce, MD, received his undergraduate and medical degrees from Harvard University.

Jeffrey A. Spaeder, MD, received his undergraduate degree from Pennsylvania State University and his medical degree from Johns Hopkins School of Medicine. He completed an internship at the University of Pittsburgh Medical Center.

FIRST-YEAR NUCLEAR MEDICINE TRAINEES

John P. Moyers, MD, received his undergraduate degree from Indiana University and medical degree from Vanderbilt University. He completed a four-year diagnostic radiology residency at Vanderbilt University Medical Center, Nashville, Tennessee. Moyers is a member of Alpha Omega Alpha.

Charles K. Pringle, MD, received his undergraduate degree from the University of Mississippi and medical degree from the University of Tennessee. He completed a one-year internship and a four-year diagnostic radiology residency at the University of Tennessee Medical Center, Memphis.

Michael C. Roarke, MD, completed a four-year diagnostic radiology residency at Mallinckrodt Institute of Radiology.

Gregg D. Schubach, MD, received his undergraduate degree from Rensselaer Polytechnic Institute and medical degree from the University of New York, Valhalla. He completed a one-year internship at Wilson Memorial Regional Medical Center, New York City, New York, and a four-year diagnostic radiology residency at Albert Einstein College of Medicine, New York City, New York.

Samuel C. Wang, MD, received his undergraduate and medical degrees at Yale University. He completed a one-year internship at Danbury Hospital, Danbury, Connecticut, and a four-year diagnostic radiology residency at Hospital of Saint Raphael, New Haven, Connecticut.

FIRST-YEAR RADIATION ONCOLOGY RESIDENTS

Lannis E. Hall-Daniels, MD, received her undergraduate degree from the University of Michigan, Ann Arbor, and medical degree from Howard University. She completed a one-year surgical internship and a one-year surgical residency at Howard University Medical Center, Washington, DC.

David A. Diamond, MD, received his undergraduate degree from Princeton University and medical degree from the University of Florida, Gainesville. Diamond completed a one-year internship at Yale-New Haven Hospital, New Haven, Connecticut. He is a member of Alpha Omega Alpha.

Tara Tabesh, MD, PhD, received her medical degree from Stanford University. She completed an internship at the University of Washington Hospitals, Seattle.

Cristiane Takita, MD, received her undergraduate and medical degrees from the University of Sao Paulos, Brazil. Takita completed a one-year internship and a three-year residency at Hospital Das Clinicas, University of Sao Paulos, where she was chief resident, radiation oncology, 1992-1993. She also completed an internship at St. Mary's Health Center, St. Louis, Missouri.

Mary L. Vest-Mason, MD, received her undergraduate degree from the University of Illinois and medical degree from Washington University. She completed an internship at Jewish Hospital, St. Louis, Missouri.

FIRST-YEAR FELLOWS

G. Glenn Coates, MD, instructor in radiology, is a fellow in magnetic resonance imaging. Coates received his undergraduate degree from Brown University and medical degree from the University of California, Irvine. He completed a one-year internship and a four-year diagnostic radiology residency at Virginia Mason Medical Center, Seattle, Washington.

Kenneth L. Ford, MD, instructor in radiology, is a fellow in abdominal radiology. Ford received his undergraduate degree from Abilene Christian University and medical degree from Baylor College of Medicine. He completed a four-year diagnostic radiology residency at Bowman Gray School of Medicine. Ford is a member of Alpha Omega Alpha.

Robert J. Feiwell, MD, instructor in radiology, is a fellow in neuroradiology. Feiwell received his undergraduate degree from the University of California, Berkeley, and medical degree from the University of California, San Diego. He completed a one-year internship at the UCSF Medical Center, Fresno, California, and a four-year diagnostic radiology residency at Baylor Medical Center, Waco, Texas.

Rachael Gordon, MD, instructor in radiology, is a fellow in neuroradiology. Gordon received her undergraduate degree from Washington University and medical degree from the University of Colorado. She completed a one-year general surgery internship at St. Joseph's Hospital, Denver, Colorado, and a four-year diagnostic radiology residency at Cedars-Sinai Medical Center, Los Angeles, California. Gordon is a member of Alpha Omega Alpha.

Phillip B. Gunther, MD, instructor in radiology, is a fellow in magnetic resonance imaging. Gunther received his undergraduate degree from the University of Denver and medical degree from the University of Colorado. He completed a one-year internship at St. Luke's Presbyterian Medical Center, Denver, Colorado, and a four-year diagnostic radiology residency at the University of Colorado Health Sciences Center, Denver.

Glenn M. Hammer, MD, instructor in radiology, is a fellow in neuroradiology. Hammer received his undergraduate and medical degrees from the University of Iowa. Hammer completed a four-year diagnostic radiology residency at Southern Illinois University Medical Center, Springfield.

Robert Y. Kanterman, MD, instructor in radiology, is a fellow in vascular and interventional radiology. He completed four years of training in diagnostic radiology at Mallinckrodt Institute of Radiology.

Keith A. Kronemer, MD, instructor in radiology, is a fellow in pediatric radiology. Kronemer received his undergraduate degree from Drake University and medical degree from Tulane University. He completed a one-year internal medicine internship at St. Louis University Medical Center, St. Louis, Missouri, and a four-year diagnostic radiology residency at Tulane University Medical Center, New Orleans, Louisiana.

Gary D. Luker, MD, instructor in radiology, is a fellow in pediatric radiology. He completed four years of training in diagnostic radiology at Mallinckrodt Institute of Radiology.

James M. Milburn, MD, instructor in radiology, is a fellow in neuroradiology. Milburn received his undergraduate and medical degrees from the University of Missouri, Kansas City. He completed a one-year internship and a four-year diagnostic radiology residency at Ochsner Foundation Hospital, New Orleans, Louisiana.

Mitchell A. Miller, MD, instructor in radiology, is a fellow in abdominal radiology. He completed a four-year diagnostic radiology residency at Mallinckrodt Institute of Radiology.

Sean M. Muldowney, MD, instructor in radiology and cochief resident, Division of Diagnostic Radiology, 1994-1995, is a fellow in vascular and interventional radiology. He completed four years of training in diagnostic radiology at Mallinckrodt Institute of Radiology.

THE DIRECTOR'S OFFICE REPORT

continued from page 19

Valerie C. Reichert, MD, instructor in radiology, is a fellow in abdominal radiology. She completed a four-year diagnostic radiology residency at Mallinckrodt Institute of Radiology.

Francis J. Schlueter, MD, instructor in radiology, is a fellow in vascular and interventional radiology. He completed a four-year diagnostic radiology residency at Mallinckrodt Institute of Radiology. He is a member of Alpha Omega Alpha.

Ken L. Schreibman, MD, instructor in radiology, is a fellow in musculoskeletal radiology. Schreibman received his undergraduate degree from Massachusetts Institute of Technology and medical degree from Case Western Reserve University. He completed a four-year diagnostic radiology residency at University of Chicago Hospitals.

Sharon J. Schubach, MD, instructor in radiology, is a fellow in breast imaging. Schubach received her undergraduate degree from Bucknell University and medical degree from New York Medical College. She completed a one-year internship at Wilson Memorial Hospital, New York City, New York, and a four-year diagnostic radiology residency at the State University of New York, Stony Brook.

Kurt R. Simpson, MD, instructor in radiology, is a fellow in vascular and interventional radiology. He completed four years of training in diagnostic radiology at Mallinckrodt Institute of Radiology.

Isabel C. Soroeta, MD, instructor in radiology, is a fellow in breast imaging. Soroeta received her undergraduate degree from Tulane University and medical degree from the University of Puerto Rico. She completed a one-year internship and a five-year diagnostic radiology residency at Ochsner Foundation Hospital, New Orleans, Louisiana. Soroeta is a member of Alpha Omega Alpha.

Glenn M. Strome, MD, instructor in radiology, is a fellow in musculoskeletal radiology. Strome received his undergraduate degree from the University of California, Los Angeles, and medical degree from the University of California, San Francisco. He completed a four-year diagnostic radiology residency at Henry Ford Hospital, Detroit, Michigan.

Robert C. Vogler, MD, instructor in radiology, is a fellow in neuroradiology. Vogler received his undergraduate and medical degrees from the University of North Carolina, Chapel Hill. He completed a four-year diagnostic radiology residency at the University of North Carolina School of Medicine, Chapel Hill.

Michael J. Wallace, MD, instructor in radiology, is a fellow in vascular and interventional radiology. Wallace received his undergraduate degree from the University of Texas, Austin, and medical degree from the University of Texas Health Sciences Center. He completed a one-year internship at Lyndon B. Johnson Hospital/Hermann Hospitals, Austin, Texas. Wallace completed one year of a diagnostic radiology residency at the University of Arizona and three years of a diagnostic radiology residency at the University of Texas.

Pamela K. Woodard, MD, instructor in radiology, is a fellow in chest radiology. Woodard received her undergraduate and medical degrees from Duke University. She completed a one-year internal medicine internship and a four-year diagnostic radiology residency at the University of North Carolina, Chapel Hill.

Terry D. Yeager, MD, instructor in radiology, is a fellow in vascular and interventional radiology. Yeager received his undergraduate degree from the University of Nebraska and medical degree from Washington University. He completed a one-year internship and a four-year diagnostic radiology residency at Tripler Army Medical Center, Honolulu, Hawaii.

OFF STAFF

Shepherd M. Abrams, MD, assistant in radiology, completed three years of training in diagnostic radiology at Jewish Hospital, St. Louis, Missouri, and one year of training at Mallinckrodt Institute of Radiology. He has accepted a position with Berland Radiology Associates, St. Louis, Missouri.

Edward E. C. Angtuaco, MD, instructor in radiology, completed a two-year fellowship in neuroradiology and has accepted a position with the Department of Radiology at the University of Arkansas, Little Rock.

Michael Beat, MD, assistant in radiology, completed four years of training in radiation oncology.

John V. Catasca, MD, assistant in radiology, completed three years of training in diagnostic radiology at Jewish Hospital, St. Louis, Missouri, and one year of training at Mallinckrodt Institute of Radiology. He has accepted a position with the Department of Radiology at the University of Utah, Salt Lake City.

Barry Chandler, MD, assistant in radiology, completed one year of training in radiation oncology.

Edward Cohen, MD, assistant professor of clinical radiology.

Constance S. Courtois, MD, instructor in radiology, completed a four-year diagnostic radiology residency and a one-year fellowship in vascular and interventional radiology. She has accepted a position with Mallinckrodt Institute of Radiology.

Colin P. Derdeyn, MD, instructor in radiology and chief resident, Division of Diagnostic Radiology, 1993-1994, completed a four-year diagnostic radiology residency and a one-year fellowship in neuroradiology. He has accepted a position with the University of Wisconsin Hospitals and Clinics, Madison.

Jeffrey A. Dobkin, MD, assistant professor of radiology, Division of Nuclear Medicine.

Thomas H. R. Farmer, MD, instructor in radiology, completed four years of training in diagnostic radiology and a one-year fellowship in magnetic resonance imaging. He has accepted a position with TeleRadiology Associates, Durham, North Carolina.

James W. Farn, MD, assistant in radiology, completed three years of training in diagnostic radiology at Jewish Hospital, St. Louis, Missouri, and one year of training at Mallinckrodt Institute of Radiology.

Thomas A. Farrell, MD, instructor in radiology, completed a one-year fellowship in vascular and interventional radiology and has accepted a position in the Department of Radiology at the University of Iowa, Iowa City.

John A. Freeby, MD, assistant in radiology, completed four years of training in diagnostic radiology and has received a computed tomography/ultrasound/magnetic resonance fellowship at Johns Hopkins Medical Center, Baltimore, Maryland.

Jeff G. Geohas, MD, assistant in radiology, completed one year of training in radiation oncology.

Chandan Guha, MD, assistant in radiology, Radiation Oncology Center.

Albert M. Hammerman, MD, assistant professor of clinical radiology, Division of Diagnostic Radiology.

Stephen F. Hatem, MD, instructor in radiology, completed a one-year fellowship in musculoskeletal radiology and has accepted a position with Case Western Reserve University Hospitals, Cleveland, Ohio.

Gregory A. Hatfield, MD, instructor in radiology, completed a two-year fellowship in neuroradiology and has accepted a position with the University of Texas, Houston.

Jacqueline C. Hodge, MD, instructor in radiology, Division of Diagnostic Radiology.

Daniel Keleti, MD, assistant in radiology and chief resident, Radiation Oncology Center, 1994-1995, completed a three-year residency and a one-year fellowship in radiation oncology.

Virginia E. Klaas, MD, assistant in radiology, completed one year of training in nuclear medicine and has accepted a position with the Valley Medical Center, Renton, Washington.

Marc G. Koenig, MD, assistant in radiology, completed four years of training in diagnostic radiology.

Joseph Krysl, MD, instructor in radiology, completed a one-year fellowship in vascular and interventional radiology and has accepted a position in the Department of Radiology at the University of Colorado Health Sciences Center, Denver.

John M. Lahorra, MD, assistant in radiology, completed one year of training in nuclear medicine and has accepted a position with Akron Radiology in Akron, Ohio.

Hamid R. Latifi, MD, assistant in radiology, completed four years of training in diagnostic radiology and one year of training in nuclear medicine. He has accepted a position with Akron Radiology, Akron, Ohio.

Bruce L. McClennan, MD, professor of radiology and chief of abdominal radiology, has accepted the position of professor and chairman of the Department of Diagnostic Radiology at Yale University School of Medicine, New Haven, Connecticut.

Charles T. McConnell, MD, instructor in radiology, completed a two-year fellowship in neuroradiology and has accepted a position with the Good Samaritan Hospital, Cincinnati, Ohio.

Allen B. Oser, MD, instructor in radiology and cochief resident, Division of Diagnostic Radiology, 1992-1993, completed a four-year diagnostic radiology residency and a two-year fellowship in neuroradiology. He has accepted a position in the Department of Radiology at the University of Alabama, Birmingham.

Rachel F. Oser, MD, instructor in radiology, completed a four-year diagnostic radiology residency and a one-year fellowship in vascular and interventional radiology. She has accepted a position in the Department of Radiology at the University of Alabama, Birmingham.

Shawn P. Quillin, MD, instructor in radiology, completed four years of training in diagnostic radiology and a one-year fellowship in abdominal radiology. He has entered private practice in Charlotte, North Carolina.

James V. Rawson, MD, instructor in radiology, completed a one-year fellowship in magnetic resonance imaging and has accepted a position with the Medical College of Georgia.

Cynthia K. Rigsby, MD, assistant in radiology and chief resident, Division of Diagnostic Radiology, 1994-1995, completed a four-year diagnostic radiology residency and has accepted a position with Children's Hospital Medical Center, Cincinnati, Ohio.

James W. Ryerson, MD, instructor in radiology, completed a one-year fellowship in pediatric radiology. He has accepted a position with St. John's Mercy Medical Center, Washington, Missouri.

Scott C. St. Amour, MD, assistant in radiology, completed four years of training in diagnostic radiology and one year of training in nuclear medicine. He has accepted a position with Sparrow Hospital, Lansing, Michigan.

THE DIRECTOR'S OFFICE REPORT

continued from page 21

David J. Scherer, MS, instructor in radiology, Division of Radiological Sciences.

Alan C. Schlesinger, MD, assistant professor of radiology, Division of Diagnostic Radiology.

Gerald L. Shaikun, MD, instructor in clinical radiology, Division of Diagnostic Radiology.

Gene W. Spector, MD, instructor in clinical radiology, Division of Diagnostic Radiology.

John A. Stahl, MD, assistant in radiology, completed four years of training in diagnostic radiology and has accepted a position with the Department of Radiology at Duke University, Durham, North Carolina.

James E. Stark, MD, assistant professor of radiology, Division of Diagnostic Radiology.

Keith M. Sterling, MD, instructor in radiology, completed a one-year fellowship in vascular and interventional radiology and has accepted a position with the Department of Radiology at Alexandria Hospital Center, Alexandria, Virginia.

Nitin Tanna, MD, instructor in radiology, completed four years of training in diagnostic radiology and a one-year fellowship in chest radiology.

Yvonne C. Taylor, PhD, assistant professor of radiology, Division of Radiological Sciences, has accepted a position with the U.S. Peace Corps as a secondary-education science teacher and teacher-trainer in the Harambee School System of Kenya.

David W. Tsai, MD, instructor in radiology, completed a one-year fellowship in musculoskeletal radiology and has accepted a position with Harborview Hospital, University of Washington Medical Center, Seattle.

Richard Valicenti, MD, instructor in radiology, completed three years of residency and a one-year fellowship in radiation oncology.

Elizabeth P. Vining, MD, instructor in radiology, completed a one-year fellowship in magnetic resonance imaging and has accepted a position with the Auburn Opelika Diagnostic Imaging Center, Auburn, Alabama.

Thomas H. Vreeland, MD, assistant in radiology, completed two years of training in nuclear medicine and has accepted a position with Tulane University, New Orleans, Louisiana.

Lei Zheng, PhD, research associate in radiology, Division of Radiological Sciences.

APPOINTMENTS/ELECTIONS

James A. Brink, MD, associate professor of radiology, was elected as a member of the Society of Computed Body Tomography and Magnetic Resonance.

Norman L. Hente, RT(R), was elected to a two-year term as the Management Chapter Delegate for Region 5 of The American Society of Radiologic Technologists (ASRT).

Scott A. Mirowitz, MD, associate professor of radiology and radiologist-in-chief at Jewish Hospital, was appointed as chair of the American College of Radiology's Magnetic Resonance Professional Self-Evaluation Test and Syllabus Committee. He also was appointed to the editorial board of *Academic Radiology*, the journal of the Association of University Radiologists.

Mitchell A. Miller, MD, instructor in radiology, was elected to the Alpha Omega Alpha honorary medical society.

Marilyn J. Siegel, MD, professor of radiology, is president-elect of the Society of Computed Body Tomography and Magnetic Resonance Imaging. She will take office in the year 2000.

Douglas R. Spitz, PhD, assistant professor of radiology, was appointed as a special reviewer for the NIH Review, Toxicology I study section, held June 14-16 in Bethesda, Maryland.

Robert G. Swanson, MD, assistant in radiology, was elected councilor of the Missouri State Medical Association - Resident Physician Section and was elected treasurer of the Missouri Delegation to the American Medical Association - Resident Physician Section.

Doctors **Eric R. Weidman** and **Farrell K. VanWagenen** were appointed 1995-1996 Diagnostic Radiology chief resident and cochief resident, respectively. In the Radiation Oncology Center, **Astrid E. Morrison, MD**, is the 1995-1996 chief resident and **Alfred Tinger, MD**, is assistant chief resident. The 1995-1996 Nuclear Medicine chief resident is **Michael C. Roarke, MD**.

O. Clark West, MD, assistant professor of radiology, was appointed as director of emergency and trauma radiology for the Washington University Medical Center. In collaboration with the departments of Medicine and Surgery, West will coordinate all radiological responsibilities related to emergency medicine and trauma surgery. As part of West's academic responsibilities, he will expand the MIR teaching and research program related to emergency medicine and trauma surgery and will develop an emergency and trauma radiology fellowship program.

Jeffrey F. Williamson, PhD, professor of radiology, was appointed associate editor of *International Journal of Radiation Oncology, Biology, and Physics*.

FELLOWSHIPS/ GRANTS

Thomas A. Bonasera, MA, research assistant in radiology, was one of 18 St. Louis-area residents who received Fulbright grants to study or teach abroad; 14 recipients were from Washington University. Bonasera, a doctoral candidate, will conduct research at Sweden's University of Uppsala on the application of the radiochemical Carbon-11 to the treatment of prostate cancer. The United States Congress established the Fulbright exchange program in 1946.

Thomas E. Conturo, MD, PhD, assistant professor of radiology, received a five-year NIH Clinical Investigator Award from the National Institutes of Neurological Disorders and Stroke. The \$395,064 award will fund the research project "MR Perfusion Imaging for Functional Brain Studies." Coinvestigators are **Marcus E. Raichle, MD**, professor of radiology and neurology; **William J. Powers, MD**, associate professor of radiology and neurology; **Michael J. Welch, PhD**, professor of radiology and chemistry; **Kenneth B. Larson, PhD**, research professor of neurology; **Daniel McKeel, MD**, associate professor of pathology; and **Joseph J. Ackerman, PhD**, professor of chemistry and radiology.

Raymond M. Hau, a Washington University graduate student, and **Thomas E. Conturo, MD, PhD**, assistant professor of radiology, as mentor, received a one-year Howard Hughes Medical Institutes Research Training

Fellowship. The \$24,500 award will fund the research project "Functional MRI."

Fidelma L. Flanagan, MD, assistant in radiology, received the 1995 Mallinckrodt Fellowship from the Society of Nuclear Medicine (SNM). The fellowship will allow Flanagan to expand her breast cancer research into the field of nuclear medicine. Flanagan also received a \$30,000 grant to investigate the use of positron emission tomography (PET) scans to monitor tamoxifen therapy in patients with breast cancer metastases. **Farrokh Dehdashti, MD**, assistant professor of radiology and the first recipient of the SNM's Mallinckrodt Fellowship, will serve as Flanagan's mentor.

David S. Gierada, MD, instructor in radiology, received a Seed Grant Award from the Radiological Society of North America's Research and Education Fund. The one-year grant will support research using 3-D magnetic resonance imaging to study changes in respiratory function following lung volume reduction surgery in patients with emphysema. The research team plans to use study results to help identify patients who would most benefit from the surgery. Coinvestigators are MIR's **Richard M. Slone, MD**; **Debiao Li, PhD**, and **Michael W. Vannier, MD**, and Joel D. Cooper, MD, from the Department of Surgery.

Eduardo G. Moros, PhD, assistant professor of radiology and chief of hyperthermia physics service, as principal investigator, received a five-year FIRST-R29 grant from the National Institutes of Health. The \$350,000 grant will fund the research project "Ultrasound Systems for Simultaneous Thermoradio-therapy." Coinvestigators are **Robert J. Myerson, MD, PhD**, associate professor of radiology; **William L. Straube, MS**, instructor in radiology; and **Eric E. Klein, MS**, assistant professor of radiology.

Marcus E. Raichle, MD, professor of neurology and radiology and codirector of the Division of Radiological Sciences, received a two-year grant from the Charles A. Dana Foundation. The \$965,000 grant will support the continuation of leadership training and research in the use of modern neuroscience imaging techniques.

Joseph L. Roti Roti, PhD, professor of radiology and chief of cancer biology, received a five-year grant from the National Cancer Institute. The \$1,082,506 grant will fund the research project "Nuclear Protein Content and Heat-Induced Cell Killing."

Peter E. Shile, MD, assistant professor of radiology, received the GE-AUR Radiology Research Academic Fellowship for his study and evaluation of digital display technologies in mammography. The two-year fellowship includes a \$50,000 annual stipend and is cosponsored by General Electric Medical Systems and the Association of University Radiologists.

HONORS/ AWARDS

K. Tyler Bae, MD, PhD, assistant in radiology, and coauthors Maryellen L. Giger, PhD, and Heber MacMahon, MD, received the 1995 Stauffer Award for their article "Computerized Detection of Pulmonary Nodules in Computed Tomography Images." The award is presented annually for the outstanding clinical article published in *Investigative Radiology*.

The American Institute of Ultrasound in Medicine (AIUM) presented the fourteenth annual Memorial Hall of Fame Award in honor of **G. Leland Melson, MD**, a professor of radiology and chief of MIR clinical ultrasound who died in November of 1992. **William D. Middleton, MD**, associate professor of radiology and head of ultrasound, presented the award to the Melson family at the AIUM annual meeting in San Francisco.

Joel S. Perlmutter, MD, associate professor of neurology and radiology, received a \$100,000 award from the Nettie and Rebecca Brown Foundation to further his research on Parkinson's disease.

Researchers from MIR's Division of Radiological Sciences received *The Journal of Nuclear Medicine*'s 1994 Manuscript Award for Overall Excellence. MIR's **Val-labhaneni V. Rao, PhD**, and **David R. Piwnica-Worms, MD, PhD**, and Harvard Medical School's Mary L. Chiu and James F. Kronauge, PhD, are authors of the prize-winning paper, "Expression of Recombinant

Human Multidrug Resistance P-Glycoprotein in Insect Cells Confers Decreased Accumulation of Technetium-99m-SESTAMIBI."

The award was presented at The Society of Nuclear Medicine's annual meeting in June, 1995.

Under the mentorship of **Douglas D. Robertson, MD, PhD**, assistant professor of radiology and surgery, Paul A. Scheet, a Washington University graduate student, was a co-recipient of the 1995 Marian Smith Spectator Award in Biology. Scheet's thesis, "The Application of Image Processing and Computer-aided Design for the Creation of an Electronic Anatomical Database for Analyses of Total Hip Replacements," was selected from work submitted by 18 honors biology graduates.

Richard M. Slone, MD, assistant professor of radiology, and coauthors **David S. Gierada, MD**, instructor in radiology; **Stuart S. Sagel, MD**, professor of radiology; **Harvey S. Glazer, MD**, professor of radiology; and **Joel S. Cooper, MD**, professor of surgery, received the Society of Computed Body Tomography *cum laude* award of \$2,500 for "Computed Tomography Assessment of Lung Volume Reduction Surgery Candidates." Slone also attended the Academic Faculty Development Program sponsored annually by Picker International, Inc. and the Association of University Radiologists. Forty attendees are selected from among hundreds of nominees, who are usually within the first five years of their faculty appointments. The program helps promising academic radiologists to develop important skills necessary for successful clinical, teaching, and research careers.

LECTURES/ PRESENTATIONS

Louis A. Gilula, MD, professor of radiology and chief of musculoskeletal radiology, presented "General Aspects of Conventional Arthrography," "Arthrography and CT Arthrography Shoulder," "Ligament Instabilities of Wrist: Overview and Basic Approach," "CT Wrist," "MRI Wrist," and "Percutaneous Bone Biopsy" at the Musculoskeletal Radiology Diagnostic Update meeting, Milan, Italy, June 23. As visiting professor, he lectured on "Analysis of Complex Carpal Trauma" at the University of Helsinki, Finland, July 3. Gilula organized the 11th International Wrist Investigators' Workshop and spoke on "Update on Wrist Imaging" at the International Federation of Societies of Surgery of the Hand, Helsinki, Finland, July 4.

Harvey S. Glazer, MD, professor of radiology, presented "CT of the Mediastinum" and "CT of Pulmonary Collapse" at the Society of Computed Body Tomography and Magnetic Resonance, New York City, New York, May 15 - 19.

Mary V. Graham, MD, assistant professor of radiology, spoke on "Nonsmall Cell Lung Cancer: Chemoradiation and Conformal Therapy" at the Gulf Coast Cancer Symposium, Biloxi, Mississippi, April 22. She presented "The Impact of New Simulation Techniques on the Clinical Process" at the Varian Users' Meeting, Orlando, Florida, May 15. Graham presented "Current and Future Radiotherapy for Nonsmall Cell Lung Cancer" at the American Society of Clinical Oncologists, Los Angeles, California, May 21 and 22, and at the Radiation Therapy Oncology Group meeting, Philadelphia, Pennsylvania, July 22.

Perry W. Grigsby, MD, MBA, professor of radiology and clinical chief of the Radiation Oncology Center, Barnes Hospital, spoke on "Current Issues in the Management of Endometrial Carcinoma" at the Chicago Radiological Society, Chicago, Illinois, April 27. He presented "Overview of the NIH Consensus Conference on Ovarian Cancer" at the Symposium on Gynecology and Gynecologic Oncology, Minneapolis, Minnesota, May 9. Grigsby lectured on "Dose

Prescription for Cervical Cancer" and "Adjuvant Radiotherapy for Endometrial Carcinoma" at Current Concepts in Radiation Therapy, Minneapolis, Minnesota, May 10. He spoke on "Carcinoma of the Endometrium - LDR" at the 4th International Brachytherapy & Remote Afterloading Symposium & Workshop, West Palm Beach, Florida, May 24 - 26. Grigsby presented "Clinical Trials in Gynecological Malignancies," "Treatment of Thyroid Carcinoma," "NIH Consensus Conference on Ovarian Carcinoma," "Management of Uterine Sarcoma," "Effects of Radiotherapy on Sexual Functions in Gynecological & Prostate Cancers," "Radiation Therapy for Cervical Cancers - Methods and Outcomes," and "Management of Carcinoma of the Endometrium" at the 7th Asian & Oceanian Congress of Radiology Meeting, Kuala Lumpur, Malaysia, May 28 - June 1.

Jay P. Heiken, MD, professor of radiology and chief of abdominal radiology, presented the 3M Lecture on "Spiral CT" and spoke on "CT and MR of the Aorta" and "CT/MR of Pelvic Malignancy" at the International London Course in Computed Tomography and Magnetic Resonance Imaging, Auchterarder, Scotland, April 9 - 13. As visiting professor, he presented the Grand Rounds Lecture on "CT and MR of the Aorta" at the University

of Pennsylvania, Philadelphia, April 25. Heiken participated in the "Liver Imaging Roundtable" and lectured on "Hepatic Lesion Detection with MRI" and "Contribution of MR to Evaluation of the Kidney" at the Eighteenth Annual Course of the Society of Computed Body Tomography and Magnetic Resonance, New York City, New York, May 15 - 19. As visiting professor, he spoke on "CT and MRI of the Aorta" at Brooke Army Medical, Milford Hall, University of Texas, San Antonio, May 31. Heiken participated in a workshop on "Virtual Colonoscopy" at the National Institutes of Health, Bethesda, Maryland, June 12.

Michel M. Ter-Pogossian, PhD, professor emeritus of radiology, received the first Peter H. Raven Lifetime Award presented by The Academy of Science of St. Louis. Presented to Ter-Pogossian for a distinguished career of service in science, the award "symbolizes the Academy's and Dr. Raven's commitment to seeking the truth through scientific discovery and its use for the betterment of humankind."

Jacqueline C. Hodge, MD, instructor in radiology, presented "MRI of the Shoulder and "MRI of the Knee" at the Radiological Society of Quito, Quito, Ecuador, April 11. She spoke on "MRI of the Shoulder" at Allgemeines Krankenhaus Altona, Hamburg, Germany, May 31.

Eric E. Klein, MS, assistant professor of radiology, as the 1994 American Association of Physicists in Medicine Travel Award recipient, spoke on "Dosimetry and Calculations of Tumors within Lung" at Sahlgrenska University Hospital, Goteborg, Sweden, June 6; "Electron Therapy with Multileaf Collimation" and "Dosimetry and Calculations of Tumors within Lung" at University Hospital, Lund, Sweden, June 8; "Dosimetry of Dynamic Wedge" and "Mono-Isocentric Treatment Techniques for Breast Cancer" at Malmo General Hospital, Malmo, Sweden, June 9; and "New Treatment Techniques for Breast Cancer" and "Development of Multileaf Collimation" at Karolinska Institute, Stockholm, Sweden, June 13.

Hsui-san Lin, MD, PhD, professor of radiology, as invited speaker, presented "Adaptation - A New Concept in Radiation Oncology" at the annual meeting of the Chinese Society for Therapeutic Radiology and Oncology, Taipei, Taiwan, March 18. He spoke on "Mononuclear Phagocytes as a Model for Cellular Differentiation and Activation" to the Department of Microbiology, National Taiwan University, Taipei, Taiwan, March 13. Lin presented "Hodgkin's Disease, Role of Radiation Therapy" to the Department of Radiation Oncology, National Chung-Kong University Hospital, Tainan, Taiwan, March 21. He lectured on

"The Role of Radiation Therapy in the Management of non-Hodgkin's Lymphoma" to the Department of Oncology, National Taiwan University, Taipei, Taiwan, March 23. Lin presented "Hodgkin's Disease" to the Department of Radiation Oncology, Cheng-Keng Medical College, Taipei, Taiwan, March 25.

Gary D. Luker, MD, instructor in radiology, presented "Ground-glass Attenuation in Pediatric Lung Disease: HRCT-pathologic Correlation" and "Testicular Sonography in Childhood: Comparison of Power versus Color Doppler US" at the Society for Pediatric Radiology meeting, Washington, DC, April 26 - 30. He spoke on "Hepatic Spiral CT in Children: Comparison of Contrast Media Injection Protocols" at the 18th Annual Course of the Society of Computed Body Tomography and Magnetic Resonance, New York City, New York, May 15 - 19.

Scott A. Mirowitz, MD, associate professor of radiology and radiologist-in-chief at Jewish Hospital, spoke on "Pitfalls in Shoulder MR" and "Pitfalls in Abdominal MR" at the Society of Computed Body Tomography.

LECTURES/ PRESENTATIONS

continued from page 25

Stephen M. Moerlein, PhD, associate professor of radiology, presented the poster "Non-internalization of N-methyl-[18F]benperidol: a PET Radioligand that Binds to Dopaminergic D2 Receptors with High Specificity and Reversibility" (coauthored with **Joel S. Perlmutter, MD**, associate professor of neurology and radiology) at the 17th International Symposium on Cerebral Blood Flow and Metabolism (Brain 95), Cologne, Germany, July 2 - 6.

Eduardo G. Moros, PhD, assistant professor of radiology and chief of hyperthermia physics service, presented "Simultaneous Thermoradiotherapy of Superficial Tumors: Physical Aspects and Clinical Experience" and "Quality Assurance Needs in Future Clinical Trials" at the 15th Annual Meeting of the North American Hyperthermia Society, San Jose, California, April 1 - 6. He spoke on "Simultaneous Ultrasound Hyperthermia and Ionizing Radiation" at The Conference for Ultrasonics in Biophysics and Bioengineering, University of Illinois-Urbana, May 30 - June 2.

Joel S. Perlmutter, MD, associate professor of neurology and radiology, presented "PET Investigations of Dystonia" and chaired the medical session for the Great Lakes Regional Symposium of the Dystonia Medical Research Foundation, St. Louis, Missouri, April 22. He chaired the "Movement Disorders: Neuroimaging" sessions at the American Academy of Neurology meeting, Seattle, Washington, May 9. Perlmutter spoke on "Parkinson's Disease: New and Emerging Therapies" as part of the Continuing Medical Education course at Jewish Hospital, St. Louis, Missouri, May 15. He presented the poster "Non-internalization of N-methyl-[18F]benperidol: a PET Radioligand that Binds to Dopaminergic D2 Receptors with High Specificity and Reversibility" (coauthored with **Stephen M. Moerlein, PhD**, associate professor of radiology and biochemistry) at the 17th International Symposium on Cerebral Blood Flow and Metabolism (Brain 95), Cologne, Germany, July 2 - 6.

Carlos A. Perez, MD, professor of radiology and director of the Radiation Oncology Center, spoke on "HDR/LDR Brachytherapy or Electron Beam Boost in Breast Conservation Therapy" and "LDR/HDR Brachytherapy: USA Experience in Cervical and Endometrial Cancers" at the International Brachytherapy Working Conference, Naples, Italy, April 7. He presented "Brachytherapy Overview" and "Carcinoma of the Cervix: Low Dose Rate" at the 4th International Brachytherapy and Remote Afterloading Symposium and Workshops, Palm Beach, Florida, May 27. Perez lectured on "Recent Strategies in Radiotherapy to Improve Quality of Life and Survival of Cancer Patients" and "Role of Radiation Oncology in Breast Conserving Treatment" at the Jakarta International Cancer Conference, Jakarta, Indonesia, May 30 and 31. He presented "Treatment Results with External Beam Radiotherapy" and "Pattern of Failure in Patients Treated with External Beam Radiotherapy" at Carcinoma of the Prostate: Innovations in Management, Brittany, France, July 10 and 11.

James A. Purdy, PhD, professor of radiology and associate director of the Radiation Oncology Center, as invited speaker, spoke on "Changing Roles and Responsibilities of Radiation Oncology Staff" at the Varian Users' Meeting, Orlando, Florida, May 14 - 18. As invited speaker, he presented "Update on Dose Escalation in Clinical Trials for Prostate Cancer" and "3D CRT PACS" at the Implementation of Emerging Technology in Radiation Oncology Symposium, Indian Wells, California, June 6 - 9. As invited speaker, Purdy spoke on "3D CRT Process" at the Varian CT-Sim Meeting, Colorado Springs, Colorado, June 22 and 23. As invited speaker, he presented "3D CRT - A New Era" at the Royal Beaumont Hospital Dedication, Royal Oak, Michigan, July 14 and 15.

Joseph L. Roti Roti, PhD, professor of radiology, associate director of the Radiation Oncology Center, and chief of cancer biology, spoke on "Mechanisms and Consequences of Nuclear Damage" at the Sporadic Inclusion Body Myositis and Familial Inclusion Body Myopathy IBM Workshop, Jupiter Beach, Florida, March 9 - 11.

Stuart S. Sagel, MD, professor of radiology and chief of chest radiology, presented "Mediastinum: Plain Chest Radiology, CT, and MRI" at the International Diagnostic Course on Imaging of Heart and Chest, Davos, Switzerland, April 1 - 8. He spoke on "CT of Focal Lung Lesions" at the 18th Annual Course of Society of Computed Body Tomography and Magnetic Resonance, New York City, New York, May 15 - 19. Sagel presented "Spiral CT of the Thorax," "CT of the Thorax: Anatomic Variants and Pitfalls," "CT of Focal Pulmonary Lesions," and "Chest Radiography: Low Tech to High Tech" at the Pitt Summer Imaging Course, Keystone, Colorado, June 19 - 23.

Barry A. Siegel, MD, professor of radiology and director of the Division of Nuclear Medicine, as visiting lecturer, spoke on "The Scintigraphic Evaluation of Pulmonary Embolism" at Providence Memorial Hospital and William Beaumont Army Medical Center, El Paso, Texas, March 16 and 17.

Marilyn J. Siegel, MD, professor of radiology, spoke on "Pediatric Retroperitoneum," "Pitfalls in CT/MR of the Pediatric Chest," "MR of Bone Marrow," and "CT/MR of the Pediatric Pelvis" at the International Course in Computed Tomography and Magnetic Resonance Imaging, Auchterarder, Scotland, April

9 - 13. As invited lecturer, she presented "Pediatric Mediastinum" at Walter Reed Army Medical Center, Washington, DC, April 28. As visiting professor, Siegel spoke on "Thymic Imaging" and "Ultrasonography of the Acute Pediatric Abdomen" at Emory University, Atlanta, Georgia, May 9 and 10. She presented "MRI of Hematopoietic Disease" and "Current Concepts in MRI of the Pediatric Abdomen" at the 18th Annual Course of the Society of Computed Body Tomography and Magnetic Resonance, New York City, New York, May 15 - 19. Siegel lectured on "Ultrasonography of Acute Abdominal Pain in Children," "Intracranial Hemorrhage and Ischemia," "Pediatric Musculoskeletal Ultrasonography," "What's New in Pediatric Renal Ultrasonography?," and "Pediatric Gynecologic Ultrasonography" at the Third Argentine Congress of Ultrasound, Buenos Aires, Argentina, June 17 - 20.

Joseph R. Simpson, MD, PhD, associate professor of radiology, presented "Voice Preservation and Complications in Combined Modality Treatment of the Piriform Sinus" at the Annual American Radium Society meeting, Paris, France, May 1.

Richard M. Slone, MD, assistant professor of radiology, presented "Pulmonary Emphysema and Radiologic Evaluation of Candidates for Lung Volume Reduction Surgery" at the Second Volume Reduction Seminar, St. Louis, Missouri, May 4. He spoke on "Radiologic Evaluation of Patients Undergoing Lung Volume Reduction Surgery" at the Third Volume Reduction Seminar, Paris, France, June 23.

Douglas R. Spitz, PhD, assistant professor of radiology, spoke on "Cellular Mechanisms of Resistance to Nitric Oxide-mediated Toxicity" at the Radiation Residents meeting, San Jose, California, April 3. He presented "Mammalian Cellular Mechanisms of Resistance to Oxidative Stress Mediated by H₂O₂, 95% O₂, and Nitric Oxide" to the Department of Chemistry and Biochemistry, University of Quebec, Montreal, Quebec, April 12. Spitz lectured on "Mechanisms of Cellular Adaptation to Oxidative Stress in Human Disease" at the Human Anatomy and Physiology Society meeting, St. Louis, Missouri, May 21.

Michael W. Vannier, MD, professor of radiology and chief of the image processing laboratory, as guest lecturer, spoke on "3D Anthropometry of the Human Body" at the Department of Radiology Research and Education Conferences, Medical College of Georgia, Georgia's Health Sciences University, Augusta, Georgia, March 29. He presented "3D Anthropometry of the Human Body" and participated in a panel discussion at the Biomedical Technology Opportunities Workshop, sponsored by the U.S. Department of Energy, Atlanta, Georgia, April 3 and 4. Vannier chaired the Three Dimensional Imaging and Planning Scientific Session and spoke on "Volumetric Head and Neck Imaging: State of the Art" at the Second International Meeting on Functional Surgery of the Head and Neck, Graz, Austria, May 11 - 13. He presented the Institute of Radiological Sciences Lecture: "3D Anthropometry" and spoke on "Volumetric Imaging of the Head and Neck" at the Techniques and Clinical Applications of Three Dimensional Imaging Conference, Mater Misericordiae Hospital, University College, Dublin, Ireland. Vannier co-organized the tutorial "Medical Workstations;" presented "Digital Atlas-based Segmentation of the Hippocampus," "Evaluation of Digital Surgical Simulation," "Craniofacial Surgical Simulation and Outcome Validation," and "Lower Limb Remnant Volumetry - Validation of Spiral CT and Optical Surface Scanning;" and chaired the Image Guided Therapy (IGT) committee at CAR '95, 9th International Symposium and Exhibition, Berlin, Germany, June 21 - 24.

LECTURES/ PRESENTATIONS

continued from page 27

Ge Wang, PhD, assistant professor of radiology, as invited speaker, presented "Feldkamp-type Cone-beam CT: Revisited," and chaired sessions on "Image Processing and Reconstruction I" and "Near-field and Other Microscopy II" at Focus on Microscopy '95: The 8th International Conference on 3D Image Processing in Microscopy and the 7th International Conference on Confocal Microscopy, Taipei, Taiwan, April 18 - 20.

Jeffrey F. Williamson, PhD, professor of radiology and chief of brachytherapy physics service, as invited speaker, presented "Regulatory and Safety Aspects of Remote Afterloading Brachytherapy" to the United States National Regulatory Commission Advisory Committee on Medical Use of Isotopes, Washington, DC, May 11.

Franz J. Wippold, MD, associate professor of radiology, presented "Temporal Bone Review" and "Paranasal Sinus" at the National Naval Medical Center, Bethesda, Maryland, May 8 and 10. He participated in the Neuroradiology Review Course at the National Naval Medical Center and the Walter Reed Medical Center, Bethesda, Maryland, May 15 - 19.

SYMPOSIA

THE AMERICAN ROENTGEN RAY SOCIETY

The following Mallinckrodt Institute staff members (highlighted in boldface type) participated in the 95th Annual Meeting of The American Roentgen Ray Society, Washington, DC, April 30 - May 5.

CATEGORICAL COURSE

Emergency Pediatric Radiology: A Problem-oriented Approach

Marilyn J. Siegel, MD, "Acute Gastrointestinal Bleeding."

INSTRUCTIONAL COURSES

Bruce L. McClennan, MD, chair.

Barbara S. Monsees, MD, "Screening Mammography."

Dennis M. Balfe, MD, "Retroperitoneal Spaces."

SCIENTIFIC SESSIONS

Dennis M. Balfe, MD, comoderator, Scientific Session 21: "Pancreatic/Spleen I."

Ronald G. Evens, MD, moderator, Scientific Session 25: "Education/Administration/Quality Assurance."

Bruce L. McClennan, MD, moderator, Scientific Session 6: "Prostate."

Barbara S. Monsees, MD, comoderator, Scientific Session 18: "Breast - New Techniques."

Ece I. Akduman, MD; Jeffrey J. Brown, MD; Kevin L. Shady, MD; Patrick D. Datoc, MD; Thomas K. Pilgram, PhD, "Comparison of Conventional Spin Echo MR Imaging with Dynamic Contrast-enhanced Imaging for Characterizing Focal Liver Lesions."

K. Tyler Bae, MD, PhD; Richard M. Slone, MD; Roger D. Yusen, MD*; Joel D. Cooper, MD*, "Quantitative CT Evaluation and Pulmonary Function Test Correlation of Emphysema in Volume Reduction Surgery Patients." *Washington University School of Medicine, St. Louis, Missouri.

K. Tyler Bae, MD, PhD; Jay P. Heiken, MD; Sharlene A. Teefey, MD, "Diagnosis of Hepatic Hemangioma: A Reassessment of CT Using Revised Criteria."

Anthony M. Foti, MD; James E. Stark, MD; Marilyn J. Siegel, MD, "Organ Invasion by Retroperitoneal Neoplasms in Children: CT Signs."

Joseph Krysl, MD; Thomas M. Vesely, MD; Lawrence S. Kaskowitz, BA*, "Iliac Stent Technical Problems." *Washington University School of Medicine, St. Louis, Missouri.

Gary D. Luker, MD; Marilyn J. Siegel, MD, "Ovarian Sonography in Children: Value of Power Doppler Sonography."

Gary D. Luker, MD; Marilyn J. Siegel, MD, "High Resolution Chest CT and Pathologic Correlation in Cystic Fibrosis: Identification of Acute vs. Chronic Disease."

Kevin W. McEnery, MD; Steven S. Winn, MD; William G. Totty, MD; Mara Lang*; **Lucky K. Kelley, BA***, "Utilization of Mosaic Software as an Interface to Radiology Instructional Resources." *Washington University School of Medicine, St. Louis, Missouri.

Shawn P. Quillin, MD; James A. Brink, MD; Cary L. Siegel, MD; Jay P. Heiken, MD; Bruce L. McClennan, MD; Ralph V. Clayman, MD*, "Spiral CT Angiography: Detection of Crossing Vessels at the Ureteropelvic Junction." *Washington University School of Medicine, St. Louis, Missouri.

Alan E. Schlesinger, MD; Gary D. Shackelford, MD; Nancy D. Bridges, MD*, "Plain Radiographic Findings in Children with Congenital Heart Disease: Roentgen Classics." *St. Louis Children's Hospital, St. Louis, Missouri.

Richard M. Slone, MD; David S. Gierada, MD; Roger D. Yusen, MD*; **Joel D. Cooper, MD***; **K. Tyler Bae, MD, PhD; Thomas K. Pilgram, PhD; Stuart S. Sagel, MD**, "Postoperative Improvement Following Lung Volume Reduction Surgery." *Washington University School of Medicine, St. Louis, Missouri.

Richard M. Slone, MD; Walter Huda, PhD*; **Cliff J. Belden, MD***; **Carol K. Palmer, RT***, "Radiographic Mottle in Computed Radiography Chest Examinations." *Shands Hospital, University of Florida, Gainesville.

Richard M. Slone, MD; David S. Gierada, MD; Roger D. Yusen, MD*; **K. Tyler Bae, MD, PhD; Joel D. Cooper, MD***, "Lung Volume Reduction Surgery." *Washington University School of Medicine, St. Louis, Missouri.

Keith M. Sterling, MD; Michael D. Darcy, MD, "Transjugular Intrahepatic Portosystemic Shunt Stenosis: Incidence and Management."

Sharlene A. Teefey, MD; James A. Brink, MD; Rachel A. Borson, MD*; **William D. Middleton, MD**, "Hepatic Doppler: Not a Predictor of Venous-occlusive Disease of the Liver in Bone Marrow Transplant Patients." *Washington University School of Medicine, St. Louis, Missouri.

Eric R. Wiedman, MD; Anthony H. Wilson, MB, ChB*; **O. Clark West, MD**, "Gunshot Injuries in an Urban Emergency Department." *Harborview Hospital, University of Washington Medical Center, Seattle.

Anthony J. Wilson, MB, ChB*; **Jacqueline C. Hodge, MD; Thomas K. Pilgram, PhD; Edith H. Kang, MD****; **William A. Murphy, MD*****, "The Incidence of Residual Red Marrow Around the Knee Joint in Adults As Demonstrated on Magnetic Resonance Imaging." *Harborview Hospital, University of Washington Medical Center, Seattle. **Ramsey Clinic, St. Paul, Minnesota. ***M.D. Anderson Cancer Center, Houston, Texas.

Franz J. Wippold, MD; J. G. Smirniotopoulos, MD*; **Christopher J. Moran, MD; J. N. Soujanen, MD****, "Myxopapillary Ependymoma: MR Features." *F. Edward Ahabert School of Uniform Services, University of the Health Sciences, Bethesda, Maryland, and Armed Forces Institute, Washington, DC. **New England Deaconess Hospital, Harvard Medical School, Cambridge, Massachusetts..

Zhiyun Y. Yang, MD; Carolyn A. Haerr, MD*; **Frederick A. Mann, MD****; **Louis A. Gilula, MD**, "Scaphoid-Pisocapitate (SPC) Relationship, a New Criterion to Establish a Lateral Position of the Carpus." *Colorado Kaiser Permanente, Denver, Colorado. **Harborview Hospital, University of Washington Medical Center, Seattle.

Yuming Yin, MD; Bradley A. Evanoff, MD, MPh*; **Louis A. Gilula, MD; Thomas K. Pilgram, PhD; Anthony J. Wilson, MB, ChB****, "Can Selective Injection of Asymptomatic Wrist Compartments Reveal Symmetric Communicating Defects in Wrist Arthrography?" *Washington University School of Medicine, St. Louis, Missouri. **Harborview Hospital, University of Washington Medical Center, Seattle.

SYMPOSIA

continued from page 29

THE SOCIETY OF NUCLEAR MEDICINE ANNUAL MEETING

The following Mallinckrodt Institute staff members (highlighted in boldface type) participated in the 42nd Annual Meeting of The Society of Nuclear Medicine, Minneapolis, June 11 - 15.

SCIENTIFIC PAPERS

Carolyn J. Anderson, PhD, comoderator, Session 85, "Radiopharmaceutical Chemistry: Preclinical Studies II."

Farrokh Dehdashti, MD, comoderator, Session 57, "Oncology Nonantibody: Breast Cancer."

Robert J. Gropler, MD, comoderator, Session 25, "Cardiovascular Clinical: PET Myocardial Perfusion."

Tom Miller, MD, PhD, comoderator, Session 7, "Instrumentation and Data Analysis: Clinical SPECT."

Stephen M. Moerlein, PhD, comoderator, Session 52, "Neuroscience Basic: Activation."

David R. Piwnica-Worms, MD, PhD, moderator, Session 89, "Oncology Nonantibody: Therapeutic Response."

Sally W. Schwarz, RPh, MS, comoderator, Session 55, "Radiopharmaceutical Chemistry: Radiopharmacy."

Jerold W. Wallis, MD, moderator, Session 34, "Instrumentation and Data Analysis: SPECT Attenuation Correction."
Carolyn J. Anderson, PhD; Elizabeth L. C. Sherman, medical research technician; Margaret V. Lanan, senior medical research technician; W. Barry Edwards, MS; Tammy S. Pajeau, MS; Michael J. Welch, PhD, "Biodistribution in a Tumor-bearing Animal Model and Metabolism of Two Cu-64-labeled Octreotide Conjugates."

Yearn S. Choe, PhD*; Pelle J. Lidstrom, PhD*; **Thomas A. Bonasera, MA**; D. Yuron Chi, PhD*; Karen S. Kirschbaum, BA*; **Michael J. Welch, PhD**; John A. Katzenellenbogen, PhD*, "Bromo-[F-18]Fluorination: A Radiofluorination Method Applied to the Synthesis of 11 β -[F-18]Fluoroandrogens and 6 α -[F-18]Fluoroprogesterins." *University of Illinois, Urbana.

Judith M. Connett, PhD*; Li W. Guo, MS*; **Carolyn J. Anderson, PhD; Sally W. Schwarz, RPh, MS**; Kurt R. Zinn, DVM, PhD**; Gordon W. Philpott, MD*; **Michael J. Welch, PhD**, "In Vivo Toxicity and Long-term Radioimmunotherapy Studies of Cu-64 and Cu-67 Anti-Colon Carcinoma Monoclonal Antibody (MAb)-1A3 in the GW39-Hamster Model."

*Washington University School of Medicine, St. Louis, Missouri. **University of Missouri, Columbia.

Carolyn L. Crankshaw, AM; Mary Marmion, PhD*; B. Daniel Burleigh, PhD*; **Edward A. Deutsch, MD; David R. Piwnica-Worms, MD, PhD**, "Non-reducible Mixed Ligand Tc(III) Cations (Q Complexes) Are Recognized as Transport Substrates by the Human Multidrug Resistance (MDR) P-Glycoprotein." *Mallinckrodt Medical, Inc., St. Louis, Missouri.

P. Duffy Cutler, PhD; Ming Xu, MS, "Strategies to Improve 3D Whole Body PET Image Reconstruction."

Jeffrey A. Dobkin, MD; Ming Xu, MS; Hamid Latifi, MD; Farrokh Dehdashti, MD; Barry A. Siegel, MD; P. Duffy Cutler, PhD, "Initial Clinical Results with Segmented Transmission Images for Attenuation Correction of Whole-body PET."

Karen S. Kirschbaum, BA*; **Thomas A. Bonasera, MA**; Brad O. Buckman, BS*; **Michael J. Welch, PhD**; John A. Katzenellenbogen, PhD*, "[F-18]Progesterins: Synthesis and Tissue Distribution of 21-Fluoroprogesterin-16 α , 17 α -Furan Ketals and Acetals: Potential Breast Tumor Imaging Agents." *University of Illinois, Urbana.

Timothy J. McCarthy, PhD; Elizabeth L. C. Sherman, medical research technician; Karen Seibert, PhD*; Peter C. Isakson, PhD*; John J. Talley, PhD*; "Radiosynthesis, Biodistribution and PET Imaging of Potent and Selective Inhibitors of Cyclooxygenase-1 and Cyclooxygenase-2." *Searle Research & Development, Monsanto Company, St. Louis, Missouri.

Stephen M. Moerlein, PhD; Joel S. Perlmutter, MD; Michael J. Welch, PhD, "D₂ Binding by N-methyl-[F18]benperidol Is Unaffected by Endogenous Dopamine."

Gordon W. Philpott, MD*; **Farrokh Dehdashti, MD; Sally W. Schwarz, RPh, MS;** Judith M. Connett, PhD*; **Carolyn J. Anderson, PhD;** Kurt R. Zinn, DVM, PhD**; **P. Duffy Cutler, PhD; Michael J. Welch, PhD; Barry Siegel, MD,** "Radioimmunopet (MAb 1A3) Fragments [F(ab')₂] in Patients with Colorectal Cancers." *Washington University School of Medicine, St. Louis, Missouri. **University of Missouri, Columbia.

Patricia J. Rubin, MD; Kenneth B. Schechtman, PhD*; Edward M. Geltman, MD*; **Steven R. Bergmann, MD, PhD; Robert J. Gropler, MD,** "Preservation of Myocardial Oxygen Consumption Identifies Viable Myocardium Independently of Measurements of Flow or Glucose Metabolism." *Washington University School of Medicine, St. Louis, Missouri.

Michael J. Welch, PhD; Thomas A. Bonasera, MA; Elizabeth L. C. Sherman, medical research technician; John A. Katzenellenbogen, PhD*; **Farrokh Dehdashti, MD; Barry A. Siegel, MD,** "[F-18]Fluorodeoxyglucose (FDG) and 16 α -[F-18]Fluoroestradiol-17 β (FES)-Rich Tissues Following Tamoxifen Treatment: A Preclinical Study." *University of Illinois, Urbana.

Ming Xu, MS; P. Duffy Cutler, PhD, "Evaluation of Adaptive PET Whole-body Segmented Attenuation Correction."

POSTER SESSIONS
Carolyn J. Anderson, PhD; Judith M. Connett, PhD*; **Sally W. Schwarz, RPh, MS;** Li W. Guo, MS*; Mary L. Baumann, BA*; Kurt R. Zinn, DVM, PhD**; **Michael J. Welch, PhD,** "Comparison of Radioimmunotherapy (RIT) in Colorectal Tumor-bearing Hamsters with Cu-64 and Cu-67-labeled MAb 1A3." *Washington University School of Medicine, St. Louis, Missouri. **University of Missouri, Columbia.

Timothy J. McCarthy, PhD; Carmen S. Dence, MS; Sandra W. Holmberg, medical research technologist*; Ayoub Y. Elnatsheh, medical research technician*; Daniel P. Schuster, MD*; **Michael J. Welch, PhD,** "The Biological Fate of Inhaled [N-13]Nitric Oxide as Compared to Inhaled [N-13]Nitrogen Measured by PET." *Washington University School of Medicine, St. Louis, Missouri.

Stephen M. Moerlein, PhD; Joel S. Perlmutter, MD; Melissa M. Anderson, BS*; Michael E. Cristel, senior medical research technician; Mary T. Stephenson, medical research technician; **Michael J. Welch, PhD,** "Metabolism in vitro of F-18 Labeled Benperidol Derivatives by Isolated Rat Hepatocytes." *Washington University, St. Louis, Missouri.

Stephen M. Moerlein, PhD; Gregory G. Gaehle, BS; James L. Bockhorst, BS; **Michael J. Welch, PhD,** "Robotic Compounding of Acetate C-11 Injection for Clinical PET."

Sally W. Schwarz, RPh, MS; P. Duffy Cutler, PhD; John O. Eichling, PhD; Carolyn J. Anderson, PhD; Judith M. Connett, PhD*; Li W. Guo, MS*; Gordon W. Philpott, MD*; **Barry A. Siegel, MD; Michael J. Welch, MD,** "Tumor Dosimetry for Cu-64 and Cu-67-Labeled MAb 1A3 for Radioimmunotherapy." *Washington University School of Medicine, St. Louis, Missouri.

Jerold W. Wallis, MD, "Use of the Selective Linogram for Correction of Patient Motion in Cardiac SPECT."

SCIENTIFIC EXHIBITS

David E. Reichert, PhD; Timothy J. McCarthy, PhD; Michael J. Welch, PhD; Robert D. Hancock, PhD*, "Molecular Modeling for the Design of Metal Based Diagnostic Agents." *University of the Witwatersrand, Johannesburg, South Africa.

Jerold W. Wallis, MD; Mitchell A. Miller, MD; Tom R. Miller, MD, PhD; Thomas H. Vreeland, MD, "An Internet-based Nuclear Medicine Teaching File."

CATEGORICAL SEMINARS

Steven R. Bergmann, MD, PhD, "Clinical Application of Myocardial Blood Flow Quantitation with Oxygen-15-Water."

TECHNOLOGIST SECTION

Mickey Clarke, CNMT, chair, Scientific and Teaching Sessions Committee.

Deborah A. Garrison-Delano, RN; Patricia J. Rubin, MD; Theron R. Baird, electronic technician; **Robert J. Gropler, MD,** "Optimization of Oral Glucose Loading Regimen for Myocardial Imaging with Fluorine-18-Fluorodeoxyglucose."

ALUMNI NEWS

Michael D. Ward, RT, MED, FASRT, an MIR chief technologist from 1987 to 1992, received his PhD in education from Washington University on May 20. A 1976 graduate of the Washington University School of Radiologic Technology at Mallinckrodt Institute of Radiology, Ward is now quality assurance manager and director of technical education for the BJC Health System Department of Radiology, St. Louis, Missouri.

FYI

CALENDAR

The Twenty-fourth Annual Wendell G. Scott Memorial Lecture
St. Louis, Missouri
October 2

American Society for Therapeutic Radiology and Oncology
Miami, Florida
October 9 - 13

The Fourth Annual Leonard J. Tolmach Memorial Lecture and 11th MIR-ROC Radiation and Biological Sciences Symposium
St. Louis, Missouri
November 3

Brachytherapy Training Course
International Atomic Energy Agency
Mexico City, Mexico
November 6 - 17

Roentgen Centenary Congress
Hong Kong
November 8 - 12

The Society of Neuroscience
San Diego, California
November 11 - 16

The American Society of Mechanical Engineers Annual Meeting
San Francisco, California
November 12 - 17

The Tenth Annual Daniel R. Biello Memorial Lecture
St. Louis, Missouri
November 13

Radiological Society of North America Annual Meeting
Chicago, Illinois
November 26 - December 1

The Third Annual G. Leland Melson Visiting Professorship and Lecture
St. Louis, Missouri
December 11



Residents, trainees, and fellows for 1994-1995: (front row, left to right) Doctors Tyler Bae; Scott Beasley; Anthony Zelazny; Tinko Zlatev; Mary Alderman; Charles McConnell; Jonathan Gurney; David Hillier; Scott St. Amour; Michele Semin; Gary Luker; Dayne Hassell; Donald Heck; Donald Frei; (second row, left to right) John Catasca; Gregory Hatfield; Neda Yagan; John Stahl; Valerie Reichert; Mitchell Miller; Dennis Balfe, director, diagnostic radiology residency program; Farrel VanWagenen; Cynthia Rigsby, chief resident, diagnostic radiology; Ronald Evens, director, Mallinckrodt Institute; Sean Muldowney, cochief resident, diagnostic radiology; Eric Weidman; Gilbert Jost, chief, Division of Diagnostic Radiology; Debra Lau; John Butman; Kurt Simpson; John Carico; Gregory Cizek; John Neil; (third row, left to right) Mark Fromke; James Farn; Marc Koenig; Stephanie Hiskes; Paul Guillerman; John Felker; Alan McDaniel; Peter Salazar; Nitin Tanna; Andrew Fisher; Matthew Fleishman; Robert Kanterman; Jeffrey Friedland; Allen Oser; Scott Kaltman; Kevin Berger; Francis Schlueter; Kim Baker; Thomas Farrell; Sandy Ruhs; Anthony Foti; John Lahorra; Michael Roarke; Scott Werden; Gavin Slethaug; Colin Derdeyn; (back row, left to right) Martin Anbari; John Healey; John Sunderland; Shepherd Abrams; John Leahy; Edward Angtuaco; Eric Malden; Rory Satterfield; Hamid Latifi; David Youmans; Shawn Quillin; Steven Winn; Thomas Vaughan; Robert McKinstry; Stephen Hatem.

Not pictured: Doctors Joseph Bargellini; Michael Beat; Higinia Cardenes; Barry Chandler; Constance Courtois; Gopal Desai; Richard Edelstein; Thomas Farmer; Fidelma Flanagan; John Freeby; Jeff Geohaus; David Gius; William James; Howard Josefberg; Daniel Keleti, chief resident, radiation oncology; David Kim; Virginia Klaas; Joseph Krsyl; Astrid Morrison, cochief resident, radiation oncology; Rachel Oser; Steven Roth; Robert Ryerson; Felix Song; Lloyd Stambaugh; Keith Sterling; Avinash Sud; Robert Swanson; Alfred Tinger; Richard Valicenti; Elizabeth Vining; Thomas Vreeland; Richard Wagman; Jennie Yoon.

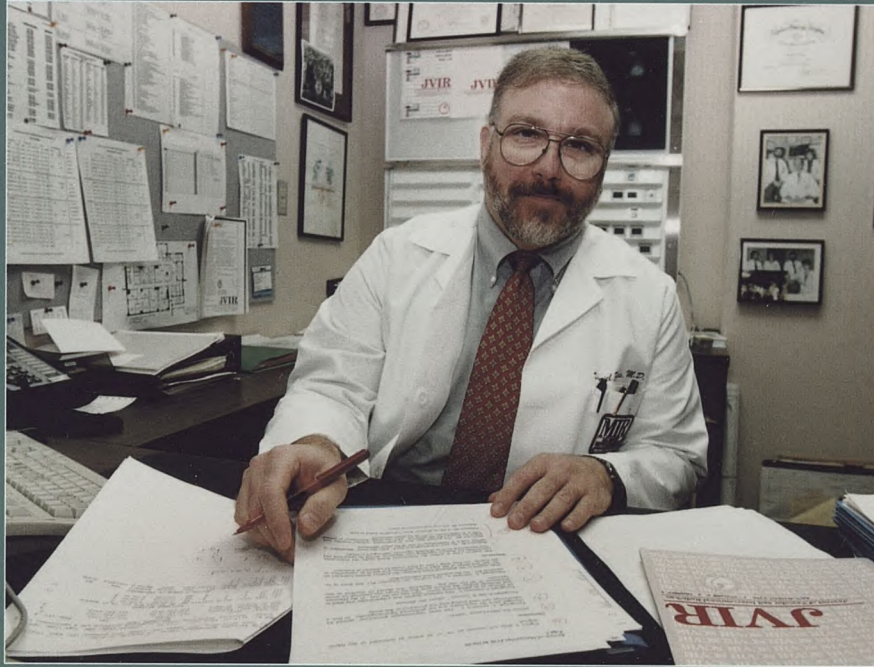

The St. Louis editorial office of *The Journal of Vascular and Interventional Radiology (JVIR)* is now officially located at the Institute with Daniel Picus, MD, chief of vascular and interventional radiology, as editor-in-chief. With a circulation of more than 4,000, JVIR is owned and published by the Society of Cardiovascular and Interventional Radiology. Annually, more than 400 manuscripts are submitted to the journal for review by 300 peer reviewers nationwide. Picus and editorial assistant Susan Wells produced their first issue of JVIR in July of this year.

FOCAL SPOT

MALLINCKRODT INSTITUTE OF RADIOLOGY

Administrator
Planning, Marketing and
Public Relations
Virginia Trent

Editor and Writer
Vicki Kunkler

Design
Purviance & Company
Marketing Communications

Contributing Writer
Candace O'Connor

Photographers
Norman Hente
Thomas Murry
Tim Parker
Michelle Wynn

Focal Spot magazine is published three times a year by the Mallinckrodt Institute of Radiology at the Washington University Medical Center at 510 South Kingshighway, St. Louis, MO 63110.

Permission is granted to reproduce articles contained herein, provided *Focal Spot* magazine of the Mallinckrodt Institute of Radiology at the Washington University Medical Center is credited.

Public Relations Department
Mallinckrodt Institute
of Radiology
510 South Kingshighway
St. Louis, MO 63110
(314) 362-2866

© Mallinckrodt Institute of
Radiology, 1995

Address Correction Requested

Non-Profit Organization
U.S. Postage
PAID
St. Louis, Missouri
Permit No. 3309

