

# ➤ Centre for Automotive Safety Research

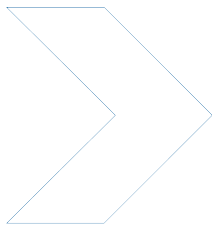

## Headform impact test performance of vehicles under the GTR on pedestrian safety

DJ Searson, RWG Anderson, G Ponte, AL van den Berg

CASR REPORT SERIES

CASR072

December 2009



# Report documentation

---

REPORT NO	DATE	PAGES	ISBN	ISSN
CASR072	December 2009	36	978 1 921645 09 9	1449-2237

## TITLE

Headform impact test performance of vehicles under the GTR on pedestrian safety

## AUTHORS

DJ Searson, RWG Anderson, G Ponte, AL van den Berg

## PERFORMING ORGANISATION

Centre for Automotive Safety Research  
The University of Adelaide  
South Australia 5005  
AUSTRALIA

## SUPPORTED BY

Department of Infrastructure, Transport, Regional Development and Local Government  
GPO Box 594  
Canberra  
ACT 2601

## AVAILABLE FROM

Centre for Automotive Safety Research  
<http://casr.adelaide.edu.au/reports>

## ABSTRACT

A Global Technical Regulation (GTR) on pedestrian safety is currently in its final draft stages, and may be adopted in Australia as an Australian Design Rule. Currently, selected new vehicles are tested by the Australasian New Car Assessment Program (ANCAP) for pedestrian protection; the GTR testing procedure is similar, but has different test conditions. The goal of this study was to estimate how many vehicles tested by ANCAP might be expected to pass the headform testing requirements of the GTR based on the vehicles ANCAP performance. Initially, three popular vehicles were tested to the specifications of the GTR. The resulting data was used to validate a theoretical relationship that predicts the change in Head Injury Criterion (HIC) for a given change in headform mass and impact speed. This relationship was used to predict the best-case and worst-case results for 60 vehicles previously tested by ANCAP, 33 of which are current models. The results indicate that a relatively small number of vehicles would be expected to unequivocally pass the GTR requirements, however many more may pass with little to no modifications.

## KEYWORDS

Global Technical Regulation, Pedestrian Protection, Safety Testing

## Summary

---

The primary goal of this study was to evaluate how many vehicles tested by the Australasian New Car Assessment Program (ANCAP) would be expected to pass the upcoming Global Technical Regulation (GTR) on pedestrian safety. The GTR is currently in the late draft stage, and may be adopted in Australia as an Australian Design Rule under the UNECE 1998 Agreement.

The GTR pedestrian testing procedure is similar to the ANCAP pedestrian testing procedure, but with a lower head impact speed and different child and adult headform masses. The GTR specifies a series of legform and headform tests, however this study only considered the headform testing component of the procedure.

Initially, three vehicles were tested according to the child headform component of GTR protocol. The three vehicles tested were a Holden Commodore, Toyota Camry and Mazda3. The Holden Commodore and Toyota Camry failed the GTR child head testing requirements, due to several tests that exceeded the maximum allowable Head Injury Criterion (HIC). The Mazda3 passed the GTR child head testing requirements.

The results of this testing, and further additional testing at locations previously tested by ANCAP, were then used to verify a theoretical relationship between the HIC values obtained under different test conditions (mass and speed). The theoretical relationship was developed using a simple linear mass-spring model. The results obtained from the testing were used in a linear regression, the results of which confirmed the theoretical model.

This theoretical relationship was used to estimate the performance of 60 vehicles previously tested by ANCAP. The relationship provided a means of scaling an ANCAP test, the scaled result being an estimate of the test structure's performance in the equivalent GTR test. For each vehicle, a best-case and worst-case estimate was made of the performance against the three criteria specified in the GTR. These criteria were (a) that no more than 1/3 of the total test area may exceed a HIC of 1000, (b) no more than 1/2 of the child test area may exceed a HIC of 1000, and that (c) no test may exceed a HIC of 1700.

A total of 7 vehicles were estimated to pass all three requirements in both the worst-case and best-case estimations. A further 11 vehicles only failed the requirement that the HIC cannot exceed 1700, and only in the worst case estimate of their performance – it is probable that these vehicles would pass the GTR with little or no modification. A total of 32 vehicles, or roughly 50% of those considered, were estimated to exceed a HIC of 1700 in at least one location.

Of the 60 vehicle models examined, 33 were current as of November 2009, and these were found to perform better on average than vehicles that are now obsolete. Six current models were estimated to pass the requirements of the GTR, and nine only failed the requirement of the HIC not exceeding 1700, and only in the worst case estimate. A total of 15 vehicles, or roughly 50% again, failed the requirement of the HIC not exceeding 1700 in any location, in both the worst case and best case estimates.

Given these results, it might be expected that a reasonable portion, about half, of current vehicle models would pass the GTR, with little to no modification. The remainder would probably require more significant design changes in order to pass the requirements. The predominant reason for failure of any vehicle was exceeding the maximum HIC of 1700, which would mean that compliance with the GTR would reduce the impact severity with the most dangerous locations on those vehicles that currently fail.

# Contents

---

- 1 Background .....1
  - 1.1 Overview .....1
  - 1.2 Comparison of the ANCAP and GTR test protocols .....1
  - 1.3 Objectives of the study .....4
- 2 Child headform testing on three vehicles to the GTR test specifications .....5
  - 2.1 Overview .....5
  - 2.2 Test method .....5
    - 2.2.1 Vehicle marking and points selection .....5
    - 2.2.2 Test procedure .....6
  - 2.3 Test results .....6
    - 2.3.1 Toyota Camry (2006) .....7
    - 2.3.2 Holden Commodore (2006) .....8
    - 2.3.3 Mazda3 (2004) .....9
  - 2.4 Comparison with ANCAP results .....10
- 3 Method for scaling the Head Injury Criterion (HIC) .....12
  - 3.1 Linear mass and spring model .....12
  - 3.2 Validation method .....13
  - 3.3 Validation results .....14
  - 3.4 Expected changes in HIC between ANCAP and the GTR .....16
- 4 Analysis of vehicles tested by ANCAP .....17
  - 4.1 Data source .....17
  - 4.2 Method for estimating results for each vehicle .....17
  - 4.3 Results .....19
- 5 Discussion .....28
  - 5.1 Sources of error in the evaluation of vehicle models previously tested by ANCAP .....28
  - 5.2 Conclusion .....29
- References .....32

# 1 Background

---

## 1.1 Overview

Pedestrian impact testing is used to assess the relative level of protection provided by a vehicle to a pedestrian in the case of a collision. The testing is conducted on a stationary vehicle, and various 'sub-system' impactors representing the head and lower extremities of a pedestrian are fired into specific locations on the vehicle. Data recorded from these impactors is used to assess the relative level of protection.

For the last 10 years, the Australasian New Car Assessment Program (ANCAP) has tested and assessed selected new vehicles for pedestrian safety, and assigned them a star rating. ANCAP assesses vehicles using the EuroNCAP pedestrian testing protocol (EuroNCAP 2009). The testing protocol specifies four different impactors, which are used to test different locations on the vehicle. A full-leg impactor is used on the bumper, an upper leg impactor on the leading edge of the bonnet and child and adult headform impactors are used on the bonnet top and windscreen areas. This testing has taken place at the Centre for Automotive Safety Research impact laboratory in Adelaide, and has included the assessment of over 100 vehicles to date.

In recent years, new regulations have been introduced in Europe and Japan that require all new vehicle designs to be tested for pedestrian safety (McLean 2005). Additionally, the Working Group on Passive Safety under the United Nations Economic Commission for Europe (UNECE) has drafted a Global Technical Regulation (GTR) on pedestrian protection (UNECE 2009). Australia is a signatory to the UNECE 1998 Agreement on Global Technical Regulations (UNECE 1998) and as such, the GTR on pedestrian protection may be adopted as an Australian Design Rule (ADR) under this agreement.

## 1.2 Comparison of the ANCAP and GTR test protocols

Given the foregoing, there are two pedestrian testing protocols which are relevant to Australia – the Euro NCAP testing protocol used by ANCAP, and the GTR testing protocol. In the case of the full leg tests, the ANCAP and GTR protocols are almost identical; however the GTR does not include an upper leg test. Both protocols require headform tests, which involve firing an instrumented headform into specific locations on the vehicle front surface. Depending on the wrap around distance (WAD) to each location, either a 'child' or 'adult' headform is used. The WAD is the distance measured to a test location from the ground at the front of the vehicle along the vehicle surface.

The acceleration of the headform measured during the impact is used to calculate the Head Injury Criterion (HIC), a number which represents the relative risk of head injury. The equation for calculating HIC is derived from the Wayne-State tolerance curve for head impacts (Versace 1971), and is based on the premise that the risk of head injury increases with the duration and magnitude of the acceleration experienced by the head. A HIC of 1000 is commonly used as an acceptable limit.

There are differences in the specifications and requirements of the tests under each protocol. These differences are summarised in Table 1.1, and are explained in further detail below.

Table 1.1  
Summary of differences between ANCAP and the GTR

Parameter	ANCAP	GTR
Test speed	40 km/h	35 km/h
Child headform mass	2.5 kg	3.5 kg
Adult headform mass	4.8 kg	4.5 kg
Child test area	WAD 1000 – 1500 mm	WAD 1000 – 1700 mm
Adult test area	WAD 1500 – 2100 mm (may include windscreen)	WAD 1700 – 2100 mm (excludes windscreen)
HIC requirements	HIC < 1000 scores maximum points HIC > 1350 scores zero points 1000 < HIC < 1350 scores partial points	HIC < 1000 to pass anywhere HIC < 1700 to pass in 'relaxation' zone (see text for definition)

For ANCAP testing, the child and adult test areas are each split into six numbered zones across the width of the test area. Each zone is then split into four smaller subzones, lettered A to D (see Figure 1.1). Within each zone, ANCAP selects what is thought to be the most potentially harmful test location. The vehicle manufacturer is then given the option to nominate one or more of the subzones in each zone for an additional test. ANCAP then selects the worst location in the nominated subzones. For example – if the most harmful location is chosen in subzone A, the manufacturer might choose subzones C and D for an additional test. The most harmful location might then be chosen in subzone C for the additional test. The advantage for the manufacturer is that the location in subzone C would be expected to perform better than the location in subzone A, hence scoring more points towards the star rating of the vehicle.

Each zone is worth a maximum of two points, which contribute toward the star rating of the vehicle. If the manufacturer does not nominate an additional test, then the original test location counts for the maximum two points. Otherwise, the two points available are shared between the two test locations depending on how many subzones the manufacturer has nominated. For example – if the manufacturer has only nominated one subzone, then the manufacturer's test location counts for a maximum of 0.5 points, and the original for a maximum of 1.5. If the HIC at the test location is less than 1000, then the maximum points are awarded for that location. If the HIC exceeds 1350, then zero points are awarded. If the HIC is between 1000 and 1350 then the points score is linearly scaled – e.g. for a HIC of 1175, half of the maximum points are awarded.

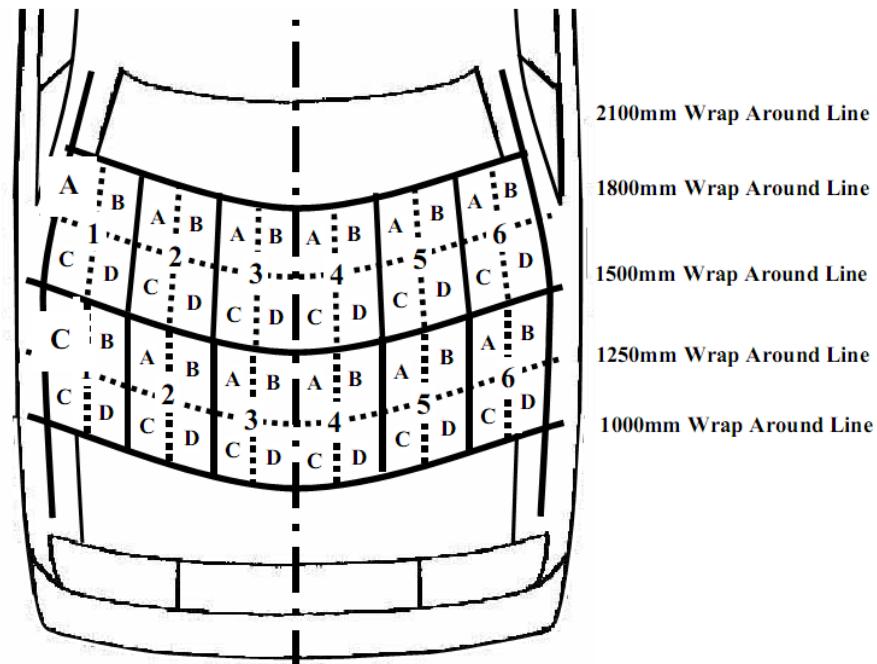

Figure 1.1  
ANCAP zone divisions (EuroNCAP 2009)

For GTR testing, the child and adult test areas are each split into thirds across the width of the test area. A minimum of nine child and nine adult test locations are chosen, with at least three test locations in each of the divided thirds. Each location is meant to be chosen on a different type of structure, and additional locations may be tested if the test house deems it necessary. An important difference between the GTR and ANCAP is that the dividing line between the child and adult test areas is 1700 mm in the GTR protocol, rather than 1500 mm in the ANCAP protocol. The effect of this is that some locations that would be tested with an adult headform under ANCAP would be tested with a child headform under the GTR. Furthermore, the GTR excludes the windscreen from any testing – the headform test area is bounded at the rear by the rear edge of the bonnet (or the WAD 2100mm line, whichever comes first, which in practice is most likely to be the rear edge of the bonnet).

Any test location that results in a HIC of less than 1000 satisfies the GTR requirements. However, the manufacturer can also nominate a 'relaxation' zone. The relaxation zone can include any parts of the test area and does not need to be continuous, as shown in Figure 1.2. The relaxation zone cannot consist of more than 1/3 of the total test area, and no more than 1/2 of the child test area. Any locations chosen within the relaxation zone may have a HIC of over 1000, but less than 1700, and still pass. If any test location exceeds the required HIC of 1000, or 1700 in the relaxation zone, then the vehicle fails the requirements of the GTR.

Previously, we have estimated performance in back-to-back tests between the GTR and ANCAP test methods (Searson and Anderson 2009). This was done using a damped contact model, and calculating the results from many simulated impacts using that model. The results suggested that HIC values under the GTR would be reduced by 44% for ANCAP child headform tests, 17% for ANCAP adult headform tests in the WAD < 1700 mm region, and 28% for adult headform tests in the WAD > 1700 mm region. However, these results were not compared with real data.

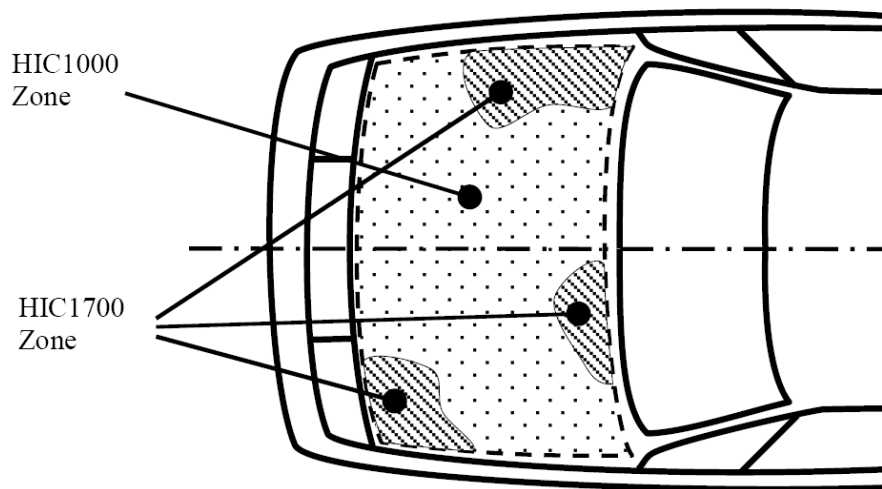

Figure 1.2  
Example of the GTR relaxation zone (UNECE 2009)

### 1.3 Objectives of the study

This study examines the headform testing component of the proposed GTR on pedestrian protection. The primary goal was to examine vehicles previously tested by ANCAP, and estimate whether or not they would be likely to pass the GTR, and if not, which components of the GTR they would be most likely to fail. The results of this study can be used to evaluate what effect the introduction of an ADR based on the GTR would be likely to have on vehicle designs in Australia.

In Section 2, the results of impact testing on three vehicles is presented. These 3 vehicles were tested according to the GTR child headform testing protocol.

Section 3 presents a method to scale the Head Injury Criterion (HIC) obtained under one set of test conditions to another set of test conditions. This includes the effect of changing headform mass, impact speed, impact angle and headform diameter. This scaling method was verified using the data obtained in Section 2, as well as a small sample of data obtained in earlier test work.

In Section 4, the HIC scaling method is used to predict the GTR performance of 60 vehicles tested by ANCAP. For each vehicle, a best-case and worst-case scenario for GTR performance is presented based upon the way in which test locations were selected in each ANCAP test zone.

Section 5 contains a summary and discussion of the findings.



## 2 Child headform testing on three vehicles to the GTR test specifications

---

### 2.1 Overview

Three vehicles were selected for testing under the child headform component of the GTR. The three vehicles selected were all relatively popular vehicles in Australia that had been previously tested by ANCAP – the Holden Commodore, Toyota Camry and Mazda3.

The goal of this testing was firstly to see directly how three popular vehicles would perform under the child headform component of the GTR. As part of this testing, some ANCAP locations were retested using GTR test conditions, thus giving two back-to-back results under two sets of conditions. As such, the secondary goal of the testing was to obtain these back-to-back results that could then be used to validate a theoretical relationship for the HIC under two sets of test conditions. This relationship, and the validation data, is discussed further in Section 3.

### 2.2 Test method

The three vehicles were marked out and tested in accordance with the child headform testing component of what was then the most recent draft of the GTR (UNECE 2009). The testing was conducted in June 2009. Since then, an updated version of the GTR draft has been released, but does not contain any changes in regards to the test and point selection method.

All three vehicles were purchased used, but were inspected to ensure that they were in good condition, and had no prior crash damage to the structures being tested.

Testing on the three vehicles was carried out at the Centre for Automotive Safety Research pedestrian impact testing laboratory in Adelaide, Australia.

#### 2.2.1 Vehicle marking and points selection

The vehicle was set to “Normal ride attitude”, as per Sec 2.26 of the draft GTR (UNECE 2009). This was done by using the same ride heights for the vehicle body as were used during ANCAP testing.

The side reference lines were marked using a 45-degree edge, traced along the sides of the vehicle (Sec 2.28 of UNECE 2009).

The child head testing area was bounded at the front and rear by wrap-around distances of 1000mm and 1700mm, respectively (Sec 2.40 of UNECE 2009). The adult headform area was bounded at the rear by the bonnet rear reference line (Sec 2.7 of UNECE 2009), as this occurred before the wrap-around distance limit of 2100mm in all three cases. The total head testing area was then divided into thirds, measured laterally at 100mm intervals.

Nine child headform test locations were chosen for each vehicle, three in each third of the bonnet top. The locations were those thought to be the most dangerous, based on a visual inspection, experience, and previous results from ANCAP testing. In accordance with the GTR, each location involved different types of structures from the other locations (Annex 5, Sec 4.2 of UNECE 2009).

## 2.2.2 Test procedure

Each test was conducted on a new bonnet. Any bonnet seals and rubber supports were transferred to the new parts. The hood liner was also transferred to the new parts.

The tests were conducted with a GTR 9 compliant 3.5 kg child headform impactor, fired at  $9.7 \pm 0.2$  m/s (35 km/h). The angle of impact was  $50^\circ$  to the horizontal. Acceleration was measured with a triaxial Kyowa damped accelerometer block. Data was acquired at 50 kHz.

Before testing commenced, the headform was certified using the procedure outlined in Annex 6, Sec 3 of the GTR (UNECE 2009). The headform passed the certification requirements.

Tests were conducted in a climate controlled laboratory, at  $20 \pm 4^\circ\text{C}$  and at  $40 \pm 30\%$  RH (Annex 3, Sec 1.1 of UNECE 2009).

## 2.3 Test results

Following are the results for the three tested vehicles. For each vehicle, a diagram of the test locations is given, showing the child and adult test areas, and the lateral division into thirds (see Figure 2.1, Figure 2.2 and Figure 2.3). The estimated relaxation zone is shown shaded in yellow.

The HIC values for each test location are listed in Table 2.1, Table 2.2 and Table 2.3.

### 2.3.1 Toyota Camry (2006)

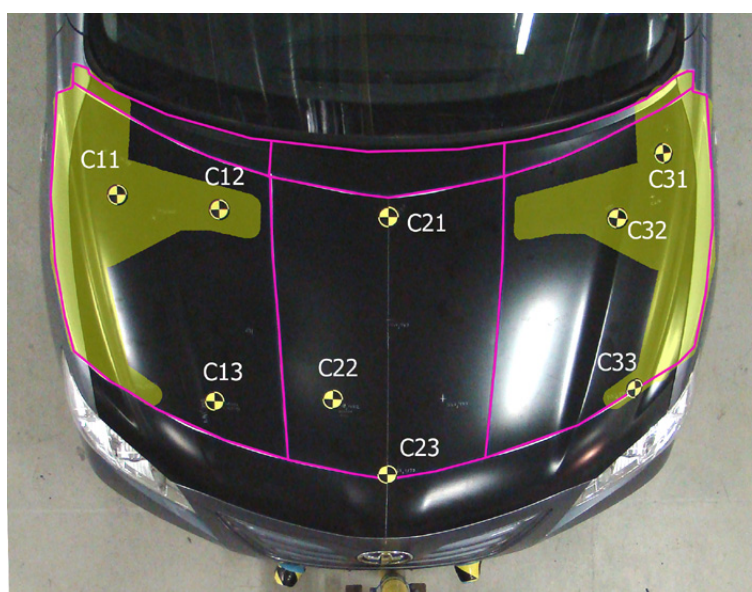

Figure 2.1  
Test locations for the Toyota Camry. The yellow shaded area is the estimated relaxation zone.

The Toyota Camry failed the GTR requirements, as one test location within the relaxation zone exceeded the maximum allowable HIC of 1700. This was location C31, positioned over an upwards pointing hinge bolt, the HIC recorded was 1774. This location was very close to passing, and with minimal redesign could probably be made to pass the requirements.

Table 2.1  
Results of GTR child headform tests on the Toyota Camry; failures shown in italics

Zone	Location	Description	Tested GTR HIC
Normal, HIC < 1000 required	C13	Bonnet rib edge	676
	C21	Above firewall	543
	C22	Above bonnet rib	511
	C23	Close to bonnet catch	683
Relaxation, HIC < 1700 required	C11	Above suspension bolt	1600
	C12	Above bonnet seal	676
	C31	Above hinge bolt	<i>1774</i>
	C32	Above bonnet rib	948
	C33	Close to bonnet stopper	1016

## 2.3.2 Holden Commodore (2006)

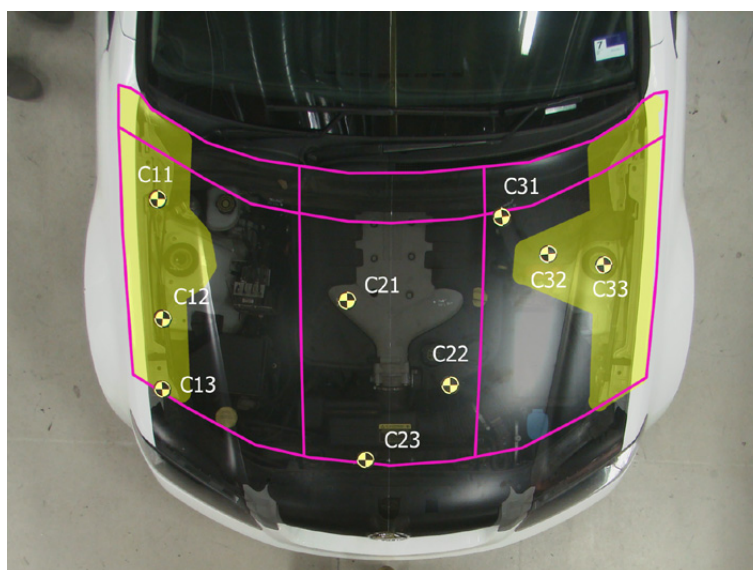

Figure 2.2

Test locations for the Holden Commodore. The yellow shaded area is the estimated relaxation zone.

The Holden Commodore failed the GTR requirements. Two locations in the relaxation zone exceeded the maximum allowable HIC of 1700. The first location (C11) was directly over the bonnet hinge mount. The second location (C13) was close to the front guard, and the front bonnet support. The HIC values for these tests were relatively close to passing, and could probably be made to pass with some redesign work.

Table 2.2

Results of GTR child headform tests on the Holden Commodore; failures shown in italics

Zone	Location	Description	Tested GTR HIC
Normal, HIC < 1000 required	C21	Over engine block	481
	C22	Above bonnet circle structure	372
	C23	Near bonnet latch	611
	C31	Close to rear seal	771
Relaxation, HIC < 1700 required	C11	Over hinge mount	<i>1865</i>
	C12	Over support strut mount	1470
	C13	Close to guard and bonnet support	<i>1890</i>
	C32	Above seal	970
	C33	Above suspension bolt	1250

### 2.3.3 Mazda3 (2004)

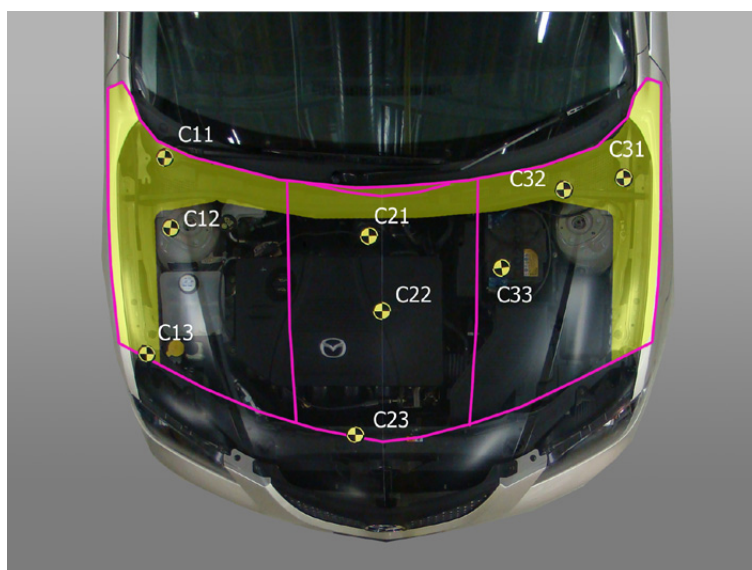

Figure 2.3  
Test locations for the Mazda3. The yellow shaded area is the estimated relaxation zone.

The Mazda3 passed the child headform requirements of the GTR. All points within the relaxation zone scored a HIC of less than 1700, and all other points scored a HIC of less than 1000. The maximum HIC scored was 1176, over the hinge bolt at location C31.

Table 2.3  
Results of GTR child headform tests on the Mazda3

Zone	Location	Description	Tested GTR HIC
Normal, HIC < 1000 required	C12	Above suspension bolt	794
	C21	Above rear bonnet seal	683
	C22	Centre of bonnet rib junction	304
	C23	Near bonnet catch	723
	C33	Above battery terminal	647
Relaxation, HIC < 1700 required	C11	Above wiper pivot	1078
	C13	Close to front guard	1120
	C31	Above hinge bolt	1176
	C32	Above plenum front wall	947

## 2.4 Comparison with ANCAP results

We can compare the results from this testing with results from earlier ANCAP testing on the same vehicle models. Table 2.4 below summarises the results from each car.

Table 2.4  
Vehicle results under ANCAP and the GTR

Vehicle	ANCAP child head score (out of 12)	ANCAP total head score (out of 24)	ANCAP pedestrian star rating	GTR child testing result
Toyota Camry	8.21	14.5	2	Fail, 1 point exceeded HIC of 1700
Holden Commodore	5.98	8.98	1	Fail, 2 points exceeded HIC of 1700
Mazda3	6.48	8.15	1	Pass

Note that the ANCAP pedestrian star rating also takes into account results from full leg and upper leg testing. However, none of these vehicles scored any points from either the full leg or upper leg ANCAP tests.

Of the 27 total locations tested, 12 locations were chosen at the same location as an earlier ANCAP test. Two of these locations were adult tests under ANCAP and the remaining 10 were child tests. These are listed below in Table 2.5, along with the HIC scored under ANCAP, and the HIC scored under the GTR.

Table 2.5  
Comparison of locations tested under ANCAP and the GTR

Vehicle	Location	ANCAP Location	ANCAP HIC	GTR HIC
Toyota Camry	C11	C1B	2615	1600
	C12	A2D(d)	1001	676
	C13	C2C(cd)*	1507	676
	C22	C3C*	1396	543
	C33	C1D(d)*	1803	511
Holden Commodore	C21	C3B	1339	481
	C23	C3D(cd)	1014	611
	C33	C6A	2264	1250
Mazda3	C13	C1C#	2394	1120
	C23	C3D	1353	723
	C32	A5D	1729	947
	C33	C5A	1084	647

\* ANCAP test was on the Toyota Aurion, which was also used for comparison with the Toyota Camry. The two vehicles have almost identical front structures, and very similar bonnets.

# ANCAP child head locations can be as close as 65mm to the side reference lines, whereas GTR child head locations must be 87.5mm from the side reference lines (due to the increased headform diameter). The original ANCAP test location C1C on the Mazda3 was too close for the GTR test to be repeated at exactly the same location, so was moved inwards by approximately 20mm.

Consider the 10 tests listed in Table 2.5 that were child headform tests under ANCAP. These results are shown graphically in Figure 2.4. A linear regression gave a scaling factor of 0.5228 between the GTR and ANCAP HIC results, as indicated by the line of best fit.

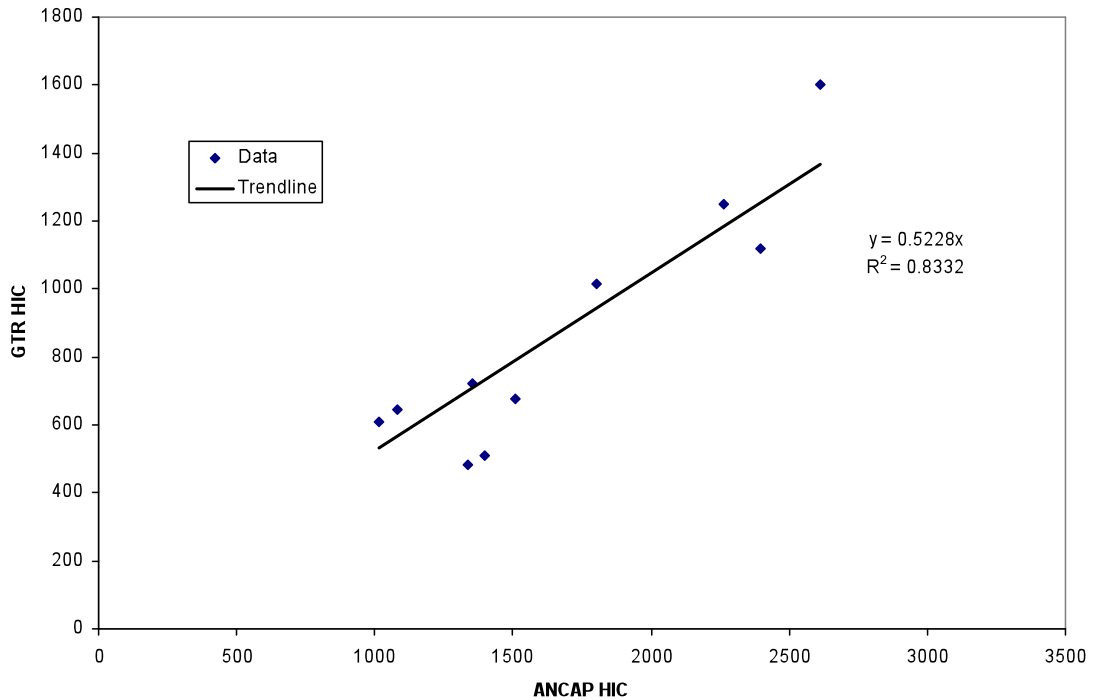

Figure 2.4  
ANCAP and GTR child headform results, with linear trendline.

These results gave a suggestion as to what difference in HIC values could be expected between child headform tests performed under ANCAP, and those performed under the GTR. The predicted scaling factor of 0.52 is close to that predicted by earlier work, which predicted a scaling factor of 0.56 (Searson and Anderson 2009).

In order to estimate the GTR headform testing performance of an entire vehicle, it was also necessary to predict the change in HIC that could be expected for ANCAP adult headform tests. As well as the reduction in impact speed, ANCAP adult headform tests with WAD < 1700 mm needed to be scaled to the mass of a GTR child headform, while those with WAD > 1700 mm needed to be scaled to the mass of an adult GTR headform.

Given this, a more generalised model was developed in order to calculate a HIC scaling factor for any two sets of test conditions (mass and speed). This model is presented in Section 3.

## 3 Method for scaling the Head Injury Criterion (HIC)

### 3.1 Linear mass and spring model

Consider the impact of the headform against the tested structure to be represented by a lumped mass  $m$ , impacting upon a linear spring with stiffness  $k$ . If  $\ddot{x}$  is the acceleration of the headform, and  $x$  is the displacement from its initial position, then balancing the forces on the headform gives us

$$m\ddot{x} = kx \quad (1)$$

Equation (1) is a differential equation that has a solution of the form

$$\ddot{x} = A\sin(\omega t) \quad (2)$$

Thus, the acceleration pulse for this model has a half-sine shape, rising to a maximum acceleration of  $A$ . The pulse ends when  $a < 0$ , as this can only occur when the spring is in tension, at which point the headform will separate from the structure.

Chou and Nyquist (1974) analysed many different impact pulse shapes, and derived analytical expressions for HIC and peak displacement. This included a half-sine acceleration pulse, which was specified by its peak acceleration value  $A$  and its duration,  $T$ . For the half-sine pulse, Chou and Nyquist derived the following expression for HIC:

$$HIC = C_1(\Delta V)A^{3/2} \quad (3)$$

Where  $\Delta V$  is the change in velocity and  $C_1$  is a constant based on the system of units in place. An expression was also derived by Chou & Nyquist for peak displacement,  $S$ :

$$S = C_2 \frac{(\Delta V)^2}{A} \quad (4)$$

Similarly,  $C_2$  is a constant based on the system of units. If we rearrange Equation (4) for  $A$  and substitute this into Equation (3), then we obtain an expression for HIC in terms of velocity change and peak displacement:

$$HIC = C_1 C_2^{3/2} \frac{(\Delta V)^4}{S^{3/2}} \quad (5)$$

The form of Equation (5) is the same as that obtained by Mizuno and Kajzer (2000) for a quadratic acceleration pulse.

Next, we can consider an energy balance when the headform reaches its peak displacement,  $S$ . At this point the velocity of the headform will be zero, and the potential energy of the spring is equivalent to the initial kinetic energy of the headform. If the initial velocity of the headform is  $v_0$ , then:

$$\frac{1}{2}kS^2 = \frac{1}{2}mv_0^2 \quad (6)$$

Simplifying Equation (6) and rearranging, we obtain:



$$S = \sqrt{\frac{m}{k}}v_0 \quad (7)$$

The impact described here is purely elastic, so the change in velocity  $\Delta V$  is simply twice the initial velocity  $v_0$ . Recognising this, and substituting Equation (7) into Equation (5), we arrive at:

$$HIC = 16C_1C_2^{3/2}k^{3/4}m^{-3/4}v_0^{5/2} \quad (8)$$

Finally, we can consider two theoretical impacts on the same structure, under different test conditions. In this case the structure is represented by  $k$ , which remains constant between both tests. The first set of test conditions is with headform mass  $m_1$  and initial velocity  $v_1$ . The second set of test conditions is with headform mass  $m_2$  and initial velocity  $v_2$ . The HICs from each test are  $HIC_1$  and  $HIC_2$ . If we take the ratio of  $HIC_1$  and  $HIC_2$  using Equation (8), then we obtain the following relation:

$$\frac{HIC_1}{HIC_2} = \left(\frac{m_1}{m_2}\right)^{-3/4} \left(\frac{v_1}{v_2}\right)^{5/2} \quad (9)$$

Equation (9) gives us a theoretical means for relating the results from a test on a given structure, for different headform masses and velocities.

## 3.2 Validation method

Equation (9) gives an analytical expression for the change in HIC that can be expected from a given change in headform mass and impact speed. To test this relationship, data from multiple tests performed on the same structures was analysed.

We can write Equation (8) in a more generalised form:

$$HIC = Lm^a v^b \quad (10)$$

In this form,  $L$  is a constant dependent on the location being tested. The exponents  $a$  and  $b$  are expected to be equal to -0.75 and 2.5, respectively. Taking the logarithm of both sides gives us:

$$\log(HIC) = \log(L) + a \log(m) + b \log(v) \quad (11)$$

Multiple linear regression was used to estimate  $a$  and  $b$  from the test data. The HIC used was calculated using a maximum 15 ms time window.

For the impact velocity  $v$ , the normal impact speed was used, taking into account both the angle of the impact to the ground, and the angle of the vehicle surface, which was measured for every test. Or, more explicitly:

$$v = v_m \sin(\theta_i + \theta_s) \quad (12)$$

Where  $v_m$  was the measured impact speed (e.g. approximately 40km/h for an ANCAP impact test),  $\theta_i$  was the impact angle relative to the ground (e.g. 50° for an ANCAP child headform test), and  $\theta_s$  was the angle of the vehicle surface relative to the ground.

The regression was also performed using the total impact speed, neglecting impact angle, but the correlation was higher when using the normal impact speed. This could be expected – the forces in the normal direction are generally much higher during the impact than the tangential/frictional forces.

The location-dependent component,  $\log(L)$ , was dealt with by introducing a series of dummy variables,  $L_i$ . Each dummy variable was set to zero, unless it corresponded to the location for that test, in which case it was set to one.

Additionally, the 2.5 kg headform was smaller in diameter (130 mm) than the three other headforms used (165 mm). For this reason, two additional dummy variables were introduced to account for headform diameter in the regression –  $D_{130}$  was set to one for the 2.5 kg headform impacts, and zero otherwise. Similarly,  $D_{165}$  was set to zero for the 2.5 kg headform impacts, and one otherwise.

Thus, the final form of the regression equation was as follows:

$$\log(HIC) = a \log(m) + b \log(v) + d_{130}D_{130} + d_{165}D_{165} + l_1L_1 + l_2L_2 + \dots \tag{13}$$

Multiple regression was used to find values for  $a$ ,  $b$ ,  $d_{130}$ ,  $d_{165}$  and  $l_i$ .

### 3.3 Validation results

A total of 77 headform tests on 31 different test locations were included. The tests were conducted on four different vehicles, including the three vehicles presented in Section 2, as well as tests performed on a Toyota Kluger in May 2008.

Table 3.1 shows the distribution of tests across different locations on the four vehicles. The speed and mass distribution of the tests are shown in Figure 3.1. The normal impact speed is used in Figure 3.1, as this was the figure used in the regression. The measured, or nominal, impact speeds were generally close to either the EuroNCAP impact speed of 11.1 m/s, or the GTR impact speed of 9.7 m/s. In some of the tests the speed was higher or lower than these values, in order to gain a wider spread of data.

Of the 31 test locations, three were found to include some significant interaction with a stiffer structure below the deformable outer structure (e.g. engine below the hood). These were included the data set, and excluding them was not found to significantly affect the results.

Table 3.1  
Distribution of tests across different locations.

Number of locations	Number of tests
2	6
2	5
1	3
26	2

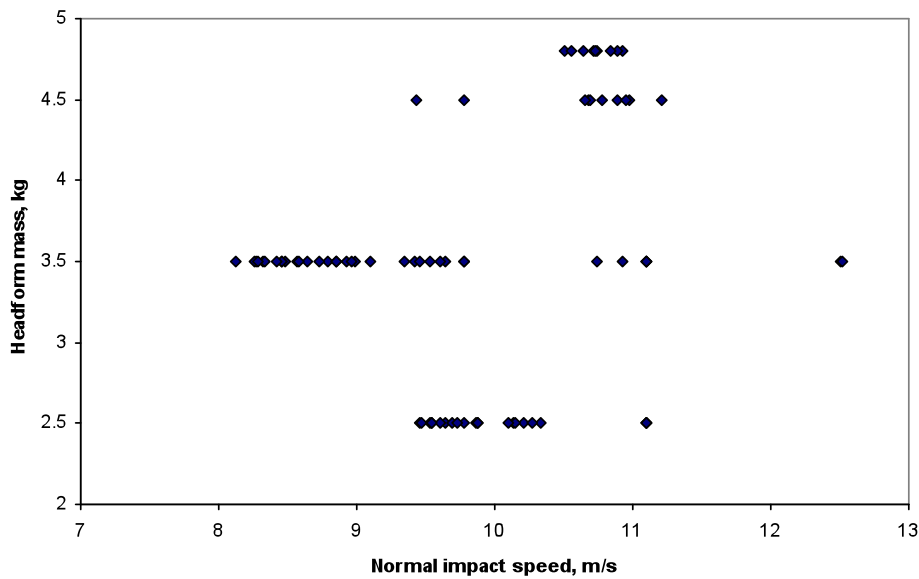

Figure 3.1  
Distribution of headform masses and normal impact speeds used in the study.

Results for the regression on Equation (13) are shown in Table 3.2. The empirical results for  $a$  and  $b$  were found to be close to their theoretical values of  $-0.75$  and  $2.5$ , respectively. Their theoretical values lay within the 95% confidence intervals of the empirical results.

Table 3.2  
Multiple regression results for estimating exponents  $a$  and  $b$ . (N=77)

Exponent $a$	-0.685
Exponent $b$	2.349
95% confidence interval for $a$	-1.008, -0.282
95% confidence interval for $b$	1.901, 2.796
$R^2$	0.972
p-value	0.000

Additionally, a regression was performed that only included results from tests conducted with the 165 mm headforms. In this case, the exponents  $a$  and  $b$  were estimated at  $-0.703$  and  $2.589$ .

Values for  $d_{130}$  and  $d_{165}$  were found, which gave scaling factors for moving from one headform diameter to the other. To scale the HIC from a 130mm headform test to a 165mm headform test, the scaling factor was 0.869. To scale the HIC from a 165mm headform test to a 130mm headform test, the scaling factor was 1.151.

Using these scaling factors and Equation (9), the predicted and measured change in HIC between every pair of tests on the same location was calculated. These results are shown in Figure 3.2.

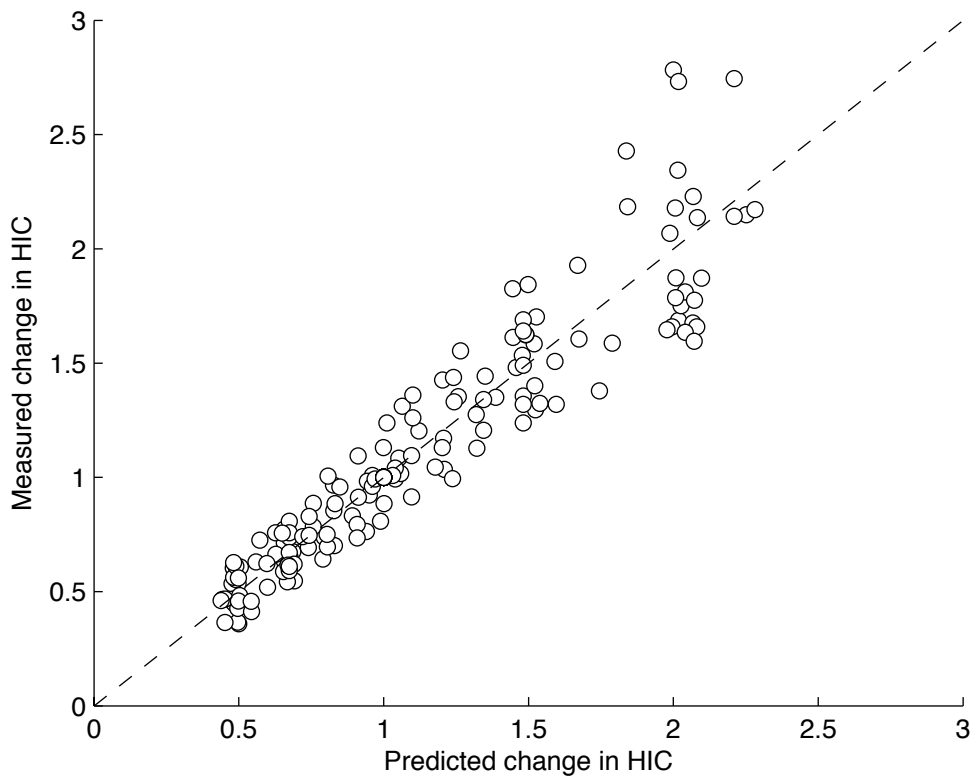

Figure 3.2

Comparison between measured and predicted change in HIC between two sets of test conditions on the same test location.

### 3.4 Expected changes in HIC between ANCAP and the GTR

Using Equation (9), an estimate can be made for the change in HIC expected within each region of the testable area; these are given in Table 3.3. For the purposes of calculating the normal velocity, a bonnet angle of 10 degrees was assumed – this is relevant for WAD 1500-1700 mm, where the impact angle changes between the two test protocols.

Table 3.3  
HIC scaling factors by wrap-around distance. Bonnet angle of 10 degrees used.

	Headform type (ANCAP – GTR)		
	Child – Child	Adult – Child	Adult – Adult
WAD range (mm)	1000 – 1500	1500 – 1700	1700 – 2100
ANCAP test conditions	2.5 kg, 40 km/h, 50°	4.8 kg, 40 km/h, 65°	4.8 kg, 40 km/h, 65°
GTR test conditions	3.5 kg, 35 km/h, 50°	3.5 kg, 35 km/h, 50°	4.5 kg, 35 km/h, 50°
HIC scaling factor	0.48	0.69	0.75

So, for tests on a given structure in the WAD 1000 – 1500mm region, a reduction in HIC of around 50% can be expected, which is similar to the result shown in Figure 2.4. For tests on a given structure in the WAD 1500 – 1700 mm region, a reduction in HIC of around 30% can be expected (for a bonnet angle of 10 degrees), and for tests on a given structure in the WAD 1700 – 2100 mm region, a reduction of about 25% can be expected.

## 4 Analysis of vehicles tested by ANCAP

---

### 4.1 Data source

Since the inclusion of pedestrian testing in the Australasian New Car Assessment Programme in 1997, over 100 vehicles have been tested at the Centre for Automotive Safety Research pedestrian impact testing laboratory. In 2002 the Euro NCAP pedestrian testing protocol was heavily revised by the EEVC Working Group 17, and since then has only had minor modifications.

For the purposes of this study, vehicles were only included that were tested using the newer, post-2002 Euro NCAP protocol.

Under the GTR, vehicles of categories M1 and N1 are tested. Category M1 includes passenger vehicles with up to eight seats in addition to the driver. Category N1 vehicles are those designed for the carriage of goods, with a maximum mass of 3.5 tonnes – this would include most utilities and vans. However, the GTR excludes any N1 vehicles, or M1 vehicles weighing more than 2.5 tonne that have been derived from N1 vehicles, that have an 'R-point' ahead of the front axle, or less than 1100mm behind the front axle. In the absence of such measurements, any vans were excluded from this study. All passenger vehicles and utilities were included.

There were six vehicles tested by ANCAP that were not included in the study, due to there being an insufficient amount of tests performed in the GTR testable area.

After these exclusions, there were 60 vehicles remaining that were included in the study.

The manufacturing year for these vehicles ranged from 2002 until 2009. Of the 60 vehicle models, 33 were regarded as 'current', i.e. were available to be purchased new as of November 2009. Currency was determined by visiting manufacturer websites.

The number of individual impact test results included was 523, across all 60 vehicles. Of those, 275 were child headform tests, and 248 were adult impact tests. Including symmetrical test locations, and locations that were not tested due to a default pass or default fail, a total of 1115 ANCAP test locations were included.

Of the impact tests included, the highest HIC recorded was 8722, the lowest was 373. The mean HIC from the impact tests was 1709.

### 4.2 Method for estimating results for each vehicle

The HIC scaling method presented in Section 3 was applied to every test location. The original impact speed from each test was 11.1 +/- 0.2 m/s, as per the ANCAP testing protocol. HIC values were scaled using the GTR impact speed of 9.7 m/s.

The impact angle and bonnet angle for each test was used to calculate the normal impact velocity for use in Equation (9). In a limited number of cases, the bonnet angle was not available, and so a bonnet angle of 15 degrees to the horizontal was assumed.

A series of computer scripts were written, that took a list of results from the ANCAP tests, and calculated the 'best case' and 'worst case' estimates of GTR performance for each vehicle.

In the following description of the script logic, the term ‘zone’ refers to one of the six numbered adult zones, or six numbered child zones. The term ‘subzone’ refers to one of the four lettered areas within each zone.

For the purposes of this estimate, the ANCAP subzone divisions were used as the smallest units of area. Any attempt to divide the testable area into smaller quanta would have been difficult and inaccurate.

As described in Section 1.2, under the ANCAP protocol, one test location is selected for every zone (the “ANCAP test”). The vehicle manufacturer then has the option of nominating one or more of the remaining three subzones, which will, in theory, perform better than the ANCAP test location. One location is selected within the manufacturer nominated subzones for an additional test (the “manufacturer test”).

Thus, within each zone there is at least one subzone that contains a test result, the ANCAP test. There may be an additional subzone that also contains a test result, the manufacturer test. The remaining two or three subzones do not contain test results, but some knowledge can be assumed regarding those remaining subzones.

- If there were *no* manufacturer nominated subzones, then we assume that the ANCAP tested subzone was the worst of all four. Thus, the three non-tested subzones may perform the same as the ANCAP test location in the worst possible case, and in the best possible case will pass any requirement (i.e. they would have a theoretical HIC of less than 1000).
- If there were one or more manufacturer nominated subzones, then we can assume that the subzone that was tested was the worst performing out of those nominated.
  - If the ANCAP test performed worse than the manufacturer test (as expected), then:
    - The remaining manufacturer nominated subzones, that were not tested, may perform the same as the manufacturer test in the worst possible case, and in the best possible case will pass any requirement (i.e. they would have a theoretical HIC of less than 1000).
    - Any subzones that were not nominated by the manufacturer and were not tested, may perform the same as the ANCAP test in the worst possible case, and in the best possible case will perform the same as the manufacturer test.
  - Otherwise, if the manufacturer test performed worse than the ANCAP test (unexpected, but happens in some cases), then:
    - All non-tested subzones may perform the same as the ANCAP test location in the worst possible case, and in the best possible case will pass any requirement (i.e. they would have a theoretical HIC of less than 1000).

Using the logic outlined above, any non-tested subzones were given an upper and lower estimate of the HIC, or performance, which could be expected.

Two additional factors also had to be taken into account:

1. In each of the adult zones, subzones C and D were divided into two, at the WAD of 1700 mm. The lower 2/3 of the subzone was part of the GTR child test area, and the upper 1/3 was part

of the GTR adult test area. As such, two appropriate HIC values were calculated for these subzones, and the two areas were considered separately.

2. The GTR test area does not extend beyond the back of the bonnet. As such, a manual inspection of photos of each vehicle was carried out. The approximate number of subzones to be included was estimated for each vehicle. Any subzones not on the bonnet area did not contribute towards the GTR performance estimate. If the rear edge of the bonnet roughly bisected a series of subzones, then those subzones only counted for 0.5 of a subzone.

Once an upper and lower limit had been established for all of the subzones included within the GTR test area, an overall best-case and worst-case estimate could be made against the three criteria of the GTR. That is,

1. No more than 1/3 of the testable area could exceed a HIC of 1000 (the 'relaxation' area).
2. No more than 1/2 of the child test area could exceed a HIC of 1000 (the 'relaxation' area).
3. No test could exceed a HIC of 1700.

For each of these criteria, an upper and lower estimate was made. In the cases of criteria 1 and 2, an upper and lower estimate of the required relaxation area was made, relative to the total area and total child test area. For criteria 3, an upper and lower estimate of the number of subzones exceeding a HIC of 1700 was made.

## 4.3 Results

The results for all 60 vehicles are listed in Table 4.1. For each vehicle, upper and lower estimates are given for the three criteria of the GTR. Vehicles marked with a star (\*) are no longer sold, or have been superseded with a more recent model. The upper estimate is the worst-case scenario, and the lower estimate is the best-case scenario, based on the scaled ANCAP test results.

Table 4.1  
Upper and lower estimates of performance under three criteria of the GTR

Vehicle Name	Percentage of total test area, HIC > 1000		Percentage of child test area, HIC > 1000		Number of subzones, HIC > 1700	
	Upper	Lower	Upper	Lower	Upper	Lower
Mazda Tribute*	54.39	12.28	45.83	10.42	6.67	1
Subaru Forester*	35.19	20.37	35.42	18.75	2	0
Toyota RAV4 *	44.44	19.44	46.88	20.83	2	0
Holden VY Commodore*	55.56	5.56	50	6.25	20	2
Ford Falcon BA*	50.93	15.74	48.96	17.71	9	1
Toyota Camry (2002)*	52.78	19.44	50	18.75	6	0
Hyundai Getz*	50	12.5	50	12.5	8	2
Holden Cruze*	87.5	62.5	87.5	62.5	6	2
Honda Jazz VTi*	25	8.33	25	8.33	2	0
Mitsubishi Magna ES*	48.15	12.04	41.67	10.42	12	2
Daewoo Kalos*	66.67	16.67	66.67	16.67	8	2
Mitsubishi Lancer*	33.33	10	33.33	10	8	2
Holden Monaro CV8*	48.15	12.96	41.67	10.42	12	2
Toyota Echo*	45.83	12.5	45.83	12.5	8	2
Mitsubishi Outlander*	55.56	27.78	56.25	27.08	6	3
Subaru Liberty MY 04*	33.33	22.22	31.25	18.75	2	0
Hyundai Accent*	55.56	16.67	50	14.58	4	0

Mazda Mazda3*	36.67	13.33	36.67	13.33	2	0
Toyota Landcruiser 100*	66.67	18.75	79.17	22.92	14.67	3.67
Lexus RX330*	71.3	17.59	73.96	18.75	4	0
Nissan Patrol	33.33	8.33	33.33	10.42	8	2
Ford Courier*	38.1	7.14	38.1	7.14	0	0
Holden Rodeo LX*	52.38	11.9	58.33	12.5	14	3
Toyota Hilux	66.67	18.75	75	18.75	5.33	2
Nissan Patrol C/C	66.67	16.67	83.33	18.75	16	4
Mitsubishi 380*	55.56	16.67	50	14.58	12.67	2.33
Toyota Landcruiser C/C*	68.75	25	80.21	28.13	25	7
Holden Viva*	61.11	13.89	62.5	14.58	12	2
Nissan Tiida	0	0	0	0	0	0
Nissan Maxima*	47.22	11.11	43.75	10.42	9	2
Honda Odyssey	0	0	0	0	0	0
Holden Commodore VE	38.89	8.33	37.5	8.33	4	0
Hyundai Accent*	0	0	0	0	0	0
Toyota Camry	29.63	16.67	29.17	14.58	4	1.33
Mitsubishi Triton	84.92	35.32	85.42	32.29	26	7
Toyota Aurion	29.63	5.56	29.17	6.25	4	0
Subaru Tribeca	50	16.67	54.17	18.75	2	0
Holden Epica	11.11	0	8.33	0	4	0
Subaru Impreza	5.56	0	4.17	0	2	0
Toyota Kluger	42.86	16.67	47.92	18.75	4	1
Mazda CX-7	44.44	11.11	43.75	12.5	10	2
Mazda BT-50	58.33	20.83	58.33	18.75	5.33	2
Hyundai Elantra	0	0	0	0	0	0
Mahindra Pik-Up	50	16.67	58.33	18.75	24	8
Subaru Forester	9.52	2.38	4.17	0	4	1
Mitsubishi Lancer	16.67	0	14.58	0	4	0
Ford Falcon	36.11	16.67	33.33	14.58	4.33	0
Nissan Navara	49.12	19.3	41.67	14.58	12.67	4
Honda Jazz GLi	16.67	0	16.67	0	2	0
Holden Barina	33.33	8.33	33.33	8.33	0	0
Suzuki APV	66.67	16.67	66.67	16.67	8	2
Kia Cerato	0	0	0	0	0	0
Hyundai iLoad	83.33	25	83.33	25	8	2
Subaru Liberty	5.56	0	4.17	0	2	0
Subaru Outback	5.56	0	4.17	0	2	0
Proton Jumbuck	46.67	13.33	46.67	13.33	12	3
Great Wall SA220	66.67	16.67	83.33	18.75	16	4
Honda City	0	0	0	0	0	0
Hyundai Santa Fe	24.07	6.48	20.83	6.25	4	0
Subaru Exiga	5.56	0	4.17	0	2	0

Note the results for the Toyota Camry, Holden Commodore and Mazda3 in Table 4.1, which can be related to the actual test results described in Section 2.3.1.

- Applying the estimation method described in this Section, the Toyota Camry was estimated to have up to four subzones with a HIC in excess of 1700 (which may be interpreted as representing the result of a single test). In the test results in Section 2.3.1, the Camry passed the relaxation zone criteria, and had one test location that exceeded a HIC of 1700, in the same area that was predicted in this Section.



- The Holden Commodore VE was estimated to have between zero and four subzones with a HIC in excess of 1700 – in the test results in Section 2.3.2, the Commodore passed the relaxation zone criterion and had two test locations with a HIC in excess of 1700. One of those locations was encompassed by the subzones identified in this Section. However, the other location with a HIC over 1700 was not identified using the estimation method described in this Section. The reason for this anomaly is that the location tested by ANCAP was not the worst location in that zone (as revealed by the result of the GTR test). The anomaly points to a limitation of the methods described herein; this limitation is described at length in Section 5.1.
- Finally, the Mazda3 was estimated to have between zero and two subzones with a HIC in excess of 1700. In the test results in Section 2.3.3, the Mazda3 passed all criteria of the GTR.

Thus, the estimated upper and lower boundaries of performance encompass most of the actual results of the tests on the three vehicles in Section 2.

The results for all vehicles are presented graphically in Figure 4.1, Figure 4.2 and Figure 4.3. In each plot, the vehicles are sorted by their worst-case estimate. Vehicles that were estimated to pass that GTR criterion under both cases (best and worse) are coloured in green, vehicles that may or may not pass that GTR criterion are coloured in blue, and vehicles that were estimated to fail that GTR criterion under both cases (best and worse) are coloured in red.

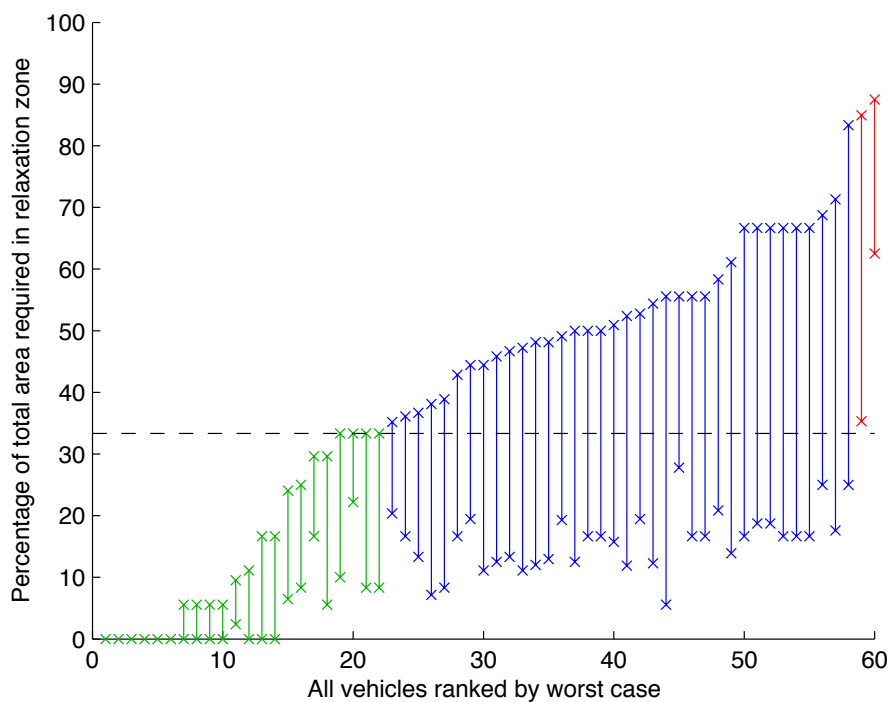

Figure 4.1  
Upper and lower estimates of percentage of total area required in relaxation zone (limit 33.3%)

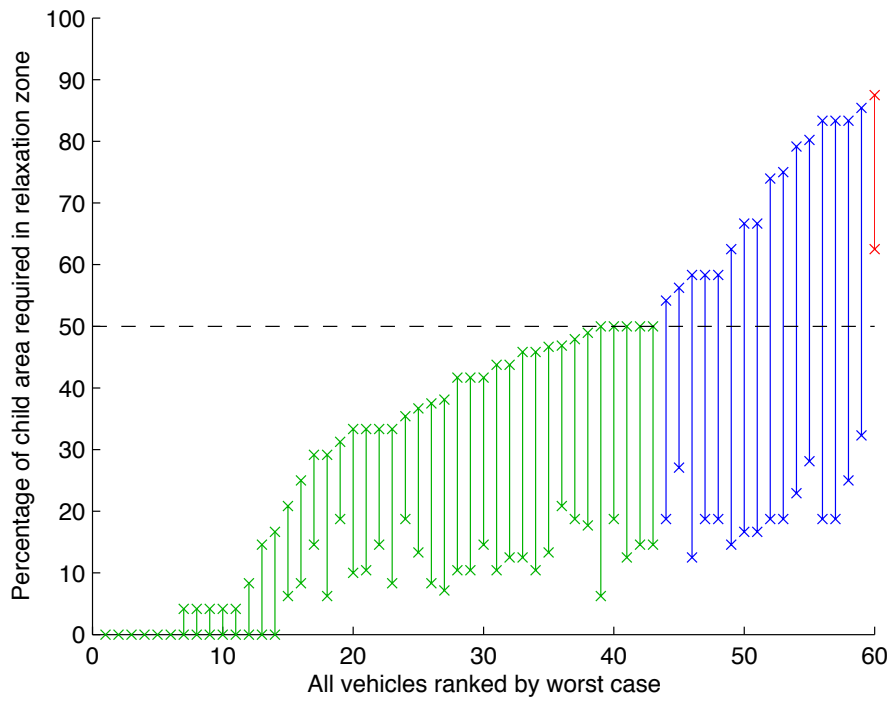

Figure 4.2  
Upper and lower estimates of percentage of child area required in relaxation zone (limit 50%)

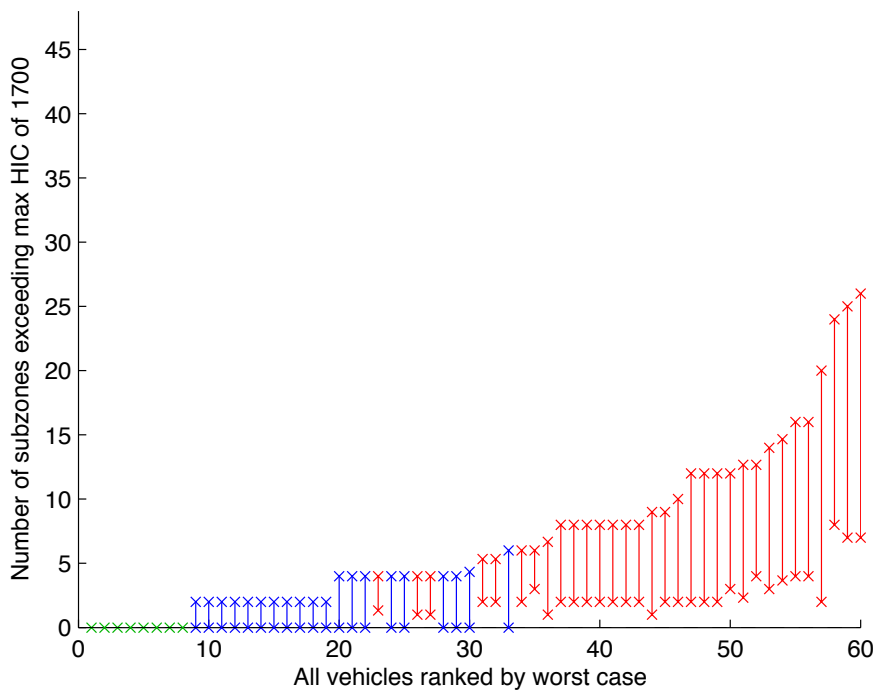

Figure 4.3  
Upper and lower estimates of number of subzones exceeding HIC 1700 (limit is zero)

Figure 4.1 shows that 22 vehicles were estimated to pass the requirement that a maximum of 1/3 of the test area may exceed a HIC of 1000. The majority of vehicles were estimated to potentially pass or fail this requirement. Just two vehicles were estimated to fail this requirement in both the best and worse cases.

Figure 4.2 shows that a large proportion of the vehicles, 43 out of 60, were estimated to pass the requirement that a maximum of 1/2 of the child test area may exceed a HIC of 1000. The remaining vehicles, except for one, were estimated to potentially pass or fail this requirement. Just 1 one vehicle was estimated to fail this requirement in both the best and worse cases.

Figure 4.3 shows that eight vehicles were estimated to pass the requirement that no test exceed a HIC of 1700. A further 20 vehicles may or may not pass this requirement. The remaining 32 vehicles were estimated to fail this requirement in both the best and worse cases.

Figure 4.4, Figure 4.5 and Figure 4.6 show the results for the 33 currently available vehicles only.

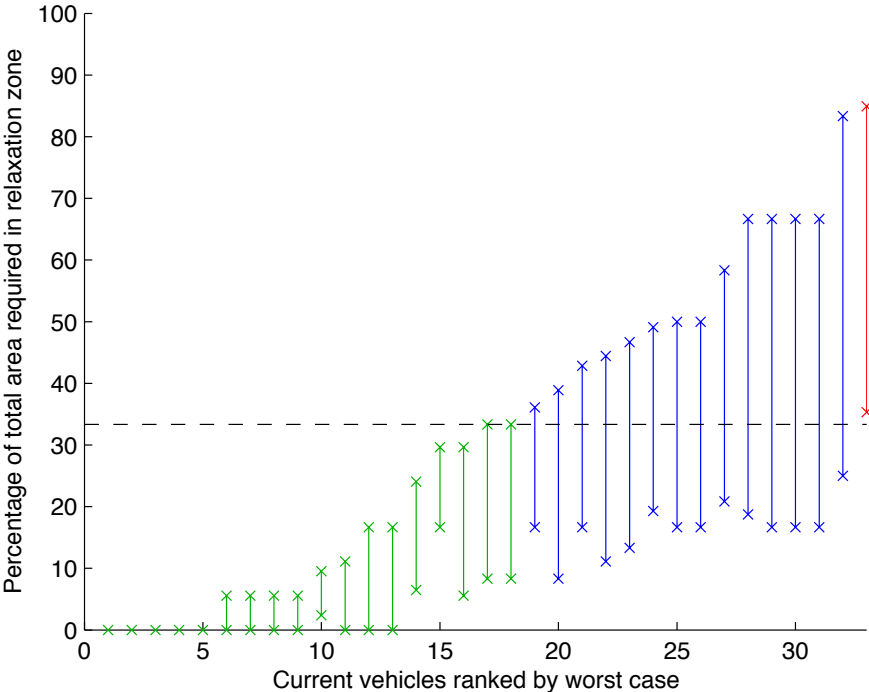

Figure 4.4

Upper and lower estimates of percentage of total area required in relaxation zone, for current vehicles only (limit 33.3%)

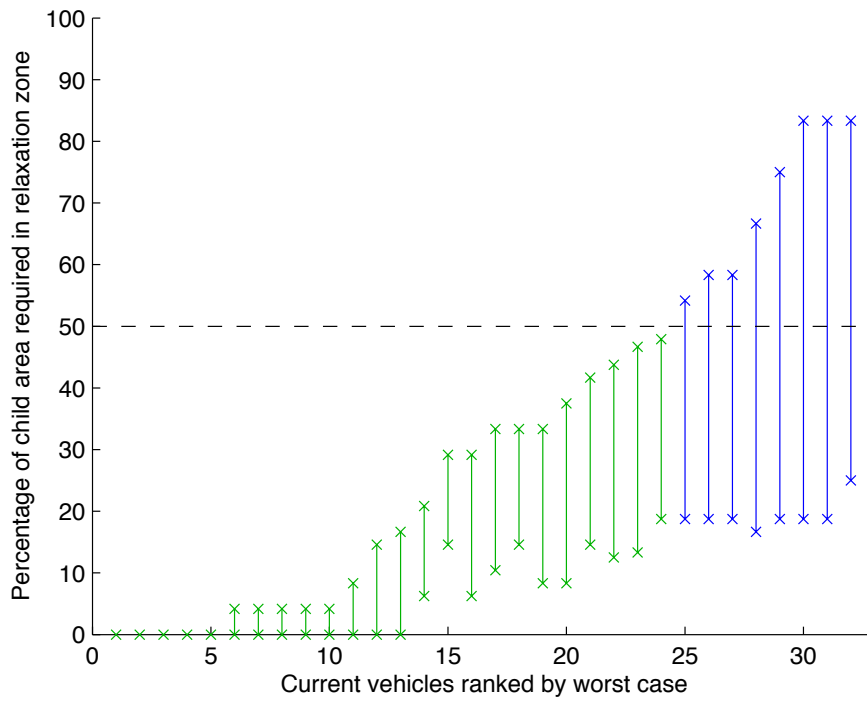

Figure 4.5

Upper and lower estimates of percentage of child area required in relaxation zone, for current vehicles only (limit 50%)

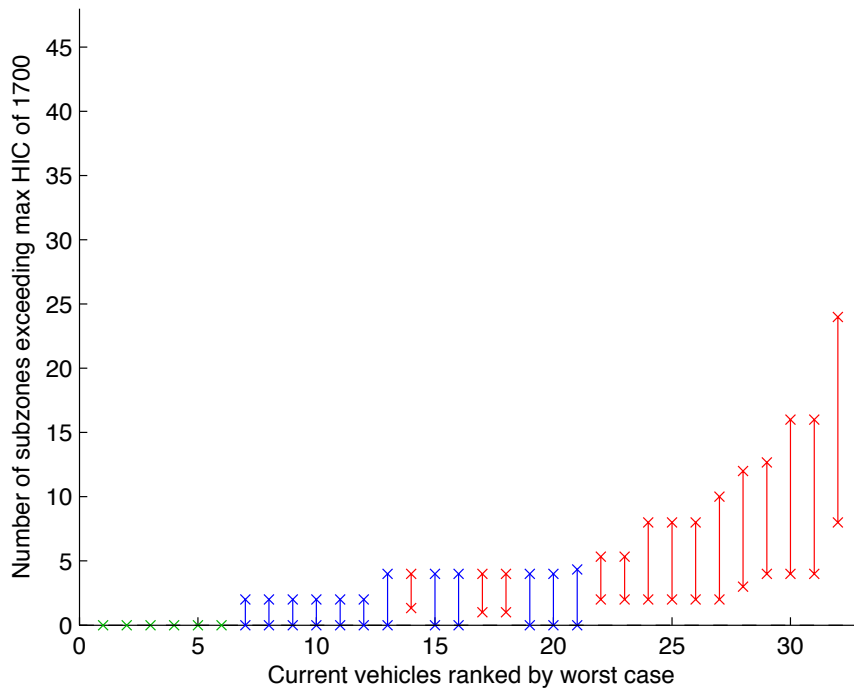

Figure 4.6

Upper and lower estimates of number of subzones exceeding HIC 1700, for current vehicles only (limit is zero)

The results for the current vehicles exhibit similar trends to those for all vehicles. Proportionally, slightly more current vehicles were estimated to pass the requirement that no more than 1/3 of the testable area exceeds a HIC of 1000 (Figure 4.4), compared with all vehicles (Figure 4.1).

If we consider only the criteria relating to the relaxation zone, we can see that the requirement that the relaxation zone does not exceed 1/3 of the total test area is the limiting factor for overall vehicle performance. In fact, in all cases where the relaxation zone passed the requirement that it was less than 1/3 of the total test area, the vehicle was also estimated to pass the requirement that the relaxation zone was less than 1/2 of the child test area. Hence, the child area requirement of the relaxation zone was not a limiting factor as to whether the entire vehicle was estimated to pass or fail the GTR requirements.

For simplicity, from here onwards the requirement that the relaxation zone is less than 1/3 of the total test area will be referred to as the 'HIC1000' criterion and the requirement that no test exceeds a HIC of 1700 will be referred to as the 'HIC1700' criterion.

It is of interest to examine the relationship between a vehicle's performance in the HIC1000 criterion, against their performance in the HIC1700 criterion. These results are given in Table 4.2 and Table 4.3 for all vehicles and current vehicles only, respectively.

Table 4.2  
Performance in the HIC1000 criterion compared with performance in the HIC1700 criterion, all vehicles

Requirement that no tests have HIC > 1700	Requirement that max 1/3 of test area has HIC > 1000		
	Estimated pass	May pass, may fail	Estimated fail
Estimated pass	7	1	0
May pass, may fail	11	9	0
Estimated fail	4	26	2

Table 4.3  
Performance in the HIC1000 criterion compared with performance in the HIC1700 criterion, current vehicles only

Requirement that no tests have HIC > 1700	Requirement that max 1/3 of test area has HIC > 1000		
	Estimated pass	May pass, may fail	Estimated fail
Estimated pass	6	0	0
May pass, may fail	9	3	0
Estimated fail	3	11	1

The results in Table 4.2 and Table 4.3 show the relationship between results under the two criteria. Of all of the vehicles, seven were estimated to pass both criteria, and six of those were current vehicles. The seven vehicles that were estimated to pass were:

- Nissan Tiida (2006)
- Honda Odyssey (2006)
- Hyundai Accent (2006, no longer sold)
- Hyundai Elantra (2007)
- Holden Barina (2008)

- Kia Cerato (2009)
- Honda City (2009)

Additionally, there were 13 vehicles, 11 of which were current, that were estimated to pass the HIC1000 criterion and possibly pass the HIC 1700 criterion. Except for one, all of these vehicles had a maximum of four subzones that might fail the HIC1700 criterion (Figure 4.3). For these vehicles, it would be reasonable to expect that only minor modifications would be needed in order to make them pass both criteria. In fact, many of these vehicles may pass the HIC1700 criterion without any modification, if their lower estimate was zero. These vehicles were:

- Honda Jazz (2003, not current – old model)
- Subaru Liberty (2004, not current – old model)
- Toyota Aurion (2006)
- Subaru Impreza (2007)
- Holden Epica (2007)
- Mitsubishi Lancer (2008)
- Honda Jazz (2008)
- Subaru Liberty (2009)
- Subaru Outback (2009)
- Subaru Exiga (2009)
- Hyundai Santa Fe (2009)

Of those vehicles that may pass or may fail the HIC1000 criterion, 27 vehicles were estimated to fail the HIC1700 criteria. This gives a somewhat pessimistic view of the expected outcomes under the GTR; however when we look at the current vehicles only, this number was reduced to 11.

There were only two vehicles in total that were estimated to fail both criteria, one of which was current. They were the Mitsubishi Triton (2006) and the Holden Cruze (2002, not current).

Finally, it is also worth looking at the ANCAP performance of vehicles in each category. The ANCAP head score is scored out of a maximum of 24 points, two points for each zone. Table 4.4 gives the mean ANCAP head score for all vehicles.

Table 4.4  
 Mean ANCAP head score (out of 24), for all vehicles.  
 Performance against the HIC1000 criterion compared with performance against the HIC1700 criterion.

Requirement that no tests have HIC > 1700	Requirement that max 1/3 of test area has HIC > 1000		
	Estimated pass	May pass, may fail	Estimated fail
Estimated pass	10.6	1.2	-
May pass, may fail	12.6	7.7	-
Estimated fail	8.7	5.1	3.9

## 5 Discussion

---

This study presents results for vehicle performance under the GTR on pedestrian protection at both the micro and macro levels. On the micro level: three popular vehicles were tested under the child headform testing requirements. The performance of these vehicles was measured directly. On the macro level: results from ANCAP pedestrian testing were used to estimate the performance of 60 vehicles, 33 of which are currently available. These results were estimated based on the location selection process, and a method for scaling the HIC values from the ANCAP tests.

### 5.1 Sources of error in the evaluation of vehicle models previously tested by ANCAP

The scaling method presented in Section 3 was based on a highly simplified version of a real impact: a linear mass-spring model. In this model, the force on the headform at any point in time is linearly related to amount of normal displacement since the initial contact.

This may not accurately represent the conditions of a real impact. In real impacts, the presence of damping and non-linear stiffness is likely to add to the force on the headform. However, the linear mass-spring model is not intended to perfectly replicate the conditions of a real impact, but to provide a basis for examining the change in HIC between two sets of test conditions. For that purpose, it would appear to give a reasonable estimate.

Additionally, the linear mass-spring model does not account for headform diameter. However, in the regression equation used in Section 3.2, it was found that a change in headform diameter did in fact have an effect on the change in HIC. To allow for this, a scaling factor for the change in headform diameter was used, based on the empirical data. There is no theoretical justification for this scaling factor in the linear mass-spring model.

Another factor that is not taken into account by the linear mass-spring model is the effect of ‘bottoming out’. This is where the structure being impacted deforms sufficiently that it comes into contact with a much stiffer structure underneath (e.g. the engine block). The linear mass-spring model assumes that the structure being impacted can deform as much as necessary. The data used for the regression in Section 3.2 did include some impacts with bottoming out present, and so the effect was accounted for somewhat in the regression results. However, there were ANCAP tests on the vehicles considered in Section 4 that would have involved bottoming out, and the GTR HIC estimates for these locations may be significantly different to what would be obtained in a real test.

The performance estimates in Section 4 were based on the maximum and minimum possible HICs for each zone, but this was done on the basis of some assumptions. The first assumption was that the test result from a specific location applies to the entire subzone in which it appears. In reality, it is likely that the rest of the subzone would score differently. Because of this, the area estimations may be slightly overestimated.

The second assumption was that the ANCAP test location was in fact the worst location (or subzone) of the entire zone, and that the manufacturer test location was in fact the worst location (or subzone) of those nominated. If the worst location was not selected by ANCAP, this will tend to underestimate potential HIC values under the GTR.



The third assumption was that the manufacturer nominated subzones would all perform better than those which were not nominated. Finally, in cases where the manufacturer location has actually turned out to be worse than the ANCAP location, it was assumed that that subzone was the worst.

These assumptions may not be valid, as the test location selection process is subjective, and is based on the test house's experience and judgement as to which test location will result in the highest HIC value. Additionally, these assumptions rely on the manufacturer having some knowledge of which subzones are likely to perform better than others. Clearly this is not always the case, as on occasion the manufacturer nominates subzones which end up performing worse than the originally nominated ANCAP subzone. However, in the majority of cases these assumptions would be expected to reflect reality.

It is not possible to generalise about how potential biases brought about by these assumptions weigh on the results, short of conducting a more extensive GTR test program on a greater number of vehicles. While the approach to estimating GTR performance has been even handed, it has not been possible to control for violations of the assumptions that underpin it.

## 5.2 Conclusion

Of the three vehicles tested, two were estimated to fail the GTR requirements. The Toyota Camry exceeded the maximum allowable HIC of 1700 in one location, and the Holden Commodore exceeded this HIC at two locations. The Mazda3 passed the GTR requirements.

For the bulk analysis of ANCAP tested vehicles, the HIC values obtained from ANCAP test locations were scaled using the method developed and validated in Section 3. A series of rules were used, based on the point selection process, in order to arrive at an upper and lower estimate for each vehicle's performance against the 3 criteria of the GTR.

The criterion that was most likely to be failed was the maximum HIC of 1700. The other two criteria were related to the size of the 'relaxation zone', the area in which the HIC was allowed to exceed 1000, but still had to be less than 1700. The first of these criteria was that the relaxation zone cannot exceed 1/3 of the total test area, and the second of these criteria was that the relaxation zone cannot exceed 1/2 of the child test area. The first of these was found to be the limiting factor – in all cases that it was passed, the second criterion was also passed, but not vice versa.

Performance under the two relaxation zone criteria was an unknown for many of the vehicles – in the best-case scenario they would pass, and in the worst-case scenario they would fail. A minimal amount of vehicles were estimated to fail either of these criteria – two out of all vehicles, one of which was current.

If only current vehicles are considered, then around half of those tested by ANCAP were estimated to pass the GTR with little or no modification. The majority of the remaining vehicles were estimated to exceed a HIC of 1700 in at least one location, and may or may not have passed the relaxation zone (they would pass in the best-case scenario, and fail in the worst-case scenario).

As might be expected, vehicles that performed better in the headform testing component of ANCAP were more likely to pass the headform testing requirements of the GTR.

It would appear the primary benefit of the GTR would be in eliminating the most dangerous locations on the front of the vehicle for the head of a struck pedestrian – those that exceed a HIC of 1700 under the GTR test conditions. These are locations that might score as highly as a HIC of 3000 under ANCAP for a child test. The majority of vehicles would appear to require at least minor redesign in

order to meet this requirement. This result was suggested in the testing of the three vehicles to the child headform requirements of the GTR, and also in the analysis of many vehicles tested by ANCAP.

This would imply that the GTR would have an effect on vehicle design, in that most vehicles would require some improvements in design for pedestrian protection. However, many vehicles would not require any design improvements in order to meet the current GTR requirements, and others would require only minor modification.

## Acknowledgements

---

This study was funded by the Australian Department of Infrastructure, Transport, Regional Development and Local Government, through a Project Grant to the Centre for Automotive Safety Research.

Results have also been used from the Australasian New Car Assessment Program (ANCAP), who contract the Centre for Automotive Safety Research to test selected new vehicles for pedestrian protection.

The Centre for Automotive Safety Research is supported by both the South Australian Department for Transport, Energy and Infrastructure and the South Australian Motor Accident Commission.

The views expressed in this report are those of the authors and do not necessarily represent those of the University of Adelaide or the funding organisations.

## References

---

- Chou CC, Nyquist GW (1974). Analytical Studies of the Head Injury Criterion. SAE Paper #740082. Warrendale: Society of Automotive Engineers.
- European New Assessment Programme (EuroNCAP) (2009). EuroNCAP Pedestrian Testing Protocol Version 4.3.
- McLean AJ (2005). Vehicle design for pedestrian protection. CASR Report #037. Adelaide: Centre for Automotive Safety Research.
- Mizuno K, Kajzer J (2000). Head Injuries in Vehicle-Pedestrian Impact. SAE Paper #2000-01-0157. Warrendale: Society of Automotive Engineers.
- Searson DJ, Anderson RWG (2009). 'Predicting vehicle performance under the Global Technical Regulation on Pedestrian Protection using ANCAP test results', in Proceedings of the 2009 Australasian Road Safety Research, Policing and Education Conference, Sydney, New South Wales, 10-12 November 2009.
- United Nations Economic Commission for Europe (UNECE) (2009). Draft Regulation on Pedestrian Safety. Document ECE/TRANS/WP.29/GRSP/2009/10.
- United Nations Economic Commission for Europe (UNECE) (1998). Agreement Concerning The Establishing Of Global Technical Regulations For Wheeled Vehicles, Equipment And Parts Which Can Be Fitted And/Or Be Used On Wheeled Vehicles.
- Versace J (1971). 'A Review of the Severity Index', in Proceedings of the 15th Stapp Car Crash Conference, Coronado, California, 17-19 November 1971.