

University of Windsor

Scholarship at UWindor

Electronic Theses and Dissertations

Theses, Dissertations, and Major Papers

1-1-1983

A comparative study between the measured and the predicted performance of a test house using the DOE-2.1A building energy simulation program.

Tariq Y. Khan
University of Windsor

Follow this and additional works at: <https://scholar.uwindsor.ca/etd>

Recommended Citation

Khan, Tariq Y., "A comparative study between the measured and the predicted performance of a test house using the DOE-2.1A building energy simulation program." (1983). *Electronic Theses and Dissertations*. 6784.

<https://scholar.uwindsor.ca/etd/6784>

This online database contains the full-text of PhD dissertations and Masters' theses of University of Windsor students from 1954 forward. These documents are made available for personal study and research purposes only, in accordance with the Canadian Copyright Act and the Creative Commons license—CC BY-NC-ND (Attribution, Non-Commercial, No Derivative Works). Under this license, works must always be attributed to the copyright holder (original author), cannot be used for any commercial purposes, and may not be altered. Any other use would require the permission of the copyright holder. Students may inquire about withdrawing their dissertation and/or thesis from this database. For additional inquiries, please contact the repository administrator via email (scholarship@uwindsor.ca) or by telephone at 519-253-3000ext. 3208.

A COMPARATIVE STUDY BETWEEN THE MEASURED AND THE
PREDICTED PERFORMANCE OF A TEST HOUSE USING THE
DOE-2.1A BUILDING ENERGY SIMULATION PROGRAM

By

TARIQ.Y.KHAN

A thesis submitted to the faculty of graduate
studies in partial fulfillment of the
requirements for the degree of
Master of Applied Science
in
Department of Mechanical Engineering
University of Windsor

Windsor, Ontario, 1983

UMI Number: EC54770

INFORMATION TO USERS

The quality of this reproduction is dependent upon the quality of the copy submitted. Broken or indistinct print, colored or poor quality illustrations and photographs, print bleed-through, substandard margins, and improper alignment can adversely affect reproduction.

In the unlikely event that the author did not send a complete manuscript and there are missing pages, these will be noted. Also, if unauthorized copyright material had to be removed, a note will indicate the deletion.

UMI[®]

UMI Microform EC54770
Copyright 2010 by ProQuest LLC
All rights reserved. This microform edition is protected against
unauthorized copying under Title 17, United States Code.

ProQuest LLC
789 East Eisenhower Parkway
P.O. Box 1346
Ann Arbor, MI 48106-1346

TO MY MOTHER

ABSTRACT

A comparative study between the measured and predicted performance of a test house has been carried out at the University of Windsor. One objective of this study was to design a simplified experimental monitoring system for single family residences. A further objective was to monitor the performance of a passive solar test house and compare the measured results with the predictions obtained by the custom weighting factor method of the DOE-2.1A computer program's, using actual on-site weather conditions.

The test house was located at the north shore of Lake Erie in Wheatley, Ontario. It was a newly-constructed, two-storey, passive solar residence with high insulation levels. The house was monitored in an unoccupied state during the early spring of 1982. The measured results indicated that the house had serious construction flaws which caused excessive infiltration under the influence of strong southerly winds. A fan depressurization test was carried out which indicated that the south and east walls of the house contained large leakage openings. This explained the directional sensitivity of the test house to strong southerly winds.

The test house was simulated as a four zone building in order to independently study the performance of spaces that were oriented towards the south. Zone-1 of the test model included living room and kitchen on the upper level facing south. Zone-2 included a master bedroom and two washrooms located in the north-

west corner of the upper level. Zone-3 comprised of two large bedrooms on the lower level which faced south. Zone-4 included underground spaces in the north corner of lower level. The crack length and the residential methods were used to model infiltration in zone-1, zone-2 and zone-3 of the test model. The residential method was used to model infiltration in zone-4 of the test model.

Since direct gain passive solar features were included in zone-1 of the test model, the measured and predicted performance of this space was analyzed in greater detail. The hourly comparisons for zone-1 showed that during all clear sunny days, except for strong southerly winds, the program was quite capable of simulating the measured temperature excursions and performance of the baseboard heaters. This indicated that the dynamics of the custom weighting factor method are accurate enough to model the performance of direct gain passive solar buildings.

The total daily energy requirements of zone-1 predicted by using the crack length infiltration method were in close agreement with the actual values. This indicated the suitability using of the crack length method to model infiltration in a multizone building that has a non-uniform distribution of leakage areas. The daily energy predictions, obtained by the crack length method were also in close agreement with the measured energy requirements of zone-2.

Zone-3 had a unique leakage characteristics due to a large leakage opening, located beneath the lower southern overhang,

which caused high infiltration in this space. The simulated results for this zone were not comparable to the measured values, due to limitation of the program to model abnormal leakage through a horizontal opening. Hence this zone was excluded from comparative analysis.

Since zone-4 was entirely below grade, it remained least affected by the wind directional effects. In general, close agreement was obtained between the measured and the predicted daily energy requirements of this zone.

ACKNOWLEDGEMENTS

The level of appreciation and respect that I feel towards my supervisors Prof. W.G.Colborne and Dr. N.W.Wilson cannot be expressed in words. Their sincere cooperation, invaluable guidance and genuine patience have been a continuing source of encouragement throughout the course of this study and is most gratefully acknowledged.

I am also thankful to Dr W.T.Kierkus for his worthy suggestions and constructive criticism. My special thanks are also extended to Dr. T.W.McDonald for his interest and support in this study.

I would also like to express my gratitude to Mr. W.Beck and Mr. R.Tattersal for their cooperation and help in the set up of the experimental monitoring system. I wish to convey my thanks to all my colleagues who have been extremely cooperative and who have assisted me in so many ways.

Finally, my thanks are also due to the National Science and Engineering Research Council of Canada and the Mechanical Engineering Department, University of Windsor, for providing the necessary financial support and other assistance to enable me to carry out this research.

TABLE OF CONTENTS

ABSTRACT	-----	ii
ACKNOWLEDGEMENTS	-----	v
CONTENTS	-----	vi
LIST OF FIGURES	-----	x
LIST OF TABLES	-----	xiii
NOMENCLATURE	-----	xv
<u>CHAPTER</u>		<u>PAGE</u>
I	INTRODUCTION -----	1
II	LITERATURE SURVEY -----	4
	INTRODUCTION -----	4
	ENERGY MONITORING PROJECTS FOR SINGLE FAMILY RESIDENCES -----	5
	COMPARATIVE STUDIES FOR SINGLE FAMILY RESIDENCES -----	7
	DISCUSSION -----	15
	SUMMARY -----	17
III	THE BUILDING -----	19
	SELECTION OF TEST HOUSE -----	19
	GENERAL DESCRIPTION -----	19
	CONSTRUCTION DETAILS -----	25
	HEATING SYSTEM -----	31
	DESIGN HEATING LOAD -----	34
IV	SELECTION OF A SIMULATION PROGRAM -----	36
V	EXPERIMENTAL MONITORING OF THE TEST HOUSE -----	40
	INTRODUCTION -----	40
	INSTRUMENTATION -----	41
	DATA ACQUISITION SYSTEM -----	48
	TEST PERIOD -----	53
VI	DEVELOPMENT OF A WEATHER FILE -----	55
	INTRODUCTION -----	55
	THE DOE WEATHER PROCESSOR -----	55

	INPUT REQUIREMENTS OF THE WEATHER PROCESSOR --	56
	PROCESSING OF WEATHER DATA -----	59
	DURATION OF THE WEATHER FILE -----	73
	SUBROUTINE " OTHER " -----	75
	THE WEATHER FILE -----	75
VII	MODELLING OF THE TEST-HOUSE -----	78
	MODELLING -----	78
	THERMAL ZONING OF THE TEST-HOUSE -----	79
	MATERIALS LIBRARY -----	83
	MODELLING OF STRUCTURAL MEMBERS -----	88
	MODELLING OF TROMBE WALL -----	90
	MODELLING OF WINDOWS AND DOORS -----	90
	MODELLING OF FURNITURE -----	94
	INTERNAL HEAT GAINS -----	95
	INFILTRATION -----	96
	MODELLING OF UNDERGROUND SURFACES -----	102
	MODELLING OF THE HEATING SYSTEM -----	103
VIII	RESULTS AND DISCUSSION -----	105
	INTRODUCTION -----	105
	ANALYSIS OF ZONE-1 -----	109
	HOURLY ANALYSIS OF RESULTS FOR ZONE-1 -----	111
	HOURLY COMPARISON OF ZONE-1 UNDER CLEAR SKY AND LOW WIND CONDITIONS -----	111
	HOURLY COMPARISON OF ZONE-1 UNDER CLEAR SKY AND HIGH NORTHERLY WINDS -----	120
	HOURLY COMPARISON OF ZONE-1 DURING A CLOUDY DAY -----	124
	HOURLY COMPARISON OF ZONE-1 UNDER HIGH SOUTHERLY WINDS -----	130
	DAILY COMPARISON OF ENERGY CONSUMPTION FOR ZONE-1 -----	130
	ANALYSIS OF ZONE-2 -----	137
	HOURLY RESULTS FOR ZONE-2 -----	137
	HOURLY COMPARISON OF ZONE-2 DURING A CLOUDY DAY -----	138
	HOURLY COMPARISON OF ZONE-2 DURING A CLEAR DAY -----	141
	HOURLY COMPARISON OF ZONE-2 UNDER HIGH NORTHERLY WINDS -----	141
	DAILY COMPARISON OF ENERGY CONSUMPTION FOR ZONE-2 -----	145
	DAILY ENERGY COMPARISON FOR ZONE-4 -----	148
	SUMMARY OF RESULTS -----	154
IX	CONCLUSIONS AND RECOMMENDATIONS -----	157

X	REFERENCES -----	162
---	------------------	-----

APPENDIX		PAGE
-----		-----

A.	DESIGN HEATING LOAD CALCULATIONS -----	167
	DESIGN CALCULATIONS FOR THE TEST HOUSE -----	168
	DESIGN CONDITIONS -----	172
	ASSUMPTIONS -----	173
	DESIGN HEAT TRANSMISSION COEFFICIENTS -----	173
	DESIGN CALCULATIONS FOR ZONE-1 -----	176
	DESIGN CALCULATIONS FOR ZONE-2 -----	177
	DESIGN CALCULATIONS FOR ZONE-3 -----	178
	DESIGN CALCULATIONS FOR ZONE-4 -----	182
	DESIGN HEAT LOSS OF THE TEST HOUSE -----	184
B.	INSTRUMENTATION AND DATA ACQUISITION SYSTEM -----	185
	HEATER MONITOR PICKUPS -----	186
	ANEMOMETER -----	189
	WIND DIRECTION METER -----	194
	PYRANOMETERS -----	197
	RADIOSHACK MICROCOMPUTER -----	199
	FLUKE DATA LOGGER -----	200
	DATA ACQUISITION SYSTEM -----	204
	SYSTEM MONITORING PROGRAMS -----	206
C.	DATA PROCESSING PROGRAMS -----	217
D.	FAN DEPRESSURIZATION TEST -----	225
	INTRODUCTION -----	226
	INFILTRMETER -----	227
	FAN TEST -----	229
	RESULTS -----	232
	CONCLUSIONS -----	237
E.	CALCULATION OF EFFECTIVE U-VALUES FOR THE UNDERGROUND WALLS AND FLOORS -----	243
	DOE-2 BASEMENT HEAT LOSS MODEL -----	244
	EFFECTIVE U-VALUES FOR UNDERGROUND WALLS -----	245
	EFFECTIVE U-VALUE FOR THE CONCRETE FLOOR ZONE-3	246
	EFFECTIVE U-VALUE FOR THE CONCRETE FLOOR ZONE-4	247
F.	THE DOE WEATHER PROCESSOR INPUT LISTINGS -----	249
G.1	THE DOE-2 INPUT LISTINGS FOR THE TEST HOUSE (RESIDENTIAL INFILTRATION METHOD) -----	254
G.2	THE DOE-2 INPUT LISTINGS FOR THE TEST HOUSE (CRACK LENGTH INFILTRATION METHOD) -----	264

LIST OF FIGURES

FIGURE -----		PAGE -----
3.1	SOUTH VIEW OF THE TEST HOUSE-----	21
3.2	NORTH VIEW OF THE TEST HOUSE-----	21
3.3	EAST VIEW OF THE TEST HOUSE-----	22
3.4	FLOOR PLAN OF THE TEST HOUSE (UPPER - LEVEL) ---	23
3.5	FLOOR PLAN OF THE TEST HOUSE (LOWER - LEVEL) ---	24
3.6	CONSTRUCTIONAL AND INSULATION DETAILS OF THE WALL ON THE UPPER AND LOWER LEVELS OF THE TEST HOUSE--	26
3.7	CONSTRUCTIONAL AND INSULATION DETAILS OF THE ROOF ON THE UPPER AND LOWER LEVELS OF THE TEST HOUSE--	27
3.8	CONSTRUCTIONAL DETAILS OF THE INTERIOR PARTITION WALLS-----	28
3.9	PASSIVE SOLAR FEATURES OF THE TEST HOUSE-----	33
5.1	FLOOR PLAN OF THE UPPER LEVEL SHOWING THE LOCATION OF WEATHER STATION AND TRANSDUCERS-----	42
5.2	FLOOR PLAN OF THE LOWER LEVEL SHOWING THE LOCATION OF TRANSDUCERS-----	43
5.3	WEATHER STATION -----	45
5.4	SCHEMATIC OF THE COMPUTERIZED DATA ACQUISITION SYSTEM INSTALLED IN THE TEST HOUSE-----	50
6.1	FLOW DIAGRAM TO ANALYZE SOLAR RADIATION -----	66
6.2	COMPARISON BETWEEN MEASURED AND ASHRAE CALCULATED TOTAL SOLAR RADIATION ON A HORIZONTAL SURFACE UNDER CLEAR SKY CONDITIONS-----	71
6.3	COMPARISON BETWEEN ASHRAE CALCULATED AND THE DERIVED DIRECT NORMAL SOLAR RADIATION UNDER CLEAR SKY. CONDITIONS-----	72
7.1	ISOMETRIC VIEW OF THE TEST HOUSE SHOWING THE BUILDING COORDINATE SYSTEM -----	80
7.2	FLOOR PLAN OF THE UPPER LEVEL SHOWING THE DETAILS OF ZONE-1 AND ZONE-2-----	81
7.3	FLOOR PLAN OF THE LOWER LEVEL SHOWING THE DETAILS OF ZONE-3 AND ZONE-4-----	82
7.4	GEOMETRIC CONFIGURATION OF ZONE-1-----	84
7.5	GEOMETRIC CONFIGURATION OF ZONE-2-----	85
7.6	GEOMETRIC CONFIGURATION OF ZONE-3-----	86
7.7	GEOMETRIC CONFIGURATION OF ZONE-4-----	87
8	CROSS-SECTIONAL VIEW OF THE TROMBE WALL -----	107
8.1.0	PLAN VIEW OF THE UPPER LEVEL SHOWING THE LOCATION OF LEAKAGE OPENINGS -----	110
8.2.A	HOURLY MEASURED AND PREDICTED PERFORMANCE OF ZONE-1 DURING A CLEAR SUNNY DAY WITH LOW WINDS	

	(CRACK LENGTH METHOD)	-----	113
8.2.B	HOURLY MEASURED AND PREDICTED PERFORMANCE OF ZONE-1 DURING A CLEAR SUNNY DAY WITH LOW WINDS (RESIDENTIAL METHOD)	-----	115
8.2.C	HOURLY MEASURED AND PREDICTED PERFORMANCE OF ZONE-1 DURING A CLEAR SUNNY DAY WITH LOW WINDS (CRACK LENGTH METHOD)	-----	117
8.2.D	HOURLY MEASURED AND PREDICTED PERFORMANCE OF ZONE-1 DURING A CLEAR SUNNY DAY WITH LOW WINDS (RESIDENTIAL METHOD)	-----	119
8.3.A	HOURLY MEASURED AND PREDICTED PERFORMANCE OF ZONE-1 DURING A CLEAR SUNNY DAY WITH HIGH NORTHERLY WINDS (CRACK LENGTH METHOD)	-----	121
8.3.B	HOURLY MEASURED AND PREDICTED PERFORMANCE OF ZONE-1 DURING A CLEAR SUNNY DAY WITH HIGH NORTHERLY WINDS (CRACK LENGTH METHOD)	-----	123
8.3.C	HOURLY MEASURED AND PREDICTED PERFORMANCE OF ZONE-1 DURING A CLEAR SUNNY DAY WITH HIGH NORTHERLY WIND (RESIDENTIAL METHOD)	-----	125
8.4	HOURLY MEASURED AND PREDICTED PERFORMANCE OF ZONE-1 DURING A CLOUDY DAY WITH LOW WINDS	-----	126
8.5	HOURLY MEASURED AND PREDICTED PERFORMANCE OF ZONE-1 DURING A CLEAR SUNNY DAY WITH HIGH SOUTHERLY WINDS	-----	131
8.6	COMPARISON BETWEEN DAILY MEASURED AND PREDICTED ENERGY CONSUMPTION FOR ZONE-1	-----	133
8.7.A	HOURLY MEASURED AND PREDICTED PERFORMANCE OF ZONE-2 DURING A CLOUDY DAY WITH LOW WINDS (CRACK LENGTH METHOD)	-----	139
8.7.B	HOURLY MEASURED AND PREDICTED PERFORMANCE OF ZONE-2 DURING A CLOUDY DAY WITH LOW WINDS (RESIDENTIAL METHOD)	-----	140
8.8.A	HOURLY MEASURED AND PREDICTED PERFORMANCE OF ZONE-2 DURING A CLEAR SUNNY DAY WITH LOW WINDS (CRACK LENGTH METHOD)	-----	142
8.8.B	HOURLY MEASURED AND PREDICTED PERFORMANCE OF ZONE-2 DURING A CLEAR SUNNY DAY WITH LOW WINDS (RESIDENTIAL METHOD)	-----	143
8.9	HOURLY MEASURED AND PREDICTED PERFORMANCE OF ZONE-2 DURING A CLEAR SUNNY DAY WITH HIGH NORTHERLY WINDS	-----	144
8.10	DAILY ENERGY COMPARISON FOR ZONE-2	-----	146
8.11	COMPARISON BETWEEN DAILY MEASURED AND PREDICTED ENERGY CONSUMPTION FOR ZONE-4	-----	151

A.1	A SCHEMATIC OF THERMAL ZONES ON THE UPPER LEVEL OF THE TEST HOUSE	-----	169
A.2	A SCHEMATIC OF THERMAL ZONES ON THE LOWER LEVEL OF THE TEST HOUSE	-----	170
A.3	SEGMENTS OF BELOW GRADE WALLS ZONE-3	-----	179
A.4	SECTIONS OF CONCRETE FLOOR ZONE-3	-----	181
B.1.1	A SCHEMATIC OF HEATER MONITOR PICKUPS	-----	187
B.2.1	A SCHEMATIC OF ANEMOMETER	-----	190
B.2.2	CALIBRATION CURVE FOR ANEMOMETER	-----	193
B.3.1	A SCHEMATIC OF WIND DIRECTION METER	-----	195
B.3.2	CALIBRATION CURVE FOR WIND DIRECTION METER	----	198
B.8.1	FLOW CHART FOR FLKCON1	----	209
B.8.2	FLOW CHART FOR FLKCON2	----	210
D.1	INFILTROMETER UNIT	----	228
D.2	LEAKAGE CHARACTERISTIC CURVES FOR THE TEST HOUSE	----	236

LIST OF TABLES

TABLE		PAGE
5.1	SYMBOLIC REPRESENTATION OF TRANSDUCERS INSTALLED IN THE WEATHER STATION AND THE TEST HOUSE -----	44
5.2	CHANNELS MONITORED IN THE WEATHER STATION -----	51
5.3	CHANNELS MONITORED IN THE TEST HOUSE -----	52
6.1	WIND DIRECTION IN DEGREES CLOCKWISE FROM NORTH AND THEIR INTEGER EQUIVALENT -----	58
6.2	CORRELATION COEFFICIENT BETWEEN CLOUD COVER AND CLOUD COVER FACTOR -----	64
6.3	SOLAR RELATED VARIABLES AS A FUNCTION OF 21ST DAY OF EACH MONTH -----	69
6.4	SOLAR RELATED VARIABLE ADJUSTED TO DAILY BASIS FOR THE TEST DURATION -----	70
6.5	A SAMPLE OUTPUT OF THE WEATHER FILE -----	77
7.1	MATERIALS LIBRARY -----	89
7.2	PROPERTIES OF WINDOW GLASSES -----	93
7.3	REGRESSION COEFFICIENTS FOR RESIDENTIAL INFILTRATION MODEL -----	99
8	DAILY COMPARISON OF THE TOTAL MEASURED AND PREDICTED ENERGY CONSUMPTION OF ZONE-1, ZONE-3, ZONE-4 FOR MARCH 25TH. -----	129
8.1.A	PERCENTAGE COMPARISON OF THE DAILY MEASURED AND PREDICTED ENERGY CONSUMPTION OF ZONE-1 (CRACK LENGTH METHOD) -----	134
8.1.B	PERCENTAGE COMPARISON OF THE DAILY MEASURED AND PREDICTED ENERGY CONSUMPTION OF ZONE-1 (RESIDENTIAL METHOD) -----	135
8.2.A	PERCENTAGE COMPARISON OF THE DAILY MEASURED AND PREDICTED ENERGY CONSUMPTION OF ZONE-2 (CRACK LENGTH METHOD) -----	149
8.2.B	PERCENTAGE COMPARISON OF THE DAILY MEASURED AND PREDICTED ENERGY CONSUMPTION OF ZONE-2 (RESIDENTIAL METHOD) -----	150
8.3	PERCENTAGE COMPARISON OF THE DAILY MEASURED AND PREDICTED ENERGY CONSUMPTION OF ZONE-4 (RESIDENTIAL METHOD) -----	152
A.1	DESIGN HEAT TRANSMISSION COEFFICIENTS OF EXTERIOR WALLS AND CEILINGS -----	174
A.2	HEAT TRANSMISSION COEFFICIENTS FOR WINDOWS & DOORS	174
A.3	HEAT TRANSMISSION COEFFICIENTS FOR UNDERGROUND WALLS -----	175

B.1.1	MEASURED POWER CONSUMPTION OF BASEBOARD HEATERS DATA ACQUISITION SYSTEM AND REFRIGERATOR UNIT----	188
B.1.2	ENERGY METER READINGS -----	188
B.2.1	EXPERIMENTAL DATA FOR ANEMOMETER CALIBRATION ---	191
B.3.1	EXPERIMENTAL DATA FOR WIND DIRECTION METER CALIBRATION -----	196
B.6.1	LOW LEVEL SCANNER SPECIFICATIONS -----	202
B.6.2	ISOTHERMAL BLOCK CONNECTOR SPECIFICATIONS -----	202
B.6.3	THERMOCOUPLE TOTAL SYSTEM ACCURACY -----	205
B.6.4	PROGRAMMING CODE FOR TEMPERATURE LINEARIZATION OPTION -----	205
B.7.1	SUMMARY OF RAM ADDRESSES USED IN MODEL III -----	207
B.7.2	SWITCH SETTINGS ON RS-232-C IN FLUKE 2240C -----	207
B.7.3	SCALE SETTING FOR DIFFERENT TRANSDUCERS WITHIN DATA LOGGER -----	208
B.8.1	LISTINGS OF FLKCON1 -----	211
B.8.2	LISTINGS OF FLKCON2 -----	212
B.8.3	NOMENCLATURE OF VARIABLES USED IN FLKCON2 -----	214
D.1	LISTINGS OF ENERSEAL PROGRAM -----	230
D.2	PRESSURE DATA FOR FIRST FAN TEST -----	233
D.3	PRESSURE DATA FOR SECOND FAN TEST -----	233
D.4	LEAKAGE DATA FOR THE TEST HOUSE -----	234
D.5	CALCULATION OF INFILTRATION RATE FOR THE TEST HOUSE USING FAN TEST RESULTS IN GRIMSRUD'S MODEL	238
D.6	LEAKAGE RATES OF DIFFERENT HOUSES TESTED BY THE NATIONAL RESEARCH COUNCIL OF CANADA -----	241

NOMENCLATURE

- A - Surface area (Ft²)
- A_m - Amplitude of ground surface temperature fluctuation (F)
- AP - Apparent solar irradiation (Btu/Hr.Ft²) at air mass=1 (ASHRAE 1977 Handbook of Fundamentals)
- BP - Atmospheric extinction coefficient (Dimensionless) (ASHRAE 1977 Handbook of Fundamentals)
- BLAST - Building Load Analysis System Thermodynamics (Reference - 11)
- C - Flow coefficient (Ft³ / min at a unit pressure difference)
- CC - Cloud cover (0 - 100, Dimensionless)
- CF - Cloud cover factor (Dimensionless)
- COS(DIR) - Cosine of wind direction w.r.t surface outward normal
- CN - Clearness number (Dimensionless) (ASHRAE 1977 Handbook of Fundamentals)
- CP - Sky diffuse factor (Dimensionless) (ASHRAE 1977 Handbook of Fundamentals)
- CZ - Direction cosine of direct solar beam.
- DE - Declination angle (Radians). The angle that the sun ray makes with the equatorial plane at solar noon is called the angle of declination.
- DELTA - Indoor - outdoor temperature difference (F) (Eq 7.3)
- DOE-2.1A - United States Department of Energy Building Energy Simulation Program (Reference 22)
- DN - Direct normal radiation estimated for the site location (Btu/ Hr. Ft²)
- ELA - Equivalent leakage area of the test house (m²)
- ET - Equation of time (Hours). Difference between local

solar time and local civil time is called the equation of time.

(ASHRAE 1977 Handbook of Fundamentals)

- F - Heat loss coefficient of exposed edge for slab on grade constructions (Btu/Hr.Ft.F)
- GC - Glass conductance (Btu / Hr. Ft. F)²
- GLAS - Graphical load analysis system (Reference - 4)
- HY - Hour angle (Degrees)
(ASHRAE 1977 Handbook of Fundamentals)
- HW - Hour angle (Radians)
- h - Mean height of liquid column in the inclined manometer (inches)
- I - Infiltration (air changes per hour)
- ID - Diffuse radiation on a horizontal surface for cloudless sky conditions (Btu / Hr. Ft)²
- IH - Direct radiation on a horizontal surface for cloudless sky conditions (Btu / Hr. Ft)²
- IN - Direct normal radiation for a cloudless sky conditions (Btu / Hr. Ft.)²
- IT - Total radiation on a horizontal surface for cloudless sky conditions. (Btu / Hr. Ft)²
- K1,K2,K3 - Coefficients of residential infiltration model (Eq 7.3)
- L - Perimeter of exposed edge of slab on grade construction (Ft)
- LA - Latitude of site location (Degrees)
- LO - Longitude of site location (Degrees)
- n - Flow exponent
- NBSLD - National Bureau of Standards Load Determination Program (Reference - 10)
- P - Cloudless sky factor (Eq - 6.1)

PATM	- Atmospheric pressure (inches Hg)
PTWV	- Wind pressure (inches H ₂ O)
PSE	- Pressure due to stack effect (inches of H ₂ O)
PT	- Total pressure caused by wind and stack effect (inches of H ₂ O)
Q	- Coefficient of cloud cover factor equation (Eq - 6.1)
Qd	- Design heat loss (Btu / Hr)
Qf	- Air change rate of the house at a pressure difference of 50 Pascals.
qs	- Design sensible infiltration heat loss (Btu / Hr)
R	- Coefficient of cloud cover factor equation
RD	- Diffuse radiation on horizontal surface at the test location (Btu / Hr. Ft ²)
RH	- Total radiation measured on a horizontal surface at the test location (Btu / Hr. Ft. ²)
RN	- Direct radiation on a horizontal surface at the test location (Btu / Hr.Ft ²)
Tb	- Design indoor temperature of basement (F)
To	- Outdoor drybulb temperature (F)
Ti	- Indoor drybulb temperature (F)
Tg	- Average monthly ground temperature (F)
Tdg	- Design indoor and ground temperature difference (F)
TRNSYS	- A Transient Simulation Program (Reference - 6)
TRY	- Test Reference Year (National Climatic Centre, Ashville, North Carolina)
TMY	- Typical Meteorological Year (National Climatic Centre, Ashville, North Carolina)
- ta	- Mean annual air temperature (F)

TZ	- Time zone of the test location
U	- Overall heat transmission coefficient (Btu / Hr.Ft.F) ²
U _m	- Modified heat transmission coefficient for windows and patio doors (Btu / Hr. Ft .F) ²
U-eff	- Effective heat transmission coefficient for underground surfaces (Btu / Hr . Ft. F) ²
V	- Design wind speed (knots)
V _e	- Output voltage from anemometer and wind direction meter (Volts)
V _o	- Volume of the test house (m) ³
Wd	- Wind direction (Degrees)
WYEC	- Weather Year for Energy Computation (National Climatic Centre, Ashville, North Carolina)
Z	- Angle between the sun's rays and normal to a horizontal surface.
ZHT	- Distance from the zone mid height to the neutral pressure level (Ft)
θ	- Inclination of the manometer (Degrees)
δ _{liq}	- Density of manometer liquid (lbs/cu.ft)
δ _{air}	- Density of air (lbs/cu.ft)
Δ P	- Pressure difference (Pascals)

CHAPTER I

INTRODUCTION

As a result of energy shortages in the 1970's, much concern has been expressed in both the private and public sectors about the world's future energy requirements. Limited fossil energy reserves, ever increasing demand for energy and rapidly escalating energy costs have forced consumers to look for alternative sources of energy and improved methods of utilization in all major sectors of energy consumption. One major area of interest is residential buildings. Considerable energy savings can be realized in this sector if construction features and energy resources are properly utilized for efficient heating and cooling of these buildings. In order to improve energy efficiency in these buildings, several energy conservation measures can be implemented in both newer designs and older constructions. These energy conservation measures include tighter construction and super-insulation of the building envelope to reduce transmission and infiltration losses, optimum selection of the environmental control equipment for efficient energy usage and passive features to utilize solar energy for space heating. There is, however, a need for a simulation procedure that can be used at the design stage to accurately predict energy savings potential associated with each of the energy conservation options considered.

In the past, detailed calculation procedures for energy analysis of buildings were considered to be expensive and time

consuming. However, with the advent of modern computers it has now become possible to perform a rigorous simulation of a building including factors which affect the building performance and the system's operation. As a result, several simulation programs have been developed which have become available for public use. Notable among these are the DOE-2.1A, BLAST and the NBLSD programs. These programs are based on refined and sophisticated procedures and are effective means of analyzing a building's thermal performance.

The use of computer simulation has become an accepted method for energy conservation studies of residential buildings. The DOE-2.1A computer program has been used extensively in this area and its suitability has been well demonstrated. This program was used to establish the Building Energy Performance Standards for residential buildings (17). It was also used to develop retrofit strategies for two types of residential dwellings in Canada (14). Recently the power of the program has been increased by the addition of the custom weighting factor method (12) of calculating a building's thermal load. This method has mainly been introduced to accurately model the thermal inertia of buildings. It can be used to simulate the performance of buildings that has large temperature swings such as a passive solar design. In the past, not much attention has been paid to the hourly verification of this method for passive solar residences, primarily due to lack of sufficient experimental data. Hourly verification of the custom weighting factor method is, however, necessary to determine the accuracy of

the program to predict the thermal behaviour passive solar residences for which the prime design objective is to minimize indoor temperature floats and to maximize the use of solar energy for space heating. The present study was, therefore, undertaken to determine the accuracy of the program for a passive solar residence.

The objectives of the present study are outlined as follows:

1. To design a simplified energy monitoring system that can be used with a minimum of supervision to measure and record the outdoor weather conditions and indoor performance of single family residences on an hourly basis.
2. To install the system in an unoccupied passive solar test house and monitor the hourly indoor space temperatures and space heat addition rates during the early spring of 1982.
3. To perform a detailed hourly comparison between the actual and predicted space temperatures and space heat addition rates of the test house, under identical weather condition, using the custom weighting factor method of the DOE-2.1A Program.

CHAPTER II
LITERATURE SURVEY

2.1 INTRODUCTION

Since the development of energy simulation programs, and their wide applicability for energy analysis of various types of buildings, it has become extremely important to establish the accuracy of these programs for practical use. This is generally accomplished by comparing the measured and predicted performance of a building under identical weather conditions. This comparison should, however, be based on performance data that is closely related to a problem being studied. In the past, several comparative studies have been carried out to determine the accuracy of simulation programs for residential buildings. The material covered in this chapter is divided in two main sections and describes the previous work done in the area of residential energy monitoring and building energy simulation.

The first section describes the instrumentation and data acquisition systems that were used in two different residential energy monitoring projects. The main objective of these projects was to generate sufficient outdoor weather and indoor performance data which could be used for the validation of energy simulation programs.

The second section is entirely devoted to the comparative studies carried out for conventional and passive-solar single family residences using the GLAS, TRNSYS, DEROB, BLAST, NBSLD

and the DOE-2 programs. These studies were generally based on an individual comparison of total energy consumption, hourly cooling loads and the measured / predicted values of the space temperatures. This section also includes limited work done by the Los Alamos Scientific Laboratory to verify the accuracy of the custom weighting factor method of the DOE-2 program, for four different classes of residential and commercial buildings (13) .

2.2 ENERGY MONITORING PROJECTS FOR SINGLE FAMILY RESIDENCES

In the year 1975-76, David T. Harrje and Richard A. Grott (1), from the Centre for Environment Studies at Princeton University, conducted extensive experimental monitoring to determine energy usage of town houses in the Twin River Project, New Jersey. The measurements systems included a remote weather station, data acquisition systems, standard instrumentation to measure indoor space temperatures, furnace gas consumption, energy consumption of electrical appliances, an automated air infiltration measurement unit using SF₆ as a tracer gas and infrared thermography for identifying localized heat losses in the building envelope. Two identical data acquisition systems were used to process data from the test houses and the weather station. Data from the acquisition systems was transmitted over telephone lines to the Energy Utilization Laboratory at Princeton University, where the data was recorded on magnetic tapes. When both data acquisition systems were on line, the data from test houses were logged every twenty minutes and the weather data

logged every hour. Results of the automated infiltration measurement system indicated 0.5 to 1.0 air changes per hour for three test town houses. Infrared thermography detected various constructional defects in the building envelope such as missing or poorly installed insulation at corners, etc. The monitoring system functioned properly over the test period with the exception of a few occasions when experimental data was lost due to power failure at the site. Nevertheless, sufficient useful data was collected and later utilized by Wayne Robertze et al (3) to validate the GLAS (4) simulation program developed at Cornell University to within 1 percent.

Charles D.Jones et.al., (2), of the Mechanical Engineering Department, University of Ohio, conducted a similar but more sophisticated experimental monitoring of nine test residences located in Columbus, Ohio. The objective of this project was to collect 400 items of weather and indoor thermal performance data for approximately one year. The quality of the recorded data was considered to be important as it was intended to be used for validation studies. In this project, several different types of standard instruments were used to measure the climatic variables, indoor space temperatures, gas/air flow rates and electrical consumption of various household appliances. The data acquisition system basically consisted of five IBM System 7 computers installed at the test sites (adjacent sites sharing a single unit) and directly on line with an IBM-1130 Central Processor, through long leased wires. Selected channels were sampled and data transmitted every 15 minutes to the Central

Processor, where the data was averaged on an hourly basis and permanently stored on the magnetic disks. In order to ensure quality control, the digital inputs were scanned 200 times per second and analog inputs once every second by the System 7. The Central Processor had 8K core and 500K disk storage. Data stored on the disks were retrieved daily for examination and proper conversion into engineering units, using an IBM 370/165 computer. The monitoring system functioned successfully over the test period with occasional transmission errors and loss of experimental data due to unavoidable power failures at the test-site and the central processing unit.

It can be concluded from these residential energy monitoring projects that computerized data acquisition systems can successfully be used to determine the thermal performance of single-family residences over an extended period of time. The data acquisition and transmission systems used in these projects were relatively complex because several residences were being monitored at the same time. Besides power failure, the transmission of experimental data through long leased wires also created problems due to noise effects which resulted in transmission errors.

2.3 COMPARATIVE STUDIES FOR SINGLE FAMILY RESIDENCES

Wayne Robertze et.al., (3) used experimental data from three highly instrumented town houses of the Twin River project (1), to validate an existing thermal analysis program by comparing its

prediction to the metered energy usage. An interactive computer graphics program, GLAS (4), developed at Cornell University, and operational on a microcomputer, was used for this validation study. Constructional details and internal load profiles for the test houses were adequately described to the program. Infiltration rates of 0.5 and 0.75 air change per hour at 15 miles per hour wind were respectively used for the first two and the third house. The test houses were simulated for a period of six weeks using actual weather data. Simulation results were output graphically both in an hourly and a daily format. Excellent agreement was reported between the measured and predicted energy usage of the first two houses. Deviations in the predicted totals for gas usage were less than 1 percent for these two houses. The agreement between the measured and predicted energy usage for the third house was not as good and was within 10 percent of the metered data

J.W.Mitchell et.al., (5) performed a comparative analysis of measured and predicted thermal behaviour of the Colorado State University Solar House, over three periods of six, ten and eleven days using actual weather conditions. Space heating of the test house was accomplished by a liquid based active solar system with ethylene glycol mixture as the working substance. Backup heat was provided by a gas fired furnace and an electric hot water heater. A transient simulation program, TRNSYS (6), developed by the Solar Energy Laboratory at the University of Wisconsin, was used to simulate the building and the system components. The house was simulated as a single zone residence, with average

internal heat gains over the three test periods. The ASHRAE recommended values of 1 to 1.5 air changes per hour were reported to have produced unrealistically high infiltration loads. These values were modified to model infiltration rates of 0.7 and 0.3 air change per hour, respectively, for occupied and unoccupied hours. Measured and predicted performance of the system components was reported to be in close agreement. Comparison between the measured and predicted results were reported to be within 3.5 to 7.0 percent for collected solar energy, 0.0 to 3.6 percent for air heater heat flow, 2.7 to 3.1 percent for delivered solar energy, and 0.0 to 3.7 percent for auxiliary heat.

Francisco Arumi-Noe and David O. Northrup (7) made hourly comparisons of the measured and predicted performance of the Balcomb residence, a 2,500 sq.ft., two-storey, L-shaped greenhouse structure in Santa-Fe, New Mexico. Solar heating was accomplished by a hybrid active/passive system. Heated air was drawn from the top of the greenhouse, blown over radiant rockbeds, and then returned back to the green house. Test data for this building was collected by the Los Alamos Scientific Laboratory, in the middle of February 1978. The building was simulated using the DEROB (8) computer program, developed by the Numerical Simulation Laboratory at the University of Texas in Austin. Part of the weather data used for this simulation was collected at the site during the test period and the rest was extracted from the weather tape of Las Vegas, a location having

a similar climate. Results of this study were based on hourly comparisons of the measured and predicted temperatures of the greenhouse and the rockbeds. In general, the agreement between the measured and simulated temperatures was within 5 percent. The largest discrepancies of 10 and 17 percent were observed on the 10th and 14th of February, respectively, in the glass house temperatures which were attributed to air stratification effects. Based on these results, the authors concluded that the DEROB program was capable of predicting the observed measurements consistently within a margin of 5 %, with occasional departures up to 17 percent.

T. Kusuda et.al., (9) have reported the results of an hourly comparison between the measured and the predicted cooling loads and attic temperatures of a conventional house in Houston, Texas, using NBSLD (10),BLAST (11) and DOE-2 (22) simulation programs. The test house was a slab on grade with wood frame construction backed by face brick on the exterior. The house had a ventilated attic and a total conditioned area of 1,106 sq.ft. Cooling in the house was provided by a 2.5 ton central air conditioning unit with the cooled and dehumidified air distributed through insulated metal ducts in the attic. The test house was monitored for a period of four months covering July through October, 1977. The measured hourly cooling loads were, however, compared for a period of three days when the outdoor weather conditions were almost identical. In all three programs, the test house was modelled as a two zone residence with a conditioned living area

and an unconditioned attic. Infiltration rates of 0.6 ach were used in all three simulation programs. Since the measured indoor temperatures fluctuated between 75 and 82 degrees F, the test house was simulated for two indoor temperature levels of 76 and 78 degrees F, respectively.

It was found in this study that, in comparison to the NBSLD computed values, the measured cooling loads were higher until 8:00 AM. The peak cooling load, however, occurred at the same time beyond which the measured cooling loads decreased slowly compared to the calculated values. This discrepancy stemmed from the fact that in the NBSLD calculations the heat storage effects of the interior furnishings and partitions were not accounted for. Although the cooling load predictions obtained by DOE-2 and BLAST showed a good tracking of the measured loads, the DOE-2 predictions were significantly higher than the actual values showing a pronounced heat storage effect. The discrepancy in DOE-2's results was explained on the basis of ASHRAE's standard weighting factors which did not precisely model the thermal mass of the house.

Comparisons between the NBSLD simulated and the measured attic temperatures were in close agreement except that a slight phase shift was observed in the two results. Similar comparisons of attic temperatures with DOE-2 and BLAST were reported to be in poor agreement on an hourly basis but were close on a daily basis.

J.F.Kerrisk et.al., (13), of the Los Alamos Scientific Laboratory, carried out hourly comparisons of the measured and predicted performance of four different test buildings to determine the accuracy of the custom weighting factor method of the DOE-2.1 program. These included: a high mass test building in the National Bureau of Standards environmental chamber, a conventional residence, a direct gain office and warehouse building, and a direct gain passive solar residence.

The performance of the test house built in the National Bureau of Standard environmental chamber was experimentally measured for two different sets of conditions using a diurnal sol-air temperature cycle typical of Saudi Arabia. In the first case, hourly heat extraction rates were measured from 6:00 AM to 6:00 PM, when the indoor temperature was held approximately constant at 75 degrees F by a cooling system. In the second case, night ventilation was employed at the rate of 14 air changes per hour, from 10:00 PM to 6:00 AM, and the resulting temperatures were measured for a period of 24 hours. The structure was modelled and simulated using the custom weighting factor method for identical indoor and outdoor environmental conditions. Hourly comparisons of the predicted cooling loads and the indoor space temperature profiles with the measured values showed that the two results were in close agreement.

It was pointed out earlier that the measured cooling loads of the Houston test house were not in close agreement when the standard weighting factor method of the DOE-2 program was

used (9). The simulation was revised, for the same three days with identical outdoor weather conditions, using the custom weighting factor method of the DOE-2.1 program (13). The indoor temperatures were controlled at 76 and 78 degrees F, respectively. The hourly values of the predicted cooling loads were reported to be in close agreement with the measured results.

A 7,000 sq.ft., direct gain office and warehouse building located in Pecos, New Mexico was also used for a similar comparative analysis. The building contained a large water wall in the office area for thermal storage. Thermal performance of the building was measured by the Los Alamos Scientific Laboratory, in the middle of February 1980. In preparing the building's input for the DOE-2 program, the water wall was modelled as a massive interior wall. The building was simulated using the custom weighting factor method of the DOE-2 program. Hourly comparison between the measured and simulated warehouse temperatures for February 10 to 15 showed close agreement until noon, but a slight drift was observed in the predicted values during the late afternoon. Similar comparisons for the office area were not in close agreement and deviations up to 39 degrees F were reported among the measured and predicted temperatures. This large discrepancy was attributed to the massive water wall that could not be handled adequately by the DOE-2 program.

A direct gain, 1,270 sq.ft., single-family residence of adobe construction, located in Santa Fe, New Mexico, was also used

for a similar comparative analysis based on the indoor temperatures. Performance of the building was monitored by the Los Alamos Scientific Laboratory in January 1980. Hourly comparisons between the measured and DOE-2 predicted temperatures were made for January 18 to 22. The two temperatures were reported to be in close agreement. A second comparison for a five day period was not in good agreement. A probable cause for the disagreement was high indoor temperatures and clear days which led to increased ventilation through open windows.

John D. Hall (14) has recently carried out a validation study of the custom weighting factor method of the DOE-2.1A program. The scope of this study included an annual comparison between the measured and predicted heating / cooling energy consumption for two existing conventional houses located in Windsor, Ontario. One of the houses had a full basement and a gross floor area of 1,000 sq.ft. The other house was a slab on grade construction with a gross floor area of 1,010 sq.ft. Heating and cooling in the two houses was provided, respectively, through a gas fired furnace and electric central air conditioning units. The two houses were modelled as occupied residences and were simulated for a period of one year using the Detroit TRY weather tape for the year 1968. Simulated annual energy consumption was compared to the measured data available from the utility records. Excellent agreement was obtained between the two results. The heating energy and cooling energy requirements agreed within 5 and 3 percent, respectively, for both the houses. The results of this study showed that the custom weighting factor method is an

accurate means of predicting the annual energy consumption of residential buildings.

2.4 DISCUSSION

The literature cited in the preceding sections showed that the criteria for comparing the measured and the predicted performance of single family residences are generally based on their constructional design. For a conventional design, where the indoor temperatures are relatively stable, the program's accuracy is determined by comparing the measured and predicted energy usage over an extended test period (3,14). In the case of a passive solar design, the program's verification was based only on an hourly comparison between the observed and predicted temperatures. Although most comparative studies for single family residences were limited in scope, they demonstrated close agreement between the measured and predicted results obtained using the GLAS, NBSLD, DEROB, TRNSYS and the DOE-2 programs. It was concluded from these results that computer simulations are an accurate means of predicting the thermal performance of single family residences.

During the literature survey, it was also observed that most of the comparative studies, carried out for passive solar residences, were confined to the buildings located in moderate climates such as Texas and New Mexico (7,13). Little attention was paid to the validation of simulation programs for similar buildings located in the colder regions of North America.

In Canada alone, 20 percent of the total energy use is attributed to space heating of residential buildings (15). In the development of residential energy conservation strategies much effort has been made towards the efficient utilization of solar energy for space heating (16). Computer simulations are finding increased applications to evaluate the building performance at preliminary design stages. To develop confidence in the use of these programs, it is essential that comparative studies be carried out for different types of residences located in the colder regions of the United States and Canada. Such comparisons would determine the applicability and accuracy of these programs for evaluation of residential energy conservation measures in these regions.

In a passive solar design for colder climates, space temperatures and heat addition rates are two important parameters from the view point of human comfort and energy conservation. These parameters would vary under the influence of continuously changing outdoor weather conditions. The verification of simulation programs for such buildings must be based on a simultaneous comparison of measured and predicted values of these inter related variables. In the previous comparative studies for passive solar buildings (7,13), the program's verification was based solely on the hourly verification of indoor temperatures. No work has been reported in which the measured temperatures and heat addition rates were simultaneously compared with the predicted values. This lack of information calls for a

comparative study of a passive solar building that is based on a simultaneous comparison between the measured and predicted values of space temperatures and space heat addition rates on an hourly basis.

2.5 SUMMARY

The literature reviewed in the context of comparative studies for single family residences can be summarised as follows:

1. Experimental data is of vital importance to verify the accuracy of energy simulation programs for residential buildings. It is, therefore, essential to develop simplified energy monitoring systems that could be used with a minimum of supervision to generate sufficient test data for single family residences.
2. There is a further need for experimental verification of simulation programs that are currently being used to predict thermal performance and to develop energy conservation strategies for single family residences located in the colder regions of the United States and Canada. Verification of these programs should be carried out under controlled conditions for different types of residential buildings.
3. The custom weighting factors method is a recent addition in the DOE-2 program. So far, not enough work has been done to verify the accuracy of this method to predict the

hourly performance of passive solar buildings . It is, therefore, imperative to carry out detailed experimentation on a passive solar house, the results of which could be utilized to verify the accuracy of this method on an hourly basis.

CHAPTER III
THE BUILDING

3.1 SELECTION OF THE TEST HOUSE

At the start of this project, an unoccupied house was selected for experimentation and energy analysis. It was a newly constructed two storey residence, located 55 Km away from Windsor, on the north shore of Lake Erie in Wheatley, Ontario. The house was constructed within the sloping grade of the lakeside cliff and was not shielded by neighbouring houses against the effect of strong winds. The house was considered suitable for energy conservation studies due to its super-insulation levels, expected tighter construction and passive solar features which were installed to take advantage of its southerly exposure. The house was made available in an unoccupied state for the test period.

3.2 GENERAL DESCRIPTION

The test house was a passive solar, super-insulated residential dwelling constructed by N.K.Becker & Associates, in the year 1981. The structure was oriented 24 degrees east of south and lay approximately at 42.31 degrees north latitude and 83.0 degrees longitude. The south, north, and east elevations of the building are shown in Figures 3.1, 3.2 and 3.4. The details of the floor plan on the upper and lower levels of the house are shown in Figures 3.4 and 3.5. The upper level of the house was totally above grade constituting 896

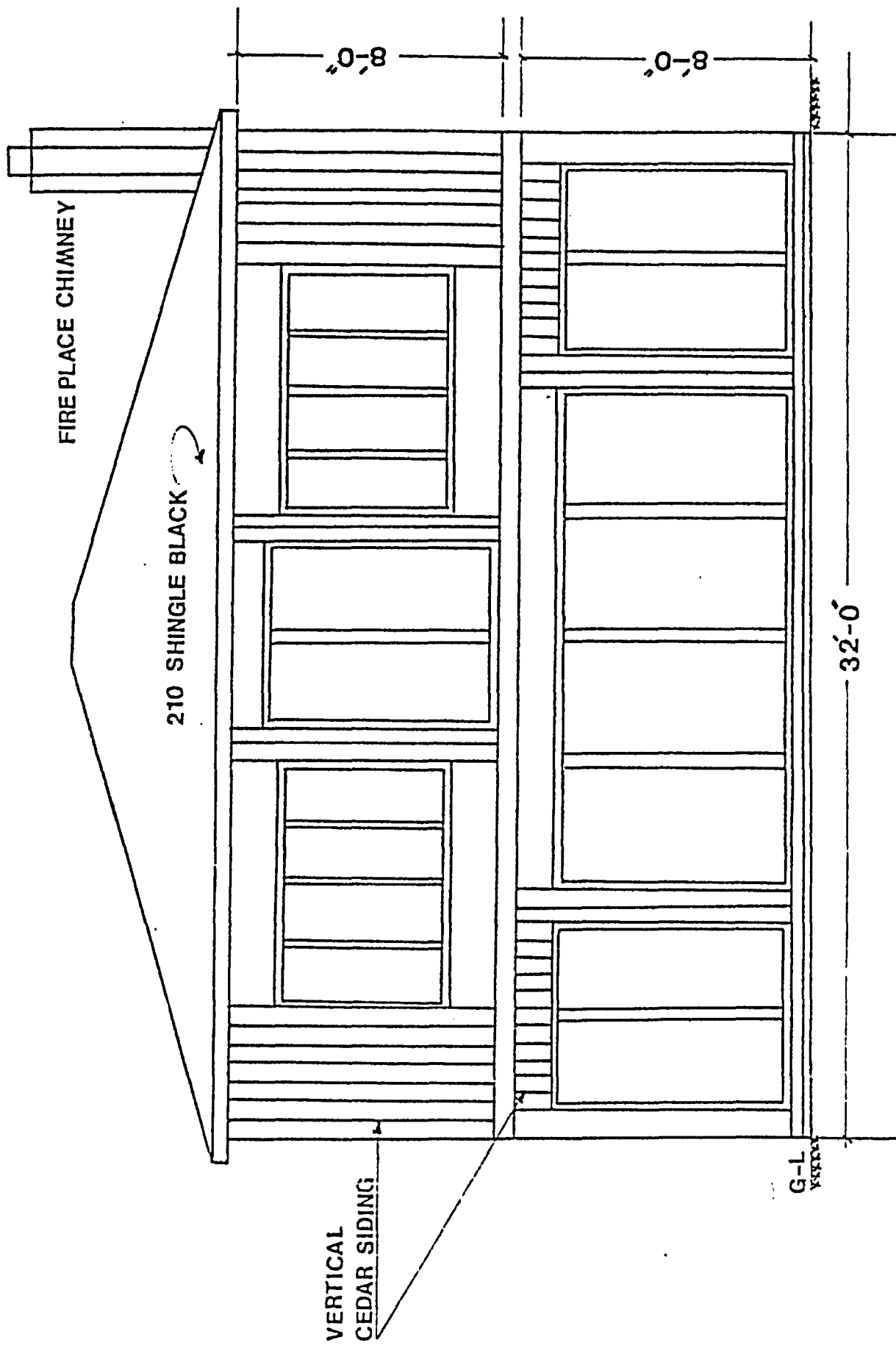

FIGURE 3.1 SOUTH VIEW OF THE TEST HOUSE

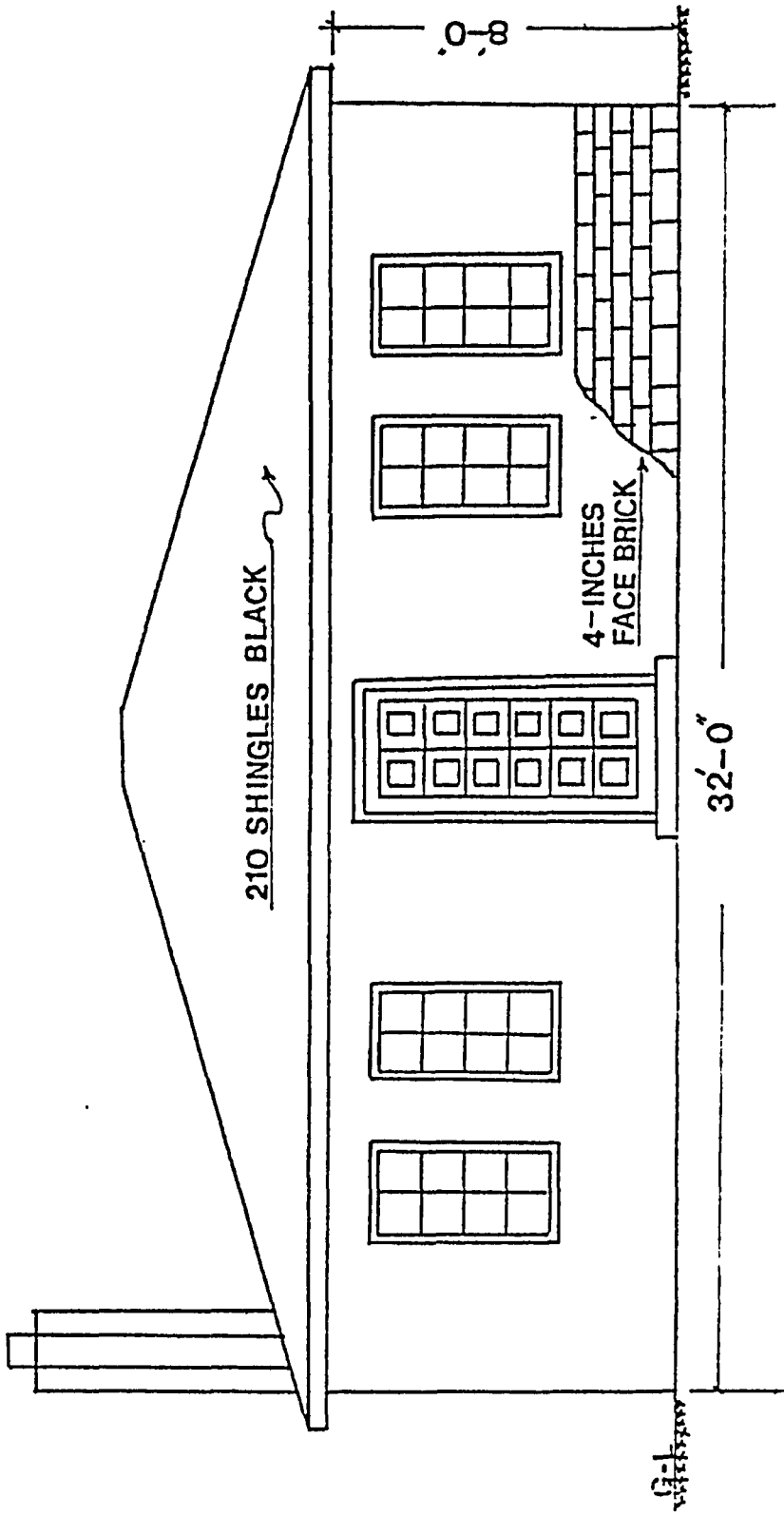

FIGURE 3.2 NORTH VIEW OF THE TEST HOUSE

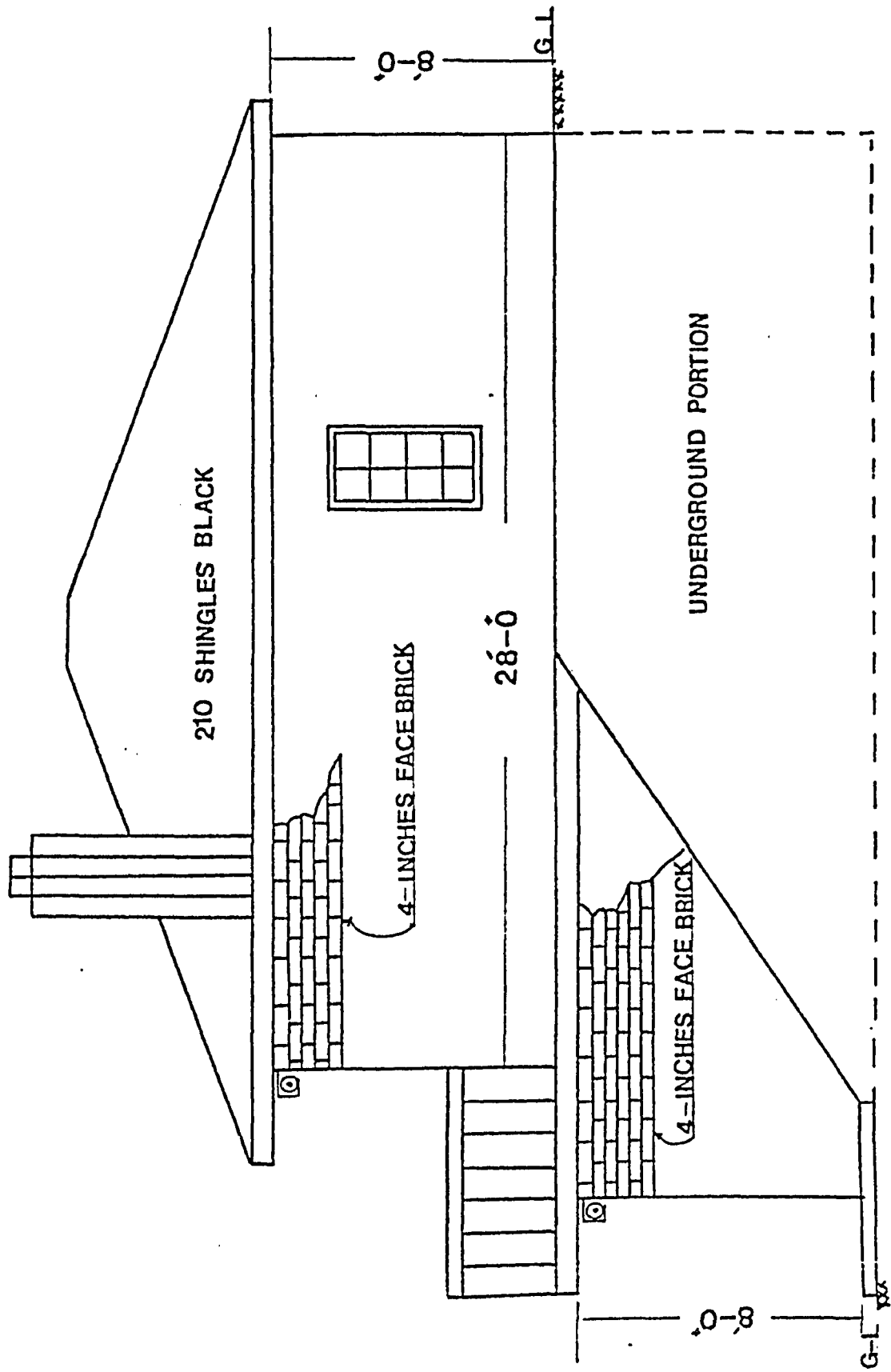

FIGURE 3.3 EAST VIEW OF THE TEST HOUSE

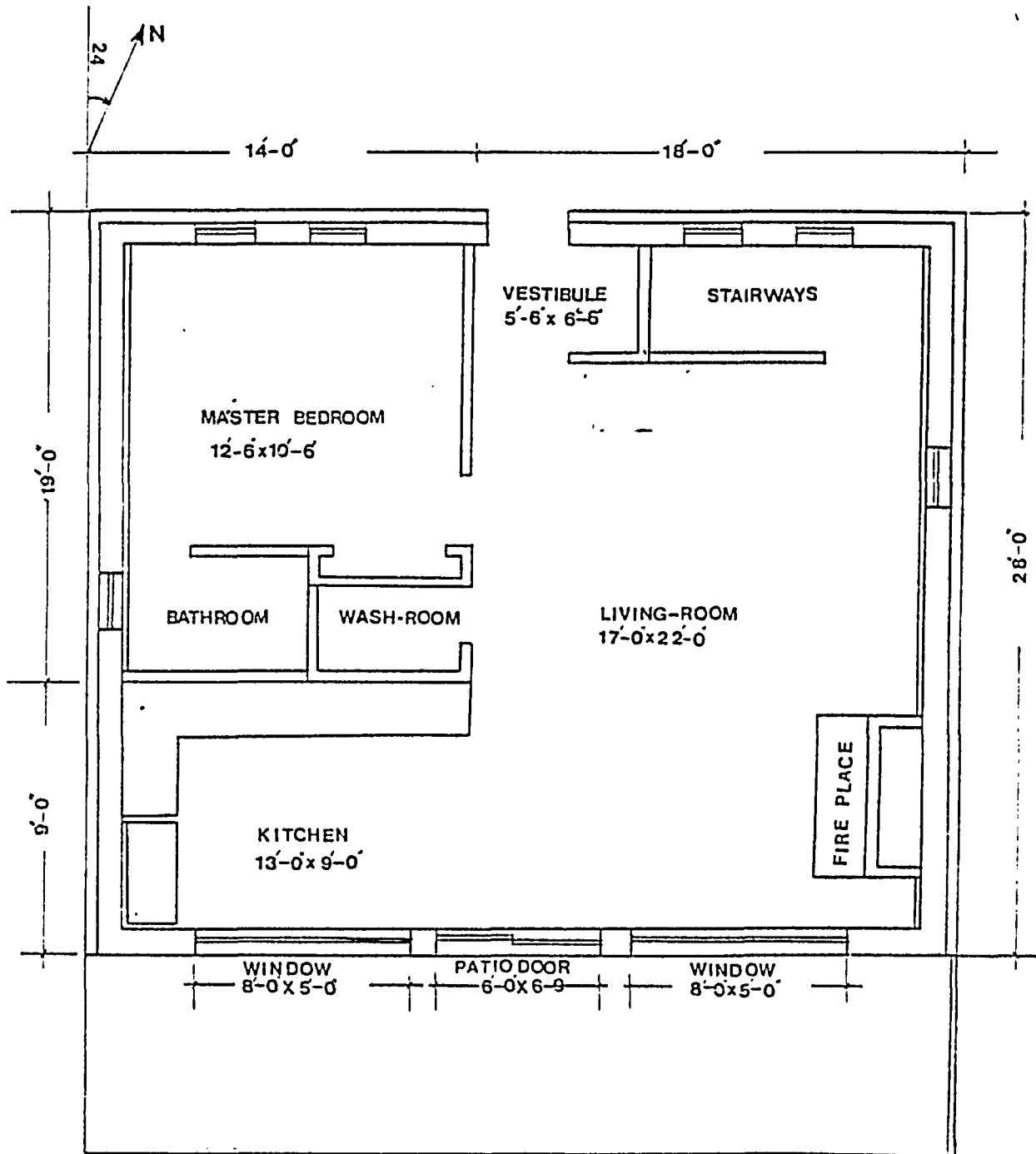

FIGURE 3.4 FLOOR PLAN OF THE TEST HOUSE
(UPPER-LEVEL)

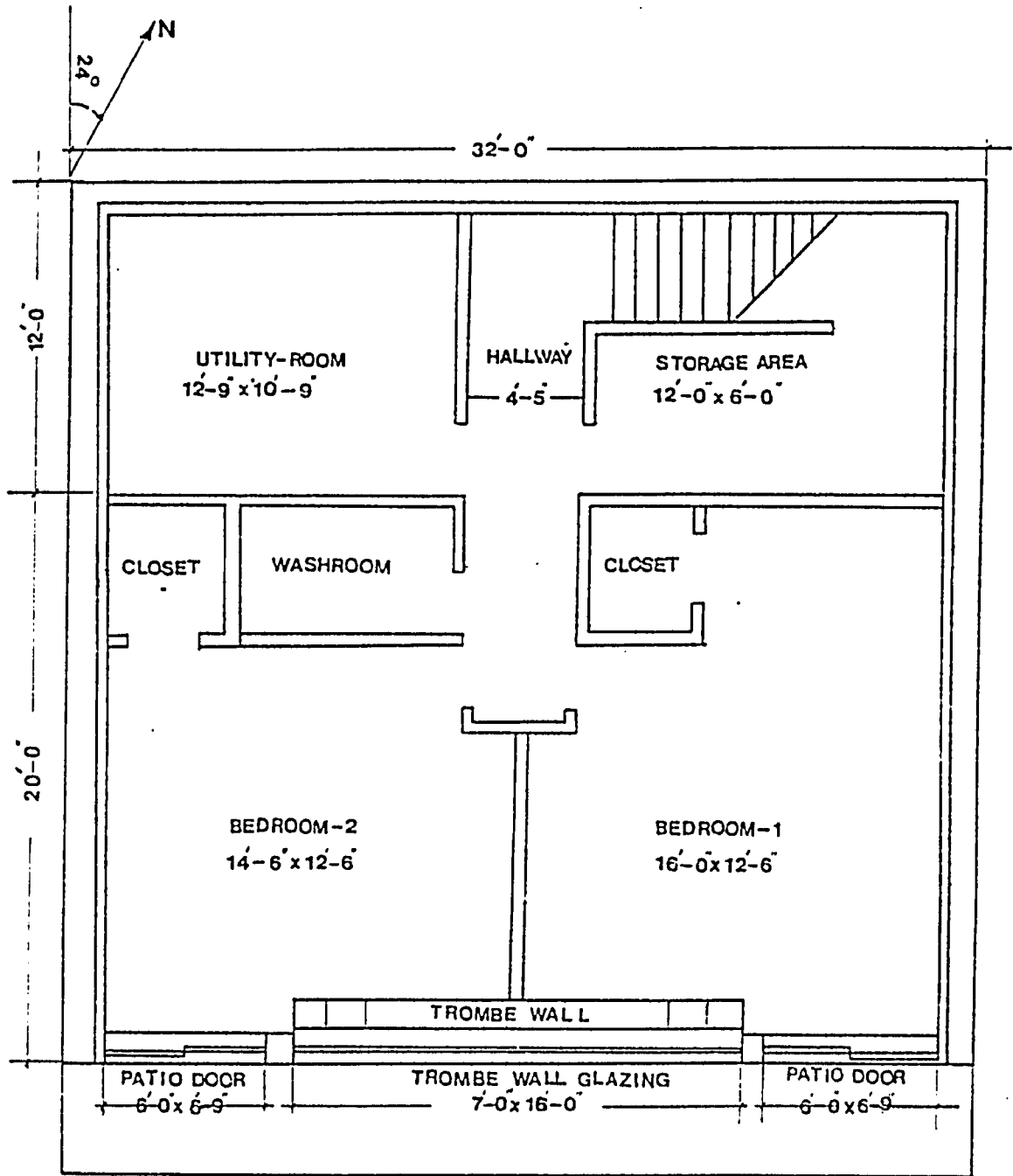

FIGURE 3.5 FLOOR PLAN OF THE TEST HOUSE
(LOWER-LEVEL)

sq.ft., of the total heated area. This floor consisted of a kitchen and a living room on the south and a master bedroom with a bath ensuite in the north-west corner. The main entrance to the house was centred in the north wall of this level. Two large 5.0 ft x 8.0 ft windows and a 6.75 ft x 6.00 ft sliding glass patio door were located in the south wall of this level. Four small 4.0 ft x 2.0 ft windows were also located in the northern walls of the living and master bedrooms. The lower level of the house constituted 1,024 sq.ft. of the total heated area and was below grade on the north side and at grade on the south side. The east and west walls of this level were about 70 percent below grade, with the grade sloping down to the grade level on the south. The south wall of this floor was 75 percent glazed with two 6.75 ft x 6.00 ft sliding glass patio doors on either end and a 7.0 ft x 16.0 ft glazing for a 10 inch concrete wall. This level contained two large bedrooms facing south. A utility room, a storage area and a hallway containing a staircase were located in the northern end of this floor.

3.3 CONSTRUCTION DETAILS

A cross-sectional view of the solar house along with construction and insulation details of the walls, ceilings and floor on the upper and lower level are shown in Figures 3.6 to 3.8.

The exterior walls on the east, west and north side of the upper floor were made up of double staggered, 16 inches on-center 2x4 wood framing backed on the outer side by 4 inch face

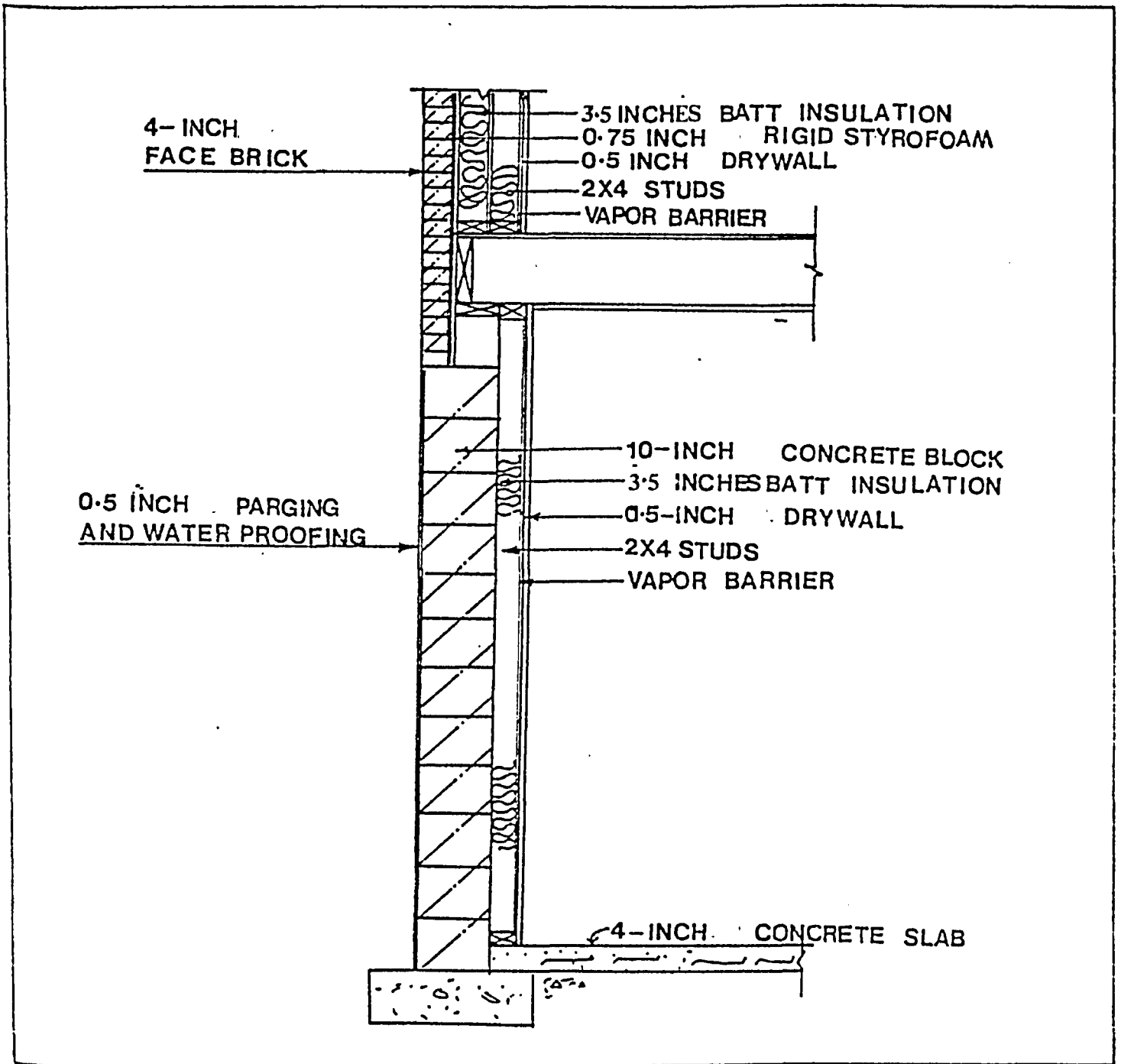

FIGURE 3.6 CONSTRUCTIONAL AND INSULATION
DETAILS OF THE WALL ON THE
UPPER AND LOWER LEVELS OF THE
TEST HOUSE

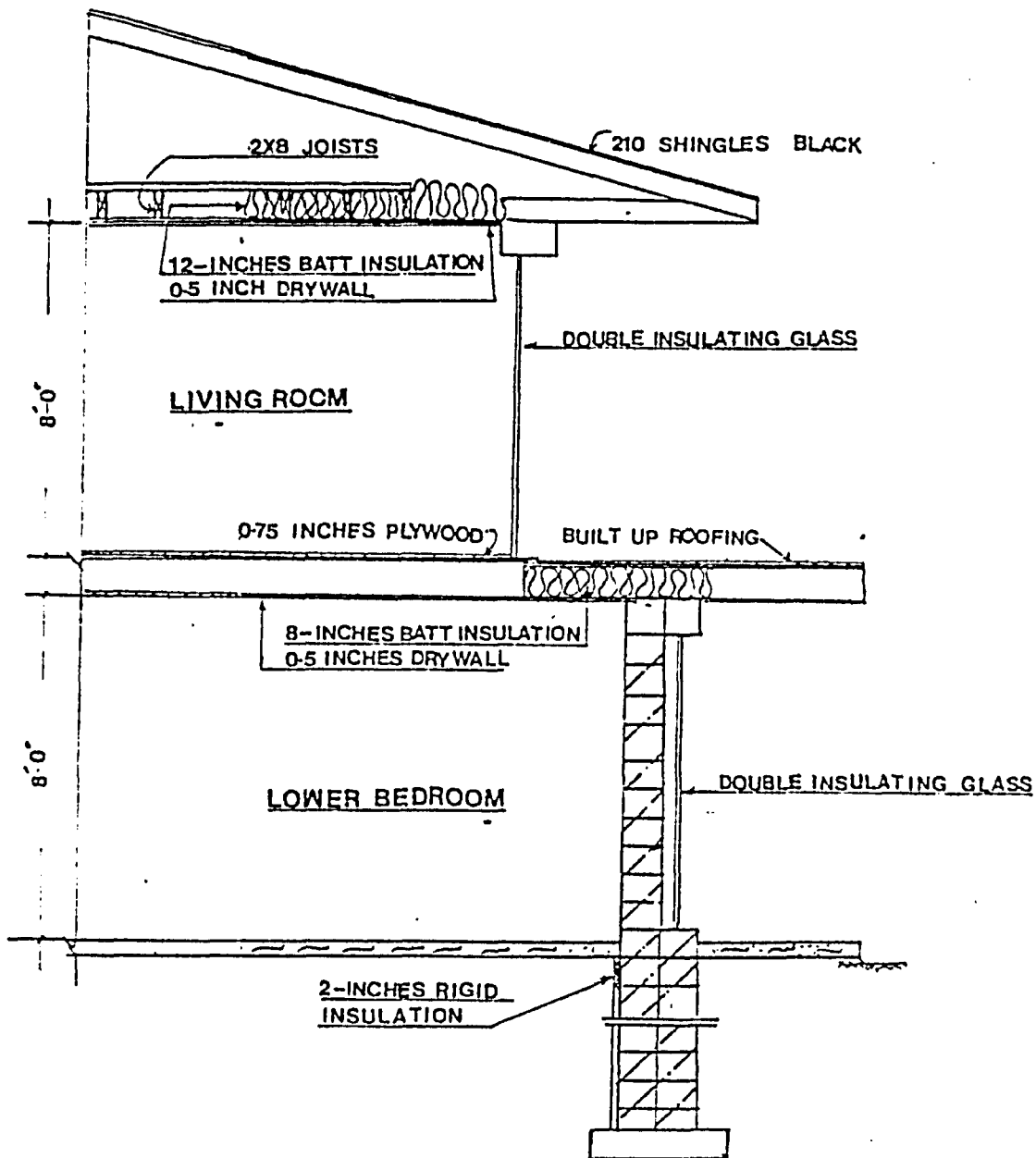

FIGURE 3.7 CONSTRUCTIONAL AND INSULATION DETAILS OF THE ROOFS AND FLOORS ON THE UPPER AND LOWER LEVELS OF THE TEST HOUSE

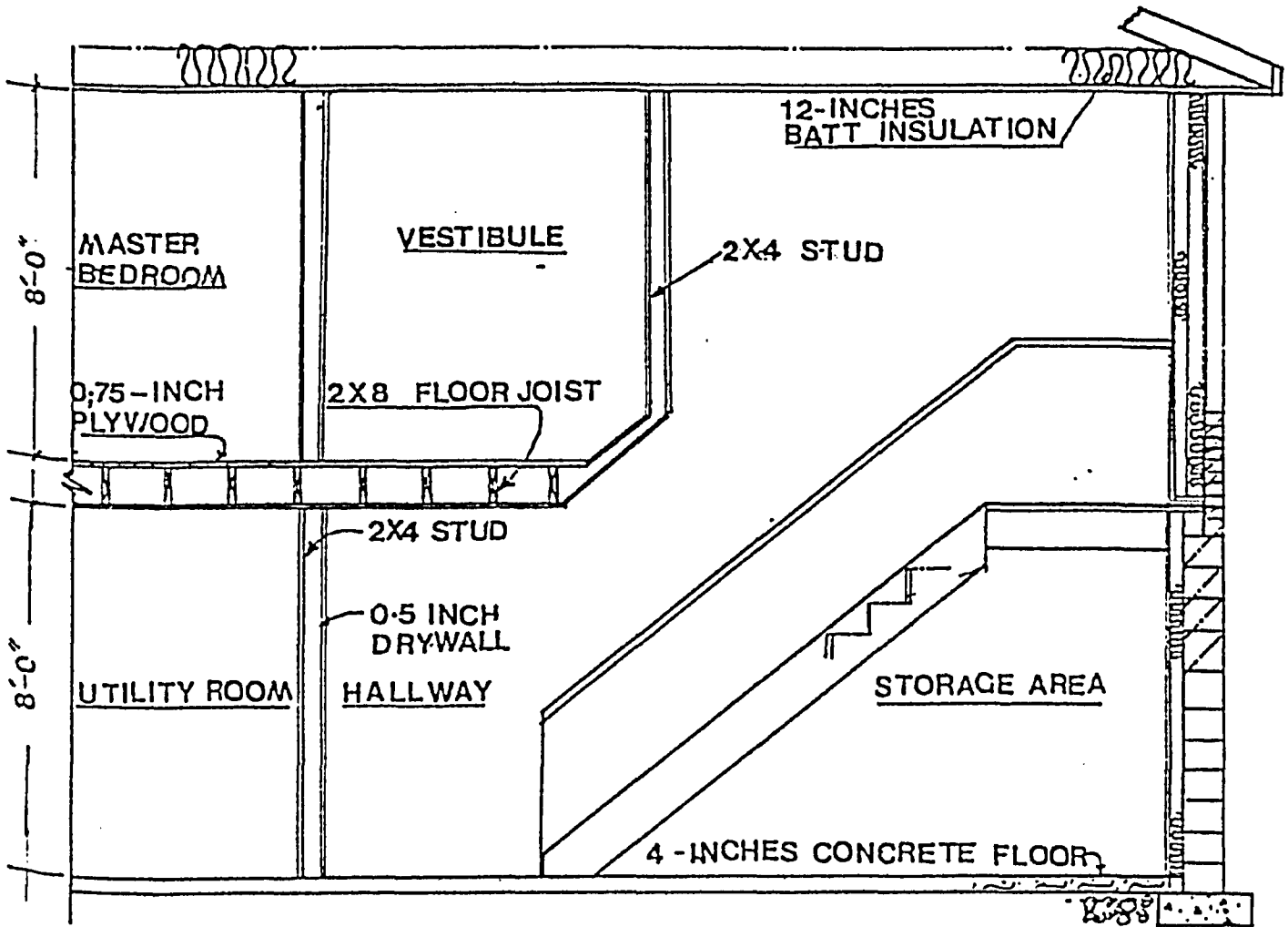

FIGURE 3.8 CONSTRUCTIONAL DETAILS OF THE INTERIOR PARTITION WALLS

brick. These walls were insulated with two layers of 3/4 inch thick rigid styrofoam board placed in between the face brick and the 2 x 4 studs. The R-value of each insulating board was 3.4 Hr.Ft. F / Btu. Two layers of fibreglass batt insulation each 3.5 inches thick with an R-value of 11.0 Hr.Ft. F/Btu were placed within the cavity of the double staggered frame wall. A 6 mil plastic sheet was tacked to the studding between the 1/2 inch dry wall and the cavity insulation to provide a vapor barrier.

The construction and insulation details of the south wall on the upper floor were similar to the preceding construction except that the face brick was replaced with 1/2 inch of wood siding.

The ceiling areas of the upper floor had 1/2 inch of gypsum board nailed to the 24 inches on-center 2x8 & 2x6 ceiling joists. The cavities between these joists were filled with 12 inches of fibre glass batt insulation of equivalent thermal resistance of 40.0 Hr.FT. F/Btu.

The floor of the upper level also served as a ceiling for the lower level and was made up of 3/4 inch of plywood subfloor resting on 2x8 floor joists. A 1/2 inch gypsum board was nailed to the lower surface of the joists to form the ceiling for the lower level. The floor on the upper level was wall-to-wall carpeted, except for the kitchen which had vinyl tiles.

All above grade walls of the lower floor were 16 inches on center 2x4 wood framing backed on the exterior side by 6 inch hollow concrete blocks and 4.0 inch face brick. The cavities

between the 2x4 wood studding were filled with 3.50 inches of fibre glass batt insulation with an equivalent thermal resistance of 11.0 Hr.FT.²F/Btu. A 6 mil plastic sheet was also tacked to the 2x4 studs to provide a vapor barrier between the 1/2 inch gypsum drywall and cavity insulation.

Below grade walls of the lower level were similar to the preceding construction except that the 6 inch concrete blocks and the 4 inch face brick were replaced with 10 inch of hollow concrete blocks. In addition, 1/2 inch of parging and water proofing was applied to the exterior of these walls.

The floor of the lower level was 4 inches of poured concrete on compacted granular fill, insulated on the southern side with 2 inches of rigid blue insulation extending vertically down to a depth of 4 feet. The floor on the lower level was not carpeted.

A 4 foot wide portion of the lower level ceiling, formed a part of the balcony for the upper floor, and was made up of built up roofing and 3/4 inch plywood resting on 2x8 ceiling joists. The cavities between the joists were filled with 8 inches of fibre glass batt insulation with an equivalent thermal resistance of 30. Hr.Ft.²F/Btu. A 6 mil plastic sheet was tacked on the joists between the cavity insulation and 1/2 inch gypsum board, to provide a vapor barrier.

All windows, sliding glass patio doors and Trombe wall glazing (except a small window in the west wall of the bathroom upstairs which is single pane, frosted, with wood framing) were

double glazed, wood framing with 1/4 inch thick glass and a 1/4 inch air space. The effective overall heat transmission coefficient of these glazings, as specified in Table-8 Chapter 22² of Reference (18), was 0.58 Btu / Hr.Ft.F. All of these glazed units were furnished with exterior roller insulating shutters for the purpose of building security in an unoccupied state and energy conservation. According to the manufacturer's specifications (20), the thermal resistance of these² insulating shutters was 3.0 Hr.Ft. F/Btu. The effective heat transmission coefficient of the small frosted window, as specified in Table 8 Chapter 22 of Reference (18), was 1.01² Btu /Hr.Ft.F.

The main entrance door was 1 inch thick, properly weather stripped solid wood construction. The effective U-value of this construction, as specified in Table 9, Chapter 22² of Reference (18), was 0.49 Btu / Hr.Ft.F.

In order to conform to the specifications of a passive solar design, adequately sized extended overhangs were also provided over the southern glazings of the upper and lower levels of the test house.

3.4 HEATING SYSTEM

In the design of the solar house, the southern exposure of the building was utilized to accomplish solar heating both by means of direct and indirect gain passive solar systems. The living room and the kitchen on the upper floor were direct gain

passive solar systems. On a clear, sunny, winter day, solar energy was admitted through two large windows and a patio door. The total area of southern glazing was 120 sq.ft., which amounts to 20 percent of the total floor area. This was in conformation with the recommended values for a passive solar design, as specified in Table IV-9a of Reference (19). The upper floor of the house was basically a light - weight construction and no attention had been paid to thermal mass for the absorption and storage of solar energy. As a result, this space was expected to overheat on clear sunny days.

The two large bedrooms on the lower level facing south used a combination of direct and indirect gain passive solar systems. Direct gain was accomplished through two glass patio doors located on the either end of the south wall. Indirect gain was accomplished through the 10 inch concrete Trombe wall located behind a portion of the southern glazing.

Figure 3.9 is a cross-sectional view of the house showing the direct and indirect passive solar systems for the upper and lower floors.

Auxiliary space heating in the house was provided through individual electric resistance baseboard heaters of various output capacities, installed at 14 different locations on the upper and lower floors. The output capacity of each heater was based on the design heat loss through the section at which it was installed. Each of these heaters was equipped with a built-in thermostat which could be used to regulate the heater's output in

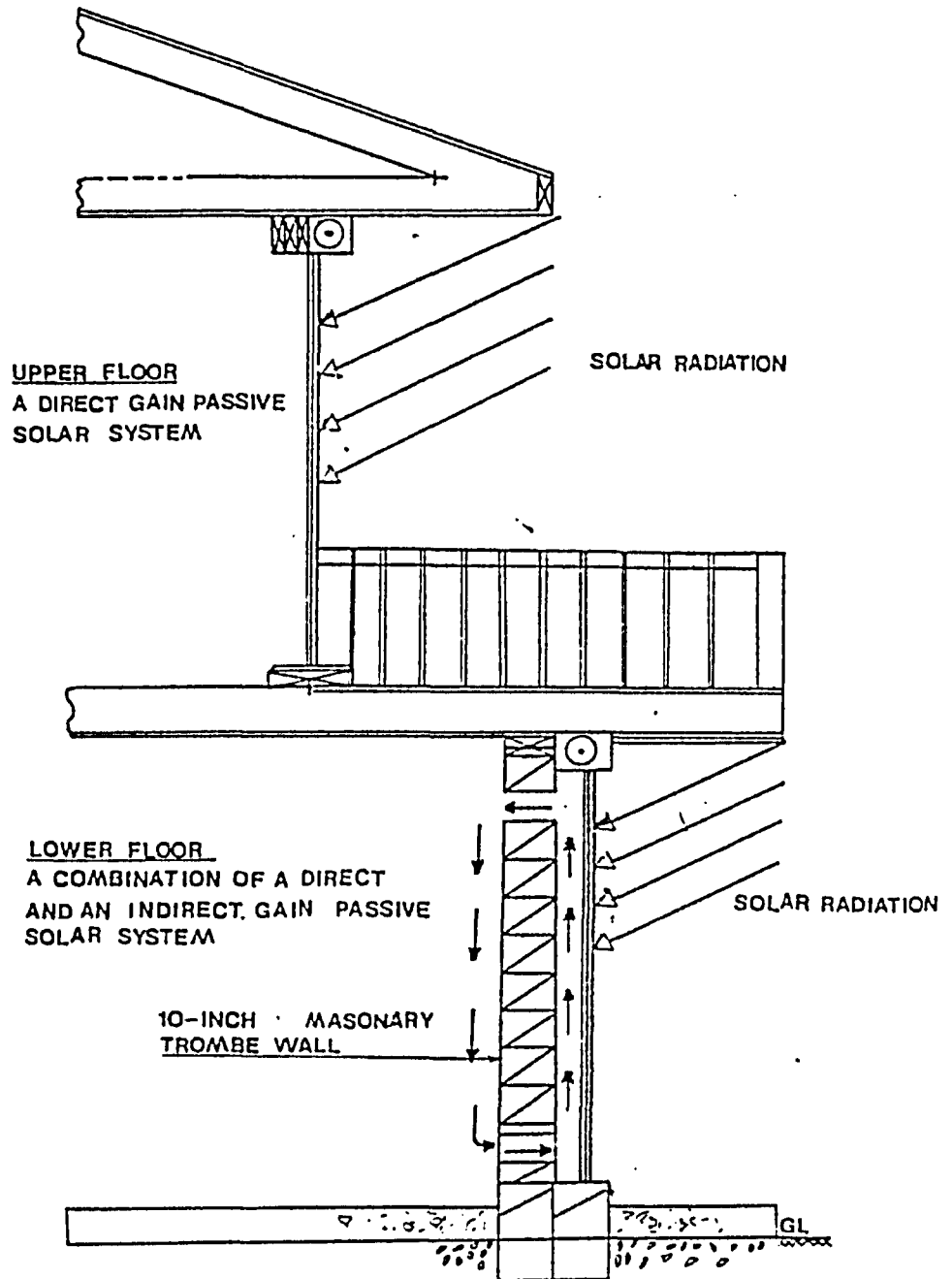

FIGURE 3.9 PASSIVE SOLAR FEATURES OF THE TEST HOUSE

order to maintain the desired room temperature. The total heating capacity of baseboard heaters installed at the upper and lower floors was 28985 Btus/Hr and 33248 Btus/Hr respectively. The total output capacity of the baseboard heaters was almost 1.5 times the design heat loss of the test house. It should be pointed out that the house was intended to be used as a vacation cottage by the owner. The baseboards heaters were, therefore, deliberately oversized to quickly heat up the space for temporary occupancy.

A fireplace manufactured by Glow Boy Fresh Air Heating System was also installed in the living room area. This could be used to provide space heat in case of power failure during occupied hours.

3.5 DESIGN HEATING LOAD

The procedures and recommendations specified in chapter 22 of the ASHRAE Handbook of Fundamentals-1977 (18) were followed to calculate the design heating load of the test house. The outdoor winter design conditions were selected for the Windsor location from Table-1 chapter 23 of ASHRAE Handbook of Fundamentals (18). The outdoor design drybulb temperature was selected as 0 degrees F based on a 99 percent value. The design wind speed was selected as 15 miles per hour. The indoor temperature was fixed at 70 degrees F to comply with the current practice for winter heating. Based on these conditions, the design heating load of the test house was estimated to be 44523 Btus/Hr. The details of the heating load calculations are

provided in Appendix-A.

CHAPTER IV

SELECTION OF A SIMULATION PROGRAM

The test house, selected for energy analysis, was a passive solar residence with extended overhangs over the southern glazings of the upper and lower levels. The lower level of the house also formed a partial basement as 70 percent of its wall area was below the sloping grade. As a part of this comparative study, it was necessary to select a suitable simulation program which could accurately model the passive solar and constructional features of the test house. The selection was to be made among the simulation programs available at the University of Windsor.

In the preliminary stages of this study, the ENCORE CANADA building energy analysis program (21) was considered to simulate the performance of the test house. This program was developed by the National Research Council of Canada and was intended to be used as a tool for the energy analysis of single family residences. The ENCORE CANADA is basically a conversational program which was modified for use at the University of Windsor's computer system. The program is formatted in the input mode and requires intensive care to prepare a building's input description. It was discovered that the program had serious limitations to model the construction features of the test house, such as the building overhangs and the partial basement. In addition, the program's ability to model building thermal mass was restricted to only light, medium, heavy and very heavy constructions. These constructions respectively, represent

fixed mass levels of 30, 70, 130 and 200 lbs /sq.ft., of floor area. Interpolation between these mass levels is not permissible. In the case of passive solar designs with indoor temperature excursions, fixed mass levels cannot model the actual thermal inertia mass of the buildings. The program is rigid in its output reports and does not permit the study of selected output variables. Besides these shortcomings, the program is also extremely expensive in terms of computer time. It requires about 6 hours of C.P.U (central processing unit) time to simulate a building for a period of one year. In view of the inherent limitations of the program, it was concluded that ENCORE CANADA was not suitable for the present study.

The DOE-2 (22) is a comprehensive energy analysis program which is quite capable of simulating energy behaviour of both commercial and residential buildings. This program was developed by the Los Alamos Scientific laboratory and Lawrence Berkeley Laboratory under sponsorship from the United States Department of Energy. The program is mainly based on the algorithms for building heat transfer subroutines prepared by the ASHRAE's Task Group (24) on energy requirements for the heating and cooling of buildings. There are several versions of the program. The current version is known as DOE-2.1A. The program became available for use at the University of Windsor in the middle of 1981.

The DOE-2 consists of a translational program called the BUILDING DESCRIPTION LANGUAGE and four associated subprograms

respectively known as the LOADS, the SYSTEMS, the PLANT and the ECONOMICS. These subprograms are executed in a sequence with the output of one becoming an input for the other. A utility program, known as the DOE weather processor, has also been prepared by the Los Alamos Scientific Laboratory. This program is used to convert the weather information contained in standard TRY, TMY and WYEC weather tapes in a format that is acceptable to the DOE-2 program. It can also be used to create a weather file for a particular location of interest. A complete description of each of these programs is provided in the DOE-2 reference manuals (22).

The DOE-2 program employs the weighting factors method to calculate the building's thermal load and air space temperatures. Two options are available to the user.

Standard Weighting Factors

The standard weighting factors are precalculated for the light, medium and heavy constructions. These constructions represent a building mass of 30, 70 and 130 lbs / sq.ft., of floor area. Interpolation and extrapolation are permissible between these mass levels up to a floor weight of 200 lbs / sq.ft. This allows the user to modify the floor weight according to the class of construction being studied.

Custom Weighting Factors

The custom weighting factors are specific to a building being analyzed and are directly calculated from the building's input

data. This method of weighting factors calculation is a unique feature of the DOE-2 program and has mainly been introduced for accurate modelling of building's thermal inertia. A complete description of custom weighting factors and their calculation procedure is provided in Reference (12).

The DOE-2 program is user oriented and has numerous advantages over other similar programs. It provides a great deal of flexibility to model a variety of building's constructional features and system operation. Input to the program is format free and is labelled with predefined key-words for easy identification of the building's input data. The program is quite flexible in its output reports and allows the user to select a variety of output variables from a predefined list. This aspect of the program makes its use more desirable for building energy conservation studies. The program was capable of modelling the extended overhangs and the partial basement of the test house. The custom weighting factors method could be used to accurately model the thermal mass of the test building.

The preceding section resulted in the conclusion that the DOE-2 program had all necessary capabilities to model the constructional features and system operation of the test house (except the Trombe wall system). It was therefore decided to use this program for the present comparative study.

CHAPTER V

EXPERIMENTAL MONITORING OF THE TEST HOUSE

5.1 INTRODUCTION

As a means of comparing the measured performance with the DOE-2.1A's predictions, a computerized energy monitoring system was designed and installed in the test house. The system consisted of a weather station, energy monitoring instruments and a computerized data acquisition unit. The system was simple and capable of continuously measuring and recording the outdoor weather conditions and indoor performance of the test house.

The monitoring system was used to accomplish the following tasks:

1. To collect sufficient meteorological data that could be used to create an on-site hourly weather file for the test period.
2. To measure the hourly indoor space temperatures and energy consumption of the electric baseboard heaters, for comparison with the simulated results obtained from the DOE-2.1A computer program.

The test house was extensively instrumented at 29 test points to measure the following weather and energy related parameters which were considered to be important in achieving the objectives of this study:

1. Outdoor Drybulb Temperature.
2. Wind Speed.
3. Wind Direction.
4. Total Solar Radiation on a Horizontal Surface.
5. Total Solar Radiation on a Vertical Surface.
6. Space Drybulb Temperatures.
7. Energy Consumption of Electric Baseboard Heaters.
8. Trombe Wall Air Space Temperature.
9. Trombe Wall Upper and Lower Surface Temperatures.
10. Solar Radiation Received by the Trombe Wall.

The layout plans of the upper and lower floors of the test house, shown in Figures 5.1 and 5.2, indicate the test points located at the weather station and in the test house. These test points also symbolically represent the type of transducers installed at different indoor and outdoor locations. Legends attached to these symbols are presented in Table 5.1. The weather station consisted of a 17 foot high, 1 inch diameter pipe post, installed at the south-west corner of the upper floor's balcony. Several types of weather sensing transducers were mounted in different positions on the weather station post as shown in Figure 5.3.

5.2 INSTRUMENTATION

Several types of transducers were used to facilitate this experimentation. These included copper-constantan thermocouples, heater monitor pickups, an anemometer, a wind direction meter, and radiometers. Among the transducers used, the radiometers

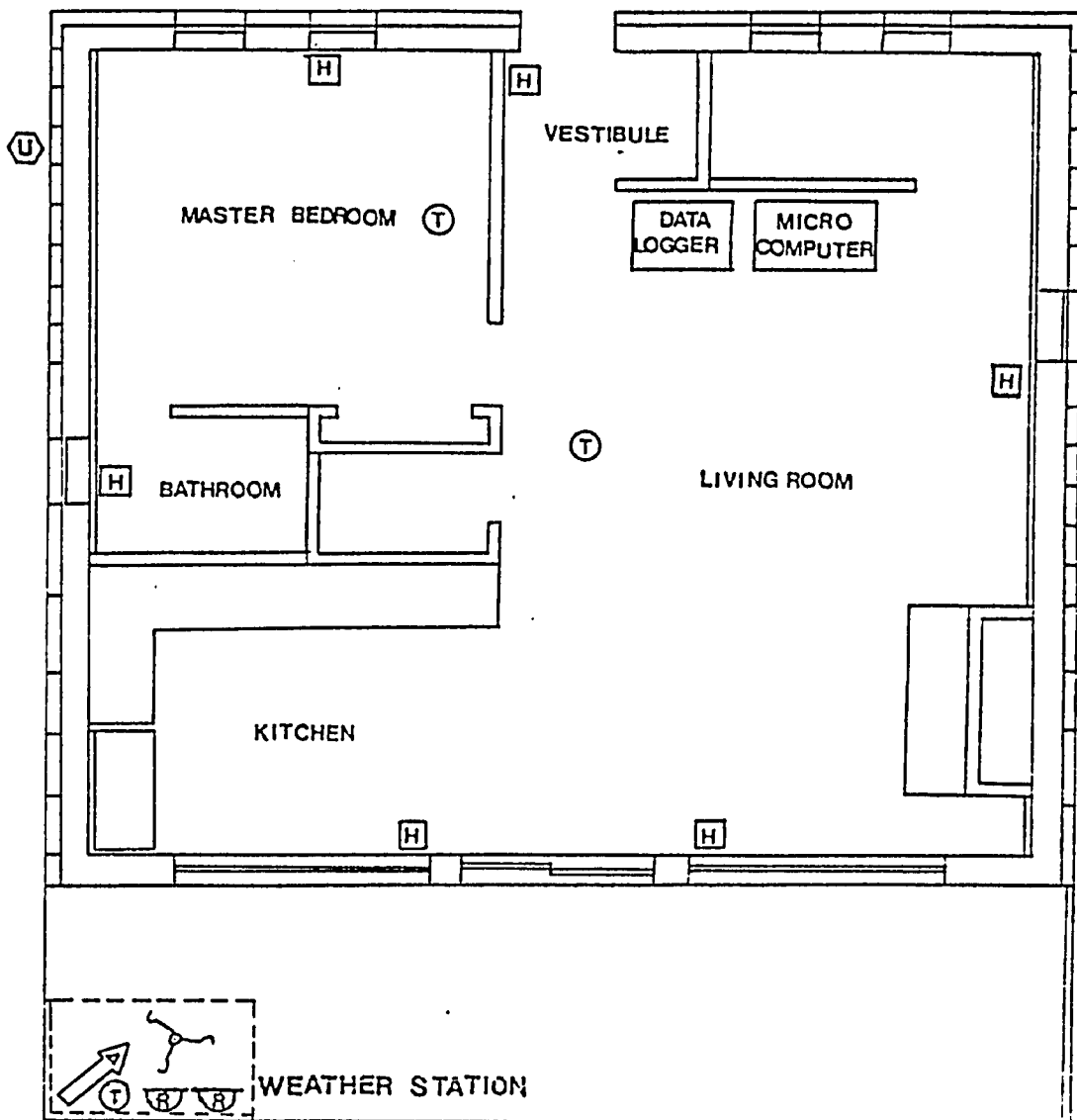

FIGURE 5.1 FLOOR PLAN OF THE UPPER LEVEL
SHOWING THE LOCATION OF WEATHER
STATION AND TRANSDUCERS

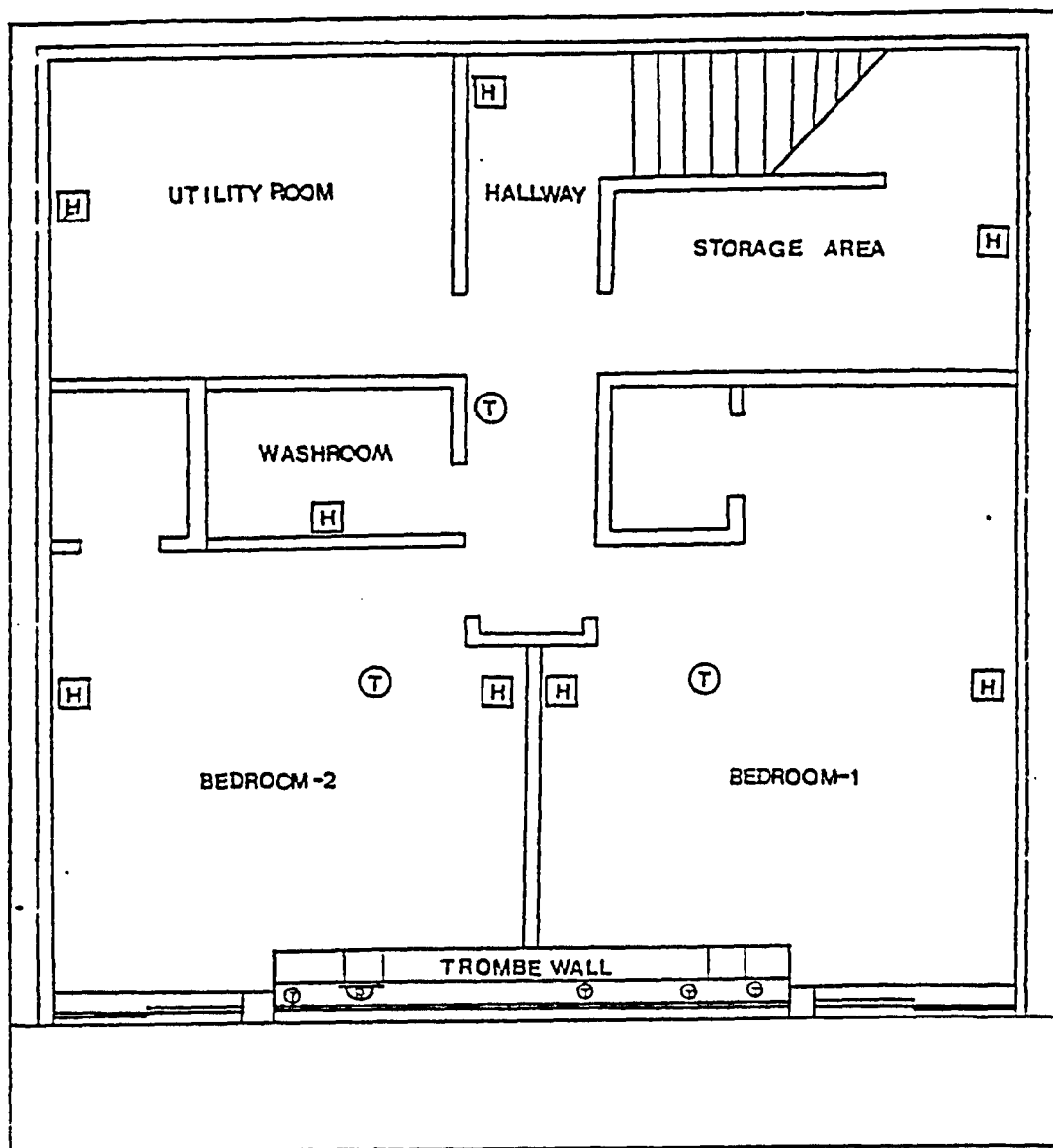



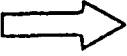



FIGURE 5.2 FLOOR PLAN OF THE LOWER LEVEL
SHOWING THE LOCATION OF TRANSDUCERS

TABLE 5.1

SYMBOLIC REPRESENTATION OF TRANSDUCERS INSTALLED
IN THE WEATHER STATION AND THE TEST-HOUSE

LEGENDS	DESCRIPTION
	THERMOCOUPLE
	HEATER MONITOR PICKUPS
	UTILITY ENERGY METER
	WIND DIRECTION METER
	RADIOMETER
	ANEMOMETER

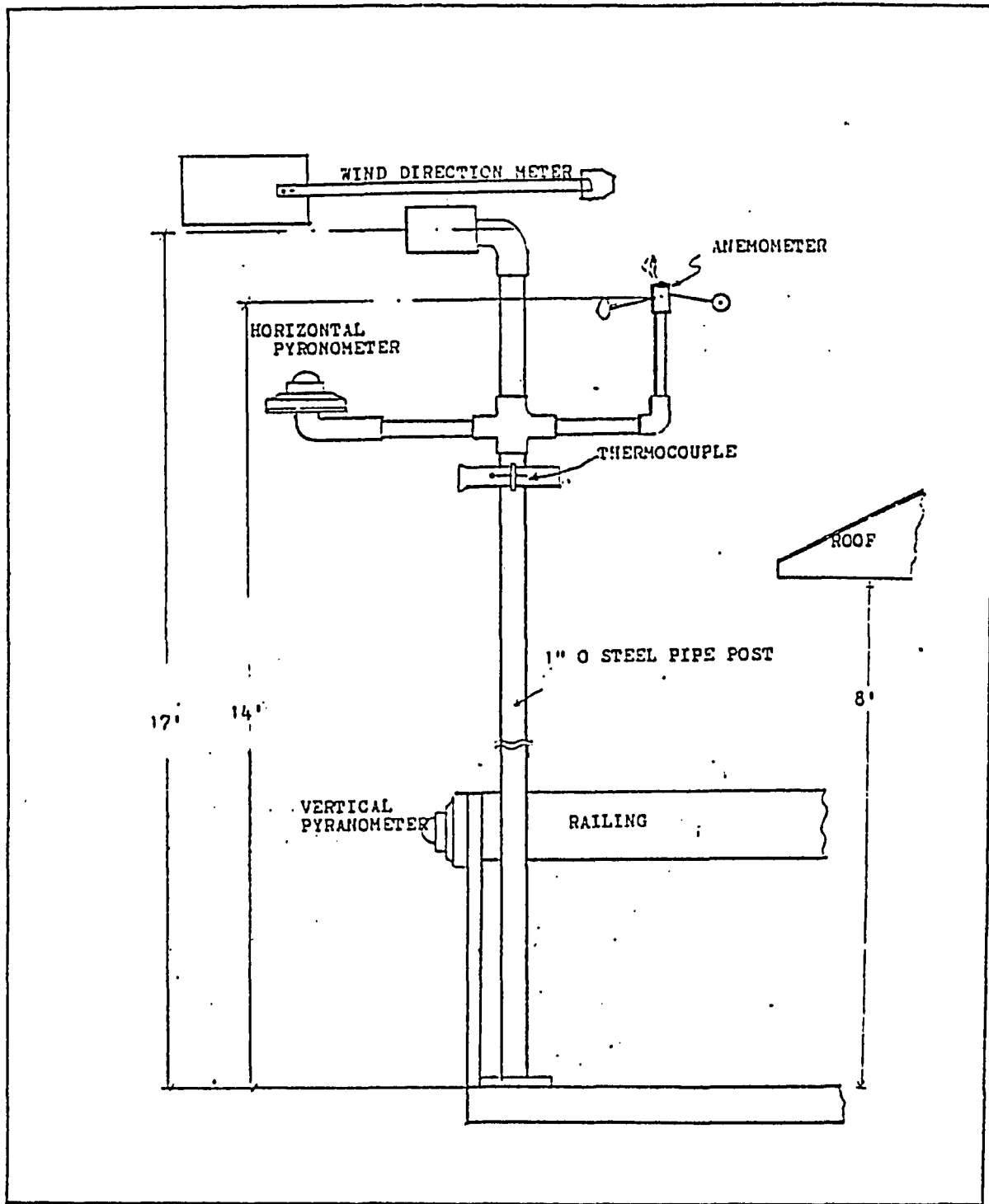

FIGURE 53 WEATHER STATION

and anemometer were standard instruments purchased from the manufacturers. The heater monitor pickups and the wind direction meter were, however, made and calibrated in the mechanical engineering workshop to meet the requirements at the site. Analog signals from these devices were conditioned in some cases before being relayed to the data acquisition system.

In all, fourteen heater monitor pickups, nine thermocouples, three radiometers, an anemometer and a wind direction meter were used in this monitoring project. A brief description of the test data measured by these transducers is given below. Details of these transducers are provided in Appendix-B.

Temperatures

All indoor and outdoor temperatures were measured using standard copper-constantan thermocouples made at the site. These thermocouples were capable of measuring the temperatures within ± 0.5 F. A thermocouple properly shielded against radiation effects was installed at the weather station to measure the outdoor drybulb temperature. Indoor drybulb temperatures were measured with thermocouples installed at 5 feet above the floor level in each of the living room, master bedroom, hallway and two large bedrooms on the lower level of the house. Since the living room and two lower bedrooms had southern orientation, care was taken to install thermocouples at locations that were not directly exposed to solar radiation entering through the southern glazings. Four thermocouples were also installed in the

Trombe wall to measure its performance over the test period. One of these thermocouples was installed half way across the Trombe wall air space to measure the air temperature, two thermocouples were glued to the upper and one to the lower exterior surface of the Trombe wall to measure its surface temperatures during clear, sunny days.

Baseboard Energy Consumption

Energy consumption of the individual baseboard units was measured with heater monitor pickup units. These pickup units were installed across the power cord of each heater, and were designed to detect the on and off cycle of the baseboard unit during a given hour. Energy usage was later determined by multiplying the percentage on time of each heater by its power rating.

Wind Speed

A standard, cup-type anemometer, manufactured by the Trade Wind Inc., was mounted on the weather station post to measure the wind speed at the test site. Output from the anemometer was calibrated to indicate the wind speed in miles per hour.

Wind Direction

Wind direction was measured by a wind direction meter mounted at the top of the weather station post. This unit was calibrated to convert the output signal into an equivalent wind direction in degrees.

Solar Radiation

Solar radiation was measured with three Eppley Black & White temperature compensated radiometers. One of these radiometers was mounted on the weather station post, facing the sky, and was used to measure the global radiation falling on a horizontal surface. The second radiometer was mounted on the railing of the upper floor's balcony, facing the lake and was used to measure the total radiation received by south facing vertical surface. The third radiometer was vertically installed halfway in the Trombe wall air space during the second half of the test period. This radiometer was used to measure the solar radiation received by the exterior surface of the Trombe wall.

Total Energy Consumption

A utility meter installed outside the test house was used to keep a record of the total electrical energy consumption of the house over the test period.

5.3 DATA ACQUISITION SYSTEM

The computerized data acquisition system consisted of the following units:

1. Fluke Data Logger model 2240-C, capable of serving up to 60 channels of input data.
2. Radio Shack Microcomputer TRS-80 Model III with disk storage system.

Communication between the data logger and the microcomputer

was established by means of a standard RS-232-C interface built into each of these units. The system was capable of providing analog to digital conversion and high speed summing up of the experimental data. A series of computer programs, written in BASIC Language, were used to facilitate the transmission, processing and storage of the experimental data.

The data acquisition system was located in the living room of the test house and is shown in Figure-5.1. A schematic of the experimental monitoring system layout is also shown in Figure- 5.3. The transducers installed in the test house and at the weather station were connected to the data logger through four isothermal block connectors.

Channel specifications for the weather station and the test house are listed in the Tables 5.2 and 5.3, respectively. Output signals relayed from the transducers were in an analog form and had to be further converted into digital form before being processed and stored on the magnetic disk of the microcomputer. This analog to digital conversion was accomplished within the data logger unit. Experimental data relayed from the transducers was recorded in millivolts, volts and percentages. The data was later converted into consistent engineering units by applying appropriate conversion factors.

As the DOE-2 computer program operates with hourly values of input/output, it became necessary to record the weather and indoor performance data of the house on an hourly basis. Accordingly, the data acquisition system was programmed to

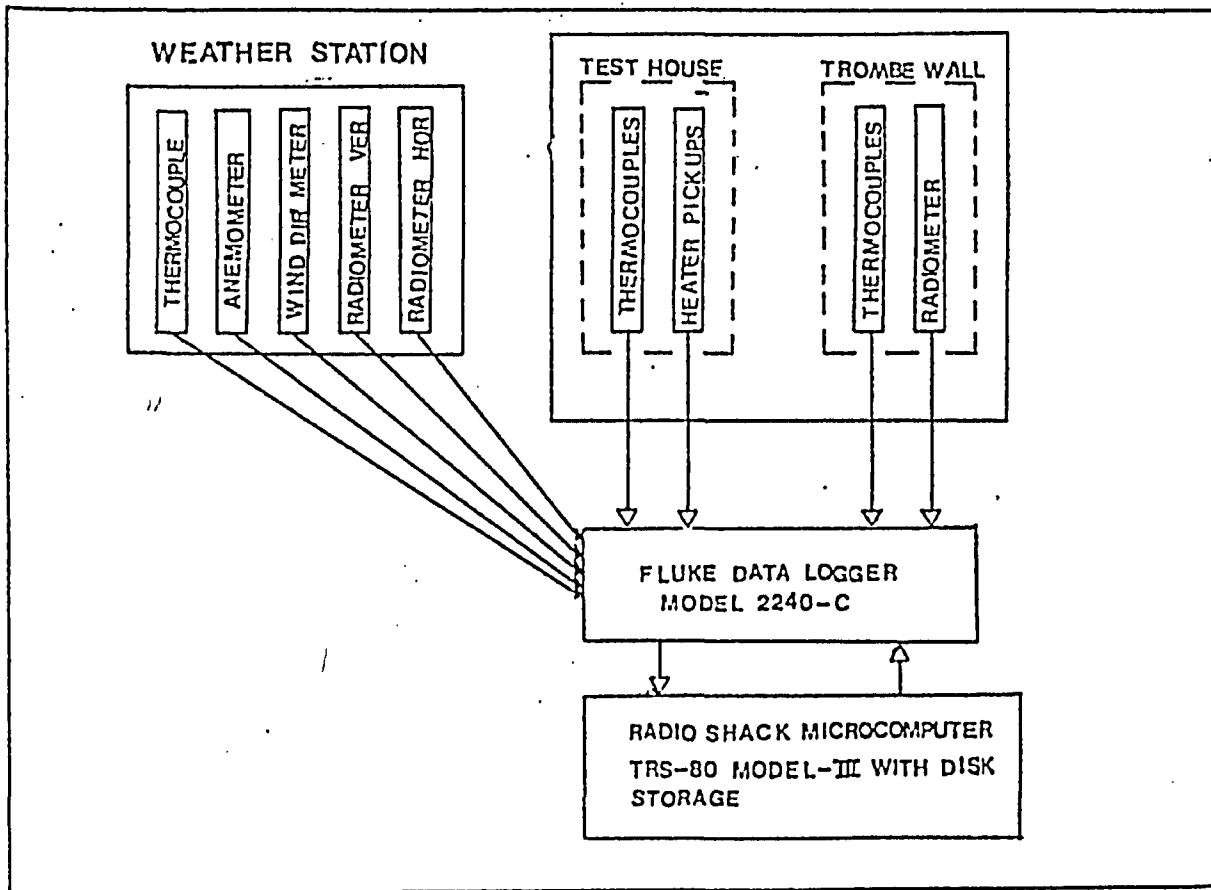

FIGURE 5.4 SCHEMATIC OF THE COMPUTERIZED DATA ACQUISITION SYSTEM INSTALLED IN THE TEST HOUSE

TABLE 5.2

CHANNELS MONITORED IN THE WEATHER STATION

CHANNEL SPECIFICATION	DESCRIPTION
14	WIND SPEED (MILES PER HOUR)
15	AMBIENT DRYBULB TEMPERATURE (F)
24	SOLAR RADIATION ON HORIZONTAL SURFACE (MV)
25	SOLAR RADIATION ON VERTICAL SURFACE (MV)
26	WIND DIRECTION

TABLE 5.3

CHANNELS MONITORED IN THE TEST HOUSE

CHANNEL SPECIFICATION	DESCRIPTION
00	BASEBOARD HEATER IN LIVING ROOM (EAST WALL)
01	BASEBOARD HEATER IN MASTER BEDROOM
02	BASEBOARD HEATER IN THE KITCHEN
03	BASEBOARD HEATER IN LIVING ROOM (SOUTH WALL)
04	BASEBOARD HEATER IN UPPER BATHROOM
05	BASEBOARD HEATER IN VESTIBULE
06	BASEBOARD HEATER IN LOWER BEDROOM NUMBER 1
07	BASEBOARD HEATER IN LOWER BEDROOM NUMBER 2
08	BASEBOARD HEATER IN LOWER HALLWAY
09	BASEBOARD HEATER IN LOWER BEDROOM NUMBER 1
10	BASEBOARD HEATER IN LOWER BEDROOM NUMBER 1
11	BASEBOARD HEATER IN LOWER BATHROOM
12	BASEBOARD HEATER IN STORE ROOM
13	BASEBOARD HEATER IN UTILITY ROOM
16	SPACE TEMPERATURE LOWER BEDROOM NUMBER 1
17	SPACE TEMPERATURE LOWER BEDROOM NUMBER 1
18	SPACE TEMPERATURE LOWER HALLWAY
19	SPACE TEMPERATURE LIVING ROOM
20	TROMBE WALL AIR SPACE TEMPERATURE
22	SPACE TEMPERATURE MASTER BEDROOM
27	TROMBE WALL LOWER SURFACE TEMPERATURE
28	TROMBE WALL UPPER SURFACE TEMPERATURE
29	TROMBE WALL UPPER SURFACE TEMPERATURE
32	RADIOMETER IN TROMBE WALL.

scan all input channels to the data logger, every 45 seconds and store the average values on an hourly basis.

5.4 TEST PERIOD

After successful installation and commissioning of the monitoring system, the thermal performance of the test house was measured in an unoccupied state for a period of five weeks. Throughout the test period, all electric baseboard heaters were turned on and their thermostats adjusted to maintain each space at minimum indoor temperature of 70 degrees F. Insulating roller shutters on all southern glazings of the upper and lower floors were left open to utilize solar energy for space heating. Insulating shutters on the Trombe wall glazings were also left open to measure the performance of the wall during clear sunny days and its contribution to the space heating over the test duration. Four small windows located in the northern wall of the upper floor were covered with their insulating shutters for energy conservation.

Routine inspection visits were normally scheduled over the weekends, depending upon the weather conditions. The instrumentation and the monitoring system were generally found to be functioning satisfactorily, except on two occasions when the system was found to be inactive due to power failures at the site. Although the experimental monitoring of the test house continued for a period of five weeks, the test data for ten days was lost due to power failures. In spite of these failures, the test data collected for the remaining four weeks was

sufficient to accomplish the objectives of this study.

CHAPTER VI
DEVELOPMENT OF A WEATHER FILE

6.1 INTRODUCTION

The DOE-2 energy analysis computer program requires an hourly weather file to simulate the thermal performance of a building located in a particular site of interest. The weather file must contain the required data in a format that is acceptable to the DOE-2 program. This chapter describes the development of a weather file from the weather data recorded at the test site.

6.2 THE DOE WEATHER PROCESSOR

The Los Alamos Scientific Laboratory and the Lawrence Berkeley Laboratory have also prepared a utility program called the DOE Weather Processor. This program was primarily developed to convert the weather information contained in the standard TRY, TMY and WYEC weather tapes into a format that is acceptable to the DOE-2 program. It can also be used to create a weather file for a test location. In order to make use of this program, the user has to write a subroutine named OTHER. This subroutine is inserted in the source code of the weather processor. It interprets the unpacked weather information to the weather processor, which in turn produces an hourly weather file for the test location.

6.3 INPUT REQUIREMENTS OF THE DOE WEATHER PROCESSOR

The following geographical and climatic information are required by the weather processor to create a weather file for a test-location:

Geographical Data

Latitude of the Location ----- Degrees.
Longitude of the Location ----- Degrees.
Time Zone of the Location ----- Dimensionless.

Weather Data

Drybulb Temperature ----- (F)
Wetbulb Temperature ----- (F)
Dewpoint Temperature ----- (F)
Atmospheric Pressure ----- (Inches of Hg)
Wind Speed ----- (Knots)
Wind Direction ----- (Integer 0 to 15)
Global Radiation ----- (Btu / Hr.Ft²)
Direct Normal Radiation ----- (Btu / Hr.Ft²)
Atmospheric Clearness Number ----- (Dimensionless)
Ground Temperature ----- (F)

The latitude, longitude and time zone of the weather station are required to describe the location of the test-site on the surface of the earth.

Input for the first seven variables grouped under the WEATHER DATA are required on an hourly basis. The last two variables,

i.e., clearness number and the ground temperature are required on a monthly basis.

The hourly values of the wetbulb, drybulb and the dew point temperatures, and atmospheric pressure are used by the weather processor to calculate the psychrometric properties of outdoor air. These properties are included in the hourly output listings of the weather file.

Wind direction is identified by the DOE-2 program as an integer ranging from 0 to 15, starting clockwise from true north. All wind directions recorded in degrees are required to be converted into their integer equivalents before being entered into the weather program. Wind direction in degrees and their corresponding integer equivalents are listed in Table 6.1.

Solar radiation data is specified in the weather processor by either of the following methods:

- a. If cloud information is available for the location, then hourly values of cloud amount and cloud type are entered in the weather processor. This cloud information along with the geographical data for the location and certain solar related variables (LA,LO,AP,BP,CP,ET,TZ,and CN discussed on page 67) are utilized by the DOE-2 program to compute the hourly intensities of the direct normal and diffuse components of the solar radiation under clear and cloudy sky conditions. The cloud information is available at all major weather stations in the United

TABLE 6.1

WIND DIRECTIONS IN DEGREES CLOCKWISE FROM TRUE NORTH
AND THEIR CORRESPONDING INTEGER EQUIVALENTS

WIND DIRECTION	DEGREES	INTEGER EQUIVALENTS
North	0	0
North by North-East	22.5	1
North-East	45.0	2
East by North-East	67.5	3
East	90.0	4
East by South-East	112.5	5
South-East	135.0	6
South by South-East	157.5	7
South	180.0	8
South by South-West	202.5	9
South-West	225.0	10
West by South-West	247.5	11
West	270.0	12
West by North-West	292.5	13
North-West	315.0	14
North by North-West	337.5	15

States and Canada, where hourly observations are made by experienced observers who estimate the cloud amount on a scale of 0 to 10 and indicate the types of cloud in four different layers. A cloud amount of 0 indicates a clear sky whereas a cloud amount of 10 corresponds to a completely overcast sky.

b. The solar radiation data can also be specified in the weather processor by inputting the hourly values of the direct normal and total global radiation on a horizontal surface recorded in Btu/Hr.Ft.² This procedure is adopted by the users who are interested in incorporating the solar data recorded at a particular site. In the present case, the global radiation was measured on a horizontal surface and it was necessary to derive the direct normal component of the solar beam from these recorded values by using standard procedures recommended by ASHRAE Task Group (24).

6.4 PROCESSING OF WEATHER DATA

Hourly weather information recorded at the test-site was in raw units and had to be converted into consistent engineering units before it could be utilized in the weather processor. Raw weather data was processed on the microcomputer, using WEHETE and SPLINE programs written in BASIC Language. Complete listings and descriptions of these programs are provided in Appendix-C.

Temperatures

In order to fulfill the input requirements of the DOE weather processor, it was necessary to supply hourly values of the outdoor drybulb, wetbulb and dew point temperatures. The experimentation at the test house was carried out during the heating season of 1982, and the outdoor drybulb temperatures were recorded throughout the test period. In the absence of actual data for the wetbulb and dewpoint temperatures, it was decided to assume that these temperatures were equal to the outdoor drybulb temperatures. This assumption was necessary to comply with the input requirements of the weather processing program. Accordingly, the outdoor drybulb temperatures recorded in degrees F were rounded off to the nearest integers and equated to the wetbulb and dew point temperatures.

The assumption of equal outdoor drybulb, wetbulb and dewpoint temperatures corresponds to a saturated outdoor air conditions. This assumption is valid since the transmission losses through the building envelope and the sensible portion of the infiltration losses are calculated on the basis of outdoor drybulb temperatures. Moreover, the DOE-2 program assumes a constant humidity ratios for the indoor and outdoor air conditions to perform heating load calculations. Hence the latent portion of infiltration losses is equated to zero in the DOE-2 calculations. The DOE-2 calculation procedure is in compliance with indoor conditions which existed in the test house. Since the house remained unoccupied during the test

period, the indoor humidity ratio remained equal to the outdoor humidity ratio. Therefore the latent infiltration losses were also zero in the actual case.

Wind Speed

The output from the anemometer was calibrated to indicate the wind speed in miles per hour. This calibration was used in the monitoring program to measure and record the wind speed at the test-site. To be consistent with the requirements of the DOE-2 program, the recorded wind speeds were converted into Knots and rounded off to the nearest integers for input into the weather processor.

Wind Directions

The wind direction meter was calibrated to indicate the direction of the wind in degrees, clockwise from true north. A provision was, however, made in the monitoring programs, to convert the wind direction into their equivalent integer ranging from 0 to 15. This was accomplished by specifying sixteen bins, each allocated to an individual integer wind direction. During any scan of the system, the equivalent integer wind direction was stored in the appropriate bin. At the end of each hour, wind directions stored in each of these sixteen bins were proportioned with respect to the total number of scans during that hour. The hourly contents of each direction bin were converted into equivalent degrees and summed to obtain an average wind direction. This wind direction was reconverted

into a single hourly integer direction by dividing by a conversion factor of 22.5.

Solar Radiation

Solar radiation travelling through the atmosphere is absorbed and scattered due to atmospheric constituents such as ozone, CO₂, N₂, water vapours and dust particles, and arrives at the surface of earth in the form of direct and diffuse radiation. The proportion of direct and diffuse radiation largely depends upon the atmospheric composition. For a clear atmosphere, the proportion of diffuse radiation is small whereas the opposite is true for highly polluted atmosphere in an industrial locality. The proportion of direct and diffuse radiation, under clear sky conditions, is well established for various localities and can be estimated according to the procedures specified in the ASHRAE's 1977 Handbook of Fundamentals. This proportion is relatively difficult to calculate under cloudy sky conditions due to large variability in the cloudiness. In the analysis of solar radiation data, it is necessary to estimate the direct and diffuse component of solar radiation under the clear and cloudy sky conditions.

The ASHRAE Task Group (24) has developed a comprehensive methodology to analyze solar radiation under the cloudy and clear sky conditions. This methodology is based on the work of Stephenson and Kimura (23) who have established a correlation between the observed radiation, cloud cover and the calculated radiation under clear sky conditions. The general form of this

relationship is

$$CCF = P + Q \times CC + R \times CC^2 \quad (6.1)$$

The left hand side of equation (6.1) is the cloud cover factor which is defined as:

$$CCF = RH / IT$$

where

RH : Total measured solar radiation on a horizontal surface under a cloudy sky for a given cloud amount and cloud type. (Btu/Hr.Ft²)

IT : Total solar radiation calculated on a horizontal surface for a cloudless sky conditions using the ASHRAE method (Btu/Hr.Ft²).

CC : Cloud cover estimated on a scale of 0 to 10

P, Q and R are the coefficients in the correlation (6.1). Recommended values of these coefficients for different seasons are listed in Table 6.2 .

The cloud cover factor is a measure of the sky's cloudiness. However, its value is not necessarily 1 for clear sky conditions, but would vary according to the composition of the atmosphere. For clear atmospheres, the value of CCF can be greater than 1 whereas for industrial locations it is generally lower than 1.

The coefficient P in equation 6.1 is called the cloudless sky factor. Its value depends upon the proportion of direct and

TABLE 6.2

CORRELATION COEFFICIENTS BETWEEN THE
CLOUD COVER FACTOR CCF AND THE CLOUD COVER CC

SEASON	P	Q	R
Spring	1.06	0.012	-0.0084
Summer	0.96	0.033	-0.0106
Autumn	0.95	0.030	-0.0108
Winter	1.14	0.003	-0.0082

diffuse radiation in reference to the standard values published in ASHRAE's 1977 Handbook of Fundamentals (18). If the value of P is 1, then the proportion of direct and diffused radiation, under cloudless sky condition, will be same as obtained by ASHRAE's standard procedures. For a value of P other than unity, this proportion will be different than the standard values.

Equation 6.1 can be used to analyze cloudy day solar radiation if either the cloud cover or measured global radiation are available. However, in the case of measured global radiation, equation 6.1 has to be rearranged into a quadratic form to calculate an equivalent cloud cover.

The ASHRAE Task Group (24) has developed the SUN algorithm to calculate direct and diffuse component of solar radiation for clear sky conditions. It has also prepared the SOLAD algorithm to analyze solar radiation under cloudy sky conditions. The cloud cover factor equation 6.1 is used in the SOLAD algorithm. A detailed description of these algorithms is provided in the Reference (24). These algorithms were merged together to analyze solar radiation data recorded at the test site. Since the measured global radiation were available, equation 6.1 was rearranged in a quadratic form and incorporated in the SOLAD algorithm. The weather data was collected during the months of March and April which corresponds to the spring season. Therefore the values of P , Q and R for the spring season were used from Table 6.2. The calculation sequence of the SUN and SOLAD algorithms is shown in Figure 6.1.

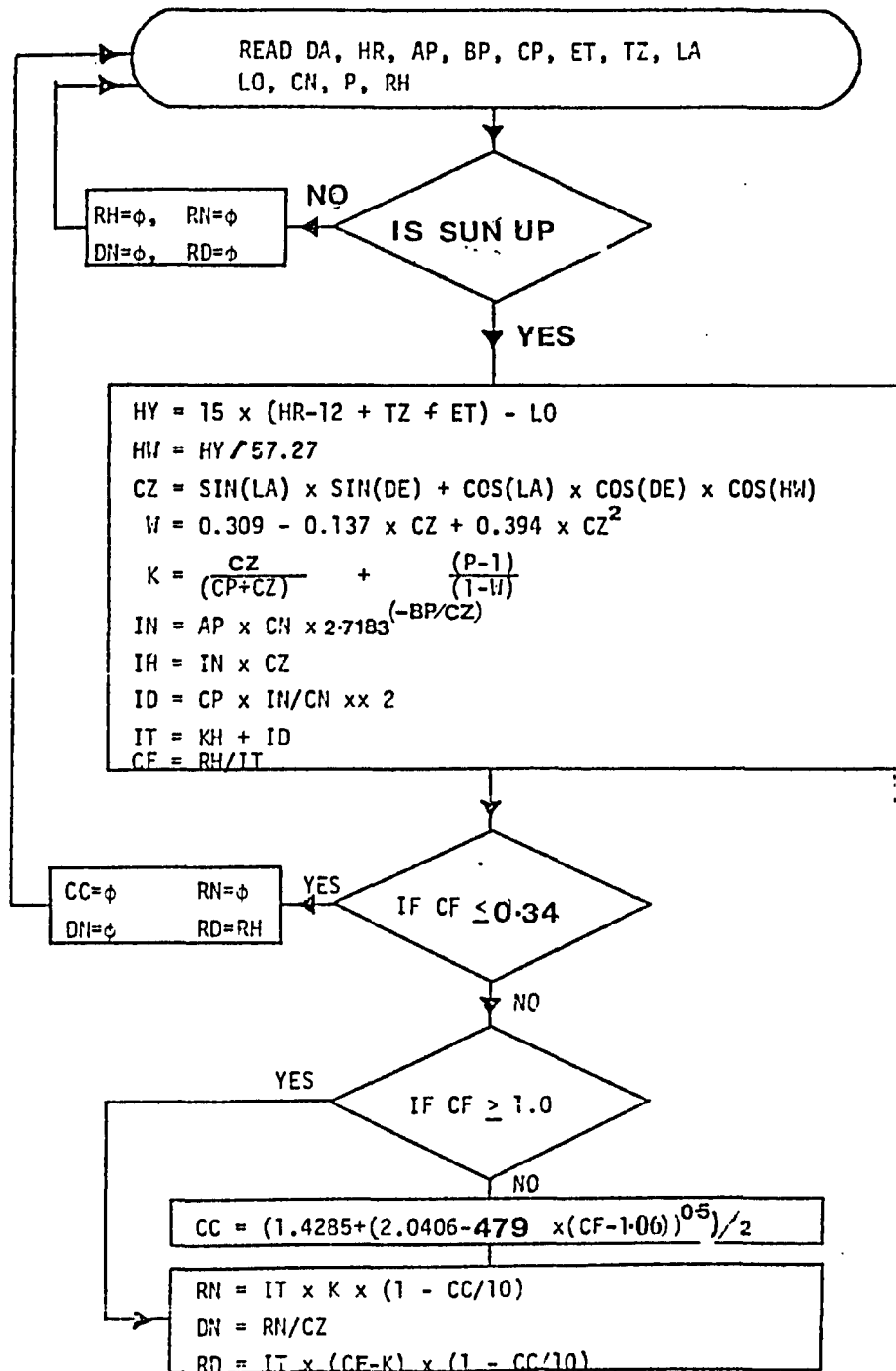

FIGURE 6.1 FLOW DIAGRAM TO ANALYZE CLOUDY DAY SOLAR RADIATION

The following geographical and solar related variables were required to make use of the SUN and SOLAD algorithms.

Geographical Location of Test Site

Longitude ----- LO
Latitude ----- LA
Time Zone ----- TZ

Sun-Earth Variables (Daily basis)

Solar Declination Angle ----- DE
Apparent Solar Irradiation ----- AP
Equation of Time ----- ET

Sky Data (Daily basis)

Atmospheric Extinction Coefficient ----- BP
Sky Diffuse Factor ----- CP
Clearness Number ----- CN

Solar Related Data (Hourly basis)

Sun Azimuth and Altitude Angle ----- Z & SALT
Sunrise Time.
Sunset Time.
Measured Global Radiation. ----- RH.

As the test site was not far from Windsor, its geographical location was described by specifying the longitude and latitude for Windsor, Ontario.

The recommended values for the solar related variables,

listed under group 2 and 3, are presented in Table 6.3. These values were extracted from the ASHRAE 1977 Handbook of Fundamentals (18) and apply for the 21st day of each month. These values are representative of average cloudless sky conditions and do not necessarily give the maximum value of direct normal solar radiation that can occur in each month. It has been recommended by ASHRAE (18) that for a clear atmosphere the maximum value of direct normal solar radiation occurring in each month can be as high as 15 percent than that obtained by ASHRAE's method using this data. For a better analysis of solar radiation data, it was considered necessary to adjust these monthly values on a daily basis for the duration of entire test period. This was accomplished by using spline interpolation subroutine extracted from Reference (25). Adjusted values of these solar variables are listed in Table 6.4. These values were used along with the measured global radiation in the SUN and SOLAD algorithms to calculate the direct normal component of solar radiation on clear and cloudy days.

Figure 6.2 presents an hourly comparison between the measured and ASHRAE calculated and measured global radiation for a typical clear sunny day recorded at the test site. It can be seen that the measured values are always higher than the ASHRAE values by about 10 percent. This was solely due to the clear and pollution free atmosphere of the test location. A comparison between the ASHRAE calculated and the estimated values of direct normal radiation for the same day is also shown in Figure 6.3. This comparison also exhibited a similar trend, since the estimated

TABLE 6.3

SOLAR RELATED VARIABLES AS A FUNCTION OF THE TWENTY FIRST DAY
DAY OF EACH MONTH , BASE YEAR 1964

DATE		DE Degrees	ET Hours	AP Btu/Hr.Ft ²	BP -	CP -
January	21	-20.0	-0.190	390.0	0.142	0.058
February	21	-10.8	-0.230	385.0	0.144	0.060
March	21	0.0	-0.123	376.0	0.156	0.071
April	21	11.6	0.020	360.0	0.180	0.097
May	21	20.0	0.060	350.0	0.196	0.121
June	21	23.45	-0.025	345.0	0.205	0.134
July	21	20.60	-0.103	344.0	0.207	0.136
August	21	12.3	-0.051	351.0	0.201	0.122
September	21	0.0	0.113	365.0	0.177	0.092
October	21	-10.5	0.255	378.0	0.160	0.073
November	21	-19.8	0.235	387.0	0.149	0.063
December	21	-23.45	0.033	391.0	0.142	0.057

TABLE 6.4

SOLAR RELATED VARIABLES ADJUSTED TO DAILY BASIS
FOR THE TEST DURATION

Date	DE Radians	ET Hours	AP Btu/Hr.Ft ²	BP -	CP -
March - 10	-0.078	-0.181	380.4	0.150	0.065
March - 11	-0.071	-0.176	380.0	0.150	0.065
March - 12	-0.064	-0.171	379.7	0.151	0.066
March - 13	-0.057	-0.166	379.3	0.151	0.066
March - 14	-0.043	-0.156	378.5	0.152	0.067
March - 21	0.000	-0.123	376.0	0.156	0.071
March - 22	0.006	-0.119	375.6	0.157	0.072
March - 23	0.013	-0.114	375.1	0.157	0.072
March - 24	0.020	-0.110	374.6	0.158	0.073
March - 25	0.026	-0.105	374.2	0.159	0.074
March - 26	0.033	-0.100	373.7	0.159	0.074
March - 27	0.039	-0.096	373.2	0.160	0.075
March - 28	0.046	-0.091	372.7	0.161	0.076
March - 29	0.052	-0.086	372.2	0.162	0.077
March - 30	0.059	-0.082	371.7	0.162	0.077
March - 31	0.066	-0.077	371.2	0.163	0.078
April - 01	0.072	-0.072	370.7	0.164	0.079
April - 02	0.079	-0.067	370.1	0.165	0.080
April - 03	0.086	-0.062	369.6	0.165	0.081
April - 08	0.119	-0.038	366.9	0.169	0.085
April - 09	0.125	-0.034	366.4	0.170	0.086
April - 10	0.132	-0.029	365.8	0.171	0.087
April - 11	0.139	-0.024	365.3	0.172	0.088
April - 12	0.145	-0.020	364.8	0.173	0.089
April - 13	0.152	-0.015	364.2	0.174	0.090
April - 14	0.158	-0.010	363.7	0.174	0.090

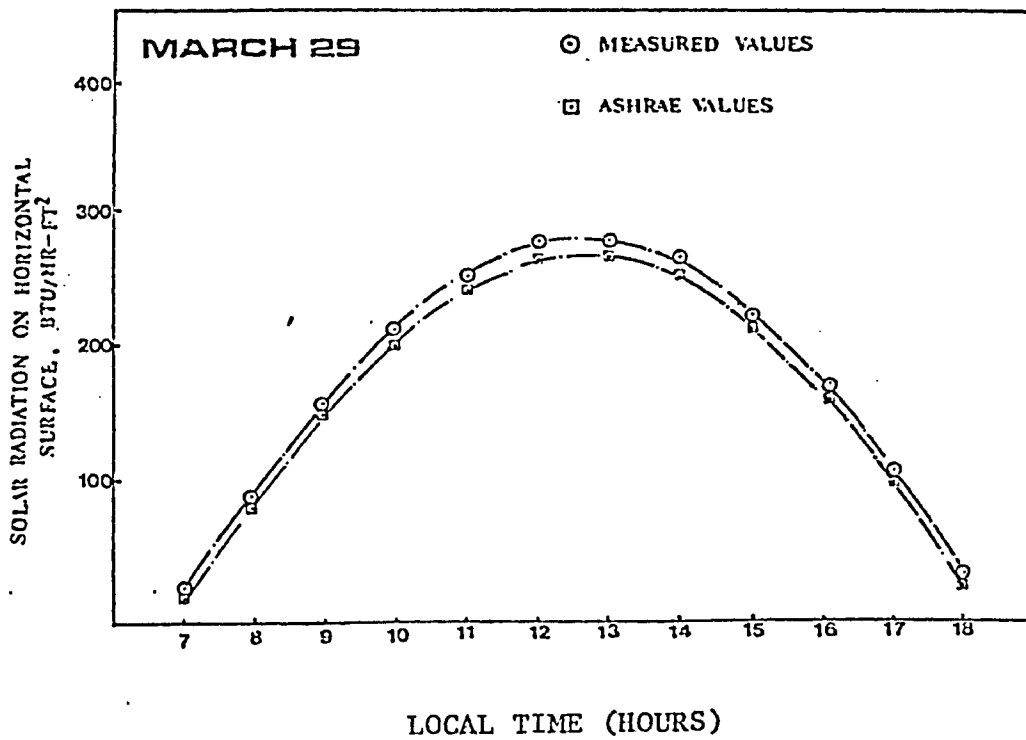

FIGURE 6.2: A COMPARISON BETWEEN ASHRAE CALCULATED AND MEASURED GLOBAL RADIATION

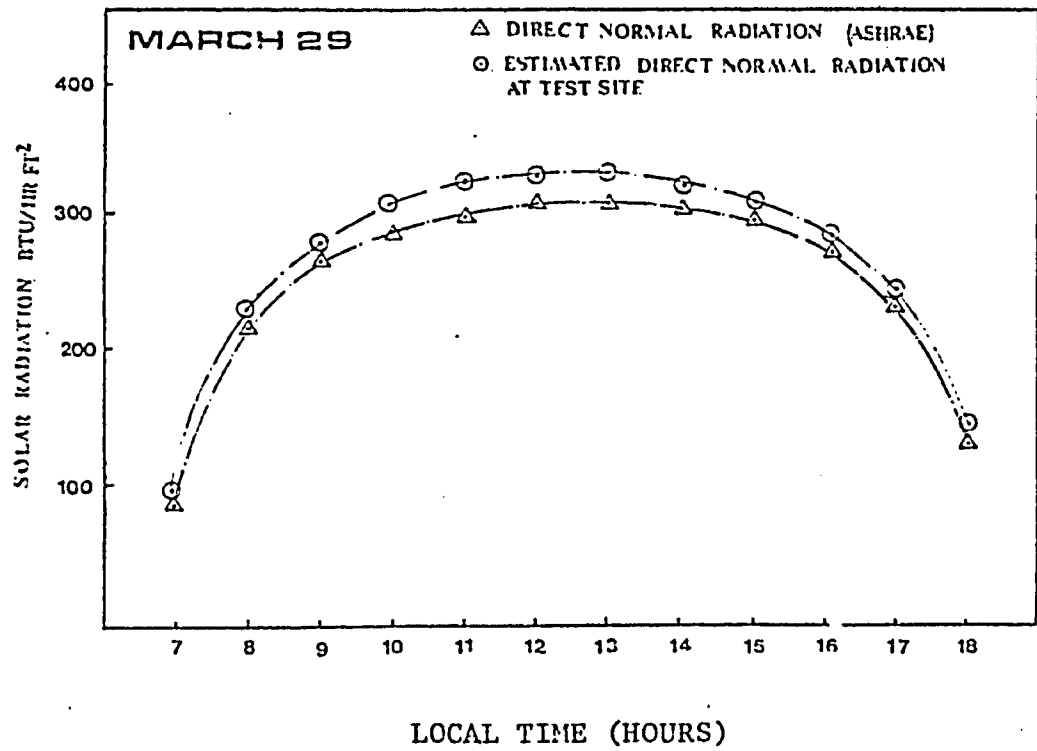

FIGURE 6.3: A COMPARISON BETWEEN ASHRAE CALCULATED AND ESTIMATED VALUES OF DIRECT NORMAL RADIATION.

direct normal radiation values were always higher than ASHRAE values, by at the most 10 percent. A concurrent experimental monitoring study (33), carried out in Windsor, Ontario, showed opposite results. The measured global radiation, under cloudless sky conditions, were always found to be less than the values obtained by ASHRAE procedures. This was due to high pollution in the industrial atmosphere of Windsor.

Clearness Number

Clearness numbers for various nonindustrial localities of North America are listed in Figure 3, chapter 26 of Reference (18). A clearness number of 1 was selected for the test site from this figure for input to the weather processor.

Ground Temperatures

During the experimental monitoring, ground temperatures were not measured at the test site. Therefore, average monthly ground temperatures were obtained from the 1968 Detroit TRY weather tape and specified in the weather program.

All processed weather information were compiled into an hourly input and transmitted to the main IBM-370 computer for insertion into the source code of the weather program.

6.5 DURATION OF WEATHER FILE

The experimental monitoring system was commissioned at 15:00 hours of March 9th and it continued to function until 14:00 hours on the 14th of April. During this period, the system ceased to

function twice due to electric power failure at the test-site. The first power failure occurred at 19:00 hours on the 15th of March and, as a result, the test data until 15:00 hours on 21st March was lost. The second power failure occurred at 14:00 hours on April the 3rd and consequently the weather data until 20:00 hours of April 8th was lost. Due to these power failures, it was impossible to keep a continuous record of the test data and hence the useful weather information were split into three periods of six, thirteen and seven days respectively.

In the input to the weather processor, it was necessary to specify the months of the year for which the weather file was to be prepared. The experimental monitoring was carried out during the months of March and the first half of April 1982. These two months were described in the weather processor. However, in order to account for the unavailable weather data for the first eight days of March (when the system was not commissioned), weather data lost due to power failures and the data for the last two weeks of April (when the system was pulled out of the test house), it was decided to enter dummy data to fulfill the input requirements of the weather processor. The dummy data contained in the weather file did not affect the predicted performance of the test house because the simulation was only carried out for those days when the monitoring system was in operation. It is however, pointed out that at the start of a simulation period, the DOE-2 program requires two preceding values of the heat loss and heat addition rates. This information is not available at

the first hour of simulation. The program overcomes this difficulty by repeating first day simulation for three times in order to generate the previous history of the building's thermal response. Research carried out at the Los Alamos Scientific Laboratory (12) has proved that this procedure is satisfactory to initialize building load calculations.

6.6 SUBROUTINE " OTHER "

A subroutine named OTHER was used to interpret the format of the unpacked weather data to the weather processor. This subroutine, written by Dr N.W.Wilson of the Mechanical Engineering Department, was put in the source code of the DOE weather processing program. The following provisions were also made in this subroutine:

1. The hourly outdoor wetbulb and dewpoint temperatures were set equal to the recorded outdoor drybulb temperatures for the entire test-duration.
2. The atmospheric pressure at the test-site was set equal to the standard barometric pressure of 29.9 inches of Hg.
3. In order to account for the unavailable data for the months of March and April, dummy weather variables were specified for the missing days of these months.

6.7 THE WEATHER FILE

The structure of the input weather data deck is shown Appendix - F . It consisted of a series of job control language

and input data cards sequentially arranged according to a prescribed order. A complete description of the weather data deck is provided in the DOE-2 reference manual (22).

After compiling all necessary weather information, the DOE weather program was run on the IBM-370 system to create a weather file in the main system disk. A sample output of the weather file for the test site is shown in Table 6.5.

TABLE 6.5
A SAMPLE OUTPUT OF WEATHER FILE

CITY - WINDSOR, ONTARIO		TZ 5		STATN -999		YEAR -999		DOE-2.1		DD/MMH/YYYY		HHCKM XM	
LAT 42.3		LON 82.9		MAR THRU APR									
REPORT - NOT PACKED		WEATHER FILE SUMMARY											
HLUR	WHT	WHT	WHT	WHT	WHT	WHT	WHT	WHT	WHT	WHT	WHT	WHT	WHT
1	33	33	29.9	0	0	0.0035	0.080	12.0	0.0	0.0	0.0	1	8
2	33	33	29.9	0	0	0.0039	0.080	12.0	0.0	0.0	0.0	1	5
3	33	33	29.9	0	0	0.0039	0.080	12.0	0.0	0.0	0.0	1	4
4	33	33	29.9	0	0	0.0039	0.080	12.0	0.0	0.0	0.0	1	4
5	33	33	29.9	0	0	0.0039	0.080	12.0	0.0	0.0	0.0	1	4
6	32	32	29.9	0	0	0.0038	0.080	11.5	25.0	96.0	0.0	1	4
7	32	32	29.9	0	0	0.0044	0.079	13.5	85.0	238.0	0.0	1	4
8	30	30	29.9	0	0	0.0046	0.079	14.0	155.0	290.0	0.0	1	4
9	30	30	29.9	0	0	0.0046	0.079	14.0	215.0	316.0	0.0	1	4
10	30	30	29.9	0	0	0.0048	0.079	14.5	259.0	329.0	0.0	1	4
11	30	30	29.9	0	0	0.0048	0.079	14.5	275.0	336.0	0.0	1	4
12	30	30	29.9	0	0	0.0050	0.079	14.5	275.0	336.0	0.0	1	4
13	37	37	29.9	0	0	0.0046	0.079	14.0	260.0	332.0	0.0	1	4
14	37	37	29.9	0	0	0.0046	0.079	14.0	220.0	329.0	0.0	1	4
15	37	37	29.9	0	0	0.0046	0.079	14.0	170.0	298.0	0.0	1	4
16	37	37	29.9	0	0	0.0046	0.079	14.0	105.0	255.0	0.0	1	5
17	36	36	29.9	0	0	0.0044	0.079	13.5	35.0	146.0	0.0	1	5
18	35	35	29.9	0	0	0.0043	0.080	13.0	0.0	0.0	0.0	1	6
19	35	35	29.9	0	0	0.0043	0.080	13.0	0.0	0.0	0.0	1	7
20	35	35	29.9	0	0	0.0043	0.080	13.0	0.0	0.0	0.0	1	7
21	35	35	29.9	0	0	0.0043	0.080	13.0	0.0	0.0	0.0	1	10
22	35	35	29.9	0	0	0.0043	0.080	13.0	0.0	0.0	0.0	1	9
23	35	35	29.9	0	0	0.0043	0.080	13.0	0.0	0.0	0.0	1	6
24	35	35	29.9	0	0	0.0043	0.080	13.0	0.0	0.0	0.0	1	6

HLUR	WHT	WHT	WHT	WHT	WHT	WHT	WHT	WHT	WHT	WHT	WHT	WHT	WHT
1	35	35	29.9	0	0	0.0043	0.080	13.0	0.0	0.0	0.0	1	5
2	35	35	29.9	0	0	0.0043	0.080	13.0	0.0	0.0	0.0	1	5
3	35	35	29.9	0	0	0.0043	0.080	13.0	0.0	0.0	0.0	1	5
4	36	36	29.9	0	0	0.0044	0.079	14.5	0.0	0.0	0.0	1	5
5	37	37	29.9	0	0	0.0050	0.079	15.5	0.0	0.0	0.0	1	5
6	41	41	29.9	0	0	0.0054	0.079	15.0	2.0	0.0	0.0	1	6
7	40	40	29.9	0	0	0.0052	0.079	15.0	23.0	0.0	0.0	1	6
8	40	40	29.9	0	0	0.0052	0.079	15.0	30.0	0.0	0.0	1	6
9	41	41	29.9	0	0	0.0050	0.079	15.0	50.0	0.0	0.0	1	8
10	42	42	29.9	0	0	0.0050	0.078	14.0	152.0	0.0	0.0	1	10
11	44	44	29.9	0	0	0.0061	0.078	17.0	252.0	0.0	0.0	1	12
12	44	44	29.9	0	0	0.0061	0.078	17.0	244.0	0.0	0.0	1	6
13	43	43	29.9	0	0	0.0058	0.078	16.5	191.0	0.0	0.0	1	6
14	43	43	29.9	0	0	0.0053	0.078	16.5	179.0	0.0	0.0	1	4
15	45	45	29.9	0	0	0.0063	0.078	17.5	126.0	0.0	0.0	1	4
16	47	47	29.9	0	0	0.0061	0.078	17.5	52.0	0.0	0.0	1	4
17	46	46	29.9	0	0	0.0061	0.078	17.0	41.0	0.0	0.0	1	0
18	46	46	29.9	0	0	0.0066	0.078	17.0	11.0	0.0	0.0	1	14
19	47	47	29.9	0	0	0.0066	0.078	17.5	0.0	0.0	0.0	1	0
20	47	47	29.9	0	0	0.0066	0.078	16.0	0.0	0.0	0.0	1	0
21	51	51	29.9	0	0	0.0079	0.076	22.5	0.0	0.0	0.0	1	7
22	54	54	29.9	0	0	0.0089	0.076	22.5	0.0	0.0	0.0	1	12
23	48	48	29.9	0	0	0.0071	0.077	19.0	0.0	0.0	0.0	1	10
24	42	42	29.9	0	0	0.0082	0.077	21.5	0.0	0.0	0.0	1	13

CHAPTER VII
MODELLING OF THE TEST HOUSE

7.1 MODELLING

The art of modelling may be defined as an accurate description of the building's location, orientation, thermophysical properties of structural components, HVAC equipment characteristics and indoor environmental control strategies, in a format that is acceptable to an energy simulation program.

The test house was modelled as an unoccupied residence using the custom weighting factor method of the DOE-2.1A program. In the input description of the building, care was taken to specify identical indoor conditions to those which existed in the unoccupied house during the test period. A complete listing of the building description input to the program is provided in Appendix-G.1 and Appendix-G.2.

The geographical location of the test-site was described by entering the longitude and latitude for Windsor, Ontario. The orientation of the test house with respect to the true north was specified by entering a building azimuth angle of (-24) degrees.

In order to comply with the input requirement of the program, a three coordinate system representing the X, Y and the Z axes was established to select a set of geometric points which were used to define the configuration of the building. An isometric view of the test-house along with the three dimensional building

coordinate system is shown in Figure 7.1 .

7.2 THERMAL ZONING OF THE TEST-HOUSE

The test-house was subdivided into four zones and described in the program as a multizone building model. This subdivision of the test-house was necessary in order to isolate the southerly oriented spaces from those which were less affected by direct solar gains. Schematics of the thermal zoning on the upper and lower floors of the house are shown in Figures 7.2 and 7.3.

ZONE-1

The living room, kitchen and the vestibule on the upper floor formed a direct gain passive solar system due to the large glazing area on the south wall. These rooms were grouped together and entered in the program as zone-1 of the building model.

ZONE-2

The master bedroom was located in the north-west corner of the upper floor. Two windows in this bedroom faced north and one small window with frosted pane faced west. Interior partitions separated this room from zone-1. Therefore this room was not directly affected by solar gains. It was combined with the two bathrooms on the upper floor and described in the program as zone-2 of the building model.

ZONE-3

The two large bedrooms on the lower floor had a combination of

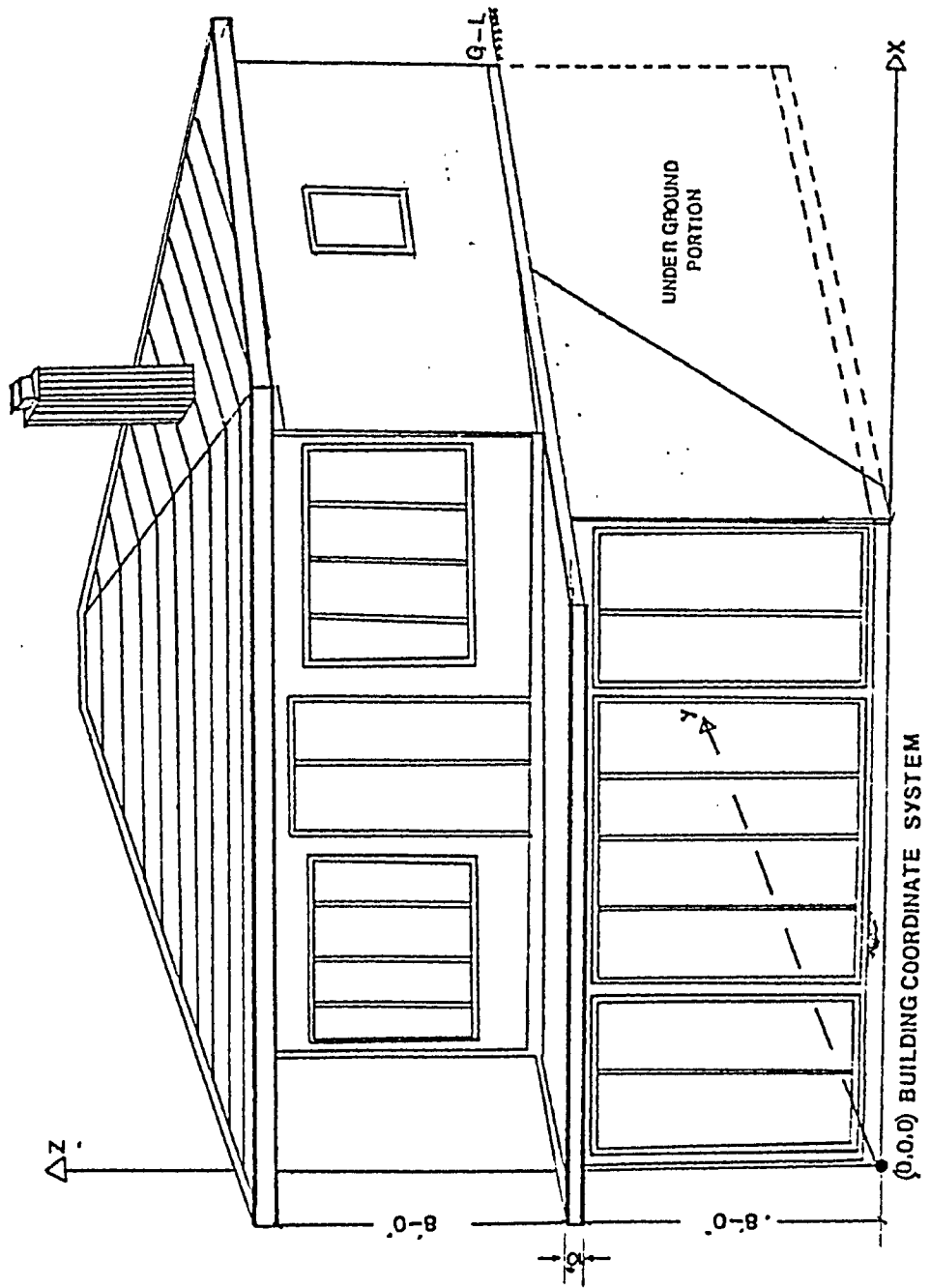

FIGURE 7-1 ISOMETRIC VIEW OF THE TEST HOUSE
SHOWING THE ORIGIN OF BUILDING
COORDINATE SYSTEM

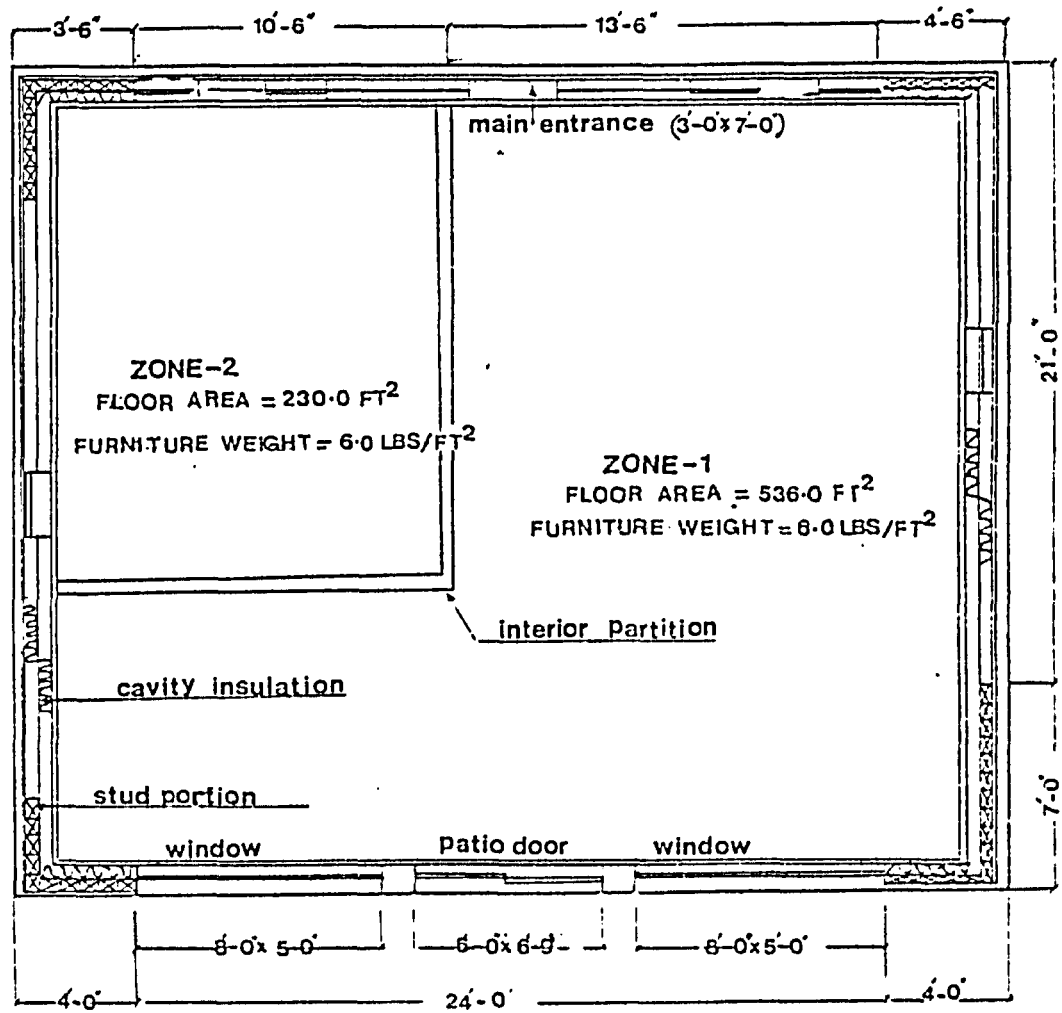

FIGURE 7.2 FLOOR PLAN OF UPPER LEVEL SHOWING DETAILS OF ZONE-1 AND ZONE-2.

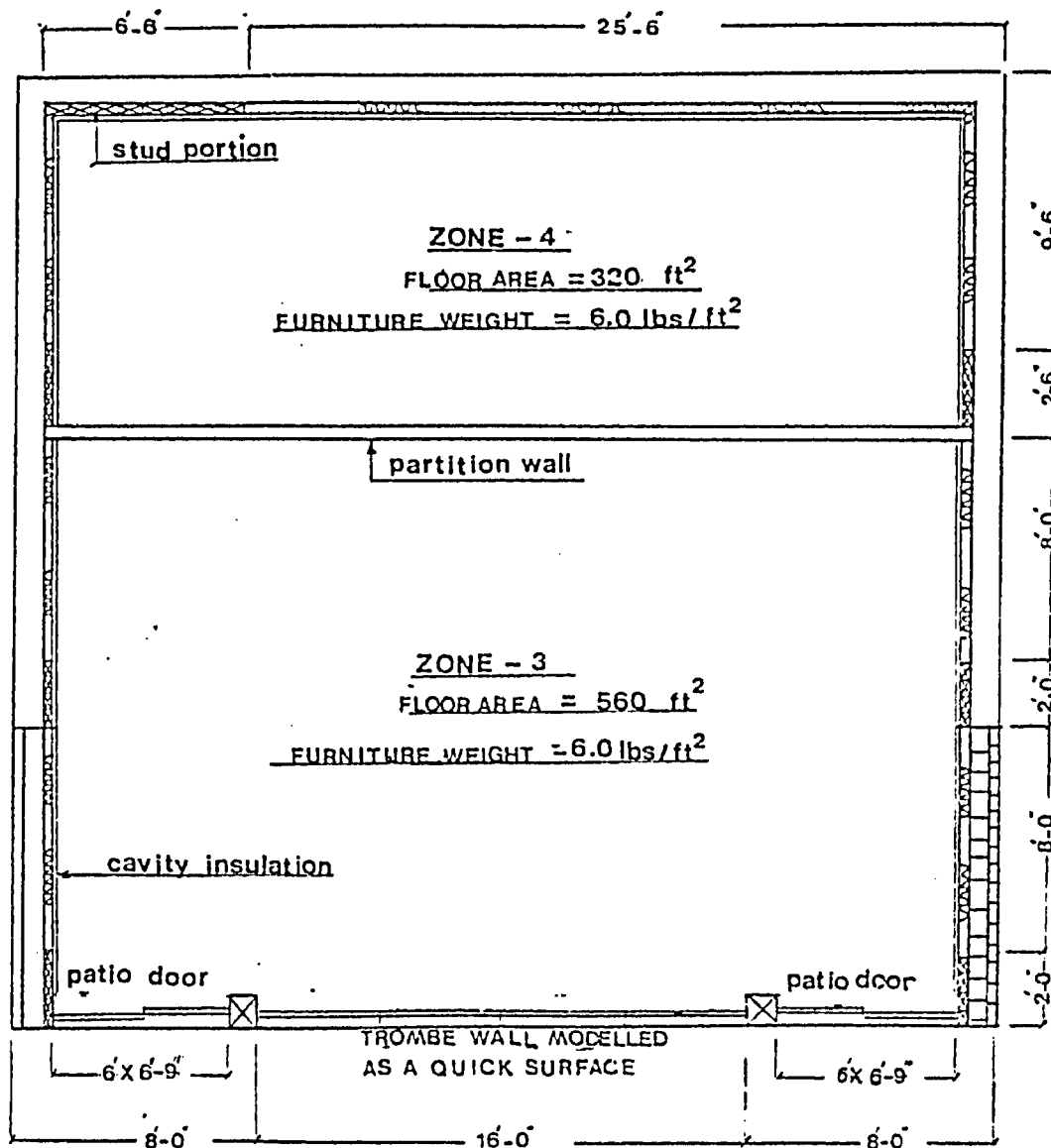

FIGURE 7.3 FLOOR PLAN OF LOWER LEVEL SHOWING DETAILS OF ZONE-3 AND ZONE-4.

a direct and an indirect gain passive solar system made up of large glazing area in the south wall with a 10 inch Trombe wall located behind a portion of this glazing. Due to identical constructional features, these bedrooms, a small washroom and a portion of lower hallway were grouped together and described in the program as zone-3 of the building model.

ZONE-4

The utility room, storage area and the remaining portion of the lower hallway including the staircase were entirely below grade and located in the north portion of the lower floor. Since these spaces were not affected by direct solar gains, they were combined together and entered in the program as zone-4.

The geometric configuration and space coordinate system of the thermal zones and their orientation with respect to the building coordinate system are shown in Figures 7.4, 7.5, 7.6 and 7.7 respectively.

7.3 MATERIALS LIBRARY

The thermophysical properties of the materials used in the construction of the test-house were required by the program to calculate the thermal resistance of each structural component and to generate custom weighting factors for each thermal zone of the building model.

In order to comply with this requirement, a materials library was created in the program by specifying the thickness, density,

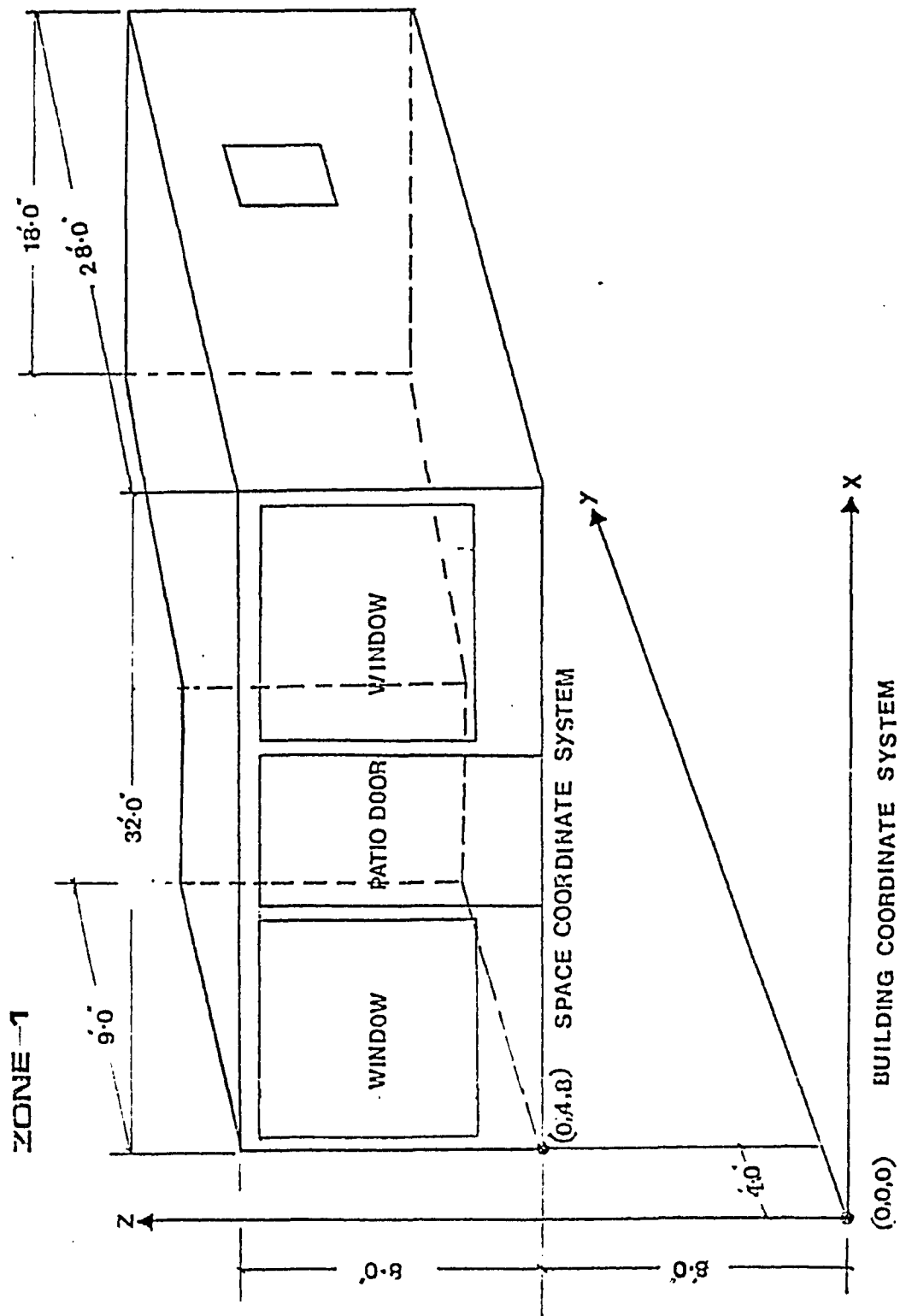

FIGURE 7-4 GEOMETRIC CONFIGURATION OF ZONE-1

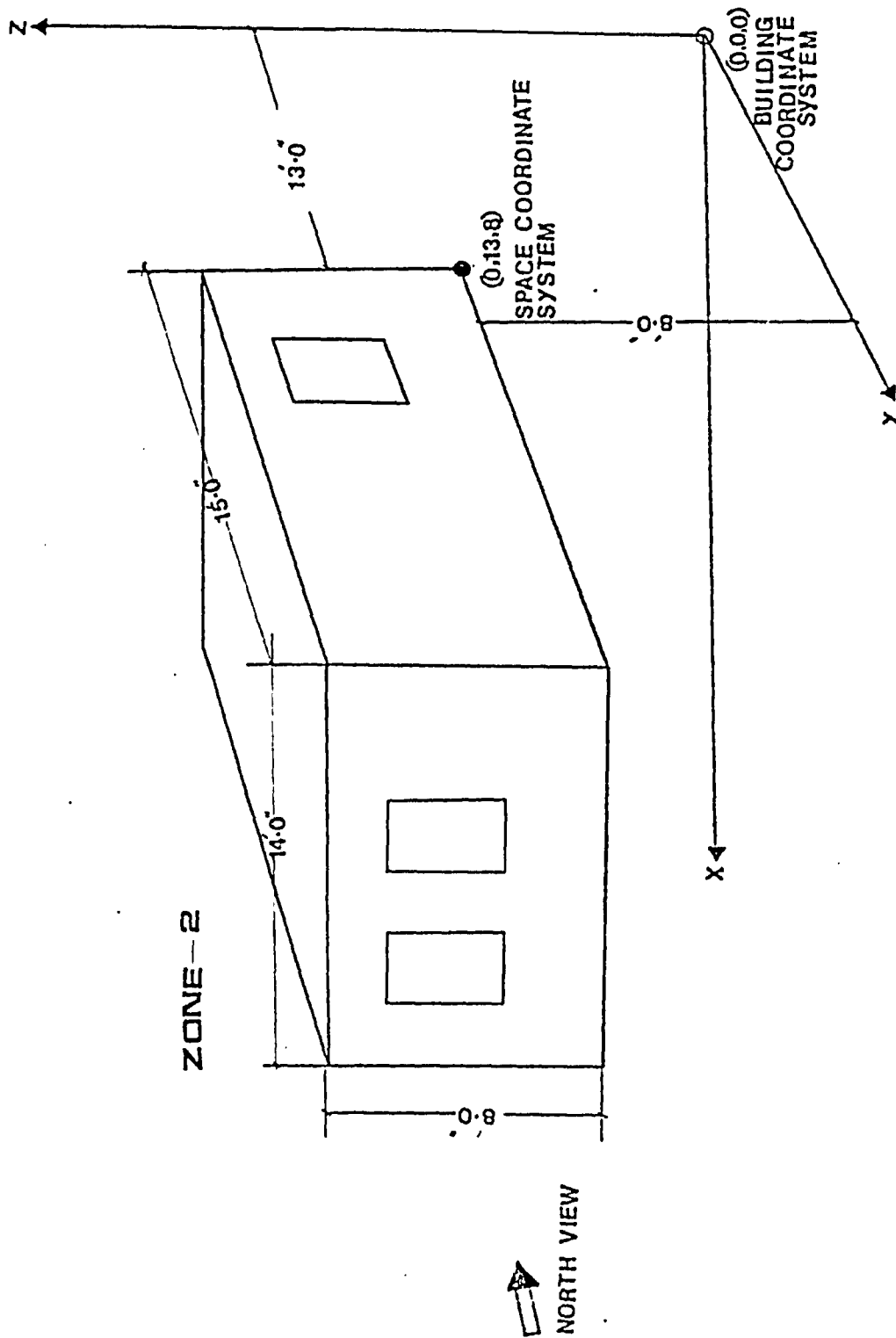

FIGURE 7-5 GEOMETRIC CONFIGURATION OF ZONE-2

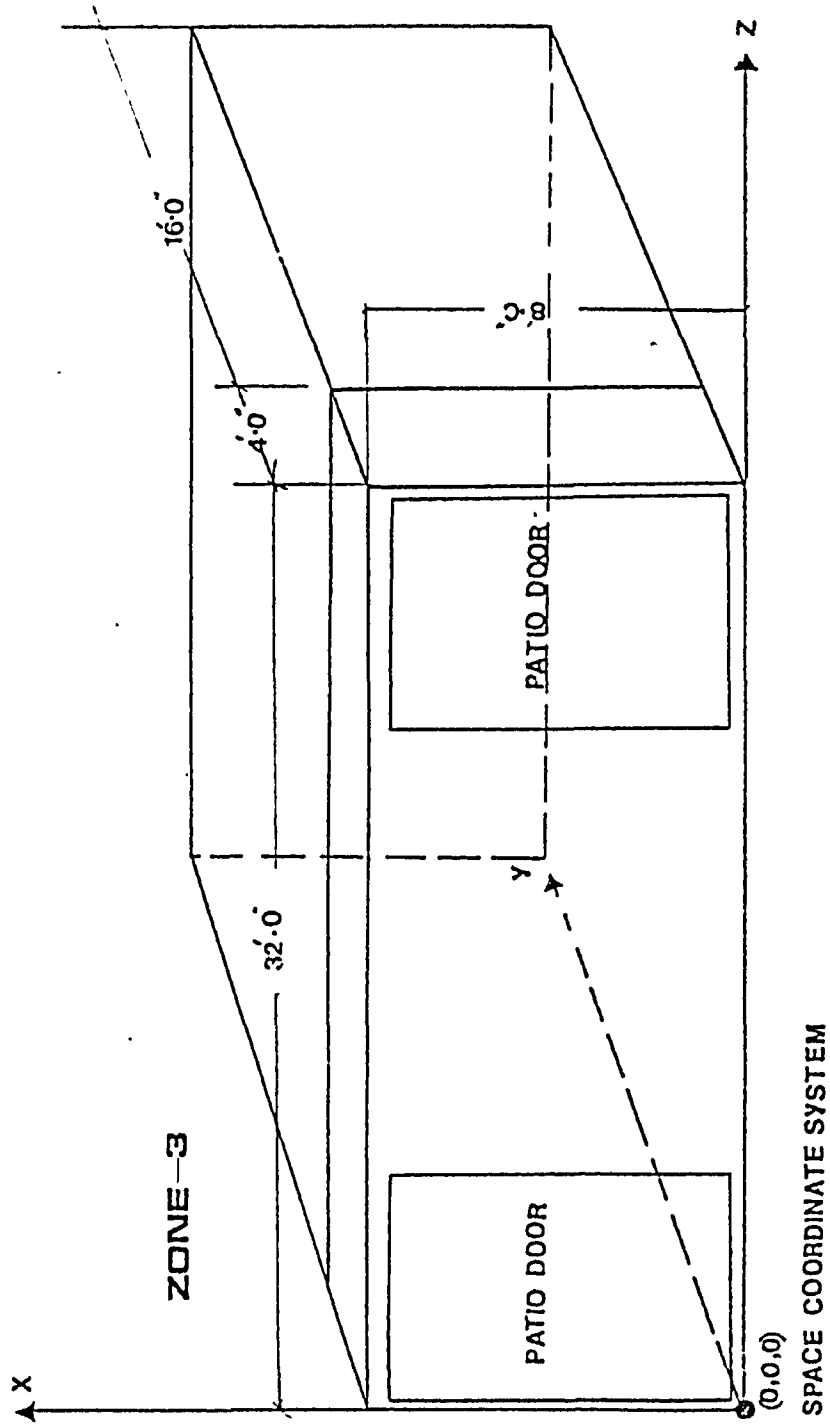

FIGURE 7-6 GEOMETRIC CONFIGURATION OF ZONE-3.

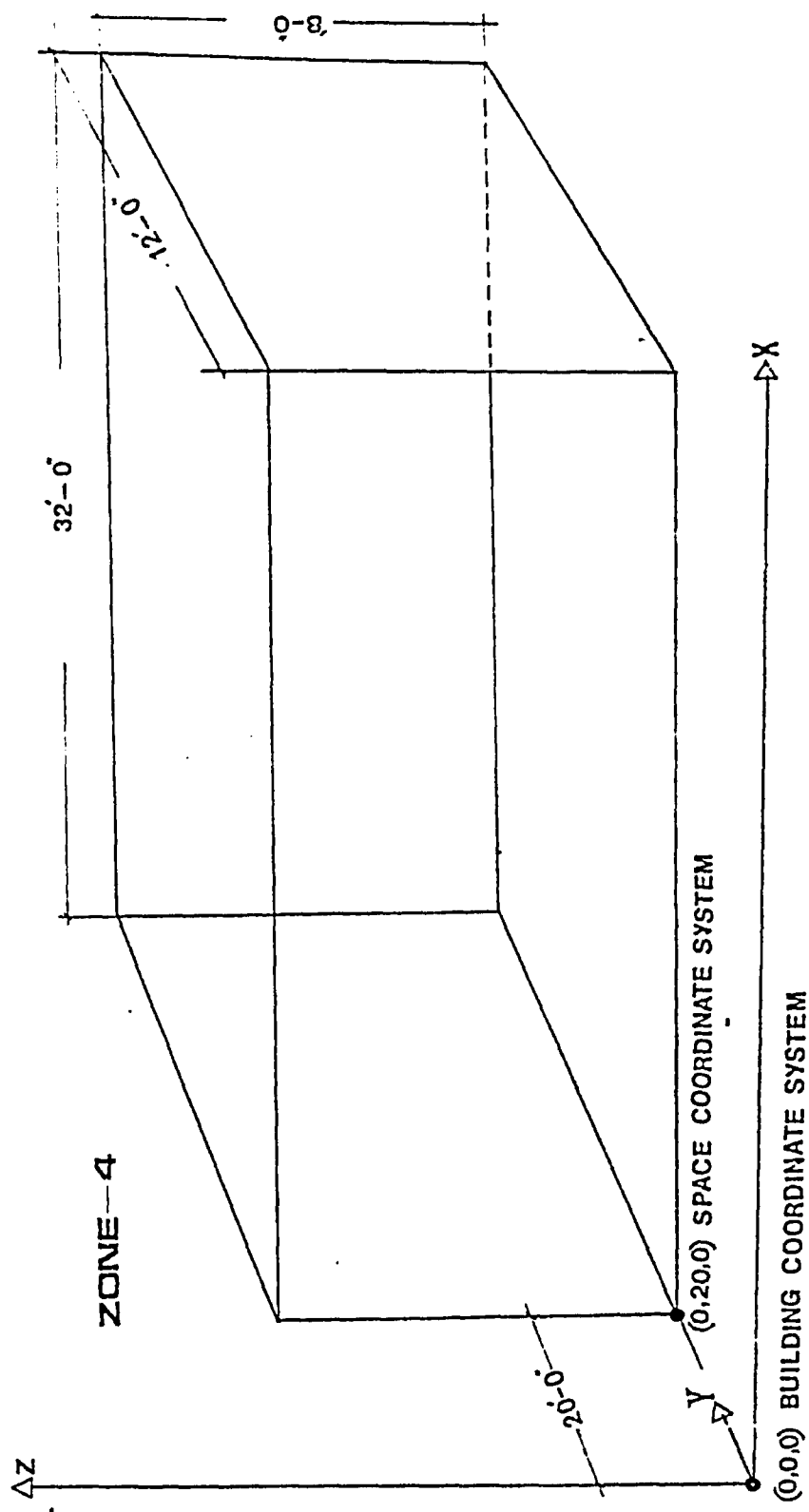

FIGURE 7-7 GEOMETRIC CONFIGURATION OF ZONE-4.

conductivity and specific heat of all constructional and insulation materials used in the formation of the building envelope. The thermophysical properties of these materials were extracted from the ASHRAE's 1977 Handbook of Fundamentals. Each material, specified in the materials library, was designated with a code name for easy identification at a later stage. The materials library created in the DOE-2 program is shown in Table 7.1.

7.4 MODELLING OF THE BUILDING'S STRUCTURAL MEMBERS

All structural members including walls, roofs, ceilings and floors forming the exterior envelope of the test-house were described into the program as a series of rectangles. Each of these rectangles representing a specific wall or a roof was properly oriented with respect to the building's coordinate system. The construction of each structural member was described by identifying, from the outer - most to the inner most surface, the code name for each component layer of material used in the formation of a particular wall or roof.

All exterior walls, interior partitions, underground walls, roofs and floor forming the building envelope and partitions between various thermal zones were modelled as delayed surfaces. The cavity insulation and the stud/joist portion of the exterior/underground walls and roofs were physically separated for better approximation of the heat transfer through the building envelope. The stud and cavity insulation of the walls

TABLE 7-1

THE MATERIALS LIBRARY

MATERIAL	THICKNESS FEET	CONDUCTIVITY BTU/HR.FT.F	DENSITY LBS/FT ³	SPECIFIC HEAT BTU/LB.F	RESISTANCE ² HR.FT.F/BTU
2x4 STUD	0.2917	0.0677	32.0	0.33	-
0.5 INCH DRYWALL	0.0417	0.0925	50.0	0.26	-
VAPOR BARRIER	0.0003	0.1100	70.0	0.40	-
FIBRE GLASS					
INSULATION (R 12)	0.2917	0.0238	0.6	0.20	-
STYROFOAM BOARD	0.1250	0.0133	1.5	0.29	-
4 INCH FACE BRICK	0.3333	0.7500	130.0	0.22	-
10 INCH CONCRETE BLOCK	0.8333	0.7800	36.0	0.21	-
2x6 CEILING JOIST	0.5000	0.0667	32.0	0.33	-
110 LBS SHINGLES	0.0208	0.0473	70.0	0.30	-
ASPHENITE	0.0420	0.2667	32.0	0.33	-
ATTIC AIR SPACE	-	-	-	-	3.1
FIBRE GLASS					
INSULATION (R 42)	1.0000	0.0238	0.6	0.20	-
FIBRE GLASS					
INSULATION (R 21)	0.5000	0.0238	0.6	0.20	-
2x8 CEILING JOISTS	0.7000	0.0667	32.0	0.33	-
PLYWOOD	0.0417	0.0667	34.0	0.29	-
BUILTUP ROOFING	0.0310	0.0946	70.0	0.35	-
CEDER DECKING	0.1700	0.0670	32.0	0.33	-
FIBRE GLASS					
INSULATION (R 30)	0.6700	0.0238	0.6	0.20	-
3.5 INCH AIR SPACE	-	-	-	-	0.93
9 INCH AIR SPACE	-	-	-	-	1.01
PLYWOOD	0.0834	0.0667	34.0	0.29	-
CARPET PAD	0.0625	0.0756	82.0	0.315	-
4 INCH CONCRETE	0.3333	0.7576	140.0	0.200	-
POLYSTYRENE	0.1670	0.0167	2.2	0.290	-
6 INCH CONCRETE BLOCK	0.5000	0.7800	38.0	0.200	-
WOOD SIDING	0.0830	0.0667	32.0	0.330	-
FALSE RESISTANCE	-	-	-	-	5.0
FALSE RESISTANCE	-	-	-	-	30.0

were proportioned as 20 and 80 percent, respectively, according to the constructional details. Similarly, the ceiling joist and cavity insulation were also physically separated in proportion of 10 and 90 percent of the total surface area according to the constructional details. The DOE-2 program uses sol-air temperatures to calculate conduction losses through exterior surfaces. Therefore, appropriate absorptance values were obtained from the DOE-2 manuals (22) and assigned to the exterior walls and roofs.

The extended overhangs on the southern glazings of the upper and lower levels were accurately modelled as rectangular surfaces, properly oriented with respect to the building coordinate system.

7.5 MODELLING OF THE TROMBE WALL

In the current version, the DOE-2 program is incapable of simulating the performance of an indirect gain passive solar system. This imposed a limitation on the use of the program to model zone-3 which had a 10 inch concrete Trombe wall. However, to complete the building description, the Trombe wall and its glazing were combined and modelled as a quick surface (a surface which does not have the ability to store heat). The thermal mass of the Trombe wall was, however, included in the furniture weight of zone-3.

7.6 MODELLING OF THE WINDOWS AND THE DOORS

Throughout the experimental monitoring of the test-house, the

insulating shutters on the southern glazings, Trombe wall and a small window in the eastern wall of zone-1 were left open in order to utilize the solar energy for space heating. Four small windows located in the northern walls of the upper floor remained covered with insulating shutters for energy conservation and to meet the security requirements of the house.

In preparing an input for the program, all windows and patio doors were modelled as double glazed windows with 20 percent wood framing. A frosted window located in the western wall of zone-2 was modelled as a single glazed window with 20 percent wooden framing. In the modelling of these windows, care was taken to specify their exact location in the respective walls by assigning proper surface coordinates and appropriate window set backs.

The heat transmission coefficients for the double and single glazed windows were selected as 0.58 and 1.10 Btu/Hr.Ft.² F from Table 8-A in the ASHRAE 1977 Handbook of Fundamentals. Adjustment factors of 0.95 and 0.9 were selected from the same table to modify the heat transmission coefficients for opacity of wooden framing. The adjusted values of the heat transmission coefficient for the two types of windows were 0.55 and 0.99 Btu / Hr. Ft.² F, respectively.

In addition to the correction made for the wooden framing, the four small windows located in the north wall of the upper floor were also modified to account for the thermal resistance of the insulating shutters. The modified overall heat transmission

coefficient of these windows was $0.19 \text{ Btu/Hr.Ft.F.}^2$

The DOE-2 program calculates hourly values of outdoor air film resistance for the exterior walls and windows. To be consistent with the DOE-2's input requirement, the modified heat transmission coefficients for all windows and patio doors were converted into equivalent glass conductance before being entered into the program.

The following equation specified, in the DOE-2 reference manual (22), was used to calculate the glass conductance.

$$GC = (1 / U - R_{\text{film}})^{-1} \quad (7.1)$$

$$R_{\text{film}} = 1 / (-0.001661 \times V^2 + 0.302 \times V + 1.45) \quad (7.2)$$

Where GC is glass conductance Btu/Hr.Ft.F, U is modified heat transmission coefficient Btu/Hr.Ft.F and V is the design outdoor wind speed in Knots. The glass conductances, for various windows and patio doors of the test house, calculated according to equation 7.1 are listed in Table 7.2.

A shading coefficient of 0.81 was selected from Table 28-B in the ASHRAE 1977 Handbook of Fundamentals for double glazed windows and patio doors. It was modified to 0.65 by applying a correction factor of 0.8 in order to account for the opacity of the windows and patio doors framing. The shading coefficient of four small windows that were covered with the insulating shutters was adjusted to zero. The shading coefficient of the single glazed frosted window was selected as 0.67 from Table 28-A of the ASHRAE 1977 Handbook of Fundamentals. It was adjusted to 0.54 by

TABLE 7.2
 PROPERTIES OF WINDOW GLASSES

Description	Number of Panels	Shading Coefficient	Glass Conductance Btu/Hr.Ft ² .F°
Windows and Patio Doors without Insulating Shutters.	2	0.65	0.620
Windows with Insulating Shutters.	2	0.00	0.217
Frosted Window	1	0.54	1.230

applying a correction factor of 0.8 . The modified shading coefficients of all the windows are also listed in Table 7.2 .

The main entrance door of the test-house was modelled as a quick surface. The equivalent heat transmission coefficient of this door was selected as 0.49 Btu/Hr.Ft.² from Table 9, Chapter 22 in the ASHRAE 1977 Handbook of Fundamentals.

7.7 MODELLING OF THE FURNITURE

The modelling of furniture and its proper distribution within a space is important for the accurate calculation of the custom weighting factors. In the DOE-2.1A program, the furniture is assumed to be composed of a slab of material with specified properties. Two furniture types are available in the DOE-2 program. These include light weight furniture composed of a 2 inch slab of 40 lbs/ cu.ft., density, and heavy furniture composed of a 3 inch slab of 80 lbs/cu.ft., density. The total quantity of furniture is specified as the mass of furniture per unit floor area, distributed over a certain fraction of the floor space. The amount of radiant energy incident on the furniture is determined from the fraction of floor area covered with the furniture.

The furniture in zone-1 consisted of standard items that are normally present in the kitchen and living room of an ordinary single family residence. One exception to that was a large fireplace located in the living room. The weight of the interior furnishings, fireplace and interior walls separating the

vestibule from the living room were approximated and entered into the program as 6.0 lbs/sq.ft., of floor area, light weight furniture distributed over 50 percent of the floor area.

The weight of the furniture in zone-2, which included the partition walls separating the master bedroom from the two bathrooms, was also approximated as 6.0 lbs/sq.ft., of floor area, light weight furniture distributed over 50 percent of the floor area.

During the test-period, one of the bedrooms in zone-3 contained light domestic furnishings, whereas the other room was almost empty. The two rooms, however, shared a massive concrete Trombe wall and an interior partition wall which represented a considerable amount of thermal mass. The weight of furniture which included the Trombe wall and the interior partition walls was estimated and specified into the program as 6.0 lbs/sq.ft., of floor area, light type furniture distributed over 50 percent of the floor area.

The thermal mass in zone-4 mainly consisted of a partition wall, staircase, washer, dryer and hot water tank etc. The weight of all these items was also approximated as 6.0 lbs/sq.ft., of floor area, light weight furniture distributed over 50 percent of the floor area.

7.8 INTERNAL HEAT GAINS

Throughout the experimental monitoring of the test-house, there was a continuous heat dissipation from the data acquisition

system and a refrigerator unit located in the living room and the kitchen areas. Internal heat gains in zone-1 resulting from these sources were required to be properly modelled in order to obtain a reliable simulation of this space. Heat dissipation from the data acquisition system, which consisted of a data logger and a microcomputer was measured and found to be 0.1 kW. Heat dissipation from the refrigerator unit was obtained as 0.14 KW by referring to the energy consumption data for various household appliances published by Ontario Hydro (27). The sum total of 0.25 KW heat dissipated by these devices was scheduled in the DOE-2 program as a continuous source of hourly internal heat gain in zone-1.

7.9 INFILTRATION

Infiltration is the natural leakage of outside air into a building through the cracks and crevices located across the building envelope. It is caused by a pressure differential across the building envelope due to the combined action of the wind and indoor-outdoor temperature differences. The directional nature of infiltration is considered to be important if the building is not adequately shielded against the effects of strong winds and the leakage openings are concentrated on one side of the building envelope. The accuracy of simulated results largely depends upon the extent to which a simulation program is capable of modelling the infiltration losses from a heated building. Several methods have been developed and incorporated into different computer programs

to approximate the infiltration in various types of buildings.

The DOE-2.1A program simulates the infiltration into residential buildings by one of the following three methods:

1. The Air Change Method.
2. The Residential Method.
3. The Crack Length Method.

The air change method models infiltration as a linear function of wind speed. The air change per hour due to infiltration is specified for a wind speed of 10 miles per hour which varies in proportion to the wind speed with respect to this reference value. The directional nature of infiltration is not taken into account in this method.

The residential method of predicting the infiltration is basically a multiple regression model that is linear in the wind speed and the temperature terms. The general form of this model is as follows:

$$I = K1 + K2 \times V + K3 \times DELT \quad (7.3)$$

Where V is the wind speed in Knots, DELT is the absolute value of the indoor-outdoor temperature difference, and K1, K2 and K3 are the coefficients in the regression model.

The values of these regression constants depend upon the leakage characteristics of the building. In the absence of wind and indoor - outdoor temperature difference, the coefficient K1 represents a constant air change which is

attributed to the occupant life style such as opening and closing of the doors / windows, turning on exhaust fans and other similar activities.

In the 1981 Handbook of Fundamentals (29), ASHRAE has specified typical values of regression coefficients for three types of residential constructions. These include a tight, medium and a loose construction. Typical regression coefficients and their applicability to different classes of residential constructions are listed in Table 7.3.

These regression coefficients were used in the residential infiltration model to determine the infiltration rate for three categories of residential buildings. Based on an average outdoor weather condition of 10 miles per hour wind speed and an indoor-outdoor temperature difference of 35 degrees F, as existed at the site during the test period, these regression coefficients produced an infiltration rate of 0.5, 0.7 and 0.9 air changes per hour for the tight, medium and loose classes of residential constructions. These infiltration rates seem to be reasonable as they were comparable with the infiltration rates of 0.4 and 0.6 air change per hour for tight and medium constructions, as predicted by the Achenbach-Coblentz equation and used to establish the Building Energy Performance Standards for residences (17).

The crack length method models infiltration by taking into account the leakage characteristics of the structural components, neutral pressure level, and the pressure difference caused

TABLE 7.3

REGRESSION COEFFICIENTS FOR THE RESIDENTIAL INFILTRATION MODEL

Type Of Construction	K1	K2	K3	Building Description
Tight	0.1	0.0175	0.00611	New buildings with special precautions to prevent infiltration.
Medium	0.1	0.0252	0.00944	Buildings constructed using conventional procedures.
Loose	0.1	0.0345	0.01278	Evidence of poor construction.

across the building envelope due to wind velocity and stack effect.

For each exterior wall, window and a door, the pressure due to wind is calculated as follows:

$$PTWV = 0.000638 \times WNDSPD^2 \times \cos(DIR) \quad (7.4)$$

where PTWV is the velocity pressure in inches of water, WNDSPD is the wind speed in Knots and DIR is the angle between the surface outward normal and the wind direction. If DIR is greater than or equal to 90 degrees, then the velocity pressure for that surface is set equal to zero.

For each space the pressure due to stack effect is calculated as follows:

$$PSE = 0.255 \times PATM \times \left\{ \frac{1}{T_o} - \frac{1}{T_i} \right\} \times (ZHT) \quad (7.5)$$

where PATM is atmospheric pressure in inches of Hg, T_o and T_i are the outdoor and the indoor temperatures in degrees R, and ZHT is the distance in feet from the zone mid height to the neutral pressure level. The value for ZHT is negative for spaces that are above the neutral pressure level.

The total pressure caused by the wind and the stack effects is calculated by summing up the two pressures.

$$PT = PTWV + PSE \quad (7.6)$$

Infiltration through an exterior surface is calculated according to the following equation:

$$\text{CFM} = C \times (\text{PT})^n \times A \quad (7.7)$$

where C is the infiltration coefficient, PT is the total pressure in inches of water, n is the flow exponent and A is the area of the exterior surface in sq.ft. The infiltration coefficient C is required to be specified as air leakage in CFM at a unit pressure difference per square foot for a delayed wall construction. However, for a quick surface such as windows, doors and light walls with negligible mass, the infiltration coefficient is required to be specified as leakage in CFM per linear foot of the perimeter. It is for this reason that the surface area A in equation 7.7 is replaced by perimeter L when infiltration is calculated for windows, doors and quick walls.

Limited data is available in the literature to specify the infiltration coefficients of various structural components of a building. ASHRAE has specified typical values for the infiltration coefficients of different classes of wall constructions, windows, and doors. These values may not necessarily represent the true leakage characteristic of a specific building being analyzed. It is quite likely that the use of these values may result in an over or under estimation of infiltration losses. However, in the absence of reliable data, these values are to be relied upon.

Infiltration in zone-1, zone-2 and zone-3 of the test house was found to be directional in nature due to a non uniform distribution of the leakage openings. The directional effects

were found to be significant under high southerly and easterly winds.

A fan depressurization test was carried out on the house to determine its leakage characteristics (see Appendix- D). Based on the results of this test and the leakage openings found in different spaces, zone-1 and zone-4 were categorized as medium construction, zone-2 as a tight construction and zone-3 as a loose construction.

Infiltration in the test house was modelled by using the residential and the crack length methods. The residential method was applied to all the four thermal zones. Based upon the fan depressurization test, appropriate regression coefficients were selected from Table 7.3 and assigned to each of the four thermal zones. Since the test house was monitored in an unoccupied state, the regression coefficient K_1 was equated to zero in order to eliminate the occupants effect. The crack length method was also employed to model infiltration in zone-1, zone-2 and zone-3. Leakage data available in Tables 3, 4 and 5, Chapter 21 of ASHRAE 1977 Handbook of Fundamentals was used to specify the leakage characteristics of each zone.

7.10 MODELLING OF THE UNDERGROUND SURFACES

In order to prepare an input for the underground surfaces the ASHRAE design approach was used to estimate the effective U-values for the underground walls and floors in zone-3 and zone-4. Details of this analysis are provided in Appendix-E. Based on

this analysis, the underground floor construction of zone-3 was modified to obtain an effective U-value of 0.16 Btu /Hr.Ft.² F. Similarly the underground floor construction of zone-4 was also modified to obtain an effective U-value of 0.0324 Btu/Hr.Ft.² F. The actual U-value of the underground walls was found to be almost identical to their effective U-value as calculated by the ASHRAE method. The underground walls were therefore specified without any modification to their U-values.

7.11 MODELLING OF THE HEATING SYSTEM

Thermostatically controlled baseboard units were modelled to provide space heat in each of the four thermal zones. Individual output capacities of the baseboard heaters located in each zone were summed up for input to the program. To comply with the types of systems available in DOE-2, the baseboard units in each zone were supplementary to a hypothetical central system with a very small capacity. It is assumed in the DOE-2 program that heat from the baseboard unit is available whenever heat from the central system is available. Therefore to activate the baseboard unit, heat from the central system was scheduled to be available throughout the simulation period. Since thermostatically controlled baseboard units were specified, the program simulated the control of the baseboard heating element in sequence with the central system. The simulated system first activated the baseboard heaters and turned on the central heating system only if the maximum baseboard heater capacity was reached. It was mentioned earlier that the total heating capacity of the

baseboard units was almost 1.5 times the design heat loss of the space which the unit was serving. Since the baseboard heating capacities were sufficient to meet the heating load at all times, no heat from the main system was ever required.

During the experimental monitoring, thermostats of the baseboard heaters were set to maintain each space at a minimum indoor temperature of 70 degrees F. Steady state temperature profiles of each space, measured with the thermocouples, were used to schedule heating in each of the four thermal zones.

CHAPTER VIII
RESULTS AND DISCUSSION

8.1 INTRODUCTION

The test house was simulated as a four zone building model using actual weather conditions. The simulation was subdivided into four periods from March 10th to March 15th, March 22nd to March 25th, March 28th to April 2nd and April 8th to April 13th. This subdivision of the simulation period was necessary to eliminate the days when the experimental data was lost due to local power failures or when the house was occupied by the owner.

One objective of this comparative study was to determine the accuracy of the DOE-2.1A program's predictions of space temperatures and space heat requirements for a direct gain passive solar system when the custom weighting factor method was used. Since the direct gain passive solar features were included in zone-1, this space was analyzed in great detail.

Infiltration in zone-1 and zone-2 of the test model was simulated by using the crack length and the residential methods of the DOE-2 program. In order to evaluate the advantages and disadvantages of the crack length and residential methods for the test house, it was decided to analyze the predicted performance of these zones by using the two methods.

The measured and simulated performance of zone-1 and zone-2 was compared on an hourly basis. These comparisons were made between the measured and predicted values of the baseboard energy

consumption and space temperatures. The daily comparisons were restricted to the total baseboard energy consumption for zone-1, zone-2 and zone-4, and were used to provide an overview of the measured and predicted energy consumption.

The measured and simulated performance of zone-3 was, however, not comparable due to the following reasons:

1. The DOE-2 program does not simulate the performance of a Trombe wall system, and zone-3 had a Trombe wall.
2. A large grille was installed underneath the southern overhang of the lower level to ventilate the air space between the joists of the overhang. Figure 8 is a cross-sectional view of the Trombe wall which clearly illustrates the location of this grille. In the final stage of construction the seal between the overhang and the Trombe wall air space was apparently broken by the contractor who had installed the roller shutters. This provided a direct air leakage path from the grille into the Trombe wall air space. During southerly winds, positive pressure around the overhang caused an air flow through the grille into the overhang air space. A major portion of this flow went into the Trombe wall air space causing high infiltration in zone-3. The residential infiltration model could not simulate this situation due to its inability to account for the directional effects of wind. Although the crack length method takes into account the wind directional effects, it does not simulate wind driven infiltration through horizontal exterior surfaces. This

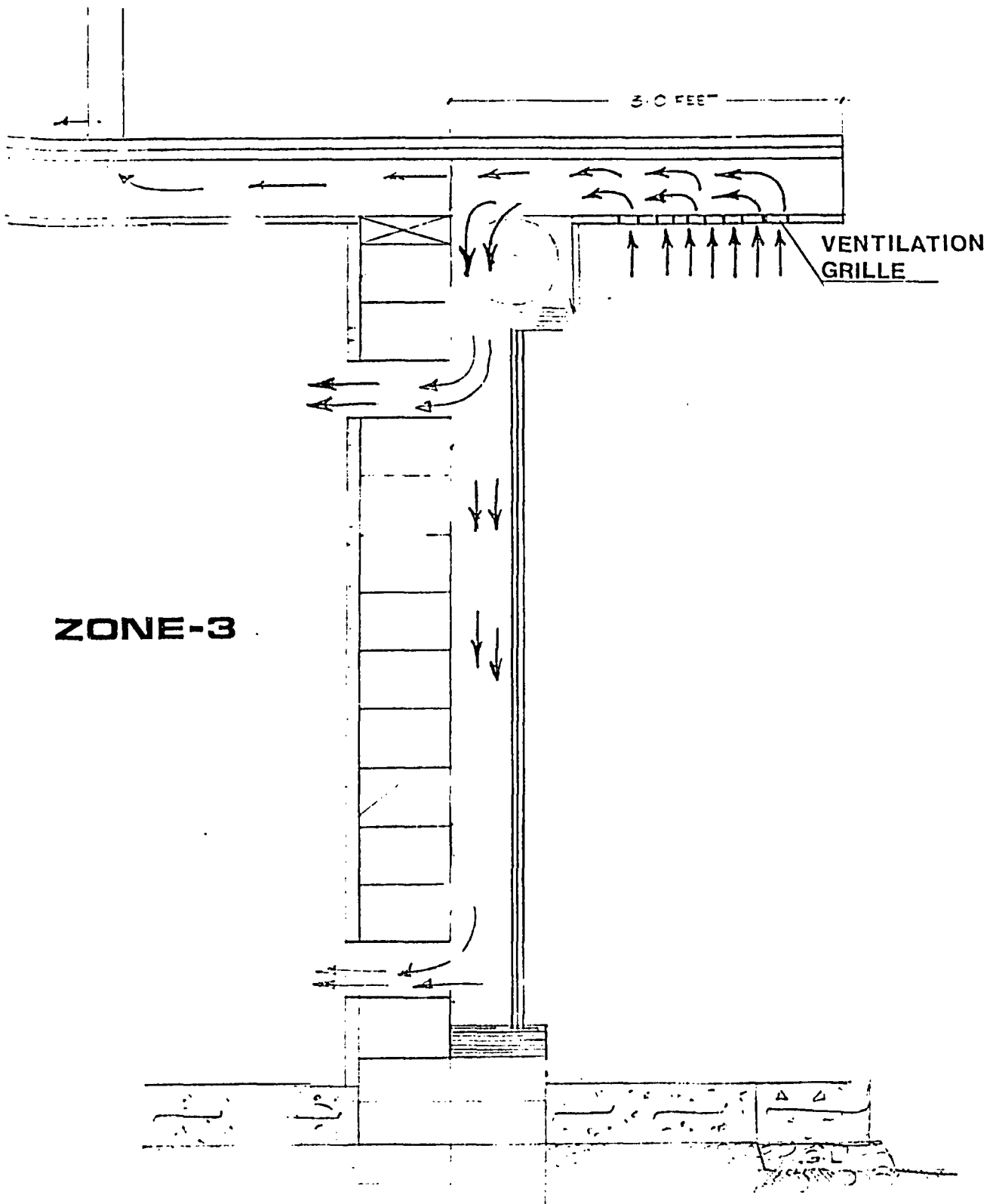

ZONE-3

FIGURE-8 CROSS-SECTIONAL VIEW OF TROMBE WALL

method was, however, used to model air leakage through the ventilation grille by assigning an infiltration coefficient for leaky windows, obtained from Reference (18), to the Trombe wall glazing. The infiltration coefficient was arbitrarily increased in successive runs of the DOE-2 program in an attempt to model infiltration through the ventilation grille. The simulated results, however, indicated that this approach did not effectively model the air leakage through the grille as infiltration was under and overpredicted during low and high southerly winds, respectively.

The presence of a Trombe wall in zone-3, which essentially represented a large thermal mass, did not cause a serious problem in the use of DOE-2 program for this zone, since it was included in the furniture weight. However, the fact that this zone had a unique leakage opening in a horizontal plane imposed a serious limitation to adequately simulate the performance of zone-3, since the crack length method was also not able to model high infiltration through this opening. It is also very unlikely that a normal house would ever have such a unique leakage opening which had primarily originated because of careless workmanship. Hence any further effort to modify the DOE-2 infiltration models to simulate abnormal leakage through this particular opening was not considered to be justified, and it was decided to exclude this zone from the comparative analysis.

It is, however, worthwhile to point out that zone-3 of the test model was connected to zone-4 and zone-1 through a hallway

and a staircase opening. The monitored results indicated that the energy requirements of these inter-connected spaces were affected by an inter-zone heat transfer. Hence in the energy analysis of zone-1 and zone-4 inter-zone heat transfer was given due consideration.

8.2.0 ANALYSIS OF ZONE-1

The layout plan of zone-1 and its orientation with respect to true north are shown in Figure 8.1. The locations of baseboard heaters and various wind directions are clearly marked in this figure. During the fan depressurization test (see Appendix-D), several abnormal leakage openings were detected in the south, east and north walls of this zone. The locations of these leakage openings are also shown in Figure 8.1. These openings included an air vent for the fireplace and several penetrations in the vapour barrier for the shutter control straps and power cords for the baseboard heaters. The penetrations in the vapour barrier were apparently not caulked and hence were a source of significant air leakage under the influence of southerly and north easterly winds. The effect of these openings was found to be more prominent in the case of the penetration for power supply wires of the baseboard heaters. These openings provided a direct path for air leakage around the thermostat of heaters located in the south and east walls. The output from these heaters was hence affected by the temperature of outdoor leakage air.

LEGENDS

- Shutter Strap Control Penetration.
- ▣ Heater
- Wind Direction

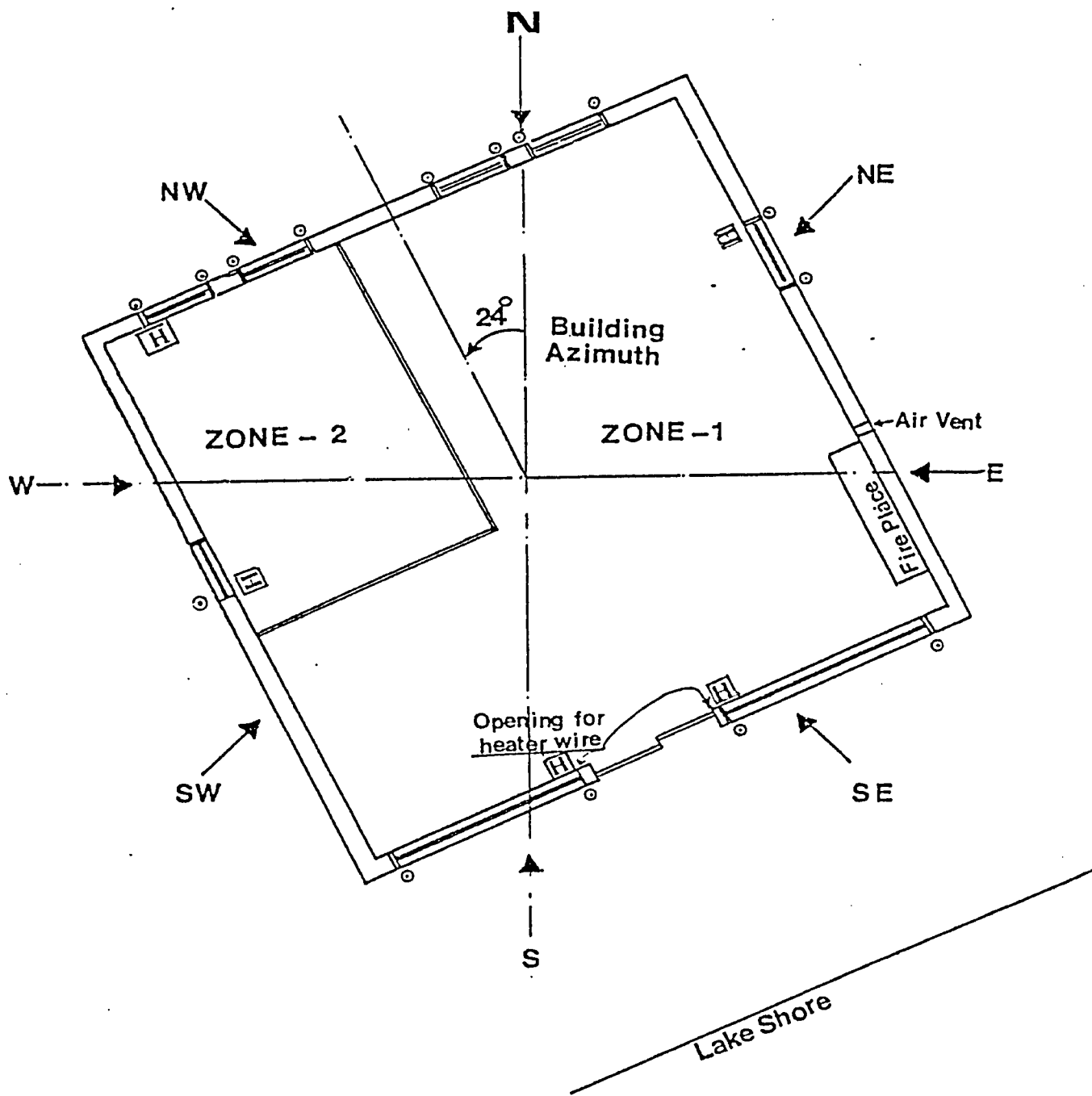

FIGURE 8-1 PLAN VIEW OF UPPER LEVEL SHOWING THE LOCATION OF LEAKAGE OPENINGS

8.2.1 HOURLY ANALYSIS OF RESULTS FOR ZONE-1

The hourly analysis of the measured and simulated results for zone-1 are presented for four weather conditions. The first section involves the discussion of results for two clear sunny days when the wind speed was relatively low. The second section involves the comparison of results for two clear sunny days with higher wind speeds. The third section is for a completely overcast sky with low northerly winds. The last section presents a discussion of results for a clear sunny day with high southerly winds.

8.2.2 HOURLY COMPARISON OF ZONE-1 UNDER A CLEAR SKY AND LOW WIND CONDITIONS

The hourly performance of zone-1, for March 14th, is presented in the following sections. This was a clear sunny day with outdoor temperatures between 34 and 40 degrees F. The wind was low on the average, from the north until noon and then from the west and west by south-west until midnight. Wind driven infiltration effects were not dominant due to low wind velocity directed towards less sensitive exposures of zone-1 during most of the time.

Figure 8.2.A shows an hourly comparison between the measured and predicted performance of zone-1 using the crack length method. A comparison of the baseboard energy consumption indicates that DOE-2 predicted and the measured heat was shut off

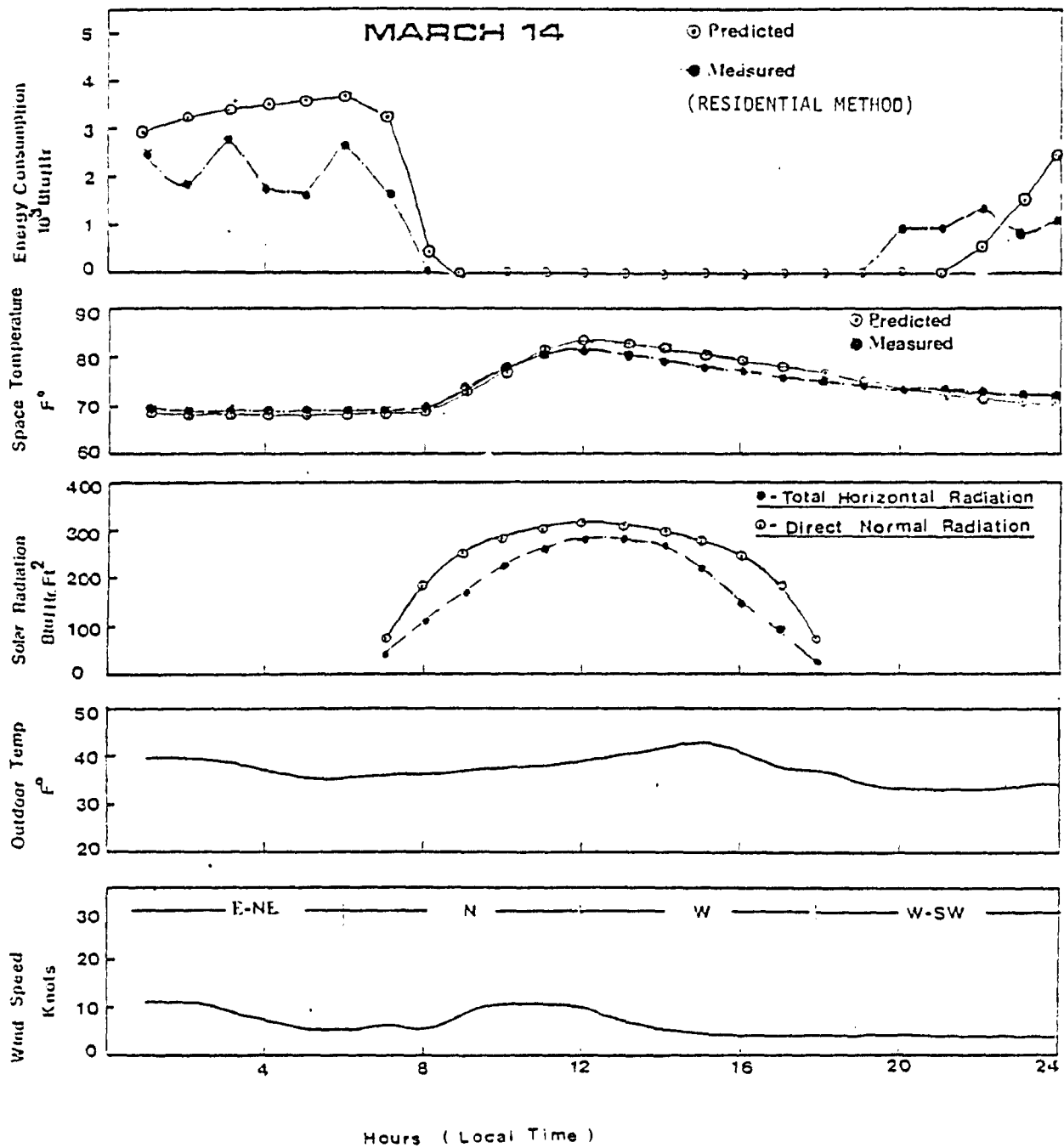

FIGURE 8-2B HOURLY MEASURED AND PREDICTED PERFORMANCE OF ZONE-1 DURING A CLEAR SUNNY DAY WITH LOW WINDS.

at the same time. The output from the baseboard heaters remained zero until hour 19:00, beyond which the measured results showed heat addition from the heater located near the south wall. This heat was added in spite of the fact that the measured temperatures were still above the thermostat set point of 70 degrees F. An examination of the weather data showed that the outdoor temperature had dropped and the wind direction changed to west by south-west. The increase in the indoor-outdoor temperature difference resulted in a small increase in the conduction loss through the southern glazing. It is also possible that the decreasing outdoor temperature would have increased the stack effect causing an air flow through the ventilation grille. Some of this flow could have resulted in leakage around the thermostat of the south wall heater. These two factors seem to have caused an early activation of the south heater.

Since it was a clear sunny day, the measured indoor temperatures rose as high as 81 degrees F and peaked at noon. The predicted temperatures also exhibited a similar trend and rose to 82 degrees F. The two temperatures were in good agreement, although the measured values reached a lower peak than the predicted. This could be caused by lower actual solar gains than those modelled by the program. This is quite possible because the standard values of shading coefficient, selected from Reference (18), could be higher than the actual shading coefficient for the south glazings. The decay rate of the actual

and the predicted temperatures are identical indicating excellent modelling of the thermal mass by the custom weighting factor method.

The predicted performance of zone-1 obtained by the residential infiltration method is compared with the measured performance in Figure B.2.B. The results showed that the predicted heating loads were significantly higher than the actual values during the early morning. Recalling that the residential method does not account for the wind directional effects, it overestimated the infiltration losses which led to increased heating loads. Consequently the baseboard units were turned off one hour later than the actual time. Since DOE-2 predicted heating loads were high, the simulated indoor temperatures rose slowly until hour 10:00 beyond which they exhibited a similar trend as was observed for the crack length method. The predictions also indicate that the simulated energy requirements of zone-1 had drastically increased after hour 22:00. This was because of the fact that the residential method modelled infiltration throughout the day, irrespective of the low winds which does not seem to have caused appreciable infiltration in zone-1 in the actual case. In the DOE-2 simulation a portion of solar energy was utilized during the day to offset these infiltration losses. By the hour 22:00, most of the stored solar energy was used up, hence heat from the baseboard heaters was simulated to meet the conduction and infiltration losses in order to maintain the space at the thermostat set point of 70 degrees F.

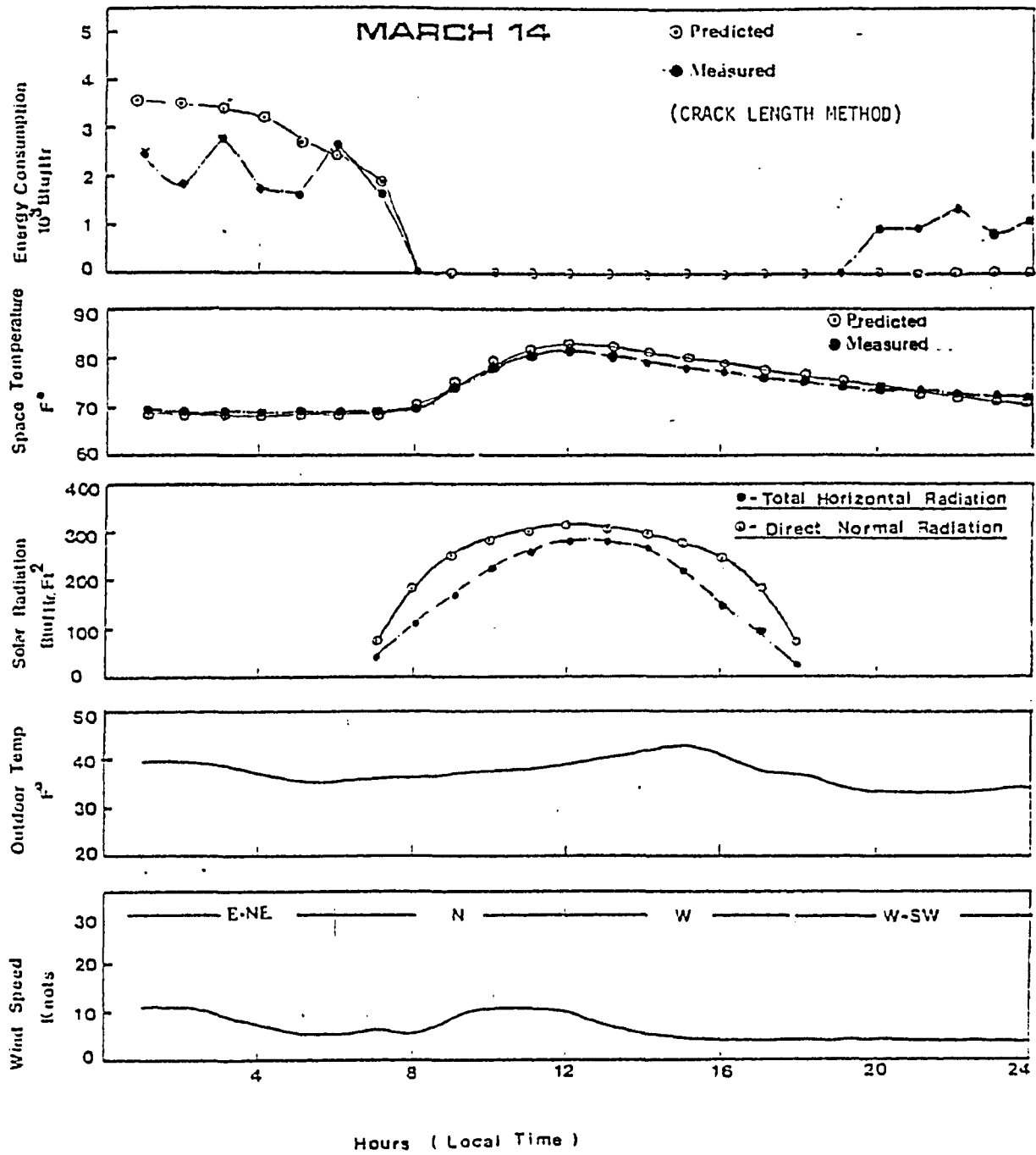

FIGURE 82A . . . CURLY MEASURED AND PREDICTED PERFORMANCE OF ZONE-1 DURING A CLEAR SUNNY DAY WITH LOW WINDS.

Figure 8.2.C presents an hourly comparison between the actual and the predicted performance of zone-1 for March 29th using the crack length method. This was also a clear sunny day with low winds and stable outdoor temperatures.

An hourly comparison between the temperature profiles indicates a close agreement between the two results. The calculated temperatures reached a higher peak than the measured values indicating again that DOE-2 may have overestimated the solar gains. The decay rate of the two temperatures again showed excellent agreement.

A comparison of the baseboard energy consumption showed that DOE-2 overestimated the heating load during most of the early morning hours. However, as the sun came up, the program seemed to have modelled more solar gains. As a result, the predicted heat was shut off one hour earlier than the actual time. The actual and the predicted baseboard output remained zero until hour 17:00. The measured results indicated that the south heater came on at 18:00 hours in spite of the fact that the room temperature was still above the set point of 70 degrees F. A closer examination of the wind speeds indicated that Figure 8.2.C contains additional information. It demonstrates the sensitivity of the south wall heater to the increasing south by south-westerly wind. As can be seen, the output from the heater varied in proportion to the strength of the wind indicating significant air leakage around the thermostat of the south baseboard heater. This air leakage occurred through the

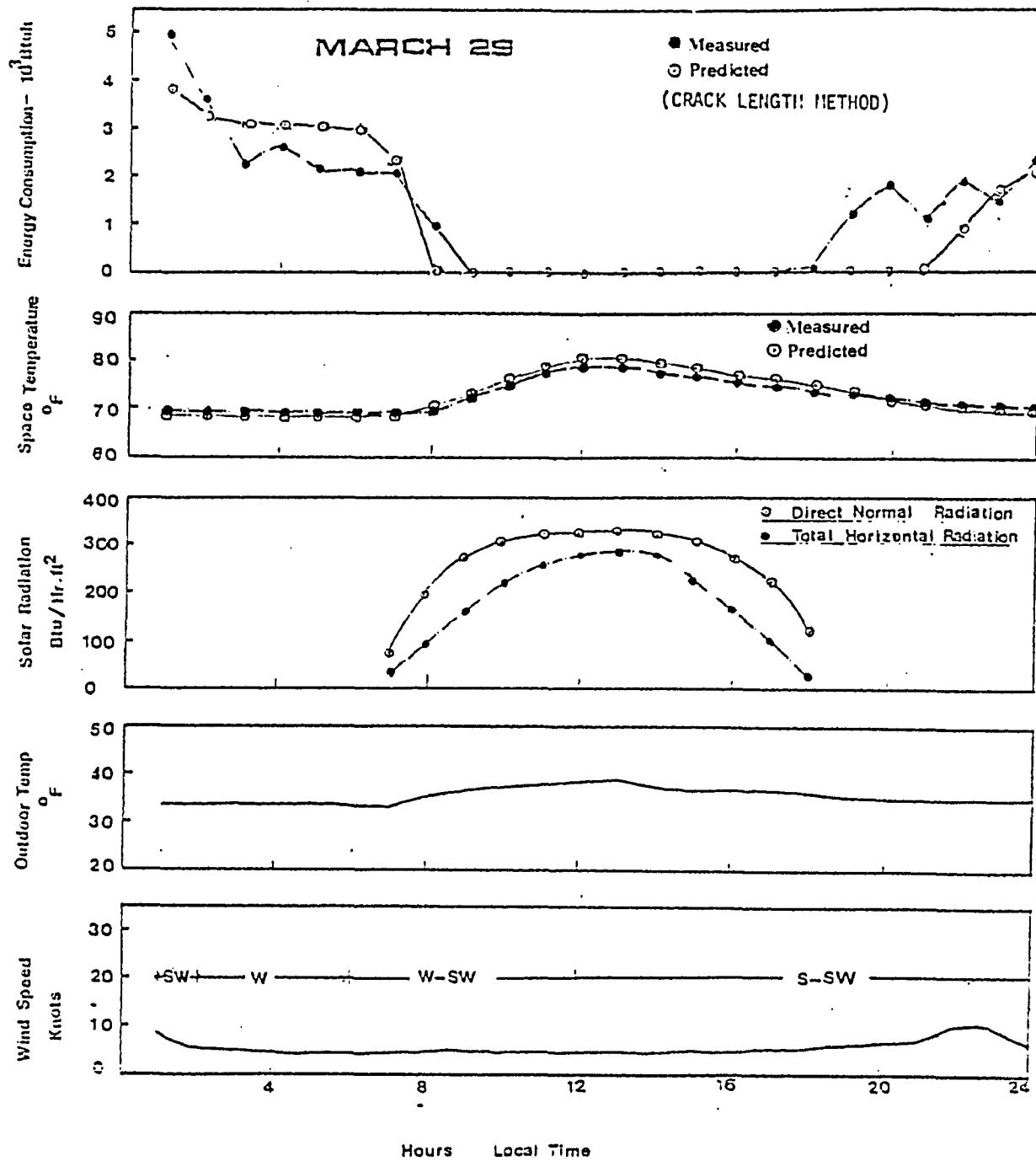

FIGURE 8-2C HOURLY MEASURED AND PREDICTED PERFORMANCE OF ZONE-1 DURING A CLEAR SUNNY DAY WITH LOW WINDS.

outlet penetration for the heater wire.

A similar comparison for March 29th is shown in Figure 8.2.D with the residential method. It can be seen that the heating loads were again overpredicted in the early morning due to overestimation of infiltration by the residential method.

The results presented in the preceding sections contain valuable information and indicate that the dynamics of the model using the custom weighting factor approach are quite accurate to predict the temperature excursions in direct gain passive solar buildings. These results further indicate the merits and demerits of using the crack length and the residential infiltration methods for buildings that have non uniform distribution of leakage area. One obvious disadvantage of the residential method is its inability to account for the directional effects of wind. This led to significant overprediction of the infiltration. In comparison, the heating loads predicted by using the crack length method were in closer agreement with the actual values. It is, however, felt that a closer agreement of the heating loads could be obtained provided enough information were available to accurately specify the leakage characteristics of zone-1. Another source of discrepancy between the actual and predicted heating loads was due to the careless construction of the building envelope. Abnormal leakage around the thermostats caused early activation of the baseboard heaters when space heat was not required in zone-1. This aspect of faulty construction caused frequent disagreement

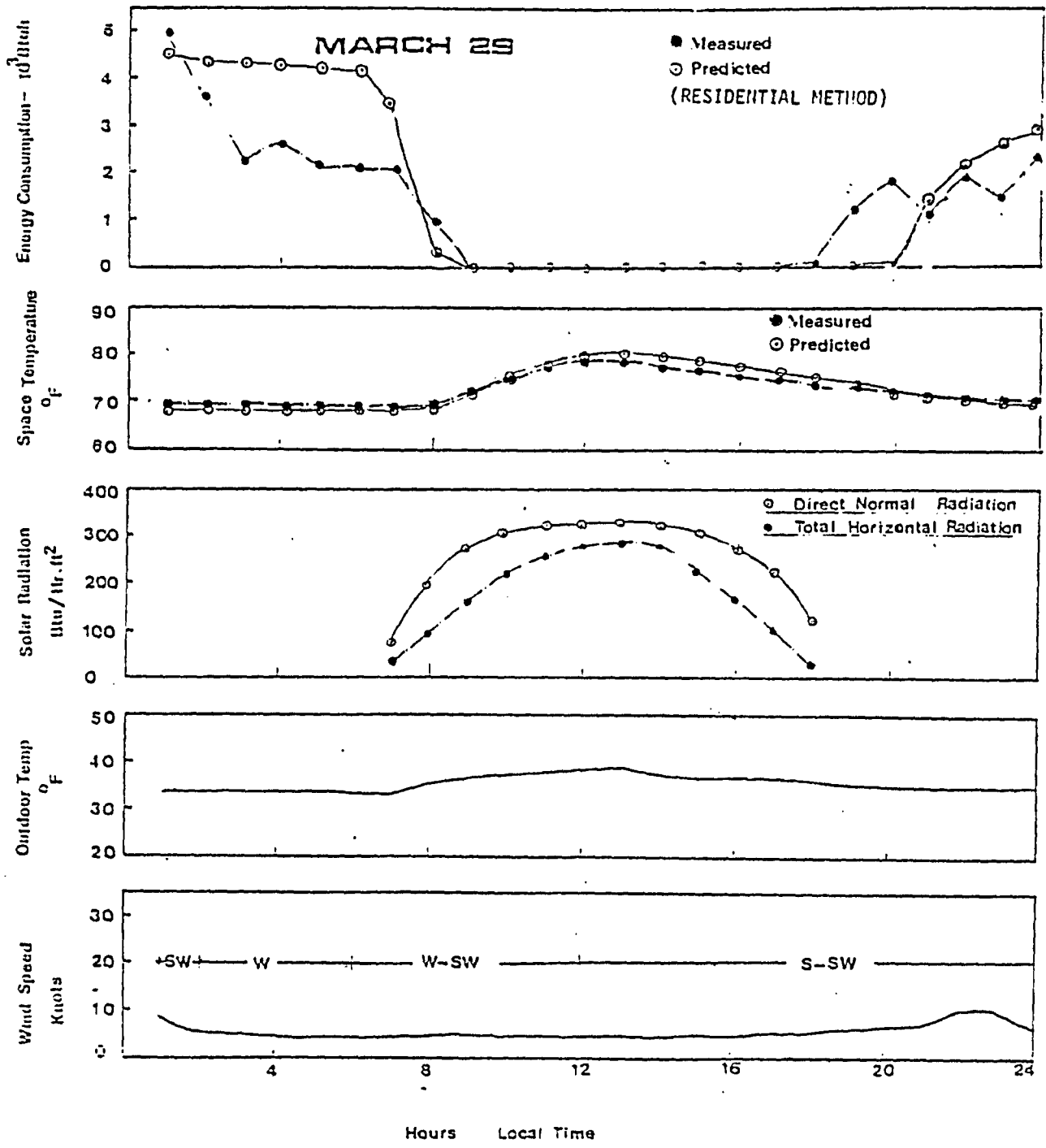

FIGURE 8-2D HOURLY MEASURED AND PREDICTED PERFORMANCE OF ZONE-1 DURING A CLEAR SUNNY DAY WITH LOW WINDS.

Reproduced with permission of the copyright owner. Further reproduction prohibited without permission.

between the predicted and the actual heating loads during the later hour of clear sunny days.

B.2.3 HOURLY COMPARISON OF ZONE-1 UNDER CLEAR SKY AND HIGH NORTHERLY WINDS

The hourly measured and predicted performance of zone-1 on March 13th is shown in Figure 8.3.A . This was also a clear sunny day with outdoor air temperatures around 42 degrees F. The wind on the average was around 15 Knots and was directed from the north-east. The results presented are for the crack length method.

A comparison of the baseboard heater's performance showed that during the first two hours, the measured energy consumption was considerably higher than the predicted values. This was caused by high infiltration through the fireplace opening and shutter strap control and heater wire penetrations present in the east wall. The thermostats of the heaters located in the east and south walls were affected by this high infiltration. Consequently the heaters were required to add more heat. During the later hours, as the wind speed dropped the measured and predicted energy consumption were almost tracking each other and the baseboard heaters were shut off at the same time. Throughout the day the wind speed remained high causing large infiltration losses. However, in both the cases, output from the heaters remained at zero until hour 16:00 due to the availability of large solar gains. After hour 16:00, the solar gain had

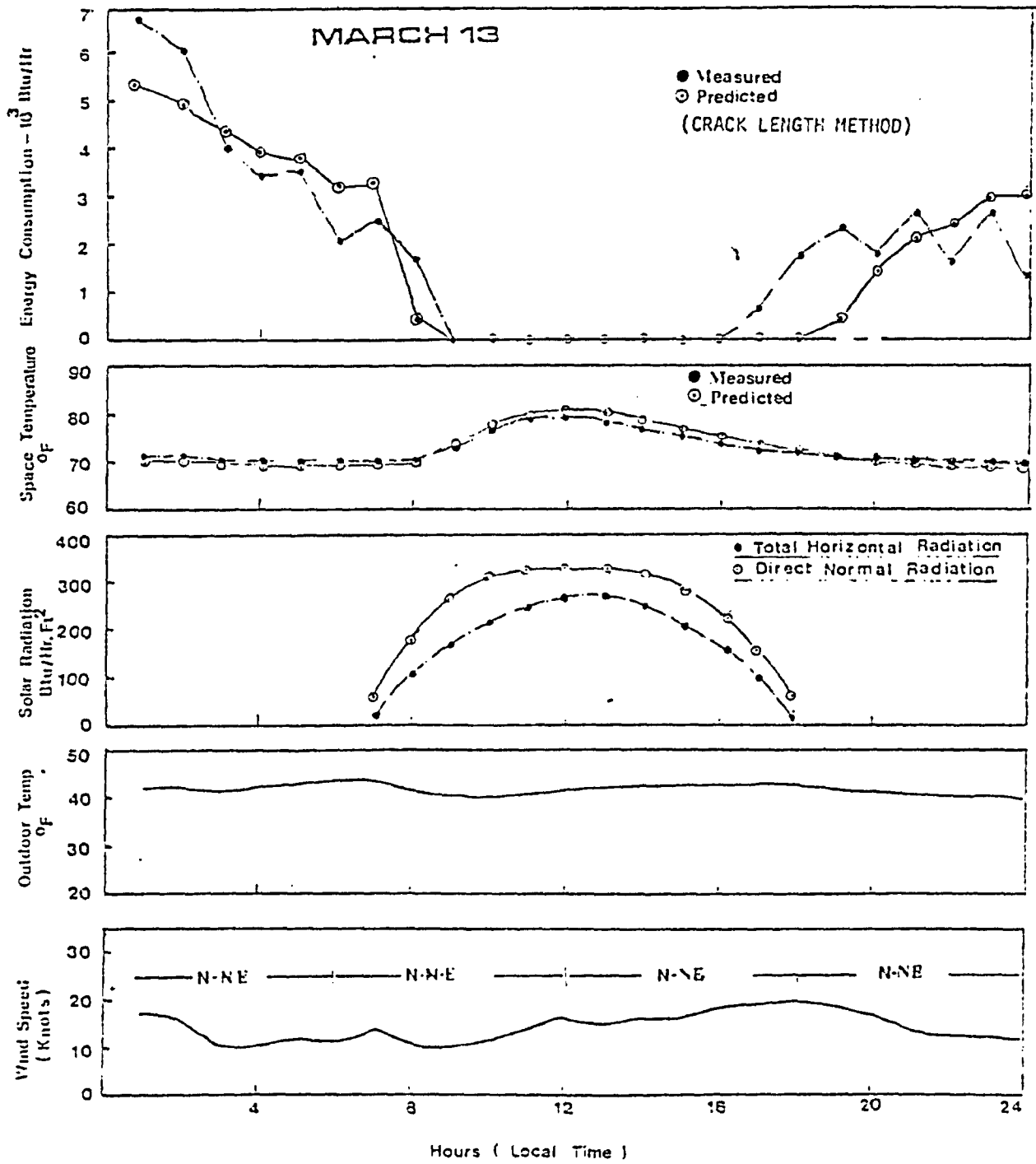

FIGURE 8-7A HOURLY MEASURED AND PREDICTED PERFORMANCE OF ZONE-1 DURING A CLEAR SUNNY DAY WITH HIGH NORTHERLY WINDS.

considerably decreased and the wind speed started to increase. As a result, air leakage around the thermostat affected the output of the baseboard heater located in the east wall. Hence excess heat was added to the space by this heater. It is worthwhile to note that the actual space temperature was still above the set point of 70 degrees F. Similar results were also observed in the preceding section when low southerly winds caused leakage around the heater thermostat. These results indicate that when the heater came on while the room temperature was above 70 degrees F, the conclusion seems to be that cold outdoor air had leaked through the hole around the wire supplying power to the heater. Since the heater thermostat was in the path of this leakage air, the heater control was governed by the temperature of leakage air rather than the room temperature. The results presented in Figure 8.3.A also illustrate that the simulated heating load had started tracking the actual heating load from hour 20:00 onwards. The space temperatures were in good agreement until noon beyond which the decay rate of two temperature was again identical.

Figure 8.3.B shows the measured and the predicted performance of zone-1 on April 1st using the crack length method. This was a clear sunny day with winds rising to 21 Knots at noon and later on decreasing to 4 Knots by midnight. A large swing was observed in the ambient temperature which rose to 55 degrees F until hour 16:00 and dropped to 35 degrees F at midnight.

An excellent agreement was obtained between the actual and

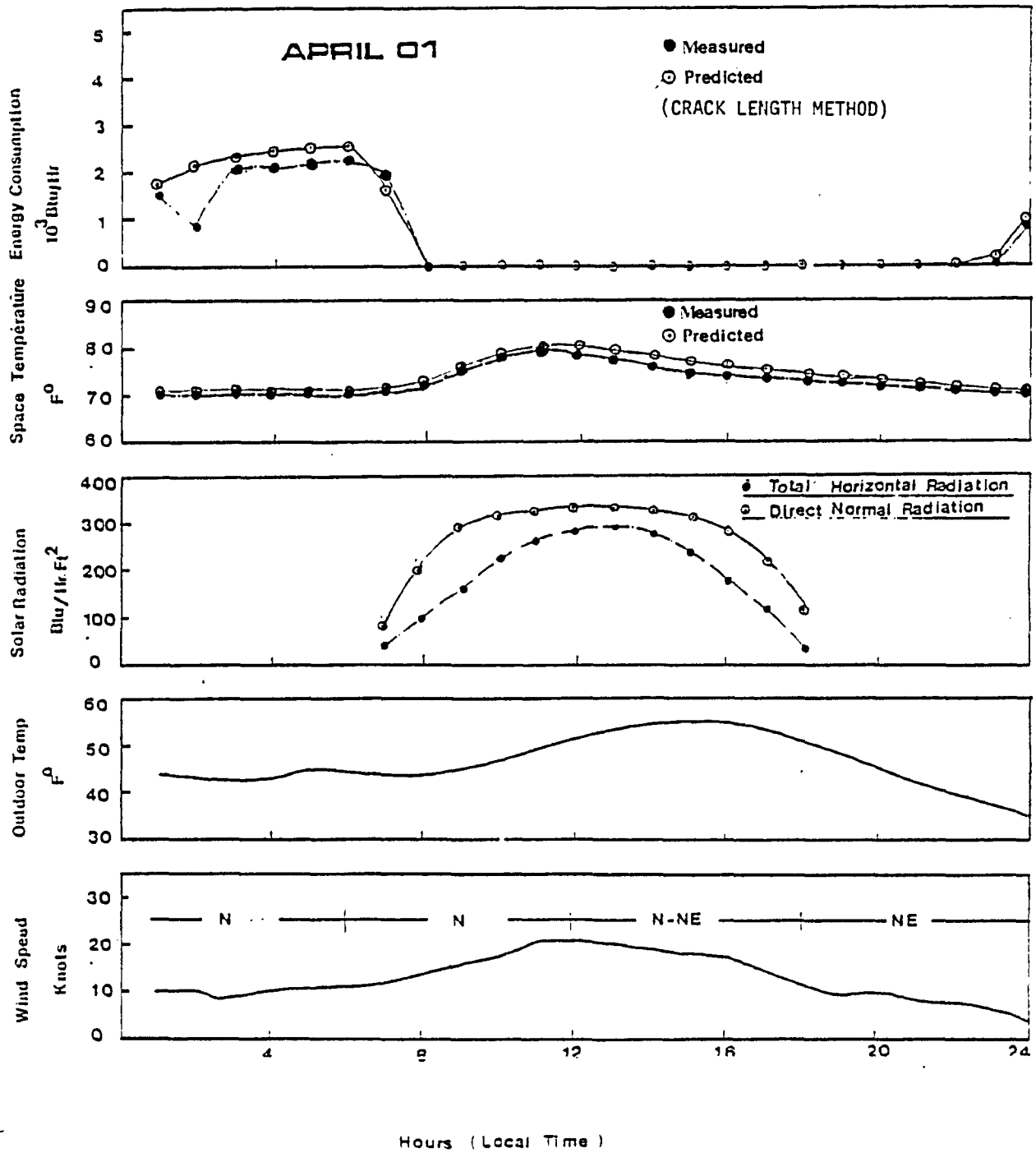

FIGURE 83B HOURLY MEASURED AND PREDICTED PERFORMANCE OF ZONE-1 DURING A CLEAR SUNNY DAY WITH HIGH NORTHERLY WINDS.

predicted off and on times of the baseboard heaters. The predicted heating loads were slightly higher during the early morning but were almost identical by midnight. The indoor temperature profiles showed a similar trend, except that the measured temperatures were lower in the late afternoon by 3 to 4 degrees F. High winds apparently caused a rapid cooling of zone-1 in the actual case.

The results obtained by the residential method, for the same day, are also compared in Figure 8.3 C. This comparison again showed an overestimation of the heating loads during the early morning and by midnight. The temperature profiles were, however, similar to those obtained by the crack length method.

8.2.4 HOURLY COMPARISON OF ZONE-1 DURING A CLOUDY DAY

The hourly measured and the predicted performance of zone-1 is shown in Figure 8.4 for March 25th. The results presented are for both the crack length and the residential infiltration methods. This was a completely overcast day. The winds were low, around 4 Knots, until hour 14:00 and were from the north-east. After 14:00 hours the winds increased to 10 Knots and the direction changed to north by north-east.

The actual and the predicted indoor temperatures were in good agreement at the thermostat set point of 70 degrees F. It was expected that under low wind conditions the DOE-2 heating load predictions would be in close agreement with the measured values. However, the two simulated heating loads showed an

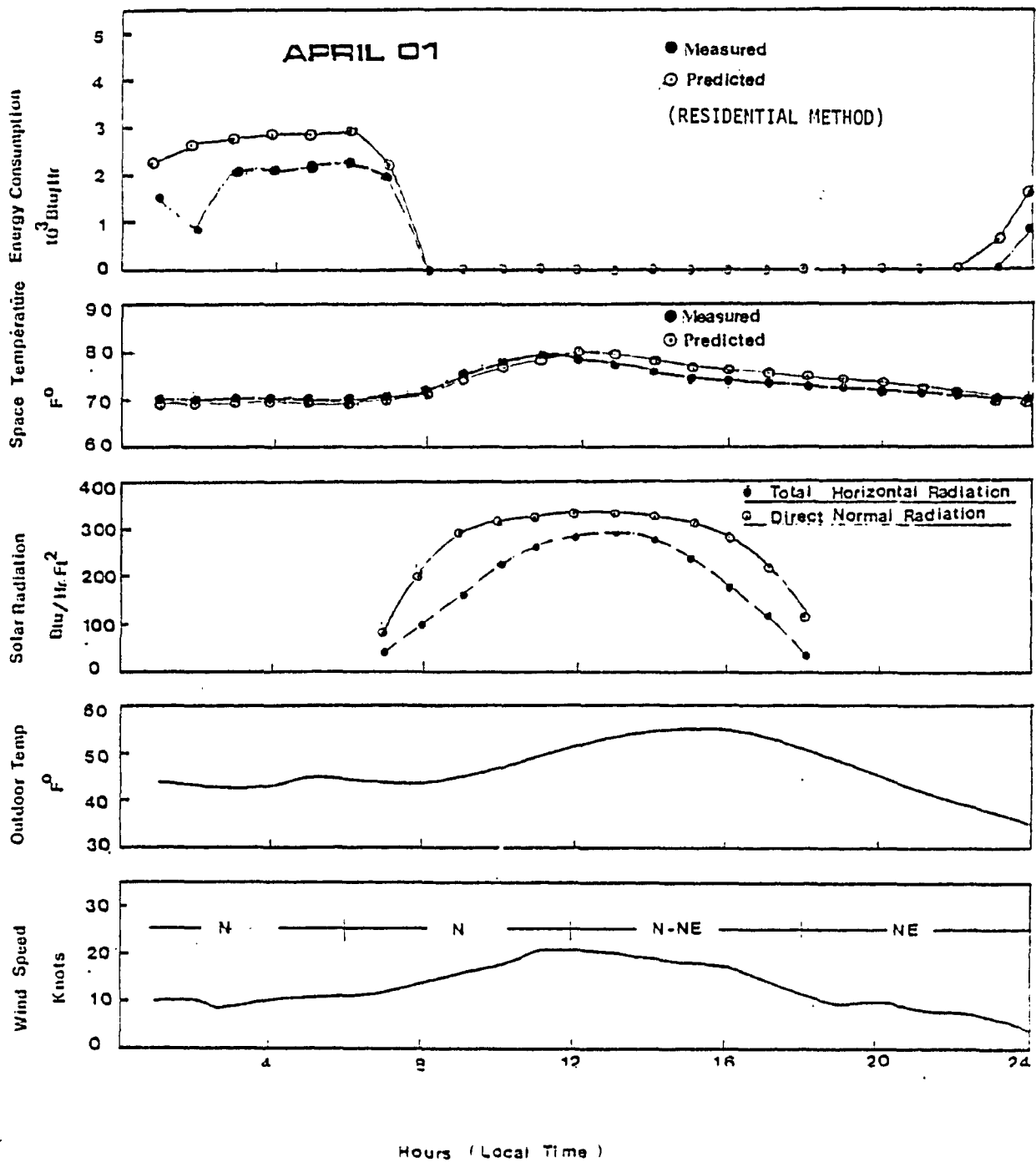

FIGURE 83C HOURLY MEASURED AND PREDICTED PERFORMANCE OF ZONE-1 DURING A CLEAR SUNNY DAY WITH HIGH NORTHERLY WINDS.

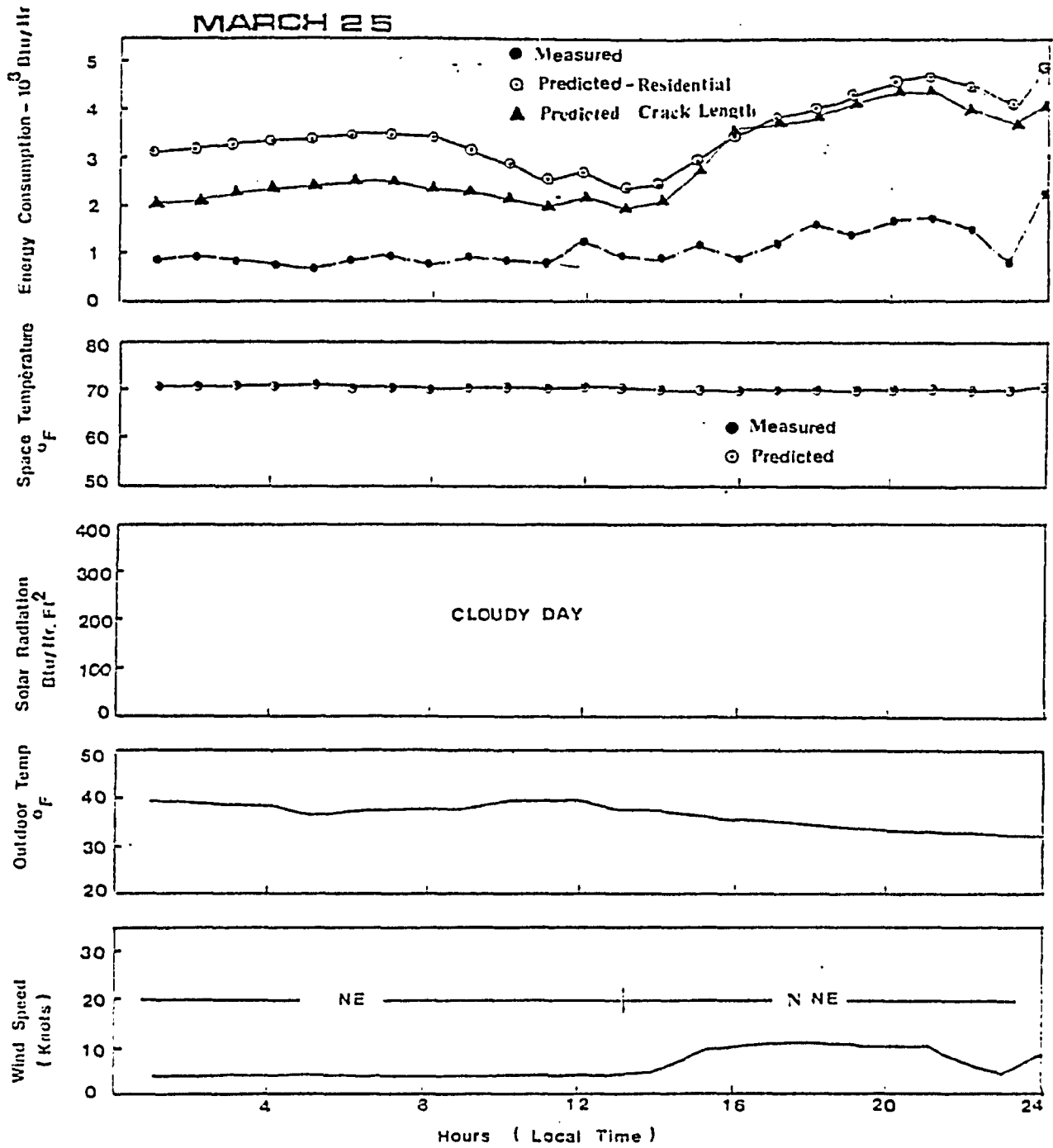

FIGURE 84 HOURLY MEASURED AND PREDICTED PERFORMANCE OF ZONE-1 DURING A CLOUDY DAY WITH LOW WINDS.

opposite trend. The predictions obtained by the residential infiltration method were significantly higher throughout the day. In comparison, the crack length method modelled less infiltration, hence its heating load predictions were lower than those obtained by the residential method until hours 14:00.

In order to determine the possible reason for the lower actual energy requirements of this zone, the measured performance of the baseboard heaters was checked. It was found that the heater located in the east wall remained inactive until 14:00 hours. However, during the later hours, this heater was activated by infiltration through the north and east walls caused by increased winds.

The DOE-2 program cannot model air movement between interconnected spaces that would occur in an actual two storey house due to pressure differences between the interconnected spaces. This possibility could not be ignored for zone-1 as it was connected to the bottom zones through a staircase opening. This opening provided a direct path for heat to flow from the lower zones to zone-1. The energy requirements of zone-1 could be affected by this heat transfer.

During the periods of low northerly winds, the effect of wind driven infiltration would not be significant in zone-3 and zone-4. However, as large leakage areas were discovered in the east and south walls of zone-3, the stack driven infiltration in zone-3 would increase with the increasing indoor-outdoor temperature difference. Consequently, the warm air from zone-3 would rise

into zone-1 through the lower hallway and staircase opening and exfiltrate through the leakage openings in zone-1. During this process heat would be transferred from the lower zones to zone-1.

In order to examine this possibility the measured performance of zone-3 and zone-4 was checked. The measured energy consumption of zone-3 was consistently higher than the energy consumption predicted by using the residential and the crack length infiltration methods. Likewise the actual energy requirements of zone-4 were also frequently higher than the predicted values. The measured temperatures in zone-3 and zone-4 were also 2 degrees F higher than the temperatures in zone-1. The stack and wind driven infiltration in zone-3, obtained by the residential infiltration method, were also compared. This comparison was made to determine the extent of the two infiltration components under the existing outdoor weather conditions. For an average indoor-outdoor temperature difference of 37 degrees F and an average wind speed of 6 knots the stack driven infiltration (0.473 ach) was 2.3 times higher than the wind driven infiltration (0.207 ach). Since the stack effect was predominant, warm air could have risen into zone-1 to meet a portion of its heating requirements. Table 8 presents an energy balance between the lower zones and zone-1 for the same day. It shows that on a daily basis the underpredictions in energy consumption of zone-3 and zone-4 were almost equal to the overprediction in the energy requirements of zone-1. It could be inferred from this observation that excess

TABLE - 8

DAILY COMPARISON OF THE TOTAL MEASURED AND THE
 PREDICTED ENERGY CONSUMPTION OF ZONE-1, ZONE-3 AND ZONE-4
 FOR MARCH 25TH

DESCRIPTION	MEASURED CONSUMPTION KBTU / DAY	PREDICTED CONSUMPTION KBTU / DAY (RESIDENTIAL)	PREDICTED CONSUMPTION KBTU / DAY (CRACK LENGTH)
ZONE-1	25.0	85.0	70.5
ZONE-3	233.0	181.0	188.0
ZONE-4	60.0	54.0	54.0 (Residential)
TOTAL ENERGY CONSUMPTION	318.0	320.0	312.0

heat from the lower zones must have been transferred to zone-1 to offset a major portion of its heating requirements.

8.2.5 HOURLY COMPARISON OF ZONE-1 UNDER HIGH SOUTHERLY WINDS

Since, a large leakage area was discovered in the south-facing side of the house, it was expected that significant disagreement would occur between the measured and the predicted performance during days with high southerly winds. To see the extent of this disagreement, the results shown in Figure 8.5 illustrate the case of a clear sunny day with strong southerly winds.

During the early morning, the predicted energy consumption obtained by the crack length and residential methods was higher than the actual. This situation was usually caused by heat transfer between zones, in this case heat from lower zones moving up into zone-1, and was explained in section 8.2.4. As the wind speed increased, the infiltration losses increased causing a dramatic increase in the measured energy consumption. In spite of the solar gains, the baseboard heaters were required to provide heat throughout the day.

These results clearly illustrate the futility of an energy conservation design such as a passive solar system, if the building envelope is not built with care and an adequate air barrier is not properly installed.

8.2.6 DAILY COMPARISON OF ENERGY CONSUMPTION FOR ZONE-1

It was found in the preceding section that strong southerly

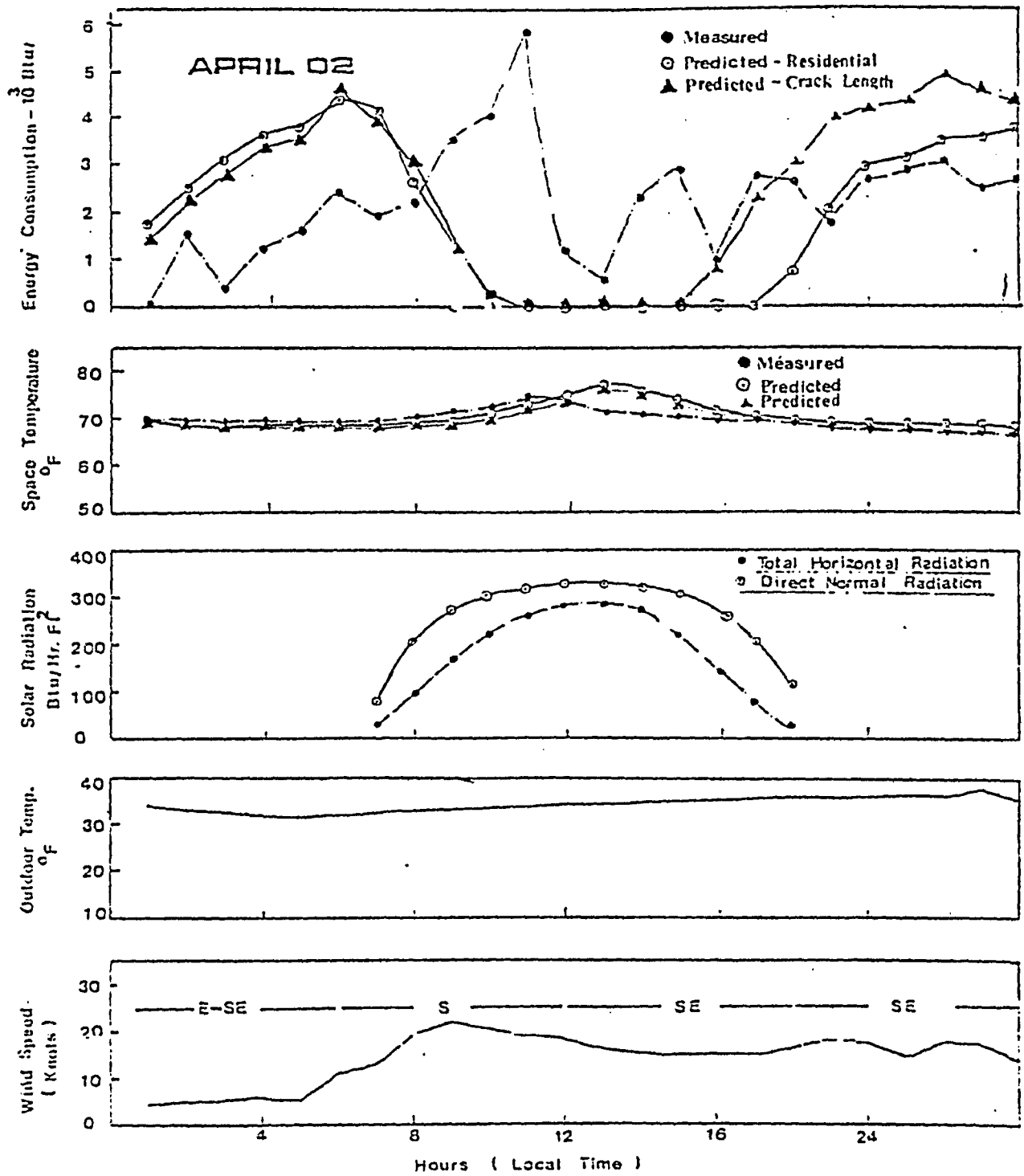

FIGURE 8-5 HOURLY MEASURED AND PREDICTED PERFORMANCE OF ZONE-1 DURING A CLEAR SUNNY DAY WITH HIGH SOUTHERLY WINDS

wind caused excessive infiltration in zone-1, which significantly affected the performance of this space. Both the crack length and the residential infiltration methods in the DOE-2 program were unable to handle such a situation. It was therefore decided to eliminate all test days with strong southerly winds for the purpose of comparing the daily energy consumption with the predicted values.

Figure 8.6 presents an overview of the daily comparison between the measured and predicted energy consumption of zone-1. This comparison is based on both the crack length and the residential infiltration methods. A percentage comparison between the daily measured and predicted energy consumption is also presented in Tables 8.1.A and 8.1.B.

Figure 8.6 indicates that the daily energy predictions obtained by the crack length method are in close agreement with the actual values for most of the test days considered. These days represent the outdoor weather conditions when the winds were low on the average and from a direction which did not significantly effect the output from the baseboard heaters due to outdoor air leakage around their thermostats. On the other hand, the energy predictions obtained by the residential method were significantly higher compared to the actual values. A major reason for the large discrepancy was the wind directional effect which could not be accounted for by the residential method. These comparisons clearly indicate the advantage of using the crack length method for buildings with a non uniform distribution

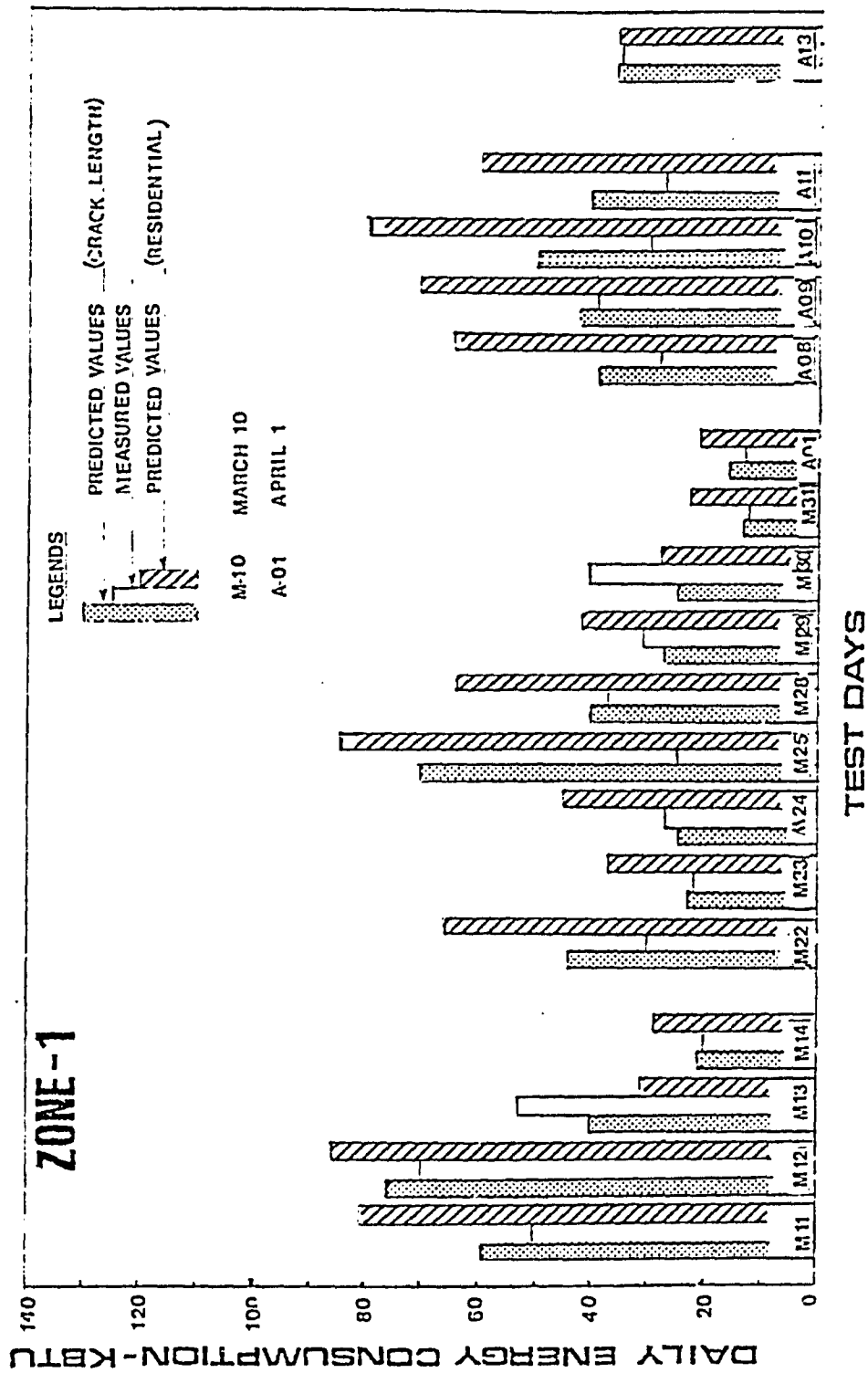

FIGURE 86 COMPARISON BETWEEN THE DAILY MEASURED AND PREDICTED ENERGY CONSUMPTION FOR ZONE 1.

TABLE B.1.A

PERCENTAGE COMPARISON OF THE DAILY MEASURED AND THE PREDICTED
 BASEBOARD ENERGY CONSUMPTION FOR ZONE-1
 (CRACK LENGTH METHOD)

DAY	MERASURED ENERGY CONSUMPTION KBTU / HR	PREDICTED ENERGY CONSUMPTION KBTU / HR	PERCENTAGE UNDER PREDICTION	PERCENTAGE OVER PREDICTION
MARCH - 11	50.00	59.50	-	19.0
MARCH - 12	70.00	76.00	-	8.5
MARCH - 13	53.00	40.00	24.5	-
MARCH - 14	20.00	21.00	-	5.0
MARCH - 22	30.00	43.00	-	43.0
MARCH - 23	22.50	21.50	-	4.4
MARCH - 24	27.00	24.50	9.2	-
MARCH - 25	25.00	70.00	-	180.0
MARCH - 28	37.50	39.00	-	4.0
MARCH - 29	31.00	27.50	9.3	-
MARCH - 30	41.00	25.30	38.0	-
MARCH - 31	13.00	13.50	-	4.0
APRIL - 01	13.00	16.00	-	23.0
APRIL - 08	28.00	38.50	-	36.0
APRIL - 09	39.00	58.00	-	49.0
APRIL - 10	30.00	50.00	-	67.0
APRIL - 11	27.00	40.00	-	48.0
APRIL - 13	35.00	36.00	-	2.8

TABLE 8.1.B

PERCENTAGE COMPARISON OF THE DAILY MEASURED AND THE PREDICTED
BASEBOARD ENERGY CONSUMPTION FOR ZONE-1
(RESIDENTIAL METHOD)

DAY	MERASURED ENERGY CONSUMPTION KBTU / HR	PREDICTED ENERGY CONSUMPTION KBTU / HR	PERCENTAGE UNDER PREDICTION	PERCENTAGE OVER PREDICTION
MARCH - 11	50.00	81.00	-	62.0
MARCH - 12	70.00	86.00	-	23.0
MARCH - 13	53.00	31.00	41.5	-
MARCH - 14	20.00	29.00	-	45.0
MARCH - 22	30.00	66.00	-	120.0
MARCH - 23	22.50	37.00	-	64.0
MARCH - 24	27.00	45.00	-	67.0
MARCH - 25	25.00	85.00	-	240.0
MARCH - 28	37.50	64.00	-	70.6
MARCH - 29	31.00	42.00	-	35.5
MARCH - 30	41.00	28.00	31.7	-
MARCH - 31	13.00	23.00	-	77.0
APRIL - 01	13.00	21.00	-	61.5
APRIL - 08	28.00	65.00	-	132.0
APRIL - 09	39.00	71.00	-	82.0
APRIL - 10	30.00	80.00	-	170.0
APRIL - 11	27.00	60.00	-	122.0
APRIL - 13	35.00	35.5	-	1.4

of leakage openings.

One exception to the preceding comparison was observed for March 13th and March 30th when the measured energy consumption was significantly underpredicted by the two infiltration methods. March 13th represents outdoor weather conditions when the north easterly winds were high causing frequent activation of the baseboard heater located near the east wall. Hence the measured energy requirements were higher than the predicted values. March 30th represents a semicloudy day with low to average (5 to 8 knots) southerly winds. In the absence of enough solar gains, and the outdoor air leakage around the thermostat, the south heater was required to add heat to the space for most of the hours. Since the DOE-2 program does not recognise the location of baseboard heater and outdoor air leakage around their thermostats, its predictions were lower than the actual values.

Under low winds and a large indoor-outdoor temperature difference, the measured results indicate that the stack effect predominated causing infiltration in zone-3 and exfiltration in zone-1. Under these conditions, the heating requirements of zone-1 were supplemented by a heat transfer from the lower zones. Hence the measured energy consumption of zone-1 was less than the predicted values. March 25th represents such a case when the stack effect seem to have predominated for a long time, resulting in a significant overprediction of the measured measured energy consumption by both the crack length and the residential infiltration methods.

A cumulative energy comparison for zone-1, carried over the test days considered, showed that the energy predictions obtained by the crack length method were 18 percent less than the actual values. A similar comparison with the residential method showed that DOE-2 overestimated the measured energy consumption by 60 percent.

8.3.0 ANALYSIS OF ZONE-2

The plan view of zone-2 is shown in Figure 8.1. This zone represented a tighter construction as less air leakage was detected during the fan depressurization test. Abnormal leakage openings in this zone were also identified as penetrations for the shutter control straps and an opening for the heater wire located in the north wall. The directional sensitivity of these leakage openings to strong northerly winds can be readily appreciated. Winds from all other directions will have little effect on the infiltration in this zone. The west wall of zone-2 was tight as it did not contain shutter control straps. There was, however, a penetration in the vapor barrier for the supply wire of a baseboard heater located in the bath ensuite facing west.

8.3.1 HOURLY COMPARISONS OF RESULTS FOR ZONE-2

The following sections are devoted to the hourly analysis of the measured and predicted performance of zone-2. Three test-days were selected for comparison. These days included March 25th,

29th and April 1st, and were considered to be representative of the weather conditions which caused good or poor agreement between the measured and predicted energy consumption. The hourly comparison was based on both the crack length and the residential methods. As zone-2 was not directly connected to the lower zones its energy requirements would not be significantly affected by the possibility of heat transfer from the lower zones.

8.3.2 HOURLY COMPARISON OF ZONE-2 FOR A CLOUDY DAY

The cloudy day performance of zone-2, on March 25th, is shown in Figures 8.7.A and 8.7.B. It can be seen that unlike zone-1, there is no significant overprediction of the hourly energy consumption.

The measured and predicted temperatures were steady at the thermostat set point of 70 degrees F. The measured energy consumption of this zone was low until hours 13:00, but increased in proportion to the wind strength during the later hours indicating increased infiltration. The simulated energy requirements obtained by the crack length method were in excellent agreement with the measured values throughout the day. The energy predictions of the residential method were almost tracking the measured consumption, but indicated slight over and under-prediction in the early morning and late afternoon. This discrepancy was again caused by the inability of the residential infiltration method to account for the directional effects of the wind.

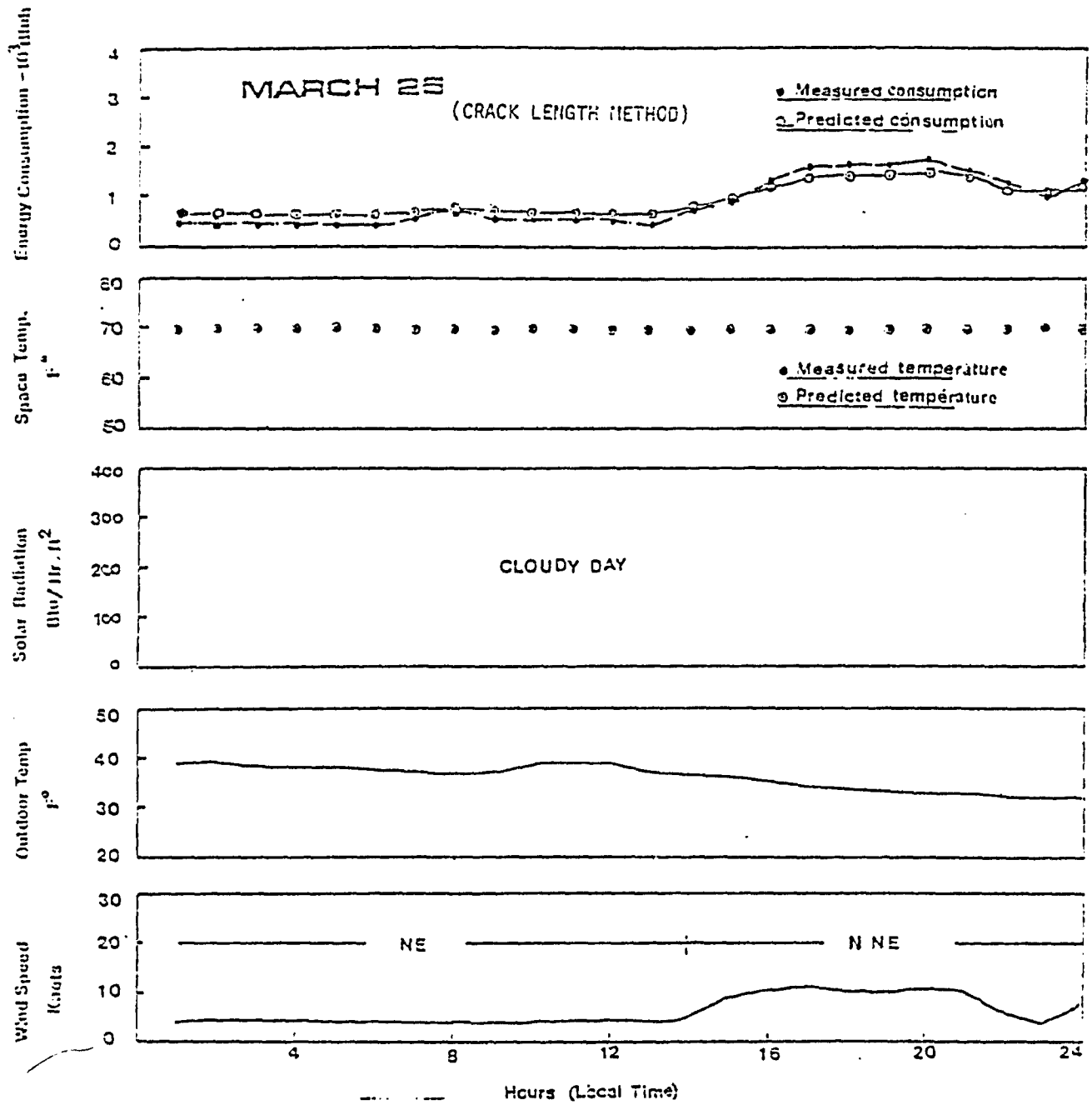

FIGURE 87A HOURLY MEASURED AND PREDICTED PERFORMANCE OF ZONE-2 DURING A CLOUDY DAY WITH LOW WINDS.

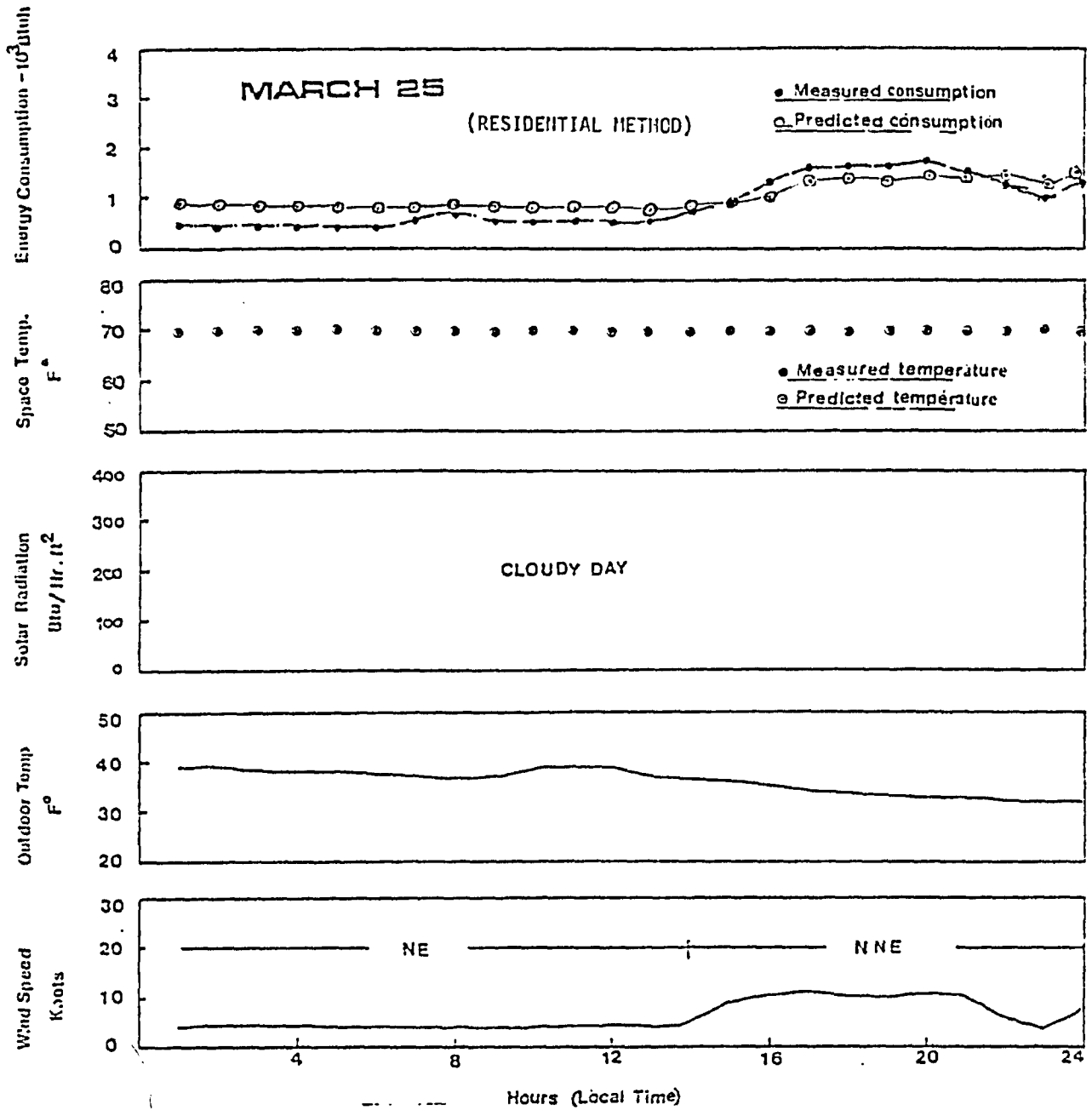

FIGURE 87B HOURLY MEASURED AND PREDICTED PERFORMANCE OF ZONE-2 DURING A CLOUDY DAY WITH LOW WINDS.

B.3.3 HOURLY COMPARISON OF ZONE-2 DURING A CLEAR DAY

The measured and predicted performance of Zone-2, on March 29th, is shown in Figures 8.8.A and 8.8.B. This was a clear sunny day with low winds directed from the south and south-west. As the winds did not directly approach this zone, the infiltration effects were not dominant.

The predicted temperatures were stable at the thermostat setpoint, but the measured temperatures showed overheating of the space. This overheating was caused by large solar gains in zone-1, which also affected the temperatures in zone-2 through an interior door, which was left open during the monitoring period.

The crack length method energy predictions were again in excellent agreement with the measured results. The residential method still overestimated the energy requirement of this zone during the early hours. The two methods, however, predicted zero output from the heater at the same time.

B.3.4 HOURLY COMPARISON OF ZONE-2 UNDER HIGH NORTHERLY WINDS

The hourly performance of zone-2, on April 1st is shown in Figure 8.9. This day was selected to demonstrate the sensitivity of this zone to strong northerly winds.

The measured and predicted energy consumptions were in complete disagreement. The performance of the baseboard heater located near the north wall was significantly affected by strong

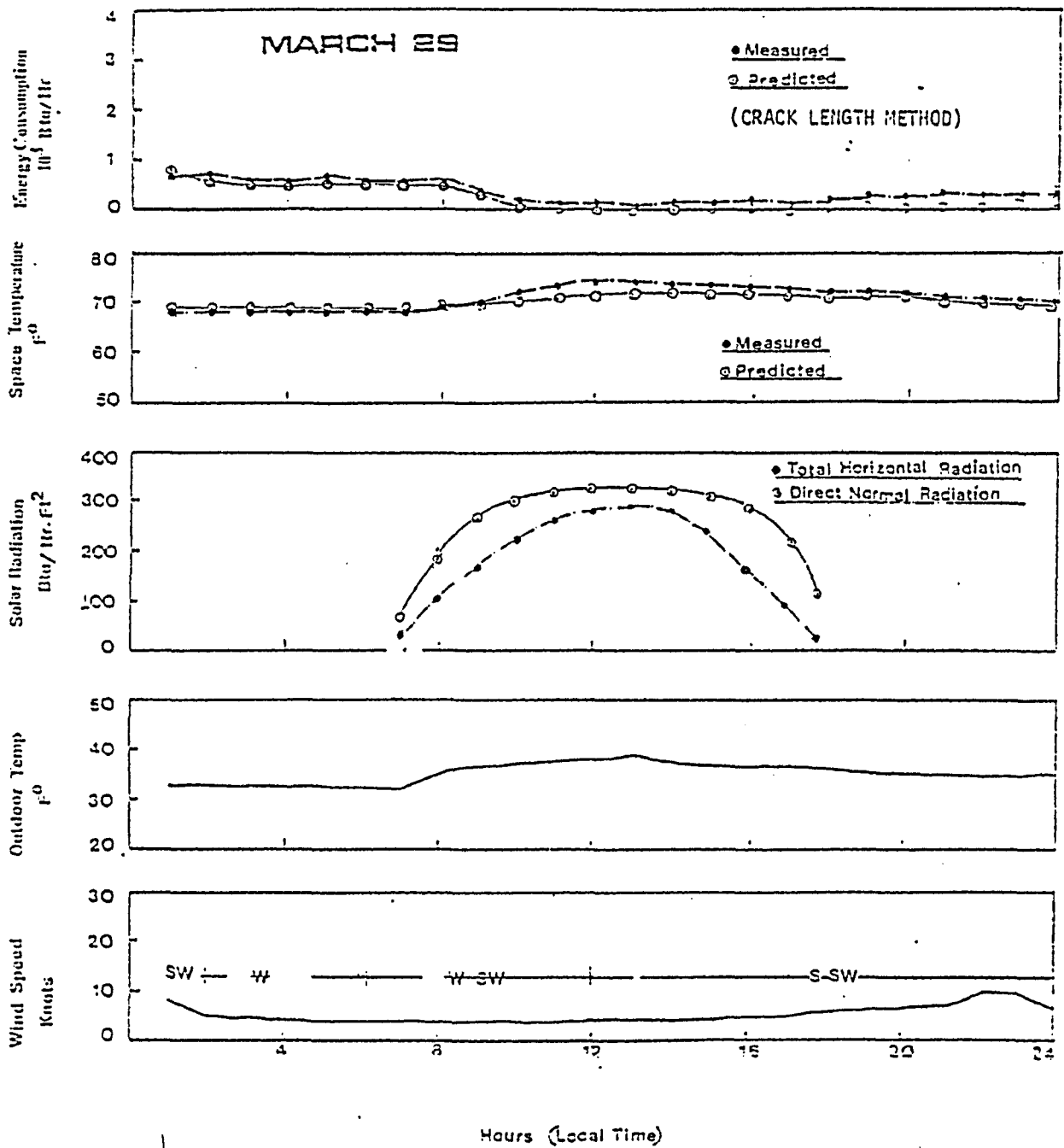

FIGURE 8-8A HOURLY MEASURED AND PREDICTED PERFORMANCE OF ZONE-2 DURING A CLEAR SUNNY DAY WITH LOW WINDS.

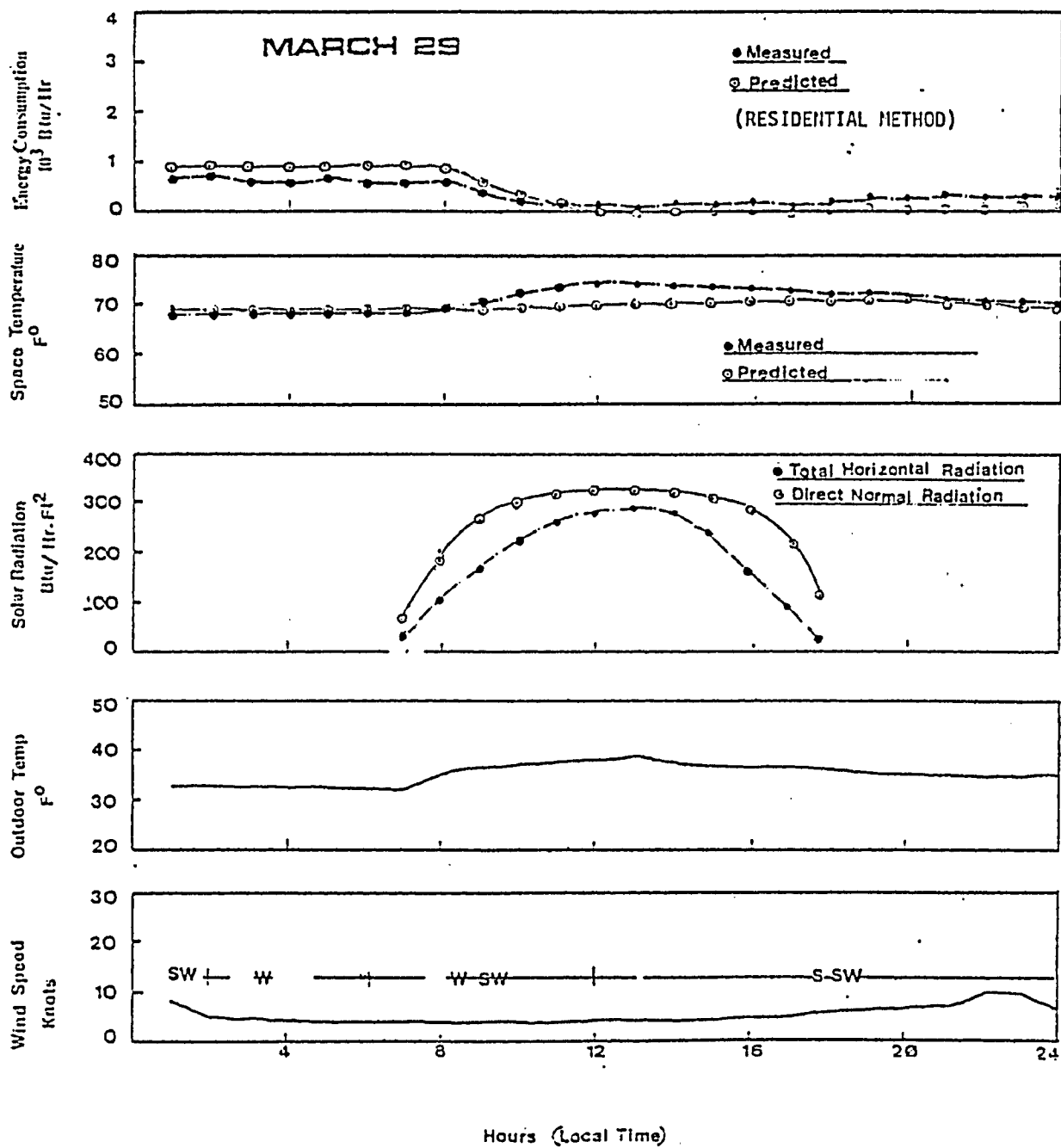

FIGURE 8-8B HOURLY MEASURED AND PREDICTED PERFORMANCE OF ZONE-2 DURING A CLEAR SUNNY DAY WITH LOW WINDS.

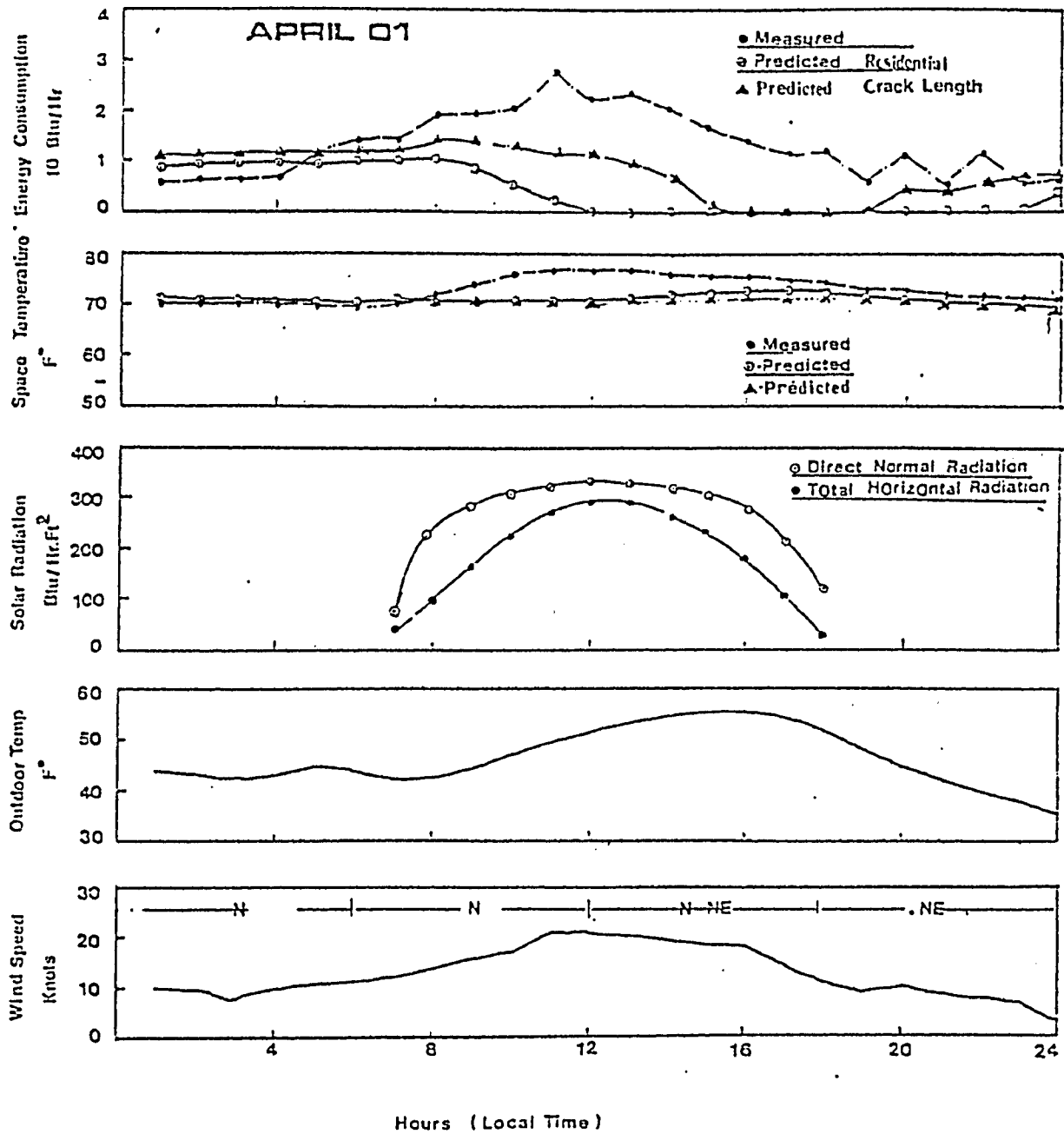

FIGURE 8-9 HOURLY MEASURED AND PREDICTED PERFORMANCE OF ZONE-2 DURING A CLEAR SUNNY DAY WITH HIGH NORTHERLY WINDS

northerly winds. High air leakage around the thermostat caused this heater to add a large amount of heat resulting in an overheating of the space.

The residential method of the DOE-2 program was not capable of modelling this situation. Its heating load predictions were significantly lower than the actual values. The crack length method did model the directional nature of infiltration to a certain extent, but failed to predict effectively the energy consumption for the entire the day.

8.3.5 DAILY ENERGY COMPARISON FOR ZONE-2

In comparison to the other zones of the test house, zone-2 represented a tighter construction. Abnormal leakage openings in the north wall of zone-2 were shown to be extremely sensitive to high northerly wind. However, under calm weather conditions, the wind directional effects were not dominant and the infiltration was not significant.

Figure 8.10 is an overview of the daily measured and the predicted energy requirements of zone-2. It can be seen that for most of the test days, the energy predictions obtained by the crack length and the residential infiltration methods were in close agreement with the measured values. These days represent weather conditions with low winds directed towards the north and west exposure of zone-2. During these days, the output from the baseboard heaters remained steady indicating no sign of an abnormal outdoor air leakage around the heater thermostat. Under

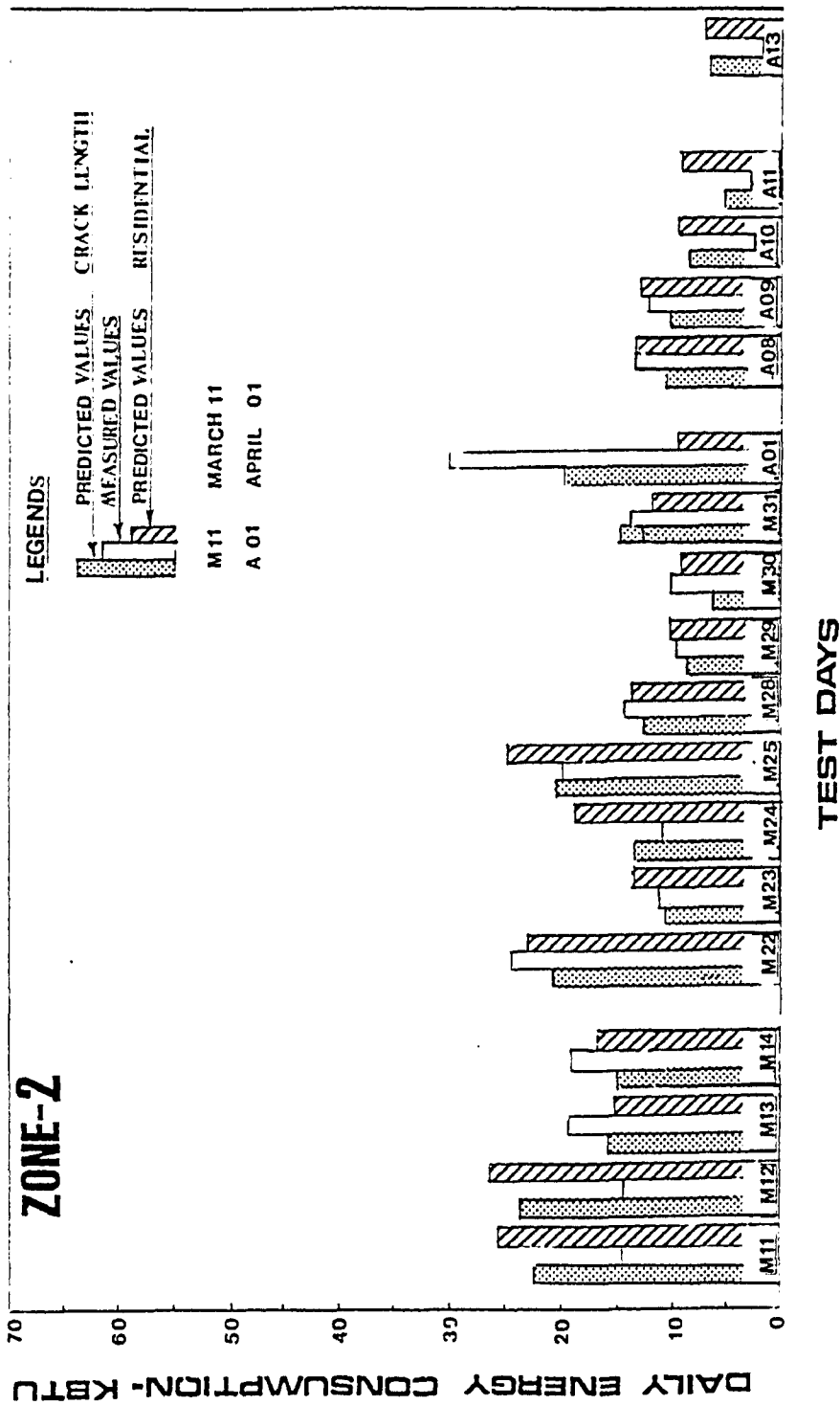

FIGURE 8.10 COMPARISON BETWEEN THE DAILY MEASURED AND PREDICTED ENERGY CONSUMPTION FOR ZONE 2.

these conditions the wind directional effects were not significant, hence the predicted values were close to the actual values.

For some of the days, such as March 11th, March 12th, April 10th, April 11th and April 13th the measured energy consumption was overpredicted by the two infiltration methods. These days generally represent low north-easterly winds which did not directly approach the north wall of zone-2. Hence the infiltration loss was not significant in the actual case. In the case of crack length method, DOE-2 calculated the normal component of north-easterly wind acting on the north wall of zone-2 and estimated infiltration according to the assigned infiltration coefficients. The residential method, however, estimated the infiltration irrespective of the wind direction. The estimated values of infiltration seem to be higher than the actual, therefore, the measured energy requirements were overpredicted.

April 1st represents a test days when the measured energy consumption was significantly underpredicted by the two methods. This day represents outdoor weather conditions with strong northerly winds. Under these conditions, excessive leakage occurred around the heater's thermostat located in the north wall. The output from the baseboard heater was governed by the outdoor air leakage temperature. Hence a large amount of heat was added to the space. Since the program could not model this situation, the actual energy consumption was significantly underpredicted.

A percentage daily comparison between the daily measured and predicted energy consumption of zone-2 is presented in Tables 8.2.A and 8.2.B. An overall comparison indicate that the crack length method over-estimated the total energy requirement of zone-2 by 0.3 percent. The residential method, however, overpredicted the energy requirements by 9 percent.

8.4.0 DAILY ENERGY COMPARISON FOR ZONE-4

The daily total measured energy consumption of zone-4 is compared with the predicted values in Figure 8.11. A percentage comparison between the daily energy consumption is also presented in Table 8.3. Infiltration in zone-4 was modelled by the residential method. The agreement between the measured and predicted energy consumption was dependant upon the extent to which the residential method was able to simulate the actual infiltration in zone-4 under different outdoor weather conditions.

The daily energy comparison reveals that the two results are in close agreement for most of the test days considered. These days represent outdoor weather conditions with low winds (4 to 5 knots). The assigned residential infiltration coefficients were quite capable of simulating the infiltration in zone-4 under these conditions. Some of the days, such as March 13th, March 31st and April 1st, indicate that the measured energy consumption was significantly underpredicted by the DOE-2 program. During these days the northerly winds were average to high (8 to 20 knots) which could have caused high infiltration in zone-4 through the cracks and crevices around the sill plate. It

TABLE 8.2.A

PERCENTAGE COMPARISON OF THE DAILY MEASURED AND THE PREDICTED
BASEBOARD ENERGY CONSUMPTION FOR ZONE-2

(CRACK LENGTH METHOD)

DAY	MEASURED ENERGY CONSUMPTION KBTU / DAY	PREDICTED ENERGY CONSUMPTION KBTU / DAY	PERCENTAGE UNDER PREDICTION	PERCENTAGE OVER PREDICTION
MARCH - 11	14.00	23.00	-	64.0
MARCH - 12	14.00	24.00	-	71.0
MARCH - 13	19.50	15.40	21.0	-
MARCH - 14	19.00	13.50	29.0	-
MARCH - 22	22.50	20.00	11.0	-
MARCH - 23	11.00	10.50	4.5	-
MARCH - 24	10.00	13.00	-	30.0
MARCH - 25	19.50	22.00	-	12.8
MARCH - 28	14.50	10.75	26.0	-
MARCH - 29	9.50	7.80	18.0	-
MARCH - 30	10.00	7.25	25.0	-
MARCH - 31	16.50	16.00	3.0	-
APRIL - 01	32.00	19.00	41.0	-
APRIL - 08	15.00	10.00	50.0	-
APRIL - 09	15.00	14.00	6.7	-
APRIL - 10	1.00	9.00	-	800.0
APRIL - 11	2.50	5.50	-	120.0
APRIL - 13	2.00	7.50	-	180.0

TABLE 8.2.B

PERCENTAGE COMPARISON OF THE DAILY MEASURED AND THE PREDICTED
 BASEBOARD ENERGY CONSUMPTION FOR ZONE-2
 (RESIDENTIAL METHOD)

DAY	MEASURED ENERGY CONSUMPTION KBTU / DAY	PREDICTED ENERGY CONSUMPTION KBTU / DAY	PERCENTAGE UNDER PREDICTION	PERCENTAGE OVER PREDICTION
MARCH - 11	14.00	26.00	-	85.0
MARCH - 12	14.00	27.00	-	93.0
MARCH - 13	19.50	15.00	23.0	-
MARCH - 14	19.00	13.00	31.0	-
MARCH - 22	25.50	23.00	10.0	-
MARCH - 23	11.00	14.00	-	27.0
MARCH - 24	10.00	15.00	-	50.0
MARCH - 25	19.50	27.00	-	38.0
MARCH - 28	14.50	14.00	3.5	-
MARCH - 29	9.50	9.00	5.0	-
MARCH - 30	10.00	8.50	15.0	-
MARCH - 31	16.50	13.00	21.0	-
APRIL - 01	32.00	10.00	68.0	-
APRIL - 08	15.00	15.00	-	-
APRIL - 09	15.00	15.50	-	1.3
APRIL - 10	1.00	10.00	-	900.0
APRIL - 11	2.50	10.00	-	300.0
APRIL - 13	2.00	8.00	-	300.0

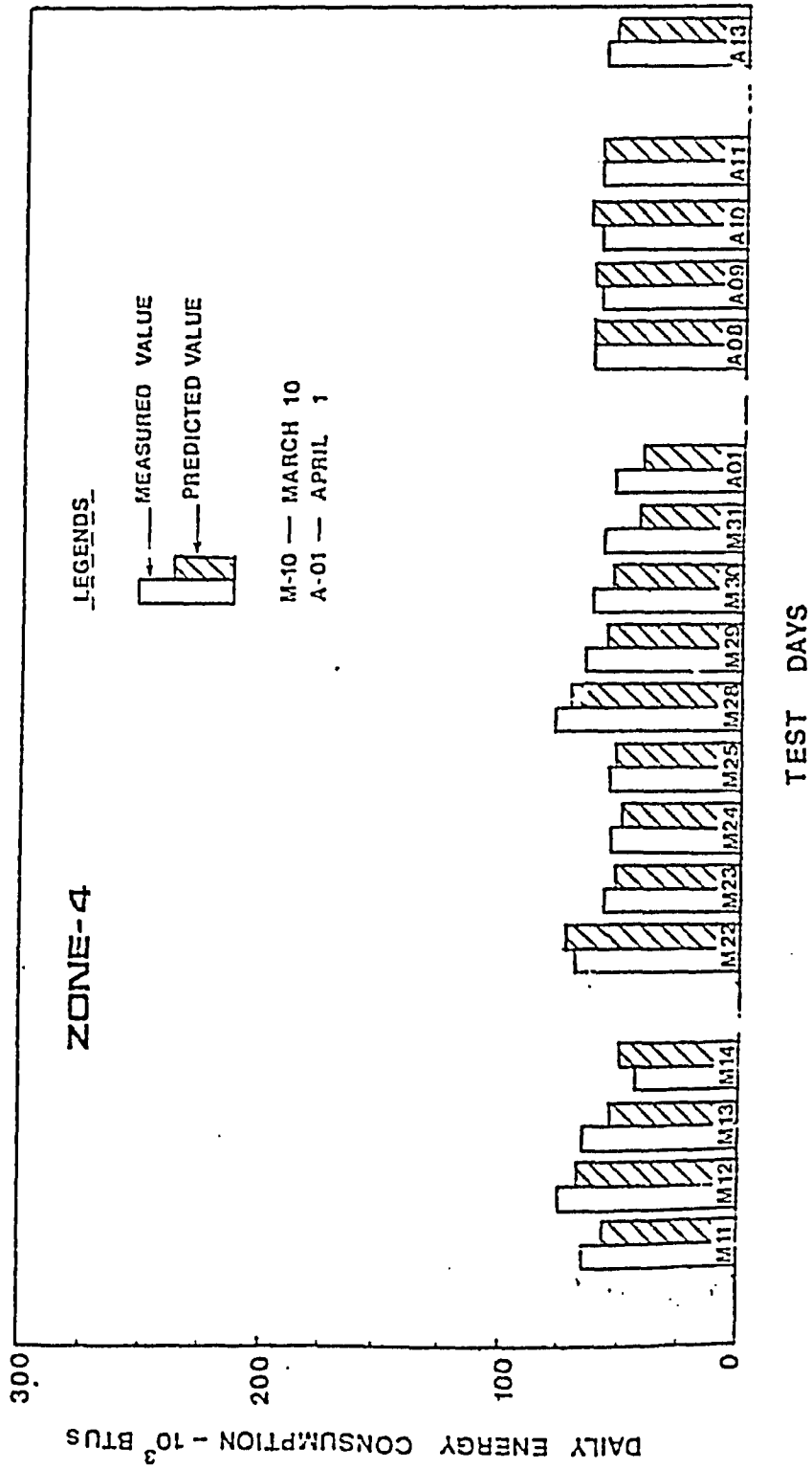

Figure 811 COMPARISON BETWEEN DAILY MEASURED AND PREDICTED ENERGY CONSUMPTION FOR ZONE-4.

TABLE B.3

PERCENTAGE COMPARISON OF THE DAILY MEASURED AND PREDICTED
BASEBOARD ENERGY CONSUMPTION FOR ZONE-4

(RESIDENTIAL METHOD)

DATE	MEASURED ENERGY CONSUMPTION KBTU / DAY	PREDICTED ENERGY CONSUMPTION KBTU / DAY	PERCENTAGE UNDER PREDICTION	PERCENTAGE OVER PREDICTION
MARCH - 11	66.00	54.00	18.0	-
MARCH - 12	76.00	58.00	24.0	-
MARCH - 13	67.00	46.00	31.0	-
MARCH - 14	43.00	46.00	-	6.9
MARCH - 22	69.00	72.00	4.0	-
MARCH - 23	62.00	51.00	18.0	-
MARCH - 24	63.00	50.00	20.0	-
MARCH - 25	60.00	54.00	8.0	-
MARCH - 28	65.00	61.00	6.0	-
MARCH - 29	63.00	52.00	17.5	-
MARCH - 30	59.00	50.00	15.0	-
MARCH - 31	62.00	44.00	29.0	-
APRIL - 01	53.00	42.00	21.0	-
APRIL - 08	62.00	61.00	1.6	-
APRIL - 09	58.00	59.00	-	1.7
APRIL - 10	59.50	64.00	-	7.5
APRIL - 11	57.00	57.00	-	-
APRIL - 13	58.00	54.00	7.0	-

appears that the residential infiltration method did not effectively handle this situation and underestimated the actual infiltration. Consequently, the measured energy requirements were significantly underpredicted.

Infiltration, however, does not seem to be the only reason that could have caused frequent underprediction of the measured energy requirements. Other factors that could be responsible for disagreement in the two results are the conduction heat loss through the underground surface and a possible inter-zone heat transfer between zone-4 and zone-1.

It is known that the DOE-2 program does not have a model to simulate basement heat losses. The user is required to specify these losses according to a method of his own choice. In the present case, the ASHRAE's design procedures were used to estimate heat loss through the underground walls and floors of the test house. These design values were based on an average soil thermal conductivity of $0.8 \text{ Btu.Ft}^2 / \text{Hr. Ft. F}$, and were used to calculate the effective U-values for the subgrade constructions. These effective U-values were specified in the program. In addition, average monthly ground temperatures were obtained from the Detroit TRY weather tape to calculate the ground heat losses in the DOE-2 program.

It is likely that the thermal conductivity of soil surrounding the test house could be higher than the average value used for the design estimates. Moreover, the actual ground temperature for the test location could have been lower than the average

monthly values obtained from the Detroit weather tape. In the actual case these two factors could have resulted in a higher conduction loss through the subgrade surfaces than that modelled in the DOE-2 program.

The measured temperatures of zone-4 were generally found to be elevated by about 2 degrees F compared to the temperatures of zone-1. The difference in the air densities could have also caused a heat transfer from zone-4 to zone-1. Although, the magnitude of this heat transfer does not appear to be significant, it cannot be ignored when accounting for the discrepancies observed in the measured and predicted energy consumption.

In spite of the frequent underprediction of daily energy consumption, the two results were still in close agreement. On an overall basis the measured energy consumption was underpredicted by 11.6 percent.

8.5.0 SUMMARY OF RESULTS

1. During all clear, sunny days, except under strong southerly winds, the program was quite capable of reproducing the measured temperature excursions in zone-1. The program was also capable of simulating the measured hourly performance of baseboard heaters in zone-1. This indicated that the dynamics of the model using the custom weighting factor method are accurate to predict the thermal performance of a direct gain passive solar building.

2. Infiltration in zone-1 and zone-2 was directional in nature. Its magnitude was dependent upon the strength and direction of wind approaching the walls containing the leakage openings. The directional effects were, however, more significant in the case of zone-1 as its south and east walls contained large leakage openings.
3. The residential infiltration method was not suitable to model infiltration in zone-1 because of its limitation to model wind directional effects.
4. The crack length method provided a better estimate of infiltration in zone-1 due to its ability to model wind directional effects. The difficulty associated with the selection of appropriate leakage coefficients was a major limitation for the effective use of this method.
5. Inability of the DOE-2 program to simulate air movement between the interconnected spaces of a multizone building model was also a reason for disagreement between the measured and predicted results.
6. Penetrations in the vapor barrier for the power supply wires caused abnormal leakage around the thermostats of baseboard heaters located in the south and east walls of zone-1. The output from these heaters was governed by the outdoor leakage air temperature rather than the room air temperature. Consequently, excess heat was added to zone-1 which was also a

reason for the disagreement between the hourly measured and predicted energy requirements for this zone.

7. Zone-2 was a relatively tight construction. Abnormal leakage openings were sensitive to strong northerly winds only. Under low wind conditions the infiltration effects were not dominant and the energy requirements predicted by the residential and crack length methods were almost identical and in close agreement with the actual values. Outdoor air leakage around the thermostat was also a reason for the underprediction of energy requirements of this space under high northerly winds.
8. The daily measured and predicted energy requirements of zone-4 were in close agreement. Slight underprediction of the measured energy consumption most likely occurred due to a high conduction loss through the underground surfaces and the possible heat transfer to zone-1.

CHAPTER IX
CONCLUSIONS AND RECOMMENDATIONS

CONCLUSIONS

1. A computerized data acquisition system, along with a weather station and related energy monitoring instruments, has been set up to facilitate the experimental monitoring of single family residences. This system was successfully used in the early spring of 1982 to measure, process and store weather and indoor performance data of a test house located in Wheatley, Ontario.

2. Careful plans and high levels of energy conservation measures can be completely destroyed by sloppy workmanship, particularly in the final stages of construction.
 - a. Due to several penetrations in the vapor barrier (air barrier) of the building envelope and careless destruction of a seal, which separated the ventilated joists of the lower southern overhang from the Trombe wall air space, the air leakage of this house was found to be comparable to pre 1945 constructions.

 - b. The Trombe wall was rendered totally ineffective by large openings to the outdoors on the south - facing side of the test house. These openings also ruled out any accurate modelling of zone-3 by computer simulation.

 - c. Infiltration in the test house was found to be very

directional in nature and was mainly sensitive to strong southerly and easterly winds. This was due to the large leakage openings concentrated on the southern and eastern exposure of the building.

3. Since the south walls of the test house contained a large leakage area, an accurate simulation of the test house could not be obtained during the test days with strong southerly winds which caused abnormally high infiltration in zone-1 and zone-3. However, for all other clear sunny days, the hourly comparisons for zone-1 indicated that the DOE-2 program was quite capable of simulating the measured temperature excursions and the performance of baseboard heaters. This indicated that the dynamics of the custom weighting factor method of the DOE-2 program are quite accurate to predict the performance of direct gain passive solar buildings.
4. The residential infiltration model in the DOE-2 program is suitable for a single zone building model in which the leakage areas are uniformly distributed in the building envelope. In most cases, passive solar houses should be simulated as multizone models. The results of this comparative study indicate that the residential infiltration model was not suitable for the test house. The simulated results were made inaccurate by the directional nature of the leakage areas.
5. The " Crack Length " infiltration model in the DOE-2 program

is suitable for multizone building models where the wind direction must be taken into account. It was shown that this model gave results which were more nearly in agreement with the measured values. The " Crack Length " method, however, does require considerable experience to properly select crack lengths and leakage coefficients. The possibility of using wrong values may seriously affect the overall results and nullify the other advantages of this model.

6. A cumulative comparison between the measured and predicted energy consumptions of zone-1, zone-2 and zone-4 showed that:
 - a. The predicted total energy consumption of zone-1, obtained by the crack length and the residential infiltration methods, over-estimated the actual consumption by 18 and 60 percent, respectively.
 - b. The crack length method overpredicted the total measured energy requirements of zone-2 by 0.3 percent. The residential method, however, overpredicted the energy requirements by 9 percent.
 - c. The total measured energy consumption of zone-4 was underpredicted by 11.6 percent.

RECOMMENDATIONS

1. In order to avoid the loss of valuable experimental data in future energy monitoring projects, it is recommended that the data acquisition system be modified by adding a battery backup

unit which could instantly take over the system in the case of a local power failure.

2. In order to provide a reliable validation of an hour - by - hour simulation program such as DOE-2.1A it is recognized that an hour - by - hour monitoring is required. It is recommended that a typical single family residence located in an urban area should be used for such a validation project. The house should be of a type that could be modelled as a single zone.
3. In order to minimize possible errors due to incorrect modelling of infiltration, it is recommended that tracer gas tests be carried out to determine the natural infiltration rates of the validation house.
4. The " Crack Length " infiltration model is required when buildings are modelled as different zones. Additional guidance is required to assist in the selection and location of crack lengths and leakage coefficients.
5. The hourly heating load of a building varies gradually due to the thermal response characteristics of the building envelope. However, due to characteristics of heating equipment, hourly heat addition to space is quite erratic. In the present study, hourly heat addition rates of the electric baseboard heaters were directly compared with the simulated values. It is, however, recommended that in future validation projects, high frequency components of actual hourly heat addition rates

be smoothed out by using an appropriate filtering technique. This would allow a more reasonable comparison between the hourly measured and simulated values of space heat addition rates.

CHAPTER X

REFERENCES

1. Harrje, D. T., and Grot, A. R., " Instrumentation for Monitoring Energy Usage in Buildings At the Twin River ", Energy and Buildings, Vol- 2, (April 1978).
2. Jones, C. D, McBride, M., Blancett, R. S., and Sepsy, C. F, " Data Acquisition and Instrumentation for Energy Studies of Remote Sites ", ASHRAE Transactions, Part - 1 , (1979).
3. Robertz, W., Rpbertz, R., Nall, D., and Greenberg, D., " Comparison of Computer Predicted Thermal Loads with Measured Data from Three Occupied Town Houses ", ASHRAE Transactions, Part - 1, (1978).
4. Rogers, R. J., An Interactive Graphic input System for Building Energy Analysis, Thesis, Program of Computer Graphics, Cornell University, Ithaca, New York, June 1979.
5. Mitchel, J. W., Beckman, W. A., and Pavelski M. J., " Comparing Measured and Simulated Performance of a Solar House ", Engineering Digest, (November / December, 1980).
6. " TRNSYS, A Transient Simulation Program ," Report 38, Solar Energy Lab., University of Wisconsin, Madison, WI, February 1978.
7. Noe, F. A., and Northrup, D., " Field Validation of Thermal Performance of a Passively Heated Building as Simulated by the DEROB System ", Energy and Buildings, Vol - 2,

(January, 1979).

8. Arumi, F.N., The Multispace Thermal Coupling Algorithms of DEROB Systems; Heat Transfer in Energy Conservation, ASME, (1978).
9. Kasuda, T., Pierce, E. T., and Bean, J. W., " Comparison of Hourly Calculated Cooling Load and Attic Temperature with Measured Data for Houston Test House ," ASHRAE Transaction, Part - 1, (1981).
10. Kasuda, T., NBLSD, The Computer Program for Heating and Cooling Loads in Buildings, NBS Building Science Series # 69, U.S Department of Commerce, Washington D.C., (1976).
11. Hittle, C.D., " The Building Load Analysis System Thermodynamics (BLAST) Program's User Manual" CER-TR-E-153, June - 1979.
12. Kerrisk, F. J., Schnurr, N. M., Moore, J. N., and Hunn, B. D., " The Custom Weighting Factor Method For Thermal Load Calculations in the DOE-2 Computer Program ", ASHRAE Transactions, Part-2, (1981).
13. Kerrisk, J. F., Schnurr, N. M., Moore, J. B., and Hunn, B. E., " Passive Solar Design Calculations with the DOE-2.1 Computer Program, " Proceedings of the 5th National Passive Solar Conference, Amherst, Massachusetts, October 19-26 (1980) .

14. Hall, J. D., " A Retrofit Strategy for Two Canadian Residential Dwellings using DOE-2.1A Building Energy Analysis Program," Master's Thesis, Department of Mechanical Engineering, University of Windsor, (1983).
15. " Builder's Guide to Energy Efficiency in New Housing ", Toronto, Housing and Urban Development Association of Canada, (1980).
16. " A Feasibility and Design Study to Assess Methods of Residential Passive Solar Energy Collection and Utilization," Energy Mines and Resources , Canada, Report ER 81-1E, (January - 1981).
17. Goldstein, D. B., Levine M. D., and Mass, J., " Methodology and Assumptions for the Evaluation of Building Energy Performance Standards for Residences ", Lawrence Berkeley Laboratory, PNL - 3044, (1979).
18. American Society of Heating Refrigerating and Air Conditioning Engineers, " Handbook of Fundamentals ", (1977).
19. E. Mazria, " The Passive Solar Energy Book ".
20. Window Roll Shutter Company Inc., 3153 Walker Road, Windsor, Ont, NBW3R6.
21. Konrad, A., " Description of the ENCORE-CANADA Building Energy Simulation Program ", Division of Buildings Research,

National Research Council, Ottawa, (August, 1978).

22. Reference Manuals, " DOE-2.1A Building Energy Simulation Program, Version 2.1 ", Group WX - 4, Los Alamos Scientific Laboratory, New Mexico, (May - 1980).
23. Kimura, K., and Stephenson, D. G., " Solar Radiation on Cloudy Days," Paper Presented at ASHRAE Semi Annual Meeting, Chicago, Illinois, (January 27 - 30, 1969).
24. " Procedures For Determining Heating and Cooling Loads For Computerizing Energy Calculations, " The ASHRAE Task Group on Energy Requirements for Heating and Cooling of Buildings, (February - 1975).
25. George, E. Forsythe., Michael, A. Malcolm., and Cleve, B.Moler., " Computer Methods for Mathematical Computations " PRENTICE-HALL, Inc., Englewood Cliff, New Jersey 07632.
26. Ener - Corp Management Ltd, Ottawa, " EnerSeal Operation Manual ".
27. Conservation Concepts: " The Importance of Knowing What Goes Where ", Ontario Hydro, (1981).
28. Sherman, M. H., and Grimsrud, D. T., " Measurement of Infiltration Using Fan Pressurization and Weather Data, " Paper Presented at the First Symposium of the Air Infiltration Center, Windsor, England, (October - 1980).
29. American Society of Heating Refrigerating and Air

Conditioning Engineers, " Handbook of Fundamentals " ,
(1981).

30. Operations and BASIC Language Reference Manual, TRS-80 Model III, Radio Shack Microcomputer: Radio Shack, A Division of Tandy Corporation, Barrie, Ont, Canada.
31. Instruction Manual Fluke Model 2240C Data Logger, John Fluke Mfg Co., Inc., Mount Lake Terrace, Washington - 98043.
32. Louis lee, C. W., " Hourly Weather Data Logging, " A final year project, Mechanical Engineering Department, University of Windsor, 1982.
33. Ganesh, R., " Residential Energy Modelling and Simulation ", A Master's thesis under preparation, Mechanical Engineering Department, University of Windsor.
34. Sherman, M. H., Grimrud, D. T., and Sonderegger, R. C., " The Low Pressure Leakage Function of a Building ", Proceedings of the ASHRAE/DOE-ORNL Conference, December 3-5, 1979, Orlando Hyatt Hotel, Kissimmee, Florida.

APPENDIX - A
DESIGN HEATING LOAD CALCULATIONS

DESIGN HEATING LOAD CALCULATIONS

The design heating load may be defined as the maximum possible heat loss from a building that would occur for a set of selected indoor air temperatures and design outdoor weather conditions. It is mainly composed of the following components:

1. Transmission losses, that occur through the solid boundaries of the building due to an indoor - outdoor temperature difference.
2. Infiltration losses, that occur due to the leakage of cold air through the cracks and crevices located around the building envelope.

In the 1977 Handbook of Fundamentals (18), the American Society of Heating, Refrigerating and Air-Conditioning Engineers has recommended procedures that can be used to estimate the transmission and infiltration losses through a building envelope. These procedures are accepted to be reasonably good for design calculations and are generally used to size the heating systems for a building.

A.1 DESIGN CALCULATIONS FOR THE TEST HOUSE

The ASHRAE procedures were used to estimate the design heat loss of the test house. For simplicity's sake, the test house was divided into four thermal zones. Schematic of these zones are shown in Figures A.1 and A.2.

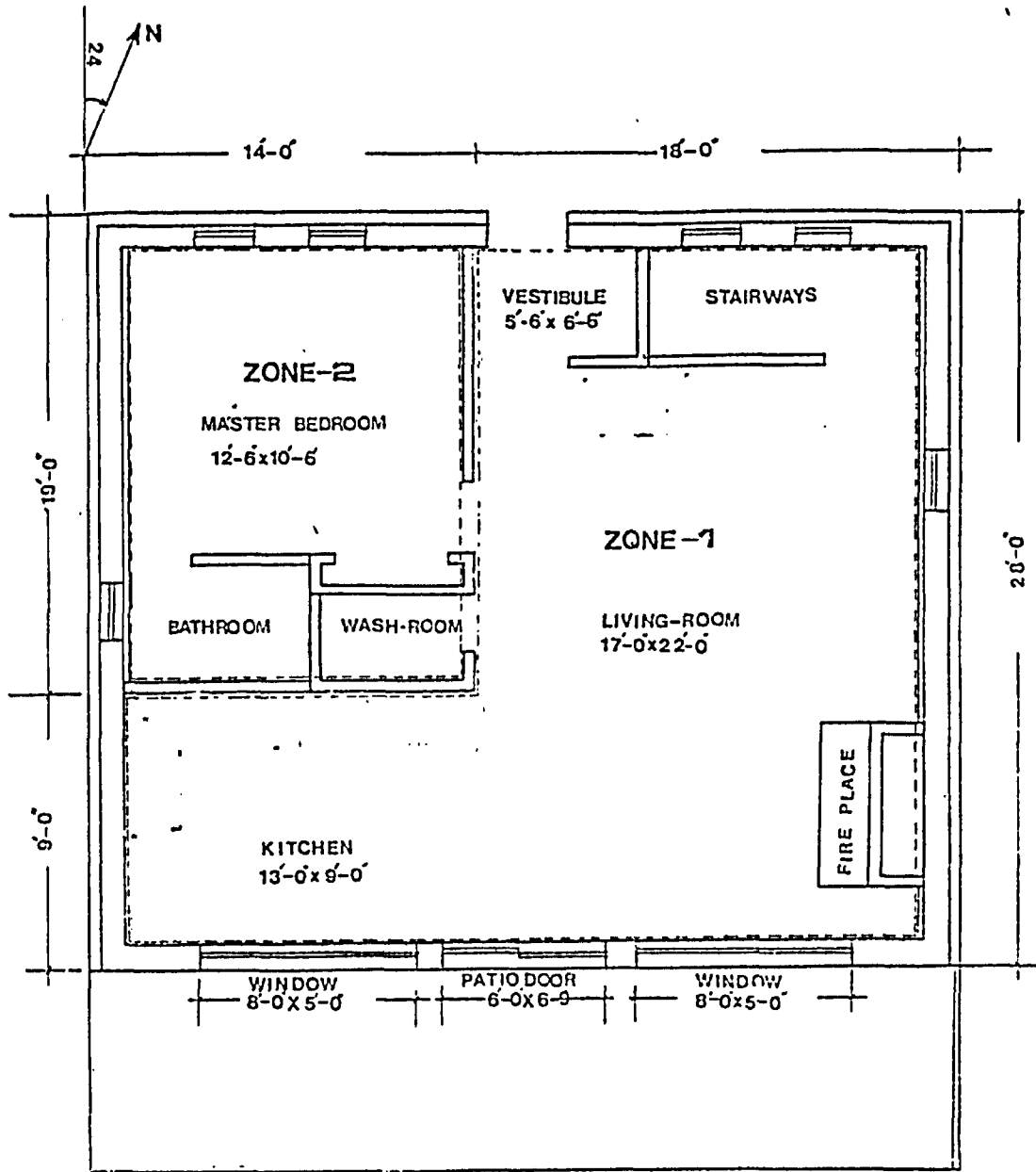

FIG. A.1: A SCHEMATIC OF THERMAL ZONE ON UPPER LEVEL OF TEST HOUSE

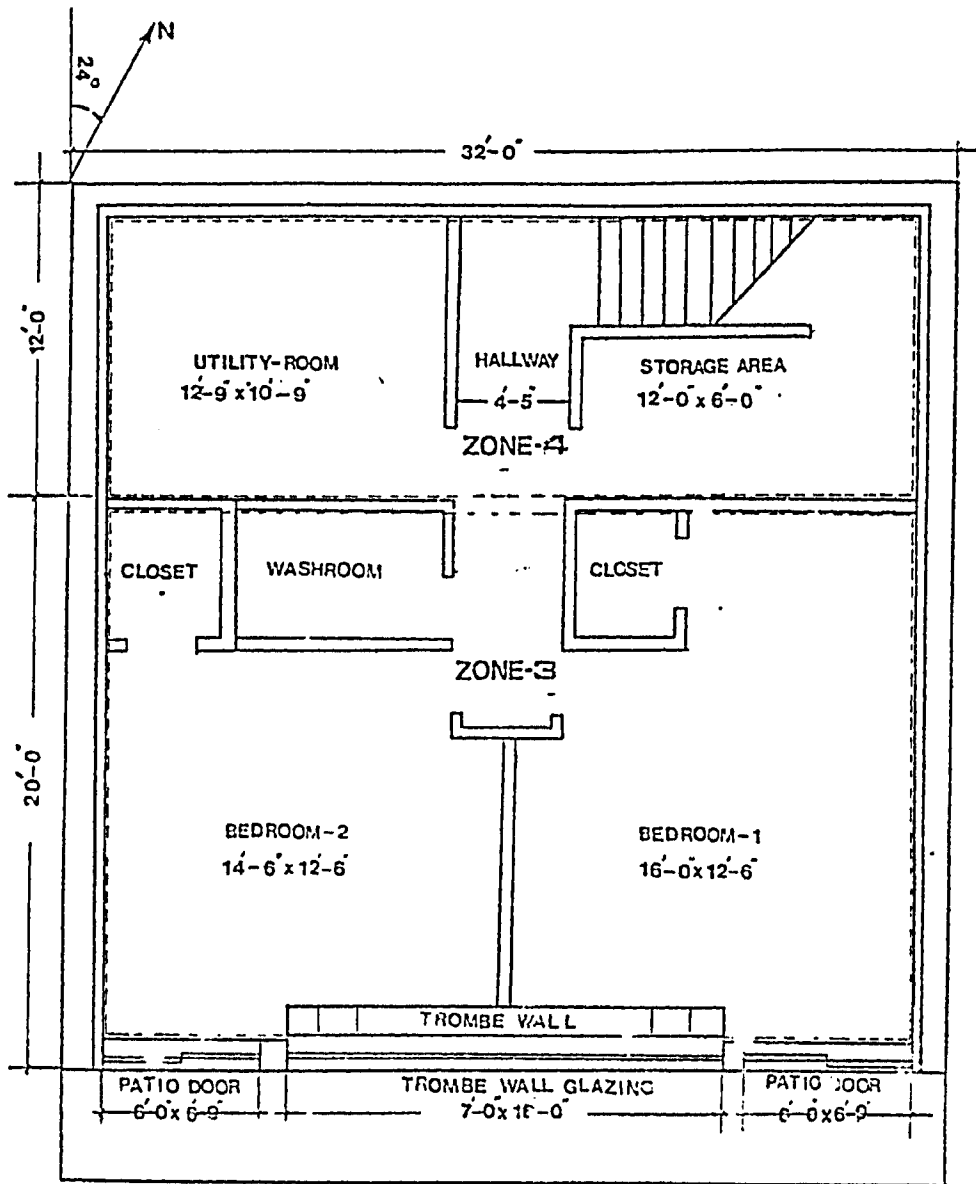

FIG. A.2: A SCHEMATIC OF THERMAL ZONES ON LOWER LEVEL OF TEST HOUSE

Transmission losses through the structural components were calculated on the basis of steady state heat transfer using the following equation.

$$Q = U \times A \times (T_i - T_o) \quad (A.2)$$

where

Q = Design heat loss - Btuh.

U = Overall heat transmission coefficient Btu/ Hr. Ft. F.^2

A = Net area of the structural component Ft.^2

T_i = Design indoor temperature - (F).

T_o = Design outdoor temperature - (F).

Heat loss through the underground walls and floors was calculated on a steady state basis using ASHRAE's radial isotherm method Reference (18).

Multiple linear regression models were used to estimate infiltration losses in each of the four spaces. The general form of these models is

$$I = K_1 + K_2 \times V + K_3 \times \text{DELT.} \quad (A.2)$$

where

I = Infiltration rate (air changes per hour).

K₁,K₂,K₃ = Coefficients of regression model.

V = Design wind speed (Knots).

DELT = Design indoor and outdoor temperature difference (F).

Recommended values of these coefficients for three types of residential constructions are listed in Table 7.3, Chapter VII, and were obtained from the ASHRAE 1981 Handbook of Fundamentals (28). The design wind speed of 15 m.p.h was also converted to 13

knots for use in equation (A.2). The calculated air change rates were used in the following expression to estimate the design infiltration loss.

$$q_s = 0.018 \times V \times (T_i - T_o)$$

where

$$\begin{aligned} V_o &= \text{Volumetric flow rate of air} \\ &= I \times \text{Volume of each zone} \text{ Ft}^3 / \text{Hour.} \end{aligned}$$

A.2 DESIGN CONDITIONS

The following indoor and outdoor design conditions were selected for the test house.

$$\begin{aligned} T_i &= \text{Design indoor temperature} \\ &= 70 \text{ F.} \end{aligned}$$

$$\begin{aligned} T_o &= \text{Design outdoor temperature} \\ &= 0 \text{ F. (99 percent value for Windsor).} \end{aligned}$$

$$\begin{aligned} V &= \text{Design wind speed} \\ &= 15 \text{ miles per hour (average winter conditions).} \end{aligned}$$

Design temperature difference for the underground surfaces was calculated on the basis of following equation, recommended in chapter 24 of Reference (18).

$$T_{dg} = T_i - (\bar{t}_a - A_m).$$

where

$$\begin{aligned} \bar{t}_a &= \text{Mean annual air temperature} \\ &= 45 \text{ F (Windsor).} \end{aligned}$$

$$\begin{aligned} A_m &= \text{Amplitude of ground surface temperature fluctuation F} \\ &= 22 \text{ F (Fig. 2, chapter 24 Reference (18)).} \end{aligned}$$

$$\begin{aligned} T_{dg} &= (70 - (45 - 22)) \\ &= 47 \text{ F.} \end{aligned}$$

A.3 ASSUMPTIONS

1. Each space was assumed to be maintained at a constant indoor temperature of 70 F.
2. Internal gains from occupants, lights and appliances were not taken into account.
3. Solar gains through the south facing windows and patio doors were ignored.
4. The effect of the Trombe wall was not accounted for. Its glazing was simply treated as a double pane window to calculate transmission losses.
5. The effect of insulating shutters was ignored.
6. The resistance of roof material and attic air was added to the ceiling of upper floor.

A.4 DESIGN HEAT TRANSMISSION COEFFICIENTS

The design heat transmission coefficients for windows, walls and ceilings were calculated according to the procedures recommended in Reference (18), and are listed in Tables A.1 and A.2.

Heat transmission coefficients for the underground walls were calculated for each foot of depth below grade taking into account the soil resistance. These values are listed in Table A.3.

TABLE A.1
 DESIGN HEAT TRANSMISSION COEFFICIENTS OF EXTERIOR WALLS
 AND CEILINGS

STRUCTURAL COMPONENT	DESIGN U - VALUE BTU. H / FT. ² F°
UPPER FLOOR CEILING (2x8 JOISTS)	0.0280
UPPER FLOOR CEILING (2x6 JOISTS)	0.0292
EAST, WEST AND NORTH WALLS (UPPER-LEVEL)	0.0317
SOUTH WALL (UPPER-LEVEL)	0.0314
EXTERIOR WALLS (LOWER-LEVEL)	0.0896
CEILING (LOWER-LEVEL)	0.0382
SILL PLATE	0.0296

TABLE A.2
 HEAT TRANSMISSION COEFFICIENTS FOR WINDOWS & DOORS

DESCRIPTION	U-VALUE, BTU.H/FT. ² .F°	CORRECTION FACTOR	MODIFIED U-VALUE BTU.H/FT. ² .F°
DOUBLE GLAZED WINDOW WITH 80 PERCENT GLASS AREA.	0.58	0.95	0.551
DOUBLE GLAZED PATIO DOOR WITH 80 PERCENT GLASS AREA.	0.58	1.00	0.580
SINGLE GLAZED FROSTED WINDOW.	1.10	0.90	0.990
MAIN ENTRANCE DOOR	0.49	1.00	0.490

TABLE A.3

HEAT TRANSMISSION COEFFICIENT FOR UNDERGROUND WALLS

DEPTH BELOW GRADE- FEET	HEAT FLOW PATH LENGTH - FEET	SOIL RESISTANCE HR. FT. ² F° / BTU	U - VALUE BTU.H/FT. ² .F°
0 - 1	0.68	0.83	0.081
1 - 2	2.27	2.84	0.069
2 - 3	3.38	4.23	0.063
3 - 4	5.52	6.90	0.053
4 - 5	7.05	8.81	0.048
5 - 6	8.65	10.81	0.044
6 - 7	10.28	12.85	0.040
7 - 8	11.91	14.88	0.037

A.5 DESIGN CALCULATIONS FOR ZONE-1

Transmission Losses

PART OF STRUCTURE	AREA SQ.FT	U-VALUE BTUH/ FT. F ²	DESIGN HEAT LOSS BTUH
SOUTH WALL	136.0	0.03145	299.40
SOUTH WINDOW-1	40.0	0.55100	1542.80
SOUTH WINDOW-2	40.0	0.55100	1542.80
PATIO DOOR	40.0	0.58000	1644.30
WEST WALL	72.0	0.03170	159.77
EAST WALL	216.0	0.03170	479.30
EAST WINDOW	8.0	0.55100	308.56
NORTH WALL	107.0	0.031700	237.43
NORTH WINDOW-1	8.0	0.551000	308.56
NORTH WINDOW-2	8.0	0.551000	308.56
ENTRANCE DOOR	21.0	0.049900	720.30
CEILING (2x8) JOISTS	504.0	0.028000	987.83
CEILING (2x6) JOISTS	126.0	0.029500	260.15
TOTAL TRANSMISSION LOSSES		8799.77 BTUH	

Infiltration Losses (Medium Construction)

$$I = 0.1 + (0.0252 \times 13) + (0.00944 \times 70)$$

$$= 1.0884 \text{ air changes per hour.}$$

$$V_0 = 1.0884 \times 4288$$

$$= 4667 \text{ Ft}^3 / \text{Hr}$$

$$q_s = 0.018 \times 4667 \times 70$$

$$= 5880 \text{ BTUH.}$$

A.6 DESIGN CALCULATIONS FOR ZONE-2

Transmission Losses

PART OF STRUCTURE	AREA SQ.FT	U-VALUE BTUH / FT. ² F	DESIGN HEAT LOSS BTUH
NORTH WALL	96.0	0.031700	213.00
NORTH WINDOW-1	8.0	0.551000	308.56
NORTH WINDOW-2	8.0	0.551000	308.56
WEST WALL	144.0	0.031700	319.54
WEST WINDOW	8.0	0.990000	554.40
CEILING (2x6) JOISTS	266.0	0.029200	544.64
TOTAL TRANSMISSION LOSSES			2248.70 BTUH

Infiltration Losses (Tight Construction)

$$I = 0.1 + 0.0175 \times 13 + 0.0061 \times 70$$

$$= 0.7545 \text{ air changes per hour.}$$

$$V_0 = 0.7545 \times 1841$$

$$= 1389.0 \text{ Ft}^3 / \text{Hr}$$

$$q_5 = 0.018 \times 1389 \times 70$$

$$= 1750.0 \text{ BTUH}$$

A.7 DESIGN CALCULATIONS FOR ZONE-3

Transmission Losses

PART OF STRUCTURE	AREA SQ.FT	U-VALUE BTUH / FT ² .F	DESIGN HEAT LOSS BTUH
SOUTH WALL	67.0	0.0896	420.00
PATIO DOOR-1	40.5	0.5800	1644.00
PATIO DOOR-2	40.5	0.5800	1644.00
TROMBE WALL GLAZING	108.0	0.5510	4165.56
EAST WALL	80.0	0.0896	501.76
WEST WALL	80.0	0.0896	501.76
SILL PLATE	30.0	0.0296	62.16
CEILING	128.0	0.0382	342.27
TOTAL TRANSMISSION LOSSES		9282.00	BTUH

Infiltration Losses (Loose Construction)

$$I = 0.1 + 0.0345 \times 13 + 0.01278 \times 70$$

$$= 1.4431 \text{ air changes per hour}$$

$$V_0 = 1.4431 \times 4468$$

$$= 6448.0 \text{ Ft}^3 / \text{Hr}$$

$$q_s = 0.018 \times 6448 \times 70$$

$$= 8124.48 \text{ BTUH.}$$

Underground Wall Losses

East and west walls of zone-3, shown in Figure A.3, were buried under the sloping grade. These walls were subdivided into eight segments each one foot deep. The design heat loss is summarized below.

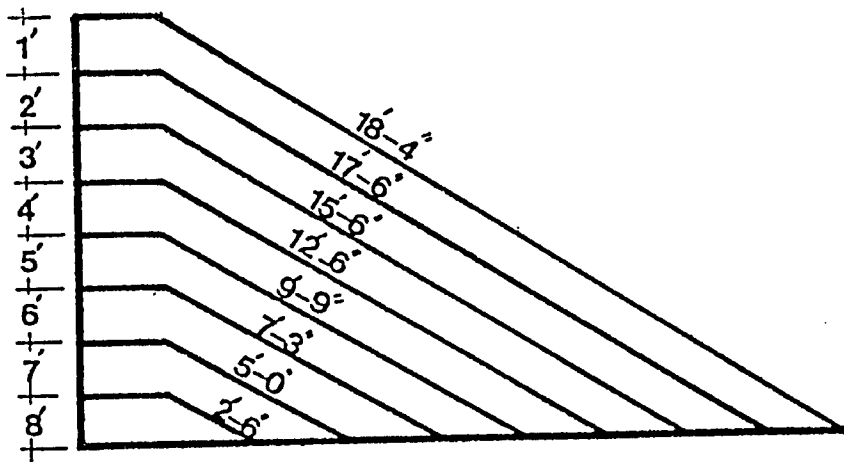

FIGURE-A3 SEGMENTS OF BELOW GRADE WALLS ZONE-3

DEPTH-FT	SEGMENT AREA SQ. FT	U-VALUE ² BTUH / FT. F	DESIGN HEAT LOSS BTUH
0 - 1	18.0	0.081	68.50
1 - 2	16.5	0.069	53.50
2 - 3	14.0	0.063	41.45
3 - 4	11.1	0.053	27.70
4 - 5	8.5	0.048	19.17
5 - 6	6.1	0.044	12.62
6 - 7	3.6	0.040	6.82
7 - 8	1.2	0.037	2.16
TOTAL DESIGN LOSS		232.00	BTUH

Underground Floor Losses

The 4 inch concrete floor of zone-3 was mostly buried below sloping grade with a small portion exposed to atmosphere at the south edge. The floor was broken into three sections as shown in Figure A.4.

Section-1 was a slab on grade with a total exposed edge of 36 feet. Heat loss through this section was calculated as follow:

$$Q_1 = F \times P \times (T_i - T_o)$$

where

F = Heat loss coefficient of exposed edge
= 0.93 Btuh/Hr.Ft.F

P = Perimeter of exposed edge
= 36 Ft.

$$Q_1 = 0.93 \times 36 \times 70$$

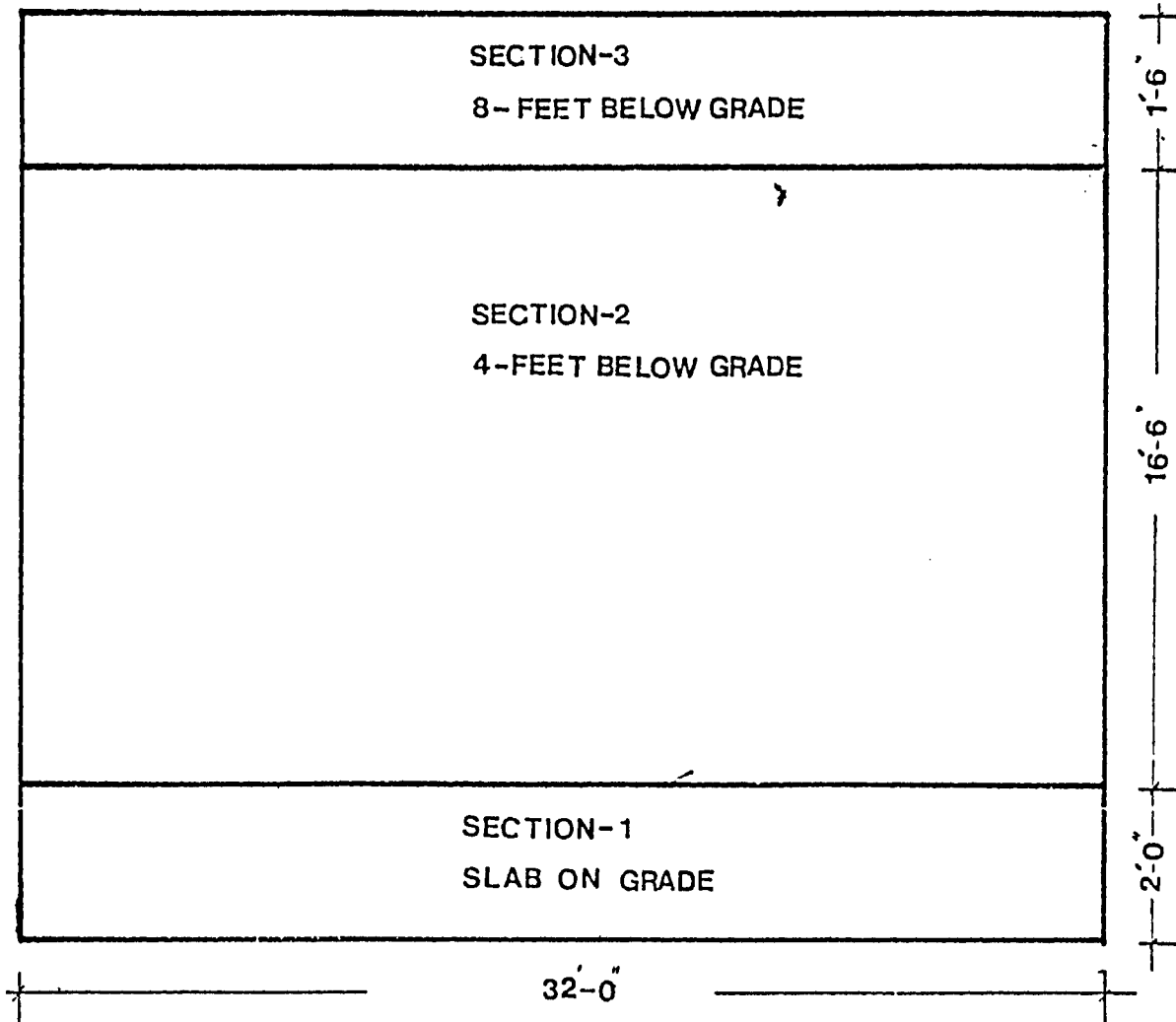

FIGURE-A-4 SECTIONS OF CONCRETE FLOOR
ZONE-3

$$= 2344.0 \text{ BTUH.}$$

Section-2 was buried under the sloping grade. An average depth of 4 feet was used to select the heat transmission coefficient from Table 2, chapter 24 of Reference (18).

$$\begin{aligned} Q_2 &= U \times A \times (T_i - (\bar{t}_a - A_m)) \\ &= 0.024 \times 528 \times 47 \\ &= 595.50 \text{ BTUH.} \end{aligned}$$

Section-3 was 8 foot below grade. Heat transmission coefficient of this section was also selected from Table 2, chapter 24 of Reference (18).

$$\begin{aligned} Q_3 &= U \times A \times (T_i - (\bar{t}_a - A_m)) \\ &= 0.02 \times 48 \times 47 \\ &= 45.12 \text{ BTUH.} \end{aligned}$$

$$\begin{aligned} \text{Total loss through the underground floor} &= Q_1 + Q_2 + Q_3 \\ &= 2984.60 \text{ BTUH.} \end{aligned}$$

A.8 DESIGN CALCULATIONS FOR ZONE-4

----- Infiltration Losses (Medium Construction) -----

$$\begin{aligned} I &= 0.1 + 0.0252 \times 13 + 0.00944 \times 70 \\ &= 1.0884 \text{ air changes per hour.} \end{aligned}$$

$$\begin{aligned} V_0 &= 1.0884 \times 2560 \\ &= 2786.3 \text{ Ft}^3 / \text{Hr} \end{aligned}$$

$$\begin{aligned} q_s &= 0.018 \times 2786.3 \times 70 \\ &= 3510.0 \text{ BTUH.} \end{aligned}$$

Underground Wall Losses

Underground walls of this space were uniformly buried below grade on all three sides. Widths of all these walls were added to calculate the design loss. Calculation details are tabulated below.

DEPTH-FT	SEGMENT AREA SQ.FT	U-VALUE BTUH / FT. F ²	DESIGN HEAT LOSS BTUH
0 - 1	56.0	0.081	213.20
1 - 2	56.0	0.069	181.60
2 - 3	56.0	0.063	165.80
3 - 4	56.0	0.053	139.50
4 - 5	56.0	0.048	126.30
5 - 6	56.0	0.044	115.80
6 - 7	56.0	0.040	105.30
7 - 8	56.0	0.037	89.50
TOTAL HEAT LOSS		1137.00 BTUH	

Underground Floor Losses

$$\begin{aligned}
 Q &= U \times A \times (T_i - (t_a - A_m)) \\
 &= 0.02 \times 384 \times 47 \\
 &= 361.0 \text{ BTUH.}
 \end{aligned}$$

A.9 DESIGN HEAT LOSS FOR THE TEST HOUSE

The design heat loss for the test house was obtained by summing the component heat loss in each of the four thermal zones. The details are tabulated below.

COMPONENT HEAT LOSS	ZONE-1	ZONE-2	ZONE-3	ZONE-4
TRANSMISSION LOSS	8779.77	2248.70	9282.00	-
INFILTRATION LOSS	5880.00	1750.00	8124.48	3510.00
UNDERGROUND WALL LOSS	-	-	464.00	1137.00
UNDERGROUND FLOOR LOSS	-	-	2987.00	361.00
TOTAL HEAT LOSS (BTUH)	14659.77	3998.70	20857.0	5008.00
TOTAL DESIGN HEAT LOSS FOR THE TEST HOUSE	44523.5			BTUH

APPENDIX - B
INSTRUMENTATION AND DATA ACQUISITION SYSTEM

INSTRUMENTATION AND DATA ACQUISITION SYSTEM

Several types of instruments and a computerized data acquisition system were used to monitor the performance of the test house. The details of the instrumentation and the data acquisition system are presented in the following sections.

B.1 HEATER MONITOR PICKUPS

The heater monitor pickup units, shown in Figure B.1.1, were designed to detect on and off cycle of the baseboard heaters. These units were basically relay coils, modified by the addition of a rectification unit which consisted of a diode and a 10 μ F capacitor. These units were inserted across the power lines of the baseboard heaters. During an on cycle of the heater, alternating current flowing through the power line induced a voltage in the soft iron core. This voltage was picked up by the coil, rectified, and relayed to the data logger unit.

The effectiveness of these pickup units was determined by comparing the sum total of power consumption of baseboard units, data acquisition system and the refrigerator unit to the data recorded from the utility meter. This comparison was made over March 21st and 28th, as uninterrupted utility meter readings were available for this period. The results of this comparison, presented in Tables B.1.1 and Table B.1.2, showed that the metered energy consumption was underpredicted by only 2.5 percent. This indicated that the pickup units were quite accurate in determining the power consumption of baseboard units.

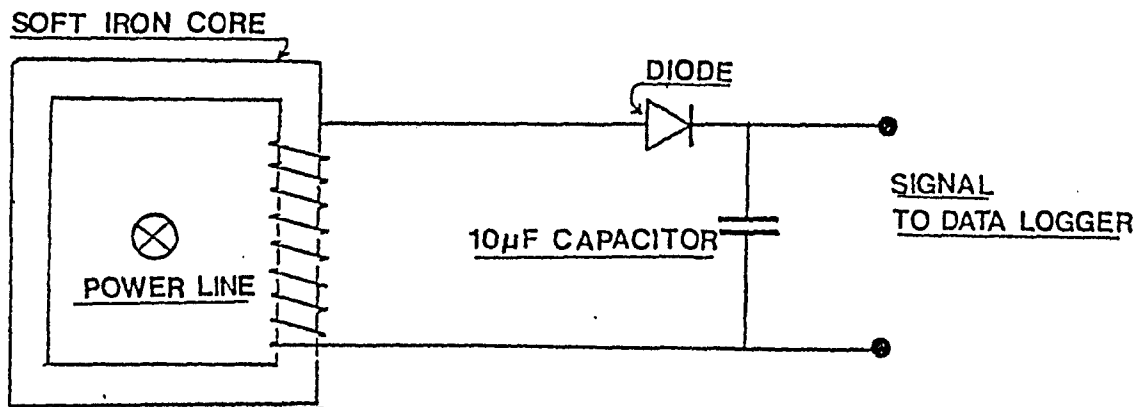

FIGURE B-11 A SCHEMATIC OF HEATER MONITOR PICKUP UNIT

TABLE B.1.1

MEASURED POWER CONSUMPTION OF BASEBOARD HEATERS, DATA ACQUISITION SYSTEM AND REFRIGERATOR UNIT

DESCRIPTION	POWER RATING KW	HOURS OF OPERATION	MEASURED CONSUMPTION KWH
BASEBOARD UNITS (ZONE-1)	-	168	60.06
BASEBOARD UNITS (ZONE-2)	-	168	62.16
BASEBOARD UNITS (ZONE-3)	-	168	474.43
BASEBOARD UNITS (ZONE-4)	-	168	136.45
MICROCOMPUTER	0.065	168	10.92
DATA LOGGER	0.045	168	7.56
REFRIGERATOR	0.140	168	23.52
TOTAL POWER CONSUMPTION		775.10	KWH

TABLE B.1.2

ENERGY METER READINGS

Metered Energy Consumption, March 28th, Hour 16:00	= 17040.0 KWH
Metered Energy Consumption, March 21st, Hour 16:00	= 16245.0 KWH
Net Energy Consumption	795.0 KWH

Percentage Difference = $\frac{\text{Metered Consumption} - \text{Measured Consumption}}{\text{Metered Consumption}}$

$$= \frac{795.00 - 775.10}{795.00} = 2.5 \%$$

A shortcoming of these pickup units was their high time constant which was of the order of 100 seconds. It is recommended that the response characteristics of the heater monitor pickups should be improved for future use. This can be done by adding a suitable resistance in parallel with the 10 uF capacitor.

B.2 ANEMOMETER

The anemometer was a standard unit purchased from Trade Winds Inc. It consisted of a small D.C generator sealed in a casing, with three hemispherical cups radially mounted on the generator's shaft. A schematic of the anemometer and its electric circuit diagram is shown in Figure B.2.1.

The anemometer was tested in the wind tunnel of the Mechanical Engineering laboratory, University of Windsor. The wind tunnel was operated at a speed of 200 to 1200 RPM in successive increments of 100 RPM. An inclined manometer was used to measure the dynamic velocity pressure. Signals from the anemometer were measured with a digital voltmeter. Test data for the anemometer is listed in Table B.2.1.

The following equation was used to convert the dynamic velocity pressure into equivalent wind speed in miles per hour.

$$V = 0.682 \sqrt{\frac{2 \times g \times 0.827 \times \rho_{air} \times h \times \sin \theta}{\rho_{air} \times 12}}$$

where

V = Wind speed in miles per hour.

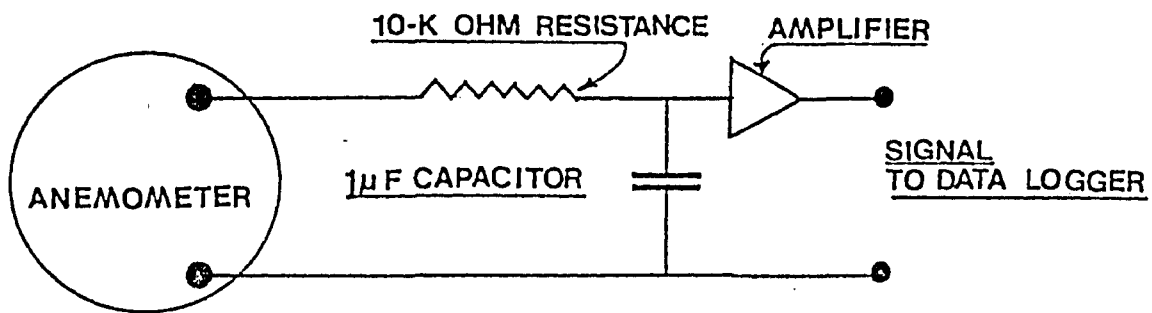

FIGURE B-2-1 A SCHEMATIC OF ANEMOMETER

TABLE B.2.1
EXPERIMENTAL DATA FOR ANEMOMETER CALIBRATION

WIND TUNNEL SPEED RPM	PRES. DIFF. MM OF LIQ	PRES. DIFF INCH OF LIQ	OUTPUT VOLTAGE VOLTS	WIND SPEED MPH
200	0.95	0.0374	0.370	5.66
300	2.75	0.1083	0.770	9.64
400	5.25	0.2066	1.120	13.32
500	9.50	0.3766	1.470	17.97
600	14.75	0.5807	1.850	22.32
700	20.50	0.8070	2.183	26.32
800	28.25	1.1100	2.560	30.90
900	35.75	1.4050	2.870	34.74
1000	45.00	1.7700	3.260	39.00
1100	55.25	2.1740	3.640	43.20
1200	67.00	2.6400	3.963	47.60

0.682 = Conversion factor to convert wind speed from feet/sec to miles per hour.

ρ_{liq} = Density of fresh water at S.T.P.
= 62.4 lbs/cu.ft.

ρ_{air} = Density of air at S.T.P.
= 0.075 lbs/cu.ft.

h = Mean height of liquid column in the manometer - inches.

θ = Inclination of manometer
= 30 degrees.

The method of least squares was used to develop a correlation between the wind speed and the corresponding output voltage from the anemometer. The following relationship was obtained :

$$V = 0.486027 + 11.8331 \times V_e$$

where V_e = Voltage output from the anemometer - Volts

$$\begin{aligned} \sum &= \text{Sum of the minimum square of errors.} \\ &= 1.261 \end{aligned}$$

Calibration curve for the anemometer is shown in Figure B.2.2. Standard error of estimate in the measured wind speed was calculated as follows:

$$\text{Standard Error} = \sqrt{\frac{\sum (y_i - \bar{y}_i)^2}{n - 1}}$$

where y_i = Measured value of wind speed.

\bar{y}_i = Regression value of wind speed.

n = Number of data points
= 11.

$$\begin{aligned} \text{Standard Error} &= \sqrt{\frac{1.261}{11 - 1}} \\ &= \pm 0.3551 \text{ mile per hour.} \end{aligned}$$

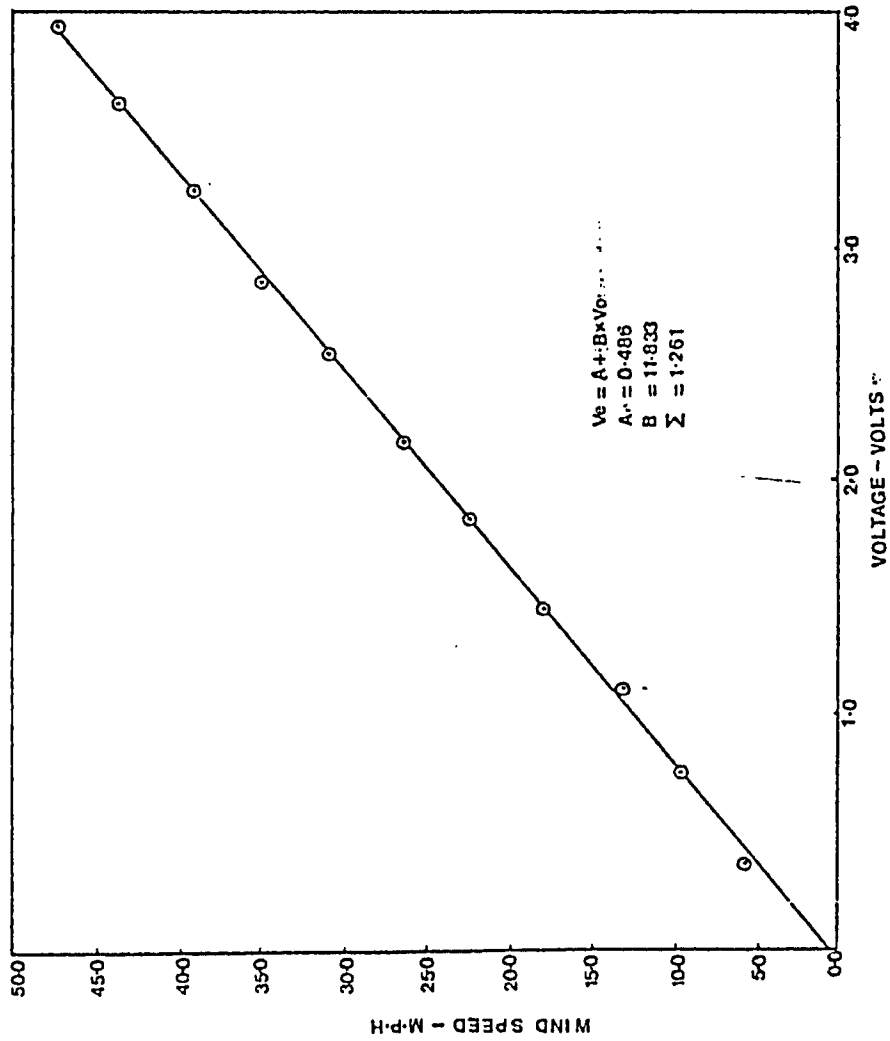

FIGURE B-3-2 CALIBRATION CURVE FOR ANEMOMETER

B.3 WIND DIRECTION METER

The wind direction meter was designed and calibrated to meet the requirements at the test site. It consisted of the following components:

1. A Rectangular Weather Vane.
2. A 10-K Ohms Circular.
3. A 15 Volt D.C Power Supply.

The electrical circuit diagram is shown in Figure B.3.1. The weather vane was mounted at the top of an axle which carried a brush at its lower end. A circular disc, graduated in degrees, was also mounted on the lower end of the axle to provide an indication of wind direction with respect to a fixed reference. The brush was in contact with the circular resistor which was in series with a fixed resistance of 10 K Ohms. The two resistors were energized by a constant 15 volts D.C power supply.

The voltage drop across the terminals of the circular resistor was proportional to its point of contact with the brush. As the weather vane rotated, the point of contact between the brush and the circular resistor also changed, varying the potential drop across the circular resistor's terminal. The potential drop across the circular resistor for different wind directions was measured with a digital voltmeter. Test data for the wind direction meter is listed in Table B.3.1.

The method of least squares was used to establish a functional correlation between the wind direction and the corresponding voltage drop. The following relationship was obtained.

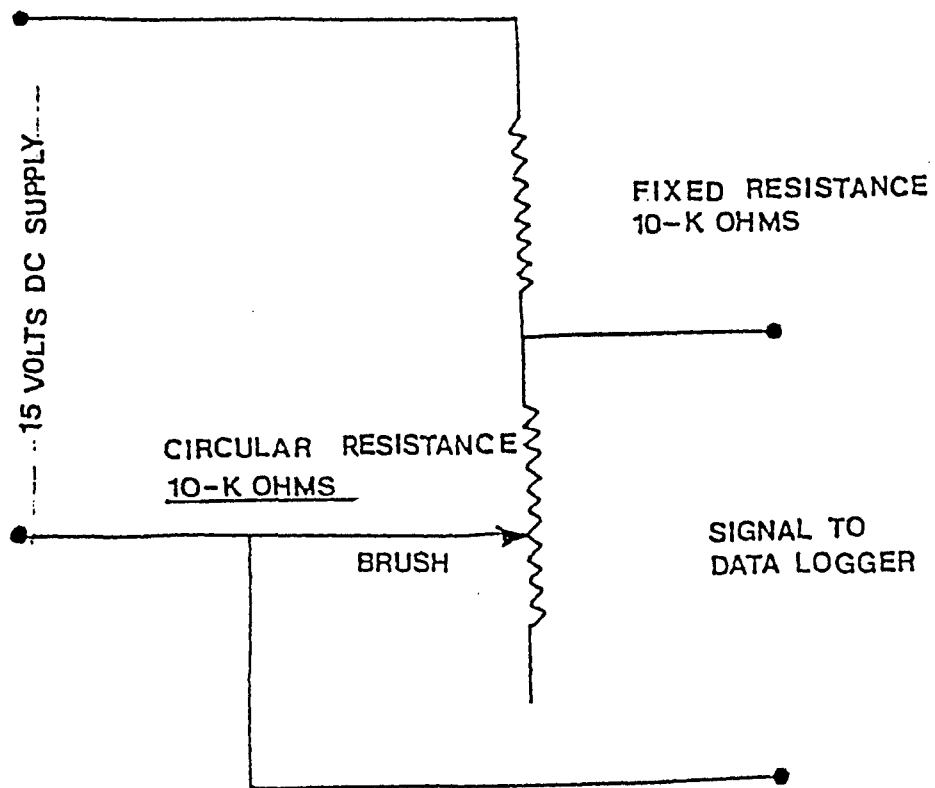

FIGURE B-3-1: A SCHEMATIC OF WIND DIRECTION METER

TABLE B.3.1

EXPERIMENTAL DATA FOR WIND DIRECTION METER CALIBRATION

WIND DIRECTION - DEGREES	VOLTAGE DROP - VOLTS
0	0.01
10	0.32
20	0.78
30	1.19
40	1.52
50	1.84
60	2.19
70	2.51
80	2.79
90	3.06
100	3.36
110	3.62
120	3.86
130	4.11
140	4.31
150	4.54
160	4.78
170	4.95
180	5.14
190	5.32
200	5.53
210	5.69
220	5.86
230	6.02
240	6.18
250	6.34
260	6.48
270	6.63
280	6.77
290	6.91
300	7.03
310	7.15
320	7.27
330	7.40
340	7.51
350	7.62
360	7.72

$$Wd = - 0.449951 + 26.8934 \times Ve + 0.363604 \times Ve^2 + 0.374574 \times Ve^3$$

where Wd = Wind direction - Degrees.

Ve = Voltage drop across the circular resistor - Volts.

$$\begin{aligned} \sum &= \text{Sum of minimum square of errors in wind direction} \\ &= 28.15 \end{aligned}$$

Calibration curve for the wind direction meter is shown in Figure B.3.2. Standard error in the measured wind direction was calculated as follows:

$$\text{Standard Error} = \sqrt{\frac{(\sum (y_i - \bar{y}_i)^2)}{n - 1}}$$

where y_i = Measured value of wind direction

\bar{y}_i = Regression value of wind direction

n = Number of test points
= 37

$$\begin{aligned} \text{Standard Error} &= \sqrt{\frac{(28.15)}{37 - 1}} \\ &= \pm 0.884 \text{ degrees.} \end{aligned}$$

B.4 PYRANOMETERS

Eppley Black and White temperature compensated pyranometers are standard instruments, developed by Eppley Laboratory, Inc. to measure the global, diffused and reflected short wave radiation. The detector element in these instruments consisted of a differential electroplated (copper-constantan) thermopile. The hot - end and the cold - end receiver junctions, respectively were coloured black and white to create a thermocouple effect.

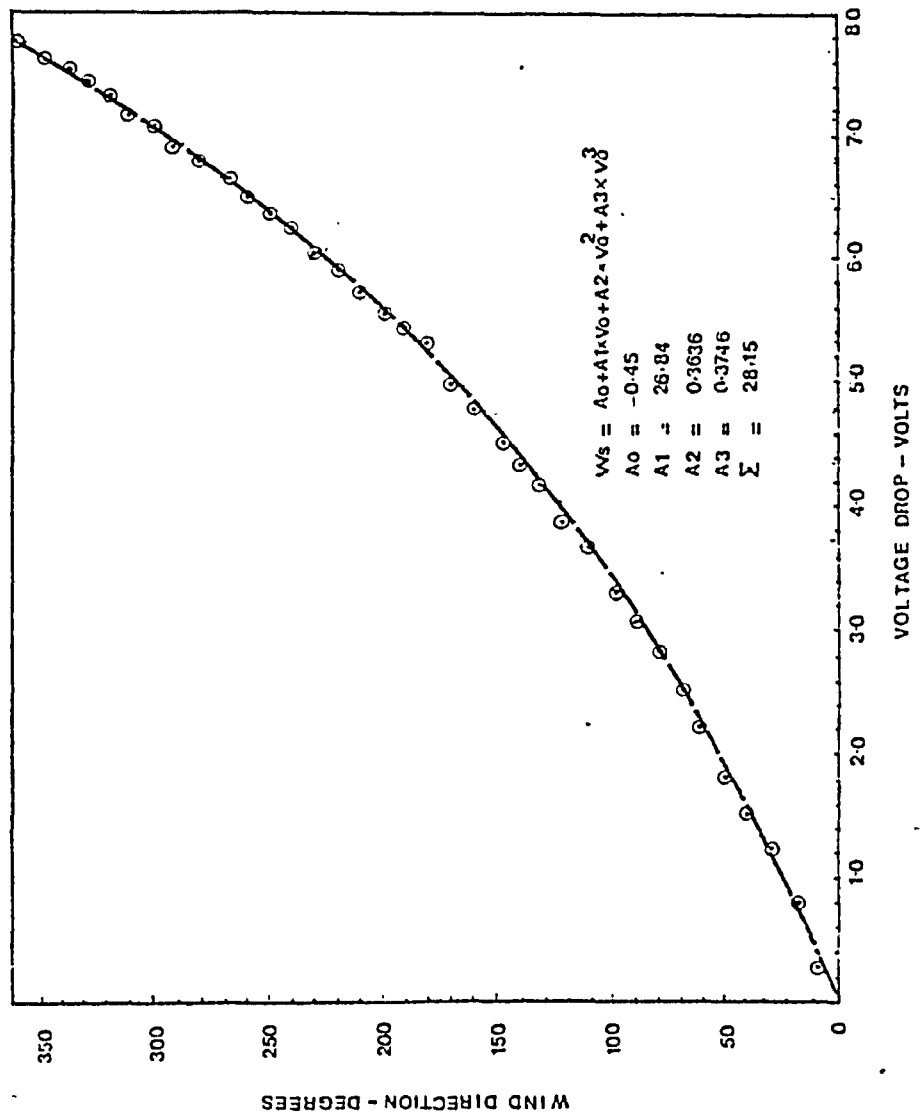

FIGURE B-3-2 CALIBRATION CURVE FOR WIND DIRECTION METER

The characteristics of these instruments are shown below.

Sensitivity	9 microvolts per watt meter (approx)
Impedance	650 ohms (approx)
Receiver	Circular 1 cm , coated with Parson's black optical laquer.
Temperature Dependance	\pm 1 percent over ambient temperature range -20 to +40 C.
Linearity	\pm 0.5 percent from 0 to 2800 watts / m ²
Response Time	1 second.

B.5 RADIO SHACK MICROCOMPUTER

The Radio Shack TRS-80 Model III (30) is a microcomputer with disk operating system. It consists of a video display screen, a key board, a central processing unit and a real time clock which were all housed in a single moulding. Model III had a storage capacity of 14K bytes of permanently programmed Read Only Memory (ROM) which was reserved for the TRS-80 BASIC Language and built in programing functions. Likewise, it also contained a storage capacity of 48K bytes of Random Access Memory (RAM) which was reserved for the user's programs and results. Model III was equipped with necessary interfaces which allowed the addition of a line printer and a cassette recorder for additional data storage. A standard RS 232-C interface, designed to meet the E.I.A (Electronic Industries Association) standards, was also installed as an option in Model III to make it compatible with other data processing equipment.

B.6 FLUKE DATA LOGGER

The Fluke Model 2240-C Data Logger (31) is a data processor. The basic unit is contained in a mechanical housing and consists of a front mounted control panel, a digital display, a digital printer, control logic required to interface the basic unit to a full range of options, an analog to digital converter and a series of PCB and module slots designed to accommodate a number of plug in options. In its basic form, the channel scanning capability of Model 2240-C was limited to only 60 channels. However, this capacity could be increased to 1000 channels through the addition of one or more of Model 2201A/ 2202A and 2203A scanner chassis which are also available as accessories. Model 2240-C was quite flexible and could be converted into a user's designed data acquisition system through the addition of several available options which included a low level scanner and an isothermal block connector. Complete specifications of Model 2240C are available in Reference (31). The following accessories were installed as options in Model 2240C to make it compatible with the Radio Shack TRS-80 Model III microcomputer for data communication.

1. Low Level Scanner.
2. Isothermal Block Connector.
3. Remote Programming Option.
4. Temperature Scaling Option.

A brief description of each option, taken from the Data Logger's instruction manual, is provided in the following

sections.

Low Level Scanner (Option 06)

The low level scanner is a plug-in, 10-channel, 3-wire relay scanner. It is designed to function as a low level analog data multiplexer in Model 2240-C data logger. Switch high, low and shield inputs are provided for each of the 10 channels. Analog interface connections to the low level scanner are completed through a solder pin or an isothermal block connector. Specifications for the low level scanner are listed in Table B.6.1.

Isothermal Block Connector (Option 08)

The isothermal block connector was a 44 pin card edged assembly. It features an isothermal block and a temperature sensing circuit and is designed to supply voltage and temperature inputs to any of the ten scanner channels. Input connections to the isothermal block connectors are in the form of 10 sets of three screw terminals. Input signals at any of the 10 channels are measured in terms of voltage or temperatures , depending upon the type of function being programmed. When a temperature function is programmed, it is assumed that a thermocouple probe is used to provide an input to that channel. Several types of thermocouples can be used to supply the temperature inputs. The user can make a selection among the types listed in Table B.6.4. The specifications of the isothermal block connectors are shown in Table B.6.2.

TABLE B.6.1

LOW LEVEL SCANNER SPECIFICATIONS (OPTION - 06)

CHANNEL RELAYS	10 LOW THERMAL-EMF REED RELAYS
POLES PER CHANNEL	THREE (INCLUDES SHIELD SWITCH)
SHIELD SWITCHING	ONE SWITCH PER CHANNEL
VOLTAGE OFFSET	$\pm 1 \mu\text{V}$
INPUT VOLTAGE	170 V DC OR PEAK AC MAX
COMMON MODE VOLTAGE LIMITS.	350V DC OR PEAK AC PROVIDED THE INPUT VOLTAGE LIMIT IS NOT EXCEEDED
OVER-CURRENT PROTECTION	470 OHMS RESISTOR IN SERIES WITH EACH INPUT.

TABLE B.6.2

ISOTHERMAL BLOCK CONNECTOR SPECIFICATIONS (OPTION-08)

COMPATIBILITY	MATES WITH EITHER THE -05 OR -06 SCANNERS.
TERMINAL STYLE	SCREW TYPE
NUMBER OF TERMINALS	30
TEMPERATURE GRADIENT BETWEEN ANY TERMINAL	$\pm 0.05 \text{ C}$ MAXIMUM.
REFERENCE JUNCTION STABILITY	$\pm 0.005 \text{ C}$ PER (0 C TO 50 C)

Remote Programming interface (Option 17)

An interface is a standard device used for data communication between two pieces of data processing equipment. The term RS 232-C, is defined in Reference (30), as a specific EIA (Electronic Industries Association) standard which is a widely accepted method of interfacing a data terminal and data communication equipment. Most video terminals, modems and microcomputers utilize RS 232-C standards for data communication. In order to be compatible for binary data interchange, interfaces installed in each of the two pieces of data processing equipment are required to share a few characteristic features which include timing format, transmission mode, baud rate, data interface level etc.

The remote programming option is basically a standard RS 232-C interface, installed in Model 2240 C to make it compatible with the Radio Shack microcomputer. It features asynchronous timing, full duplex capability, selectable baud rate, a choice of interface levels and selectable input/output format for binary data interchange. This option was quite flexible, as its characteristics could conveniently be changed through a set of four switches located within the PCB assembly of Model 2240C.

Temperature Scaling Option (-43)

The temperature scaling option (-43) operates as an extension of the A/D converter and provides temperature measurements and

linearization capabilities to the data logger. It consists of a Temperature Measurement PCB and two linearization ROMs. The linearization ROMs contain linearization programs for the microprocessor and linearization tables for the selected thermocouple types. When a thermocouple input is used, the Temperature Scaling Option operates in conjunction with the isothermal block connectors to provide temperature readouts which are selectable in degrees C or degrees F with 0.1 degree resolution. The Temperature Scaling Option (-43), consists of a group of 11 temperature linearizations and one scaling function which are shown in Table B.6.3. In this monitoring project, copper-constantan thermocouples were used which correspond to type T of option (- 43). System accuracy for this type of thermocouples is listed in Table B.6.4.

B.7 DATA ACQUISITION SYSTEM

The data acquisition system, designed for the test house, consisted of a Model 2240C data logger and a TRS-80 Model III Radio Shack microcomputer. Data communication between the two pieces of equipment was established through standard RS 232-C interfaces built into each of these units. The following system characteristics were used for this monitoring project:

Baud Rate:	300 Bits/Second.
Parity:	Odd.
Word Length:	8 Bits.
Stop Bits:	2
Input Buffer:	1

TABLE B.5.3

THERMOCOUPLE TOTAL SYSTEM ACCURACY

TEMPERATURE RANGE	WORST CASE RESOLUTION	NBS CONFORMITY	SYSTEM ACCURACY		
			90 DAYS		1 YEAR
			77 F ± 9F SLOW	FAST	77 F ± 18F SLOW
COPPER-CONSTANTAN					
F -328 TO -202	0.2	0.15	0.5	0.7	0.8
-202 TO 32	0.1	0.15	0.5	0.5	0.6
32 TO 1112	0.1	0.15	0.4	0.4	0.5

TABLE B.6.4

PROGRAMMING CODE FOR TEMPERATURE LINEARIZATION OPTION

OPTION	1	2	3	4	5	6	7	8	9	10	11	0
-63	J	K	T	S	R	B	E	C	385	390	0-100%	REF JUN

Output Buffer: 1

These characteristics were further converted into equivalent codes to meet the requirements of the Model III. These coded characteristics were stored in five RAM locations of the Model III and are listed in Table B.7.1. The characteristics of Model 2240C were also changed through the four switch settings to match the data transmission requirements for this project. Switch settings within the data logger are listed in Tables B.7.2.

Channel inputs for the test points were provided to the data logger through the isothermal block connector. Scale setting, within the data logger, for different types of transducers is listed in Table B.7.3. All channels monitoring weather and indoor energy related parameters were scanned every 45 seconds and averaged on an hourly basis.

B.8 SYSTEM MONITORING PROGRAMS

System monitoring programs, FLKCON1 and FLKCON2, were written by C.W.Louis Lee as a part of his final year project (32). These programs were quite flexible to meet the data transmission requirements at the test site. Flow charts describing the control logics of FLKCON1 and FLKCON2 are shown in Figures B.8.1 & B.8.2. A complete listing of these programs is provided in Tables B.8.1 and B.8.2. Nomenclature of the variables used in FLKCON2 is listed in Table B.8.3.

FLKCON1 was designed to control the data logger through the

TABLE - B.7.1

SUMMARY OF RAM ADDRESSES USED IN MODEL III

ADDRESS	CONTENT	PROGRAM CODE
16888	BAUD RATE CODE	85
16889	PARITY/WORD LENGTH/STOP BIT	124
16890	WAIT SWITCH CODE ZERO= DONT WAIT, NON ZERO= WAIT	1
16872	INPUT BUFFER CODE, ONE BYTE	0
16880	OUTPUT BUFFER CODE, ONE BYTE	0

TABLE B.7.2

SWITCH SETTINGS ON RS-232-C IN FLUKE 2240C

SWITCH	SWITCH POSITION			
	1	2	3	4
S1	ON	OFF	OFF	ON
S2	ON	ON	ON	OFF
S3	ON	OFF	OFF	OFF
S4	OFF	OFF	ON	OFF

TABLE - B.7.3

SCALE SETTING FOR DIFFERENT TRANSDUCERS WITHIN THE
DATA LOGGER

TRANSDUCER	SCALE SETTING
RADIOMETERS	40 mV
ANEMOMETER	40 V
WIND DIRECTION METER	40 V
HEATER MONITOR PICK UPS	40 V

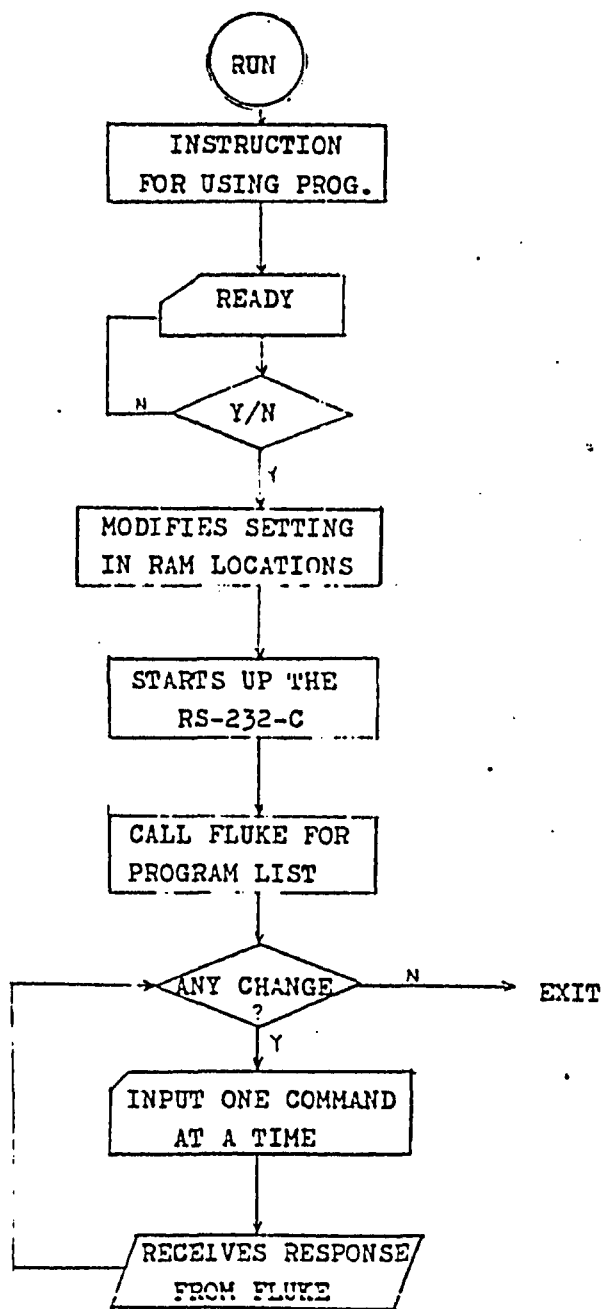

FIGURE B.8.1 : FLOW CHART FOR FLKCON1

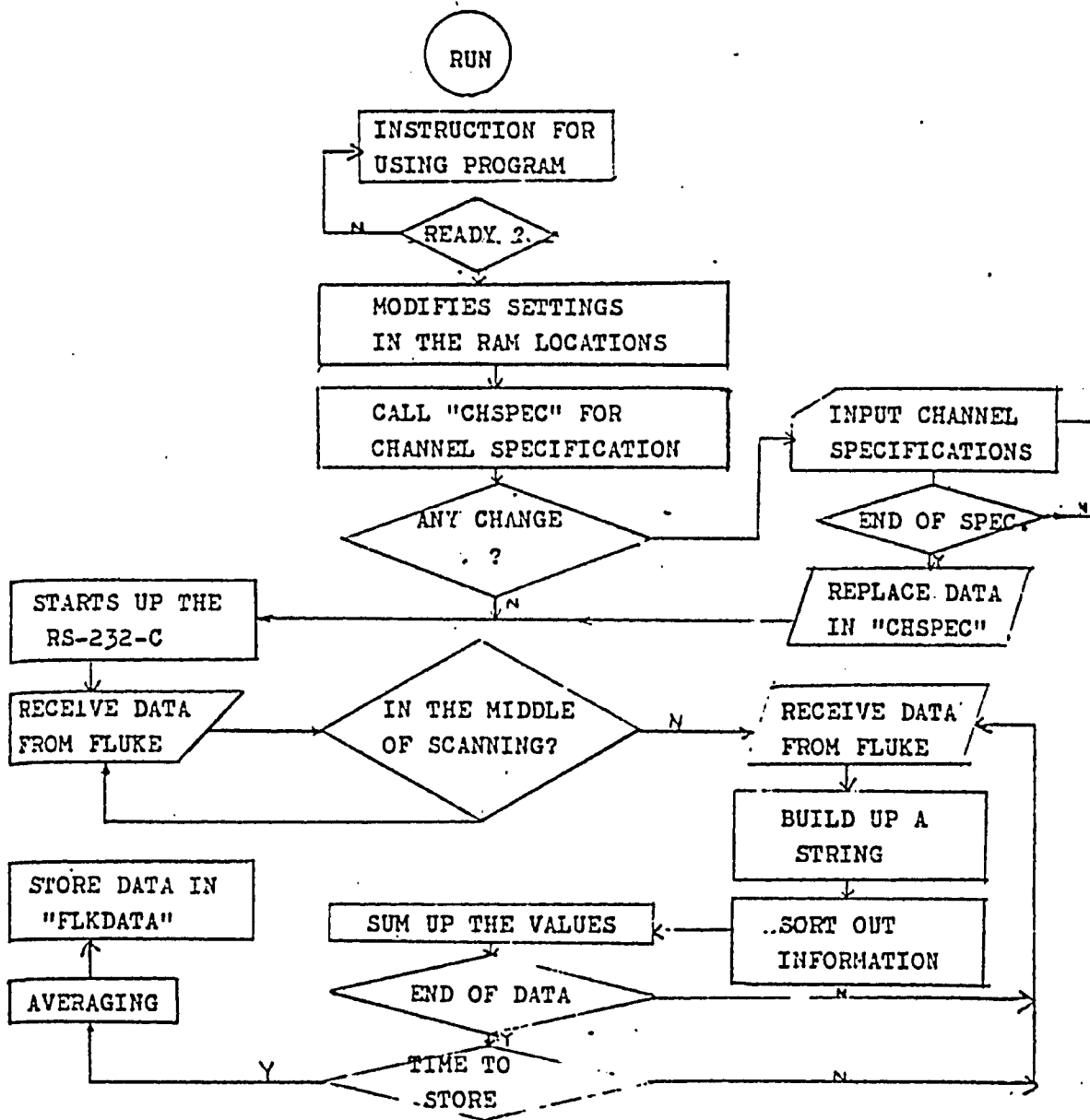

FIGURE B.8.2: FLOW CHART FOR FLKCON2

TABLE B-8.1

FLKCON1

```
1 CLS: PRINT " -----FLKCON1-----"
2 PRINT " EDITED BY LOUIS LEE C.W."
3 PRINT: PRINT " THIS PROGRAM IS TO BUILD UP PROGRAM IN FLUKE"
4 PRINT: PRINT " STRIKE <BREAK> KEY TO EXIT"
5 PRINT: LINE INPUT "ARE YOU READY ? Y/N ? ";ST$
6 IF ST$="Y" THEN 7 ELSE 5
7 CLEAR 1000
10 CLS: PRINT TAB(10) " FLUKE CONTROLER PROGRAM"
20 PRINT CHR$(13),CHR$(13)
25 POKE 16890,1 ' WAIT
30 POKE 16412,0 'BLINK
40 POKE 16419,253 'CURSOR CHR
50 POKE 16889,124 'PAR/WL/SB
60 POKE 16888,(5*16)+5 'BAUT RATE
70 DEFUSR0=90
80 DEFUSR2=85
90 DEFUSR1=80
100 X=USR0(0) 'START UP
110 CI=16872 :CO=16880 'I/O ADDRESS
112 PRINT "THIS IS THE PROGRAM IN MEMORY"
114 PRINT: A$="P"+CHR$(13):GOTO 140
120 PRINT:LINE INPUT "ENTER ONE COMMAND AT A TIME ----->";A$
130 A$=A$+CHR$(13)
140 L=LEN(A$)
150 FOR I=1TO L: ID$=MID$(A$,I,1): CD=ASC(ID$)
160 POKE CO,CD: X=USR2(0): NEXT I
162 A=A+1 : IF A=1 GOTO 180
170 CLS: PRINT "RESPONSE FROM FLUKE",CHR$(13)
180 X=USR1(0):BD=PEEK(CI):IF BD=13 OR BD=10 THEN BD=32
181 PRINT CHR$(BD);
190 IF BD=64 THEN 120 ELSE 180
```

TABLE B-8-2

FLKCON 2

```

10 CLS: PRINT "-----FLKCON-----"
20 PRINT "EDITED BY LOUIE LEE C.W."
30 PRINT:PRINT:THIS PROGRAM IS TO LOG FLUKE DATA INTO FILE
40 PRINT: PRINT "SARINE <F>NEAR> KEY TO EXIT"
50 PRINT: LINE INPUT "ARE YOU READY ? Y/N ? " :ST$
60 IF ST$="Y" THEN 70 ELSE 50
70 CLEAR 2020 : DIM CH(50),SIG(50),A,G(50),ENZ(50),LG(50),SINK(15)
80 CLS: PRINT TAB(10) " FLUKE CONTROLLER PROGRAM"
90 PRINT CHR$(13),CHR$(13)
100 POKE 16890,1
110 POKE 16412,0
120 POKE 16419,253
130 POKE 16889,124
140 POKE 16868,(5*16)+5
150 DEFUSR0=90
150 DEFUSR2=85
170 DEFUSR1=80
180 X=USR0(0)
190 CI=16872 :CO=16880
200 CLS: PRINT "
210 PRINT "
220 PRINT "
230 PRINT "
240 PRINT "
250 PRINT "
250 OPEN "1",3,"CHSPEC:0"
270 INPUT#3,CB%,C9%
280 PRINT @710 ;"FIRST CHANNEL ";CB%,"LAST CHANNEL ";C9%
290 FOR R1=CB% TO C9%
300 INPUT#3,I0%,CHR(I): PRINT " CH#;R1:"---";CH(R1);:NEXT R1
310 CLOSE 3:INPUT "
320 IF R1$="N" GOTO 530
330 I1=0: CLS: PRINT "
340 PRINT "
350 PRINT "
360 PRINT "
370 PRINT "
380 PRINT "
390 PRINT "ENTER < 0 > A) END OF SPECIFYING"
400 PRINT @720," :INPUT "FIRST CHANNEL ";CB%
410 PRINT @720," :INPUT "LAST CHANNEL ";C9%
420 PRINT @720,"CHANNEL # ",I1
430 INPUT "----->";I2$
440 IF I2$="0" THEN 480
450 IF VAL(I2$)<1 OR VAL(I2$)>5 GOTO 420
460 CH(I1)=VAL(I2$):PRINT CH(I1) :IF CH(I1)=0 GOTO 420
470 I1=I1+1: GOTO 420
480 OPEN "0",3,"CHSPEC:0"
490 PRINT#3,CB%,C9%
500 FOR R1=CB% TO C9%
510 PRINT#3,R1,CH(R1): NEXT R1
520 CLOSE 3
530 T=0:YB=0
540 CRZ=0: X=USR0(0)
550 C7Z=0
560 FOR R1=CB% TO C9% : SLG(R1)=0 :NEXT R1
570 FOR J=9 TO 15:BIN(I)=0:NEXT I
580 B$=""
590 X=USR1(0):B=PEEK(CI)
600 IF B=89 THEN B$="Y" ELSE GOT0590
610 GOTO 630
620 B$=""

```

```

640 A=USR1(0): B=LEN(C)
640 IF B=10 THEN GOTO ELSE B$=E$+CHR$(B)
650 GOTO 630
660 IF LEFT$(B$,1) <> "Y" THEN 690
670 CLS: T$=B$: C7%=C7%+1
680 PRINT "-----C7%-----", C7%: PRINT B$
690 IF LEFT$(B$,1) <> "A" THEN 620
700 FCHZ=VAL(MID$(B$,2,3))
710 LG(FCHZ)=VAL(MID$(B$,6,7))
720 PRINT B$: IF FCHZ <> C9% GOTO 620
730 IF LG(31) > 2 THEN D=5 ELSE D=1
740 FOR N9%=CBZ TO C9%
750 IF CH(N9%) < 3 THEN SLG(N9%)=SLG(N9%)+LG(N9%): GOTO 810
760 IF CH(N9%)=5 AND ABS(LG(N9%/D)) > .2 THEN SLG(N9%)=SLG(N9%)+1: GOTO 810
770 IF CH(N9%)=4 THEN L=ABS(LG(N9%/D)): SLG(N9%)=SLG(N9%)+0.486023 + 11.83331*L: GOTO 810
780 IF CH(N9%)=3 THEN V0=ABS(LG(N9%/D)): H=-65.449951+26.8934*V0-.363604*V0*V0+.374574*V0*V0*V0
790 IF CH(N9%) < 3 THEN 810
800 H=INT(H/24+.5): IF H < 0 OR H > 15 THEN H=0
805 BIN(H)=BIN(H)+1
810 NEXT N9%
820 IF T <> 0 THEN 840
830 H1=VAL(MID$(T$,6,2)): T=100: GOTO 580
840 H2=VAL(MID$(T$,6,2))
850 M2=VAL(MID$(T$,9,2))
860 S2=VAL(MID$(T$,12,2))
865 IF C7% > 200 THEN 890
870 IF H2=0 AND M2=0 AND S2=0 GOTO 890
880 IF (H2-H1) < 1 THEN 580
890 OPEN "E", 1, "FLKDATA/0:1"
900 TIME# = VAL(MID$(T$,2,3)) + 10000 + VAL(MID$(T$,6,2)) * 100 + VAL(MID$(T$,9,2))
910 PRINT #1, T$
920 FOR N9%=CBZ TO C9%
930 ENZ(N9%) = CH(N9%) * 1000 + N9%
940 ALG(N9%) = SLG(N9%) / C7%: PRINT "AVERAGING-----"
950 PRINT "WRITING-----"
960 PRINT #1, ENZ(N9%); ALG(N9%)
970 NEXT N9%
980 FOR I=0 TO 15: PRINT #1, BIN(I) / C7%: NEXT I
990 PRINT #1, " "
1000 CLOSE I
1010 H1=H2: GOTO 550

```

TABLE B-3

VARIABLES	DESCRIPTION
C1, C0	I/O Address
C8%, C9%	First/last channel
CH(ARRAY)	Channel Specification
I2\$	Input Channel Specification
C7%	Loop Counter
BIN(ARRAY)	Wind direction
SLG	Sum of Logged value
LG	Logged data
H1/H ₂ , M ₂ , S ₂	Time parameter
ALG	Average Logged data
T\$	Time string

microcomputer and was used to make all necessary modifications in the data logger's program .

FLKCON2 was designed to specify a functional code to each input channel. It performed all necessary calculations on the scanned data according to the following procedures:

All hourly temperatures, wind speed and solar radiation were straight averages, calculated on the basis of number of scans during a given hour.

Power consumption of the baseboard units was calculated as a percentage of time the heater was on during a given hour. This was accomplished by summing up the hourly on cycles of each heater and later on dividing them by the total number of hourly scans of the system.

Hourly values of the wind direction were distributed in sixteen bins. Each bin corresponded to a specific integer wind direction. During a scan of the system, wind direction measured in terms of output voltage was converted into an equivalent integer number and stored in the appropriate direction bin. At the end of each hour, the contents of each bin were divided by the total number of scans to calculate the percentage of time the weather vane was pointing towards a specific wind direction.

Hourly averages for each input channel, calculated in FLKCON2, were stored in a file named FLKDATA. In order to economise the disk storage capacity, hourly averages were stored in the form of continuous sets of data. Each data set contained

a time string, a channel specification and the corresponding hourly average of that channel.

APPENDIX - C
DATA PROCESSING PROGRAMS

DATA PROCESSING PROGRAMS

The experimental data recorded at the test site was required to be analyzed and converted into a proper format before it could be utilized for the development of a weather file and subsequent energy comparisons with the simulated results. BASIC programs WEHETE, TROMBE and SPLINE were written to process the raw data on the microcomputer. Complete listings and description of these programs are provided in the following sections.

WEHETE

The program WEHETE was used to access FLKDATA file and to sort out the hourly weather and indoor energy related data. Provisions were made in the program to perform necessary operations on the sorted data in order to convert them into consistent engineering units to meet the requirements of the DOE-2 program.

Wind speed, recorded in miles per hour, was converted into equivalent Knots by multiplying by a conversion factor of 0.869. The hourly wind directions were distributed as percentages in the sixteen bins depending upon the abrupt variation in the wind direction. The percentage content of these bins was converted into equivalent degrees and summed to obtain a single integer wind direction for each hour. The solar radiation measured by the horizontal and vertical radiometers were recorded in millivolts. These values were converted into equivalent radiation intensity in Btu/Hr.Ft² by multiplying by the calibration factor

of the respective radiometers. Energy consumption of individual baseboard heaters was in the form of percentage on-time of the heaters during a given hour. These percentages were multiplied by the power ratings of the baseboard units to calculate the hourly energy consumption in Btuh. Hourly consumption of individual baseboard units was later summed to obtain the total energy usage in each of the four thermal zones.

The indoor and outdoor temperatures were recorded in degrees F and did not require a conversion in units.

The weather and indoor performance data were compiled and stored in a data file named WHEATLY for further usage.

TROMBE

The program TROMBE was primarily used to access the file FLKDATA and retrieve data related to the performance of the Trombe wall. These included the Trombe wall air space and surface temperatures and solar radiation received by the radiometer. Temperatures were recorded in degrees F and did not require a conversion. However, solar radiation recorded in millivolts was converted into equivalent $\text{Btu}/\text{Hr}\cdot\text{Ft}^2$ by multiplying by the calibration factor of the radiometer. The Trombe wall performance data was compiled and stored in a file named TROMBE.

SPLINE

The program SPLINE was developed on the basis of ASHRAE's SUN and SOLAD algorithms and was used to analyze solar radiation for

the test period.

The program was executed in two steps. In the first step, solar related variables, based on the 21st day of each month, were interpolated on a daily basis using spline interpolations. In the second step, the program accessed the file WHEATLY and retrieved weather related variables which included outdoor temperatures in degrees F, wind speed in Knots, wind direction in degrees and solar radiation on a horizontal surface in Btu/Hr.Ft.² The horizontal radiation was used with the daily adjusted solar variables to calculate the direct normal and diffuse components of solar radiation for cloudy and clear sunny days recorded at the test site. The program also converted the hourly wind direction in degrees to equivalent integers.

The hourly weather data including the direct normal component of solar radiation were compiled and stored in a data file named WEATHER which was used as an input for the DOE weather processor.

WEHETE

```
5 CLEAR COMM:DIM B(15)
10 PRINT:USE IO READ FLNDATA:FILES IN DRIVE 1 AND CREATE A FILE WHEATLY IN DRIVE 0 PRESS A KEY TO CONTINUE*
15 OPEN "1",1,"FLNDA.A":
20 OPEN "0",2,"WHEA.LY":0
25 IF EOF(1) THEN 680
30 INPUT#1,A$
35 IF MID$(A$,1,1)<>"Y" THEN 120
40 IF Z=0 THEN Z=1:GOTO110
45 PRINT USING "### DA:HR:PRINT USING "###,#:VE;TD;TG:PRINT USING "###, #:RH;RV;AH
50 PRINT#2,USING"###:DA:HR:PRINT#2,USING"###,#:VE;TD;TG:PRINT#2,USING "###, #:RH;RV;AH
85 TB=(T1+T2)/2:HL=INT(H1+H2+H3+H4+.5):HM=INT(H5+H6+.5):HB=INT(H7+H8+H10+H11+.5)
90 PRINT USING "###, #:TN;TL;TM;TB;TH:PRINT USING "###, #:HL;HM;HB;HH
100 PRINT#2,USING"###, #:TN;TL;TM;TB;TH:PRINT#2,USING"###, #:HL;HM;HB;HH
110 DA=VAL(MID$(A$,2,3)):HR=VAL(MID$(A$,6,2)):GOTO 25
120 IF MID$(A$,1,4)='2015' THEN TD=VAL(MID$(A$,5,20)):GOTO 25
130 IF MID$(A$,1,4)='2019' THEN TL=VAL(MID$(A$,5,20)):GOTO 25
140 IF MID$(A$,1,4)='2022' THEN TM=VAL(MID$(A$,5,20)):GOTO 25
150 IF MID$(A$,1,4)='2016' THEN T1=VAL(MID$(A$,5,20)):GOTO 25
160 IF MID$(A$,1,4)='2017' THEN T2=VAL(MID$(A$,5,20)):GOTO 25
180 IF MID$(A$,1,4)='2018' THEN TH=VAL(MID$(A$,5,20)):GOTO 25
185 IF MID$(A$,1,4)='2021' THEN TN=VAL(MID$(A$,5,20)):GOTO25
190 IF MID$(A$,1,4)='5000' THEN H1=VAL(MID$(A$,5,20))*7645 :GOTO25
200 IF MID$(A$,1,4)='5002' THEN H2=VAL(MID$(A$,5,20))*8532 :GOTO25
210 IF MID$(A$,1,4)='5003' THEN H3=VAL(MID$(A$,5,20))*8532:GOTO 25
220 IF MID$(A$,1,4)='5005' THEN H4=VAL(MID$(A$,5,20))*1706.5 :GOTO 25
230 IF MID$(A$,1,4)='5001' THEN H5=VAL(MID$(A$,5,20))*3413 :GOTO 25
240 IF MID$(A$,1,4)='5004' THEN H6=VAL(MID$(A$,5,20))*2560 :GOTO25
250 IF MID$(A$,1,4)='5006' THEN H7=VAL(MID$(A$,5,20))*6826:GOTO 25
260 IF MID$(A$,1,4)='5007' THEN H8=VAL(MID$(A$,5,20))*6826:GOTO 25
270 IF MID$(A$,1,4)='5009' THEN H10=VAL(MID$(A$,5,20))*6826:GOTO25
280 IF MID$(A$,1,4)='5010' THEN H11=VAL(MID$(A$,5,20))*6828:GOTO25
290 IF MID$(A$,1,4)='5008' THEN HH=VAL(MID$(A$,5,20))*3413:GOTO 25
510 IF MID$(A$,1,4)='4014' THEN VE= VAL(MID$(A$,5,20))*0.669 ELSE 550
520 V0=0.340084+0.020462*VE+0.003541*VE*VE-8.14729E-05*VE*VE*VE+6.63304E-07*VE*VE*VE*VE
530 VE=(-.486023+11.8331*V0)*0.869
540 GOTO 25
550 IF MID$(A$,1,4)='2015' THEN TD=VAL(MID$(A$,5,20)) :GOTO25
560 IF MID$(A$,1,4)='2023' THEN TG=VAL(MID$(A$,5,20)):GOTO25
570 IF MID$(A$,1,4)='1024' THEN GOSUB720 :RH=-D*33.49:GOTO25
580 IF MID$(A$,1,4)='1025' THEN GOSUB720 :RV=-D*31.06:GOTO25
590 IF MID$(A$,1,4)<>"5031" THEN 670
600 FOR I=0TO15:INPUT#1,B(I):NEXT I
610 BB=0:IF B(0)<>0 AND B(15)<>0 THEN630
620 FOR I=1 TO 15:BB=BB+I*B(I):NEXT I:GOTO650
630 FOR I=1 TO 7:BB=3B+I*B(I):NEXT I
640 FOR I=8 TO 14:BB=BB+(I-15)*B(I):NEXT I
650 AH=BB*24:IF AH<0 THEN AH=AH+360
670 GOTO 25
680 PRINT "EOF"
690 CLOSE 1
700 CLOSE 2
710 END
720 D#=MID$(A$,5,20):DL=LEN(D$)
730 FOR I=1TODL:C#=MID$(D$,I,1):IF C#="E" THEN750 ELSE IF C#="-" THEN760
740 NEXT I
750 D=VAL(D$):RETURN
760 D#=MID$(D$,I+1,DL):D=-VAL(D$):RETURN
```

TROMBE

```

10 CLEAR MEM
20 OPEN "1",1,"FLANDATA:1"
30 OPEN "0",2,"PROBLE:0"
40 IF EOF(1) THEN 420
50 INPUT H1,A4
60 IF MID$(A4,1,1) <> "Y" THEN 160
70 IF Z=0 THEN Z:=1:GOTO 150
80 LW=(IX+TY)
90 TI=(0.7*PI+0.3*TM)
100 T2=(0.63*TM+0.37*TZ)
110 H1=INT((H1+H1+H2+H3+H4+H5+0.5)
120 H2=INT((H6+H7+H8+H9+H10+H11+H12+0.5)
130 PRINT USING "#.#";DA:HR:PRINT USING "#.#";TD:TN:T1:T2:PRINT USING"###.#";TA:TU:TT:TB:PRINT USING"
###";RT
140 LPRINT USING"###";DA:HR:PRINT USING"###.#";TD:TN:T1:T2:LPRINT USING"###.#";TA:TU:TT:TB:LPRINT
USING"###";RT
150 DA=VAL(MID$(A4,2,3)):HR=VAL(MID$(A4,5,20)):GOTO 40
160 IF MID$(A4,1,4)=""2015" THEN TD=VAL(MID$(A4,5,20)):GOTO 40
170 IF MID$(A4,1,4)=""2021" THEN TN=VAL(MID$(A4,5,20)):GOTO 40
180 IF MID$(A4,1,4)=""2019" THEN TL=VAL(MID$(A4,5,20)):GOTO 40
190 IF MID$(A4,1,4)=""2022" THEN TM=VAL(MID$(A4,5,20)):GOTO 40
200 IF MID$(A4,1,4)=""2016" THEN TX=VAL(MID$(A4,5,20)):GOTO 40
210 IF MID$(A4,1,4)=""2017" THEN TY=VAL(MID$(A4,5,20)):GOTO 40
220 IF MID$(A4,1,4)=""2018" THEN TZ=VAL(MID$(A4,5,20)):GOTO 40
230 IF MID$(A4,1,4)=""2020" THEN TA=VAL(MID$(A4,5,20)):GOTO 40
240 IF MID$(A4,1,4)=""2027" THEN TB=VAL(MID$(A4,5,20)):GOTO 40
250 IF MID$(A4,1,4)=""2028" THEN TU=VAL(MID$(A4,5,20)):GOTO 40
260 IF MID$(A4,1,4)=""2029" THEN TT=VAL(MID$(A4,5,20)):GOTO 40
270 IF MID$(A4,1,4)=""5000" THEN H0=VAL(MID$(A4,5,20))*7645:GOTO 40
280 IF MID$(A4,1,4)=""5002" THEN H2=VAL(MID$(A4,5,20))*8532:GOTO 40
290 IF MID$(A4,1,4)=""5003" THEN H3=VAL(MID$(A4,5,20))*8532:GOTO 40
300 IF MID$(A4,1,4)=""5005" THEN H5=VAL(MID$(A4,5,20))*1706:GOTO 40
310 IF MID$(A4,1,4)=""5001" THEN H1=VAL(MID$(A4,5,20))*3413:GOTO 40
320 IF MID$(A4,1,4)=""5004" THEN H4=VAL(MID$(A4,5,20))*2560:GOTO 40
330 IF MID$(A4,1,4)=""5006" THEN H6=VAL(MID$(A4,5,20))*6826:GOTO 40
340 IF MID$(A4,1,4)=""5007" THEN H7=VAL(MID$(A4,5,20))*6826:GOTO 40
350 IF MID$(A4,1,4)=""5009" THEN H9=VAL(MID$(A4,5,20))*6826:GOTO 40
360 IF MID$(A4,1,4)=""5010" THEN H8=VAL(MID$(A4,5,20))*6826:GOTO 40
370 IF MID$(A4,1,4)=""5008" THEN H8=VAL(MID$(A4,5,20))*3413:GOTO 40
380 IF MID$(A4,1,4)=""5012" THEN H5=VAL(MID$(A4,5,20))*1707:GOTO 40
390 IF MID$(A4,1,4)=""5013" THEN H0=VAL(MID$(A4,5,20))*2560:GOTO 40
400 IF MID$(A4,1,4)=""1032" THEN 60500 720:RT=-D*28.68:GOTO 40
410 6000 40
420 PRINT "EOF"
430 CLOSE 1
440 CLOSE 2
450 END
720 D4=0(D4(A4,5,20):DL=LEN(D4)
730 FOR I=1 TO DL:CF=MID$(D4,I,1):IF CF="E" THEN 750 ELSE IF CF="-" THEN 760
740 NEXT I
750 D=VAL(CF):RE TURN
760 D=-VAL(D4,I+1,DL):D=-VAL(D4):RETURN

```

SPLINE

```

100 DIM X(12), Y(12), Z(12), D(12), Z(12)
25 PI=3.1415927/180
30 DATA 10.0, -10.0, 0.0, 11.6, 20.0, 23.45, 20.6, 12.3, 0.0, -10.5, -19.8, -23.45
40 DATA -0.19, -0.23, -0.123, 0.02, 0.06, -0.025, -0.103, -0.051, 0.113, 0.155, 0.235, 0.033
50 DATA 190, 380, 375, 360, 350, 345, 344, 351, 365, 378, 387, 391
60 DATA 0.142, 0.144, 0.156, 0.18, 0.196, 0.205, 0.207, 0.201, 0.177, 0.16, 0.149, 0.142
70 DATA 0.058, 0.05, 0.071, 0.097, 0.121, 0.134, 0.136, 0.122, 0.092, 0.073, 0.053, 0.057
80 N=12
90 FOR DD=1 TO 5
100 FOR I=1 TO 12 : X(I)=I : READ Y(I): NEXT I
110 GOSUB 16000
120 IF DA=52 AND DA=80 THEN X=2+(DA-52)/28
130 IF DA=80 AND DA=111 THEN X=3+(DA-80)/31
140 GOSUB 18000
150 ON DD GOTO 170, 180, 190, 200, 210
170 DE(DA)=Y*PI : GOTO 220
180 DE(DA)=Y : GOTO 220
190 AP(DA)=Y : GOTO 220
200 BE(DA)=Y : GOTO 220
210 CP(DA)=Y :
220 NEXT DD
230 GOTO 240 TO 104
240 PRINT USING "###.###": PA: PRINT USING "###.###": DE(DA): PRINT USING "###.###": AP(DA): PRINT USING "###.###": BE(DA):
250 NEXT DA
260 READ LA, LU, TZ, CN, P
270 DATA 0.738, 82.90666667, 5, 1.0, 1.0
280 OPEN "I", 2, "WEATHER"
290 OPEN "O", 1, "WEATHER"
300 IF EOF(1) THEN 530
310 INPUT DE, DA, HR, VE, TD, TG, RH, RV, AH, TN, TL, TM, TB, TH, HL, HM, HZ, HH, HS, HU
320 AI=1/AN(LA)*TAN(DE(DA))
330 HX=ATH(AI/50*(AI*AI+1))+1.5708
340 U=1.624HZ
350 S=12-U*ET(DA)-TZ+U/15
360 HY=15*(OR-12+TZ+ET(DA))-(LO)
370 IF HR=7 THEN HZ=0: RH=0: RN=0: DN=0: RD=0: IN=0: IH=0: ID=0: CC=0: CF=0: K=0: IT=0: GOTO 500
380 IF HR=18 THEN HZ=0: RH=0: RN=0: DN=0: RD=0: IN=0: IH=0: ID=0: CC=0: CF=0: K=0: IT=0: GOTO 500
390 IF NOT 1 THEN RH=0: RN=0: DN=0: RD=0: CC=0: CF=0: K=0: GOTO 500
395 I4=HY/57.27
400 CZ=5/IN(LA)*SIN(DE(DA))+COS(LA)*COS(DE(DA))*COS(HM)
410 S1=ATH(CZ/SIN(-CZ*VZ+1))

```

Reproduced with permission of the copyright owner. Further reproduction prohibited without permission.

APPENDIX - D
FAN DEPRESSURIZATION TEST

FAN DEPRESSURIZATION TEST

D.1 INTRODUCTION

The test house was selected for the purpose of energy analysis due to its energy conservation features and expected tighter construction. However, during the analysis of test data it was found that the house was not a tight structure and was highly sensitive to strong winds directed towards the southern exposure of the building. Based on these observations, it was suspected that the southern exposure of the building contained unidentified leakage openings which caused uncontrolled infiltration under the influence of strong winds. In order to identify these openings, and to determine the leakage characteristics of the building, it was decided to perform a fan depressurization test on the house.

In a fan depressurization test, a pressure difference is created across the building envelope by mechanically exhausting air from the house. This is accomplished by means of a device which consists of a variable speed fan/motor assembly fitted with a calibrated nozzle. The unit is temporarily sealed in an exterior door opening with the help of an adjustable frame and clamps. During a depressurization test, the air exhausted from the house is replaced by outdoor air which enters through the cracks and holes around the building. The pressure difference across the building envelope and the air flow measured at the venturi are used to determine the leakage

characteristics of the building. In order to eliminate the weather effects, a fan test is carried out under conditions of low wind and a minimum indoor-outdoor temperature difference.

D.2 INFILTROMETER

A portable infiltrometer unit, purchased from Ener-Corporation Management Ltd, was used to perform a depressurization test on the house. The unit became available in the early fall of 1982. It consisted of the following component parts:

1. Fibre glass panel with variable speed fan/motor assembly.
2. A precalibrated fibre glass nozzle.
3. An adjustable aluminum frame.
4. Aluminum frame to door frame clamps.
5. Data processing and control centre.

A schematic of the infiltrometer unit is shown in Figure D.1. The unit was simple in construction and could be sealed in the exterior door opening of the house with the help of an aluminum frame and adjustable clamps. The data processing and control unit contained a Texas Instrument TI-59 programmable calculator which could be used at the site to calculate the flow characteristics of the test house. The pressure data recorded during the fan test, could be used in the Ener-Seal program to determine the flow characteristics of the house in SI units. This

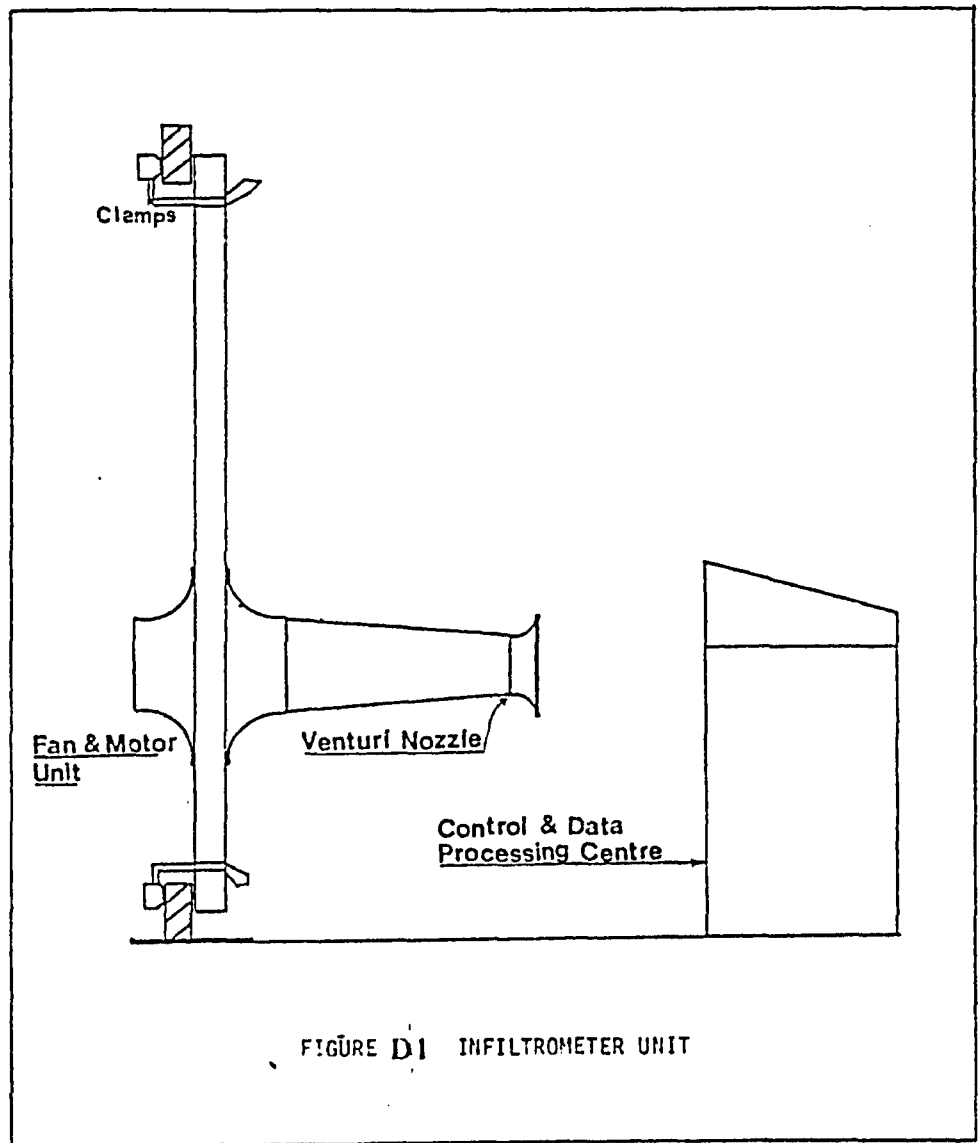

program was stored on a magnetic card and was read into the programmable calculator. A listing of this program, translated into FORTRAN language is provided in Table D.1. The infiltrometer was calibrated in SI units, therefore to maintain uniformity, the results of the fan tests are expressed in the same units.

D.3 FAN TEST

The fan test was conducted on October 2, 1982, under favorable weather conditions. The wind speed was about 2.2 meter per second (5 m.p.h) from the south-west and the outdoor temperature was 14 degrees C. The indoor temperature was 15 degrees C. The infiltrometer was sealed on the main entrance of the test house and two depressurization tests were performed on the house.

The following observations were made during the first fan test:

In the living room, the leakage openings were identified at locations listed below.

1. All around the fireplace moulding.
2. Air vent in the top of the fireplace.
3. Shutter strap openings located above the glazings in the south, east and north walls.
4. Electrical outlet for the baseboard heater located in the south wall .
5. Cracks around the patio doors .

TABLE -D-1
LISTING OF ENERSEAL PROGRAM

```

1. //INFTEST JOE (G1310CW2AC), 'TAHIQ', CLASS=W
2. // EXEC WATFIV
3. //GO.SYSIN CC *
4. SJOB WATFIV G13100W2A0 TARIQ
5. REAL N, PRES(2,20), G(20), LFRES(20), LQ(20), LQS(20), LPRESQ(20)
6. DO 5 KK=1,1
7. READ, A, V, TEMP, P, M
8. DO 4 K=1,1
9. IF (K .EQ. 1) THEN CC
10. PRINT, 'BEFCRE SEALING'
11. ELSE DO
12. PRINT, 'AFTER SEALING'
13. END IF
14. READ, ((PRES(I,J), J=1,M), I=1,2)
15. DO 1 I=1,M
16. Q(I)=(14.655*PRES(1,I)**.5092)*(254/(TEMP+273))*(P/101.3)*1.05
17. 1 PRINT, PRES(2,I), PRES(1,I), Q(I)
18. SLP=SLC=SLCS=SLFS=PPDFQ=0.0
19. DO 2 J=1,M
20. LPRES(J)=ALCG10(PRES(2,J))
21. LQ(J)=ALOG10(Q(J))
22. LQS(J)=LQ(J)**2
23. LPRESQ(J)=LPRES(J)**2
24. SLP=SLF+LPRESQ(J)
25. SLQ=SLC+LQ(J)
26. SLPS=SLPS+LPRESQ(J)
27. SLQS=SLQS+LQS(J)
28. PPDFC=PPDFC+LPRES(J)*LQ(J)
29. 2 CCNT INUE
30. N=(M*PPDFC-SLP*SLQ)/(M*SLFS-SLP**2)
31. C=(SLC*SLPS-PPDFC*SLP)/(M*SLPS-SLP**2)
32. C=(10*C)/1000
33. SXX=M*SLPS-SLP**2
34. SYY=M*SLQS-SLQ**2
35. SXY=M*PPDFC-SLP*SLC
36. R=(SXY**2/(SXX*SYY))**.5
37. RHO=P/(.2872*(TEMP+273))
38. ELA=(C*(10**N))/(.59*((10**2/RHO)**.5))
39. ENFIL=C*(4**N)*36/V*100
40. QFIFTY=C*(50**N)*36/V*100
41. REL=C*(10**N)/A*1000
42. PRINT 20, R, ELA, CFIFTY, ENFIL, C, REL, N
43. 20 FORMAT (' ', 1X, F9.7, 1X, F9.7, 1X, F9.7, 1X, F9.7, 1X, F9.7, 1X, F9.7
44. * , 1X, F9.7, 1X, F9.7)
45. 4 CCNT INUE
46. PRINT 10
47. 10 FORMAT (' ')
48. 5 CCNT INUE
49. STOP; END
50. $ENTRY
51. 224, 373.12, 15.99, 26.6
53. 535.620, 730, 1100, 1630, 2350
54. 10, 12, 14, 20, 26, 38

```

The master bedroom was found to be relatively tight except for leakage detected through the shutter strap openings located in the north wall.

The two lower bedrooms had significant air leakage. The dominant leakage openings in these rooms were concentrated on the south and the east walls and were identified as follows:

1. Trombe wall leakage directly into the bedrooms caused by an open passage into the ventilated joist space under the balcony overhang.
2. An air vent located in the ceiling of one of these rooms connected to the fireplace assembly located on the upper level.
3. Shutter strap openings located in the south walls of these rooms.
4. Cracks around the patio doors.

In the underground portion of the house, the leakage openings were identified around the following locations.

1. Sewer pipes and a plastic vent in the utility room.
2. All electrical conduits entering the fuse box located in the utility room.
3. An air vent located in the ceiling of the lower floor's bathroom.

D.4 RESULTS

Realizing that significant air leakage occurred in the lower bedrooms, a second fan test was conducted by isolating these spaces from the rest of the house. This was done by closing the interior doors of these rooms and placing rugs between the floor and the door cracks.

The pressure data recorded during the two fan tests are listed in Tables D.2 & D.3 . These pressure data along with the heated volume of the building V 373.12 - M³, exposed surface area A 224 - M², indoor temperature T 15 degrees C and the atmospheric pressure P 99.26 KP were input to the Ener-Seal program to calculate the flow characteristics of the test house for the two test conditions. The total equivalent leakage area of the house ELA - M², flow rate through the building at a pressure differential of 50 pascals Q_f , flow coefficient C and the flow exponent n , determined from the Ener-Seal program are listed in Table D.4 .

The flow coefficient C is the flow rate through a building at a unit pressure difference across a building envelope. It represents the leakage characteristics of leakage openings around a building envelope. Higher value of the leakage coefficient represents a leakier structure and vice versa. The flow exponent n is the slope of the leakage characteristic curve of a house. It represents the characteristics of flow taking place through the leakage openings in a building. The flow coefficient varies in between 0.5 and 1. It is assumed that the flow is laminar if

TABLE D.2

PRESSURE DATA FOR THE FIRST FAN TEST

Serial No	House Pressure (Pascals)	Nozzle Pressure (Pascals)
1	10	535
2	12	620
3	14	730
4	20	1100
5	28	1630
6	38	2350

TABLE D.3

PRESSURE DATA FOR THE SECOND FAN TEST

Serial No	House Pressure (Pascals)	Nozzle Pressure (Pascals)
1	20	560
2	30	940
3	40	1150

TABLE D.4

LEAKAGE DATA FOR THE TEST HOUSE

Test No.	Equivalent Leakage Area ² ELA - M	Air Changes Per Hour [*] Qf	Leakage Coefficient ^{**} C	Flow Exponent ^{***} n
1	0.1537	8.98	0.09896	0.57
2	0.1123	6.16	0.07860	0.54

* - Air change rate at a pressure difference of 50 pascals.

** - Flow coefficient (M / Sec at a unit pressure difference)³

*** - Flow exponent (Dimensionless)

the the flow exponent is 1, and completely turbulent or orifice flow if n is 0.5. It has been found experimentally (34) that in reality the value of n is in between the above specified range, depending upon the predominant flow regime. Each house will have a unique flow coefficient and flow exponent. The flow coefficient and the flow exponent are useful parameters as they can be used without any additional information to generate the leakage characteristics curve for a house.

The leakage characteristic curves of the house are shown in Figure D.2 for two test conditions. The higher value of flow coefficient C (0.099), obtained for the first fan test indicate that the house was a very leaky structure. The results obtained for the second fan test, when the lower two bedrooms were isolated from the house, however, indicate that the flow coefficient C was considerably decreased to (0.0786), confirming that the dominant leakage openings were located in the lower bedrooms. A percentage comparison of leakage areas, obtained from the two tests, also indicate a 30 percent reduction in the total equivalent leakage area of the house when the lower bedrooms were isolated. The flow exponents n , obtained from the two fan tests, were within the vicinity of 0.5, indicating that the flow characteristics of the house were nearly in the turbulent regime.

The results of the fan test could not directly be used to obtain the natural infiltration rate of the test-house. Models are, however, available which correlate the fan test results

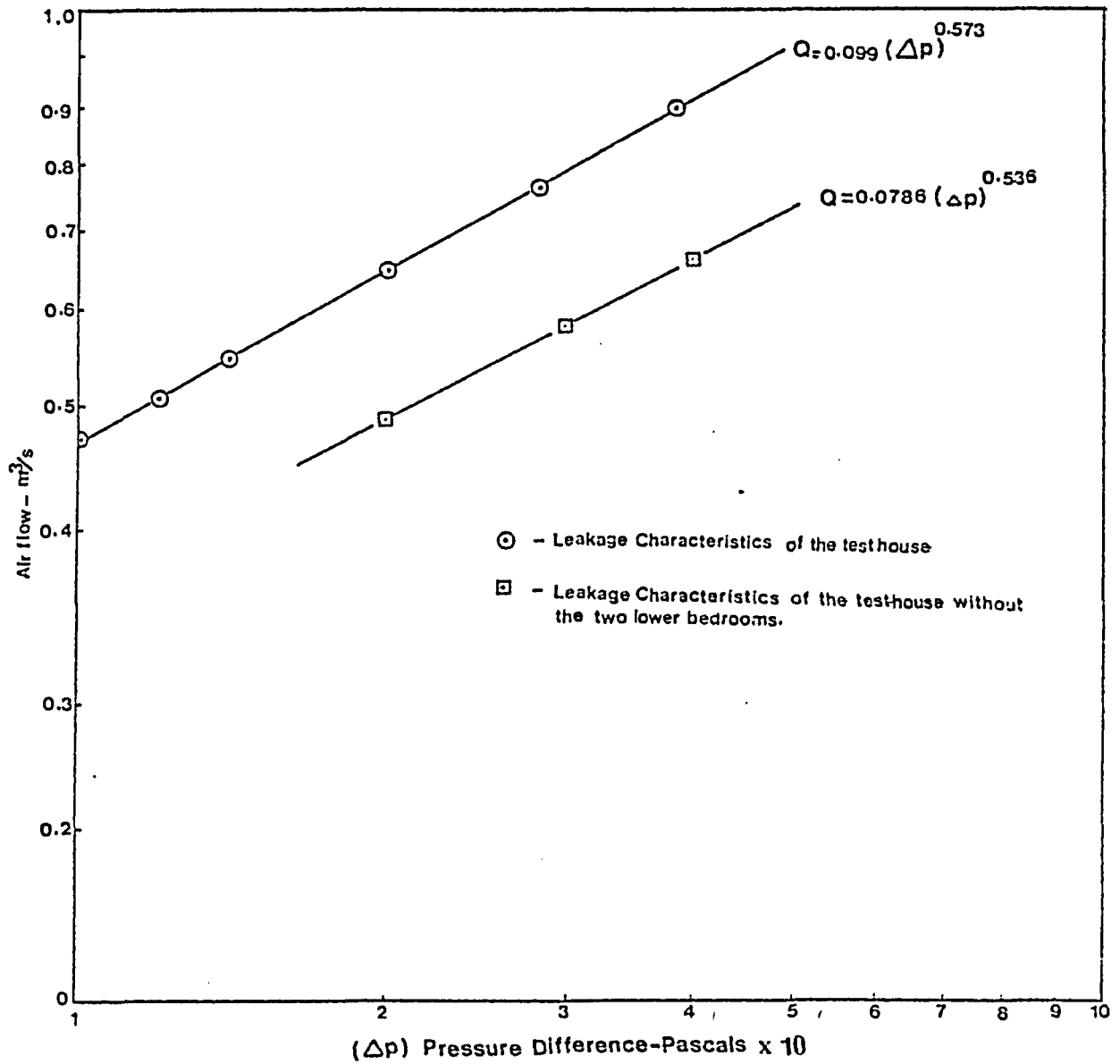

FIGURE D.2 LEAKAGE CHARACTERISTICS OF THE TEST HOUSE

to the natural infiltration rates for different combinations of weather conditions. M.H.Sherman and D.T.Grimsrud (28) have developed a methodology which can be used to determine the infiltration rates for various residences located in the urban, suburban or rural locations. This methodology is based on the assumption of uniform leakage openings in the building envelope and is applicable to single zone building models. In order to make use of this methodology the total equivalent leakage area of the house must be known. The total equivalent leakage area of the test house, determined from the first fan test was used in this methodology to obtain the natural infiltration rate of the house for average weather conditions at the test site. Calculation details are presented in Table D.5. Based on an average wind speed of 4.47 meters per second (10 miles per hour) and an indoor-outdoor temperature difference of 19 degrees C (35 degrees F), the infiltration rate of the house was found to be 2.30 air changes per hour. It is evident that this infiltration rate is extremely high for an energy efficient house. The results further indicated that the house exchanged 8.98 air changes per hour at a pressure difference of 50 pascals. This air change rate was compared to the leakage rates of several houses tested by the National Research Council of Canada (26). The test data is listed in Table D.6. This comparison showed that the leakage rate of the house are comparable to pre 1945 constructions.

D.5 CONCLUSIONS

The following conclusions were drawn on the basis of the fan

TABLE - D.5

CALCULATION OF INFILTRATION RATE FOR THE TEST HOUSE
USING FAN TEST RESULTS IN GRIMSRUD'S METHODOLOGY

Infiltration in the wind regime:

$$Q_w = f_w^* \times A_o \times V$$

where f_w^* = reduced wind parameter

$$= C' \times (1 - R) \times \left\{ \frac{(H / 10)}{(H' / 10)} \right\}$$

C' = Generalised shielding coefficient

$$= 0.34$$

R = Fraction of effective leakage area that is horizontal

$$= 0.1$$

H = Height of the ceiling

$$= 5.2 \text{ m.}$$

H' = Height of the wind speed measurement.

$$= 6.1 \text{ m.}$$

$$f_w^* = 0.31067$$

A_o = Total equivalent leakage area of the house

$$= 0.1537 \text{ m.}^2$$

V = Measured wind speed

$$= 4.47 \text{ m / sec.}$$

$$Q_w = (0.31067) \times (0.1537) \times (4.47)$$

$$= 0.2135 \text{ m}^3 / \text{sec.}$$

Infiltration in the stack regime.

$$Q_s = f_s \times A_o \times (\text{DEL T})^{0.5}$$

where f_s = reduced stack parameter

$$\left\{ \frac{1 + R / 2}{3} \right\} \times \left\{ 1 - \frac{X^{1.5}}{(2 - R)} \right\} \left\{ \frac{g \times H}{T_i} \right\}^{0.5}$$

R = fraction of effective leakage area that is horizontal
= 0.1

X = fractional difference between ceiling and floor leakage
= 0.1

g = acceleration due to gravity
= 9.8 m / sec.

T_i = indoor temperature
= 294 K

DEL T = indoor - outdoor temperature difference
= 19.3 K

f_s = 0.145

$$Q_s = (0.145) \times (0.1537) \times (19.3)^{0.5}$$

$$= 0.098 \text{ m}^3 / \text{sec.}$$

The wind and stack infiltrations were superimposed to obtain the total infiltration.

$$Q_t = \sqrt{(Q_w^2 + Q_s^2)}$$

$$Q_t = \sqrt{(0.2135^2 + 0.098^2)}$$

$$= 0.235 \text{ m}^3 / \text{sec.}$$

Air Change Rate for the House

$$\text{A.C.H.} = \frac{Q_t}{V_0} \times 3600$$

where V_0 = Total interior volume of the house.
 $= 373.12 \text{ m}^3$

$$\text{A.C.H.} = \frac{(0.235) \times (3600)}{373.12}$$

$$= 2.27 \approx 2.3$$

TABLE D.6

LEAKAGE RATES OF DIFFERENT HOUSES TESTED BY
THE NATIONAL RESEARCH COUNCIL OF CANADA

House Description	Air Change Rate At 50 Pascals.
Leakiest Houses	33.33
Houses Built Pre 1945	10.40
Houses Built in 1945-60	4.60
Houses Built in 1961-80	1.50
Tightest House.	0.37

test results and the leakage detected in various spaces of the test house.

1. The house did not comply with the requirements of an energy conservation design due to its leaky construction. Based on Grimsrud's model (28), the house had a natural natural infiltration of 2.3 air changes per hour for an average wind of 4.47 meters per second (10 miles per hour) and a temperature difference of 19 degrees C (35 degrees F).
2. The fan test indicated that the house had 8.98 air changes per hour at a pressure difference of 50 pascals which was close to the leakage rates for the houses built before 1945.
3. The major leakage openings of the house were located in the south and east walls. This confirmed the sensitivity of the house to strong southerly winds.
4. The dominant leakage opening was a large ventilation grille which was connected to the Trombe wall air space.
5. The major source of leakage was into the lower two bedrooms (See Fig. D.2) and these were therefore classified as loose construction. The living room, utility room and storage room were classified as average construction although significant leakage was noted. The master bedroom was classified as tight construction since relatively minor leakage was detected.

APPENDIX E

CALCULATION OF EFFECTIVE U-VALUES FOR THE
UNDERGROUND WALLS AND FLOORS

E.1 DOE-2 BASEMENT HEAT LOSS MODEL

The DOE-2 basement heat loss model is based on the assumption of steady state heat transfer. Heat loss through the underground surfaces is calculated on the basis of an effective U - value concept using the following equation.

$$Q = U\text{-eff} \times A \times (T_b - T_g) \text{ ----- (E.1)}$$

where U-eff = Effective heat transmission coefficient of
underground surface. Btu/Hr.Ft. F.²

A = Total area of underground surface. Ft.²

T_b = Indoor temperature of the basement air degrees F.

T_g = Average monthly ground temperature degrees F.

The effective U-value concept has been introduced to avoid over-estimation of the basement heat losses when the total surface areas of the underground walls and floors are used (as in the case of custom weighting factor calculation). It accounts for the thermal resistance of soil surrounding the sub-grade surfaces. The effective U-value is obtained by adding a false layer of insulation on the exterior of the underground surfaces. The resistance of false insulation should , however, be sufficient to simulate the effect of thermal resistance offered by the soil.

The effective U-value concept of the DOE-2 program is quite flexible. It allows the user to model basement heat losses according to a method of his own choice. This is done by supplying the program with an effective U-value that would result

in the same heat loss as is obtained by the selected procedure using similar basement and ground temperatures.

In the modelling of the test-house, ASHRAE procedures were used to determine heat loss through underground surfaces of zone-3 and zone-4. Design heat loss through these surfaces was calculated in Appendix - A and will not be repeated. These heat loss values along with appropriate basement and ground temperatures were used in equation E.1 to obtain effective U-values for the underground walls and floors. These effective U-values were used to make necessary modifications in the insulation levels of the underground surfaces. The detailed calculations for the effective U-values are presented in the following sections.

E.2 EFFECTIVE U-VALUE FOR UNDERGROUND WALLS

The underground walls of zone-3 and zone-4 were identical in construction. For simplicity sake, design heat loss through these surfaces was summed and used to obtain a single effective U-value.

$$U\text{-effective} = \frac{Q_{\text{design}}}{A \times (T_b - T_g)}$$

where Q design = Design heat loss through the underground walls (see Appendix-A)

$$= 464.00 + 1137.00$$

$$= 1601 \text{ Btuh.}$$

A = Total surface area of underground walls

$$= 606.00 \text{ Ft.}^2$$

Tb = Basement temperature

= 70 F.

Tg = Average monthly ground temperature

= 41 F.

$$U\text{-effective} = \frac{1601.00}{606.00 \times (70 - 41)^2} \\ = 0.091 \text{ Btuh / Ft. F}$$

U-actual = Actual heat transmission coefficient of underground walls without the thermal resistance of soil²
= 0.088 Btu/Hr Ft. F.

Since the actual U-value of the underground walls was almost equal to the effective value, it was not necessary to modify their insulation levels.

E.3 EFFECTIVE U-VALUE FOR THE CONCRETE FLOOR (ZONE-3)

The concrete floor of zone-3 was split into three sections to calculate the design heat loss. These heat loss values were summed, and used to obtain an average effective U-value for the entire floor.

Q design = Design heat loss through the concrete floor
(see Appendix-A).

= 2984.60 Btuh.

A = Total surface area of the floor.

²
= 640.00 Ft.

Tb = 70 F.

Tg = 41 F.

$$U\text{-effective} = \frac{2984.60}{640.0 \times (70 - 41)^2}$$

$$= 0.160 \text{ Btu /Hr. Ft. F.}^2$$

$$\begin{aligned} R\text{-effective} &= \frac{1}{U\text{-effective}} \\ &= 6.25 \text{ Hr.Ft. F}^2 / \text{Btu.} \end{aligned}$$

$$\begin{aligned} R\text{-actual} &= R \text{ film} + R \text{ concrete} \\ &= 0.91 + 0.44 \\ &= 1.35 \text{ Hr.Ft. F}^2 / \text{Btu} \end{aligned}$$

R-additional = Additional resistance required to obtain effective U value.

$$\begin{aligned} &= R\text{-effective} - R\text{-actual} \\ &= 6.25 - 1.35 \\ &= 4.9 \approx 5 \end{aligned}$$

The preceding analysis showed that a false resistance of R 5 was required below the concrete floor to obtain the required effective U-value of 0.16 Btu /Hr. FT. F.² Accordingly, the floor construction was modified for input to the DOE-2 program.

E.4 EFFECTIVE U-VALUE OF CONCRETE FLOOR (ZONE-4)

Q design = Design heat loss through the concrete floor
(see Appendix-A)

$$= 361.00 \text{ Btuh.}$$

A = Total surface area of the floor.

$$= 384.0 \text{ Ft.}^2$$

Tb = 70 F

Tg = 41 F

$$\begin{aligned} U\text{-effective} &= \frac{361.00}{384.0 \times (70 - 41)} \\ &= 0.0324 \text{ Btu /Hr. Ft. F}^2 \end{aligned}$$

$$R\text{-effective} = \frac{1}{U\text{-effective}}$$

$$= 30.864 \text{ Hr Ft. F}^2 / \text{Btu.}$$

$$R\text{-actual} = R \text{ film} + R \text{ concrete}$$

$$= 0.91 + 0.44$$

$$= 1.35 \text{ Hr.FT. F}^2 / \text{Btu.}$$

$$R\text{-additional} = R\text{-effective} - R\text{-actual}$$

$$= 30.864 - 1.35$$

$$= 29.514 \approx 30$$

The analysis showed that an additional R 30 dummy insulation was required to be added in the floor construction to obtain an effective U-value of 0.0324 Btu/Hr.Ft. F.² The floor construction was hence modified for input to the DOE-2 program.

APPENDIX - F
THE DOE WEATHER PROCESSOR INPUT LISTINGS

```

3626.          SUBROUTINE OTHER
3627.
3628.          C THIS ROUTINE READS ACTUAL ON SITE WEATHER DATA RECORDED
3629.          C IN WHEATLY FOR CONVERSION TO DOE 2.1 FORM. IT IS TO BE RUN
3630.          C WITH DOE 2.1 WEATHER PROGRAM WHEN RECORDED SOLAR DATA IS TO
3631.          C USED IN DOE 2.1
3632.          C AUTHOR:      N W WILSON
3633.          C                DEPARTMENT OF MECHANICAL ENGINEERING
3634.          C                UNIVERSITY OF WINDSOR
3635.          C                WINDSOR, ONTARIO
3636.          C                CANADA
3637.          C                PHONE 519-253-4232 EXT 254
3638.
3639.          C
3640.          COMMON/TIMES/IMNTH, ICAY, IHQLR, IREXO, IDXC, IDAYL
3641.          COMMON/FILES/INFIL, CUTFIL, INWTH, OUTWTH, SOLWTH, MFICHE
3642.          INTEGER      OUTFIL, OLTWTH, SOLWTH
3643.          COMMON/GETCF/ IEOF
3644.          LOGICAL      IEOF
3645.          COMMON/PACKEC/NTZ, ISTAT, XLAT, XLONG, IYR, INTINT, DDBT, IBEGH
3646.          COMMON/PARAMS/STOPIT, VERS, FIRST, NEWPAK
3647.          LOGICAL      STOPIT, FIRST, NEWPAK
3648.          COMMON/PCKINT/KYR, KSTAT, CN(12), TG(12)
3649.          COMMON/RAWCAT/ICRY(24), IWET(24), IDEW(24), IPRESS(24),
3650.          -           IWNCSP(24), ICLAMT(24), ISOL(24), IDN(24),
3651.          -           IWNDIR(24), ICLTY(24), IRN(24), ISN(24), ICLTY1(24)
3652.          COMMON/REPCRC/IBEGM, IENDM
3653.          COMMON/SKIPFY/ FIRSTS
3654.          LOGICAL      FIRSTS
3655.          COMMON/UNDEF/IUNDEF, UNDEF
3656.
3657.          C
3658.          C
3659.          C
3660.          C
3661.          C
3662.          C
3663.          C
3664.          C
3665.          C
3666.          C
3667.          C
3668.          C
3669.          C
3670.          C
3671.          C
3672.          C
3673.          C
3674.          C
3675.          C
3676.          C
3677.          C
3678.          C
3679.          C
          INTEGER DOY
          DATA DOY/0/
          IF (.NOT.FIRSTS) GC TO 3000
          FIRSTS=.FALSE.

3000      CONTINUE
          DOY=DOY+1
          IF (DAY.EQ.CAYL) RETURN
          IF (DOY.GT.365) GC TO 3001
          IF (DOY.GE.67.AND.CCY.LE.74) GO TO 10
          IF (DOY.GE.79.AND.CCY.LE.93) GO TO 10
          IF (DOY.GE.96.AND.CCY.LE.104) GO TO 10

          DO 100 I=1,24
          IDRY(I)=32
          IWET(I)=32
          IDEW(I)=32
          IPRESS(I)=2992
          IWNCSP(I)=15
          ICLAMT(I)=0

          IF (I.LT.7.OR.I.GT.18) GO TO 110

```

```

3680.          ISCL(I)=200
3681.          IDN(I)=JJO
3682.          GO TO 120
3683.
3684.          110          ISCL(I)=0
3685.          IDN(I)=0
3686.          120          I#NDIR(I)=0
3687.          ICLTY(I)=1
3688.          IRN(I)=0
3689.          ISN(I)=0
3690.          100          ICLTY1(I)=1
3691.          RETURN
3692.          10          II=1
3693.          IE=24
3694.          IF (DOY.EQ.67) II=0
3695.          IF (JUY.EQ.74) IE=15
3696.
3697.          IF (DOY.EQ.79) II=0
3698.          IF (DOY.EQ.93) IE=14
3699.
3700.          IF (DOY.EQ.96) II=0
3701.          IF (DOY.EQ.104) IE=14
3702.
3703.          DO 30 I=II,IE
3704.          READ (5,20) ICAR, IDN(I), ISCL(I), IHR, I#NDSP(I), IDRY(I),
3705.          I#WDIR(I)
3706.
3707.          20          FORMAT (3I3,4I2)
3708.          WRITE(6,21) I, IHR, DOY, ICAR, IDN(I), ISCL(I), I#NDSP(I),
3709.          IDRY(I), I#WDIR(I), I#MTH, ICAY
3710.
3711.          21          FORMAT (1H,11I5)
3712.
3713.          IWET(I)=IDRY(I)
3714.          IDEW(I)=IDRY(I)
3715.          I#PRECIP(I)=2*92
3716.          ICLAMT(I)=0
3717.          ICLTY(I)=1
3718.          IRN(I)=0
3719.          ISN(I)=0
3720.          ICLTY1(I)=1
3721.
3722.          30          CONTINUE
3723.          RETURN
3724.
3725.          3001          ICONF=.TRUE.
3726.          RETURN
3727.          END
3728.          INTEGER FUNCTION ICONF(ICEL)
3729.          FAR=FLOAT(ICEL)*1.3 +32.
3730.          ICONF=FAR
3731.          IF(FAR.LT.0) GO TO 1
3732.          IF((FAR-FLOAT(ICONCF)).GE.0.5) ICONF=ICONCF+1
3733.          RETURN
3734.          1          IF(FAR-FLOAT(ICONCF).LT.-0.5) ICONF=ICONCF-1
3735.          RETURN
3736.          END
3737.          //GO.FT01F001 DO DISP=(CLD,KEEP),UNIT=3330.
3738.          // DSN=MENG.DOE2.WEATH.WEATLY.
3739.          // VOL=SER=DISK01.
3740.          // SPACE=(CYL,(1,1),RLSE),DCB=(RECFM=VBS,LRECL=6204,BLKSIZE=12412)
3741.          //GO.FT11F001 DO DSN=CJCL.DISP=(NEW,PASS),UNIT=SYSDA.
3742.          // SPACE=(CYL,(1,1),DCB=(RECFM=VBS,LRECL=32,BLKSIZE=524)
3743.          //GO.SYSIN DD *
3744.          PACK
3745.          WHEATLY , ONTARIO
3746.          OTHER -999 -999
3747.          1. 1. 1. 1. 1. 1. 1. 1. 1. 1. 1.
3748.          30. 30. 41. 41. 46. 46. 46. 46. 46. 46. 46.
3749.          07 0 0 0 51814
3750.          07 0 0 1 51814
3751.          07 0 0 2 52014
3752.          07 0 0 31235 0
3753.          07 0 0 41426 0
3754.          07 0 0 51527 1
3755.          07 0 0 61527 0
3756.          07 0 0 71728 0
3757.          07 0 12 31829 0
3758.          07 0 28 91930 0
3759.          07 47 88101731 0

```

3760.	67	20	84	11	53	2	1
3761.	67	127	179	121	0	34	0
3762.	67	179	208	13	6	36	0
3763.	67	112	162	14	5	39	0
3764.	67	0	52	15	5	31	4
3765.	67	0	35	16	5	37	14
3766.	67	0	21	17	5	38	14
3767.	67	0	10	18	6	37	13
3768.	67	0	0	19	7	38	13
3769.	67	0	0	20	6	37	14
3770.	67	0	0	21	6	36	13
3771.	67	0	0	22	5	37	13
3772.	67	0	0	23	5	37	11
3773.	68	0	0	0	4	18	11
3774.	68	0	0	1	4	18	11
3775.	68	0	0	2	4	20	11
3776.	68	0	0	3	11	25	12
3777.	68	0	0	4	12	26	12
3778.	68	0	0	5	13	27	12
3779.	68	0	0	6	13	27	13
3780.	68	0	0	7	14	23	13
3781.	68	0	12	8	16	24	13
3782.	68	0	28	9	16	24	14
3783.	68	47	88	10	14	23	14
3784.	68	20	84	11	13	27	14
3785.	68	127	179	12	8	27	15
3786.	68	179	208	13	10	27	15
3787.	68	112	162	14	10	26	15
3788.	68	0	52	15	10	26	15
3789.	68	0	35	16	10	26	14
3790.	68	0	21	17	8	25	14
3791.	68	0	10	18	8	24	14
3792.	68	0	0	19	7	21	14
3793.	68	0	0	20	6	20	14
3794.	68	0	0	21	4	20	14
3795.	68	0	0	22	4	20	14
3796.	68	0	0	23	4	20	14
3797.	69	0	0	0	4	18	9
3798.	69	0	0	1	4	18	9
3799.	69	0	0	2	4	20	9
3800.	69	0	0	3	11	25	9
3801.	69	0	0	4	12	26	9
3802.	69	0	0	5	13	27	9
3803.	69	0	0	6	13	27	9
3804.	69	0	0	7	14	28	9
3805.	69	0	12	8	16	29	9
3806.	69	0	28	9	16	29	9
3807.	69	47	88	10	14	31	9
3808.	69	20	84	11	13	32	9
3809.	69	127	179	12	8	34	9
3810.	69	179	208	13	10	36	9
3811.	69	112	162	14	4	36	9
3812.	69	0	52	15	4	36	9
3813.	69	0	35	16	4	37	9
3814.	69	0	21	17	4	39	10
3815.	69	0	10	18	5	37	10
3816.	69	0	0	19	6	38	10
3817.	69	0	0	20	5	37	10
3818.	69	0	0	21	5	36	10
3819.	69	0	0	22	4	37	11
3820.	69	0	0	23	5	37	11
3821.	70	0	0	0	5	37	11
3822.	70	0	0	1	5	31	12
3823.	70	0	0	2	9	31	12
3824.	70	0	0	3	6	36	13
3825.	70	0	0	4	6	38	14
3826.	70	0	0	5	8	38	14
3827.	70	0	0	6	7	39	14
3828.	70	0	0	7	6	39	14
3829.	70	0	12	8	9	39	14
3830.	70	0	16	9	9	39	14
3831.	70	0	20	10	8	41	14
3832.	70	0	34	11	8	43	14
3833.	70	0	47	12	7	39	14
3834.	70	0	22	13	6	39	14
3835.	70	0	24	14	5	41	15
3836.	70	0	15	15	4	42	15
3837.	70	0	26	16	4	44	15
3838.	70	0	1	17	5	41	15
3839.	70	0	0	18	5	33	15

```

4481. 104 0 0 0 441 3
4482. 104 0 0 1 533 3
4483. 104 0 0 2 533 3
4484. 104 0 0 3 434 3
4485. 104 0 0 4 333 2
4486. 104 0 0 5 333 2
4487. 104 0 0 6 233 3
4488. 104 52 31 7 333 3
4489. 104108 90 3 438 4
4490. 104176159 9 439 5
4491. 10421921410 341 5
4492. 10413020711 559 9
4493. 104 0 18312 0 710
4494. 10410520213 0 3310
4495. 10429127614 0 3810
4496. LIST
4497. PACKED -999 -999 3 4
4498. END
4499. //

```

APPENDIX - G.1

THE DOE-2 INPUT LISTINGS FOR THE TEST HOUSE
(RESIDENTIAL INFILTRATION METHOD)

```

1. //A836TDOE JOB (G270.CS7.8.9), 'TDOE TARIQ'.CLASS=S,MSGLEVEL=(1,1),
2. // REGION=1500K
3. // EXEC DOE21CWF
4. //STEP04.SYSIN DD *
5. INPUT LOADS ..
6. TITLE LINE-1 *BECKER SOLAR COTTAGE RUN 1 *
7. LINE-2 *--CUSTOM WEIGHTING FACTOR GENERAT --*
8. LINE-3 *INTERNAL GAINS IN ZONE1 *
9. LINE-4 *TROMBE WALL MODELLED AS EXTR WALL *
10. ..
11.
12. $-----HEADING-----$
13.
14. DIAGNOSTIC CAUTIONS ..
15. ABORT ERRORS ..
16. RUN-PERIOD MAR 10 1982 THRU MAR 15 1982
17. MAR 22 1982 THRU MAR 25 1982
18. MAR 28 1982 THRU APR 02 1982
19. APR 08 1982 THRU APR 13 1982 ..
20.
21. BUILDING-LOCATION LAT=42.30 LON=82.9 T-2=5
22. ALT=637. AZ=-24
23. ..
24.
25. $-----SCHEDULE-----$
26.
27. INT-LDS-1=SCHEDULE THRU DEC 31 (ALL) (1,24) (1) ..
28.
29.
30. $-----MATERIALS-----$
31.
32.
33.
34. STUD-WALL =MAT TH=.2917 COND=.0667 DENS=32 S-H=.33 $2X4STUD$ ..
35. DRYWALL-1 =MAT TH=.0417 COND=.0925 DENS=50 S-H=.26 $1/2 IN DRYWALLS ..
36. VAPOR-BAR =MAT TH=.0003 COND=.11 DENS=70 S-H=.4 $VAPOR BAR$ ..
37. WALL-INS-1 =MAT TH=.2917 COND=.0238 DENS=.6 S-H=.2 $R12 INSULATIONS ..
38. RIGSTYFM-1 =MAT TH=.125 COND=.0133 DENS=1.5 S-H=.29 $1.5 IN STYRCFOAMS ..
39. FAC-BRIK-1 =MAT TH=.3333 COND=.75 DENS=130 S-H=.22 $4 IN FACE BRIK$ ..
40. CONC-BLK-1 =MAT TH=.833 COND=.78 DENS=36 S-H=.21 $10 IN CONC BLK$ ..
41. CEL-JOIST-1 =MAT TH=.500 COND=.0667 DENS=32 S-H=.33 $2X6 CEL JOIST$ ..
42. SHINGLE-1 =MAT TH=.0203 COND=.0473 DENS=70 S-H=.3 $110 LB SHINGLES ..
43. ASPENITE-1 =MAT TH=.042 COND=.0667 DENS=32 S-H=.33 $3/8 IN ASPENITE$ ..
44. AT-AIR-1 =MAT RES=3.1 $ATTIC AIR SPACES ..
45. CEL-INS-1 =MAT TH=1.0 COND=.0238 DENS=.6 S-H=.2 $R 42 INSULATIONS ..
46. CEL-INS-2 =MAT TH=.5 COND=.0238 DENS=.6 S-H=.2 $R 21 INSULATIONS ..
47. CEL-JOIST-2 =MAT TH=.7 COND=.0667 DENS=32 S-H=.33 $2X8 CEL JOIST$ ..
48. PLY#-1 =MAT TH=.0417 COND=.0667 DENS=34 S-H=.26 $5/8 IN PLYWOODS ..
49. BUILT-RFG-1 =MAT TH=.031 COND=.0946 DENS=70 S-H=.35 $BUILT UP ROOFINGS ..
50. CEDR-DECK =MAT TH=.17 COND=.0670 DENS=32 S-H=.33 $CEDAR DECKINGS ..
51. CEL-INS-3 =MAT TH=.67 COND=.0222 DENS=.6 S-H=.2 $R 30 INSULATIONS ..
52. AIR-SPACE-2 =MAT RES=1.01 $3.5 IN AIR SPACE$ ..
53. AIR-SPACE-3 =MAT RES=0.93 $8 IN AIR SPACE$ ..
54. PLY#-2 =MAT TH=.0834 COND=.0667 DENS=34 S-H=.26 $3/4 IN PLYWOOD$ ..
55. TILE-1 =MAT TH=.0625 COND=.075 DENS=82 S-H=.315 $CARPET-PAD$ ..
56. CONCRETE-1 =MAT TH=.3333 COND=.758 DENS=140 S-H=.2 $4 IN CONCRETE$ ..
57.
58.
59. EXP-POLY-1 =MAT TH=.0167 COND=.0167 DENS=2.2 S-H=.25 $2 IN POLYSTYRENE$ ..
60. CONC-BLK-2 =MAT TH=.5000 COND=.78 DENS=38 S-H=.20 $6-IN CONC BLK$ ..
61.
62. CEDR-PLKS =MAT TH=.083 COND=.0667 DENS=32 S-H=.33 $CEDR PLANKS$ ..
63.
64.
65. SOIL-1 =MAT RES=5.00 $ RESISTANCE OF SCIL BELCW FLOOR $ ..
66.
67. SOIL-2 =MAT RES=30.00 $ RESISTANCE OF SCIL BELCW FLOOR $ ..
68.
69. CAV-INSL =MAT RES=11.0 $ BELOW GRD WALL CAVITY INS Z-3-4 $ ..
70.
71.
72. $-----GLAZING (DOUBLE PANE)-----$
73.
74. GT-WIN-1=GLASS-TYPE P=2 S-C=0.65 G-C=0.62 ..
75. GT-WIN-2=GLASS-TYPE P=2 S-C=0.0 G-C=0.22 ..
76. GT-WIN-3=GLASS-TYPE P=1 S-C=0.54 G-C=1.23 ..
77. GT-WIN-4=GLASS-TYPE P=2 S-C=0.0 G-C=0.62 ..
78.
79.
80. $-----CONSTRUCTIONS-----$

```

```

80.          S-----CONSTRUCTIONS-----S
81.
82. LAY-1      =LAYERS      MAT=(FAC-BRICK-1,RIGSTYFM-1,WALL-INS-1,
83.          WALL-INS-1,VAPOR-BAR,DRYWALL-1)
84.          I-F-R=.01 ..
85. INS-WL-1   =CCNS       LAYERS=LAY-1      ABS=.89      RC=2 ..
86.
87. LAY-2      =LAYERS      MAT=(FAC-BRICK-1,RIGSTYFM-1,STUD-WALL,
88.          WALL-INS-1,VAPOR-BAR,DRYWALL-1)
89.          I-F-R=.01 ..
90. STUD-WL-1  =CCNS       LAYERS=LAY-2      ABS=.89      RC=2 ..
91. LAY-3      =LAYERS      MAT=(SHINGLE-1,ASPENITE-1,AT-AIR-1,
92.          CEL-INS-1,VAPOR-BAR,DRYWALL-1)
93.          I-F-R=.01 ..
94. INS-RF-1   =CCNS       LAYERS=LAY-3      ABS=.32      RC=3 ..
95.
96. LAY-4      =LAYERS      MAT=(SHINGLE-1,ASPENITE-1,AT-AIR-1,
97.          CEL-JOIST-1,VAPOR-BAR,
98.          DRYWALL-1)
99.          I-F-R=.01 ..
100. STUD-RF-1  =CCNS       LAYERS=LAY-4      ABS=.32      RC=3 ..
101.
102. LAY-5      =LAYERS      MAT=(DRYWALL-1,AIR-SPACE-2,DRYWALL-1) ..
103. PART-WL-1  =CCNS       LAYERS=LAY-5 ..
104.
105. LAY-6      =LAYERS      MAT=(TILE-1,PLY-2,AIR-SPACE-3,DRYWALL-1) ..
106. AIR-FLR-1 =CCNS       LAYERS=LAY-6 ..
107.
108. LAY-8      =LAYERS      MAT=(CONC-BLK-1,CAV-INSL,
109.          VAPOR-BAR,DRYWALL-1)
110.          I-F-R=.01 ..
111. INS-WL-2   =CCNS       LAYERS=LAY-8 ..
112.
113. LAY-9      =LAYERS      MAT=(SHINGLE-1,ASPENITE-1,AT-AIR-1,
114.          CEL-JOIST-2,VAPOR-BAR,DRYWALL-1)
115.          I-F-R=.01 ..
116. STUD-RF-2  =CCNS       LAYERS=LAY-9 ..
117.
118. LAY-10     =LAYERS      MAT=(SOIL-1,CONCRETE-1)
119. SLAB-1     =CCNS       LAYERS=LAY-10     ABS=.55      RC=3 ..
120.
121. LAY-7      =LAYERS      MAT=(SOIL-2,CONCRETE-1)
122. SLAB-2     =CCNS       LAYERS=LAY-7      ABS=.65      RC=3 ..
123.
124. LAY-11     =LAYERS      MAT=(BUILT-RFG-1,PLY-2,
125.          CEL-INS-3,VAPOR-BAR,DRYWALL-1)
126.          I-F-R=.01 ..
127. INS-CEL-1  =CCNS       LAYERS=LAY-11     ABS=.76      RC=3 ..
128.
129. LAY-12     =LAYERS      MAT=(FAC-BRICK-1,CONC-BLK-2,WALL-INS-1,VAPOR-BAR,
130.          DRYWALL-1) ..
131.
132. BRICK-CCNC-1=CCNS      LAYERS=LAY-12     ABS=0.88      RC=2 ..
133.
134. LAY-13     =LAYERS      MAT=(FAC-BRICK-1,CONC-BLK-2,STUD-WALL,VAPOR-BAR,
135.          DRYWALL-1) ..
136. BRICK-CCSTD=CCNS      LAYERS=LAY-13     ABS=0.88      RC=2 ..
137.
138. LAY-14     =LAYERS      MAT=(CEDR-PLKS,RIGSTYFM-1,WALL-INS-1,
139.          WALL-INS-1,VAPOR-BAR,DRYWALL-1)
140.          I-F-R=.01 ..
141. CEDR-INS  =CCNS       LAYERS=LAY-14     ABS=.76      RC=6 ..
142.
143. LAY-15     =LAYERS      MAT=(CEDR-PLKS,RIGSTYFM-1,STUD-WALL,WALL-INS-1,
144.          VAPOR-BAR,DRYWALL-1)
145.          I-F-R=.01 ..
146. CEDR-STUD =CCNS       LAYERS=LAY-15     ABS=.76      RC=6 ..
147.
148. LAY-16     =LAYERS      MAT=(CONC-BLK-1,STUD-WALL,VAPOR-BAR,
149.          DRYWALL-1)
150.          I-F-R=.01 ..
151. STUDED-WALL=CCNS      LAYERS=LAY-16 ..
152.
153. TRUMBE-WALL=CCNS      U=0.33 ..
154. DR-1       =CCNS       U=0.49 ..
155.
156.          S-----BUILDING-SHADE-----S
157.
158. BUILDING-SHADE      X=-1.5      Y=4      Z=15.75      I=3.25      A=33
159.

```

```

160. AZ=180. TILT=180 3-ZONE-1 FRONT OVERHANG-1 ..
161.
162. BUILDING-SPACE X=12. Y=4 Z=16.75 H=1.50 A=29.3
163. AZ=90 TILT=180 1-ZONE-1 RIGHT OVERHANG-1 ..
164.
165. BUILDING-SPACE X=32 Y=32 Z=16.75 H=1.5 A=1.5
166. AZ=90 TILT=180 1-ZONE-1 REAR OVERHANG-1 ..
167.
168. BUILDING-SPACE X=0 Y=13 Z=16.75 H=1.5 A=1.5
169. AZ=270 TILT=180 3-ZONE-1 LEFT OVERHANG-1 ..
170.
171. -----SPACE DESCRIPTION-----
172.
173. CONC-1=SPACE-CONDITIONS
174. EQUIP-SCHEDULE=INT-LDS-1
175. EQUIPMENT-KA=0.25
176. FLOOR-WEIGHT=C
177. FURN-FRACTION=0.5
178. FURNITURE-TYPE=LIGHT
179. FURN-WEIGHT=0.0
180. TEMPERATURE=(70)
181. INF-METHOD=RESIDENTIAL
182. R-I-C=(0.0,0.0252,0.0044) ..
183.
184.
185. ZONE-1=SPACE X=0.
186. Y=4.
187. Z=16.75
188. AZIMUTH=0
189. AREA=530
190. VOLUME=4224
191. S-C=COND-1 ..
192.
193. FRONT-WL-1 =E-W F=8 A=4.0 AZ=180 CONS=COND-STUD
194. X=0 Y=0 Z=0 G-R=0.1 S-D=1 S-F-F=0.5 G-F-F=0.5 ..
195.
196. FRONT-WL-2 =E-W H=2 W=24.0 AZ=133 CONS=COND-ING
197. X=0.0 Y=0 Z=0 G-R=0.1 S-D=1 S-F-F=0.5 G-F-F=0.5 ..
198. WIN-1 =W1 F=5.0 A=6.0 G-T=GT-WIN-1 X=4.0 Y=1.5 SET=0.75 ..
199. WIN-2 =W1 F=5.0 W=6.0 G-T=GT-WIN-1 X=15.0 Y=0 SET=0.75 ..
200. WIN-3 =W1 F=5.0 W=6.0 G-T=GT-WIN-1 X=20.0 Y=1.5 SET=0.75 ..
201.
202. FRONT-WL-3 =E-W F=8 A=4 AZ=180 X=24.0 Y=0 Z=0 CONS=COND-STUD
203. G-R=0.1 S-D=1 S-F-F=0.5 G-F-F=0.5 ..
204.
205.
206. RIGHT-WL-1 =E-W F=8 A=7.0 AZ=90 X=32 Y=0 Z=0 CONS=STUD-WL-1
207. S-D=1 G-R=0.69 G-F-F=0.5 S-F-F=0.5 ..
208.
209. RIGHT-WL-2 =E-W F=8 W=21.0 AZ=90 A=32 Y=7.0 Z=0 CONS=INS-WL-1
210. S-D=5 G-R=0.69 G-F-F=0.5 S-F-F=0.5 ..
211. WIN-4 =W1 H=4 A=2.0 G-T=GT-WIN-1 X=13.0 Y=2.5 SET=0.33
212. ..
213.
214. REAR-WL-1 =E-W F=8 A=4.0 AZ=0 A=21 Y=0 Z=0 CONS=STUD-WL-1
215. S-D=5 G-R=0.69 G-F-F=0.5 S-F-F=0.5 ..
216.
217. REAR-WL-2 =E-W H=2 A=12.5 AZ=0 X=27.5 Y=2.5 Z=0 CONS=INS-WL-1
218. S-D=5 G-R=0.69 G-F-F=0.5 S-F-F=0.5 ..
219. WIN-5 =W1 F=4 A=2.0 G-T=GT-WIN-2 X=0.0 Y=2.5 SET=0.33
220. ..
221. WIN-6 =W1 F=4 A=2.0 G-T=GT-WIN-2 X=4.0 Y=2.5 SET=0.33
222. ..
223.
224. OCCUP-1 =OCCUP F=7 A=3 CONS=DR-1 X=11.0 ..
225.
226. LEFT-WL-1 =E-W F=8 W=2.25 AZ=270 X=0 Y=5 Z=0 CONS=STUD-WL-1
227. S-D=5 G-R=0.69 G-F-F=0.5 S-F-F=0.5 ..
228.
229. LEFT-WL-2 =E-W F=8 A=0.25 AZ=270 A=1 Y=0.75 Z=0. CONS=INS-WL-1
230. S-D=5 G-R=0.69 S-F-F=0.5 G-F-F=0.5 ..
231.
232. BACK-WALL=I-A F=1
233. A=14
234. CONS=PART-WL-1
235. A-I=2,3,5-2 ..
236.
237. LEFT-WALL=I-A F=1
238. A=14
239. CONS=PART-WL-1

```

```

240. N-T =ZCNE-2 ..
241.
242. FLOOR-1=I-W A=353.
243. CCNS=AIR-FLR-1 TILT=180
244. N-T =ZCNE-3 ..
245.
246. FLOOR-2=I-W A=147
247. CCNS=AIR-FLR-1 TILT=180
248. N-T=ZCNE-4 ..
249.
250. FRONT-RF-1=RCCF H=18 W=3.5 X=32 Y=0 Z=8.0 AZ=90
251. TILT=0.0 CCNS=STUD-RF-2 S-D=1 ..
252.
253. FRONT-RF-2=RCCF H=18 W=24.5 X=32 Y=3.5 Z=8.0 AZ=90
254. TILT=0.0 CCNS=INS-RF-1 S-D=1 ..
255.
256. FRONT-RF-3=RCCF H=14 W=7.875 X=0 Y=4. Z=8.0 AZ=270
257. TILT=0.0 CCNS=INS-RF-1 S-D=1 ..
258.
259. FRONT-RF-4=RCCF H=14 W=1.125 X=0 Y=1.125 Z=9.0 AZ=270
260. TILT=0.0 CCNS=STUD-RF-1 S-D=1 ..
261.
262.
263.
264. -----BUILDING-SHADE-----
265.
266. BUILDING-SHADE X=14.0 Y=32. Z=16.75 H=1.5 W=15.5
267. AZ=0. TILT=180. S-ZONE-2 REAR OVERHANG-S ..
268.
269. BUILDING-SHADE X=0 Y=32 Z=16.75 H=1.5 W=19.0
270. AZ=270 TILT=180. S-ZONE-2 LEFT OVERHANG-S ..
271.
272. COND-2=SPACE-CONDITIONS FLOOR-WEIGHT=0
273. FURN-FRACTION=0.5
274. FURNITURE-TYPE=LIGHT
275. FURN-WEIGHT=6.0
276. TEMPERATURE=(70)
277. INF-METHOD=RESIDENTIAL
278. R-I-C= (0.0,0.0175,0.0051) ..
279.
280. ZONE-2=SPACE X=0
281. Y=13
282. Z=8.75
283. AZIMUTH=0.
284. AREA=230.
285. VOLUME=1841.
286. S-C=CCNC-2 ..
287.
288. REAR-WL-21=E-W H=8 W=10.5 AZ=0 X=14 Y=19 Z=0
289. CCNS=INS-WL-1 S-C=5 G-F=0.69 S-F-F=0.5 G-F-F=0.5 ..
290. WIN-21 =WI H=4 W=2.0 G-T=GT-WIN-2 X=4 Y=2.5 SET3=.33
291.
292. WIN-22 =WI H=4 W=2.0 G-T=GT-WIN-2 X=9 Y=2.5 SET3=.33
293.
294.
295.
296.
297. REAR-WL-22=E-W H=8 W=3.5 AZ=0 X=3.5
298. Y=19 Z=0.
299. CCNS=STUD-WL-1 G-R=0.69 S-D=5 G-F-F=0.5 S-F-F=0.5 ..
300.
301. LEFT-WL-21=E-W H=8 W=4.75 AZ=270
302. X=0 Y=19 Z=0
303. CCNS=STUD-WL-1 G-R=0.69 S-D=5 G-F-F=0.5 S-F-F=0.5 ..
304.
305. LEFT-WL-22=E-W H=8 W=14.25 AZ=270 X=0 Y=14.25 Z=0.
306. CCNS=INS-WL-1 G-R=0.69 S-D=5 S-F-F=0.5 G-F-F=0.5 ..
307. WIN-23 =WI H=4 W=2.0 G-T=GT-WIN-3 X=11.7 Y=2.5 SET3=.33 ..
308.
309.
310. FLOOR-21 =I-W A=230.
311. CCNS=AIR-FLR-1 TILT=180
312. N-T=ZCNE-4 ..
313. REAR-RF-21=RCCF H=14 W=2.375 X=0 Y=19 Z=8.0 AZ=270
314. TILT=0.0 CCNS=STUD-RF-1 S-D=1 ..
315.
316.
317. REAR-RF-22=RCCF H=14 W=16.625 X=0 Y=16.625 Z=9.0
318. AZ=270 TILT=0.0 CCNS=INS-RF-1
319. S-D=1 ..

```

320.
321.
322.
323.
324.
325.
326.
327.
328.
329.
330.
331.
332.
333.
334.
335.
336.
337.
338.
339.
340.
341.
342.
343.
344.
345.
346.
347.
348.
349.
350.
351.
352.
353.
354.
355.
356.
357.
358.
359.
360.
361.
362.
363.
364.
365.
366.
367.
368.
369.
370.
371.
372.
373.
374.
375.
376.
377.
378.
379.
380.
381.
382.
383.
384.
385.
386.
387.
388.
389.
390.
391.
392.
393.
394.
395.
396.
397.
398.
399.

5-----BUILDING SHADE-----5

BUILDING-SHADE X=0 Y=0 Z=3.0 H=3.0 W=32.0
AZ=180 TILT=130 S-ZONE-3 FRONT OVERHANG -3
..

CJND-3=SPACE-CONDITIONS FLOOR-WEIGHT=0.0
FURN-FRACTION=0.50
FURNITURE-TYPE=LIGHT
FURN-WEIGHT=6.0
TEMPERATURE=(70)
INF-METHOD=RESIDENTIAL
R-I-C= (0.0,0.0345,0.01278) ..

ZONE-3=SPACE X=0
Y=0
Z=0
AZIMUTH=0
AREA=560.
VOLUME=4468
S-C=COND-3 ..

FRONT-WL-31=E-W H=8 W=8 AZ=180 X=0 Y=0 Z=0
CONS=BRICK-COSTO S-D=1 C-F=0.34 G-F-F=0.5 S-F-F=0.5 ..

WIN-31 =WI H=6.8 W=6.0 G-T=GT-WIN-1 X=1.0 Y=0 SETB=.50 ..
FRONT-WL-32=E-W H=8 W=16 AZ=180 X=8 Y=0 Z=0
CONS=TRCMBE-WALL ..
FRONT-WL-33=E-W F=8 W=8 AZ=180 X=24 Y=0 Z=0
CONS=BRICK-COSTO S-D=1 G-R=0.34 S-F-F=0.5 G-F-F=0.5 .. SETB=.5 ..
WIN-33 =WI H=6.8 W=6 G-T=GT-WIN-1 X=25 Y=0 SETB=.5 ..

RIGHT-WL-31=E-W F=8 W=2 AZ=90 X=32 Y=0 Z=0
CONS=BRICK-COSTO S-D=5 C-R=0.69 S-F-F=0.5 G-F-F=0.5 ..

RIGHT-WL-32=E-W H=8 W=8.0 AZ=90 X=32 Y=2 Z=0
CONS=BRICK-CONC-1 S-D=5 G-R=0.69 S-F-F=0.5 G-F-F=0.5 ..

LEFT-WL-31=E-W H=8 W=2 AZ=270 X=0 Y=2.0 Z=0
CONS=BRICK-CUSTO S-D=5 C-R=0.69 G-F-F=0.5 S-F-F=0.5 ..

LEFT-WL-32=E-W F=8 W=8.0 AZ=270 X=0 Y=10. Z=0
CONS=BRICK-CONC-1 S-D=5 C-R=0.69 G-F-F=0.5 S-F-F=0.5 ..

PART-WL-3 =I-W H=8.
W=29.5
CONS=PART-WL-1
N-T=ZONE-4 ..

ROOF-3 =RCOF H=4.
W=32.
X=0 Y=0 Z=8
AZ=180 TILT=0.
CONS=INS-CEL-1 S-D=20 ..

UNDERGROUND-WALL CONS=INS-WL-2
AREA=129 ..
UNDERGROUND-WALL CONS=STUDED-WALL
AREA=31 ..

UNDERGROUND-FLOOR CONS=SLAB-1
AREA=640. S GRS FLOOR AREA 5
TILT=130 ..

CJND-4 =SPACE-CONDITIONS FLOOR-WEIGHT=0
FURN-FRACTION=0.5
FURNITURE-TYPE=LIGHT
FURN-WEIGHT=6.0

```

400.                                     TEMPERATURE=(70)
401.                                     INF-METHOD=RESIDENTIAL
402.                                     R-I-C= (0.0,0.02E2,0.0)994) ..
403.
404. ZONE-4=SPACE                        X=0
405.                                     Y=20
406.                                     Z=0.
407.                                     AZIMUTH=C
408.                                     AREA=320.
409.                                     VOLUME=2E60.
410.                                     S-C=COND-4 ..
411.
412.
413. UNDERGROUND-WALL                   CCNS=INS-WL-2
414.                                     AREA=35E
415.                                     ..
416.
417. UNDERGROUND-WALL                   CCNS=STUCCD-WALL
418.                                     AREA=4C ..
419.
420.
421.
422. UNDERGROUND-FLOOR                  CCNS=SLAE-2
423.                                     AREA=3E4.  > GRS FLOOR AREA S
424.                                     TILT=18C ..
425.
426.
427.
428. LOADS-REPORT VERIFICATION=(ALL-VERIFICATION)
429. SUMMARY=(ALL-SUMMARY) ..
430.
431.          3-----HOURLY REFCRTS-----3
432.
433. HR-SCH-1 =SCHEDULE                   THRU MAR 09 (ALL) (1,24) (0)
434.                                     THRU MAR 15 (ALL) (1,24) (1)
435.                                     THRU MAR 21 (ALL) (1,24) (0)
436.                                     THRU APR 03 (ALL) (1,24) (1)
437.                                     THRU APR 08 (ALL) (1,24) (0)
438.                                     THRU APR 14 (ALL) (1,24) (1)
439.                                     THRU DEC 31 (ALL) (1,24) (0) ..
440.
441.
442. OUT-1 =REPORT-BLOCK                 VARIABLE-TYPE=ZONE-1
443.                                     V-L=(1,2,3,4,5,10,37,41,44) ..
444.
445. OUT-2 =REPORT-BLOCK                 V-T=ZONE-2
446.                                     V-L=(1,2,3,4,5,37,41,44) ..
447.
448. OUT-3 =REPORT-BLOCK                 V-T=ZONE-3
449.                                     V-L=(1,2,3,4,5,7,8,37,41,44) ..
450.
451.
452. LOS-REP =HOURLY-REFCRT              REFCRT-SCHEDULE=HR-SCH-1
453. REPORT-BLOCK=(OUT-1,OUT-2,OUT-3) ..
454.
455. END ..
456. COMPUTE LOADS ..
457. INPUT SYSTEMS ..
458.
459. SYSTEMS-REPORT                       VERIFICATION=(ALL-VERIFICATION)
460.                                     SUMMARY=(ALL-SUMMARY) ..
461.
462.          3-----SYSTEM SCHEDULE-----3
463.
464. HEAT-1 =SCHEDULE                     THRU MAR 15 (ALL) (1,24) (70)
465.                                     THRU MAR 20 (ALL) (1,24) (70)
466.                                     THRU MAR 29 (ALL) (1,24) (70)
467.                                     THRU MAR 30 (ALL) (1,24) (70)
468.                                     THRU MAR 31 (ALL) (1,24) (70)
469.                                     THRU APR 05 (ALL) (1,24) (70)
470.                                     THRU APR 08 (ALL) (1,24) (70)
471.                                     THRU APR 09 (ALL) (1,24) (70)
472.                                     THRU APR 12 (ALL) (1,24) (70)
473.                                     THRU DEC 31 (ALL) (1,24) (70) ..
474.
475.
476.
477. HEAT-2 =SCHEDULE                     THRU MAR 27 (ALL) (1,24) (70)
478.                                     THRU MAR 30 (ALL) (1,24) (70)
479.                                     THRU APR 02 (ALL) (1,24) (70)

```

```

480. THRU APR 09 (ALL) (1.24) (68)
481. THRU APR 12 (ALL) (1.24) (66)
482. THRU DEC 31 (ALL) (1.24) (67.0) ..
483.
484.
485. HEAT-3 =SCHEDULE THRU MAR 12 (ALL) (1.24) (70)
486. THRU MAR 13 (ALL) (1.8) (70) (9) (74)
487. (10.14) (73.5) (15.19) (72) (19.24) (71)
488. THRU MAR 14 (ALL) (1.8) (70.5) (9) (73)
489. (10) (74) (11.14) (75) (15)(74) (16.24)
490. (72.5)
491. THRU MAR 30 (ALL) (1.24) (70.5)
492. THRU MAR 31 (ALL) (1.8) (70) (9.20) (73.5)
493. (21.24) (72)
494. THRU APR 01 (ALL) (1.8) (71) (9.15) (75)
495. (16.19) (74) (20.24) (73)
496. THRU DEC 31 (ALL) (1.24) (70.5) ..
497.
498. HEAT-4 =SCHEDULE THRU DEC 31 (ALL) (1.24) (70.5) ..
499.
500. COOL-1 =SCHEDULE THRU DEC 31 (ALL) (1.24) (95) ..
501.
502. HEAT-SCH-1 =SCHEDULE THRU DEC 31 (ALL) (1.24) (1) ..
503. COOL-SCH-1 =SCHEDULE THRU DEC 31 (ALL) (1.24) (0) ..
504.
505.
506.
507.
508. FAN-1 =SCHEDULE THRU DEC 31 (ALL) (1.24) (0) ..
509.
510. $-----ZONE DESCRIPTION-----$
511.
512. ZONE-1 =ZONE DESIGN-HEAT-T=70
513. HEAT-TEMP-SCH=HEAT-1
514. DESIGN-COOL-T=78
515. COOL-TEMP-SCH=COOL-1
516. ASSIGNED-CFM=10.
517. BASEBCARC-CTRL=THERMSTATIC
518. THERMSTAT-TYPE=TWC-POSITION
519. THRDTTLING-RANGE=1.5
520. ZONE-TYPE=CONDITIONED
521. BASEBCARC-RATING=-26415 ..
522.
523. ZONE-2 =ZONE DESIGN-HEAT-T=70
524. HEAT-TEMP-SCH=HEAT-2
525. DESIGN-COOL-T=78
526. COOL-TEMP-SCH=COOL-1
527. ASSIGNED-CFM=10.
528. BASEBCARC-CTRL=THERMSTATIC
529. THERMSTAT-TYPE=TWC-POSITION
530. THRDTTLING-RANGE=1.5
531. ZONE-TYPE=CONDITIONED
532. BASEBCARC-RATING=-5973 ..
533.
534. ZONE-3 =ZONE DESIGN-HEAT-T=70
535. HEAT-TEMP-SCH=HEAT-3
536. DESIGN-COOL-T=78
537. COOL-TEMP-SCH=COOL-1
538. ASSIGNED-CFM=10.
539. BASEBCARC-CTRL=THERMSTATIC
540. THERMSTAT-TYPE=TWC-POSITION
541. THRDTTLING-RANGE=1.5
542. ZONE-TYPE=CONDITIONED
543. BASEBCARC-RATING=-27394 ..
544.
545. ZONE-4 =ZONE DESIGN-HEAT-T=70
546. HEAT-TEMP-SCH=HEAT-4
547. DESIGN-COOL-T=78
548. COOL-TEMP-SCH=COOL-1
549. ASSIGNED-CFM=10.
550. BASEBCARC-CTRL=THERMSTATIC
551. THERMSTAT-TYPE=TWC-POSITION
552. THRDTTLING-RANGE=1.5
553. ZONE-TYPE=CONDITIONED
554. BASEBCARC-RATING=-7589 ..
555.
556. SYS-1 =SYSTEM SYSTEM-TYPE=RESYS
557. MAX-SUPPLY-T=150
558. MIN-SUPPLY-T=50
559.

```

```

560. SUPPLY-CFM=10.
561. HEATING-SCHEDULE=HEAT-SCH-1
562. COOLING-SCHEDULE=COOL-SCH-1
563. FAN-SCHEDULE=FAN-1
564. SUPPLY-KW=0.
565. CRANKCASE-HEAT=0.
566. HEATING-CAPACITY=-364
567. FURNACE-AUX=0.
568. BASEBOARC-SOURCE=ELECTRIC
569. ZONE-NAMES=(ZONE-1) ..
570.
571. SYS-2 =SYSTEM SYSTEM-TYPE=RESYS
572. MAX-SUPPLY-T=150
573. MIN-SUPPLY-T=50
574. SUPPLY-CFM=10.
575. HEATING-SCHEDULE=HEAT-SCH-1
576. COOLING-SCHEDULE=COOL-SCH-1
577. FAN-SCHEDULE=FAN-1
578. SUPPLY-KW=0.
579. CRANKCASE-HEAT=0.
580. HEATING-CAPACITY=-364
581. FURNACE-AUX=0
582. BASEBOARC-SOURCE=ELECTRIC
583. ZONE-NAMES=(ZONE-2) ..
584.
585.
586. SYS-3 =SYSTEM SYSTEM-TYPE=RESYS
587. MAX-SUPPLY-T=150
588. MIN-SUPPLY-T=50
589. SUPPLY-CFM=10.
590. HEATING-SCHEDULE=HEAT-SCH-1
591. COOLING-SCHEDULE=COOL-SCH-1
592. FAN-SCHEDULE=FAN-1
593. SUPPLY-KW=0.
594. CRANKCASE-HEAT=0.
595. HEATING-CAPACITY=-364
596. FURNACE-AUX=0
597. BASEBOARC-SOURCE=ELECTRIC
598. ZONE-NAMES=(ZONE-3) ..
599.
600. SYS-4 =SYSTEM SYSTEM-TYPE=RESYS
601. MAX-SUPPLY-T=150
602. MIN-SUPPLY-T=50
603. SUPPLY-CFM=10.
604. HEATING-SCHEDULE=HEAT-SCH-1
605. COOLING-SCHEDULE=COOL-SCH-1
606. FAN-SCHEDULE=FAN-1
607. SUPPLY-KW=0.
608. CRANKCASE-HEAT=0.
609. HEATING-CAPACITY=-364
610. FURNACE-AUX=0
611. BASEBOARC-SOURCE=ELECTRIC
612. ZONE-NAMES=(ZONE-4) ..
613.
614. PLANT-1 =PLANT-ASSIGNMENT SYSTEM-NAMES=(SYS-1,SYS-2,SYS-3,SYS-4) ..
615.
616.
617. $-----HOURLY REPORT-----$
618.
619. HR-SCH-1 =SCHEDULE THRU MAR 07 (ALL) (1,24) (0)
620. THRU MAR 15 (ALL) (1,24) (1)
621. THRU MAR 19 (ALL) (1,24) (1)
622. THRU APR 03 (ALL) (1,24) (1)
623. THRU APR 05 (ALL) (1,24) (0)
624. THRU APR 14 (ALL) (1,24) (1)
625. THRU DEC 31 (ALL) (1,24) (0) ..
626.
627. OUT-1 =R-B V-T=GLOBAL
628. V-L=(7,9,10,12) ..
629.
630. OUT-2 =R-B V-T=ZONE-1
631. V-L=(5,6,15) ..
632.
633. OUT-3 =R-B V-T=ZONE-2
634. V-L=(5,6,15) ..
635.
636. OUT-4 =R-B V-T=ZONE-3
637. V-L=(5,6,15) ..
638.
639. OUT-5 =R-B V-T=ZONE-4

```

```

640.          V-L=(6,15) ..
641.
642.      UUT-6      =R-B      V-T=SYS-1
643.          V-L=(9,46) ..
644.
645.      UUT-7      =R-B      V-T=SYS-2
646.          V-L=(9,46) ..
647.
648.      UUT-8      =R-B      V-T=SYS-3
649.          V-L=(9,46) ..
650.
651.      UUT-9      =R-B      V-T=SYS-4
652.          V-L=(9,46) ..
653.
654.
655.      SYS-REP    =F-R      R-SCH=HR-SCH-1
656.          R-B      =(CUT-1,OUT-2,CUT-3,OUT-4,
657.                  CUT-5,CUT-6,OUT-7,UUT-8,OUT-9) ..
658.
659.
660.      END ..
661.      COMPUTE SYSTEMS ..
662.      INPJT PLANT ..
663.
664.          $---PLANT INFLT WITH ONE PEICE OF EQUIPMENT---$
665.          $---TO GET DEFS REPORT---$
666.
667.      PLANT-REPORT          SUMMARY=(DEFS,PS-B) ..
668.
669.          $---CUMMY PLANT EQUIPMENT---$
670.
671.      DUM-1          =PLANT-EQUIPMENT      TYPE=COOLING-TWR      SIZE=0.001 ..
672.
673.
674.      END ..
675.      COMPUTE PLANT ..
676.      STOP ..
677.      //SETEPOS.FTOSFJ01 CD USN=WENG,DCE2,WEATH,WEATLY.
678.      // DISP=SHR,UNIT=3330,VCL=SER=DISK03
679.      //

```

APPENDIX - G.2

THE DOE-2 INPUT LISTINGS FOR THE TEST HOUSE
(CRACK LENGTH INFILTRATION METHOD)

1.
2.
3.
4.
5.
6.
7.
8.
9.
10.
11.
12.
13.
14.
15.
16.
17.
18.
19.
20.
21.
22.
23.
24.
25.
26.
27.
28.
29.
30.
31.
32.
33.
34.
35.
36.
37.
38.
39.
40.
41.
42.
43.
44.
45.
46.
47.
48.
49.
50.
51.
52.
53.
54.
55.
56.
57.
58.
59.
60.
61.
62.
63.
64.
65.
66.
67.
68.
69.
70.
71.
72.
73.
74.
75.
76.
77.
78.
79.
80.

```
// AB36TDOE JOB (G270,CS7,8,9), 'TDOE TARIO', CLASS=S, MSGLEVEL=(1,1),
// REGION=1500K
// EXEC DOE21CWF
// STEP04.SYSIN DD *
INPUT LOADS ..
TITLE LINE-1 *BECKER SOLAR COTTAGE RUN 1 *
LINE-2 *--CUSTOM WEIGHTING FACTOR GENERAT --
LINE-3 *INTERNAL GAINS IN ZONE1 *
LINE-4 *TROMBE WALL MODELLED AS EXTR WALL *
```

-----HEADING-----

```
DIAGNOSTIC CAUTIONS ..
ABORT ERRORS ..
RUN-PERIOD MAR 10 1982 THRU MAR 15 1982
MAR 22 1982 THRU MAR 25 1982
MAR 28 1982 THRU APR 02 1982
APR 09 1982 THRU APR 13 1982 ..
```

```
BUILDING-LOCATION LAT=42.30 LON=82.9 T-Z=5
ALT=637. AZ=-24
```

-----SCHEDULE-----

```
INT-LDS-1=SCHEDULE THRU DEC 31 (ALL) (1,24) (1) ..
```

-----MATERIALS-----

STUD-WALL	=MAT	TH=.2917	COND=.0667	DENS=32	S-H=.33	\$2X4STUDS ..
DRYWALL-1	=MAT	TH=.0417	COND=.0925	DENS=50	S-H=.26	\$1/2 IN DRYWALLS ..
VAPOR-BAR	=MAT	TH=.0003	COND=.11	DENS=70	S-H=.4	\$VAPOR BARS ..
WALL-INS-1	=MAT	TH=.2917	COND=.0238	DENS=.6	S-H=.2	\$R12 INSULATIONS ..
RIGSTYFM-1	=MAT	TH=.125	COND=.0133	DENS=1.5	S-H=.29	\$1.5 IN STYRCFCAMS ..
FAC-BRIK-1	=MAT	TH=.3333	COND=.75	DENS=130	S-H=.22	\$4 IN FACE BRIKS ..
CONC-BLK-1	=MAT	TH=.833	COND=.78	DENS=36	S-H=.21	\$10 IN CONC BLKS ..
CEL-JOIST-1	=MAT	TH=.500	COND=.0667	DENS=32	S-H=.33	\$2X6 CEL JOISTS ..
SHINGLE-1	=MAT	TH=.0208	COND=.0473	DENS=70	S-H=.3	\$110 LB SHINGLES ..
ASPENITE-1	=MAT	TH=.042	COND=.0667	DENS=32	S-H=.33	\$3/8 IN ASPENITE ..
AT-AIR-1	=MAT	RES=3.1				\$ATTIC AIR SPACES ..
CEL-INS-1	=MAT	TH=1.0	COND=.0238	DENS=.6	S-H=.2	\$R 42 INSULATIONS ..
CEL-INS-2	=MAT	TH=.5	COND=.0238	DENS=.6	S-H=.2	\$R 21 INSULATIONS ..
CEL-JOIST-2	=MAT	TH=.7	COND=.0667	DENS=32	S-H=.33	\$2X8 CEL JOISTS ..
PLY#-1	=MAT	TH=.0417	COND=.0667	DENS=34	S-H=.29	\$5/8 IN PLYWOODS ..
BUILT-RFG-1	=MAT	TH=.031	COND=.0946	DENS=70	S-H=.35	\$BUILT UP ROOFINGS ..
CEDR-DECK	=MAT	TH=.17	COND=.0670	DENS=32	S-H=.33	\$CEDAR DECKINGS ..
CEL-INS-3	=MAT	TH=.67	COND=.0222	DENS=.6	S-H=.2	\$R 30 INSULATIONS ..
AIR-SPACE-2	=MAT	RES=1.01				\$3.5 IN AIR SPACES ..
AIR-SPACE-3	=MAT	RES=0.93				\$8 IN AIR SPACES ..
PLY#-2	=MAT	TH=.0834	COND=.0667	DENS=34	S-H=.29	\$3/4 IN PLYWOODS ..
TILE-1	=MAT	TH=.0625	COND=.075	DENS=82	S-H=.315	\$CARPET-PADS ..
CONCPETE-1	=MAT	TH=.3333	COND=.758	DENS=140	S-H=.2	\$4 IN CONCRETES ..
EXP-POLY-1	=MAT	TH=.0167	COND=.0167	DENS=2.2	S-H=.29	\$2 IN POLYSTYRENE ..
CONC-BLK-2	=MAT	TH=.5000	COND=.78	DENS=38.	S-H=.20	\$6-IN CONC BLKS ..
CEDR-PLKS	=MAT	TH=.083	COND=.0667	DENS=32.	S-H=.33	\$CEDR PLANKS ..
SOIL-1	=MAT	RES=5.00				\$ RESISTANCE OF SCIL BELCW FLOOR \$..
SOIL-2	=MAT	RES=30.00				\$ RESISTANCE OF SCIL BELCW FLGR \$..
CAV-INSL	=MAT	RES=11.0				\$ BELOW GRD WALL CAVITY INS Z-3-4 \$..

-----GLAZING (DOUBLE PANE)-----

GT-WIN-1=GLASS-TYPE	P=2	S-C=0.65	G-C=0.62	..
GT-WIN-2=GLASS-TYPE	P=2	S-C=0.0	G-C=0.22	..
GT-WIN-3=GLASS-TYPE	P=1	S-C=0.54	G-C=1.23	..
GT-WIN-4=GLASS-TYPE	P=2	S-C=0.0	G-C=0.62	..

-----CONSTRUCTIONS-----

Reproduced with permission of the copyright owner. Further reproduction prohibited without permission.

```

80.          S-----CONSTRUCTIONS-----S
81.
82. LAY-1      =LAYERS      MAT=(FAC-BRICK-1,RIGSTYF4-1,WALL-INS-1,
83.          WALL-INS-1,VAPOR-BAR,DRYWALL-1)
84.          I-F-R=.61 ..
85.
86. INS-WL-1   =CCNS        LAYERS=LAY-1      ABS=.83      RC=2 ..
87.
88. LAY-2      =LAYERS      MAT=(FAC-BRICK-1,RIGSTYF4-1,STUD-WALL,
89.          WALL-INS-1,VAPOR-BAR,DRYWALL-1)
90.          I-F-R=.65 ..
91.
92. STUD-WL-1  =CCNS        LAYERS=LAY-2      ABS=.83      RC=2 ..
93.
94. LAY-3      =LAYERS      MAT=(SHINGLE-1,ASPENITE-1,AIR-SPAC-1,
95.          CEL-INS-1,VAPOR-BAR,DRYWALL-1)
96.          I-F-R=.61 ..
97.
98. INS-RF-1   =CCNS        LAYERS=LAY-3      ABS=.82      RC=3 ..
99.
100. LAY-4      =LAYERS      MAT=(SHINGLE-1,ASPENITE-1,AIR-SPAC-1,
101.          CEL-INS-1,VAPOR-BAR,
102.          DRYWALL-1) I-F-R=.61 ..
103.
104. STUD-RF-1  =CCNS        LAYERS=LAY-4      ABS=.82      RC=3 ..
105.
106. LAY-5      =LAYERS      MAT=(DRYWALL-1,AIR-SPACE-2,DRYWALL-1) ..
107.
108. PART-WL-1  =CCNS        LAYERS=LAY-5 ..
109.
110. LAY-6      =LAYERS      MAT=(TILE-1,PLY-2,AIR-SPACE-3,DRYWALL-1) ..
111.
112. AIR-FLR-1  =CCNS        LAYERS=LAY-6 ..
113.
114.
115. LAY-8      =LAYERS      MAT=(CCNC-BLK-1,CAV-INSL,
116.          VAPOR-BAR,DRYWALL-1) I-F-R=.64 ..
117.
118. INS-WL-2   =CCNS        LAYERS=LAY-8 ..
119.
120. LAY-9      =LAYERS      MAT=(SHINGLE-1,ASPENITE-1,AIR-SPAC-1,
121.          CEL-INS-2,VAPOR-BAR,DRYWALL-1) I-F-R=.61 ..
122.
123. STUD-RF-2  =CCNS        LAYERS=LAY-9 ..
124.
125. LAY-10     =LAYERS      MAT=(SOIL-1,CONCRETE-1) I-F-R=0.92 ..
126.
127. SLAB-1     =CCNS        LAYERS=LAY-10     ABS=.95      RC=3 ..
128.
129. LAY-7      =LAYERS      MAT=(SOIL-2,CONCRETE-1) I-F-R=0.92 ..
130.
131. SLAB-2     =CCNS        LAYERS=LAY-7      ABS=0.65     RC=3 ..
132.
133.
134. LAY-11     =LAYERS      MAT=(BUILT-RFG-1,PLY-3,
135.          CEL-INS-3,VAPOR-BAR,DRYWALL-1)
136.          I-F-R=.61 ..
137.
138. INS-CEL-1  =CCNS        LAYERS=LAY-11     ABS=.76      RC=3 ..
139.
140. LAY-12     =LAYERS      MAT=(FAC-BRICK-1,CCNC-BLK-2,WALL-INS-1,VAPOR-BAR,
141.          DRYWALL-1) ..
142.
143. BRICK-CCNC-1=CCNS        LAYERS=LAY-12     ABS=0.69     RC=2 ..
144.
145. LAY-13     =LAYERS      MAT=(FAC-BRICK-1,CCNC-BLK-2,STUD-WALL,VAPOR-BAR,
146.          DRYWALL-1) ..
147.
148. DRINK-CCSTC=CCNS        LAYERS=LAY-13     ABS=0.66     RC=2 ..
149.
150. LAY-14     =LAYERS      MAT=(CEDR-PLKS,RIGSTYF4-1,WALL-INS-1,
151.          WALL-INS-1,VAPOR-BAR,DRYWALL-1)
152.          I-F-R=.68 ..
153.
154. CEDR-INS  =CCNS        LAYERS=LAY-14     ABS=.76      RC=6 ..
155.
156. LAY-15     =LAYERS      MAT=(CEDR-PLKS,RIGSTYF4-1,STUD-WALL,WALL-INS-1,
157.          VAPOR-BAR,DRYWALL-1)
158.          I-F-R=.68 ..
159.
160. CEDR-STUD =CCNS        LAYERS=LAY-15     ABS=.76      RC=6 ..
161.
162.
163. LAY-16     =LAYERS      MAT=(CCNC-BLK-1,STUD-WALL,VAPOR-BAR,
164.          DRYWALL-1) I-F-R=0.63 ..
165.
166.
167. STUDEC-WALL=CCNS        LAYERS=LAY-16 ..
168.
169. TRUMBE-WALL=CCNS        U=0.13 ..
170.
171. DR-1       =CCNS        U=0.49 ..
172.
173.
174.          S-----BUILDING-SHADE-----S
175.
176. BUILDING-SHADE      X=-1.5      Y=4      Z=16.75      I=3.25      .035
177.
178.
179.

```

```

161.
162. BUILDING-SHADE X=J2. Y=4 Z=16.75 H=1.50 W=29.5
163. AZ=90 TILT=180 S-ZONE-1 RIGHT OVERHANG-IG-S ..
164.
165. BUILDING-SHADE X=J2 Y=32 Z=16.75 H=1.5
166. AZ=0 TILT=180 S-ZONE-1 REAR OVERHANG-S ..
167.
168. BUILDING-SHADE X=0 Y=13 Z=16.75 H=1.5
169. AZ=270 TILT=180 S-ZONE-1 LEFT OVERHANG-S ..
170.
171. S-----SPACE DESCRIPTION-----S
172.
173. CCND-1=SPACE-CONDITIONS
174. EQUIP-SCHEDULE=INT-LDS-1
175. EQUIPMENT-KW=0.25
176. FLOOR-WEIGHT=0
177. FURN-FRACTION=0.50
178. FURNITURE-TYPE=LIGHT
179. FURN-WEIGHT=6.0
180. TEMPERATURE=(70)
181. INF-METHOD=CRACK
182. N-Z-H=-4
183.
184.
185. ZCNE-1=SPACE X=0.
186. Y=4.
187. Z=8.75
188. AZIMUTH=0
189. AREA=536
190. VOLUME=4258
191. S-C=CCND-1 ..
192.
193.
194. FRONT-WL-1=E-W H=8 W=4.0 AZ=130 CONS=CEDR-STUD
195. INF-COEF=0 X=0 Y=0 Z=0 G-R=0.1 S-D=1 S-F-F=0.5 G-F-F=0.5 ..
196.
197. FRONT-WL-2=E-W H=8 W=24.0 AZ=180 CONS=CEDR-INS
198. INF-COEF=0 X=4.0 Y=0 Z=0 G-R=0.1 S-D=1 S-F-F=0.5 G-F-F=0.5 ..
199. WIN-1=WI H=5.0 W=6.0 G-T=GT-WIN-1 X=4.0 Y=1.5 SETB=.75
200. INF-COEF=J ..
201. WIN-2=WI H=6.8 W=6.0 G-T=GT-WIN-1 X=13.0 Y=0 SETB=.75
202. INF-COEF=J ..
203. WIN-3=WI H=5.0 W=6.0 G-T=GT-WIN-1 X=20.0 Y=1.5 SETB=.75
204. INF-COEF=J ..
205.
206. FRONT-WL-3=E-W H=8 W=4 AZ=130 X=28.0 Y=0 Z=0 CCNS=CEDR-STUD
207. INF-COEF=0 G-R=0.1 S-D=1 S-F-F=0.5 G-F-F=0.5 ..
208.
209. RIGHT-WL-1=E-W H=8 W=7.0 AZ=90 X=J2 Y=0 Z=0 CONS=STUD-WL-1
210. INF-COEF=1.50 S-D=1 G-R=0.69 G-F-F=0.5 S-F-F=0.5 ..
211.
212. RIGHT-WL-2=E-W H=8 W=21.0 AZ=90 X=J2 Y=7.0 Z=0 CCNS=INS-WL-1
213. INF-COEF=1.50 S-D=5 G-R=0.69 G-F-F=0.5 S-F-F=0.5 ..
214. WIN-4=WI H=4 W=2.0 G-T=GT-WIN-1 X=13.0 Y=2.5 SETB=.33
215. INF-COEF=2.0 ..
216.
217. REAR-WL-1=E-W H=8 W=4.5 AZ=0 X=J2 Y=25 CCNS=STUD-WL-1
218. INF-COEF=0 S-D=5 G-R=0.69 G-F-F=0.5 S-F-F=0.5 ..
219.
220. REAR-WL-2=E-W H=8 W=13.5 AZ=0 X=27.5 Y=28 Z=0 CCNS=INS-WL-1
221. INF-COEF=0 S-D=5 G-R=0.69 G-F-F=0.5 S-F-F=0.5 ..
222. WIN-5=WI H=4 W=2.0 G-T=GT-WIN-2 X=0.0 Y=2.5 SETB=.33
223. INF-COEF=1.25 ..
224. WIN-6=WI H=4 W=2.0 G-T=GT-WIN-2 X=4.0 Y=2.5 SETB=.33
225. INF-COEF=1.25 ..
226. DOOR-1=DOOR H=7 W=3 CONS=DR-1 X=10.0 INF-COEF=0.25 ..
227.
228. LEFT-WL-1=E-W H=8 W=2.25 AZ=270 X=0 Y=9 Z=0 CCNS=STUD-WL-1
229. INF-COEF=1.5 S-D=5 G-R=0.69 G-F-F=0.5 S-F-F=0.5 ..
230.
231. LEFT-WL-2=E-W H=8 W=6.25 AZ=270 X=0 Y=6.75 Z=0. CCNS=INS-WL-1
232. INF-COEF=1.5 S-D=5 G-R=0.69 S-F-F=0.5 G-F-F=0.5 ..
233.
234. BACK-WALL=I-W H=8
235. W=14
236. CCNS=PART-WL-1
237. N-T=ZONE-2 ..
238.
239. LEFT-WALL=I-W H=8

```



```

238.          W=19
239.          CONS=PART-WL-1
240.          N-T=ZONE-2 ..
241.
242. FLOCR-1=I-W          A=353.
243.          CONS=AIR-FLR-1          TILT=150
244.          N-T=ZONE-3 ..
245.
246. FLOCR-2=I-W          A=147
247.          CONS=AIR-FLR-1          TILT=150
248.          N-T=ZONE-4 ..
249.
250. FRCNT-WF-1=ROOF      H=18  W=3.5  X=31  Y=0  Z=8.0  AZ=90
251. INF-COEF=0.0        TILT=0.0  CONS=STUD-RF-2  S-D=1 ..
252.
253. FRCNT-WF-2=RCCF      H=18  W=24.5  X=32  Y=3.5  Z=8.0  AZ=90
254. INF-COEF=0.0        TILT=0  CONS=INS-RF-1  S-D=1 ..
255.
256. FRCNT-WF-3=RCCF      H=14  W=7.875  Y=0  Y=9  Z=8.0  AZ=270
257. INF-COEF=0.0        TILT=0  CONS=INS-RF-1  S-D=1 ..
258.
259. FRCNT-WF-4=ROOF      H=14  W=1.125  X=0  Y=1.125  Z=8.0  AZ=270
260. INF-COEF=0.0        TILT=0  CONS=STUD-RF-1  S-D=1 ..
261.
262.
263.
264.          S-----BUILDING-SHADE-----S
265.
266. BUILDING-SHADE      X=14.0  Y=32.  Z=16.75  H=1.5  W=15.5
267.          AZ=0.  TILT=180.  S-ZONE-2 REAR OVERHANG-S ..
268.
269. BUILDING-SHADE      X=0  Y=32  Z=16.75  H=1.5  W=19.0
270.          AZ=270  TILT=180.  S-ZONE-2 LEFT OVERHANG-S ..
271.
272. COND-2=SPACE-CONDITIONS  FLCOR-WEIGHT=0
273.          FURN-FRACTION=0.50
274.          FURNITURE-TYPE=LIGHT
275.          FURN-WEIGHT=6.0
276.          TEMPERATURE=(70)
277.          INF-METCD=CRACK
278.          N-Z-H=-4 ..
279.
280. ZCNE-2=SPACE          X=0
281.          Y=13
282.          Z=8.75
283.          AZIMUTH=0.
284.          AREA=230.
285.          VOLUME=1841.
286.          S-C=COND-2 ..
287.
288. REAR-WL-21=E-W      H=8  W=10.5  AZ=0  X=14  Y=19  Z=0
289.          CCNS=INS-WL-1  S-D=5  G-R=0.69  S-F-F=0.5  G-F-F=0.5
289.1  INF-COEF=2.00 ..
290. WIN-21=W1          H=4  W=2.0  G-T=GT-WIN-2  X=4  Y=2.5  SETB=.33
291. INF-COEF=1.50 ..
292. WIN-22=W1          H=4  W=2.0  G-T=GT-WIN-2  X=8  Y=2.5  SETB=.33
293. INF-COEF=1.50 ..
294.
295.
296.
297. REAR-WL-22=E-W      H=8  W=3.5  AZ=0  X=3.5
298.          INF-COEF=2.00  Y=19  Z=0.
299.          CONS=STUD-WL-1  G-R=0.69  S-D=5  G-F-F=0.5  S-F-F=0.5 ..
300.
301. LEFT-WL-21=E-W      H=8  W=4.75  AZ=270
302.          X=0  Y=19  Z=0
303.          INF-COEF=1.0  CONS=STUD-WL-1  G-R=0.69  S-D=5  G-F-F=0.5  S-F-F=0.5 ..
304.
305. LEFT-WL-22=F-W      H=8  W=14.25  AZ=270  X=0  Y=14.25  Z=0.
306.          INF-COEF=1.5  CONS=INS-WL-1  G-R=0.69  S-D=5  S-F-F=0.5  G-F-F=0.5 ..
307.          WIN-23=W1  H=4  W=2.0  G-T=GT-WIN-3  X=11.7  Y=2.5  SETB=.33
308.          INF-COEF=1.5 ..
309.
310. FLCCR-21=I-W          A=230.
311.          CONS=AIR-FLX-1          TILT=150
312.          N-T=ZCNE-4 ..
313. REAR-RF-21=RCCF      H=14  W=2.375  X=0  Y=14  Z=9.0  AZ=270
314.          INF-COEF=0.0  TILT=0  CONS=STUD-RF-1  S-D=1 ..
315.
316.

```

```

317. REAR-RF-22=ROOF      H=14   W=16.625  X=0     Y=16.625  Z=8.0
318.                      AZ=270  TILT=0    CCNS=INS-RF-1
319. INF-COEF=0.0  S-E=1
320.
321.
322. S-----BUILDING SHADE-----S
323.
324.
325. BUILDING-SHADE      X=0     Y=0     Z=8.0   H=J.0   W=J2.0
326.                      AZ=180  TILT=180  S-ZONE-J  FRCNT OVERHANG -S
327.
328.
329. CONE-3=SPACE-CONDITIONS  FLOOR-WEIGHT=0.0
330.                      FURN-FRACTION=0.50
331.                      FURNITURE-TYPE=LIGHT
332.                      FURN-WEIGHT=0.0
333.                      TEMPERATURE=(70)
334.                      INF-METHOD=CRACK
335.                      N-Z-H=4 ..
336.
337.
338. ZONE-3=SPACE      X=0
339.                      Y=0
340.                      Z=0
341.                      AZIMUTH=0
342.                      AREA=560.
343.                      VOLUME=1468
344.                      S-C=COND-3 ..
345.
346.
347. FRCNT-WL-31=E-W      H=8     W=8     AZ=180  X=0     Y=0     Z=0
348. INF-COEF=0  CCNS=BRK-COSTD  S-D=1  G-R=0.34  G-F-F=0.5  S-F-F=0.5 ..
349.
350. WIN-31 =W1          H=6.8  W=6.0  G-I=GT-WIN-1  X=1.0  Y=0     SETH=.50
351. INF-COEF=8.2 ..
352. FRCNT-WL-32=E-W      H=8     W=16    AZ=180  X=8     Y=0     Z=0
353. INF-COEF=8.2 ..      CCNS=TROMBE-WALL ..
354. FRCNT-WL-33=E-W      H=8     W=8     AZ=180  X=24    Y=0     Z=0
355. INF-COEF=0  CCNS=BRK-COSTD  S-D=1  G-R=0.34  S-F-F=0.5  G-F-F=0.5 ..
356. WIN-33 =W1          H=6.8  W=6     G-I=GT-WIN-1  X=25   Y=0     SETH=.5
357. INF-COEF=8.2 ..
358.
359. RIGHT-WL-31=E-W      H=8     W=2     AZ=90   X=J2    Y=0     Z=0
360. INF-COEF=3.00  CCNS=BRK-COSTD  S-D=5  G-R=0.69  S-F-F=0.5  G-F-F=0.5 ..
361.
362. RIGHT-WL-32=E-W      H=8     W=8.0   AZ=50   X=J2    Y=2     Z=0
363. CCNS=BRK-CONC-1  S-D=5  G-R=0.69  S-F-F=0.5  G-F-F=0.5
364. INF-COEF=3.00 ..
365. LEFT-WL-31=E-W      H=8     W=2     AZ=270  X=0     Y=2.0   Z=0
366. INF-COEF=4  CCNS=BRK-COSTD  S-D=5  G-R=0.69  G-F-F=0.5  S-F-F=0.5 ..
367.
368. LEFT-WL-32=E-W      H=8     W=8.0   AZ=270  X=0     Y=10.   Z=0
369. INF-COEF=4  CCNS=BRK-CONC-1  S-D=5  G-R=0.69  G-F-F=0.5  S-F-F=0.5 ..
370.
371. PART-WL-3 =I-W      H=8.
372.                      W=29.5
373.                      CONS=PART-WL-1
374.                      N-T=ZONE-4 ..
375.
376.
377.
378. ROOF-3 =ROOF      H=4.
379.                      W=32.
380.                      X=0   Y=0   Z=8
381.                      AZ=180  TILT=0.
382. INF-COEF=2      CCNS=INS-CEL-1  S-D=20 ..
383.
384.
385. UNDERGROUND-WALL  CONS=INS-WL-2
386.                      AREA=129 ..
387. UNDERGROUND-WALL  CONS=STUDED-WALL
388.                      AREA=31 ..
389.
390.
391.
392. UNDERGROUND-FLOOR  CCNS=SLAB-1
393.                      AREA=640.  S GRS FLOOR AREA S
394.                      TILT=180 ..
395.

```

```

396. COND-4 =SPACE-CCNDITICNS      FLOOR-WEIGHT=0
397.                                FURN-FRACTION=0.50
398.                                FURNITURE-TYPE=LIGHT
399.                                FURN-WEIGHT=0.0
400.                                TEMPERATURE=(70)
401.                                INF-ME(HOD=RESIDENTIAL
402.                                R-I-C=(0.0,0.0252,0.0C944) ..
403.
404. ZCNE-4=SPACE                  X=0
405.                                Y=20
406.                                Z=0.
407.                                AZIMUTH=0
408.                                AREA=320.
409.                                VOLUME=2560.
410.                                S-C=COND-4 ..
411.
412.
413. UNDERGROUND-WALL             CONS=INS-WL-2
414.                                AREA=355
415.                                ..
416.
417. UNDERGROUND-WALL             CONS=STUDED-WALL
418.                                AREA=90 ..
419.
420.
421.
422. UNDERGROUND-FLOOR            CONS=SLAB-2
423.                                AREA=384. S GRS FLOOR AREAS
424.                                TILT=180 ..
425.
426.
427.
428. LOADS-REPORT VERIFICATION=(ALL-VERIFICATION)
429. SUMMARY=(ALL-SUMMARY) ..
430.
431. S-----HOURLY REPORTS-----S
432.
433. HR-SCH-1 =SCHEDULE             THRU MAR 09 (ALL) (1,24) (0)
434.                                THRU MAR 15 (ALL) (1,24) (1)
435.                                THRU MAR 21 (ALL) (1,24) (0)
436.                                THRU APR 03 (ALL) (1,24) (1)
437.                                THRU APR 08 (ALL) (1,24) (0)
438.                                THRU APR 14 (ALL) (1,24) (1)
439.                                THRU DEC 31 (ALL) (1,24) (0) ..
440.
441.
442. OUT-1 =REPORT-BLOCK            VARIABLE-TYPE=ZCNE-1
443.                                V-L=(1,2,3,4,5,37,41,44) ..
444.
445. OUT-2 =REPORT-BLOCK            V-T=ZCNE-2
446.                                V-L=(1,2,3,4,5,37,41,44) ..
447.
448. OUT-3 =REPORT-BLOCK            V-T=ZCNE-3
449.                                V-L=(1,2,3,4,5,37,41,44) ..
450.
450.1 OUT-4 =REPORT-BLOCK           V-T=ZCNE-4
450.2.                                V-L=(1,2,3,4,5,37,41,44) ..
451.
452. LDS-REP =HOURLY-REPORT          REPORT-SCHEDULE=HR-SCH-1
453. REPORT-BLOCK=(OUT-1,OUT-2,OUT-3,OUT-4) ..
454.
455. END ..
456. COMPUTE LCADS ..
457. INPUT SYSTEMS ..
458.
459. SYSTEMS-REPORT                 VERIFICATION=(ALL-VERIFICATION)
460.                                SUMMARY=(ALL-SUMMARY) ..
461.
462. S-----SYSTEM SCHEDULE-----S
463.
464. HEAT-1 =SCHEDULE                THRU MAR 15 (ALL) (1,24) (70)
465.                                THRU MAR 26 (ALL) (1,24) (70)
466.                                THRU MAR 29 (ALL) (1,24) (70)
467.                                THRU MAR 30 (ALL) (1,24) (70)
468.                                THRU MAR 31 (ALL) (1,24) (70)
469.                                THRU APR 03 (ALL) (1,24) (70)
470.                                THRU APR 08 (ALL) (1,24) (70)
471.                                THRU APR 09 (ALL) (1,24) (70)
472.                                THRU APR 12 (ALL) (1,24) (70)
473.                                THRU DEC 31 (ALL) (1,24) (68) ..

```

479.
480.
481.
482.
483.
484.
485.
486.
487.
488.
489.
490.
491.
492.
493.
494.
495.
496.
497.
498.
499.
500.
501.
502.
503.
504.
505.
506.
507.
508.
509.
510.
511.
512.
513.
514.
515.
516.
517.
518.
519.
520.
521.
522.
523.
524.
525.
526.
527.
528.
529.
530.
531.
532.
533.
534.
535.
536.
537.
538.
539.
540.
541.
542.
543.
544.
545.
546.
547.
548.
549.
550.
551.
552.
553.
554.
555.
556.
557.
558.
559.
560.
561.
562.

THRU APR 02 (ALL) (1,24) (70)
THRU APR 09 (ALL) (1,24) (60)
THRU APR 12 (ALL) (1,24) (60)
THRU DEC 31 (ALL) (1,24) (67.0) ..

HEAT-3 =SCHEDULE THRU MAR 12 (ALL) (1,24) (70)
THRU MAR 13 (ALL) (1,3) (70) (9) (74)
(10,14) (73.5) (15,13) (72) (19,24) (71)
THRU MAR 14 (ALL) (1,8) (70.5) (9) (73)
(10) (74) (11,14) (75) (15)(74) (15,24)
(72.5)
THRU MAR 30 (ALL) (1,24) (70.5)
THRU MAR 31 (ALL) (1,3) (70) (9,20) (73.5)
(21,24) (72)
THRU APR 01 (ALL) (1,3) (71) (9,15) (75)
(16,19) (74) (20,24) (73)
THRU DEC 31 (ALL) (1,24) (70.5) ..

HEAT-4 =SCHEDULE THRU DEC 31 (ALL) (1,24) (70) ..

COOL-1 =SCHEDULE THRU DEC 31 (ALL) (1,24) (95) ..

HEAT-SCH-1 =SCHEDULE THRU DEC 31 (ALL) (1,24) (1) ..
COOL-SCH-1 =SCHEDULE THRU DEC 31 (ALL) (1,24) (0) ..

FAN-1 =SCHEDULE THRU DEC 31 (ALL) (1,24) (0) ..

S-----ZONE DESCRIPTION-----S

ZONE-1 =ZONE DESIGN-HEAT-T=70
HEAT-TEMP-SCH=HEAT-1
DESIGN-COOL-T=78
COOL-TEMP-SCH=COOL-1
ASSIGNED-CFM=10.
BASEBOARD-CTRL=THERMOSTATIC
THERMOSTAT-TYPE=TWO-POSITION
ZONE-TYPE=CONDITIONED
BASEBOARD-RATING=-20415 ..

ZONE-2 =ZONE DESIGN-HEAT-T=70
HEAT-TEMP-SCH=HEAT-2
DESIGN-COOL-T=78
COOL-TEMP-SCH=COOL-1
ASSIGNED-CFM=10.
BASEBOARD-CTRL=THERMOSTATIC
THERMOSTAT-TYPE=TWO-POSITION
ZONE-TYPE=CONDITIONED
BASEBOARD-RATING=-597J ..

ZONE-3 =ZONE DESIGN-HEAT-T=70
HEAT-TEMP-SCH=HEAT-3
DESIGN-COOL-T=78
COOL-TEMP-SCH=COOL-1
ASSIGNED-CFM=10.
BASEBOARD-CTRL=THERMOSTATIC
THERMOSTAT-TYPE=TWO-POSITION
ZONE-TYPE=CONDITIONED
BASEBOARD-RATING=-27304 ..

ZONE-4 =ZONE DESIGN-HEAT-T=70
HEAT-TEMP-SCH=HEAT-4
DESIGN-COOL-T=78
COOL-TEMP-SCH=COOL-1
ASSIGNED-CFM=10.
BASEBOARD-CTRL=THERMOSTATIC
THERMOSTAT-TYPE=TWO-POSITION
ZONE-TYPE=CONDITIONED
BASEBOARD-RATING=-700J ..

SYS-1 =SYSTEM SYSTEM-TYPE=RESYS
MAX-SUPPLY-T=150
MIN-SUPPLY-T=50
SUPPLY-CFM=10.
HEATING-SCHEDULE=HEAT-SCH-1
COOLING-SCHEDULE=COOL-SCH-1

```

563. FAN-SCHEDULE=FAN-1
564. SUPPLY-KW=0.
565. CRANKCASE-HEAT=0.
566. HEATING-CAPACITY=-864
567. FURNACE-AUX=0.
568. BASEBOARD-SOURCE=ELECTRIC
569. ZONE-NAMES=( ZCNE-1 ) ..
570.
571. SYS-2 =SYSTEM SYSTEM-TYPE=RESYS
572. MAX-SUPPLY-T=150
573. MIN-SUPPLY-T=50
574. SUPPLY-CFM=10.
575. HEATING-SCHEDULE=HEAT-SCH-1
576. COOLING-SCHEDULE=CCOL-SCH-1
577. FAN-SCHEDULE=FAN-1
578. SUPPLY-KW=0.
579. CRANKCASE-HEAT=0.
580. HEATING-CAPACITY=-864
581. FURNACE-AUX=0
582. BASEBOARD-SOURCE=ELECTRIC
583. ZONE-NAMES=( ZCNE-2 ) ..
584.
585.
586. SYS-3 =SYSTEM SYSTEM-TYPE=RESYS
587. MAX-SUPPLY-T=150
588. MIN-SUPPLY-T=50
589. SUPPLY-CFM=10.
590. HEATING-SCHEDULE=HEAT-SCH-1
591. COOLING-SCHEDULE=CCOL-SCH-1
592. FAN-SCHEDULE=FAN-1
593. SUPPLY-KW=0.
594. CRANKCASE-HEAT=0.
595. HEATING-CAPACITY=-864
596. FURNACE-AUX=0
597. BASEBOARD-SOURCE=ELECTRIC
598. ZONE-NAMES=( ZCNE-3 ) ..
599.
600.
601. SYS-4 =SYSTEM SYSTEM-TYPE=RESYS
602. MAX-SUPPLY-T=150
603. MIN-SUPPLY-T=50
604. SUPPLY-CFM=10.
605. HEATING-SCHEDULE=HEAT-SCH-1
606. COOLING-SCHEDULE=CCOL-SCH-1
607. FAN-SCHEDULE=FAN-1
608. SUPPLY-KW=0.
609. CRANKCASE-HEAT=0.
610. HEATING-CAPACITY=-864
611. FURNACE-AUX=0
612. BASEBOARD-SOURCE=ELECTRIC
613. ZONE-NAMES=( ZCNE-4 ) ..
614.
615. PLANT-1 =PLANT-ASSIGNMENT SYSTEM-NAMES=( SYS-1, SYS-2, SYS-3, SYS-4 ) ..
616.
617.
618. S-----HOURLY REPORT-----S
619. HR-SCH-1 =SCHEDULE THRU MAR 07 (ALL) (1,24) (0)
620. THRU MAR 15 (ALL) (1,24) (1)
621. THRU MAR 19 (ALL) (1,24) (0)
622. THRU APR 03 (ALL) (1,24) (1)
623. THRU APR 05 (ALL) (1,24) (0)
624. THRU APR 14 (ALL) (1,24) (1)
625. THRU DEC 31 (ALL) (1,24) (0) ..
626.
627. OUT-1 =R-B V-T=GLOBAL
628. V-L=( 7,8,10,12 ) ..
629.
630. OUT-2 =R-B V-I=ZCNE-1
631. V-L=( 5,6,15 ) ..
632.
633. OUT-3 =R-B V-T=ZCNE-2
634. V-L=( 5,6,15 ) ..
635.
636. OUT-4 =R-B V-I=ZCNE-3
637. V-L=( 3,6,15 ) ..
638.
639. OUT-5 =R-B V-I=ZCNE-4
640. V-L=( 6,15 ) ..
641.
642. OUT-6 =R-B V-T=SYS-1

```

```

043.          V-L=(9,46) ..
044.
045. OUT-7      =R-B          V-I=SYS-2
046.          V-L=(9,46) ..
047.
048. OUT-8      =R-B          V-T=SYS-3
049.          V-L=(9,46) ..
050.
051. OUT-9      =R-B          V-T=SYS-4
052.          V-L=(9,46) ..
053.
054.
055. SYS-REP    =H-R          R-SCH=HR-SCH-1
056.          R-B      =(CUT-1,OUT-2,OUT-3,OUT-4,
057.                    CUT-5,OUT-6,OUT-7,OUT-8,OUT-9) ..
058.
059.
060. END ..
061. CCMPUTE SYSTEMS ..
062. INPUT PLANT ..
063.
064.          S---PLANT INPUT WITH ONE PRICE OF EQUIPMENT---S
065.          S---TO GET BEPS REFCR I---S
066.
067.          PLANT-REPORT          SUMMARY=(BEPS,PS-H) ..
068.
069.          S---DUMMY PLANT EQUIPMENT---S
070.
071. DUW-1      =PLANT-EQUIPMENT  TYPE=COOLING-1R  SIZE=0.001 ..
072.
073.
074. END ..
075. COMPUTE PLANT ..
076. STOP ..
077. //SETEPOS.FTOSH001 DD DSN=MENG.DOE2.VEATH.WEAILY,
078. // DISP=SHR,UNIT=3J30,VOL=SER=DISK01
079. //

```

VITA AUCTORIS

- 1954 Borned at Abbottabad, Pakistan, on November 28,
1954.
- 1969 Completed Higher Secondary Education from
Senior Burns Hall School, Abbottabad, Pakistan.
- 1972 Completed college education from Government
Degree College, Abbottabad, Pakistan.
- 1976 Received the Degree of Bachelor of Science in
Mechanical Engineering (First Class Hons)
from Engineering College, University of
Peshawar, Pakistan.
- 1980 Worked for four years as a project engineer for
Klien Schanzlin & Becker Pumps Manufacturing
Company Ltd, Lahore, Pakistan.
- 1983 Currently a candidate for the Degree of Master
of Applied Science in Mechanical Engineering at
the University of Windsor, Windsor, Ontario,
Canada.