

Utah State University

DigitalCommons@USU

---

Presentations

Materials Physics

---

5-8-2017

## Of Mice and Materials: Payoffs of UNSGC Research Infrastructure Awards

JR Dennison  
*Utah State University*

Kent Hartley  
*Utah State University*

Lisa Phillipps  
*Utah State University*

Justin Dekany  
*Utah State University*

Robert H. Johnson  
*Utah State University*

James S. Dyer  
*Space Dynamics Laboratory, Utah State University*

Follow this and additional works at: [https://digitalcommons.usu.edu/mp\\_presentations](https://digitalcommons.usu.edu/mp_presentations)

 Part of the [Condensed Matter Physics Commons](#)

---

### Recommended Citation

JR Dennison, "Of Mice and Materials: Payoffs of UNSGC Research Infrastructure Awards," Utah NASA Space Grant Consortium Annual Meeting, May 8, 2017, Weber State University, Ogden, UT.

This Presentation is brought to you for free and open access by the Materials Physics at DigitalCommons@USU. It has been accepted for inclusion in Presentations by an authorized administrator of DigitalCommons@USU. For more information, please contact [digitalcommons@usu.edu](mailto:digitalcommons@usu.edu).



# *Of Mice and Materials: Payoffs of UNSGC Research Infrastructure Awards*

**J.R. Dennison**

*Materials Physics Group  
Physics Department, Utah State University*



Utah NASA Space Grant Consortium Annual Meeting  
Weber State University  
May 8, 2017



### Small Satellite Space Environments Effects Test Facility

JR Dennison,<sup>1</sup> Kent Hartley,<sup>1,2</sup> Lisa Phillipps,<sup>1,2</sup> Justin Dekany,<sup>1</sup> and Robert H. Johnson,<sup>1,2,3</sup>  
 Physics Department, Logan, UT 84322-4415 USA; (435) 797-2936  
[JR.Dennison@USU.edu](mailto:JR.Dennison@USU.edu)

James S. Dyer  
 Space Dynamics Laboratory, Utah State University  
 North Logan, UT 84341 USA; (435) 713-3545  
[Jim.Dyer@SDL.USU.edu](mailto:Jim.Dyer@SDL.USU.edu)

<sup>1</sup> Materials Physics Group, Physics Department, Utah State University  
<sup>2</sup> Mechanical Engineering Department, Utah State University  
<sup>3</sup> Kern River Gas Transmission Company

#### ABSTRACT

A versatile test facility has been designed and built to study space environments effects on small satellites and system components. Testing for potentially environmental-induced modifications of small satellites is critical to avoid possible deleterious or catastrophic effects over the duration of space mission. This is increasingly more important as small satellite programs have longer mission lifetimes, expand to more harsh environments (such as polar or geosynchronous orbits), make more diverse and sensitive measurements, minimize shielding to reduce mass, and utilize more compact and sensitive electronics (often including untested off-the-shelf components). The vacuum chamber described here is particularly well suited for cost-effective, long-duration tests of modifications due to exposure to simulated space environment conditions for CubeSats, system components, and small scale materials samples of >10 cm X 10 cm. The facility simulates critical environmental components including the neutral gas atmosphere, the FUV/UV/VIS/NIR solar spectrum, electron plasma fluxes, and temperature. The solar spectrum (~120 nm to 2500 nm) is simulated using an Solar Simulator and Kr resonance lamps at up to four Suns intensity. Low and intermediate electron flood guns and a Sr<sup>90</sup>  $\beta$  radiation source provide uniform, stable, electron flux (~20 eV to 2.5 MeV) over the CubeSat surface at >5X intensities of the geosynchronous spectrum. Stable temperatures from 100 K to 450 K are possible. An automated data acquisition system periodically monitors and records the environmental conditions, sample photographs, UV/VIS/NIR reflectivity, IR absorptivity/emissivity, and surface voltage over the CubeSat face and *in situ* calibration standards during the sample exposure cycle.

#### INTRODUCTION

To paraphrase Douglas Adams,<sup>1</sup> "Space is [harsh]. You just won't believe how vastly, hugely, mind-bogglingly [harsh] it is." Interactions with this harsh space environment can modify materials and cause unforeseen and detrimental effects to spacecrafts.<sup>2,3</sup> If these are severe enough the spacecraft will not operate

properties of surface and bulk materials as a result of prolonged exposure to the space environment has been identified as one of the critical areas of research in spacecraft charging.<sup>18</sup> Further, materials modifications can change the satellite environment, leading to feedback mechanisms for further spacecraft responses.<sup>17</sup>





# The Poster Child for Space Environment Effects

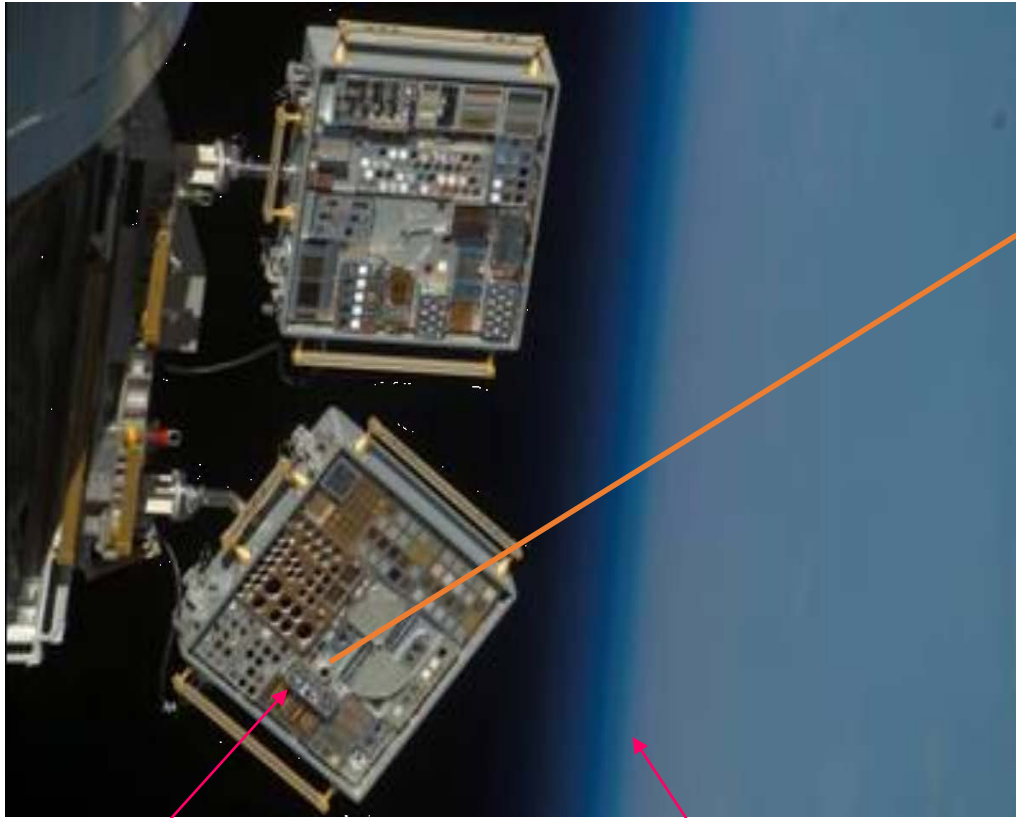

USU MISSIE SUSpECS II Sample Tray

Logan, UT



Ag coated Mylar with micrometeoroid impact

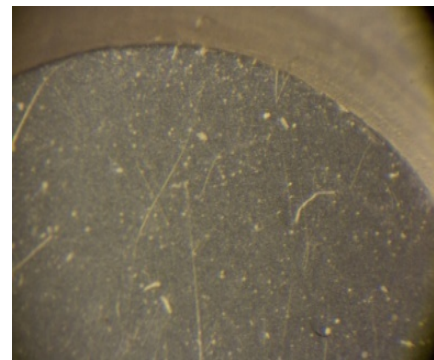

Before

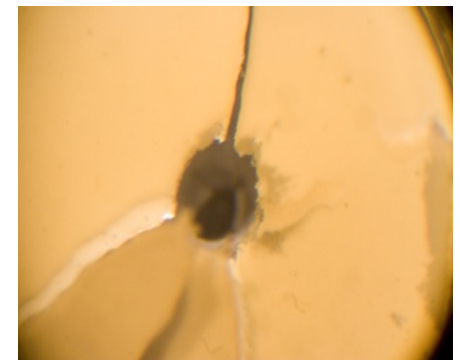

After

# Complex dynamic interplay between space environment, satellite motion, and materials properties

## Facilities & Capabilities

### Sample Characterization & Preparation

- Bulk composition (AA, IPC).
- Surface contamination (AES, AES mapping ESD).
- Surface morphology (SEM, optical microscopy).

### Conduction Related Properties:

- Bulk & surface conductivity.
- High resistivity testing.
- Capacitance, dielectric constant, charge decay monitoring, and electrostatic discharge.

### Electron Induced Emission:

- Total, secondary and backscattered yield vs. incident energy and angle.
- Energy-, angle-resolved emission spectra.
- Cathodoluminescence

### Ion Induced Emission:

- Total electron and ion yield versus incident energy and angle.

### Photon Induced Emission:

- Total electron yield vs photon energy.
- Energy-angle resolved photoelectron yield cross-sections.

### Electron Induced Arcing:

- Four ultrahigh vacuum chambers for **electron emission tests** equipped with electron, ion, and photon sources, detectors, and surface analysis capabilities.
- Two high vacuum chambers for **resistivity tests**.
- High vacuum chamber for **electrostatic breakdown tests**.
- Ultrahigh vacuum chamber for **pulsed electro acoustic** measurements of internal charge distributions.

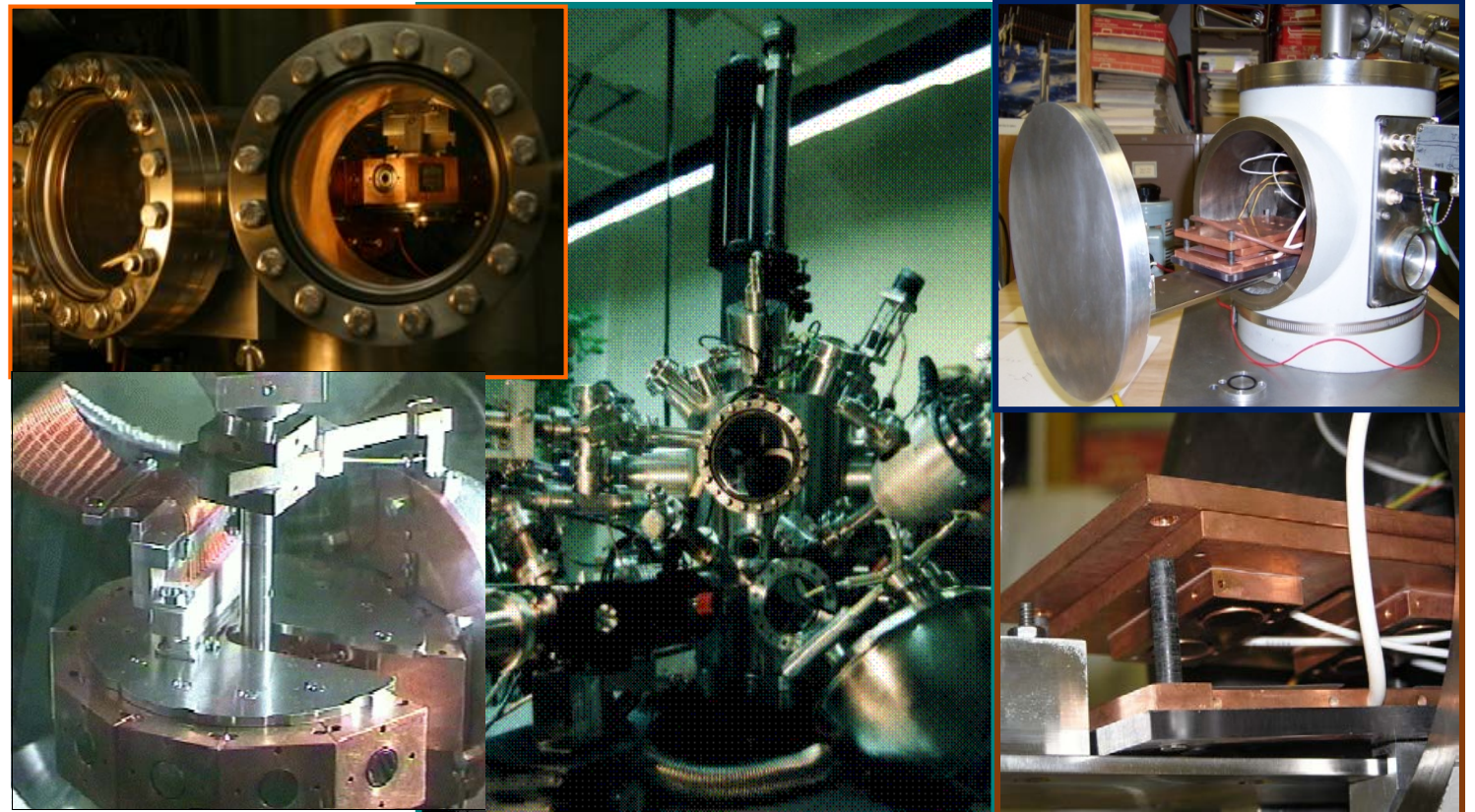

# A Materials Physics Approach to the Problem

Measurements with many methods...

Interrelated through a...

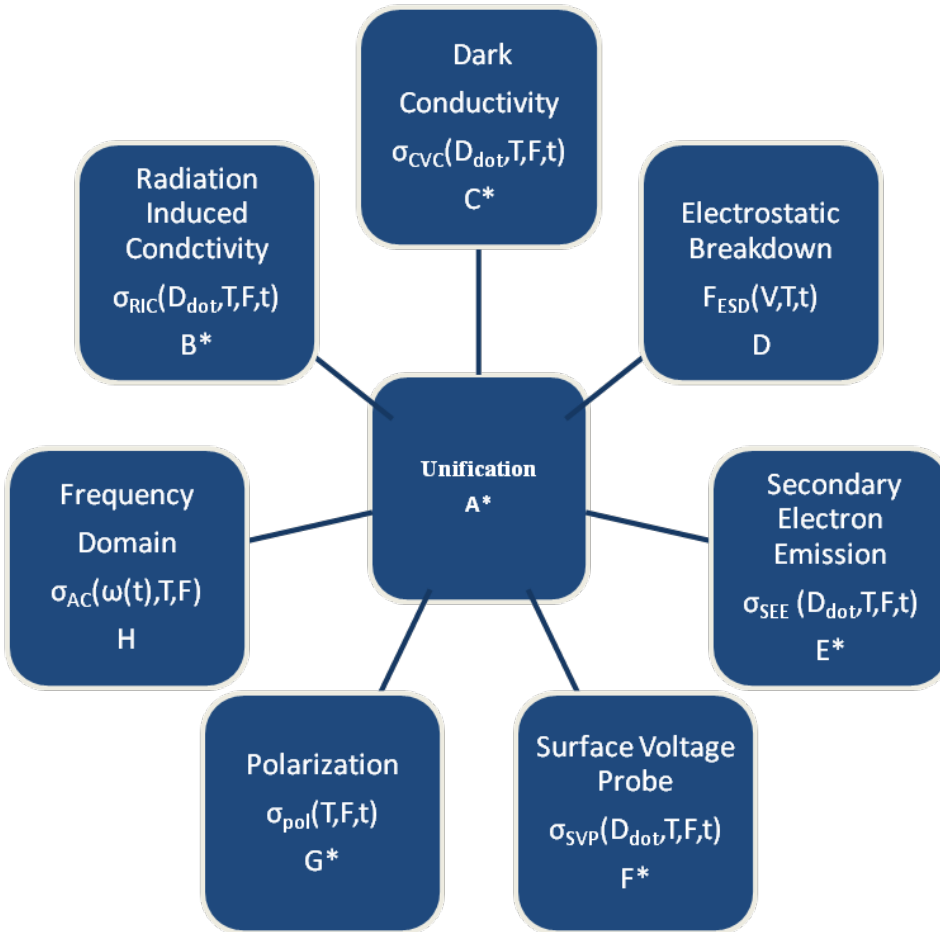

Complete set of dynamic transport equations

$$J = q_e n_e(z, t) \mu_e F(z, t) + q_e D \frac{dn_{tot}(z, t)}{dz}$$

$$\frac{\partial}{\partial z} F(z, t) = q_e n_{tot} / \epsilon_0 \epsilon_r$$

$$\frac{\partial n_{tot}(z, t)}{\partial t} - \mu_e \frac{\partial}{\partial z} [n_e(z, t) F(z, t)] - q_e D \frac{\partial^2 n_e(z, t)}{\partial z^2} = N_{ex} -$$

$$\alpha_{er} n_e(z, t) n_{tot}(z, t) + \alpha_{et} n_e(t) [N_t(z) - n_t(z, t)]$$

$$\frac{dn_h(z, t)}{dt} = N_{ex} - \alpha_{er} n_e(z, t) n_h(z, t)$$

$$\frac{dn_t(z, \epsilon, t)}{dt} = \alpha_{et} n_e(z, t) [N_t(z, \epsilon) - n_t(z, \epsilon, t)] -$$

$$\alpha_{te} N_e \exp\left[-\frac{\epsilon}{kT}\right] n_t(z, \epsilon, t)$$

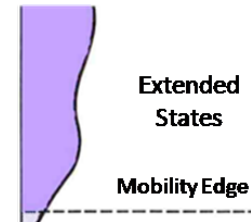

...written in terms of spatial and energy distribution of electron trap states

Disordered Localized States

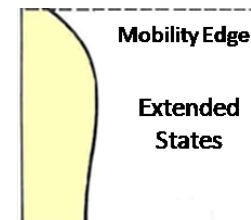



# USU Space Survivability Test Chamber

Utah NASA Space Grant Consortium Faculty Research Infrastructure Award Program, "Space Survivability Test Facility for CubeSats, Components and Spacecraft Materials," JR Dennison, (April 2016 to April 2017).

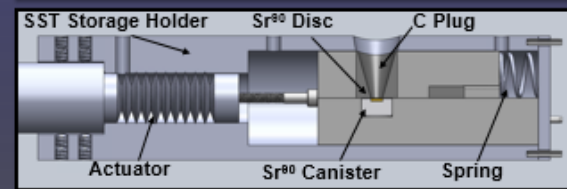
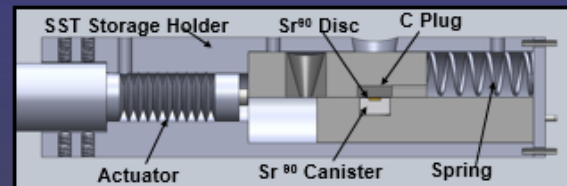
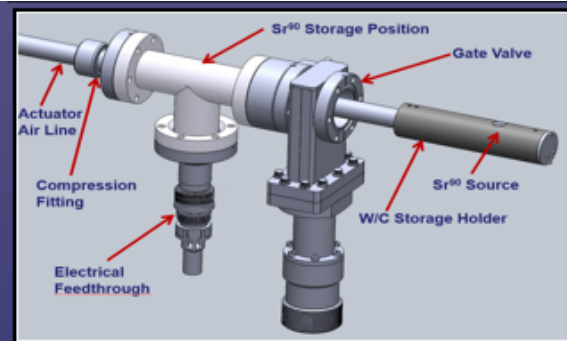
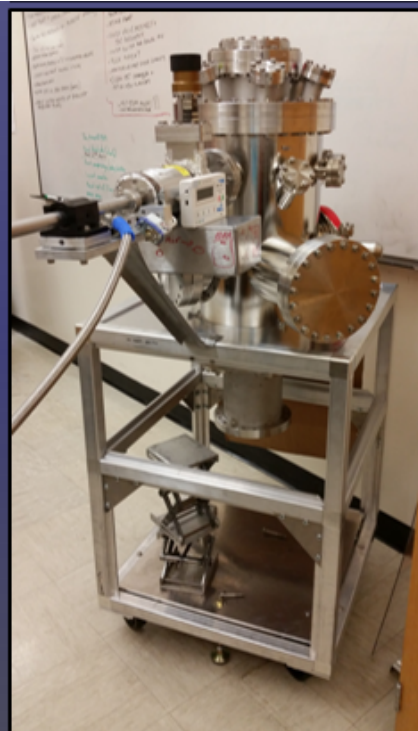
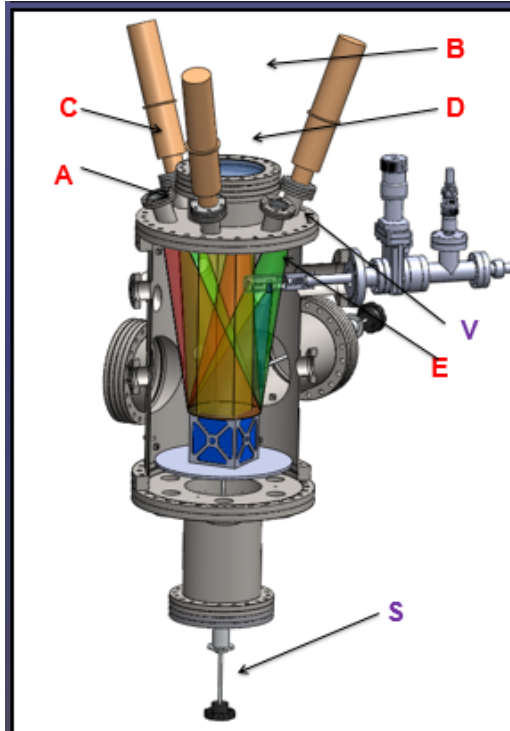

## Radiation Sources

- A High Energy Electron Gun
- A' Low Energy Electron Gun
- B UV/NIS/NIR Solar Simulator
- C FUV Kapton Discharge Lamps
- D Air Mass Zero Filter Set
- E Flux Mask
- E' Sr<sup>90</sup> Radiation Source

## Analysis Components

- F UV/VIS/NIR Reflectivity Spectrometers
- G IR Emissivity Probe
- H Integrating Sphere
- I Photodiode UV/VIS/NIR Flux Monitor
- J Faraday Cup Electron Flux Monitor
- K Platinum Resistance Temperature Probe

## Sample Carousel

- L Samples
- M Rotating Sample Carousel
- N Reflectivity/Emissivity Calib. Standards
- O Resistance Heaters
- P Cryogen Reservoir

## Chamber Components

- Q Cryogen Vacuum Feedthrough
- R Electrical Vacuum Feedthrough
- S Sample Rotational Vacuum Feedthrough
- T Probe Translational Vacuum Feedthrough
- U Sapphire UV/VIS Viewport
- V MgF<sub>2</sub> UV Viewport
- W Turbomolecular/Mech. Vacuum Pump
- X Ion Vacuum Pump
- Y Ion/Convectron Pressure Gauges
- Z Residual Gas Analyzer

## Chamber Components

- α CubeSat
- β CubeSat Test Fixture
- Γ Radiation Shielding
- Δ COTS Electronics
- ε Rad Hard Breadboard
- η COTS Text Fixture
- θ Electron Gun

## Instrumentation (Not Shown)

- Data Acquisition System
- Temperature Controller
- Electron Gun Controller
- UV/VIS/NIR Solar Simulator Controller
- FUV Kr Resonance Lamp Controller
- Spectrometers and Reflectivity Source



# UNSGC 2016 Infrastructure Grant

## Simulated Space Environment Fluxes

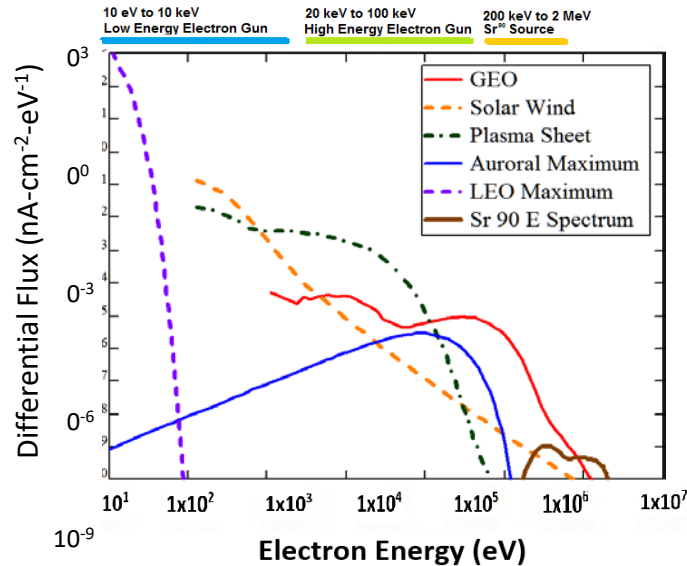

## Electron Radiation

A high energy (~10-80 keV) and three lower energy (~10 eV to 5 keV) electron guns provide high electron fluxes.

## Ionizing Radiation

A 100 mCi encapsulated Sr<sup>90</sup> β-radiation source (~200 keV to >2.5 MeV) mimics high energy (~500 keV to 2.5 MeV) geostationary electron flux [2].

## Infrared/Visible/Ultraviolet Flux

A commercial Class AAA solar simulator provides NIR/Vis/UVA/UVB electromagnetic radiation (from 200 nm to 1700 nm) at up to 4 times sun equivalent intensity.

## Far Ultraviolet Flux

Kr resonance lamps provide FUV radiation flux (ranging from 10 to 200 nm) at 4X sun equivalent intensity. Kr bulbs have ~3 month lifetimes for long duration studies.

## Temperature Control

Temperature range from 60 K [4] to 450 K is maintained to ±2 K [3]. This is achieved through cartridge heaters, and chilled fluid pumped through a cold plate.

## Controlled Atmosphere and Vacuum

Ultrahigh vacuum chamber allows for pressures <10<sup>-7</sup> Pa to simulate LEO.

## Video Discharge Monitoring

Using custom developed software, live video capture and processing of electrostatic discharge events allows for visual identification of discharge location and frequency.

## Flexible Sample Mounting

A rotating graphite carousel, ensures uniform irradiation and allows for custom mounting of samples. Or a flange mounted fixture allows for electrostatic discharge testing. Radiation source to sample distance is adjustable.

## Biological Testing

Biological samples, which are vacuum incompatible, can use a custom designed chamber with controlled atmosphere and temperature.

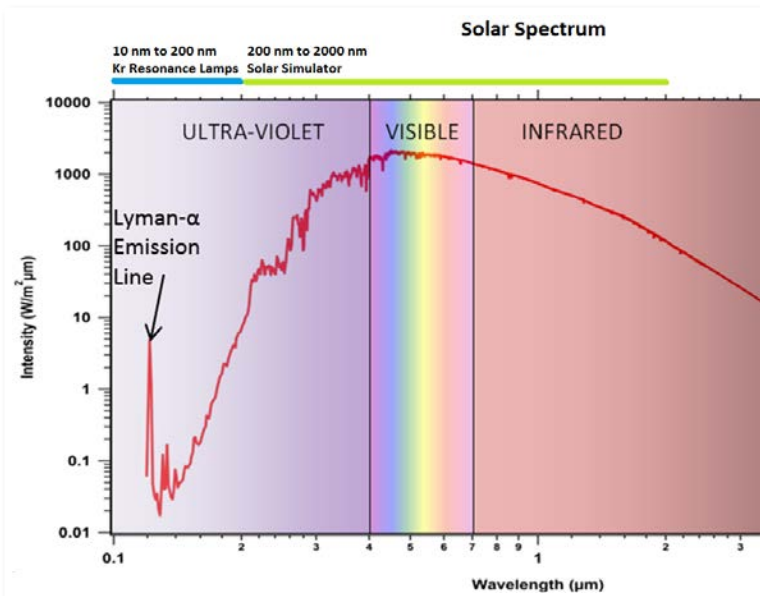



# SST Chamber Components Developed Under UNSGC Infrastructure Award

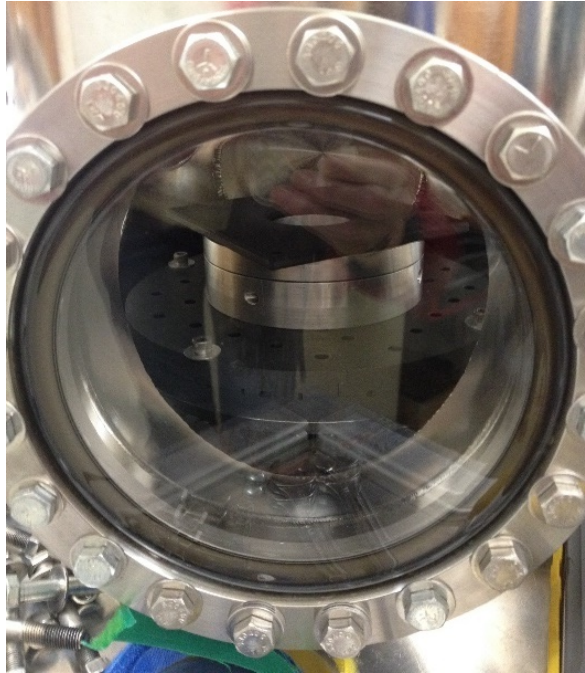

**Biological  
Test  
Chamber**

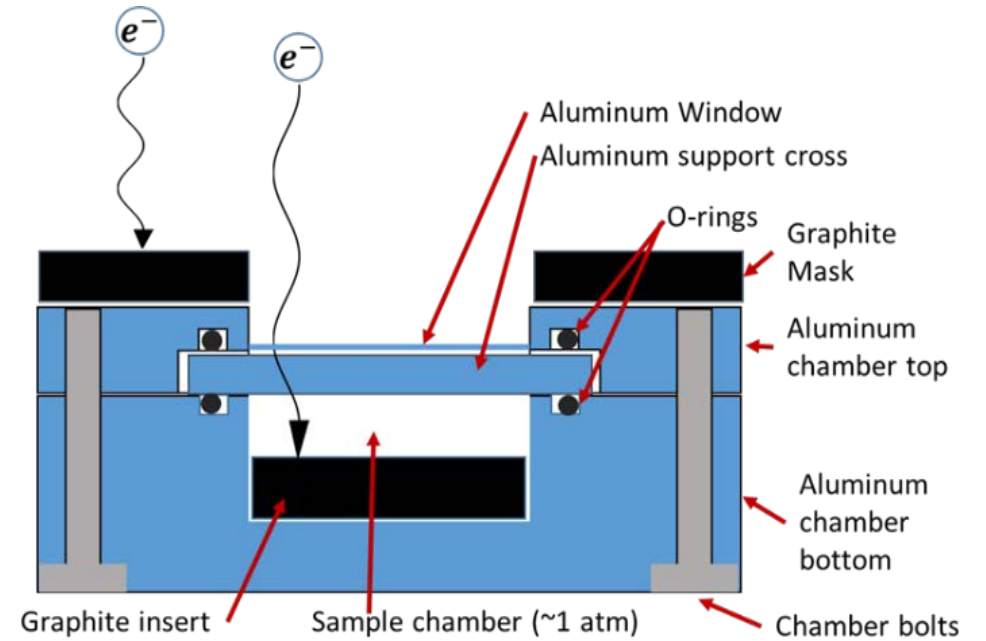

**Custom  
Designed  
SST Sr<sup>90</sup>  
Radiation  
Source**

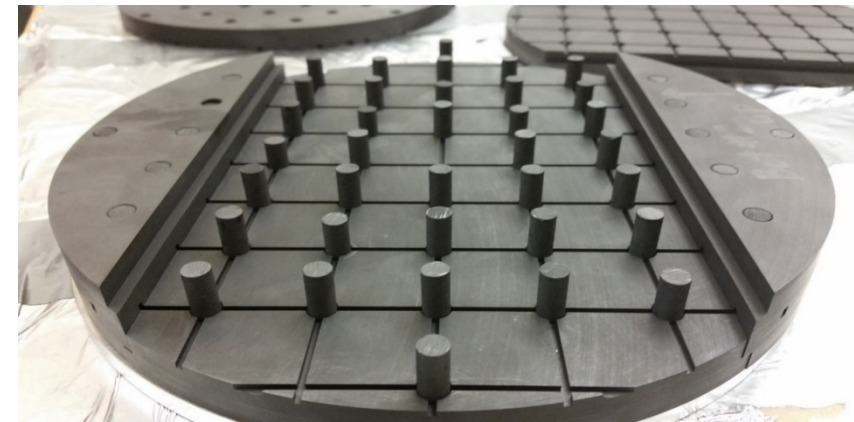
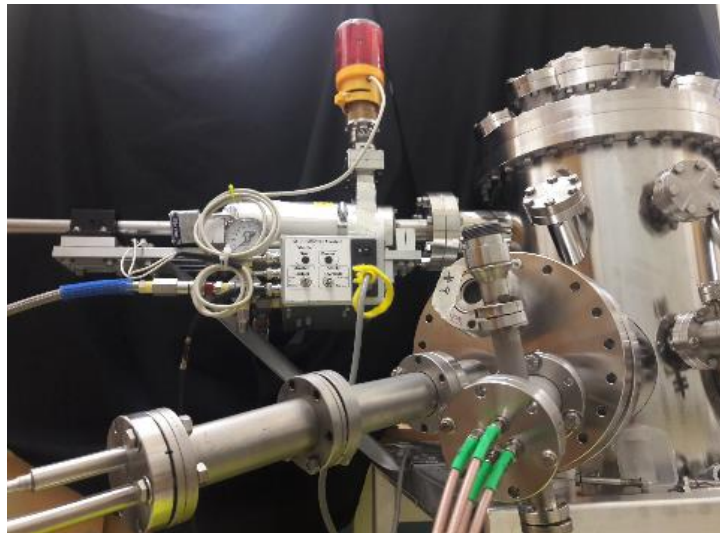

**Radiation  
Absorbent  
Sample  
Mount**

# Telecommunications Component Viability

High frequency RF antenna dielectric components used on telecommunications satellites were tested in orbital conditions. Electrostatic discharge events induced by  $\beta$ -radiation were monitored and characterized using both video and current monitoring to identify the frequency, location, and magnitude of discharges. Effect of temperature ( $\sim 10^\circ\text{C}$  to  $60^\circ\text{C}$ ) on discharge characteristics was tested over a full orbital cycles of several days.

*Funded by ViaSat.*

*Irradiation tests of electron transport properties of PEEK materials for NASA Europa Clipper Mission. Funded--NASA JPL*

*VUV degradation of communications satellite antennas and thermal control coatings. Funded--Proprietary space industry funding.*

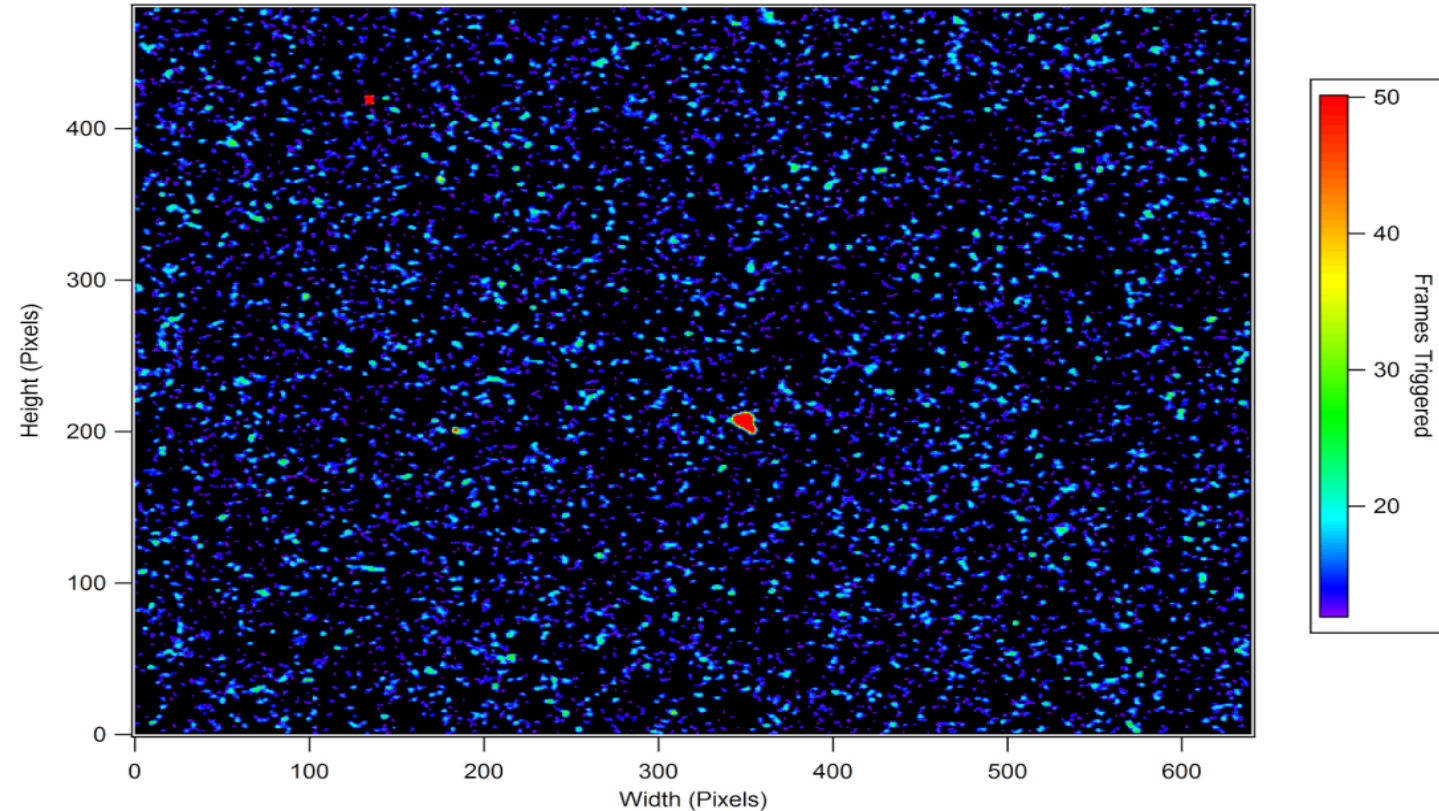



# Mission Lifetime Survivability of Space Grade Electronic Components

High performance RF communications cabling underwent accelerated testing simulating the duration of a full multi-year mission. In-Situ permittivity characterization was performed to understand the long-term cumulative effects of  $\beta$ -radiation on cable properties including frequency response and power loss. Additionally, electrostatic discharge was monitored and characterized using video and current monitoring. This provided understanding of charge accumulation and discharge induced by  $\beta$ -radiation within the samples.

*Funded by Times Microwave.*

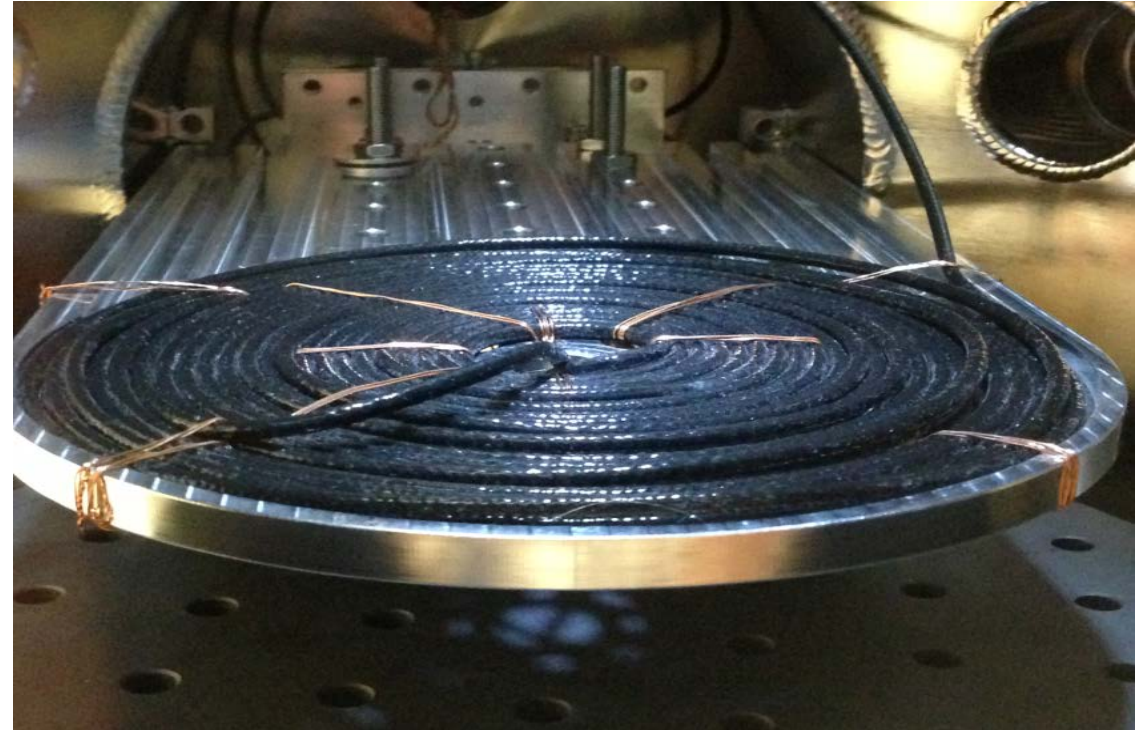

Testing of New Spacecraft Propulsion Engineering Designs Equipment to be flown on a Terrier Malamute rocket to test hybrid thruster designs. Proposed by USU Engineering Department in conjunction with a NASA Undergraduate Student Instrument Project (USIP).



# Microcontroller Radiation Hardening

Microcontrollers are essential satellite components, but radiation hardened electronics can be prohibitively expensive for CubeSat missions. Testing of economical Commercial-Off-The-Shelf (COTS) electronic components is necessary to determine their viability for replacing radiation hardened electronics. Tests showed that the Arduino ceased to function properly after ~250 Gy exposure.

*USU Physics Senior Project.*

*$\beta$  radiation TID effects on electronic components.*

*Funded-- Space Dynamics Lab.*

*Funds Pending--Proprietary Space Flight Industry.*

*Project Proposed--SparkFun*

*Radiation induced conductivity (RIC) of perovskite dielectric materials by total ionizing dose (TID).*

*Funding pending from DOE Sandia National Labs.*

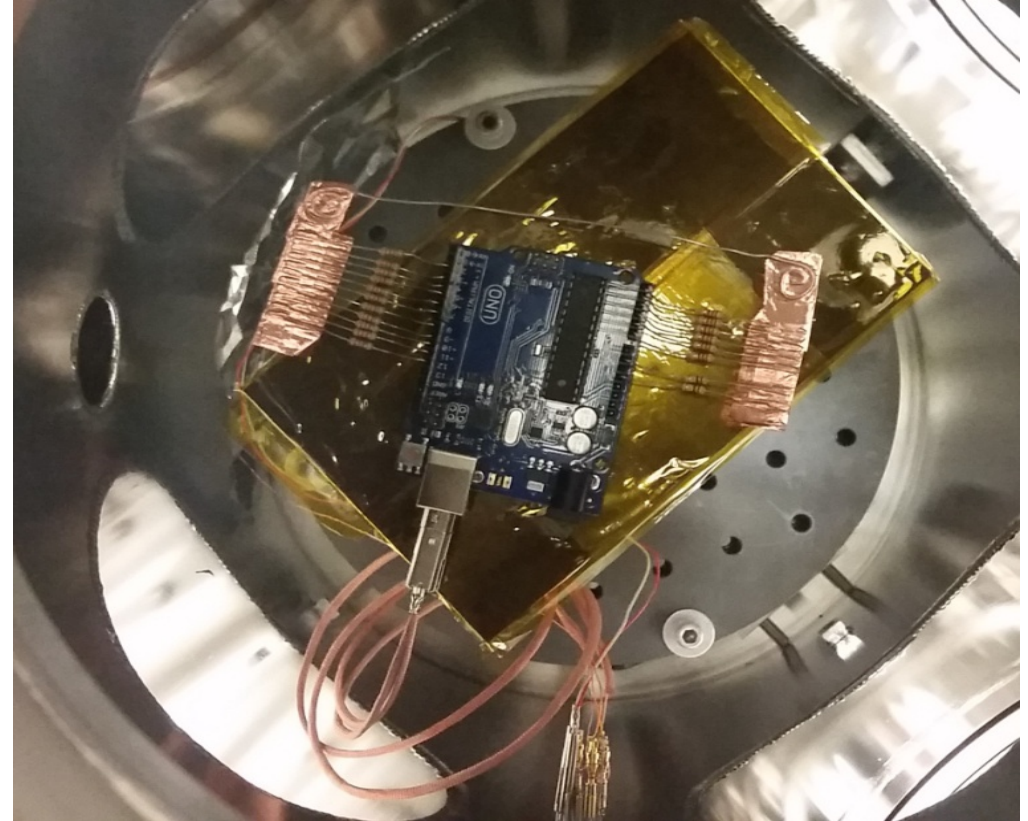

# Viability of Plant Growth in Space

Radish seeds flown on the Russian BION-M1 mission were observed by Logan High School students to have faster germination rates than control, ground based radish seeds. Seeds were tested in the SST to test if radiation was the cause of this change in germination rate. A biological test chamber, designed by University Tsukuba students, housed the seeds in a controlled atmosphere for safe testing in the SST vacuum.

*Partial funding through the DoEd USUStars Gear Up Program. Partial funding through the Japan Tsukuba University Student Space Collaboration Program.*

**NASA: Proposals for the Russian Bion-M2 Mission with USU MPG, USUStars Gear Up Program, and Tsukuba University.**

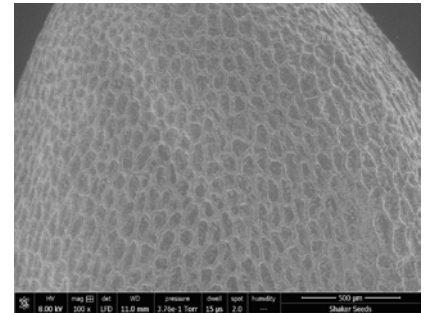
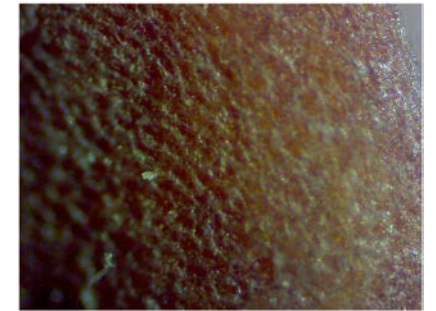
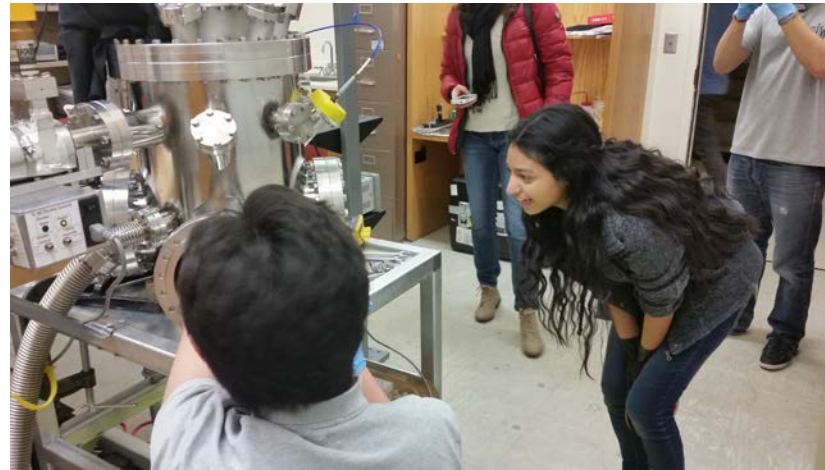
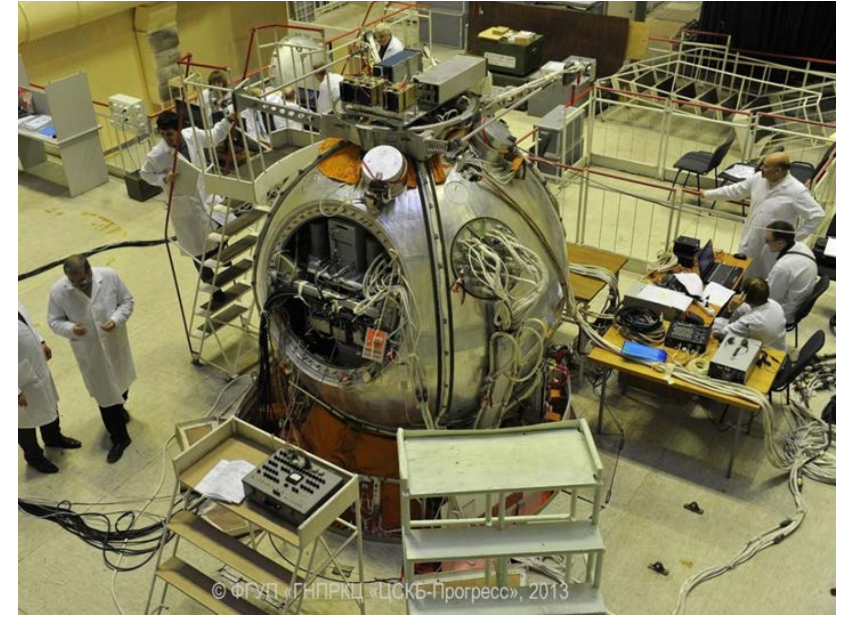



# Space Environment Effects on Muscle and Skeletal Cells

*In-Vitro* tests of muscles cells irradiated in the SST and biological test chamber have been . The effects of radiation on muscle cells will progress work in cardiovascular disease and degenerative tissue risks from space radiation. **Partially Funded by UNSGC Graduate Fellowship.**

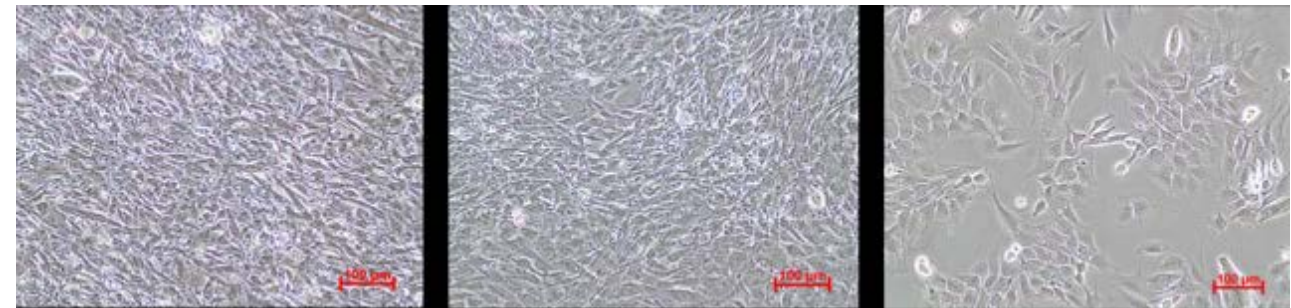
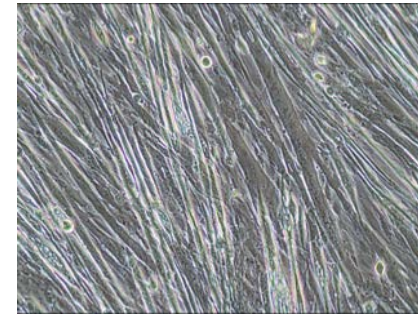

A collaborative follow-on will support further development of the physiological effects of ionizing radiation. **2017 UNSGC Infrastructure award for Elizabeth Vargas in USU Bioengineering.**

Elizabeth Vargas, JR Dennison, Jon Takemoto, “Optimized Cardiac Tissue Models to Evaluate Countermeasures to Weightlessness and Spaceflight Radiation”. **In preparation. NASA Space Radiobiology and Human Health Countermeasures Topics.**



# Related Funding and Publications

## RESEARCH FUNDING

### *Pending Funding*

SpaceX, "UV Degradation of SpaceX Thermal Control Materials," JR Dennison, (\$20,863, April 2017 to February 2018).

SpaceX, "Electron Emission Studies of SpaceX Coating Materials," JR Dennison, (\$9,481, July 2017 to February 2018).

SpaceX, "Electron Transport Studies of Space X Coating Materials," JR Dennison, (\$14,261, June 2017 to December 2017).

### *Current and Recent Funding*

Utah NASA Space Grant Consortium Faculty Research Infrastructure Award Program, "Effects of Space Ionizing Radiation on Cell Viability," Elizabeth Vargas with JR Dennison, (\$20,000, April 2017 to April 2018).

Air Force Office of Scientific Research, Defense University Research Instrumentation Program (DURIP), "Enhanced Test Facility for Survivability and Characterization of Evolving Multiscale Materials in Extreme Plasma Environments," JR Dennison, (\$498,869, January 2017-to December 2019).

Space Dynamics Laboratory IR&D, "Radiation Modification of Space Flight CCD Array," JR Dennison, (\$8,450, July 2016 to March 2017).

ViaSat, "Simulated Space Radiation Effects on Spacecraft Components: Phase I and II," JR Dennison, (\$76,191, May 2016 to December 2016); Phase III," JR Dennison, (\$38,403, October 2016 to February 2017).

Lockheed Martin, "Electron Emission Studies of Orion Backshell Materials," JR Dennison, (\$24,000, May 2016 to April 2017).

Utah NASA Space Grant Consortium Faculty Research Infrastructure Award Program, "Space Survivability Test Facility for CubeSats, Components and Spacecraft Materials," JR Dennison, (\$20,931, April 2016 to April 2017).

Times Microwave Systems, "Deep charging effects of GEOS environment on coaxial cable," JR Dennison, (\$35,593, May 2016 to December 2017).

## STUDENT FUNDING:

USU Undergraduate Research and Creative Opportunities (URCO), "Temperature Dependence of Electrostatic Breakdown in Highly Disordered Polymers," (\$2,000, January 2017 to June 2017) [for Trevor Kippen with Allen Andersen and J.R. Dennison].

USU Undergraduate Research and Creative Opportunities (URCO), "Degradation Effects of Ionizing Radiation on Commercially Available Spacecraft Components," (\$2,350, June 2016 to December 2016) [for Alex Souvall with Greg Wilson and J.R. Dennison].

NASA Utah Space Grant Consortium Graduate Student Fellowship, "Multilayer Models of Electron Emission and Charge Transport with Spacecraft Charging Applications." (\$30,000, September 2015 to August 2016) [for Greg Wilson with J.R. Dennison].

### *Past Funding*

NASA Utah Space Grant Consortium Graduate Student Fellowship, "Electron Yield Measurements of High-Yield Low Conductivity Dielectric Materials." (\$15,000, September 2015 to August 2016) [for Justin Christensen with J.R. Dennison].

USU Physics Department Undergraduate Student Summer Research Internship, "Development and Applications for the Space Survivability Test Chamber." (\$2,000, May 2015 to August 2015) [for Heather Tippetts with J.R. Dennison].

## RELATED PUBLICATIONS

Greg Wilson and JR Dennison, "Hemispherical Grid Retarding Field Analyzer Redesign for Secondary Electron Emission Studies," *Proceedings of the Utah NASA Space Grant Consortium Research Symposium*, May 8, 2017, Weber State University, Ogden, UT, 9 pp.

Robert H. Johnson, Lisa D. Montierth, JR Dennison, James S. Dyer, and Ethan Lindstrom, "Small Scale Simulation Chamber for Space Environment Survivability Testing," *IEEE Trans. on Plasma Sci.*, **41**(12), 2013, 3453-3458.

JR Dennison, Kent Hartley, Lisa Montierth Phillipps, Justin Dekany, James S. Dyer, and Robert H. Johnson, "Small Satellite Space Environments Effects Test Facility," *Proceedings of the 28th Annual AIAA/USU Conference on Small Satellites*, (Logan, UT, August 2-7, 2014), 7pp.

Robert H. Johnson, Lisa D. Montierth, JR Dennison, James S. Dyer, and Ethan Lindstrom, "Small Scale Simulation Chamber for Space Environment Survivability Testing," *Proceedings of the 12th Spacecraft Charging Technology Conference*, (Kitakyushu, Japan, May 14-18, 2012), 6 pp.

JR Dennison, John Prebola, Amberly Evans, Danielle Fullmer, Joshua L. Hodges, Dustin H. Crider and Daniel S. Crews, "Comparison of Flight and Ground Tests of Environmental Degradation of MISSE-6 SUSpECS Materials," *Proceedings of the 11th Spacecraft Charging Technology Conference*, (Albuquerque, NM, September 20-24, 2010), 12 pp.

Amberly Evans and JR Dennison, "The Effects of Surface Modification on Spacecraft Charging Parameters," *Proceedings of the 11th Spacecraft Charging Technology Conference*, (Albuquerque, NM, September 20-24, 2010), 5 pp.

# Related Presentations

## ***Accepted***

- JR Dennison, "Enhanced Test Facility for Survivability and Characterization of Evolving Multiscale Materials in Extreme Plasma Environments," 2017 Aerospace Materials for Extreme Environments Program Review, Air Force Office of Scientific Research, Kirtland Air Force Base, Albuquerque, NM, May 15, 2017.
- Lori Caldwell, Charles Harding, JR Dennison, Elizabeth Vargis, "Characterizing the Effects of Radiation on Muscle Cells," Biomedical Engineering Society (BMES) Annual Meeting, Phoenix, AZ, October 11-14, 2017.
- Alex Souvall, Ben Russon, Greg Wilson, Brian Wood and JR Dennison, "Myriad Investigations Using the USU Space Survivability Tests Facility," *Utah NASA Space Grant Consortium Research Symposium*, May 8, 2017, Weber : Ogden, UT.

## ***Presented***

- Windy Olsen and JR Dennison, "Microcontroller and Memory Card Survivability in Space Conditions," *USU Student Research Symposium*, April 13, 2017, Logan, UT.
- David King and JR Dennison, "Temperature Dependent Conductivity of Polymers," *USU Student Research Symposium*, April 13, 2017, Logan, UT.
- Alexandra Hughlett and JR Dennison, "Reduction of Radiation Effects in Polymers," *USU Student Research Symposium*, April 13, 2017, Logan, UT.
- JR Dennison, "Satellite Survivability in a Harsh Space Environment: A Materials Perspective," *Invited Talk*, SDL-USU Technical Lecture Series, Logan, UT, February 28, 2017.
- Tyler Kippen, Allen Andersen, and JR Dennison, "Temperature Dependency of Electrostatic Breakdown in LDPE and PEEK," *Utah Conference on Undergraduate Research (UCUR) Meeting*, Brigham Young University, Provo, UT, February, 28, 2017.
- Alexander Souvall, Takuyuki Sakai, Takahiro Shimizu, Yuta Takahashi, Midori Morikawa, Shusuke Okita, Akihiro Nagata, Toshihiro Kameda, Shaunda Wenger and JR Dennison, "Space Environment Effects of Ionizing Radiation on Seed Germination and Growth," Utah Research on Capitol Hill, Salt Lake City, UT, January 26, 2017.
- Gareema Dhiman, Michelle Jung, Andre Nguyen, Shaunda Wenger, Alexander Souvall, JR Dennison, Takuyuki Sakai, Takahiro Shimizu, Yuta Takahashi, Midori Morikawa, Shusuke Okita, Akihiro Nagata, and Toshihiro Kameda, "Effects of Space Travel on Seed Germination and Viability," *Logan School Board Forum*, Logan High School, Logan, UT, January 10, 2016.
- Alexandra Hughlett, Tyler Kippen, and JR Dennison, "Relaxation of Radiation Effects on the Optical Transmission of Polymers," *American Physical Society Four Corner Section Meeting*, New Mexico State University, Las Cruces, N
- Alexander Souvall, Takuyuki Sakai, Takahiro Shimizu, Yuta Takahashi, Midori Morikawa, Shusuke Okita, Akihiro Nagata, Toshihiro Kameda, Shaunda Wenger and JR Dennison, "Space Environment Effects of Ionizing Radiation on Seed Germination and Growth," *American Physical Society Four Corner Section Meeting*, New Mexico State University, Las Cruces, NM, October 21-22, 2016. *Presentation received award for outstanding Undergraduate Talk.*
- Alex Souvall, Gregory Wilson, Ben Russon, Katie Gamaunt, and JR Dennison, "CubeSat Space Environments Effects Studied in the Space Survivability Test Chamber," USU Fall Undergraduate Research Orientation, Logan, UT, September 9, 2016.
- JR Dennison, Gregory Wilson, Alex Souvall, Ben Russon, and Katie Gamaunt, "CubeSat Space Environments Effects Studied in the Space Survivability Test Chamber," Paper Number SSC16-P-, 30th Annual AIAA/USU Conference on Small Satellites, (Logan, UT, August 6-11, 2016).
- Katie Gamaunt, Krysta Moser, Alex Souvall and JR Dennison, "UV Degradation Effects: Surface vs. Space Environment," *USU Student Research*
- L. H. Pearson, J. R. Dennison, E. W. Griffiths and A. C. Pearson, "Pulsed Electroacoustic System Modeling an dSignal Processing for Volume Charge Distribution Measurement in Thin Dielectric Films," *14<sup>th</sup> Spacecraft Charging Technology Conference*, Space Research and Technology Centre of the European Space Agency (ESA/ESTEC), (Noordwijk, Netherlands, April 4-8, 2016).
- Heather Tippets with JR Dennison, "Developing a Safe Test System for High-energy Electron Flux Environments Testing," Research and Creative Works Conference, Brigham Young University-Idaho, Rexburg, ID, March 30, 2016.
- JR Dennison, "The Role of Space Materials Research in Spacecraft Charging and Satellite Survivability," Keynote address, *JAXA 12<sup>th</sup> Space Environment Symposium*, Laboratory of Spacecraft Environment Interaction Engineering, Kitakyushu, Japan, November 16, 2015.
- Alex Souvall, Greg Wilson, Katie Gamaunt, Ben Russon, Heather Tippets and JR Dennison, "Properties of Spacecraft Materials Exposed to Ionizing Radiation," *American Physical Society Four Corner Section Meeting*, Arizona State University, Tempe, AZ, October 16-17, 2015.
- Ben Russon, Heather Tippets, Greg Wilson, Katie Gamaunt, Alex Souvall and JR Dennison, "Measurement of Effects of Long Term Ionizing Radiation on High Efficiency Solar Arrays," *American Physical Society Four Corner Section Meeting*, Arizona State University, Tempe, AZ, October 16-17, 2015.
- Katie Gamaunt, Heather Tippets, Alex Souvall, Ben Russon and JR Dennison, "The Space Survivability Test Chamber," *American Physical Society Four Corner Section Meeting*, Arizona State University, Tempe, AZ, October 16-17, 2015. *Presentation received award for outstanding Undergraduate Poster.*
- JR Dennison, Crystal Frazier, Erik Stromberg, Ben Russon, Heather Tippets, Lisa Phillipps, Alex Souvall, and James S. Dyer, "Small Satellite Verification and Assessment Test Facility with Space Environments Effects Ground-testing Capabilities," Paper Number SSC15-P-2, *29<sup>th</sup> Annual AIAA/USU Conference on Small Satellites*, (Logan, UT, August 8-13, 2015).
- Lisa Phillipps, JR Dennison, Kent Hartley, Robert H. Johnson, Justin Dekany and James S. Dyer, "Space Effects Survivability Testing," American Physical Society Four Corner Section Meeting, Utah Valley University, Orem, UT, October 17-18, 2014.



# USU Materials Physics Group

(Back row Left to Right) **Ben Russon**,  
Heather Zollinger, Zack Gibson, Matthew  
Robertson, Jordan Lee, David King

(Front row Left to Right) **Justin Christensen**,  
**Alexandra Hughlett**, **Alex Souvall**, **Greg  
Wilson**, Allen Andersen, JR Dennison, Windy  
Olsen

(Not pictured) Brian Wood, Vladimir  
Zavyalov, Jodie Gillespie, Jonh Mojica  
Decena, **Katie Gamaunt**, **Davis Muhwezi**,  
**Tyler Kippen**

**(UNSGC Supported)**

USU MPG  
Webpage



<http://digitalcommons.usu.edu/mp/>







**J. R. Dennison** received the B.S. degree in physics from Appalachian State University, Boone, NC, in 1980, and the M.S. and Ph.D. degrees in physics from Virginia Tech, Blacksburg, in 1983 and 1985, respectively. He was a Research Associate with the University of Missouri—Columbia before moving to Utah State University (USU), Logan, in 1988. He is currently a Professor of physics at USU, where he leads the Materials Physics Group. He has worked in the area of electron scattering for his entire career and has focused on the electron emission and conductivity of materials related to spacecraft charging for the last two decades.