

# Evaluation of Drowsiness by HRV Measures - Basic Study for Drowsy Driver Detection -

Atsuo MURATA and Yasutaka HIRAMATSU

Dept. of Intelligent Mechanical Systems, Division of Industrial Innovation Sciences, Graduate School of Natural Science and Technology, Okayama University

3-1-1, Tsushimanaka, Okayama, 700-8530 Japan TEL:81-086-251-8055 FAX:81-086-251-8056

E-mail:hiramatsu@iims.sys.okayama-u.ac.jp

**Abstract**—The aim of this study was to identify a useful measure to estimate an arousal level of drivers, to apply the result to develop ITS (Intelligent Transportation System) that can warn drivers of their low arousal state and to prevent driving under low arousal level from occurring and contribute to the reduction of traffic accidents. The EEG (electroencephalography) and ECG(electrocardiography) during a monotonous task was measured, and it was investigated how these measures change under the low arousal (drowsy) state. The time series of mean power frequency of EEG was plotted on X-bar control chart. Heart rate variability (HRV) measures RRV3 and RRV8-3 were derived on the basis of R-R intervals (interbeat intervals) obtained from ECG. Under the low arousal state (drowsy state), the mean power frequency tended to be lower than central line (CL) and range between CL and lower control limit (LCL). In accordance with this, RRV3 and RRV8-3 tended to increase under the low arousal (drowsy) state, which means that the parasympathetic nervous system became dominant under drowsy states.

## INTRODUCTION

Many studies have shown that night work such as driving a truck is associated with increased subjective sleepiness and increased EEG theta (4-7.9Hz) power density. In some cases, drivers actually fell asleep and induce critical and disastrous traffic accidents. Therefore, monitoring drowsiness during driving as an important risk factor for accidents in road transportation has been paid more and more attention. The development of ITS (Intelligent Transportation System) that can monitor drivers' arousal level and warn drivers of a risk of falling asleep and causing a traffic accident is essential for the assurance of safety during driving. However, we have not established effective measures for warning drivers of the risk of causing a traffic accident and preventing it from occurring. If such a monitoring function of drowsiness is built into ITS and we can warn drivers of a risk of falling asleep in advance, this would contribute to the promotion of safety driving and eventually decreasing disastrous traffic accidents.

Brookhuis et al.[1] carried out an on-road experiment to assess driver status using psychophysiological measures such

as EEG and ECG. They found that changes in psychological parameters such as EEG and ECG reflected changes in driver status and could predict driving impairment that might lead to a disastrous traffic accident. Kecklund et al. [2] recorded EEG continuously during a night or evening drive for eighteen truck drivers. They showed that during a night drive a significant intra-individual correlation was observed between subjective sleepiness and the EEG alpha burst activity. End-of-the-drive subjective sleepiness and the EEG alpha burst activity were significantly correlated with total work hours. As a result of a regression analysis, total work hours and total break time predicted about 66% of the variance of EEG alpha burst activity during the end of drive. Galley [3] overcame a few disadvantages of EOG in the measurement of gaze behavior by using on-line computer identification of saccades and additional keyboard masking of relevant gazes by the experimenter. As EOG, especially saccades and blinks, is regarded as one of useful measures to evaluate drivers' drowsiness, such an improvement might be useful to detect the low arousal state of drivers. Wright et al.[4] investigated sleepiness in aircrew during long-haul flights, and showed that EEG and EOG are potentially promising measures on which to base an alarm system. Skipper[5] made an attempt to detect drowsiness of driver using discrimination analysis, and showed that the false alarm or miss would occur in such an attempt.

Many studies used psychophysiological measures such as blink, EEG, saccade, and heart rate to assess fatigue [6]-[12]. McGregor [6] suggested caution in interpreting saccade velocity change as an index of fatigue since most of the reduction in average saccade velocity might be secondary to increase in blink frequency. No measures alone can be used reliably to assess drowsiness, because each has advantages and disadvantages. The results of these studies must be integrated and effectively applied to the prevention of drowsy driving. To prevent drivers from driving under drowsy state and causing a disastrous traffic accident, not the gross tendency of reduced arousal level but more accurate identification of timing when the drowsy state occurs is necessary. It is not until such accurate measures to identify drowsiness and predict the timing of drowsy driving is established that we apply this to the development of ITS which can surely and reliably avoid unsafe and unintentional driving under drowsy and low arousal state.

Although the studies above made an attempt to evaluate drowsiness (or sleepiness) on the basis of psychophysiological measures, Landstrom et al. [13] examined the effectiveness of sound exposure as a measure against driver drowsiness. They used twelve lorry drivers in a total of 110 tests of a waking (alarm) sound system. The effectiveness of the waking sound system was verified through subjective ratings by lorry drivers. This system is used by a driver when he or she feels that their arousal level is becoming lower, and there is a risk of falling asleep. The disadvantage of this system is that one must intentionally and spontaneously use the waking alarm system by monitoring their drowsiness by oneself. Eventually, an automobile in the future is required to detect the arousal level of a driver automatically by ITS and warn drivers of the drowsy state by using some effective measures such as a waking sound system. In order to develop and realize such a system, a useful measure that can predict an arousal level must be classified.

The aim of this study was to identify a useful measure to estimate an arousal level of drivers using HRV measures, and to apply the result to develop ITS (Intelligent Transportation System) that can warn drivers of their low arousal state. It is expected that such a system can prevent driving under low arousal level from occurring and contribute to the reduction of traffic accidents.

## METHOD

### Participants

Five male graduate or undergraduates (from 21 to 26 years old) participated in the experiment. They were all healthy and had no orthopaedic or neurological diseases.

### Apparatus

The outline of experimental (measurement) system is summarized in Figure 1. Electroencephalography (EEG) and Electrocardiography (ECG) activities were acquired with measurement equipment shown in Figure 1. An A/D instrument PowerLab8/30 and bio-amplifier ML132 were used. Surface EEG was recorded using A/D instrument silver/silver chloride surface electrodes (MLAWBT9), and sampled with a sampling frequency of 1kHz.

### Procedure

According to international 10-20 standard, EEGs were led from  $O_1$  and  $O_2$ . The participants sat on an automobile seat, and were required to watch a driving scene recorded on a highway from the front side. The experimental duration was not predetermined, because the time until the participant became drowsy differed across the participants. Basically, the experiment was continued until the experimenter judged that the participant reached drowsy and low arousal state.

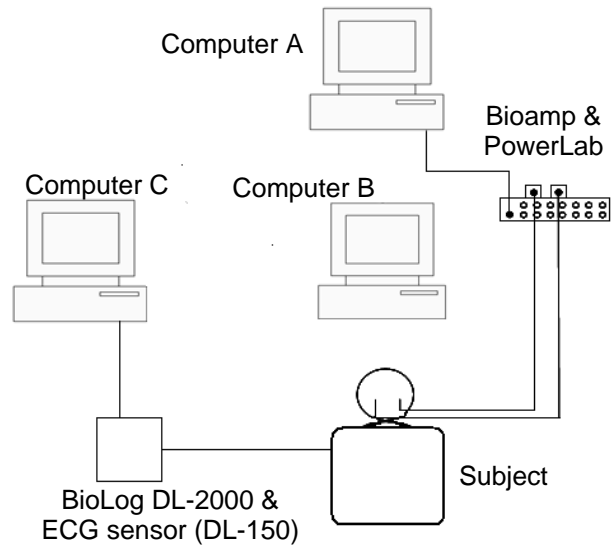

Figure 1. Outline of measurement system.

FFT was carried out every 1024 data (1.024 s). Before the EEG data were entered into FFT program, the data were passed through a cosine taper window. Based on this, the mean power frequency was calculated. This was plotted as time series as shown in Figure 6. Such time series data, the judgment of drowsiness of participants was carried out. The ECG was led from  $V_5$  using BioLog DL-2000(S&ME).

On the basis of ECG waveform, R-R intervals (inter-beat intervals) were obtained. Heart rate variability (HRV) measures RRV3 and RRV8-3 were derived as follows. As for RRV3, the moving average per ten inter-beat intervals was calculated. When RRV8-3 was obtained, a 25-point moving average operation was carried out. Variance of past three inter-beat intervals was calculated as RRV3. The subtraction RRV3 from variance of past eight inter-beat intervals corresponded to RRV8-3. The rationale for these calculations is shown in Figure 2. RRV3 and RRV8-3 are regarded to represent the functions of parasympathetic and sympathetic nervous systems, respectively. In general, it is believed that RRV3 increases under drowsy state.

(a)

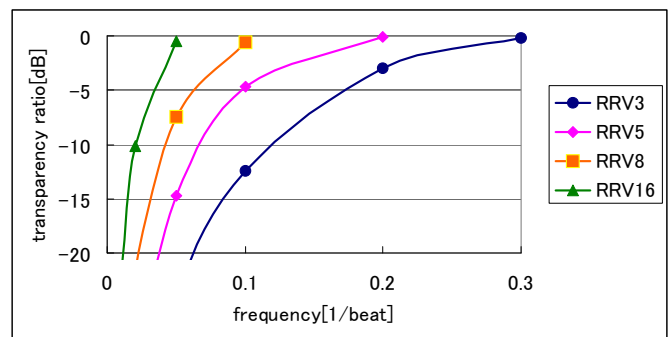

Figure 2 (a). Filter characteristics of RRV(n).

(b)

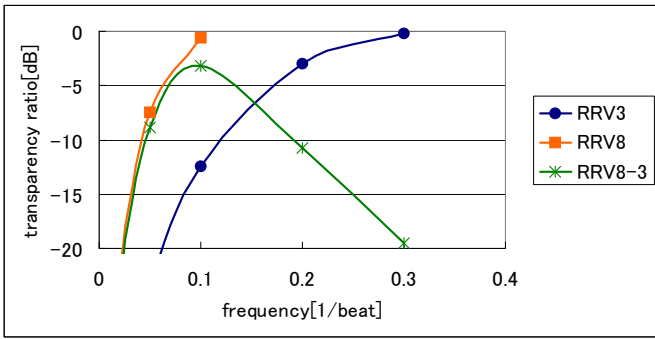

Figure 2 (b). Filter characteristics of *RRV8-3*.

## RESULTS

The time series of R-R intervals is shown in Figure 3. The power spectrums of R-R intervals under the high and low arousal states are shown in Figures 4 and 5, respectively. In these figures, we can observe two peaks, one around 0.1Hz and another around 0.2-0.3Hz. These represent sympathetic and parasympathetic nervous systems, respectively. The component corresponding to low frequency (sympathetic nervous system) is called Mayer wave variation (blood pressure component variation). The component corresponding to high frequency (parasympathetic nervous system) is called respiratory sinus arrhythmia. The time series of mean power frequency of EEG is shown in Figure 6. The time series of RRV3 is shown in Figures 7.

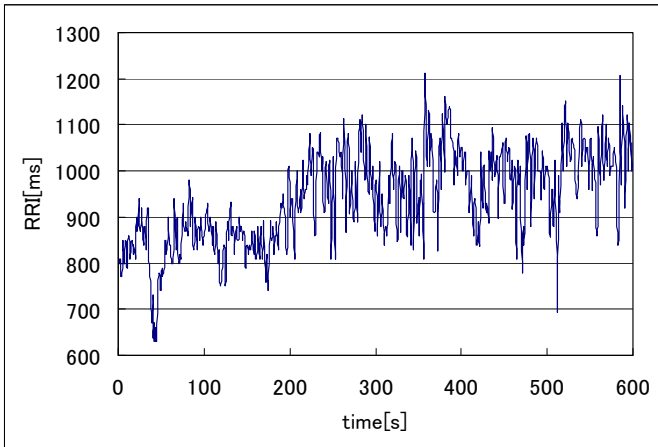

Figure 3. An example of time series of R-R intervals.

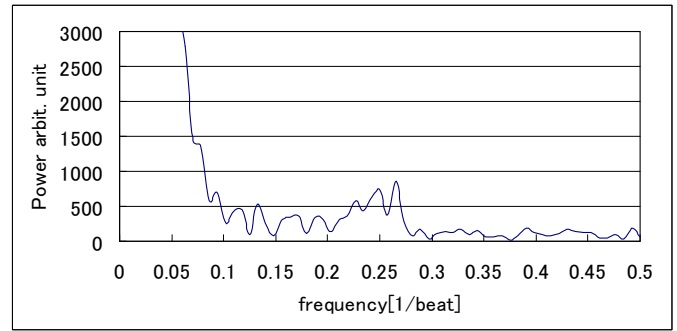

Figure 4. Power spectrums of R-R intervals under the high arousal state.

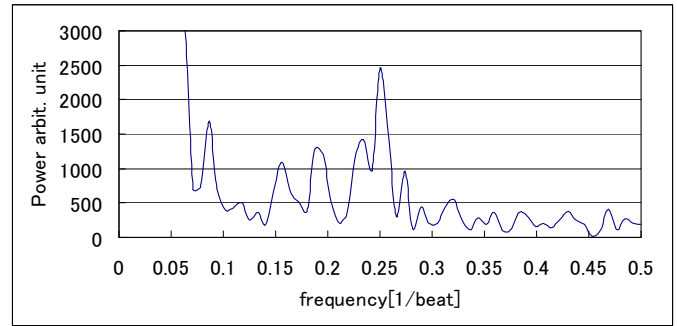

Figure 5. Power spectrums of R-R intervals under the low arousal state.

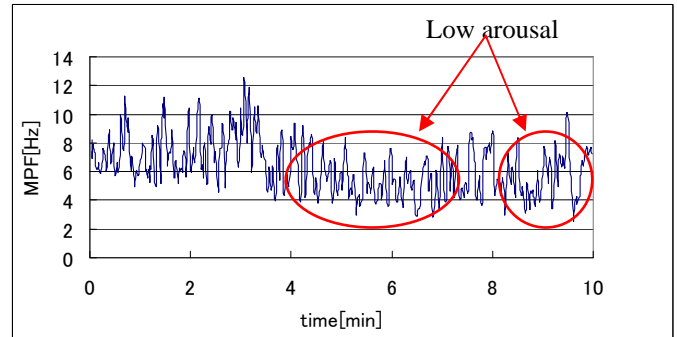

Figure 6. An example of time series of mean power frequency (MPF) of EEG.

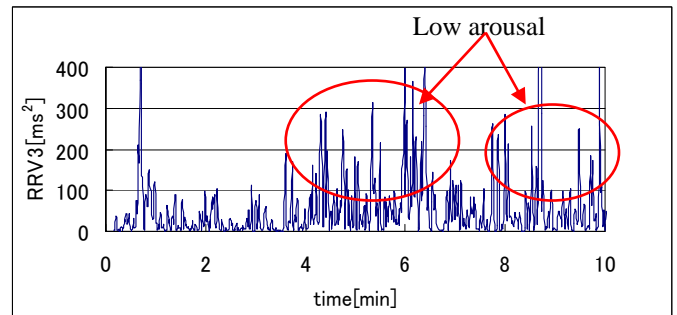

Figure 7. An example of time series of RRV3.

## DISCUSSION

As shown in Figures 4 and 5, we can see that the activity of parasympathetic nervous system is enhanced under the low arousal and drowsy state. This was confirmed and verified using the time series of MPF of EEG such as shown in Figure 6. Under the high arousal (not drowsy) state (see Figure 4), such a tendency of enhancement of parasympathetic nervous system is not observed at all.

However, it must be noted that power spectral analysis of R-R intervals requires a large data points (for example, more than 100 R-R intervals). Thus, the change of power spectrum cannot be obtained time by time like EEG (1000 EEG data are obtained per second). This makes us impossible to use spectral analysis of R-R intervals to evaluate drivers' arousal level time by time.

Therefore, on the basis of the rationale shown in Figure 2, the time by time change of sympathetic and parasympathetic nervous system was obtained using a HRV measure RRV3. In the range of this study, these HRV measures were very sensitive to the change of arousal level as shown in Figure 7. When the arousal level judged on the basis of mean power frequency (MPF) of EEG power spectrum is low, a HRV measure RRV3 tended to increase in accordance with this. In a practical application, it is very difficult to build a measurement system of EEG into drowsiness detection ITS, because attaching electrode to a driver is essential to measure EEG. On the other hand, the measurement technology of ECG is advancing and a system that can measure ECG only by putting a measurement sensor under a driver's seat. Therefore, in a practical application viewpoint, the more accurate and reliable detection of drowsiness by HRV measures might be more promising. In such a way, the approach to detect drivers' drowsiness on the basis of HRV measures should be more elaborated in future research.

In this study, it was shown that HRV measure, RRV3 increased under drowsy states. The most important is to predict reliably the time when the driver becomes drowsy and potentially cause disastrous traffic accidents. However, at present, it is still not possible to predict the arousal level on the basis of the values of HRV measures. Future research should propose a method to estimate and predict arousal level reliably and stably on the basis of HRV measures at present by using Bayesian network [14].

## REFERENCES

- [1]Brookhuis, K.A. and Waard, D. 1993. The use of psychophysiology to assess driver status, *Ergonomics*, 36, 1099-1110.
- [2]Kecklund, G. and Akersted, T. 1993. Sleepiness in long distance truck driving: An ambulatory EEG study of night driving, *Ergonomics*, 36, 1007-1017.
- [3]Galley, N. 1993. The evaluation of the electrooculogram as a psychophysiological measuring instrument in the driver study of driver behavior, *Ergonomics*, 36, 1063-1070.
- [4]Wright, N. and McGown, A. 2001. Vigilance on the civil flight deck: incidence of sleepiness and sleep during long-haul flights and associated changes in physiological parameters, *Ergonomics*, 44, 82-106.
- [5]Skipper, J.H. and Wierwillie, W. 1986. Drowsy driver detection using discrimination analysis, *Human Factors*, 28, 527-540.
- [6]McGregor, D.K. and Stern, J.A. 1996. Time on task and blink effects on saccade duration, *Ergonomics*, 39, 649-660.
- [7]Fukui, T. and Morioka, T. 1971. The blink method as an assessment of fatigue, *Ergonomics*, 14, 23-30.
- [8]Piccoli, B., D'orso, M., Zambelli.P.L., Troiano, P., and Assint, R. 2001. Observation distance and blinking rate measurement during on-site investigation: new electronic equipment, *Ergonomics*, 44, 668-676.
- [9]Sharma, S. 2006. Linear temporal characteristics of heart interbeat interval as an index of the pilot's perceived risk, *Ergonomics*, 49, 874-884.
- [10]Tejero, P. and Cholz, M. 2002. Driving on the motorway: the effect of alternating speed on driver's activation level and mental effort, *Ergonomics*, 45, 605-618.
- [11]Milosevic, S. 1978. Vigilance performance and amplitude of EEG activity, *Ergonomics*, 21, 887-894.
- [12]Fumio, Y. 1998. Frontal midline theta rhythm and eyeblinking activity during a VDT task and a video game; useful tools for psychophysiology in ergonomics, *Ergonomics*, 41, 678-688.
- [13]Landstrom, U., Englund, K., Nordstrom, B., and Astrom, A. 1999. Sound exposure as a measure against driver drowsiness, *Ergonomics*, 42, 927-937.
- [14]Hershman, R.L. (1971). A rule for the Integration of Bayesian Options, *Human Factors*, 13, 255-259.