

Engineering
Electrical Engineering fields

Okayama University

Year 2001

Suppression of common-mode voltage in
a PWM rectifier/inverter system

Satoshi Ogasawara
Okayama University

Hirofumi Akagi
Tokyo Institute of Technology

This paper is posted at eScholarship@OUDIR : Okayama University Digital Information Repository.

http://escholarship.lib.okayama-u.ac.jp/electrical_engineering/42

Suppression of Common-Mode Voltage in a PWM Rectifier/Inverter System

Satoshi Ogasawara* and Hirofumi Akagi**

*Department of Electrical Engineering, Okayama University
3-1-1 Tsushima-naka, Okayama, 700-8530 JAPAN

**Department of Electrical Engineering, Tokyo Institute of Technology
2-12-1 O-okayama, Meguro, Tokyo, 152-8552 JAPAN

Abstract— This paper proposes a PWM rectifier/inverter system capable of suppressing not only supply harmonic currents but also electromagnetic interference (EMI). An active common-noise canceler (ACC) developed for this system is characterized by sophisticated connection of a common-mode transformer which can compensate for common-mode voltages produced by both PWM rectifier and inverter. As a result, the size of the common-mode transformer can be reduced to 1/3, compared with the previously proposed ACC. A prototype PWM rectifier/inverter system (2.2 kW) has been implemented and tested. Some experimental results show reduction characteristics of the supply harmonic current and EMI.

I. INTRODUCTION

In recent years, the development of high-speed power semiconductor devices such as insulated gate bipolar transistors (IGBT's) has realized high response and high efficiency in voltage-source pulse-width-modulation (PWM) inverters. However, high-speed switching can lead to the following serious problems: 1) ground current escaping through stray capacitors [1], [2]; 2) conducted and radiated electromagnetic interference (EMI) [3]–[5]; 3) bearing current and shaft voltage [6]–[8]; 4) shortening of insulation life of motors and transformers [9], [10]. A steep change in voltage and/or current at a switching operation of the inverter produces high-frequency oscillatory common-mode currents because parasitic stray capacitors inevitably exist inside an ac motor.

Conventionally, common-mode chokes and EMI filters, which consist of only passive elements, have been used to reduce EMI. Some technical papers have reported on the reduction method using active elements[11]–[14]. The authors have proposed an active common-noise canceler (ACC), which can cancel the common-mode voltage produced by the PWM inverter[14].

On the other hand, PWM rectifiers are often used for reducing harmonic currents produced by power electronic equipment, e.g., home appliance and industrial apparatus. However, a PWM rectifier also can generate common-mode voltage, because it has the same circuit configuration as a PWM inverter.

This paper proposes a PWM rectifier/inverter system that is capable of suppressing not only supply harmonic currents but also electromagnetic interference (EMI). The conversion system consists of a PWM rectifier and inverter,

and an active common-noise canceler (ACC) which has been proposed by the authors. The ACC developed for this system is characterized by sophisticated connection of a common-mode transformer which can compensate for common-mode voltages produced by both the PWM rectifier and inverter. As a result, the size of the common-mode transformer can be reduced to 1/3, compared with the previously proposed ACC. A prototype PWM rectifier/inverter system (2.2 kW) has been implemented and tested. Some experimental results show effects on supply harmonic currents, leakage current, shaft voltage, and prevention of electric shock.

II. ACTIVE COMMON-NOISE CANCELER (ACC)

Fig. 1 shows an induction motor drive system connecting the original active common-noise canceler (ACC) which has been proposed by the authors[14]. The ACC is composed of a push-pull type emitter follower circuit using two complementary transistors Tr1 and Tr2, a common-mode transformer, three capacitors C_1 for common-mode voltage detection, and two dc-side capacitors C_0 . When a pair of IGBT's in one phase change its on-off state, the inverter varies common-mode voltage stepwise by 1/3 of the dc link voltage E_d . For this reason, a leakage current i_c flows to the grounding conductor through stray capacitors between motor windings and frame.

Fig. 2 shows a common-mode equivalent circuit for the drive system. Here, v_{inv} means common-mode voltage produced by the inverter, and C_c , L_c and R_c are stray capacitance, inductance and resistance components included in the common-mode circuit of the drive system, respectively. When no ACC is installed, each switching of the inverter causes a leakage current accompanied with high-frequency oscillation. In the equivalent circuit shown in Fig. 2, the ACC is modeled by a voltage-controlled voltage source and an inductor L_m which implies magnetizing inductance of the common-mode transformer. The emitter follower circuit detects the common-mode voltage at the inverter output terminals, and produces the same voltage to the common-mode transformer. The transformer superimposes the common-mode voltage on the inverter outputs. As a result, the ACC can cancel the common-mode voltage generated by the inverter, and the leakage current can be

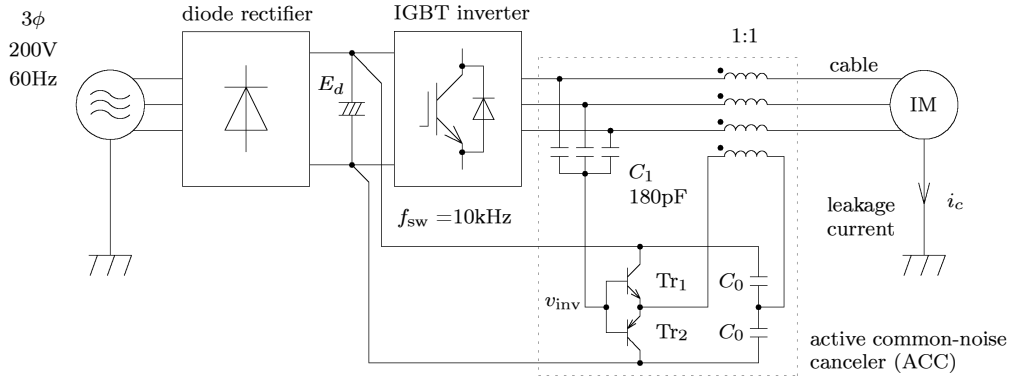

Fig. 1. The original ACC connected with a induction motor drive system.

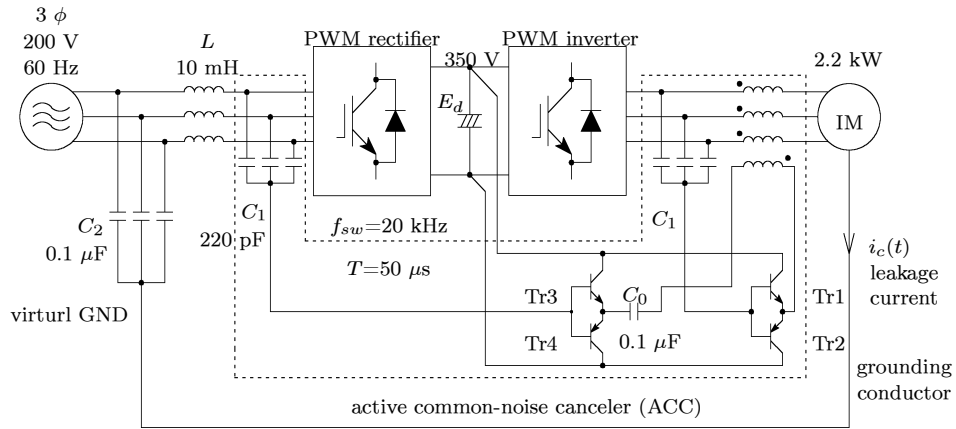

Fig. 3. A new ACC equipped with an experimental system.

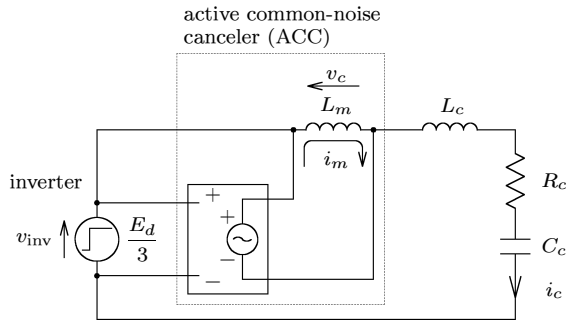

Fig. 2. Equivalent common-mode equivalent circuit.

suppressed perfectly. In addition, the ACC is effective in preventing electric shock and in reducing conducted EMI, motor shaft voltage and bearing current[14].

On the other hand, harmonic currents produced by power electronic equipment, e.g., home appliance and industrial apparatus, causes a problem to power distribution lines. PWM rectifiers are often used not only for regenerative operation but also for elimination of the harmonic cur-

rents. A PWM rectifier also can generate common-mode voltage and leakage current, because it has the same circuit configuration as a PWM inverter. In order to solve this problem perfectly, it is an easy way that the ACC of Fig. 1 is installed in the PWM rectifier at the ac side. However, two relatively large common-mode transformers are necessary for both PWM rectifier and PWM inverter.

III. A NEW ACC CONFIGURATION

Fig. 3 shows a new ACC for a PWM rectifier/inverter system. The motor frame of an induction motor is connected with a virtual-grounding point through a grounding conductor. Note that the virtual ground is introduced to remove the influence of a common-mode impedance between terminals on a switchboard and an actual grounding point. The PWM rectifier using IGBT's converts ac power into dc power. Different from the system shown in Fig. 1, it is possible not only to regenerate the dc power to the ac power supply but also to eliminate harmonic currents in the ac side of the PWM rectifier.

In Fig. 3, a new ACC can cancel common-mode voltages

TABLE I
SPECIFICATIONS OF COMPLEMENTARY TRANSISTORS USED FOR
EXPERIMENT.

type	2SA1772 (SANYO)	2SC4615 (SANYO)
V_{CBO} [V]	-400	400
V_{CEO} [V]	-400	400
$I_C(DC)$ [A]	-1	1
P_C^* [W]	15	15

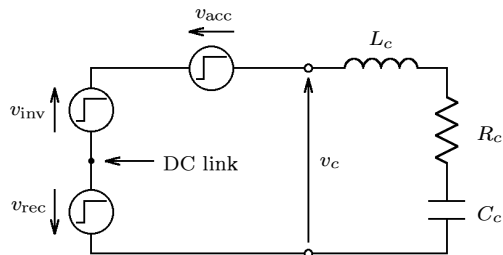

Fig. 4. Equivalent common-mode circuit for the proposed system.

generated by the PWM rectifier and inverter all together. Y-connected capacitors, which are represented as C_1 , detect the common-mode voltage at each ac-side terminals with respect to the dc link. Since a difference in common-mode voltage between the PWM rectifier and inverter appears between output terminals of two push-pull emitter follower circuits, the common-mode voltage produced by the two converters can be canceled all together by using one common-mode transformer. Table I shows specifications of the complementary transistors used in the emitter follower circuits. A capacitor C_0 , which is connected to the common-mode transformer in series, prevents dc current from flowing in the winding.

Fig. 4 shows an equivalent common-mode circuit for the drive system shown in Fig. 3. Since polarity of the rectifier common-mode voltage v_{rec} is opposite to that of the inverter common-mode voltage v_{inv} , total common-mode voltage of the equivalent circuit equals $v_{inv} - v_{rec}$. When the ACC generates a common-mode voltage v_{acc} being equal to $v_{inv} - v_{rec}$, the common-mode voltage generated by the PWM rectifier and inverter can be canceled perfectly, and no leakage current flows.

Fig. 5 shows waveforms of v_{rec} and v_{inv} . It is assumed that a common triangular signal is used for generation of PWM signals in both PWM rectifier and inverter. The waveforms of v_{rec} and v_{inv} is different from each other, but they have the same frequency as the triangular carrier signal. Generally, maximum flux in a transformer determines the core size, and it can be calculated from time integral of the winding voltage. If the original ACC shown in Fig. 1 is equipped with the PWM rectifier, it is necessary to provide a common-mode transformer, the saturation flux of which is larger than the flux represented by a hatched part of v_{rec} in Fig. 5. Similarly, for the original ACC connected with the PWM inverter, the saturation flux of the common-

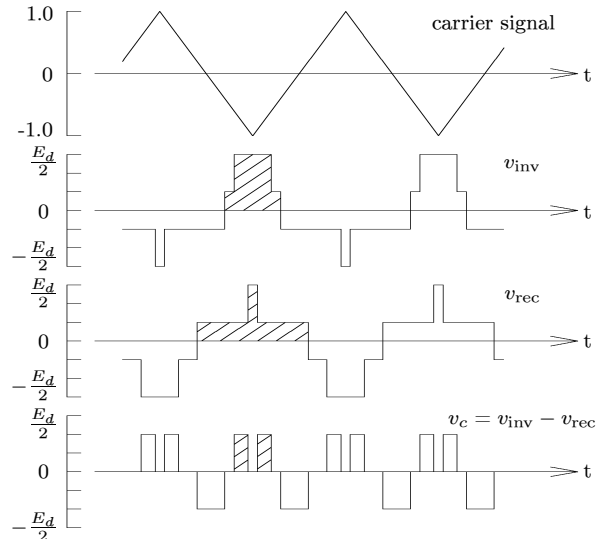

Fig. 5. Cancellation of Common-mode voltages between the rectifier and inverter.

mode transformer is larger than the flux represented by a hatched part of v_{inv} in Fig. 5. For this reason, two relatively large cores are required for the common-mode transformers.

Fig. 5 also shows a waveform of $v_{inv} - v_{rec}$. Since a common triangular signal is used in both PWM rectifier and inverter, a part of the common-mode voltage is canceled each other. Therefore, voltage time integral of $v_{inv} - v_{rec}$ is smaller than that of v_{inv} or v_{rec} . It is enough to provide only one common-mode transformer, when a new ACC shown in Fig. 3 cancels $v_{inv} - v_{rec}$ in a lump. Moreover, the core size is smaller than that of the original ACC.

IV. COMMON-MODE TRANSFORMER

A. Analysis of Interlinkage Flux

Fig. 6 shows a waveform of common-mode voltage produced by a voltage-source PWM inverter. PWM signals are generated by comparing sinusoidal voltage references with a triangular signal. The sinusoidal signals are represented as dc signals, because frequency of the triangular signal is much higher than that of the sinusoidal signals. Intervals shown in Fig. 6 are given by the following equations:

$$x = \frac{T}{4}(1 - \gamma \sin \alpha), \quad (1)$$

$$z = \frac{T}{4} \left\{ 1 - \gamma \sin \left(\alpha + \frac{2}{3}\pi \right) \right\}. \quad (2)$$

Here, α and γ mean a phase of the sinusoidal signals and a modulation index, respectively. Time integral of the common-mode voltage gives interlinkage flux of the common-mode transformer, which is used in the original ACC.

$$\Phi = \frac{E_d}{6} \left(\frac{T}{4} - x \right) - \frac{E_d}{6} x - \frac{E_d}{3} z \quad (3)$$

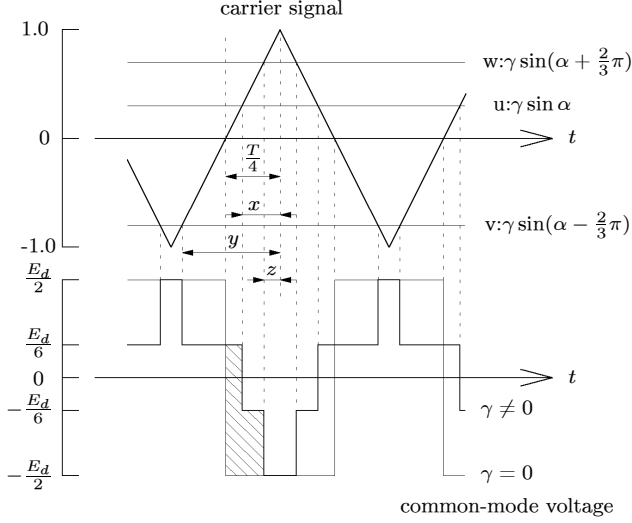

Fig. 6. Common-mode voltage produced by the PWM inverter.

Substituting (1) and (2) into (3) produces the following equation, when $0 < \alpha < \pi/6$, i.e., $z < x < T/4$.

$$\Phi = -\frac{E_d T}{8} + \frac{E_d T}{12} \gamma \sin\left(\alpha + \frac{\pi}{3}\right) \quad (4)$$

The amplitude of the interlinkage flux reaches a maximum value of $E_d T/8$ when $\gamma=0$. The common-mode transformer used in the original ACC should be designed so that the core does not saturate with the maximum flux.

On the other hand, the common-mode transformer used in the proposed ACC is designed, taking the difference in common-mode voltage between the PWM rectifier and inverter in consideration, because time integral of $v_{\text{inv}} - v_{\text{rec}}$ gives interlinkage flux of the common-mode transformer. When modulation index γ of one converter, e.g., the PWM inverter, is equal to zero, the interlinkage flux Φ' takes a large value. The interlinkage flux Φ' , which is indicated by a hatched part in Fig. 6, is calculated by the following equation:

$$\begin{aligned} \Phi' &= -\frac{E_d T}{8} - \Phi \\ &= -\frac{E_d T}{12} \gamma \sin\left(\alpha + \frac{\pi}{3}\right). \end{aligned} \quad (5)$$

Fig. 7 shows an analytical result of $|\Phi'|$. Here, the vertical axis is normalized by $E_d T/8$, i.e., the maximum interlinkage flux in case of the original ACC. A condition that $\gamma = 1$ and $\alpha = \pi/6$ leads to the maximum interlinkage flux $|\Phi'|_{\text{max}}$ being equal to $E_d T/12$. Although the analytical result is shown only in a range of ± 30 deg, the result is repeated in other ranges periodically.

In the case using the original ACC's, two common-mode transformers are necessary, the saturation flux of which is greater than the maximum flux of $E_d T/8$. In the proposed system shown in Fig. 3, it is enough to provide only one common-mode transformer, the saturation flux of which

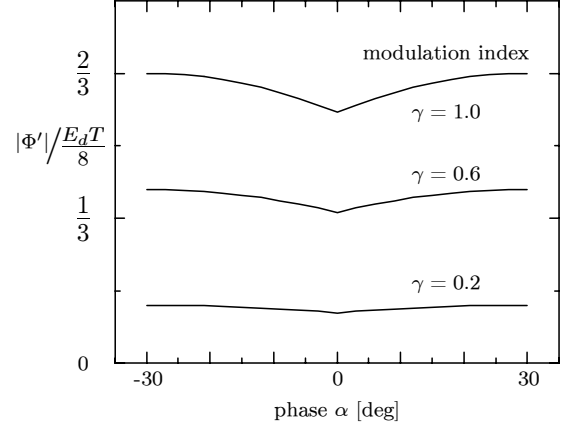

Fig. 7. Interlinkage flux of common-mode transformer.

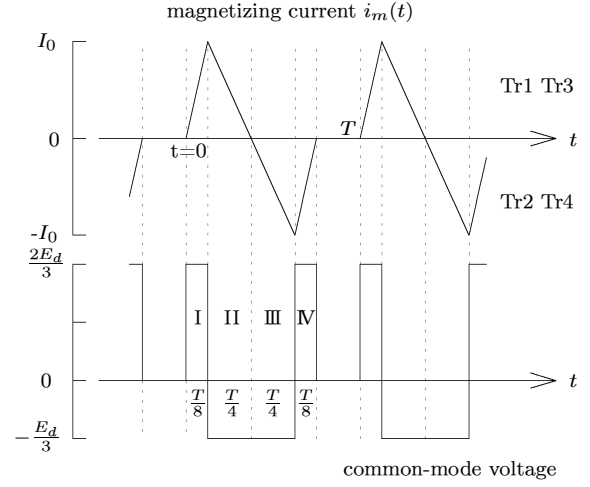

Fig. 8. Variation of magnetizing current ($\gamma = [0, 1]$, $\alpha = 30$ deg).

is greater than the maximum flux of $E_d T/12$. Therefore, the proposed system can reduce the core volume of the common-mode transformer to 1/3 compared with that of the original ACC's.

B. Design of a Prototype

In order to design a prototype ACC, power dissipation in each transistor should be considered. Magnetizing current of the common-mode transformer causes the power dissipation. Fig. 8 shows waveforms of magnetizing current i_m and $v_{\text{inv}} - v_{\text{rec}}$. This figure assumes the worst case that the amount of the power dissipation is at maximum. In intervals I and II, the magnetizing current is positive so that it flows not through Tr2 and Tr3, but through Tr1 and Tr4. On the contrary, the magnetizing current flows through Tr2 and Tr3 in intervals III and IV. For example, Tr1 dissipates power only in interval I, because emitter-collector voltage of Tr1 equals zero in interval II. Average

TABLE II
SPECIFICATIONS OF FERRITE CORE.

TYPE	H1D T60×20×36	(TDK)
effective sectional area	A_e	235 mm ²
effective length of magnetic path	l_e	144 mm
AL-value	AL	13.2±25% μH/N ²
weight	W_t	172 g
saturation magnetic flux density	B_s	430(at 25°C) mT 260(at 100°C) mT

power dissipation of Tr1 is given by

$$P_{C1} = \frac{1}{T} \int_0^T v_{CE1}(t) \cdot i_{C1}(t) dt = \frac{E_d I_0}{16}. \quad (6)$$

Similarly, average power dissipations of the other transistors can be calculated as $P_{C2} = E_d I_0 / 8$, $P_{C3} = E_d I_0 / 8$ and $P_{C4} = E_d I_0 / 16$, respectively. Since the absolute maximum power dissipation of the transistor is rated at 15 W as shown in Table I, the peak value of the magnetizing current I_0 and the magnetizing inductance L_m are limited as follows:

$$I_0 < \frac{15\text{W} \times 8}{E_d} = 0.343 \text{ A}, \quad (7)$$

$$L_m = \frac{E_d T}{12 I_0} > 4.3 \text{ mH}, \quad (8)$$

where the dc link voltage E_d and the PWM period T in the experimental system are 350 V and 50 μs, respectively.

Table II shows the specifications of the ferrite core used. The common-mode transformer should be designed so as not to cause magnetic saturation. Therefore, product of the core stack number k and the turns number N should satisfy

$$kN > \frac{E_d T}{12 A_e B_s}. \quad (9)$$

In the experimental system, two toroidal ferrite cores ($k = 2$) are used for the common-mode transformer, and the number of turns is selected as $N = 20$, in consideration of margin. Therefore, the magnetizing inductance L_m is given by

$$L_m = 2 \times 13.2 \times 10^{-6} \times 20^2 = 10.6\text{mH} \quad (10)$$

In this case, the maximum magnetizing current I_0 and the maximum flux density B_m are calculated as follows:

$$I_0 = 0.175\text{A}, \quad B_m = 155\text{mT}. \quad (11)$$

The power dissipation of each transistor, which corresponds to 0.17 % or 0.35 %, is much smaller than the rated power of the induction motor.

V. EXPERIMENTAL RESULTS

An experimental system connecting the new ACC is constructed and tested. The experimental system consists of a PWM rectifier and a PWM inverter as shown in Fig. 3, and drives a 2.2-kW induction motor.

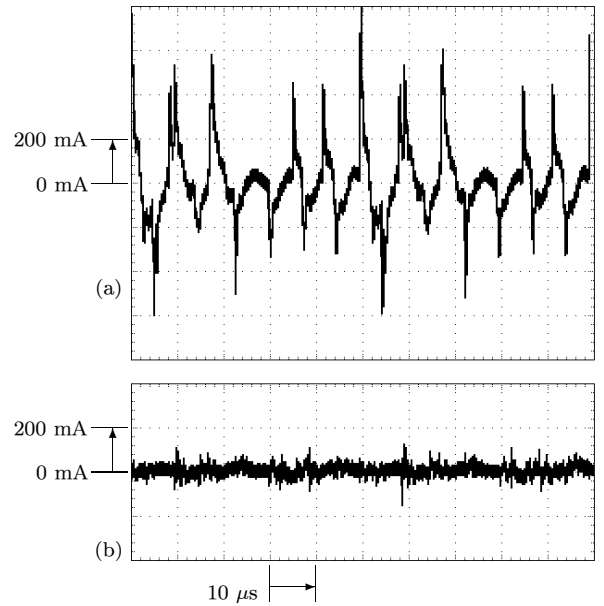

Fig. 9. Leakage current under no-load condition. (a) without ACC. (b) with ACC.

A. Effect on Leakage Current

Fig. 9 shows waveforms of leakage current flowing through the grounding conductor. In the case that no ACC is connected with the experimental system, it is shown that impulse leakage currents occur 12 times in a period of the triangular signal (50 μs), because the PWM rectifier or inverter performs switching operations 6 times in the period. The peak value of the leakage current reaches 1 A at the maximum. The common-mode voltages and the leakage currents cause serious problems. When the new ACC is connected, the leakage current is suppressed almost perfectly as shown in Fig. 9 (b). The experimental result shows that the proposed ACC providing one common-mode transformer can cancel the common-mode voltage generated by both PWM rectifier and inverter all together.

Fig. 10 shows waveforms of the leakage current under the full-load condition. The waveform of Fig. 10 (a) is almost the same as that of Fig. 9 (a) except for timing at which the impulse leakage current appears. The fact indicates that load conditions have no relation with the leakage current. Similarly, the new ACC can eliminate the leakage currents regardless of the load condition, as shown in 10 (b).

Fig. 11 shows waveforms of a supply phase voltage and a line current measured at the ac-side terminals of the PWM rectifier under the full load condition. Since both waveforms are sinusoidal and in-phase, the PWM rectifier achieves reduction of the harmonic currents and improvement of power factor.

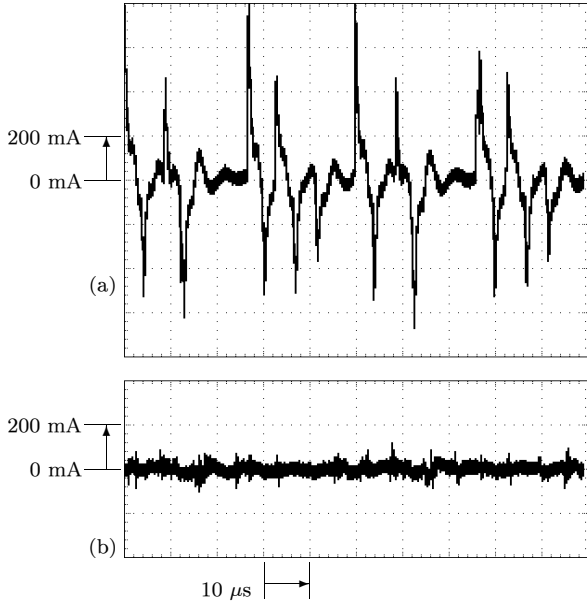

Fig. 10. Leakage current under the rated-load condition. (a) without ACC. (b) with ACC.

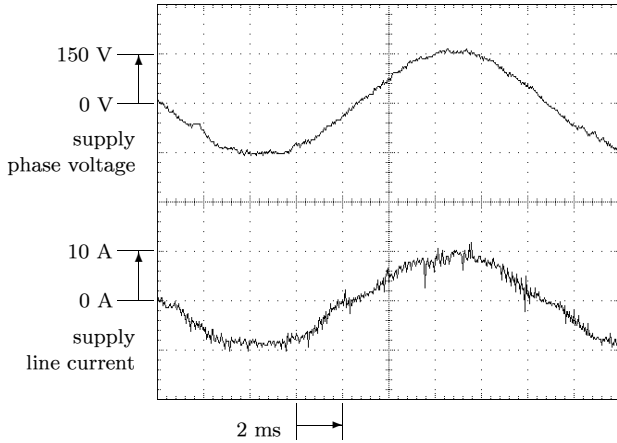

Fig. 11. Phase voltage and line current of the PWM rectifier.

B. Effect on Motor Shaft Voltage

Fig.12 shows an effect of the new ACC on shaft voltage. Common-mode voltage v_c is measured at the input terminals of the induction motor, and shaft voltage v_s means a voltage between the motor shaft and the motor frame measured by using a carbon brush. It is concluded that the motor shaft voltage is caused by the common-mode voltage, because the shapes of the two waveforms are similar. The shaft voltage results from a capacitive coupling between the stator and rotor[6]. The experimental result shows that switching operations of the PWM rectifier and inverter cause a motor shaft voltage of 5 V (peak value) when no ACC is connected. It may induce electric field breakdown of a thin oil film existing between a bearing

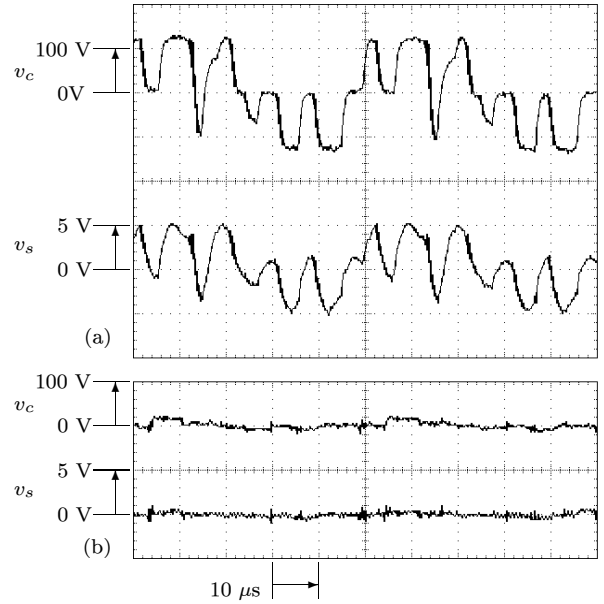

Fig. 12. Waveforms of shaft voltage and common-mode voltage. (a) without ACC. (b) with ACC.

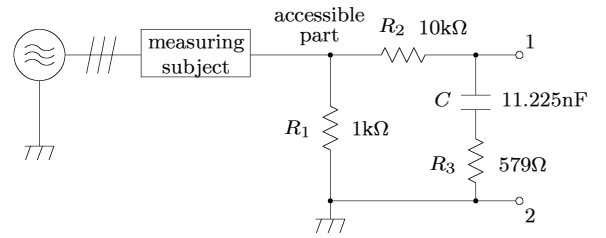

Fig. 13. Measuring circuit.

race and balls, thus resulting in bearing current. The bearing of the motor might be damaged by the bearing current altering the chemical composition of the lubricant[8].

As shown in Fig. 12 (b), neither common-mode voltage nor motor shaft voltage appears in the waveforms. Therefore, the proposed ACC is a promising way of eliminating common-mode voltage and motor shaft voltage.

C. Effect on Prevention of Electric Shock

In Japan, a safety standard to prevent electric shock from being received on an accessible metal part of a nongrounded electric apparatus has been enacted, which is a similar standard to IEC 335. Fig. 13 shows a measuring circuit complying with the Japanese standard. The measuring circuit is connected between a nongrounded motor frame and an earth terminal, and an rms value of voltage between output terminals 1 and 2 is measured. It was judged that there is no danger of electric shock when the terminal voltage is less than 1 V.

Fig. 14 shows waveforms of the common-mode voltage and the terminal voltage of the measuring circuit. When no ACC is connected, the rms value of the terminal volt-

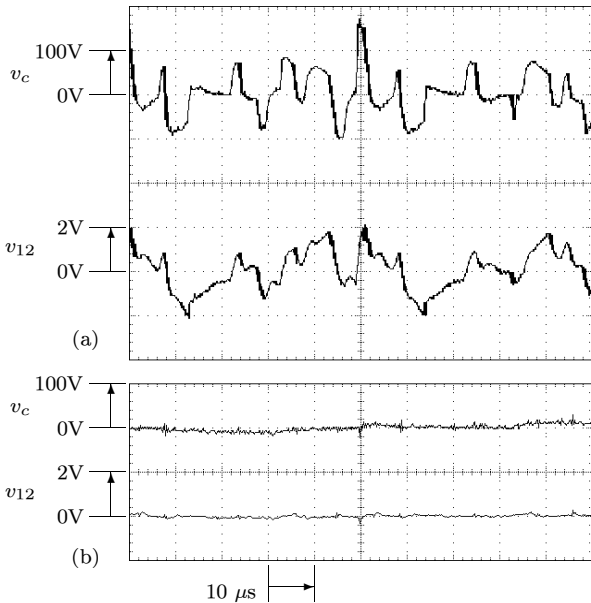

Fig. 14. Terminal voltage of measuring circuit. (a) without ACC. (b) with ACC.

age v_{12} is 0.74 V. The value is smaller than that of a drive system using a diode rectifier and a PWM inverter. This reason is that two common-mode voltages produced by the PWM rectifier and inverter counteract each other because of a common triangular signal for generating the PWM signals. When the proposed ACC is connected, it is indicated that the common-mode voltage v_c and the terminal voltage v_{12} are well reduced. The proposed ACC can cancel the common-mode voltages produced by the PWM rectifier and inverter almost completely. The rms value of the terminal voltage v_{12} measures less than 100 mV, and the value is much smaller than the prescribed value of 1 V. Therefore, the proposed ACC can remove any danger of an electric shock received on a nongrounded motor frame.

VI. CONCLUSIONS

This paper has proposed a new active common-noise canceler (ACC) for a PWM rectifier/inverter system. The ACC is capable of canceling common-mode voltages produced by both PWM rectifier and inverter all together. The configuration can reduce the core size of the common-mode transformer to 1/3, compared with that of the conventional ACC. A prototype PWM rectifier/inverter system driving a 2.2-kW induction motor has been constructed and tested. As a result, experimental results lead to the following conclusions:

- The load condition of the motor has no influence on the leakage or ground current.
- The proposed ACC can suppress the leakage current almost completely, regardless of the load condition.

- The proposed ACC is effective in elimination of the shaft voltage and prevention of electric shock.
- Harmonic reduction and power factor correction are achieved in ac side of the PWM rectifier.

Since the proposed PWM rectifier/inverter system is a clean power conversion system capable of suppressing both the input harmonic current and the common-mode noise, the system is promising for motor drive applications.

REFERENCES

- [1] Y. Murai, T. Kubota, and Y. Kawase: "Leakage Current Reduction for a High-Frequency Carrier Inverter Feeding an Induction Motor," *IEEE Trans. Industry Applications*, vol. 28, no. 4, pp.858–863, Jul./Aug., 1992.
- [2] S. Ogasawara and H. Akagi: "Modeling and Damping of High-Frequency Leakage Currents in PWM Inverter-Fed AC Motor Drive Systems," *IEEE Trans. Industry Applications*, vol. 32, no. 5, pp. 1105–1114, 1996.
- [3] E. Zhong and T. A. Lipo: "Improvement in EMC Performance of Inverter-Fed Motor Drives," *IEEE Trans. Industry Applications*, vol. 31, no. 6, pp. 1247–1256, 1995.
- [4] S. Ogasawara, H. Ayano, and H. Akagi: "Measurement and Reduction of EMI Radiated by a PWM Inverter-Fed AC Motor Drive System," *IEEE Trans. Industry Applications*, vol. 33, No. 4, pp. 1019–1026, Jul./Aug., 1997.
- [5] G. L. Skibinski, R. J. Kerkman, and D. Schlegel: "EMI Emissions of Modern PWM ac Drives," *IEEE Industry Applications Magazine*, vol. 5, no. 6, pp. 47–81, Nov./Dec. 1999.
- [6] S. Chen, T. A. Lipo, and D. Fitzgerald: "Modeling of Motor Bearing Currents in PWM Inverter Drives," *IEEE Trans. Industry Applications*, vol. 32, no. 6, pp.1365–1370, 1996.
- [7] J. M. Erdman, R. J. Kerkman, D. W. Schlegel, and G. L. Skibinski: "Effect of PWM Inverters on AC Motor Bearing Currents and Shaft Voltages," *IEEE Trans. Industry Applications*, vol. 32, no. 2, pp. 250–259. Mar./Apr., 1996.
- [8] D. Busse, J. Erdman, R. J. Kerkman, D. Schlegel, and G. Skibinski: "Bearing Currents and Their Relationship to PWM Drives," *IEEE Trans. Power Electronics*, vol. 12, No. 2, pp. 243–252, Mar., 1997.
- [9] A. von Jouanne, D. A. Rendusara, P. N. Enjeti, and W. G. Gray: "Filtering Technique to Minimize the Effect of Long Motor Leads on PWM Inverter-Fed AC Motor Drive Systems," *IEEE Trans. Industry Applications*, vol. 32, no. 4, pp. 919–926, 1996.
- [10] A. von Jouanne, P. N. Enjeti, and W. G. Gray: "Application issues for PWM Adjustable Speed AC Motor Drives," *IEEE Industry Applications Magazine*, vol. 2, no. 5, pp. 10–18, Sep./Oct. 1996.
- [11] I. Takahashi, A. Ogata, H. Kanazawa, and A. Hiruma: "Active EMI Filter for Switching Noise of High Frequency Inverters," Proceedings of PCC-Nagaoka, pp. 331–334, Aug., 1997.
- [12] Hyeoun-Dong Lee, Seung-Ki Sul "Common-mode Voltage Pulse Cancellation Method Based on Space-Vector PWM Converter-Inverter System," ICPE'98, pp. 171-175, 1998.
- [13] G. Oriti, A. L. Julian, T. A. Lipo: "A New Space Vector Modulation Strategy for Common Mode Voltage Reduction," PESC'97 Conf. Rec., pp. 1541-1546, 1997.
- [14] S. Ogasawara, H. Ayano, and H. Akagi: "An Active Circuit for Cancellation of Common-Mode Voltage Generated by a PWM Inverter," *IEEE Trans. Power Electronics*, vol. 13, No. 5, pp. 835–841, Sep., 1998.