

*Engineering*

*Electrical Engineering fields*

---

Okayama University

Year 1991

---

A practical approach to harmonic  
compensation in power systems-series  
connection of passive and active filters

Hideaki Fujita  
Okayama University

Hirofumi Akagi  
Okayama University

This paper is posted at eScholarship@OUDIR : Okayama University Digital Information  
Repository.

[http://escholarship.lib.okayama-u.ac.jp/electrical\\_engineering/1](http://escholarship.lib.okayama-u.ac.jp/electrical_engineering/1)

# A Practical Approach to Harmonic Compensation in Power Systems—Series Connection of Passive and Active Filters

Hideaki Fujita and Hirofumi Akagi, *Member, IEEE*

**Abstract**—This paper presents a combined system of a passive filter and a small-rated active filter, both connected in series with each other. The passive filter removes load produced harmonics just as a conventional one does. On the other hand, the active filter plays a role in improving the filtering characteristics of the passive filter. This results in a great reduction of the required rating of the active filter and in eliminating all the limitations faced by using only the passive filter, leading to a practical and economical system. Experimental results obtained from a prototype model are shown to verify the theory developed in this paper.

## I. INTRODUCTION

“HARMONIC interferences” in power systems, which are caused by harmonic-producing loads such as diode or thyristor converters and cycloconverters, have been serious problems to solve. Passive filters consisting of a bank of tuned LC filters and/or a high-pass filter have been broadly used to suppress harmonics because of a low initial cost and high efficiency. However, passive filters have the following disadvantages:

- 1) Source impedance strongly affects filtering characteristics.
- 2) Parallel resonance between a source and a passive filter causes amplification of harmonic currents on the source side at specific frequencies.
- 3) A passive filter may fall into series resonance with a source so that voltage distortion produces excessive harmonic currents flowing into the passive filter.

With remarkable progress in the speed and capacity of semiconductors switching devices such as GTO thyristors and IGBT's, active filters consisting of voltage- or current-source PWM inverters have been studied and put into practical use [1]–[6] because they have the ability to overcome the above-mentioned disadvantages inherent in passive filters. However, active filters have the following problems:

- 1) It is difficult to construct a large-rated current source with a rapid current response.
- 2) Initial costs and running costs are high.

Paper IPCSD 91-41, approved by the Industrial Power Convention Committee of the IEEE Industry Applications Society for presentation at the 1990 Industry Applications Society Annual Meeting, Seattle, WA, October 7–12. Manuscript released for publication March 22, 1991.

The authors are with Okayama University, Okayama, Japan.  
IEEE Log number 9102110.

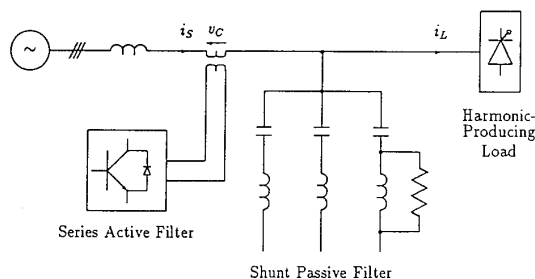

Fig. 1. Combination of a series active and shunt passive filter.

A few approaches to rating reduction in active filters have been proposed on the basis of a combination of active filters and passive elements such as capacitors and reactors [7]–[10]. Fig. 1 shows a combination of a series active filter and a shunt passive filter [9], [10]. The shunt passive filter connected in parallel with a load suppresses the harmonic currents produced by the load, whereas the active filter connected in series to a source acts as a “harmonic isolator” between the source and the load.

This paper presents a combined system of a passive filter and a small-rated active filter, which are connected in series with each other. The passive filter suppresses harmonic currents produced by the load, whereas the active filter improves the filtering characteristics of the passive filter. As a result, the proposed system can solve the problems inherent in using only the passive filter. In addition, the active filter is much smaller in rating than a conventional active filter.

## II. SYSTEM CONFIGURATION

Fig. 2 is a proposed system consisting of an active filter and a passive filter, which are connected in series with each other. The system is installed in parallel with a harmonic-producing load, i.e., a three-phase thyristor bridge converter of rating 20 kVA. The passive filter of rating 10 kVA consists of a fifth- and seventh-tuned LC filter and a high-pass filter. The main circuit of the active filter with a rating of 0.5 kVA is a three-phase voltage-source PWM inverter using six MOSFET's. The PWM inverter has a dc capacitor of 1200  $\mu$ F. The purpose of a small-rated LC filter ( $L_R$ ,  $C_R$ ) is to suppress switching ripples generated by the active filter. Table I shows the constants of the passive filter and the small-rated LC filter used in the following experiment. Three current transformers of turn ratio 1:10 are connected to

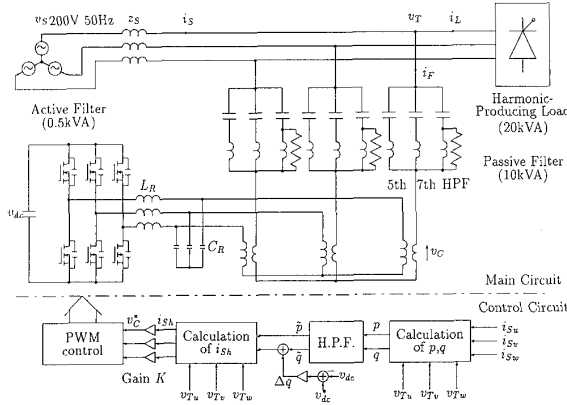

Fig. 2. Proposed system configuration.

TABLE I  
CIRCUIT CONSTANTS

Passive Filter			
5th	$L = 1.2 \text{ mH}$	$C = 340 \text{ } \mu\text{F}$	$Q = 14$
7th	$L = 1.2 \text{ mH}$	$C = 170 \text{ } \mu\text{F}$	$Q = 14$
HPF	$L = 0.26 \text{ mH}$	$C = 300 \text{ } \mu\text{F}$	$R = 3 \Omega$
Small-Rated LC Filter			
	$L_R = 10.0 \text{ mH}$	$C_R = 0.1 \text{ } \mu\text{F}$	

match the voltage-current rating of the active filter with that of the passive filter.

### III. CONTROL CIRCUIT

A control circuit is also shown in Fig. 2. Three-phase source currents,  $i_{Su}$ ,  $i_{Sv}$ , and  $i_{Sw}$  are detected and a source harmonic current in each phase  $i_{Sh}$  is calculated by applying the  $p$ - $q$  theory [11]. Terminal voltages and the source currents are transformed from three- to two-phase quantities as follows.

$$\begin{bmatrix} e_\alpha \\ e_\beta \end{bmatrix} = \sqrt{\frac{2}{3}} \begin{bmatrix} 1 & -\frac{1}{2} & -\frac{1}{2} \\ 0 & \frac{\sqrt{3}}{2} & -\frac{\sqrt{3}}{2} \end{bmatrix} \begin{bmatrix} e_u \\ e_v \\ e_w \end{bmatrix} \quad (1)$$

$$\begin{bmatrix} i_{S\alpha} \\ i_{S\beta} \end{bmatrix} = \sqrt{\frac{2}{3}} \begin{bmatrix} 1 & -\frac{1}{2} & -\frac{1}{2} \\ 0 & \frac{\sqrt{3}}{2} & -\frac{\sqrt{3}}{2} \end{bmatrix} \begin{bmatrix} i_{Su} \\ i_{Sv} \\ i_{Sw} \end{bmatrix} \quad (2)$$

Here,  $e_u$ ,  $e_v$ , and  $e_w$  are the fundamentals of the terminal voltages  $v_{Tu}$ ,  $v_{Tv}$ , and  $v_{Tw}$ , respectively. Hence, the instantaneous real power  $p$  and the instantaneous imaginary power  $q$  [11] are given by

$$\begin{bmatrix} p \\ q \end{bmatrix} = \begin{bmatrix} e_\alpha & e_\beta \\ -e_\beta & e_\alpha \end{bmatrix} \begin{bmatrix} i_{S\alpha} \\ i_{S\beta} \end{bmatrix} \quad (3)$$

In (3), the fundamental of  $i_S$  is transformed to dc components  $\bar{p}$  and  $\bar{q}$ , and the harmonics to ac components  $\tilde{p}$  and  $\tilde{q}$ . The ac components are extracted by two high-pass-filters, and the harmonics of the three-phase source currents,  $i_{Shu}$ ,

$i_{Shv}$ , and  $i_{Shw}$  are obtained by the following calculation:

$$\begin{bmatrix} i_{Shu} \\ i_{Shv} \\ i_{Shw} \end{bmatrix} = \sqrt{\frac{2}{3}} \begin{bmatrix} 1 & 0 \\ -\frac{1}{2} & \frac{\sqrt{3}}{2} \\ -\frac{1}{2} & -\frac{\sqrt{3}}{2} \end{bmatrix} \cdot \begin{bmatrix} e_\alpha & e_\beta \\ -e_\beta & e_\alpha \end{bmatrix}^{-1} \begin{bmatrix} \tilde{p} \\ \tilde{q} \end{bmatrix} \quad (4)$$

The calculated harmonic current in each phase  $i_{Sh}$  is amplified by the gain  $K$  and input to a PWM controller as a voltage reference

$$v_C^* = K \cdot i_{Sh} \quad (5)$$

To produce PWM switching patterns, the PWM controller compares  $v_C^*$  with a triangle-wave carrier whose frequency is 20 kHz.

In addition, the active filter can build up and regulate the dc capacitor voltage without any external power supply. If the active filter outputs a fundamental voltage that is in phase with the fundamental leading current of the passive filter, the active power formed by the leading current and the fundamental voltage is supplied to the dc capacitor. Therefore, the electrical quantity to be controlled in a dc voltage feedback loop is not  $\Delta p$  but  $\Delta q$ .

### IV. COMPENSATION PRINCIPLE

Fig. 3 shows single-phase equivalent circuits of the proposed system. Assuming that the active filter is an ideal controllable voltage source  $V_C$  and that the load is a current source  $I_L$ , Fig. 2 can be redrawn as Fig. 3(a), where  $Z_S$  is a source impedance and  $Z_F$  is the total impedance of the passive filter.

When no active filter is connected ( $K = 0$ ), a load harmonic current  $I_{Lh}$  is compensated by the passive filter, filtering characteristics of which depend on the ratio of  $Z_S$  and  $Z_F$ . From Fig. 3, the source harmonic current  $I_{Sh}$  is given by

$$I_{Sh} = \frac{Z_F}{Z_S + Z_F} I_{Lh} \quad (6)$$

If the source impedance is so small ( $|Z_S| \approx 0$ ), or unless the passive filter is tuned to harmonic frequencies generated by the load ( $|Z_F| \gg |Z_S|$ ), desirable filtering characteristics would not be obtained. Moreover, parallel resonance between  $Z_S$  and  $Z_F$  occurs at specific frequencies ( $|Z_S + Z_F| \approx 0$ ), causing a harmonic-amplifying phenomena. A much larger amount of harmonic current flows in the source than in the load.

When the active filter is connected, and is controlled as a voltage source

$$V_C = K \cdot I_{Sh} \quad (7)$$

The active filter forces all the harmonics contained in the load current to flow into the passive filter so that no harmonic current flows in the source. The function of the active filter is to solve the problems inherent in using the passive filter

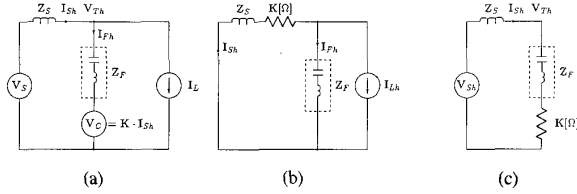

Fig. 3. Equivalent circuit of proposed filter system: (a) Single-phase equivalent circuit; (b) equivalent circuit for  $I_{Lh}$ ; (c) equivalent circuit for  $V_{Sh}$ .

alone. In addition, no fundamental voltage is applied to the active filter. This results in a great reduction of the voltage rating of the active filter.

### V. FILTERING CHARACTERISTICS

Let us consider filtering characteristics for the load harmonic current  $I_{Lh}$ . Let us assume that a source voltage  $V_S$  is sinusoidal. The source harmonic current  $I_{Sh}$ , the terminal harmonic voltage  $V_{Th}$  and the output voltage of the active filter  $V_C$  are given by the following three equations:

$$I_{Sh} = \frac{Z_F}{K + Z_S + Z_F} I_{Lh} \quad (8)$$

$$V_{Th} = V_{Sh} - Z_S I_{Sh} = -\frac{Z_F Z_S}{K + Z_S + Z_F} I_{Lh} \quad (9)$$

$$V_C = K I_{Sh} = \frac{K Z_F}{K + Z_S + Z_F} I_{Lh}. \quad (10)$$

Equation (8) tells us that Fig. 3(a) is equivalent in  $I_{Sh}$  to Fig. 3(b). This means that a pure resistance  $K[\Omega]$  is connected in series with  $Z_S$  as shown in Fig. 3(b). If  $K \gg |Z_F|$ , all the harmonic currents produced by the load would sink into the passive filter. If  $K \gg |Z_S|$ ,  $K$  would dominate the filtering characteristics. In addition,  $K$  acts as a resistor to damp parallel resonance between  $Z_S$  and  $Z_F$ .

Fig. 4 shows filtering characteristics in the case of  $Z_S = 0.02$  pu, the vertical axis of which indicates the ratio of the source harmonic current to the load current. In the case of the passive filter used alone ( $K = 0$ ), parallel resonance occurs near the fourth-harmonic frequency. In the case of the proposed system ( $K = 2\Omega$ ), the filtering characteristics are improved for all over the harmonic frequencies, and no parallel resonance occurs.

Now, let us discuss the harmonics present in the source voltage, assuming there is no load ( $I_{Lh} = 0$ ) in Fig. 3(a). The active filter behaves just like a pure resistor  $K[\Omega]$  as shown in Fig. 3(c). From Fig. 3(c), the following equations are obtained:

$$I_{Sh} = \frac{V_{Sh}}{K + Z_S + Z_F} \quad (11)$$

$$V_{Th} = \frac{K + Z_F}{K + Z_S + Z_F} V_{Sh} \quad (12)$$

$$V_C = \frac{K}{K + Z_S + Z_F} V_{Sh} \quad (13)$$

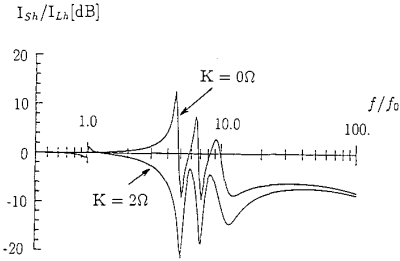

Fig. 4. Filtering characteristics for load harmonic current.

If  $K \gg |Z_S + Z_F|$ ,  $V_{Sh}$  would be applied to the active filter. This prevents harmonic currents caused by  $V_{Sh}$  from flowing into the passive filter. However,  $V_{Sh}$  appears in the terminal voltage  $V_T$ .

Fig. 5 shows compensation characteristics of the source harmonic current caused by the source harmonic voltage. In the case of  $K = 0$ , series resonance exists at the fourth-harmonic frequency. If the harmonic voltage included in the source is 1%, the fourth-harmonic current flowing into the passive filter would be about 20%. However, it would be only 1% in the case of  $K = 2[\Omega]$  because the series resonance is damped by the active filter.

The following ideal filtering characteristics are obtained by assuming that  $K$  is infinite:

$$I_{Sh} = 0 \quad (14)$$

$$V_{Th} = V_{Sh} \quad (15)$$

$$V_C = Z_F I_{Lh} + V_{Sh} \quad (16)$$

The fundamental leading current from the source and the harmonic current from the load both flow into the active filter, so that the required rating of the active filter is given by

$$|Z_F I_{Lh} + V_{Sh}| \cdot |I_{F0} - I_{Lh}|.$$

### VI. EXPERIMENTAL RESULTS

If the high-pass filter used for extraction of  $\tilde{p}$  and  $\tilde{q}$  is assumed to be ideal, the active filter acts as a resistor. Strictly speaking, the active filter does not act as a pure resistance due to a phase characteristic of the high-pass-filter. Improvement of filtering characteristics would be especially spoiled if the lowest frequency in  $\tilde{p}$  and  $\tilde{q}$  is near the cutoff frequency of the high-pass filter. Therefore, use of the high-pass filter, whose cutoff frequency is much lower than the lowest frequency in  $\tilde{p}$  and  $\tilde{q}$ , is preferred. Note that the lowest frequency to be considered is the fundamental one that which would be related to the second-harmonic frequency of current. On the other hand, load variation causes fluctuation of  $p$  and  $q$ . If the cutoff frequency of the high-pass filter is lower than the frequency of load variation, the active filter outputs a fundamental voltage to compensate for load variation, which increases the required rating of the active filter. Hence, the cutoff frequency of the high-pass filter should be designed to be higher than the frequency of load variation.

In the following experiments, the high-pass filter with cutoff frequency of  $f_c = 10$  Hz was used.  $K$  was  $2\Omega = 1$

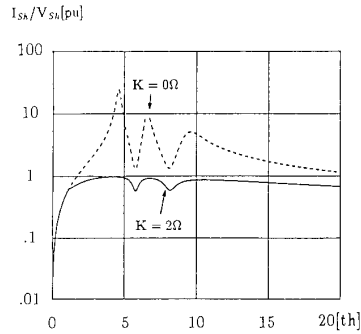

Fig. 5. Compensation characteristics for source voltage distortion.

pu, and a single phase-diode bridge rectifier was connected to the dc capacitor to supply switching and conducting losses of the active filter.

Fig. 6 shows experimental waveforms where  $Z_S$  is 0.02 pu. Before the active filter was started, a large amount of the fifth-harmonic current was included in the source current, but the source current became sinusoidal after starting. The simulation result shown in Fig. 7 agrees with the experimental result shown in Fig. 6. Because the output voltage of the active filter was about 2.5 V, the required rating of the active filter was only 1.5% of the harmonic-producing load, i.e., the thyristor converter of rating 20 kVA. Frequency spectra of the source currents  $i_S$  and the terminal voltage  $v_T$  in Figs. 8 and 9 were measured before and after the active filter was started. Although the fifth and seventh harmonics are contained in  $i_S$  before starting, they were eliminated after it was started.

Fig. 10 shows experimental waveforms under the same condition as that in Fig. 5 except that  $Z_S$  is 0.06 pu. Here, the passive filter fell in parallel resonance at the fourth-harmonic frequency with source impedance before the active filter was started. Not only the source current but also the terminal voltage was distorted. After starting, the parallel resonance disappeared, and both the source current and the terminal voltage became sinusoidal.

Fig. 11 shows an experimental result of buildup of the dc capacitor voltage under no harmonic-producing load. Here, no external diode rectifier was connected to the dc capacitor of the active filter. Before the active filter was started, the dc capacitor voltage was zero, and the source current was distorted by the source harmonic voltage. The dc capacitor voltage started to rise as soon as the active filter was started. After buildup, the dc capacitor voltage was regulated at a constant level, and the source current became sinusoidal because the active filter prevented harmonic currents from entering into the passive filter from the source.

#### VII. COMPARISON OF FIGS. 1 AND 2

Table II compares the combination of a series active and shunt passive filter shown in Fig. 1 [9], [10], and the series connection of a passive and active filter shown in Fig. 2. The same harmonic detection and control scheme are applicable to both systems, and they obtain the same compensation characteristics except for the terminal voltage. The terminal

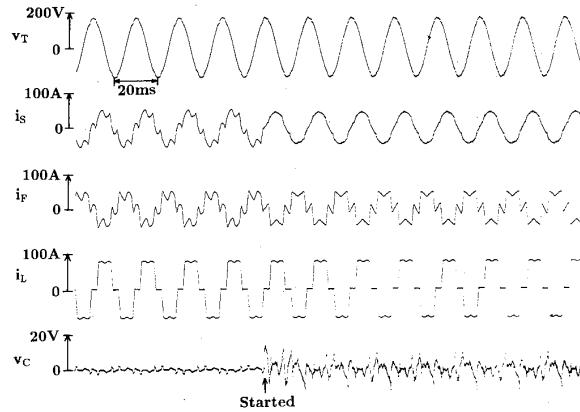

Fig. 6. Experimental waveforms in case of  $Z_S = 0.02$  pu.

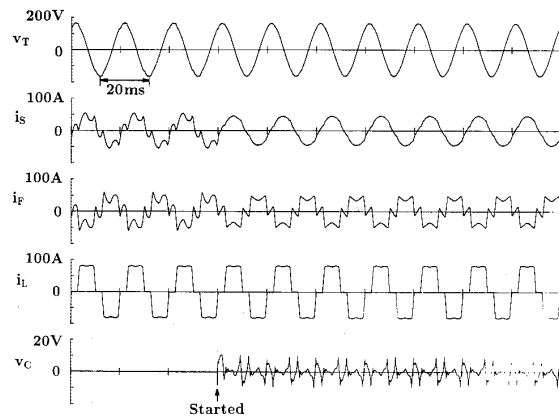

Fig. 7. Simulation waveforms in case of  $Z_S = 0.02$  pu.

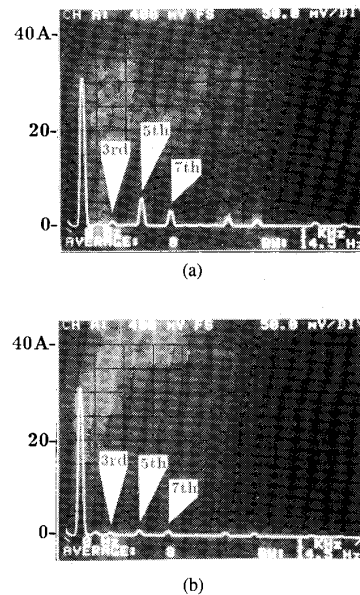

Fig. 8. Frequency spectra of  $i_S$ : (a) Before starting; (b) after starting.

TABLE II  
COMPARISON OF FIGS. 1 AND 2

	Combination of Series Active and Shunt Passive Filters	Series Connection of Active and Passive Filters
Current to be detected	Source current	Source current
Control scheme of active filters	$v_C^* = Ki_{Sh}$	$v_C^* = Ki_{Sh}$
Source harmonic current $I_{Sh}$	0	0
Terminal harmonic voltage $V_{Th}$	$-Z_F I_{Lh}$	$V_{Sh}$
Output voltage of active filters $V_C$	$Z_F I_{Lh} + V_{Sh}$	$Z_F I_{Lh} + V_{Sh}$
Current flowing through active filters	$I_{F0} + I_{Lf}$	$I_{F0} + I_{Lh}$
	Only fundamental	Containing harmonic
Required rating of active filters	Small in case of low power factor load	Small in case of high power factor load
Isolation and protection of active filters	Difficult	Easy

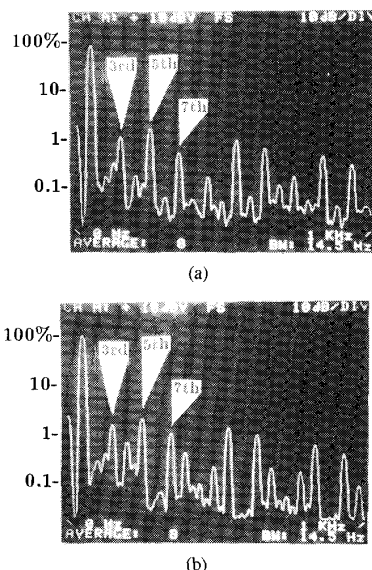

Fig. 9. Frequency spectra of  $v_T$ : (a) Before starting; (b) after starting.

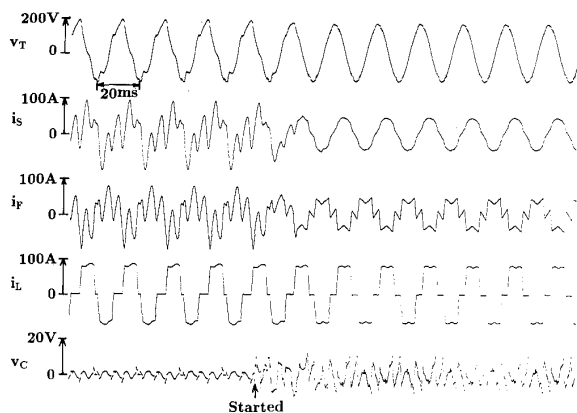

Fig. 10. Experimental waveforms in case of  $Z_S = 0.06$  pu.

harmonic voltage in Fig. 1 corresponds to a voltage drop across the passive filter  $-Z_F I_{Lh}$ , whereas that in Fig. 2 is equal to the source harmonic voltage  $V_{Sh}$ .

The current flowing through the active filter in Fig. 1 is the sum of the leading current of the passive filter and the fundamental of the load current, which does not contain any

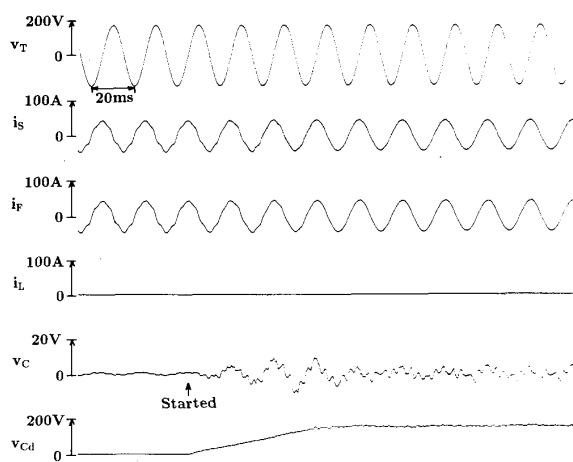

Fig. 11. Experimental waveforms in case of  $Z_S = 0.06$  pu.

harmonics. But in Fig. 2, the harmonic current produced by the load and the leading current of the passive filter flow through the active filter. The harmonic current causes a harmonic voltage drop across the matching transformer. On the other hand, it is easy to supply electric power corresponding to the switching and conducting loss of the active filter to the dc capacitor in Fig. 2. Fig. 1 requires an external power supply because the fundamental current flowing through the active filter is varied by the operating conditions of the load.

The required rating of the active filter depends on the power factor of the load because the passive filter is usually designed according to the reactive power of the load to be canceled. Therefore, in the case of a low power factor, Fig. 1 is smaller in the required rating of the active filter than Fig. 2, whereas in the case of a high power factor, Fig. 2 is smaller than Fig. 1.

In Fig. 1, it is difficult to isolate the active filter from the source and to protect it against a short-circuit fault because of the series connection with the source. In Fig. 2, it is easy to protect and isolate the active filter connected to the neutral point of the wye-connected passive filter. Accordingly, Fig. 2 would be more applicable to high-voltage power systems.

## VIII. CONCLUSIONS

The authors have proposed a combined system of a passive and an active filter, which are connected in series with each other. The theory developed in this paper was verified analytically.

ically and experimentally. The features of the proposed system are summarized as follows:

- 1) Filtering characteristics are independent of the source impedance.
- 2) Parallel and series resonance between the source and the passive filter can be damped by the active filter.
- 3) The required rating of the active filter is much smaller than that of a conventional active filter used alone.

In the laboratory experiment, the required rating of the active filter is only 1.5% of a harmonic-producing load, which is a three-phase thyristor converter of 20 kVA. Because a passive filter having a higher quality factor ( $Q = 50 \sim 100$ ) may be used in a practical system, the required rating of the active filter connected in series would be reduced according to inverse proportion of the quality factor of the passive filter.

#### REFERENCES

- [1] L. Gyugyi and E. Strycula, "Active ac power filter," *IEEE Trans. Industry Applications*, pp. 529-535, 1976.
- [2] H. Akagi, A. Nabae, and S. Atoh, "Control strategy of active power filters using voltage-source PWM converters," *IEEE Trans. Industry Applications*, vol. IA-22, no. 3, p. 460, 1986.
- [3] K. Komatsugi *et al.*, "Harmonic current compensator composed of static power converter," *IEEE/PESC Conf. Rec.*, 1986, p. 283.
- [4] S. Moran, "A line voltage regulator/conditioner for harmonic-sensitive load isolation," *IEEE/IAS Ann. Meeting Conf. Rec.*, 1989, pp. 947-951.
- [5] S. Deb, B. W. Sherman, and R. G. Hoft, "Resonant converter power line conditioner: Design and Evaluation," *IEEE/IAS Ann. Meeting Conf. Rec.*, 1989, pp. 952-958.
- [6] B. S. Acharya, R. W. Gascoigne, and D. M. Divan, "Active power filter using resonant pole inverters," *IEEE/IAS Ann. Meeting Conf. Rec.*, 1989, pp. 967-973.
- [7] A. Nakagima, J. Nishidai, and T. Shiraishi, "Development of active filter with series resonant circuit," *IEEE/PESC Ann. Meeting Conf. Rec.*, 1988, p. 1168.
- [8] M. Takeda, K. Ikeda, Y. Tominaga, and K. Oku, "Harmonic current compensation with active filter," *IEEE/IAS Ann. Meeting Conf. Rec.*, 1987, p. 808.
- [9] F. Z. Peng, H. Akagi, and A. Nabae, "A new approach to harmonic compensation in power systems," *IEEE/IAS Ann. Meeting Conf. Rec.*, 1988, pp. 874-880.
- [10] —, "Compensation characteristics of combined system of shunt passive and series active filters," *IEEE/IAS Ann. Meeting Conf. Rec.*, 1989, pp. 959-966.
- [11] H. Akagi *et al.*, "Instantaneous reactive power compensators comprising switching device without energy storage components," *IEEE Trans. Industry Applications*, vol. IA-20, no. 3, pp. 625-630, 1984.

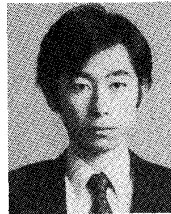

**Hideaki Fujita** was born in Toyama Prefecture, Japan, on September 10, 1965. He received the B.S. and M.S. degrees in electrical engineering from Nagaoka University of Technology, Nagaoka, Japan, in 1988 and 1990, respectively.

Since 1991, he has been a Research Associate at Okayama University, Japan. His research interests are active power filters and resonant converters.

Mr. Fujita is a member of the Institute of Electrical Engineers of Japan.



**Hirofumi Akagi** (M'87) was born in Okayama Prefecture, Japan, on August 19, 1951. He received the B.S.E.E. degree from the Nagoya Institute of Technology, Nagoya, Japan, and the M.S. and Ph.D. degrees in electrical engineering from the Tokyo Institute of Technology, Tokyo, Japan, in 1976 and 1979, respectively.

From 1976 to 1991, he was an Assistant and then an Associate Professor at Nagaoka University of Technology, Japan. Since August 1991, he has been a Professor at Okayama University, Japan.

He is engaged in research on ac motor drives, active power filters, and high-frequency inverters.

Dr. Akagi is a member of the Institute of Electrical Engineers of Japan.