

DEVELOPMENT OF MULTISTAGE CUK CONVERTER FOR PV VOLTAGE REGULATION

WAEEL A. Y. SALAH

UNIVERSITI SAINS MALAYSIA

2007

**DEVELOPMENT OF MULTISTAGE CUK CONVERTER FOR PV VOLTAGE
REGULATION**

by

Wael Abdel Muhdi Yacoub Salah

**Thesis submitted in fulfillment of the
requirements for the degree
of Masters of Science**

April, 2007

ACKNOWLEDGEMENTS

This work would never be complete without the mercy of Allah, and Doa'a of my parents.

I am very grateful to all whom have helped me during this work, and surely their help and support will always be greatly appreciated.

I would like to thank my advisor Assoc. Prof. Dr. Soib Taib, for his willingness to work with me and giving me his endless guidance throughout this project. With his enthusiasm and good humor, Dr. Soib made the study of power electronics fun and rewarding.

The USM staff also deserve my gratitude, as they work hard to help the students to reach their goals.

I would like to thank my friends and colleagues in the power lab research group. It is great to work with a group of people who are so willing to help. I have enjoyed my time here and wish the good luck to everyone at USM.

I could not have made it without the love and encouragement of my parents, whom I left in Palestine. It would have been very difficult without their support and Doa'a to Almighty Allah.

I thank my sisters and brothers; also who were always a source of support and encouragement. I appreciate all what they have done for me.

Finally, I wish to dedicate this work to my parents, brothers and sisters.

TABLE OF CONTENTS

	Page
ACKNOWLEDGEMENTS	ii
TABLE OF CONTENTS	iii
LIST OF TABLES	Viii
LIST OF FIGURES	ix
LIST OF PLATES	xiii
LIST OF SYMBOLS	xiv
LIST OF ABBREVIATION	xvii
LIST OF PUBLICATIONS & SEMINARS	xvii
ABSTRAK	xviii
ABSTRACT	xx
CHAPTER ONE : INTRODUCTION	
1.0 Introduction	1
1.1 Problem Statement	2
1.2 Scope	2
1.3 Objectives	3
1.4 Thesis Layout	3
CHAPTER TWO : LITERATURE REVIEW	
2.0 Introduction	5
2.1 Power Supply Rule	5
2.2 DC-DC Converters	6
2.3 Power Supply Types	7

2.3.1	Linear Voltage Regulator	7
2.3.1.1	The Shunt Regulator	8
2.3.1.2	The Series-pass Linear Regulator	8
2.3.2	PWM Switch Mode Power Supply (SMPS)	9
2.3.3	Resonant Converters	13
2.4	Power Supply Basic Topologies	14
2.4.1	Buck Converters	15
2.4.2	Boost Converters	17
2.4.3	Buck Boost Converters	18
2.4.4	Cuk Converter	19
2.5	Transformer Based Topologies	24
2.6	DC Converters and Duty Ratio D	25
2.7	Switching Capacitor Converters	25
2.8	Pulse Width Modulation (PWM)	27
2.9	Losses in PWM Switching	28
2.9.1	Major Losses	28
2.9.2	Losses Associated with the Power Switch	29
2.10	Design Specification	30
2.10.1	Power Switches	30
2.10.2	Diodes	31
2.10.3	MOSFET Gate Driver	33
2.11	Control Principles	34
2.11.1	Voltage-mode Control	35
2.11.2	Current-mode Control	36
2.12	Commercial IC Controller for Switching Converter	37

2.12.1	Fixed Frequency Voltage-Mode SG352X PWM Controller	37
2.12.2	Fixed Frequency Current-Mode UC384X PWM Controller	28
2.11.3	Variable Frequency Voltage Mode TL479 Controller	39
2.13	Sensor	40
2.14	Thermoelectric Cooling (TEC)	42
2.14.1	Operation	43
2.14.2	Thermoelectric Cooling Modules	44
2.14.3	TEC Applications	44
2.14.4	TEC Installation	44
2.14.5	TEC Advantages	45

CHAPTER THREE : DESIGN OF THE 3-STAGE NON-INVERTING CUK CONVERTER

3.0	Introduction	47
3.1	Methodology	47
3.2	Switch Capacitor Converters	49
3.3	Design Details	50
3.4	Multistage DC-DC converters	51
3.5	Equivalent Circuits	52
3.5.1	Non-Inverting Cuk Converter	52
3.5.2	Single Stage Non-Inverting Cuk Converter	53
3.5.3	Multistage Non-Inverting Cuk Converter	55
3.6	PWM Switching control and Gate Drive	62
3.7	Voltage Feedback	62

3.8	System Application Load	62
3.9	Determination of Inductors and Capacitors Values	64
3.10	Simulation	65
	3.10.1 Simulation Software	66
	3.10.2 Circuit Setup	66
3.11	PCB Design	68

CHAPTER FOUR : RESULTS AND DISCUSSION

4.0	Introduction	69
4.1	System Block Diagram	69
4.2	Prototype Assembling	70
	4.2.1 Bread boarding Tests	71
	4.2.2 System Integration	72
4.3	Switch Selection	75
4.4	Gate Drive Configurations	75
4.5	Data Measurements	76
	4.5.1 Measurement Apparatus	76
	4.5.2 Temperature Circuit Calibration	77
	4.5.3 TEC Tests	78
	4.5.4 PV Panel Power Measurement	80
	4.5.5 Simulation Results	81
	4.5.6 Converter Output Measurement	82
	4.5.7 Power and Efficiency	91

CHAPTER FIVE : CONCLUSION

5.0	Multistage Cuk Converter Design	94
5.1	Future Work	95

REFERENCES	97
-------------------	-----------

APPENDICES

Appendix A	Simulation Results	102
Appendix B	IR2110 MOSFET Driver	113
Appendix C	IRFZ44N Data sheet	116
Appendix D	LM35 Data sheet	119
Appendix E	SG3524 Data sheet	121
Appendix F	UC3843 Data sheet	123
Appendix G	TL497 Data sheet	125

LIST OF TABLES

		Page
Table 2.1	Power supply technologies	14
Table 2.2	Major losses	28
Table 4.1	LM35 test	77
Table 4.2	Maximum Output name plate ratings	80
Table 4.3	Simulation parameters	81

LIST OF FIGURES

		Page
Figure 2.1	The basic linear regulator	9
Figure 2.2	Basic forward-mode converter (buck converter)	11
Figure 2.3	Voltage and current waveforms for a forward-mode converter (buck converter)	12
Figure 2.4	Basic flyback-mode converter (boost converter shown)	12
Figure 2.5	Waveforms for a discontinuous-mode boost converter	13
Figure 2.6	B-H plot of symmetrical converters	15
Figure 2.7	Buck converter	16
Figure 2.8	Typical waveforms of buck converter	16
Figure 2.9	Boost (step-up) converter	17
Figure 2.10	Typical waveforms of boost converter	18
Figure 2.11	Buck-boost converter	18
Figure 2.12	Typical waveforms of buck-boost converter	19
Figure 2.13	Cuk converter circuit	20
Figure 2.14	Cuk converter waveforms	20
Figure 2.15	Cuk converter	21
Figure 2.16	Transformerless Cuk PWM converter	21
Figure 2.17	Equivalent circuit of the Cuk converter	22
Figure 2.18	Boost converter followed by a buck converter	22
Figure 2.19	Equivalent circuit with switches	23
Figure 2.20	Single switch equivalent circuit	23
Figure 2.21	Cuk practical realization	23
Figure 2.22	Fixed frequency PWM	27

Figure 2.23	Power switch losses	29
Figure 2.24	Switch or diode	31
Figure 2.25	Steady state V-I characteristic of a diode	32
Figure 2.26	Transient V-I characteristic of a diode	33
Figure 2.27	IR2110 DIP14 package	34
Figure 2.28	Functional block diagram	34
Figure 2.29	Voltage-mode control	35
Figure 2.30	Current-mode control	35
Figure 2.31	Temperature Sensor configuration	41
Figure 2.32	Thermal response in still air	42
Figure 2.33	Minimum supply voltage vs. temperature	42
Figure 2.34	Thermoelectric cooling modules	43
Figure 2.35	Typical thermoelectric cooler	44
Figure 2.36	Peltier effect thermoelectric cooler diagram	46
Figure 3.1	Converter design flow chart	48
Figure 3.2	Capacitors charging and discharging	49
Figure 3.3	Charging and discharging state	50
Figure 3.4	Complete system block diagram	51
Figure 3.5	Inverting Cuk converter	52
Figure 3.6	Non-inverting Cuk converter	52
Figure 3.7	Single stage non-inverting Cuk converter	53
Figure 3.8	On-state equivalent circuit	53
Figure 3.9	Off-state equivalent circuit	53
Figure 3.10	Current and voltage waveforms	55
Figure 3.11	Three stage non-inverting Cuk converter	56

Figure 3.12	Off-state power switch losses	56
Figure 3.13	On-state power switch losses	57
Figure 3.14	Conduction modes	60
Figure 3.15	PV connected to converter with the TEC load	63
Figure 3.16	Simulation setup	65
Figure 3.17	Three stage non-inverting cuk converter	67
Figure 3.18	Three Stage non-inverting capacitance voltage divider (S-Off)	67
Figure 3.19	Three Stage non-inverting capacitance voltage divider (S-On)	68
Figure 4.1	System block diagram	69
Figure 4.2	TEC and PV connection	70
Figure 4.3	LM35 temperature versus voltage	78
Figure 4.4	LM35 IC sensor versus thermocouple temperature	78
Figure 4.5	TEC direct measured temperature at cold side	79
Figure 4.6	Load voltage V_o (at 0.5 ohm Load)	81
Figure 4.7	Load current (I_o)	82
Figure 4.8	Three stage Cuk converter circuit	83
Figure 4.9	Measured voltage across MOSFET S_1	83
Figure 4.10	Simulation waveforms of MOSFET switch S_1	84
Figure 4.11	Measured voltage across MOSFET S_2	84
Figure 4.12	Simulation waveforms of MOSFET switch S_2	85
Figure 4.13	Measured voltage across MOSFET S_3	85
Figure 4.14	Simulation waveforms of MOSFET switch S_3	86
Figure 4.15	Measured voltage across MOSFET S_4	86
Figure 4.16	Simulation waveforms of MOSFET switch S_4	87

Figure 4.17	Output diode voltage V_{D_o}	87
Figure 4.18	Simulated voltages and current through the output diode D_o	88
Figure 4.19	Measured output voltage V_o	88
Figure 4.20	Measured output voltage V_o with Fluke power quality analyzer	89
Figure 4.21	Simulated output voltage and current	89
Figure 4.22	Maximum D	90
Figure 4.23	Minimum D	90
Figure 4.24	Converter efficiency versus load	91
Figure 4.25	Efficiency versus the duty ratio	92
Figure 4.26	Output power versus efficiency	92

LIST OF PLATES

		Page
Plate 3.1	A pre-developed TEC cooling prototype	63
Plate 4.1	MOSFETs driver and PWM circuit bread board	71
Plate 4.2	Power circuits board connected to control circuit	71
Plate 4.3	Power circuit PCB	72
Plate 4.4	Power circuit PCB with MOSFET driver circuit	72
Plate 4.5	DC-DC converter 18V supply with R-load	73
Plate 4.6	Temperature monitor circuit	73
Plate 4.7	TEC modules attached to heat sink	74
Plate 4.8	TEC modules attached to heat sink and AL sheet	74
Plate 4.9	Gating driver and isolation circuit	75
Plate 4.10	FLUKE 43B power quality analyzer	76
Plate 4.11	Traditional oscilloscope	76
Plate 4.12	TEC module with the heat sink	79
Plate 4.13	BP solar module	80

LIST OF SYMBOLS

		Page
V_{C1}	Capacitor number 1 voltage (refer Figure 3.14)	54
I_C	Collector current of BJT.	29
V_{CE}	Collector to emitter voltage of BJT.	29
L_i	Converter input inductor	54
L_o	Converter output inductor	55
i_L	Current through inductor	61
R_l	DC resistance of the inductor.	61
V_F	Diode voltage drop at $I_{L(max)}$	61
I_D	Drain current of MOSFET switch	29
$R_{DS(on)}$	Drain to source On-resistance	54
D	Duty ratio percentage (%)	17
t_f	Fall time of MOSFET switch	61
f	Frequency	61
L	Inductor general symbol	61
$i_{init.}$	Initial transient time	28
V_{in}	Input voltage of DC-DC converter in Volts (V)	18
D_{max}	Maximum duty cycle	61
$V_{i(max)}$	Maximum input voltage	61
D_{min}	Minimum duty ratio	61
$V_{i(min)}$	Minimum input voltage	61

V_o	Output v voltage	20
V_o	Output voltage by neglecting losses	61
V_o^*	Output voltage under losses consideration	61
V_{out}	Output voltage of DC-DC converter in Volts (V)	18
$P_{D(conduct)}$	Power loss during conduction time	29
t_r	Rise time of MOSFET switch	61
V_s	Supply voltage	20
t_{off}	Switching Off-time	27
t_{on}	Switching ON-time	28
$t_{on(total)}$	Total On-time of MOSFET switch	61
T	Total switching time	18
$t_{D(Off)}$	Turn Off delay time	59
$v_{Li(off)}$	Voltage across input inductor during switching Off - state	58
$v_{Li(on)}$	Voltage across input inductor during switching On - state	58
V_{S1}	Voltage across MOSFET switch S1.	57
V_{S2}	Voltage across MOSFET switch S2.	57
$v_{Lo(on)}$	Voltage across output inductor during switching ON -state	58
$v_{Lo(off)}$	Voltage across output inductor during switching ON -state	58
V_{RD}	Voltage across the diode resistance	58
V_{Rs}	Voltage across the ON-resistance of MOSFET switch	58
V_{sw}	Voltage drop across the switch	61
V_L	Voltage drop in resistance of inductor	61

LIST OF ABBREVIATION

		Page
AC	Alternating Current	5
CAD	Computer Aided Design	65
DC	Direct Current	5
IC	Integrated Circuit	37
IEEE	Institute of Electrical and Electronic Engineering	107
IR	International Rectifier	34
MOSFET	Metal Oxide Field Effect Transistor	33
MTBF	Mean Time Between Failure	43
PCB	Printed Circuit Board	68
PV	Photovoltaic	3
PWM	Pulse Width Modulation	10
RTD	Resistance Temperature Detector	40
SC	Switching Converters	47
SCC	Switch Capacitor Converter	26
SIMCAD	Simulation of Computer Aided Design	65
SMPC	Switch Mode Power Converter	9
SMPS	Switch Mode Power Supply	1
SPS	Switching Power Supply	7
TEC	Thermo Electric Cooler	42

LIST OF PUBLICATIONS & SEMINARS

	Page
1 Salah, W., Taib, S. (2006). Improvement of Transformerless 200W SMPS Using CUK DC-DC Converter. First IEEE International Power and Energy Conference, PECon 2006. Putrajaya, Malaysia. 28-29 November, 2006.	127
2 Taib, S., Anwar, A., Salah, W. (2006). Energy Efficiency Practice: Concept, Indicator and Benefit. JSPS-VCC Group Seminar 2006, National Resources and Energy Environment. Johor Bahru, Malaysia. 11-12 December, 2006.	128
3 Al-Mofleh A., S Taib, and Salah, W. (2007). Energy Policy and Energy demand for Malaysian Development Energy Efficiency. First Power Engineering and Optimization Conference 2007, PEOCO2007. Shah Alam, Malaysia. 6 th June 2007.	129

PEMBANGUNAN PENUKAR CUK PELBAGAI ARAS UNTUK PENGAWALAN VOLTAN PV

ABSTRAK

Tesis ini mengemukakan reka bentuk pengubah SPMS untuk aplikasi berkuasa rendah. Litar penukar adalah berdasarkan topologi CUK yang secara asasnya ialah kombinasi topologi penukar “buck” dan “boost”. Topologi penukar yang dicadangkan adalah berdasarkan junaman masukan voltan ke dalam peranti penyimpanan dalam keadaan pengecasan dan menghantar tenaga yang disimpan dalam keadaan penyahcasan. Proses ini akan beroperasi pada kelajuan tinggi untuk memastikan pengaliran arus beban yang berterusan. Penukar yang rekabentuk mampu menukar masukan voltan arus terus melalui pemengal voltan pelbagai peringkat. Penghantaran tenaga dilakukan melalui elemen kapasitif untuk memastikan riak arus beban yang minimum. Pensuisan pantas dan rintangan yang rendah dari MOSFET berkuasa tinggi digunakan untuk menurunkan voltan. Suis berkuasa tinggi beroperasi pada frekuensi yang tinggi dan kawalan IC SG3524 PWM digunakan untuk memberikan denyut isyarat pengoperasian untuk pensuisan. Hasil simulasi menunjukkan penukar boleh membekalkan kuasa ke beban sehingga 100 Watt dengan 90% kecekapan parameter berdasarkan nilai unggul dan beban terkadar daripada sel PV. Keputusan simulasi, menunjukkan penukar boleh beroperasi dengan baik pada frekuensi pensuisan yang tinggi sehingga 500KHz. Bagi meminimumkan tekanan terhadap suis MOSFET, frekuensi yang digunakan oleh penukar ialah 200kHz.

Komponen litar yang dipilih memberikan kadar pensuisan dan kehilangan kealiran yang minimum.

Secara praktikalnya, penukar berfungsi pada kecekapan kuasa sebanyak 80% untuk beban 70Watt dan sesuai untuk applikasi TEC.

DEVELOPMENT OF MULTISTAGE CUK CONVERTER FOR PV VOLTAGE REGULATION

ABSTRACT

This thesis presents the design of a transformerless SMPS for low power applications. The converter circuit is based on CUK topology which is basically a combination of buck and boost converter topologies. The proposed converter topology is based on dividing the input voltage into storage devices as charging state and delivering the stored energy to the load in the discharging state. This process is operated at high speed to ensure continuous conduction of load current. The developed converter converts input DC voltage throughout multistage voltage chopping. The transfer of energy through the capacitive elements ensures that the load current is almost ripple free. Fast switching and low On-resistance power MOSFETs were used to step down the input voltage. The power switches operated at high frequency, and the PWM control IC was used to provide the operating signal for the switch.

The simulation results show, that the converter had the capability to supply the load of power up to 100W with an efficiency of 90% under ideal parameters using rated load supplied from PV cell. The results show that the converter could operate properly at high switching frequency up to 500KHz. For the purpose of minimization of the stress on MOSFET switches, the frequency used for implementation of the converter was 200KHz. The circuit components were selected to reduce the switching and conduction losses. Practical implementation of the converter shows that the converter operated at an efficiency of 80% at 70W load, and suitable for TEC application.

CHAPTER 1

INTRODUCTION

1.0 Introduction

Power supply is a buffer circuit that provides power, required by the load from a primary power source with characteristics incompatible with the load. It makes the load compatible with its power source. A Power supply is also known as a power converter and the process is called power conversion. It is also called a power conditioner and the process is called power conditioning.

Power supply can be defined as a device that converts the available power of one set of characteristics to another set of characteristics to meet the specified requirements. Typical application of power supplies includes the conversion of a raw input voltage to a controlled or stabilized voltage for the operation of electronic equipment.

Switch mode power supplies (SMPS) can be used in applications of high current drain which require a low stable supply voltage. Switching power supplies are of highly efficient devices.

The essential feature of a switch mode regulation of DC voltages is that the load is connected to the power source at regular intervals by a semiconductor switch, and then disconnected. The mean value of the voltage applied to the load is maintained at a nearly constant level by an automatic regulation circuit that vary the duration of On and Off periods of the power switch.

1.1 Problem Statement

SMPS occupies between the two type of converters namely, the line regulated and resonant converters. The main problem of the line regulator is high power losses which is being dissipated mainly as heat, and the efficiency level is very low, at around only 40%. On the other hand this type of regulators are cheap and simple, relative to resonant converters which are complex and expensive but are highly efficient.

The switching converter is a good choice for many applications, and so the development of this converter was the object under interest. The existence of a transformer in DC-DC conversion process of switching converter, would limit the control range of duty ratio to a small value (Middlebrook, 1988).

The primary design problem of the system was to interconnect the converter components and to control the switches, so that desired results can be obtained. The secondary design problem was to avoid using loose components that will affect the converter performance and characteristics.

1.2 Scope

Nowadays all applications emphasize on efficiency. Switch mode power supply (SMPS) design minimizes the use of loose components such as resistors and use components that are ideally lossless, such as switches, capacitors, inductors, and transformers. This project concentrates on usage of power storage elements in the implementation of a power conversion process, and then transferring the stored energy to the load.

The design of the switching converter and the selection of switching elements and their configuration was the highest challenge. The simulation test

has to be done under ideal considerations, so that the implementation and fabrication of hardware will be the real challenge. A proper topology and control was chosen that would exceed the performance requirements.

1.3 Objectives

The design process was considered successful when a proper topology and control had been chosen to exceed the performance requirements and when protection techniques and parts were selected to exceed the required reliability. So the main objective will be:

- To select a proper topology for DC-DC converter.
- To select suitable components for converter that ensures the best performance.
- To develop a DC converter that is compatible with photovoltaic (PV) as a source for input power.
- To develop a power supply that is capable to supply TEC load.
- To avoid the use of transformers in DC-DC conversion process.
- To have a power supply with relatively good efficiency.
- To develop a cooling system for the telecommunication cabinets cooling applications.

1.4 Thesis Layout

The thesis chapters are arranged in such away that the project work details have been clearly presented. The thesis was arranged in five chapters namely: Introduction, Literature Review, Design of the 3-Stage Non-inverting Cuk Converter, Results and Discussion and ended with the Conclusion.

An introduction to power supply, the objectives of the project and proposed solutions were illustrated with a scope of the basic topology of Cuk converter and multistage converters in the first chapter.

Although many topologies are introduced in the implementation of DC-DC converters, basically they are categorized into three main topologies, which are Buck (step-down), Boost (step-up) and buck-boost (step up/down) converters. Chapter 2 presents an introduction and a review of power supply main topologies, a general scope on DC-DC converters, and thorough details on the topology circuits and waveforms, and theories of such converters. The position of the switching capacitor converter among other topologies is illustrated with comparison of advantages and disadvantages of each topology.

The approaches and methods of this project have been explained thoroughly in Chapter 3. The chapter starts with an introduction to the basic switch capacitor converter topology and then goes to the basic Cuk converter topology configuration. The details of the DC-DC conversion process are illustrated clearly.

The results and discussion are presented in Chapter 4 where all the details of project simulation and experimental results are illustrated with figures, waveforms and plots. The discussion and summary of this chapter would be presented at the end of the chapter.

Finally, Chapter 5, the conclusion chapter provides the overview of the objectives achieved by this project, and it also provides suggestions and recommendations for future work.

CHAPTER 2

LITERATURE REVIEW

2.0 Introduction

A power supply assumes a very unique role within a typical system. It can be considered as the mother of the system. It gives the system life by providing consistent and repeatable power to its circuits. It defends the system against the harsh world outside the confines of the enclosure and protects its wards by not letting them to do harm to themselves. If the supply has a failure within itself, it must fail gracefully and not allow the failure to reach the system (Ferenczi, 1987).

Power processing is an essential stage of most electrical equipments. The differences in voltages and currents required for different applications led to the design of special power converters (Tse, et al., 1994).

Generally power conversion process involves either converting alternating (AC) to direct current (DC) or converting DC of one voltage level to other voltage level depending on the application requirements (Ferenczi, 1987).

2.1 Power Supply Rule

The primary function of a power supply is to hold the voltage in its output circuit at predetermined value over the expected range of load currents. The degree of which the power supply is able to maintain constant voltage against variation in load current, input voltage and temperature will determine the quality of the designed power supply.

The power supply has been considered as the heart of any electrical system, and so it plays an important role. The quality of power conversion highly affects the overall performance of the system (www.psma.com).

2.2 DC-DC Converters

DC conversion is of great importance in many applications, starting from low power applications to high power applications. The goal of any system is to emphasize and achieve the efficiency to meet the system needs and requirements. Several topologies have been developed in this area, but all these topologies can be considered as apart or a combination of the basic topologies which are buck, boost and flyback (Rashid, 2001).

For low power levels, linear regulators can provide a very high-quality output voltage. For higher power levels, switching regulators are used. Switching regulators use power electronic semiconductor switches in On and Off states. Because there is a small power loss in those states (low voltage across a switch in the On state, zero current through a switch in the Off state), switching regulators can achieve high efficiency energy conversion (Rashid, 2001).

The functions of dc-dc converters are:

- 1- Convert a DC input voltage V_s into a DC output voltage V_o .
- 2- Regulate the DC output voltage against load and line variations.
- 3- Reduce the AC voltage ripple on the DC output voltage below the required level.
- 4- Provide isolation between the input source and the load (if required).

5- Protect the supplied system and the input source from electromagnetic interference (EMI) (Krein, 1998).

The DC-DC converter is considered as the heart of the power supply (Perez, 2000), thus it will affect the overall performance of the power supply system. The converter accepts DC and produces a controlled DC output.

2.3 Power Supply Types

The three major power supply technologies that can be considered within a power supply system are:

1. Linear voltage regulators.
2. Pulse-width modulated (PWM) switching power supplies.
3. High efficiency resonant technology switching power supplies.

2.3.1 Linear Voltage Regulator

The linear regulator is the original form of the regulating power supply. It relies upon the variable conductivity of an active electronic device to drop voltage from an input voltage to a regulated output voltage (Brown, 1994).

The linear regulator wastes a lot of power in the form of heat, and therefore gets hot. The linear power supply finds a very strong niche within applications where its inefficiency is not important and also where low cost and a short design period are desired. The linear regulator is sometimes referred as dissipative regulator (Sum, 1984). These include wall-powered, ground-base equipment where forced air cooling is not a problem, and also those applications in which the instrument is so sensitive to electrical noise that it requires an electrical “quiet” power supply. These products might include audio

and video amplifiers, RF receivers, and so forth. Linear regulators are also popular as local, board-level regulators. Here only a few watts are needed by the board, so the few watts of loss can be accommodated by a simple heat-sink (Brown, 1990).

Linear regulators can only produce output voltages lower than their input voltages and each linear regulator can produce only one output voltage. Each linear regulator has an average efficiency of between 35 and 50 percent; the losses are dissipated as heat.

Linear regulators are step-down regulators only; that is, the input voltage source must be higher than the desired output voltage. There are two types of linear regulators: the shunt regulator and the series-pass regulator (Rashid, 2004).

2.3.1.1 The shunt regulator

It is a voltage regulator that is placed in parallel with the load. An unregulated current source is connected to a higher voltage source, the shunt regulator draws output current to maintain a constant voltage across the load and gives a variable input voltage and load current. A common example of this is a zener diode regulator (Ang and Oliva, 2005).

2.3.1.2 The series-pass linear regulator

Comparatively this is more efficient than the shunt regulator and uses an active semiconductor as the series-pass unit between the input source and the load. In general, the linear regulator is quite useful for those power supply applications requiring less than 10W of output power. Above 10W the heat-sink

required becomes so large and expensive that a switching power supply becomes more attractive (Ang and Oliva, 2005).

The basic linear regulator as shown in Figure 2.1 illustrates the major parts of a series-pass linear regulator.

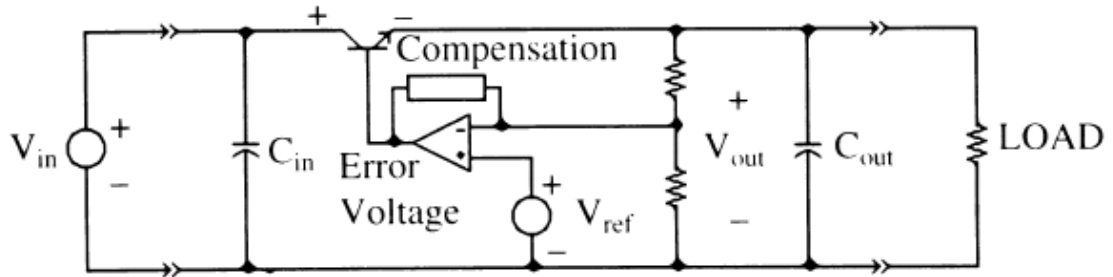

Figure 2.1 Basic linear regulator

2.3.2 PWM Switch Mode Power Supply (SMPS)

A switching mode power converter (SMPC) is a power electronic system, which converts one level of voltage into another level of voltage at load side by switching on and off of power switches.

In DC to DC switching circuits, the power switches control the transfers of power from the input DC source to the load by means of connecting the power to the load for a predetermined duration (Krein, 1998). Switching power supply has a higher efficiency, less heat, and is smaller in size and weight in comparison with the linear voltage regulator. They are commonly found within portable products, aircraft and automotive products, small instruments, off-line applications, and generally applications where high efficiency and multiple output voltages are required (Maniktala, 2005).

a) Principle of Operation

The operation of switching power supplies can be relatively easy to understand. Unlike linear regulators which operate the power transistor in the linear mode, the PWM switching power supply operates the power transistors in both the saturated and cutoff states. In these states, the volt-ampere product across the power transistor is always kept low (saturated, low-voltage / high-current; and cutoff, high-voltage / No-current). This product within the power device is the loss within all the power semiconductors (Hnatek, 1989).

This more efficient operation of the PWM switching power supply is done by “chopping” the direct current (DC) input voltage into pulses whose amplitude is the magnitude of the input voltage and whose duty cycle is controlled by a switching regulator controller. These AC waveforms are then filtered to provide the DC output voltages (Pressman, 1998). The controller; main purpose is to maintain a regulated output voltage and operates like a linear style controller. That is, the functional blocks, voltage reference, and error amplifier are arranged identical to the linear regulators. The difference in the output of the error amplifier (the error voltage) is then placed into a voltage-to-pulse-width converter stage prior to driving the power switches (Brown, 1994).

b) Operational Types

There are two major operational types of switching power supplies: the forward-mode converter and the Fly back Mode Converter. Although the arrangements of their parts are subtly different, their operation is very different and each has advantages in certain areas of application (Brown, 1990).

i) The Forward Mode Converter

Forward-mode regulators form a large family of switching power supply topologies. They can be recognized by an L-C filter just after the power switch or after the output rectifier on the secondary of a transformer. A simple form of the forward-mode regulator can be seen in Figure 2.2. This is called the buck regulator (Mohan et al., 2003).

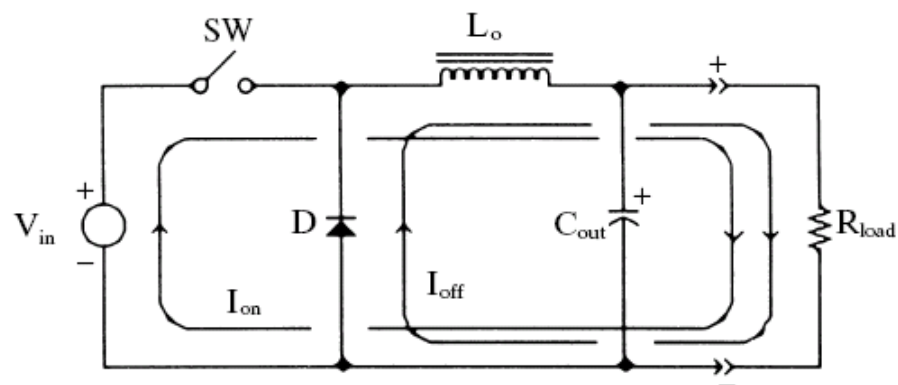

Figure 2.2 Basic forward-mode converter (buck converter).

Its operation can be seen as analogous to a mechanical flywheel and a one piston engine. The L-C filter, like the flywheel, stores energy between the power pulses of the driver. The input to the L-C filter (choke input filter) is the chopped input voltage. The L-C filter volt-time averages this duty-cycle modulated input voltage waveform.

The output voltage is maintained by the controller by varying the duty cycle. The buck converter is also known as a step-down converter, since its output must be less than the input voltage. The operation of the buck regulator can be seen by breaking its operation into two periods as shown in Figure 2.3. When the switch is turned on, the input voltage is presented to the input of the L-C filter.

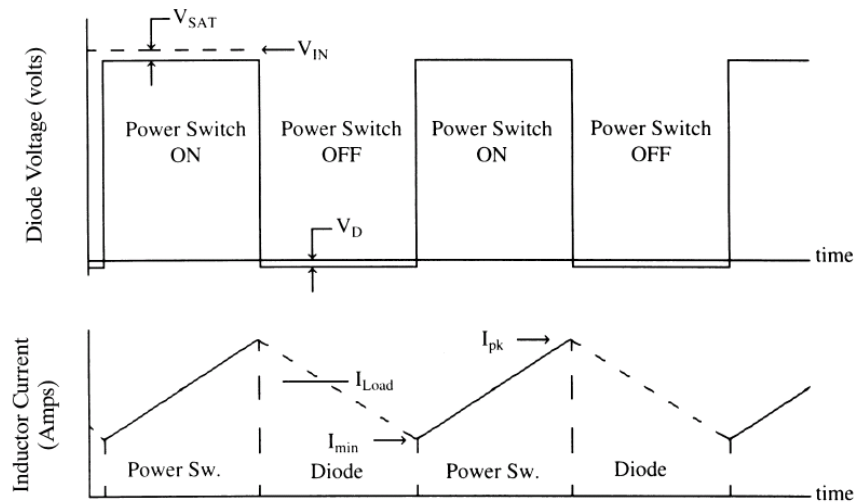

Figure 2.3 Voltage and current waveforms for a forward-mode converter (buck converter).

ii) The Flyback Mode Converter

The second family of converters is the flyback (boost) mode converters. The most elementary flyback-mode (or boost-derived) converter can be seen in Figure 2.4. It is called a boost converter (Ang and Oliva, 2005).

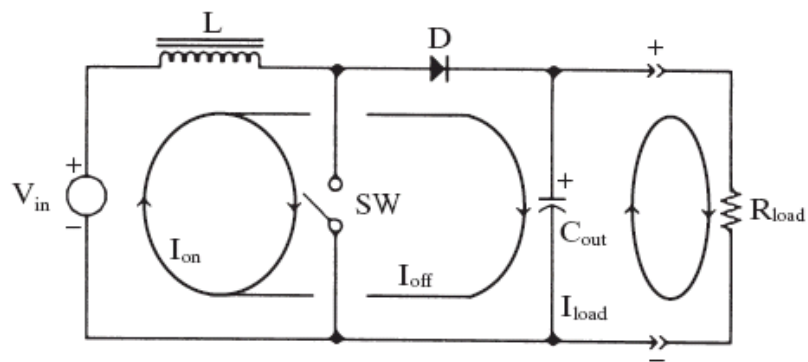

Figure 2.4 Basic flyback-mode converter (boost converter shown).

The boost-mode converter has the same parts as the forward-mode converter, but they have been rearranged. This new arrangement causes the converter to operate in a completely different fashion than the forward-mode converter. This time, when the power switch is turned on, a current loop is

created that only includes the inductor, the power switch, and the input voltage source. The diode is reverse-biased during this period.

The inductor's current waveform is shown in Figure 2.5 is also a positive linear ramp.

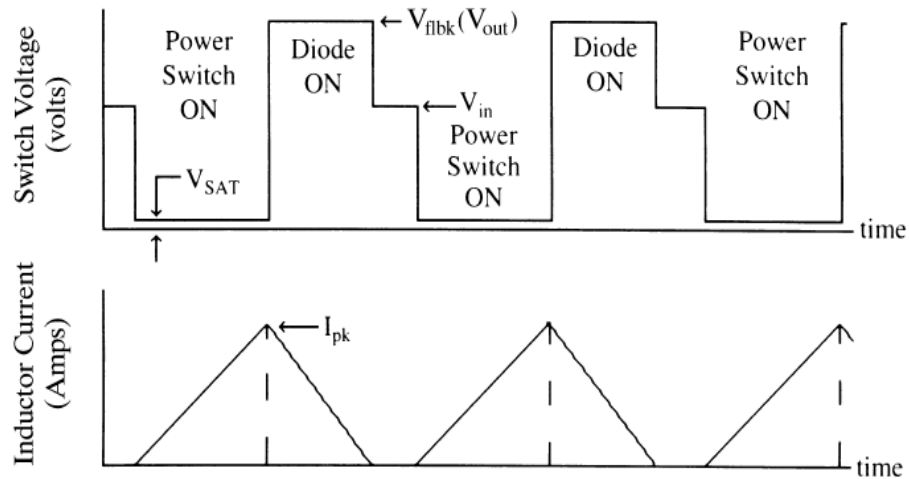

Figure 2.5 Waveforms for a discontinuous-mode boost converter.

2.3.3 Resonant Converters

This variation on the basic PWM switching power supply finds its place in applications where still lighter weights and smaller sizes are desired, and most importantly, where a reduced amount of radiated noise (interference) is desired. The common products where these power supplies are utilized are aircraft avionics, spacecraft electronics, and lightweight portable equipment and modules.

The drawbacks are that, this power supply technology requires the greatest amount of engineering design time and usually costs more than the other two previous technologies (Gottlieb, 1981). The trends within the industry are away from linear regulators (except for board-level regulators) towards PWM switching power supplies. Resonant and quasi-resonant switching power

supplies are emerging slowly as the technology matures and their designs are made easier (Luecke, 2005).

Table 2.1 shows a comparison between the last three technologies, referring to their cost, weight, efficiency, and development difficulties.

Table 2.1 Power supply technologies

	Cost	Weight	Efficiency	Development Difficulties
Linear Regulator	Low	High	34-50%	Simple
PWM Switch Mode converter	High	Low-Medium	70-85%	Medium
Resonant Switch mode converter	Highest	Low-Medium	78-92%	Hard

Resources: Marty Brown, Power Supply Cookbook, 1994.

2.4 Power supply Basic Topologies

Whittington, (1992) presents an overview of the most important DC-DC converter topologies. The main objective is to guide the designer in selecting the topology with its associated power semiconductor devices. The DC-DC converter topologies can be divided into two major parts, depending on whether or not they have isolated between the input supply and the output circuitry.

Non - Isolated Switching Regulators:

According to the position of the switch and the rectifier, different types of voltage converters can be made:

- Step down "Buck" regulator
- Step up "Boost" regulator

- Step up / Step down “Buck - Boost” regulator
- Transformerless CUK Converter

Isolated Converters

The isolated converters can be classified according to their magnetic cycle swing in the B-H plot as shown in Figure 2.6. An isolated converter is asymmetrical, if the magnetic operating point of the transformer remains in the same quadrant. Any other converter is of course called symmetrical.

In this project, the main interest will be towards transformerless DC-DC converter topology.

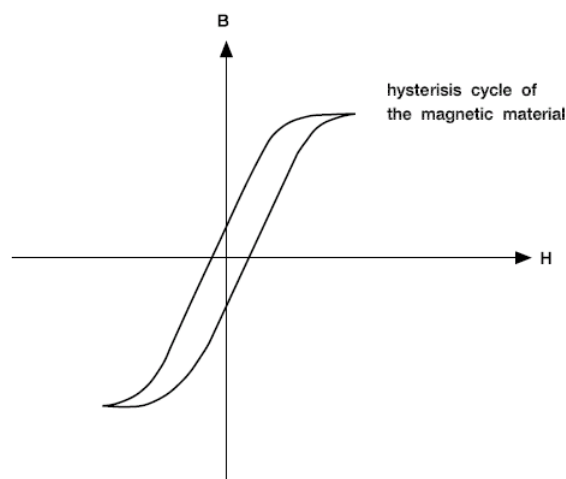

Figure 2.6 B-H plots of symmetrical converters

2.4.1 Buck Converters

The step-down DC converter, commonly known as a buck converter is shown in Figure 2.7. It consists of DC input voltage source V_{in} , controlled switch S, diode D, filter inductor L, filter capacitor C, and load resistance R (Rashid, 2003).

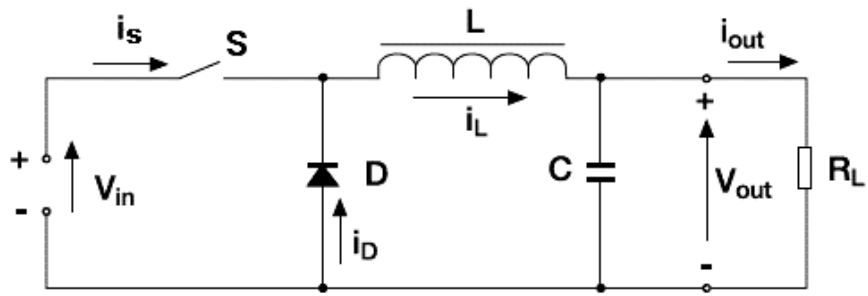

Figure 2.7 Buck converter

Typical waveforms in the converter are shown in Figure 2.8 under the assumption that the inductor current is always positive (Trzynadlowski, 1998). The state of the converter in which the inductor current is never zero for any period of time is called the continuous conduction mode (CCM). It can be seen from the circuit that when the switch S is commanded to the On state, the diode D is reverse-biased. When the switch S is Off, the diode conducts to support an uninterrupted current in the inductor.

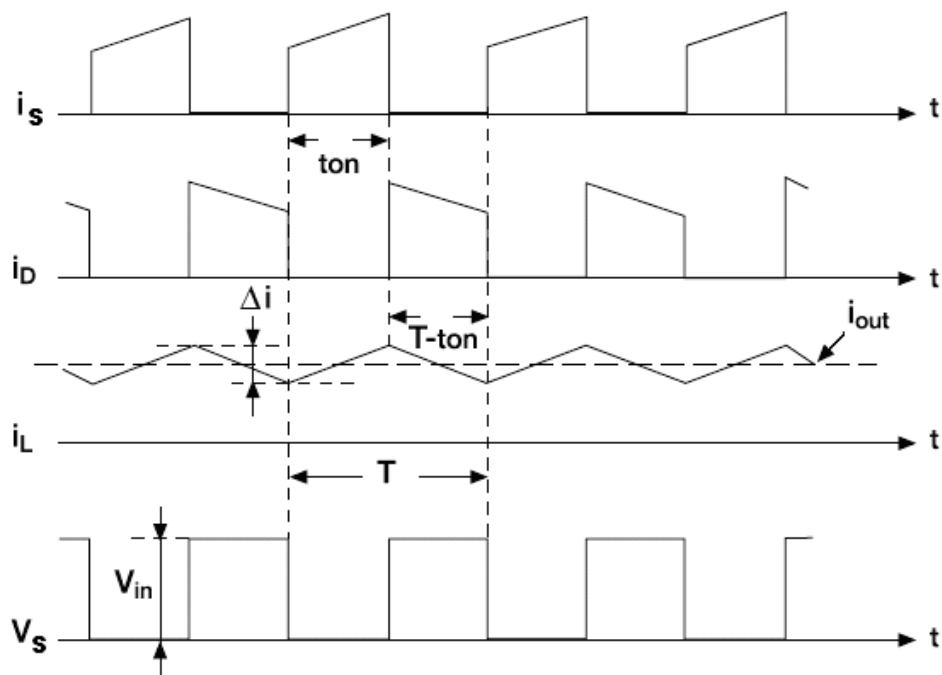

Figure 2.8 Typical waveforms of buck converter

The relationship among the input voltage, output voltage, and the switch duty ratio D can be derived, based on the Faraday's law i.e., the inductor volt-second product over a period of steady-state operation is zero.

2.4.2 Boost Converters

A step-up or a PWM boost converter as shown in Figure 2.9 consists of DC input voltage source V_{in} , boost inductor L , controlled switch S , diode D , filter capacitor C , and load resistance R (Rashid, 2003). The converter waveforms in the continuous conduction mode are presented in Figure 2.10.

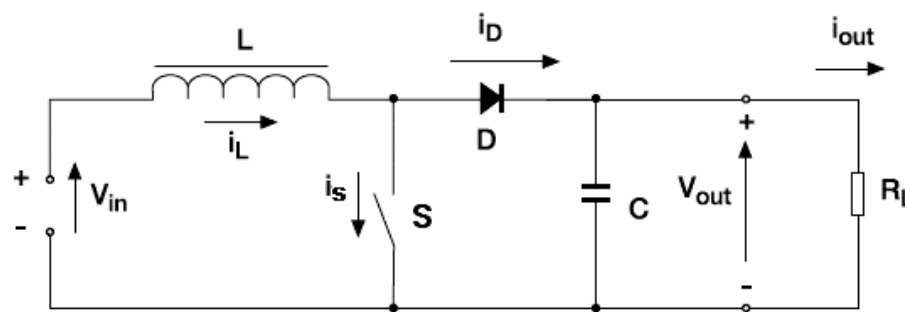

Figure 2.9 Boost (step-up) converter

When the switch S is in the on state, the current in the boost inductor increases linearly and the diode D is off at that time. When the switch S is turned off, the energy stored in the inductor is released through the diode to the output RC circuit.

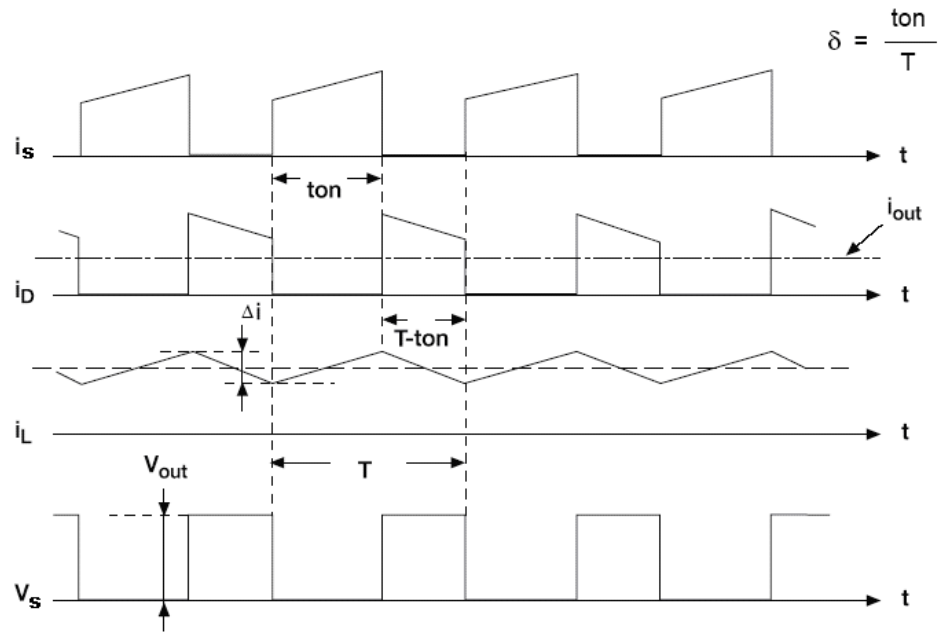

Figure 2.10 Typical waveforms of boost converter

2.4.3 Buck Boost Converters

A non-isolated (transformerless) topology of the buck-boost converter is shown in Figure. 2.11. The converter consists of DC input voltage source V_{in} , controlled switch S , inductor L , diode D , filter capacitor C , and load resistance R . With the switch on, the inductor current increases while the diode is maintained off. When the switch is turned off, the diode provides a path for the inductor current (Schuler, 2003; Brown, 1994).

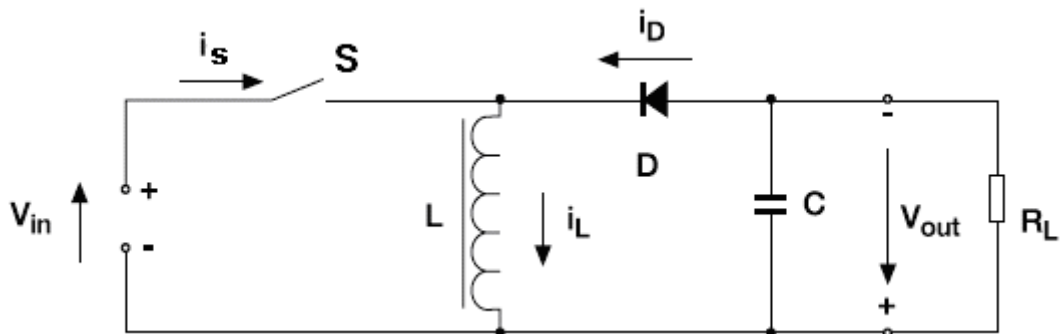

Figure 2.11 Buck-boost converter

The polarity of the diode that results in its current is being drawn from the output. The buck-boost converter waveforms are depicted in Figure 2.12. The output voltage V_o is negative with respect to the ground. Its magnitude can be either greater or smaller (equal at $D = 0.5$) than the input voltage as the name of the converter implies.

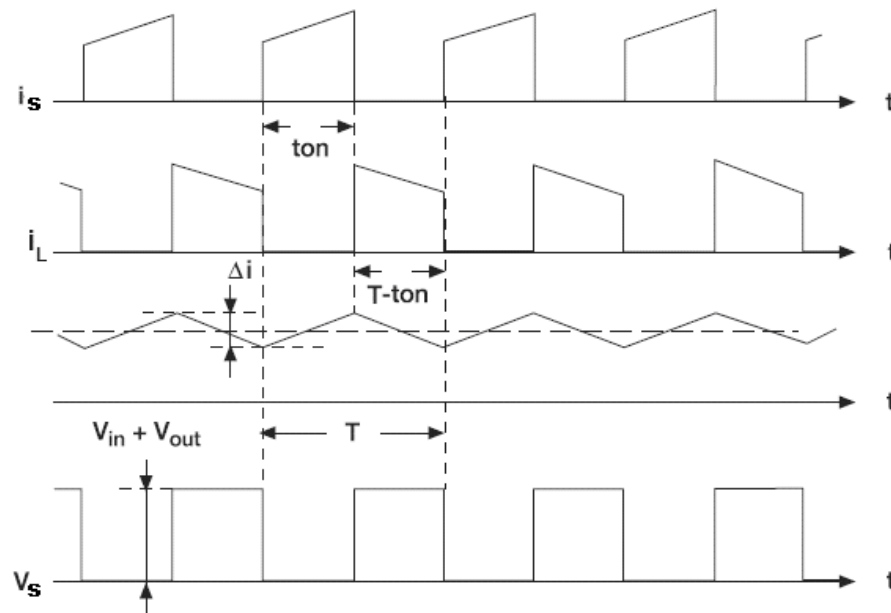

Figure 2.12 Typical waveforms of buck-boost converter

2.4.4 Cuk Converters

The buck, boost and buck-boost converters all transfers energy between input and output using the inductor, analysis being based on the voltage balance across the inductor. The Cuk converter uses the capacitor for energy transfer and the analysis is based on the current balance of the capacitor (Chryssis, 1984; Middlebrook, 1998).

a) CUK circuit and waveforms

The circuit of the Cuk converter is shown in Figure 2.13 consists of DC input voltage source V_s , input inductor L_1 , controllable switch S , energy transfer

capacitor C_1 , diode D , filter inductor L_2 , filter capacitor C , and load resistance R . An important advantage of this topology is a continuous current at both the input and the output of the converter. Disadvantages of the Cuk converter are a high number of reactive components and high current stresses on the switch, the diode, and the capacitor C_1 .

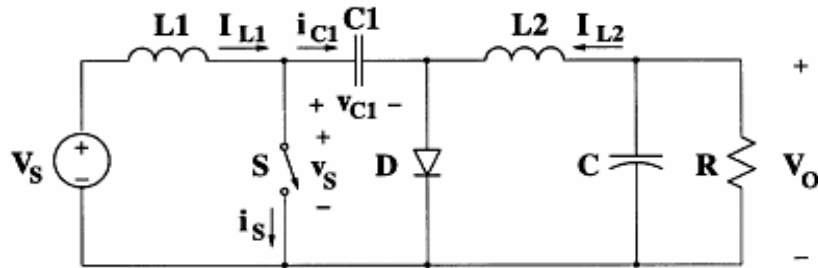

Figure 2.13 Cuk converter circuit

The main waveforms of the converter are presented in Fig. 2.14. When the switch is on, the diode is off and the capacitor C_1 is discharged by the inductor L_2 current. With the switch in the off state, the diode conducts currents of the inductors L_1 and L_2 , whereas capacitor C_1 is charged by the inductor L_1 current (Rashid, 2004; Ang, 1995).

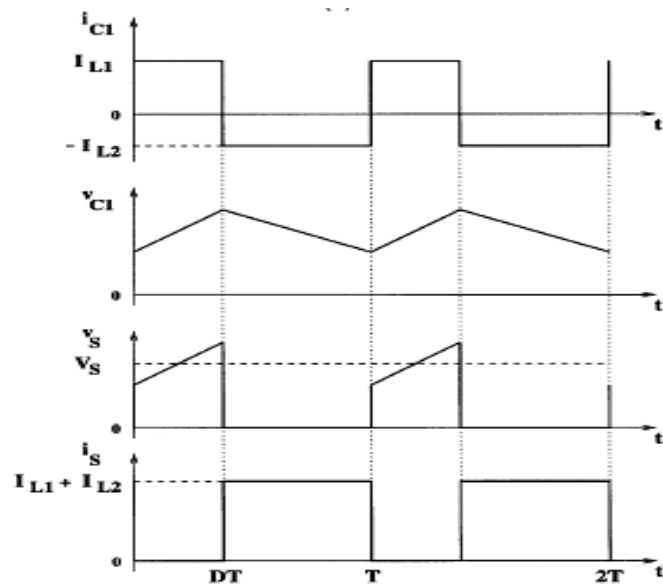

Figure 2.14 Cuk converter waveforms

b) CUK converter operation

The DC transfer function for the buck, boost, and Cuk PWM DC-DC converters in continuous conduction mode are, D , $1 / (1 - D)$, and $-D / (1 - D)$ respectively, where D is the duty cycle. Therefore the Cuk PWM DC-DC converter circuit can be synthesized by cascading boost and buck converter circuits (Bryant and Kazimierczuk, 2003; Beil et al., 1999).

The circuit of Figure 2.15 is the Cuk converter which can be considered as a boost converter cascade with a buck converter, realized with minimum amount of components.

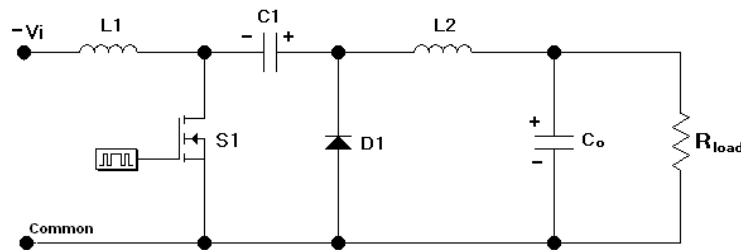

Figure 2.15. Cuk converter

The block diagram of the transformerless Cuk PWM converter circuit topology is shown in Fig. 2.16.

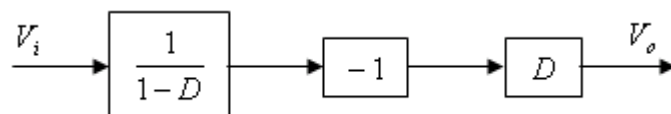

Figure 2.16 Transformerless Cuk PWM converter

This is the starting point for simplifying the cascaded connection of the boost and buck converter circuits into the Cuk converter circuit.

The basic operation of the Cuk converter can be illustrated as in Figure 2.17, when the switch S is at position A ; the energy will be loaded to $L1$, at the same

time the energy stored in C_1 will be discharged to the load R_o , through the low-pass filter L_o-C_o .

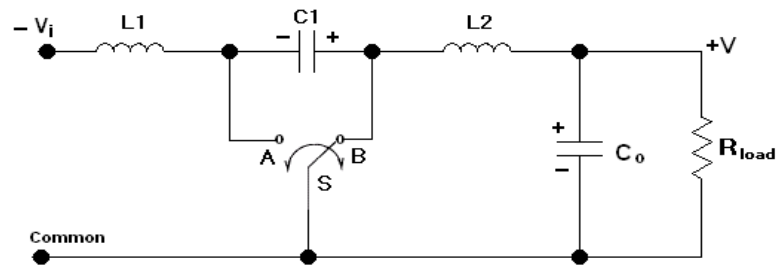

Figure 2.17 Equivalent circuit of the Cuk converter

c) Cuk converter derivation

In 1978, the US Patent Office granted Dr Slobodan Cúuk of CalTech (pronounced Chook) a patent for the design of a new SMPS topology. The benefits of his new topology includes increased efficiency, low input and output current ripple, minimal RFI and small size and weight (www.pσμα.com).

The figures below, show how the Cuk circuit is derived. Firstly, consider a boost converter followed by a buck converter as shown in Figure 2.18.

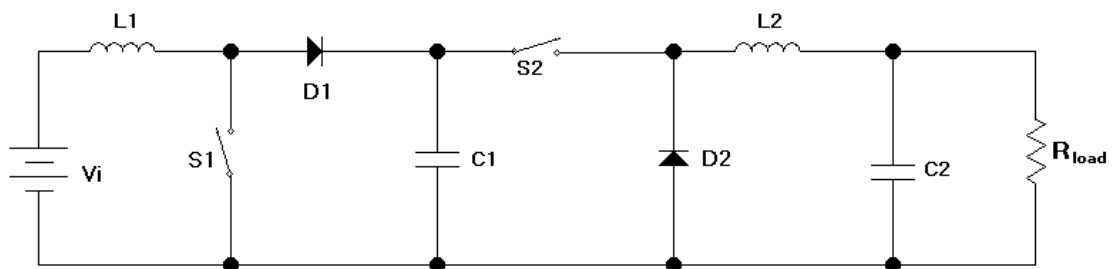

Figure 2.18 Boost converter followed by a buck converter

If the diodes are considered as switches, then the two switch-and diode sets could be replaced with a Double Pole, Double Throw (DPDT) switch as shown in Figure 2.19.

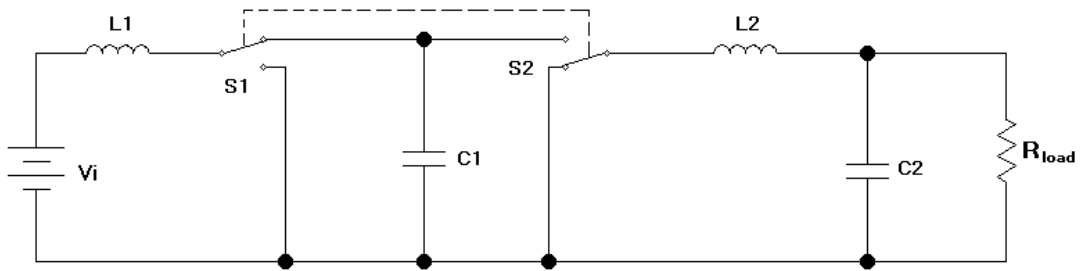

Figure 2.19 Equivalent circuit with switches

The DPDT switch and shunt capacitor can be replaced with a Single Pole, Single Throw (SPST) switch and series capacitor, provided a reverse of output polarity is accepted, as shown in Figure 2.20.

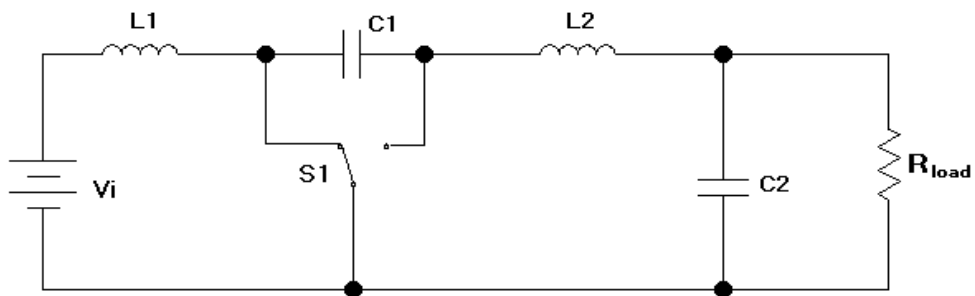

Figure 2.20 Single switch equivalent circuit

The circuit shown in Figure 2.20 is an example of a Cuk converter. A practical realization could be as shown in Figure 2.21.

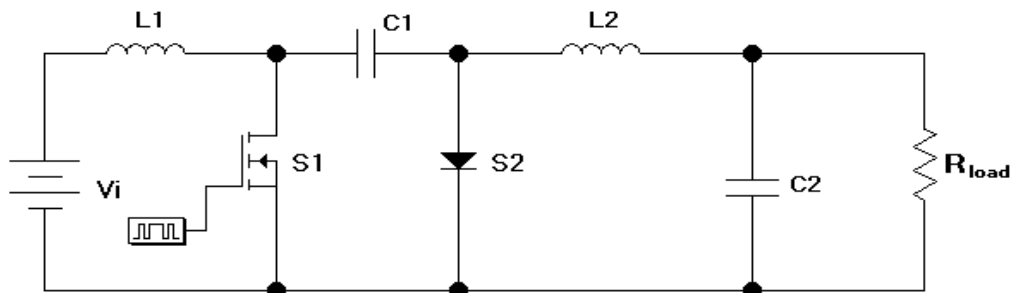

Figure 2.21 Cuk practical realization

The DC voltage transformation ratio M is $M=D/D'$, where D is the duty ratio (fractional on-time) of the transistor switch operated at a switching frequency $1/T_s$, and $D'=1-D$ is the complementary duty ratio (fractional off-time).

For a DC input voltage V_i , the output voltage is $V_o=MV_i$. The converter thus has a step down ratio for $D<0.5$ and a step-up ratio for $D>0.5$. The other principal feature is that both the input and output currents are non-pulsating, both being smoothed by the input and output inductors. These inductors also eliminate current surges in the transistor switch at power-on and power-off, which is often a difficult problem to solve.

The output capacitance C_2 is usually included to absorb the load current fluctuations. The Cuk converter is unique because of the capacitive energy transfer from the input to the output instead of inductive energy transfer converters. Therefore capacitive energy transfer is more effective in comparison with the unit size or weight basis than the inductive energy transfer (Yaskiv, 2001).

Because the input and output inductor currents are essentially constant, the switching current is confined entirely within the converter in the transistor coupling capacitor-diode loop. With careful layout this loop can be made physically small, in order to reduce the radiated RFI from the magnetic field (Wanior, 2003).

2.5 Transformer Based Topologies

Other topologies for DC-DC converters also exist. These are transformer based topologies. The following are a list of these topologies (Whittington et al., 1992; Krein, 1998).