

Berichte  
aus dem  
Institut für Meereskunde  
an der  
Christian-Albrechts-Universität Kiel

Nr. 62

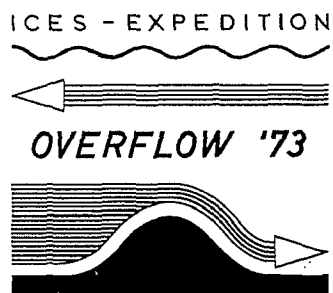

THE DISTRIBUTION OF WATER MASSES  
ON THE GREENLAND-SCOTLAND RIDGE  
IN AUGUST/SEPTEMBER 1973 <sup>⊕</sup>

a Data-Report

by

T.J. MÜLLER <sup>+</sup>, J. MEINCKE <sup>+</sup> and G.A. BECKER <sup>++</sup>

⊕ ICES Expedition Overflow '73, Contribution No. 36

+ Institut für Meereskunde an der Universität Kiel  
Düsternbrooker Weg 20  
2300 Kiel  
Germany

++ Deutsches Hydrographisches Institut  
Bernhard-Nocht-Str. 78  
2000 Hamburg  
Germany

Copies of this report are available on request from the authors.

---

ISSN 0341 - 8561

DOI 10.3289/IFMLBER\_62

Die „Berichte aus dem Institut für Meereskunde“ erscheinen in unregelmäßiger Folge und sind gedacht als Arbeitsunterlagen für den sich mit dem jeweiligen Thema befassenden Personenkreis. Die Hefte werden fortlaufend nummeriert. Sie sind unredigierte Beiträge und geben allein die Meinung des Verfassers wieder.

**D 2300 Kiel 1, Düsternbrooker Weg 20**

<u>Contents</u>	Page
Summary/Zusammenfassung	6
1. Introduction	7
2. Observed water masses and their TS-relation	8
3. Methods of analysis	11
4. References	13
5. Tables, section index maps	14
Table 1: List of origin of data	14
Table 2: Water mass characteristics	15
Table 3: Mixing triangles used for calculation of fractions of water masses	16
Table 4: List of water masses and mixing triangles analysed	17
Section index maps	18
6. Water mass analysis	20
6.1 Explorer	21
6.2 Helland-Hansen	35
6.3 J.C. Svabo	46
6.4 Challenger	50
6.5 Cirolana	59
6.6 Shackleton	63
6.7 Boris Davydov	72
6.8 Meteor	79
6.9 Bj. Saemundsson	89
6.10 Walter Herwig	103
6.11 Hudson	125
6.12 Professor Viese	155

### Summary

In August/September 1973 the ICES Expedition Overflow '73 was carried out in the area of the Greenland-Iceland-Scotland ridge to study the arctic overflow. TS-profiles from both, hydrocasts and CTD's of twelve ships from seven countries are analysed for water masses of the area. The results are presented shipwise in terms of overall TS-diagrams and sections of water masses contributing to the deep overflow of arctic and subarctic waters across the ridge. These are Norwegian Sea Deep water (NS) for the whole area. A mixture of North Icelandic Winter water and Arctic Intermediate water (NI/AI) and East Icelandic Winter water (EIW) which origin from the East Icelandic current contribute as intermediate waters to the deep overflow between Iceland and Scotland. The corresponding intermediate waters on the Greenland-Iceland ridge are Arctic Intermediate (AI) and Polar Intermediate water (PI).

### Zusammenfassung

Im August/September 1973 wurde im Seegebiet des Grönland-Island-Schottland Rückens die Expedition Overflow '73 des ICES durchgeführt. Vertikale TS-Profile von zwölf Schiffen aus sieben Nationen sind einer Analyse auf Wassermassen unterzogen worden. Die Ergebnisse sind für jedes Schiff in Form von TS-Übersichtsdiagrammen der benutzten Profile sowie Vertikal-schnitten derjenigen arktischen und subarktischen Wassermassen dargestellt, die zum tiefen Overflow über das Rückensystem beitragen. Dies ist für den gesamten Bereich das Norwegische See Tiefenwasser (NS). Im Bereich des Island-Farøer-Schottland Rückens trägt ferner als Zwischenwasser eine Mischung aus Nordisländischem Winter- und Arktischem Zwischenwasser (NI/AI) und Ostisländisches Winterwasser (EIW) mit Ursprung im Ostislandstrom zum Overflow bei. Arktisches Zwischenwasser (AI) und Polares Zwischenwasser (PI) sind die entsprechenden Wassermassen im Bereich des Grönland-Island Rückens.

## 1. Introduction

In August/September the ICES Expedition Overflow '73 was carried out in the area of the Greenland-Iceland-Scotland ridge, the main topographic rise between the arctic seas and the North Atlantic. It's main aims were to study the overflow of cold arctic and subarctic waters across the ridge-system which compensates the inflow of Atlantic water, precipitation and run off into the northern seas. This overflow partly occurs in the cold surface currents along the east coast of Greenland and Iceland and a branch of recirculated North Atlantic water which enters the Faroe Shetland channel from the north on the Faroe side. These basic surface currents flowing southwards can already be seen on the early current chart of this area by Helland-Hansen and Nansen (1909).

The existence of a deep overflow of Norwegian Sea Deep water was first recognized by Knudsen (1899). Helland-Hansen and Nansen (1909) also showed the existence of low saline water with temperature ranging from  $0^{\circ}$  C. to  $3^{\circ}$  C. which sinks to depths of 200 m to 500 m south of the polar front. The importance of these intermediate water masses for the deep overflow across the Iceland-Faroe ridge has been pointed out by Stefansson (1962) and Meincke (1972). For the Greenland-Iceland ridge Gade et al. (1965) reported intermediate waters contributing to the deep overflow.

This data report has been initiated by the ICES Working Group on Oceanic Hydrography in order to get a basis knowledge about the distribution of water masses contributing to the deep overflow across the Greenland-Scotland ridge during the ICES expedition Overflow '73. On the basis of hydrographic stations of twelve ships from seven countries (table 1) a TS-diagram analysis for these water masses has been conducted. The results are presented shipwise in terms of watermass-sections and overall TS-diagrams for each section.

A study using the water mass distribution together with results of current measurements during Overflow '73 for the

calculation of transport rates of deep overflow across the ridges is in preparation by one of the authors (Meincke, 1979).

## 2. Observed water masses and their TS-relation

A short review of the origin and characteristics of the water masses observed in the area of Overflow '73 will now be given and summarized in table 2. For further information about origin and formation of water masses see Stefansson (1962).

### (i) Iceland-Faroe-Scotland ridge:

Well southwest of the ridge those undisturbed water masses maybe defined which are involved from the Atlantic side in the intensive mixing over the Iceland-Faroe ridge and in the channel system between the Faroes and Shetlands.

First as deep water the Irminger Sea water (IS,  $\sim 4^{\circ}$  C.,  $\sim 34.97^{\circ}/\text{oo}$ ) is found at depths of 800 m and more. It has been described extensively by Dietrich (1957) and is shown in the TS-diagrams of the southwest stations of SHACKLETON (p. 64, 65, stat 220-226). This deep water does not reach the sill depth and thus does not cross the ridge northwards.

The inflow from the Atlantic towards the Norwegian Sea is completely given by North Atlantic water with core below the surface layer in  $\sim 250$  m in it's pure (NA,  $\geq 9.0^{\circ}$ ,  $\geq 35.32^{\circ}/\text{oo}$ ) or modified form (MNA,  $\geq 8.5^{\circ}$ ,  $\sim 34.24^{\circ}/\text{oo}$ ). NA is found in the southeastern part of the area at all stations of CHALLENGER (p. 50 ff) as well as at the Shetland side of the Faroe-Shetland channel (EXPLORER, p. 23). MNA is observed on the Faroe side of the Faroe-Shetland channel and at all stations of SHACKLETON (p. 65 ff). This supports the idea of a recirculation of North Atlantic water round the Faroes (Meincke, 1978). MNA occurs also on the whole central Iceland-Faroe ridge, but the reason for this is not yet clear. The main part of the south flowing cold Overflow water is given by the well known Norwegian Sea

Deep water (NS,  $\leq 0.5^{\circ} \text{C}$ ,  $\sim 34.92$  ‰). It occurs at all stations north of the ridge in undisturbed form at least from the sill depth on.

Two intermediate water masses also contribute: North Icelandic Winter water is formed in winter on the North Icelandic shelf, mixes with Arctic Intermediate water and flows south-east (Stefansson, 1962). Along the polar front it sinks below the Atlantic water. Its characteristics (NI/AI,  $2.5^{\circ} \text{C} - 3^{\circ} \text{C}$ ,  $34.88$  ‰) are found over the whole area just south and north of the sill depths. To the overflow it contributes less than NS.

The second intermediate water occurs in the region from the southeastern shelf of Iceland towards the central part of the ridge. (W. HERWIG, p. 107, METEOR, p. 81, stat. 39, 41). It can hardly be traced south of the ridge. Due to its low temperature and salinity, according to Meincke (1978), it is speculated to be formed in winter from waters of the East Icelandic current (EIW,  $-0.5^{\circ} \text{C} - 1^{\circ} \text{C}$ ,  $\sim 34.72$  ‰). Low salinity intermediate waters have been shown in sections earlier, e.g. by Dietrich (1956).

Also southeast of Iceland the surface waters of the south going East Icelandic current are defined (EIC,  $6.0^{\circ} \text{C} - 6.5^{\circ} \text{C}$ ,  $34.45$  ‰ -  $34.65$  ‰) with temperatures of the summer season.

All over the ridge the surface waters (SW) of various origins have not been taken into account.

## (ii) Greenland-Iceland ridge

Looking first at the Atlantic components one finds from the southern stations of HUDSON (p. 127, stat. 31 - 37) two deep waters. Irminger Sea water (IS,  $\sim 4^{\circ} \text{C}$ ,  $\sim 34.97$  ‰) is observed in a thick layer below Labrador Sea water (LS,  $\sim 3.8^{\circ} \text{C}$ ,  $\sim 34.88$  ‰) and North Atlantic water (NA,  $\geq 7^{\circ} \text{C}$ ,  $\geq 35.10$  ‰). IS, LS and NA proceed towards the sill of the ridge northwards on the Icelandic side, but

IS and LS seem not to cross the sill whereas NA contributes nearly completely to the northerly inflow. Note that NA in this region is less warm and saline as further southeast. There are four water masses flowing southwards across the ridge (HUDSON, p. 130, stat. 111 - 120). At the surface on the Greenland side it is the East Greenland current with very low saline Polar water with admixtures of low saline Greenland shelf waters. In the upper most meters this water is summer heated. Since the analysis is mainly concerned with the deep overflow, a definition close to the one of Stefansson (1962) for Polar water has been used (P,  $\leq -1.0^{\circ} \text{C}$ ,  $\leq 34.00 \text{ }^{\circ}/\text{oo}$ ).

The most dense water is the Norwegian Sea Deep water (NS,  $\leq -0.5^{\circ} \text{C}$ ,  $\sim 34.92 \text{ }^{\circ}/\text{oo}$ ) which fills the basin north of the sill and is also observed at most stations south of the sill.

Two intermediate water masses contribute also to the overflow. Arctic Intermediate water (AI,  $\sim 1^{\circ} \text{C}$ ,  $\sim 35.00 \text{ }^{\circ}/\text{oo}$ ) is formed by cooling of Atlantic water and mixing with Polar water and bottom water far north of Iceland (Stefansson, 1962) and probably originates from the Spitzbergen Atlantic current (Helland-Hansen and Nansen, 1909). It's high salinity supports this idea, since it cannot be formed by mixing of NA from the western part ( $7^{\circ} \text{C}$ ,  $35.10 \text{ }^{\circ}/\text{oo}$ ) with NS and the waters of the Spitzbergen Atlantic currents originally come from the more saline inflow from the North East Atlantic.

When reaching the sill region it's density is very close to that of NS. Thus due to probable mixing, AI and NS cannot be distinguished far south of the sill, and NS has been taken as the only reference at these stations. The second intermediate water shows not so clear a signal in the TS-diagram but seems to be present at all stations on the Greenland side north of the ridge in about 100 - 200 m depth. According to Gade et al. (1965) this water with low temperature and salinity ( $\leq -1.0^{\circ} \text{C}$ ,  $\sim 34.50 \text{ }^{\circ}/\text{oo}$ ) is formed further north. Because of it's polar constituents, Malmberg (1972) called it Polar Intermediate water



(PI,  $\leq -1^{\circ}$  C,  $34.50 \pm 0.1$  ‰). Far south of the ridge it is found on the Greenland side of the continental break in a thin and deep intermediate layer above NS, probably mixed with P.

### 3. Methods of analysis

Both, hydrocasts and CTD's have been used on the different ships for sampling. In a first step, all data have been validated by the responsible national institutes and after delivery to the IfM have been checked once more. Obvious errors as indicated by statical instability or single TS-points falling outside the 'normal' TS-relation have been removed. In some cases the salinities of whole profiles have been corrected with respect to a non mixed water mass at that station, mainly Norwegian Sea Deep Water (NS).

Next, fractions of water masses have been calculated analogue to a procedure described by Hermann (1967). Assuming linear mixing of three water masses with (conservative) TS-relations  $(T_i, S_i)$ ,  $i = 1, 2, 3$ , the fractions  $m_i$  of these water masses in a volume of unit 1 with relation  $(T, S)$  are derived from the set of equations

$$\begin{aligned} T &= \sum_i m_i T_i \\ (1) \quad S &= \sum_i m_i S_i \\ 1 &= \sum_i m_i. \end{aligned}$$

The  $m_i$  are all non-negative (and thus physically relevant) if and only if the point  $(T, S)$  falls within the mixing-triangle with corner points  $(T_i, S_i)$  in the TS-diagram.

Due to errors in the measurements, nonlinear effects in mixing processes or the existence of small fractions of a fourth water mass, TS-points often lie slightly outside the relevant mixing triangle. In such cases the TS-value has been projected onto the neighbouring side of the mixing triangle, thus assuming mixing only between those two water masses, connected by this line.

At many stations the form of the TS-curves below the surface layer shows clearly the existence of four water masses, that take part in the mixing. If, starting below the surface layer, at least one of the intermediate layers occur non-mixed, it is possible to calculate the fractions  $m_i$ ,  $i = 1, 2, 3, 4$  in two different mixing triangles where the relation of the non mixed layer connects both triangles and thus assures continuity. The procedure is similar for more than four water masses. The decision for the triangles to use has been made after inspection of the TS curves of each station separately.

For each ship the used mixing triangles are listed in tables. Overall TS-diagrams give some impression about the quality of the data. Both precede the sections of fractions of water masses contributing to the overflow, expressed in percentages of the unit volume. Their absolute errors are estimated to  $\pm 10\%$ . Positions, depths and times of measurements have been compared with or taken from the Overflow '73 Inventory (1976).

Acknowledgements: We would like to thank our colleagues of the ICES Working Group on Oceanic Hydrography for making available the basis data. K. Aagaard and S.-A. Malmberg gave helpful advices. H. Denker, A. Eisele, E. Petersen, E. Mempel and C. Tietze from the IfM drawing group prepared the figures, a job, which often tried their patience. Thanks for it.

This project was supported by the Deutsche Forschungsgemeinschaft, Bonn-Bad Godesberg.

4. References

- DIETRICH, G., 1956: Überströmung des Island Faröer-Rückens in Bodennähe nach Beobachtungen mit dem Forschungsschiff "Anton Dohrn" 1955/56. - Dtsch. Hydr. Z., 9, 2, 78-89.
- DIETRICH, G., 1957: Schichtung und Zirkulation der Irminger-See im Juni 1955. - Ber. Dtsch. Wiss. Komm. Meeresforsch. XIV, 4, 255-312.
- GADE, G., S.-A. MALMBERG, U. STEFANSSON, 1965: Report on the Joint Icelandic-Norwegian Expedition to the Area between Iceland and Greenland 1963. - NATO Subcomm. Oceanogr. Res. Techn. Rep. No. 22.
- HELLAND-HANSEN, B., F. NANSEN, 1909: The Norwegian Sea. - Rep. Norw. Fish. Mar. Invest. 2, 1, No. 2.
- HERMANN, F., 1967: The TS-Diagram Analysis of the water masses over the Iceland-Faroe Ridge and in the Faroe-Bank Channel. - Rapp. P. - v. Récm. Cons. perm. int. Explor. Mer 157, 139 - 149.
- KNUDSEN, M., 1899: Danish Ingolf-Expedition. - Hydrography 1, 2, Kopenhagen.
- MALMBERG, S.-A., 1972: Intermediate Polar Water in the Denmark Strait - "Overflow" August 1971 - ICES C.M. 1972/C:2, mimeo.
- MEINCKE, J., 1972: The Hydrographic Section along the Iceland-Faroe Ridge carried out by R.V. "Anton Dohrn" in 1959 - 1971. - Ber. dt. wiss. Komm. Meeresforsch. 22, 372 - 384.
- MEINCKE, J., 1978: On the Distribution of Low Salinity Intermediate Waters around the Faroes. - Dtsch. Hydr. Z. 31, 50 - 64.
- Overflow '73 Inventory, 1976: ICES Oceanographic Data Lists Inventories No. 29
- STEFANSSON, U., 1962: North Icelandic Waters. - Rit Fiskideilar, 3.

5. TablesTable 1 List of origin of data

Ship	Institute/Organisation
Explorer	DAFS, Marine Laboratory, Aberdeen
Helland-Hansen	Geophysical Institute, Bergen
J.C. Svabo	Institute for Physical Oceanography, Copenhagen
Challenger	SMBA, Oban, ICES
Cirolana	Fish. Lab. Lowestoft
Shackleton	IOS-Wormley
B. Davydov	ICES
Meteor	Institut für Meereskunde, Kiel
Bj. Saemundsson	Marine Research Institute, Reykjavik, ICES
W. Herwig	Deutsches Hydrographisches Institut, Hamburg
Hudson	Bedford Institute of Oceanography, Dartmouth
Prof. Viese	ICES

Table 2: Water mass characteristics

Area	Name	Symbol	TS-characteristics
Greenland-Scotland	Norwegian Sea Deep water	NS	$\leq -0.5^{\circ} \text{C}$ , $\sim 34.92^{\circ}/\text{oo}$
	Irminger Sea water	IS	$\sim 4^{\circ} \text{C}$ , $\sim 34.97^{\circ}/\text{oo}$
Iceland-Scotland	North Atlantic water	NA	$\geq 9.0^{\circ} \text{C}$ , $\geq 35.32^{\circ}/\text{oo}$
	Modified North Atlantic water	MNA	$\geq 8.5^{\circ} \text{C}$ , $\sim 35.24^{\circ}/\text{oo}$
	East Icelandic Current water	EIC	$6.0^{\circ} \text{C} - 6.5^{\circ} \text{C}$ , $34.45^{\circ}/\text{oo}$ $- 34.65^{\circ}/\text{oo}$
	North Icelandic Winter/Arctic Intermediate water	NI/AI	$2.5^{\circ} - 3.0^{\circ} \text{C}$ , $34.88^{\circ}/\text{oo}$
South east Iceland	East Icelandic Winter water	EIW	$-0.5^{\circ} \text{C} - 1^{\circ} \text{C}$ , $\sim 34.72^{\circ}/\text{oo}$
Greenland-Iceland	North Atlantic water	NA	$\geq 7^{\circ} \text{C}$ , $\geq 35.10^{\circ}/\text{oo}$
	Labrador Sea water	LS	$\sim 3.8^{\circ} \text{C}$ , $\sim 34.88^{\circ}/\text{oo}$
	Polar water	P	$\leq -1.0^{\circ} \text{C}$ , $\leq 34.00^{\circ}/\text{oo}$
	Polar Intermediate water	PI	$\leq -1.0^{\circ} \text{C}$ , $\sim 34.50^{\circ}/\text{oo}$
	Arctic Intermediate water	AI	$\sim 1^{\circ} \text{C}$ , $\sim 35.00^{\circ}/\text{oo}$
General	Surface waters of various types	SW	relative high T      relative low S

Table 3: Mixing triangles used for calculation of fractions of water masses (characteristics see table 2).

Triangle No	Water masses	Area
1	NA, IS, NS	Iceland-Scotland
2	MNA, IS, NS	" "
3	NA, NI/AI, NS	" "
4	MNA, NI/AI, NS	" "
5	MNA, EIC, NI/AI	South East Iceland
6	EIC, EIW, NS	" " "
7	EIC, EIW, NI/AI	" " "
8	NI/AI, EIW, NS	" " "
9	NA, LS, IS	Greenland-Iceland
10	IS, PI, NS	" "
11	P, NA, PI	" "
12	NA, PI, AI	" "
13	PI, AI, NS	" "
14	NA, PI, NS	" "
15	P, NA, NS	" "

Table 4: List of water masses and mixing triangles analysed

Ship	Observed water masses (table 2)	Mixing triangles (table 3)
Explorer	NA, MNA, NI/AI, NS	3, 4
Helland-Hansen	NA, MNA, NI/AI, NS	3, 4
J.C. Svabo	NA, MNA, NI/AI, NS	3, 4
Challenger	NA, IS, NI/AI, NS	1, 3
Cirolana	NA, NI/AI, NS	3
Shackleton	MNA, IS, NI/AI, NS	2, 4
Boris Davydov	MNA, EIC, IS, NI/AI, EIW, NS	2, 4, 5, 7, 8
Meteor	NA, MNA, EIC, IS, NI/AI, EIW, NS	1, 2, 4, 5, 8
Bj.Saemundsson	MNA, EIC, IS, NI/AI, EIW, NS	2, 4, 5, 6, 7, 8
Walter Herwig	MNA, EIC, NI/AI, EIW, NS	4, 5, 7, 8
Hudson	NA, P, LS, IS, AI, PI, NS	9, 10, 11, 12, 13, 14, 15
Professor Viese	NA, P, LS, IS, AI, PI, NS	9, 11, 12, 13, 14, 15

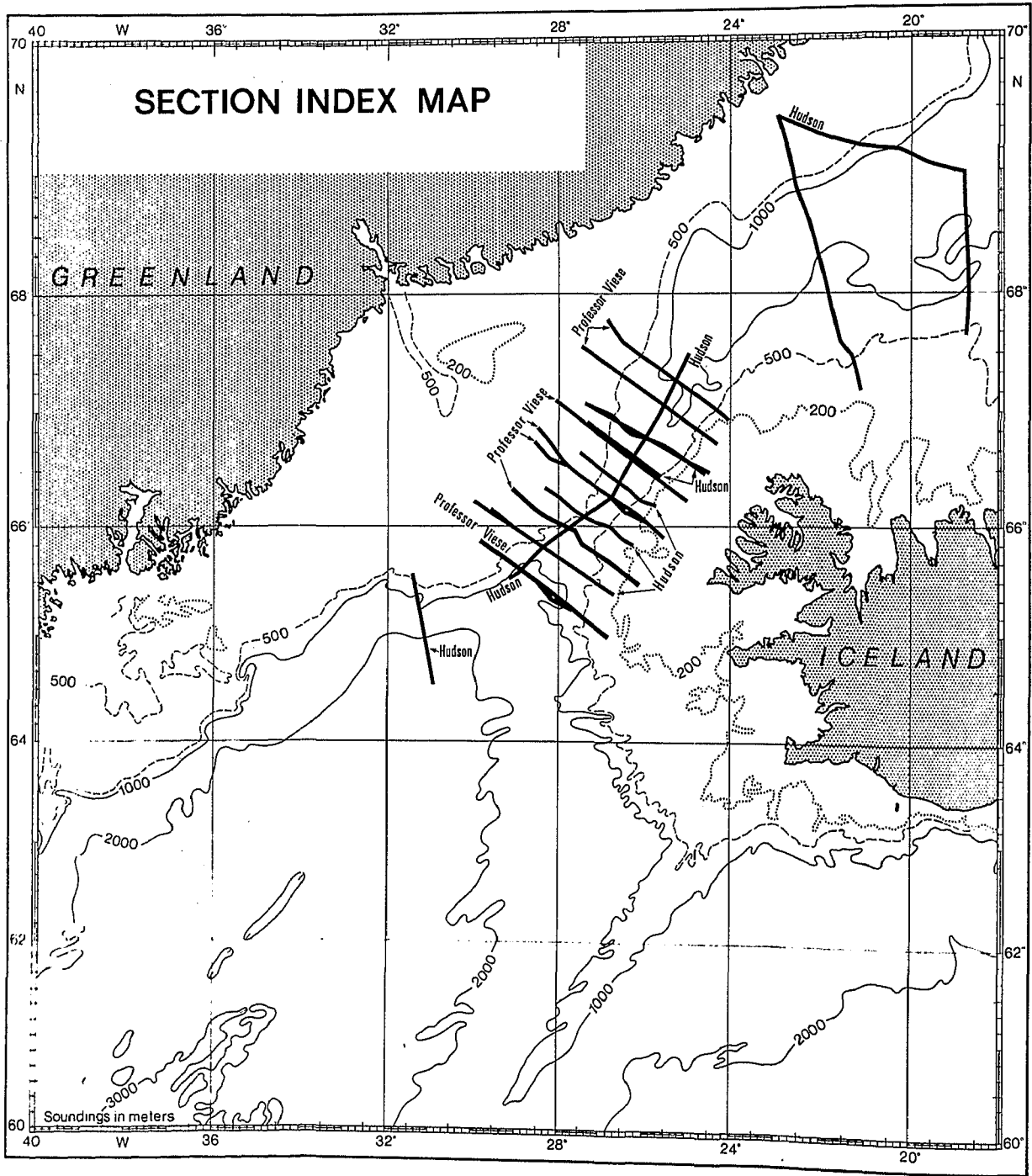



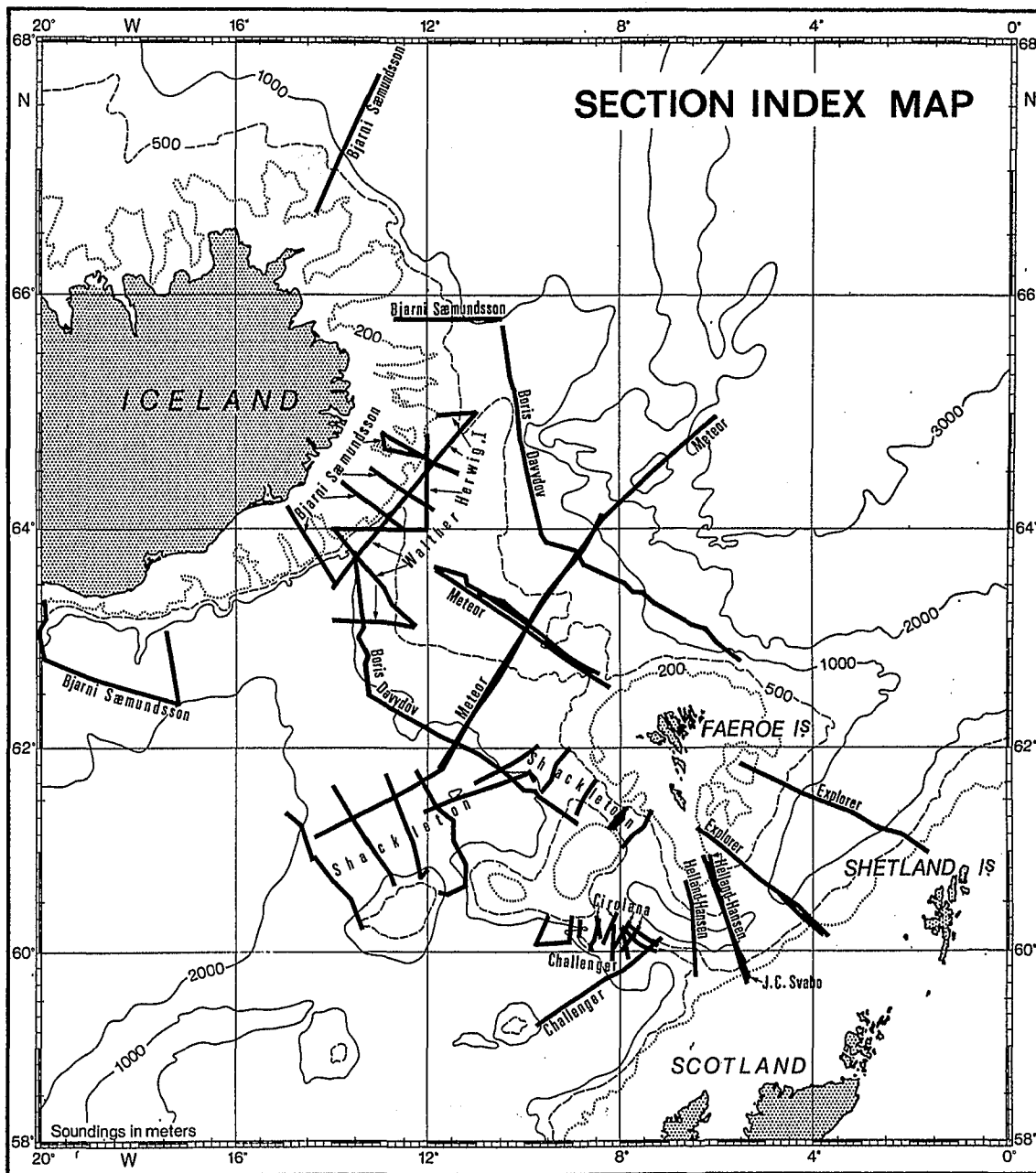

## 6. Water mass analysis

In this chapter the results of the water mass analysis are presented in form of sections. For each ship these sections are preceded by special remarks, a station map and overall TS-diagrams.

6.1 Explorer

The working area was the Faroe-Shetland region. The TS-diagrams clearly show two water masses of the North Atlantic type below surface waters with lower salinities. Overflow waters occur in amounts of NI/AI and NS.

Section	Stat.No.	Mixing triangles (see table 3)
201 - 210	201 - 205	4
	206 - 210	3
211 - 220	211 - 215	3
	216 - 220	4
221 - 227	221 - 224	4
	225 - 227	3
228 - 237	228 - 231	3
	232 - 237	4
238 - 248	238 - 240	3
	241 - 248	4
249 - 258	249 - 254	4
	255 - 258	3
261 - 271	261 - 267	4
	268 - 271	3
272 - 282	272 - 275	3
	276 - 282	4
283 - 293	283 - 287	4
	288 - 293	3

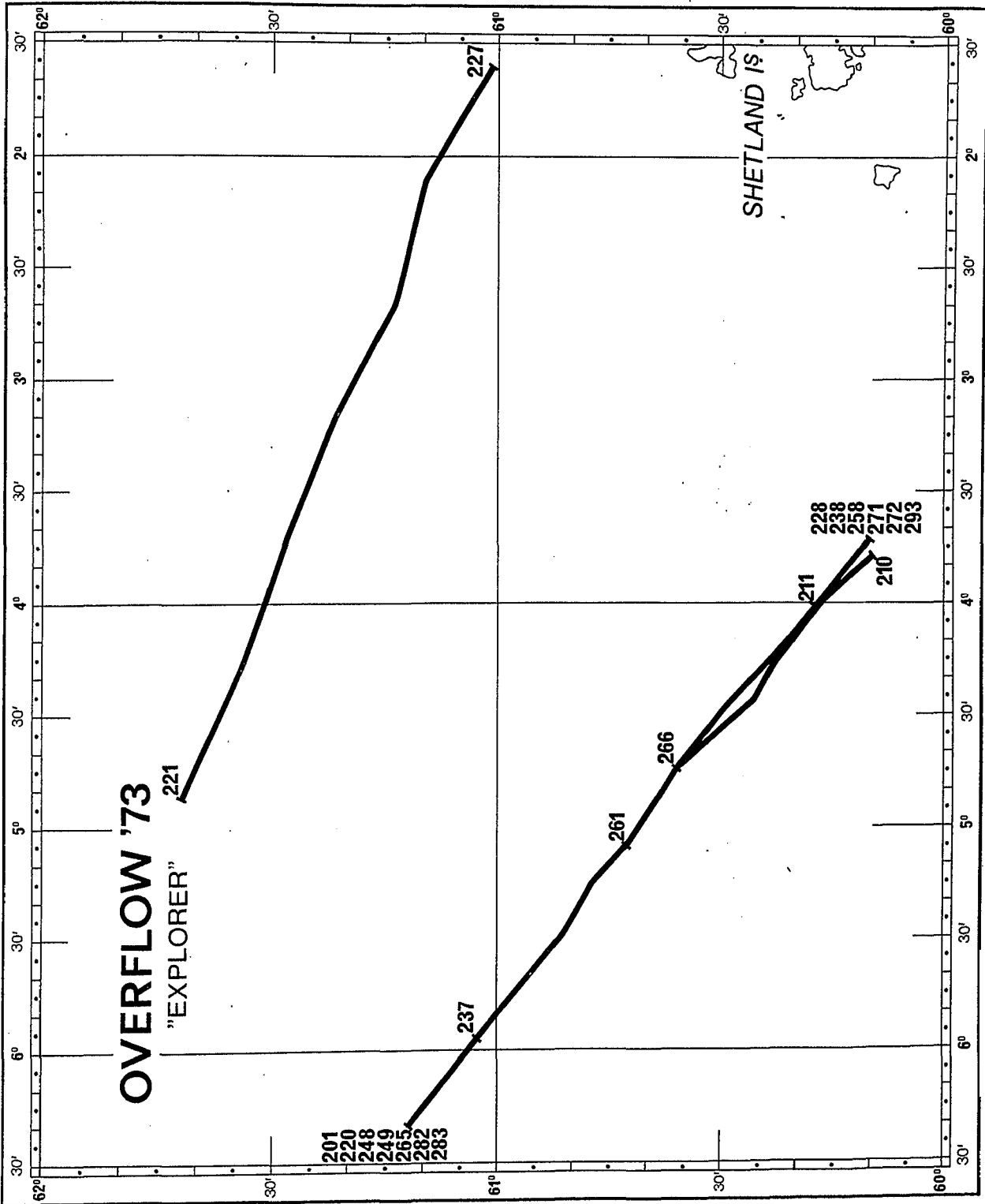

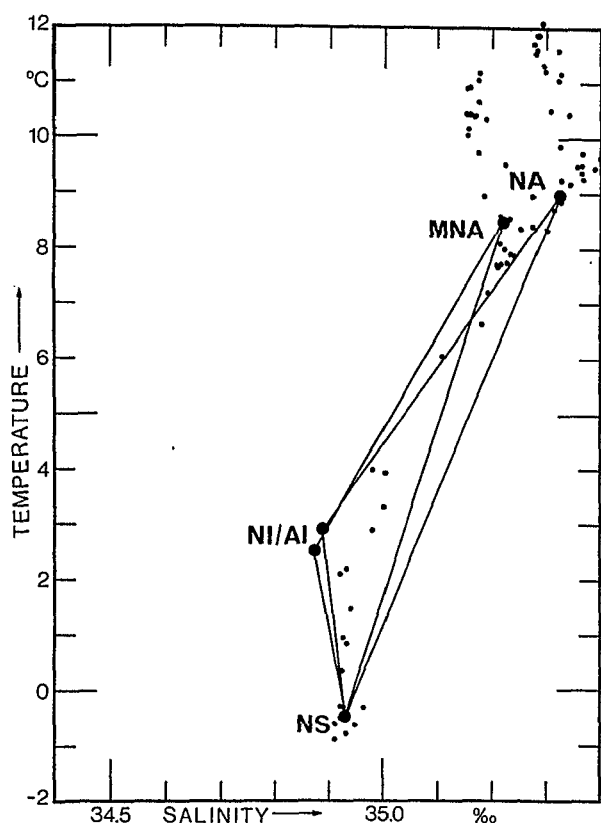

"EXPLORER" 20.-21. AUG. 1973  
STAT. NO. 201-210

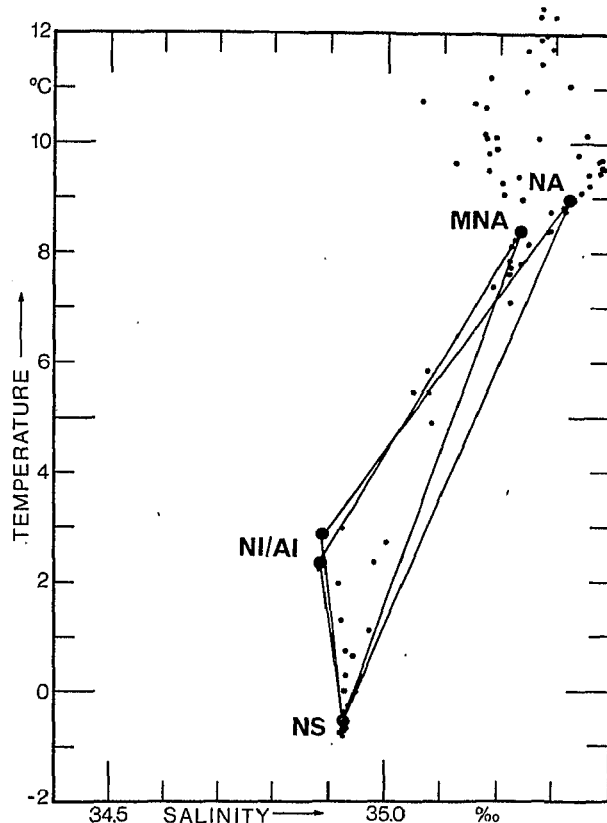

"EXPLORER" 23.-24. AUG. 1973  
STAT. NO. 211-217, 219, 220

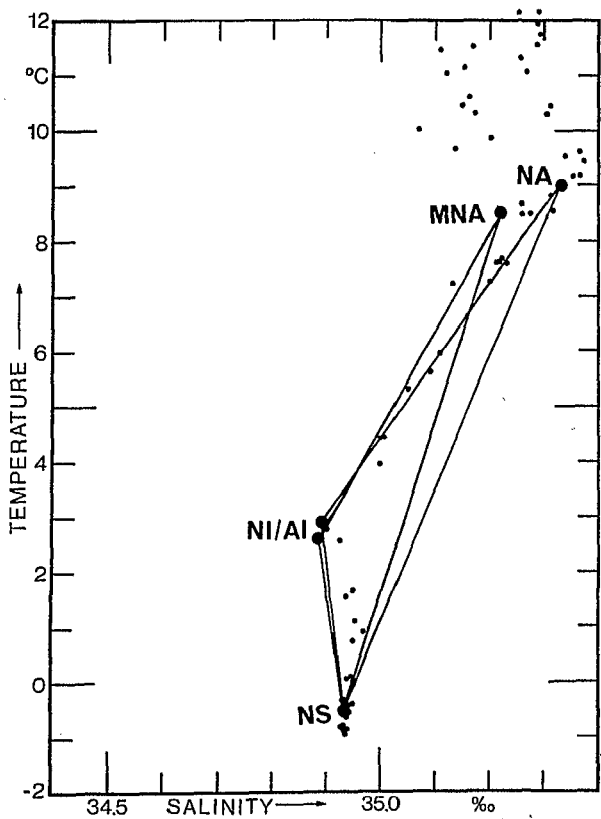

"EXPLORER" 26. AUG. 1973  
STAT. NO. 221-227

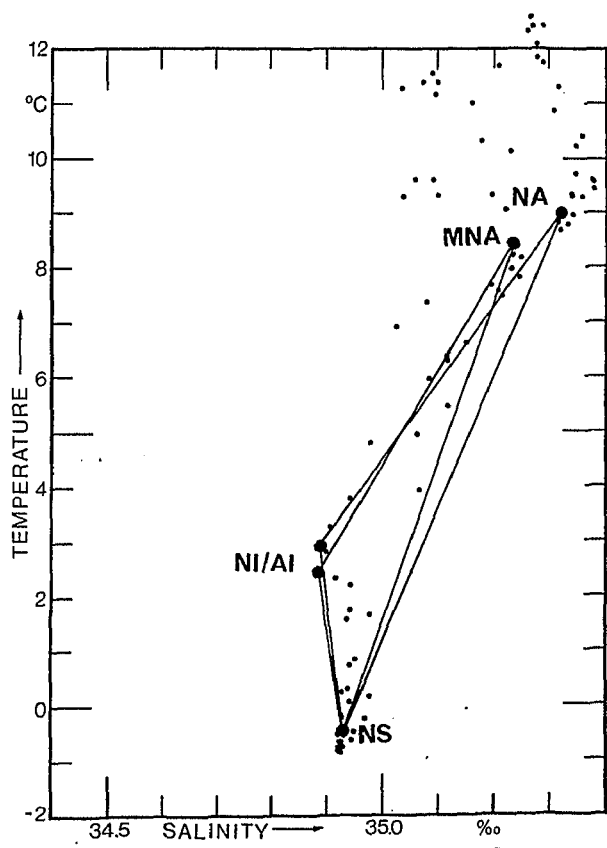

"EXPLORER" 27.-28. AUG. 1973  
STAT. NO. 228-237

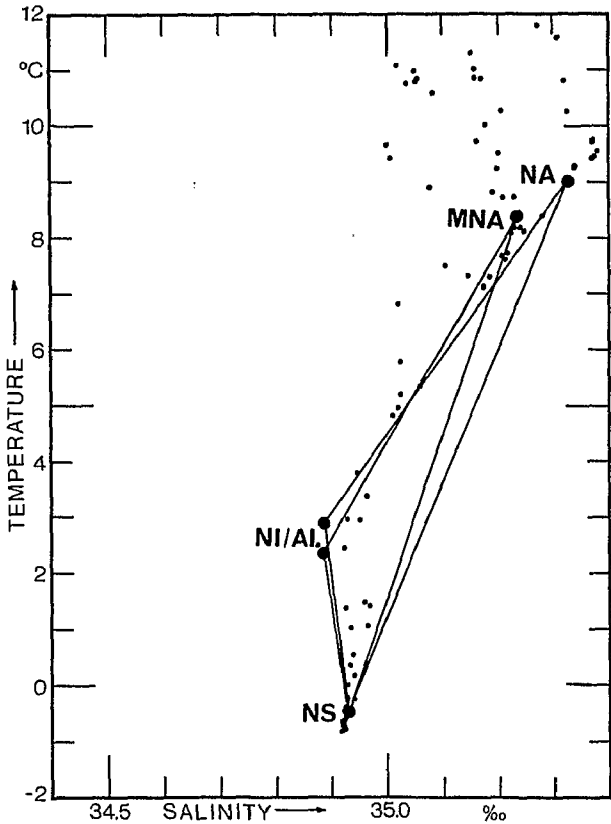

"EXPLORER" 29.-30.AUG.1973  
STAT.NO.238-248

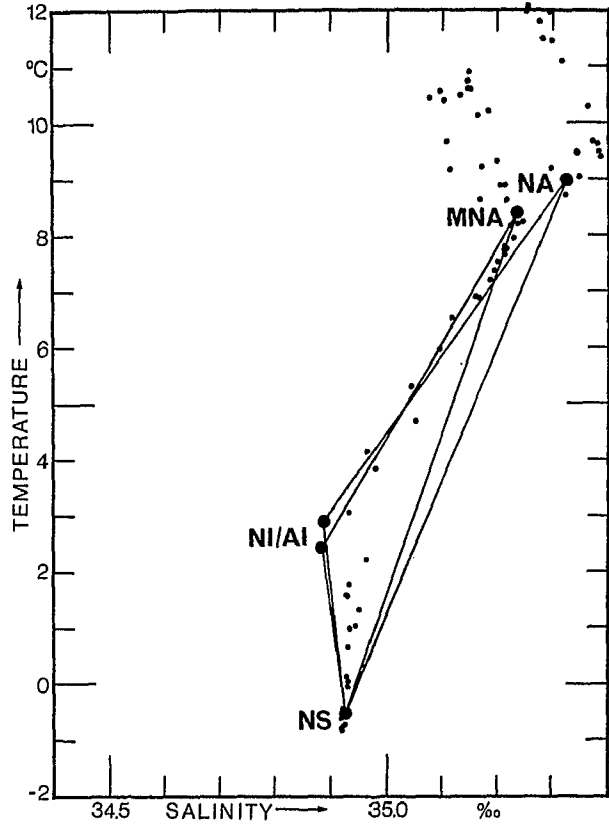

"EXPLORER" 2.-3.SEP.1973  
STAT.NO.249-258

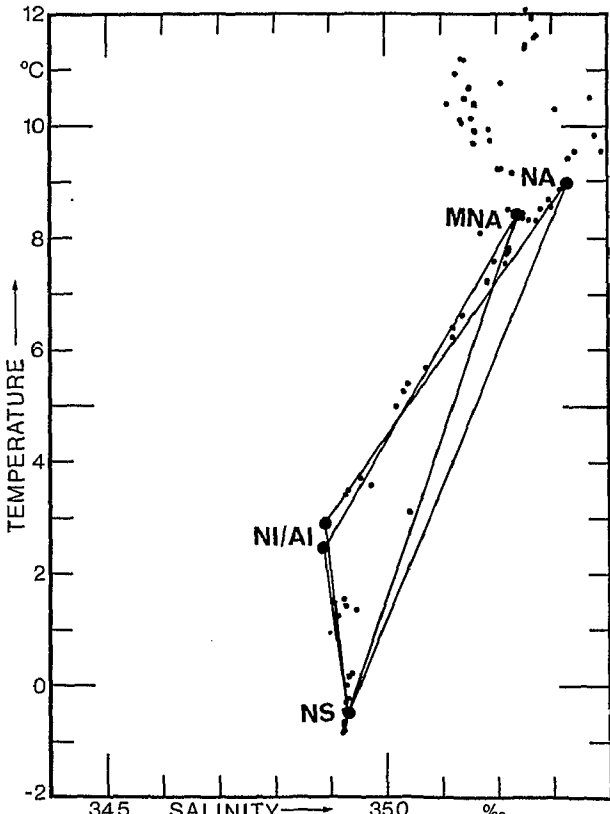

"EXPLORER" 6.-7.SEP.1973  
STAT.NO.261-271

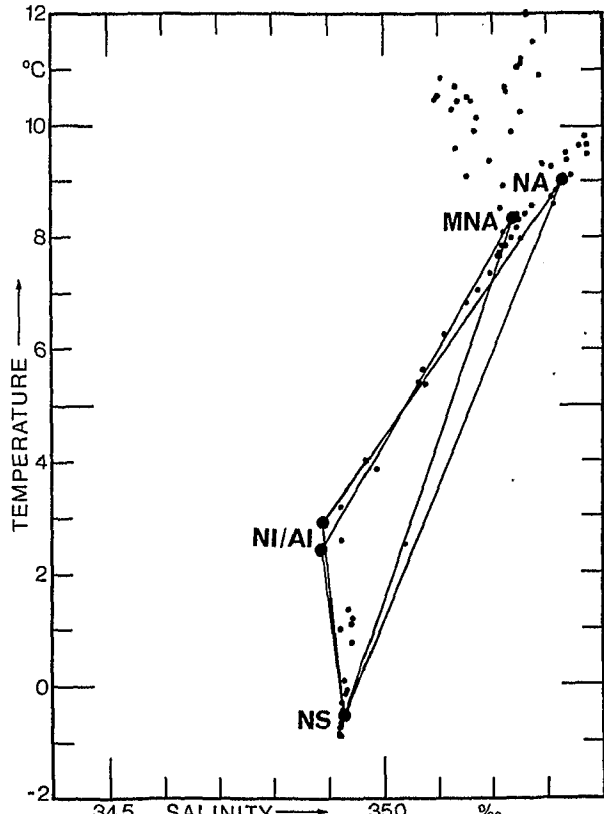

"EXPLORER" 9.-10.SEP.1973  
STAT.NO.272-282

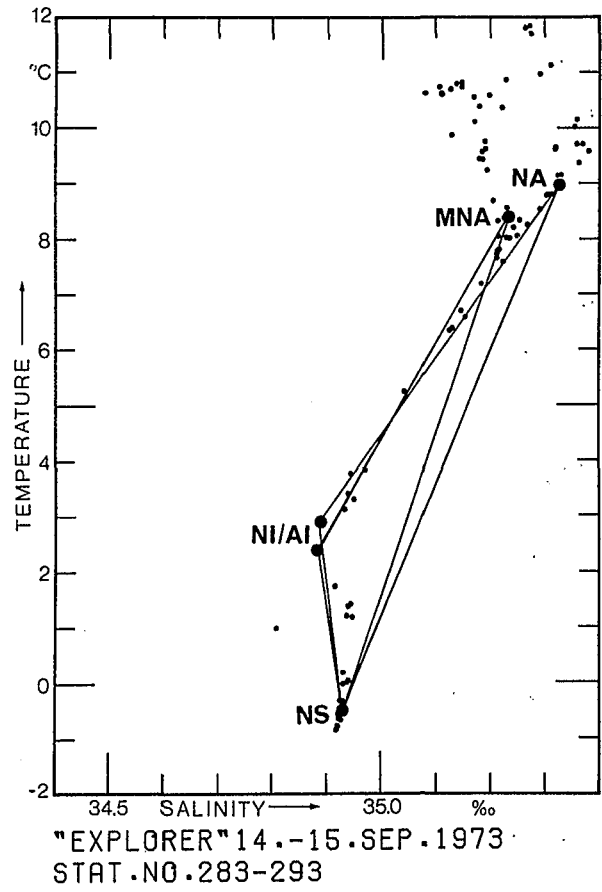

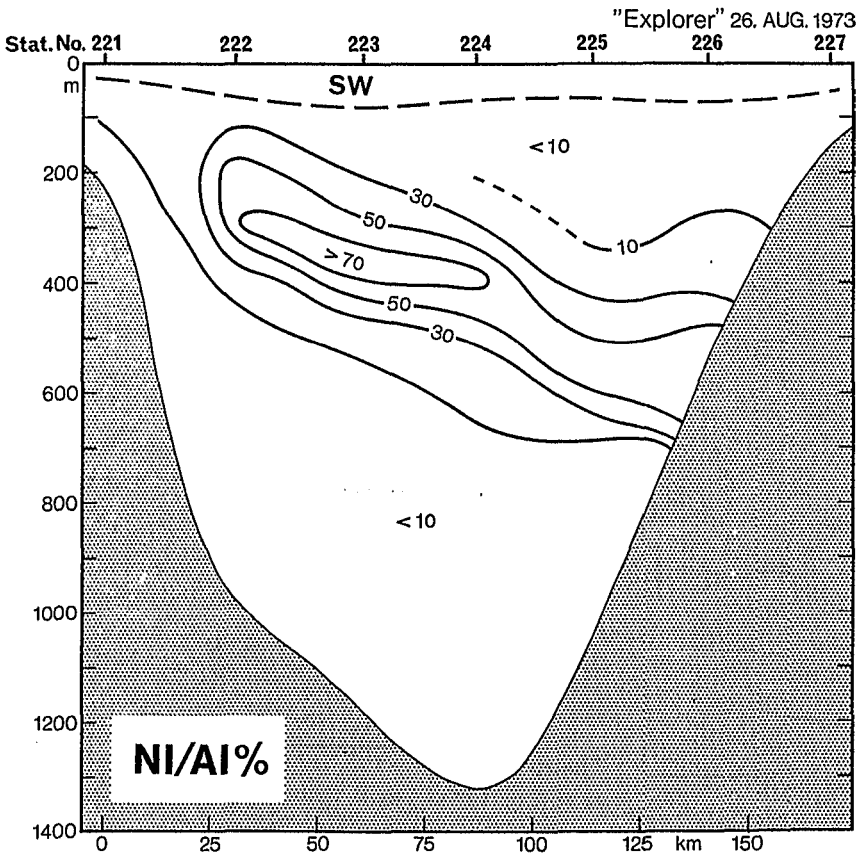
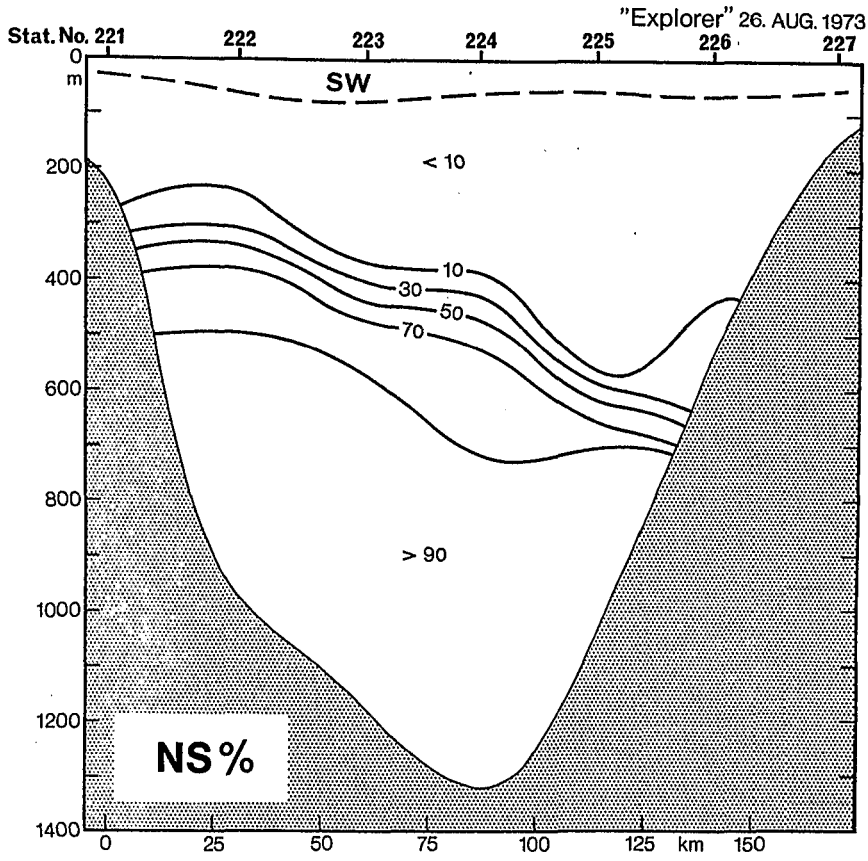



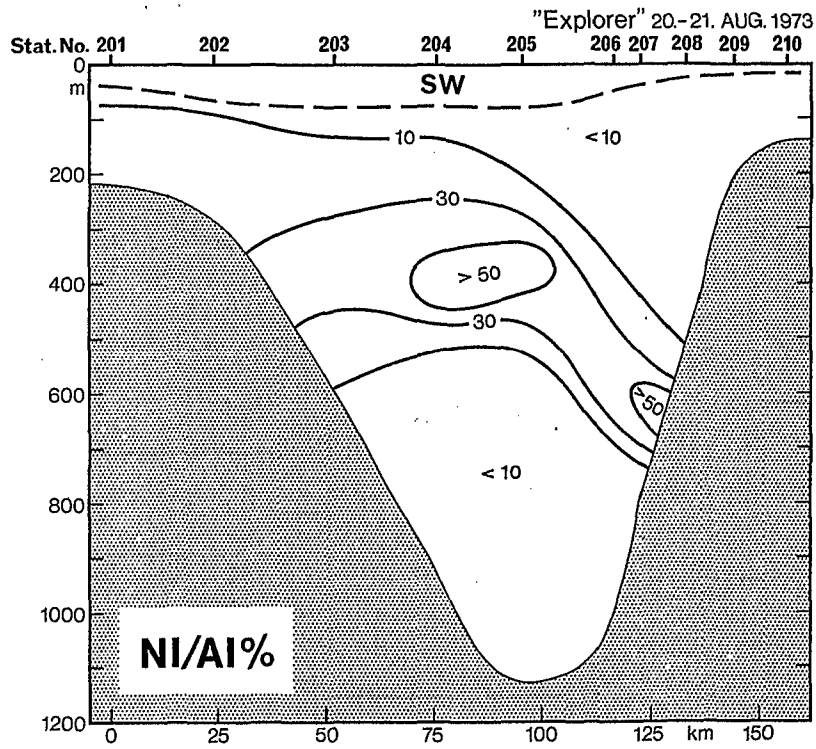
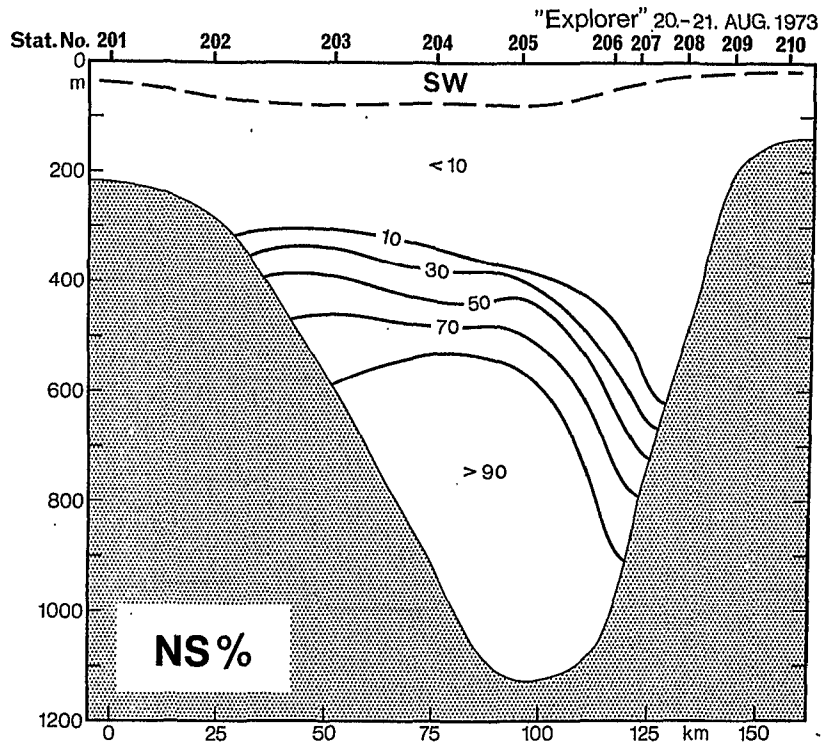

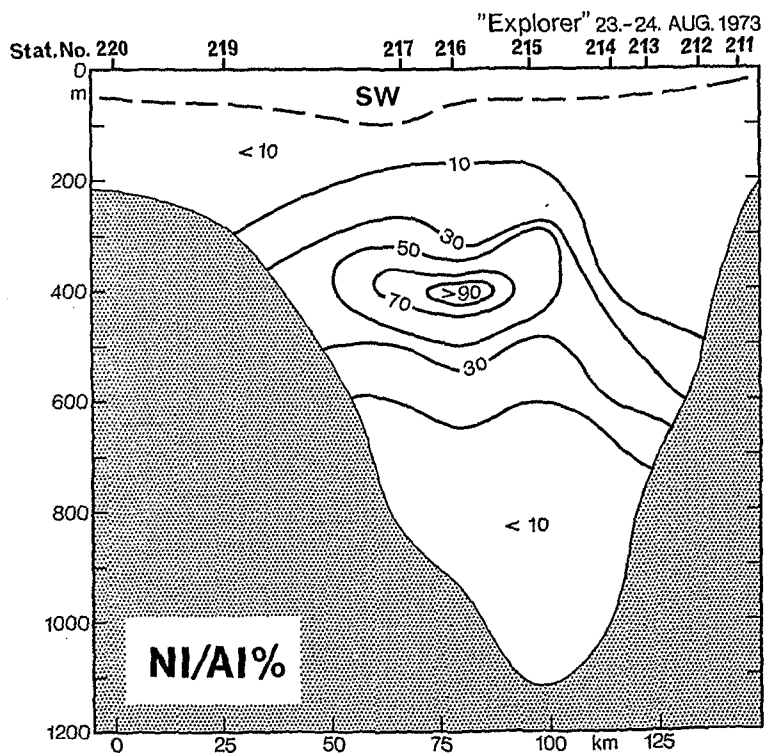
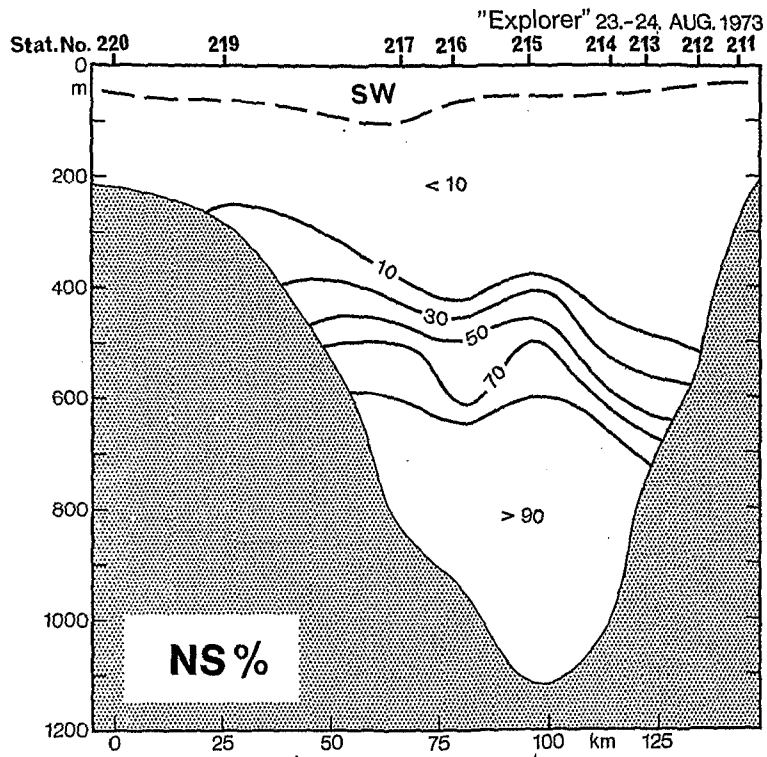

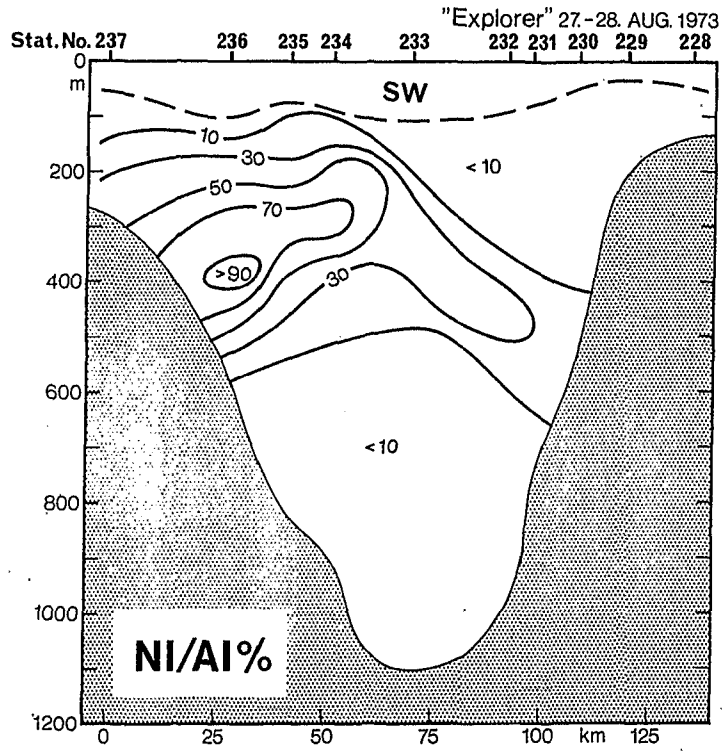
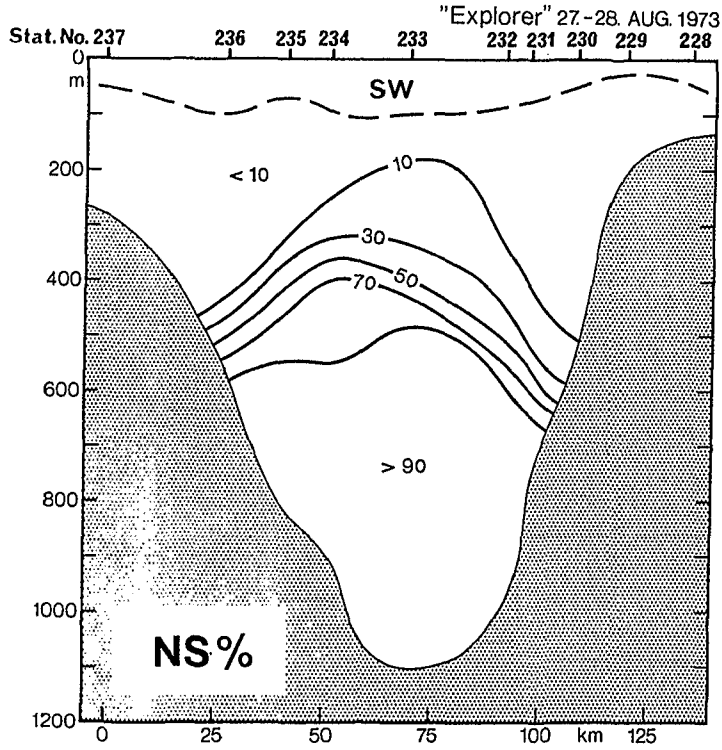

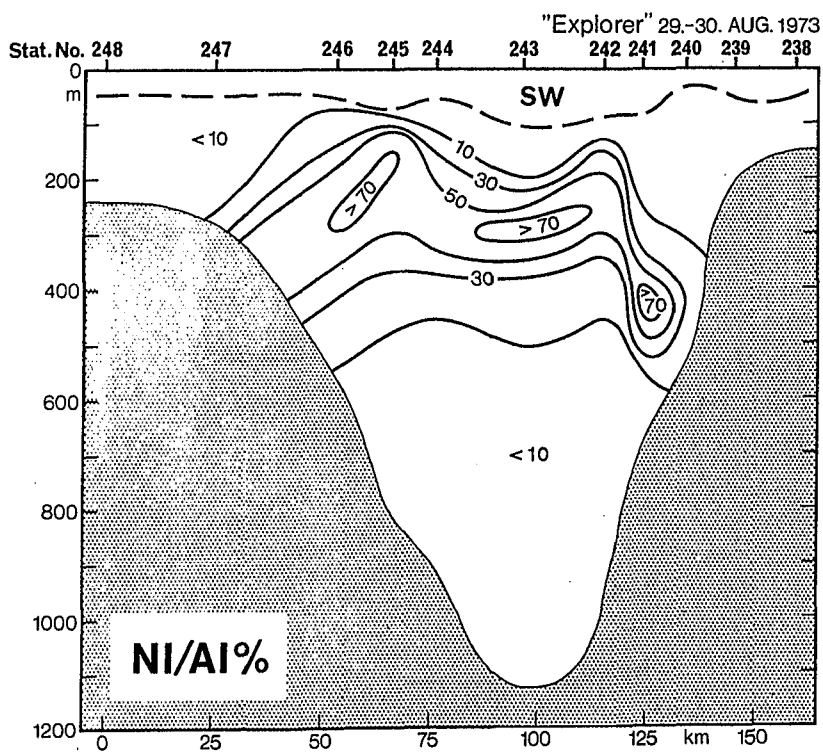
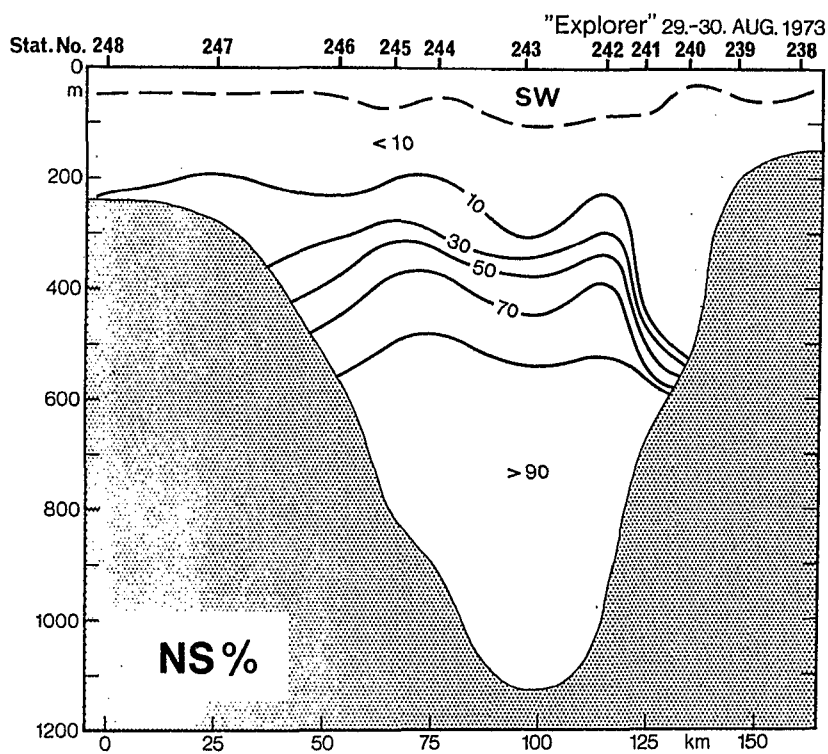

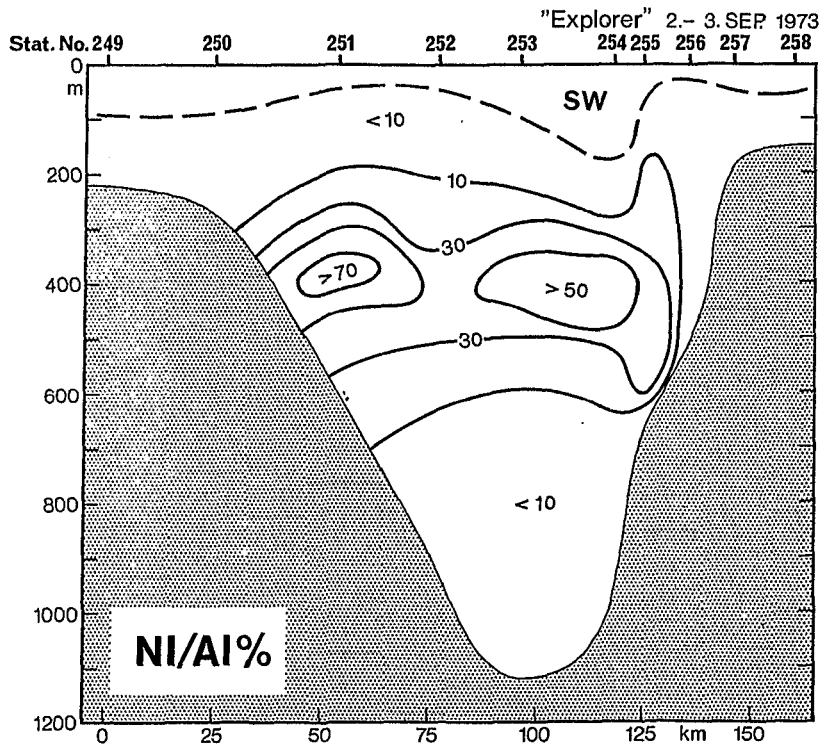
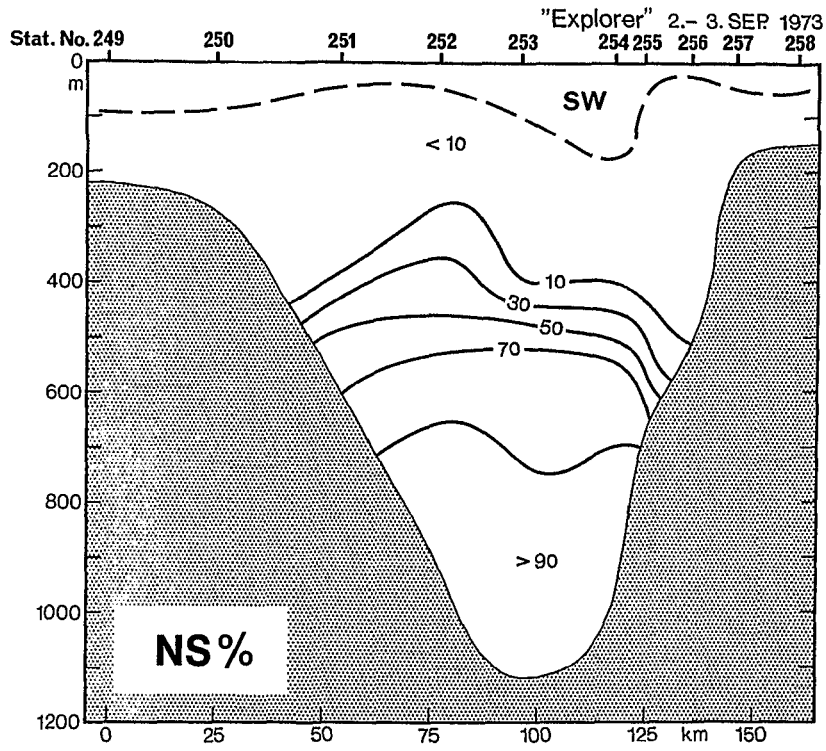

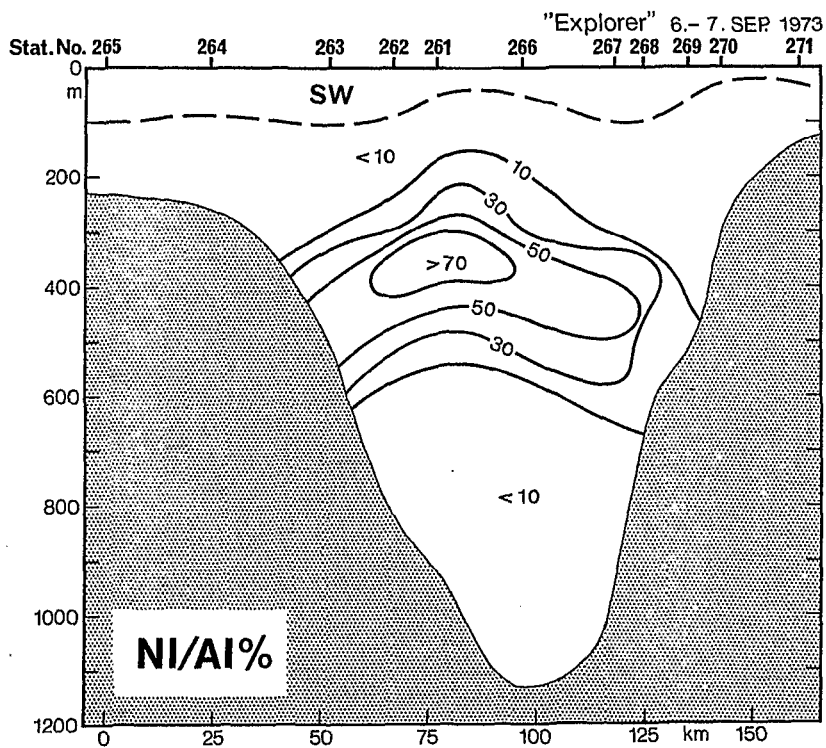
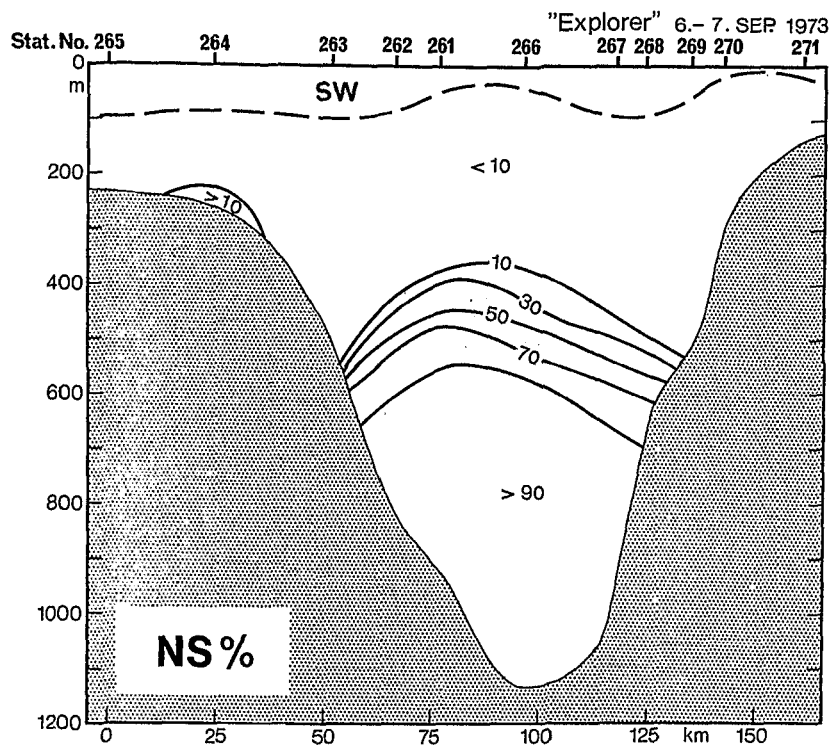

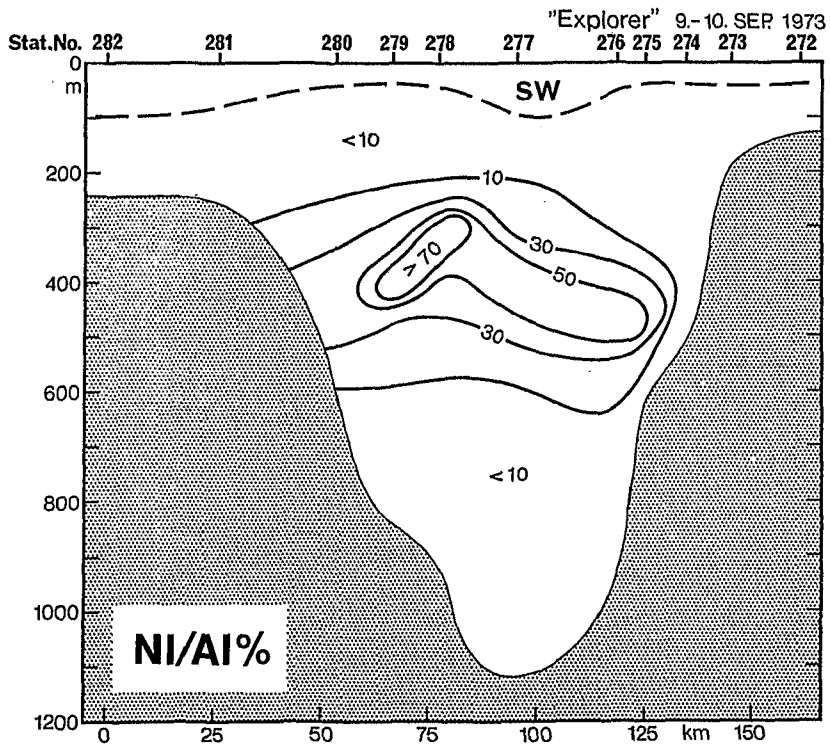
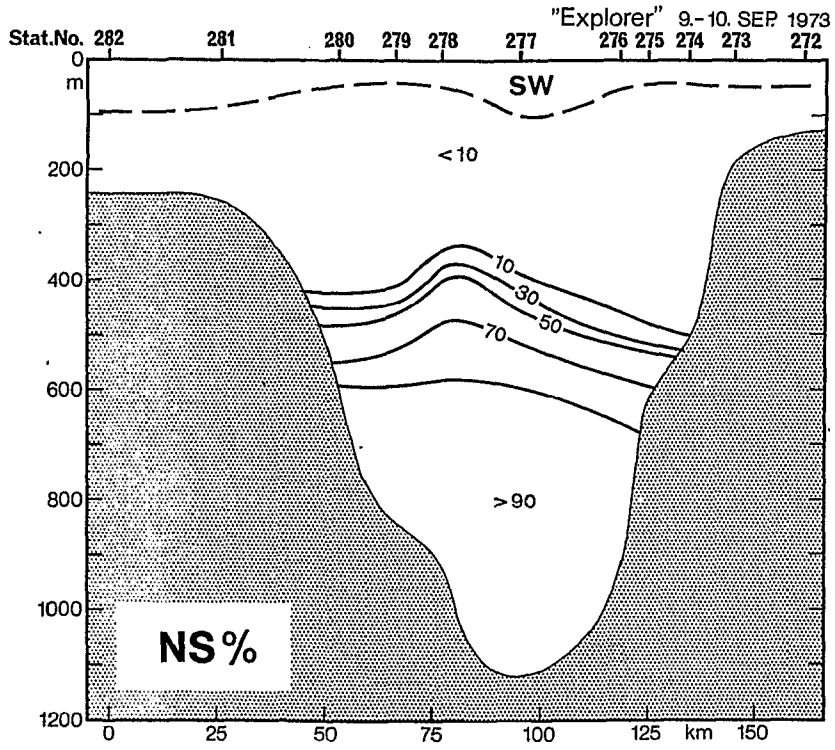

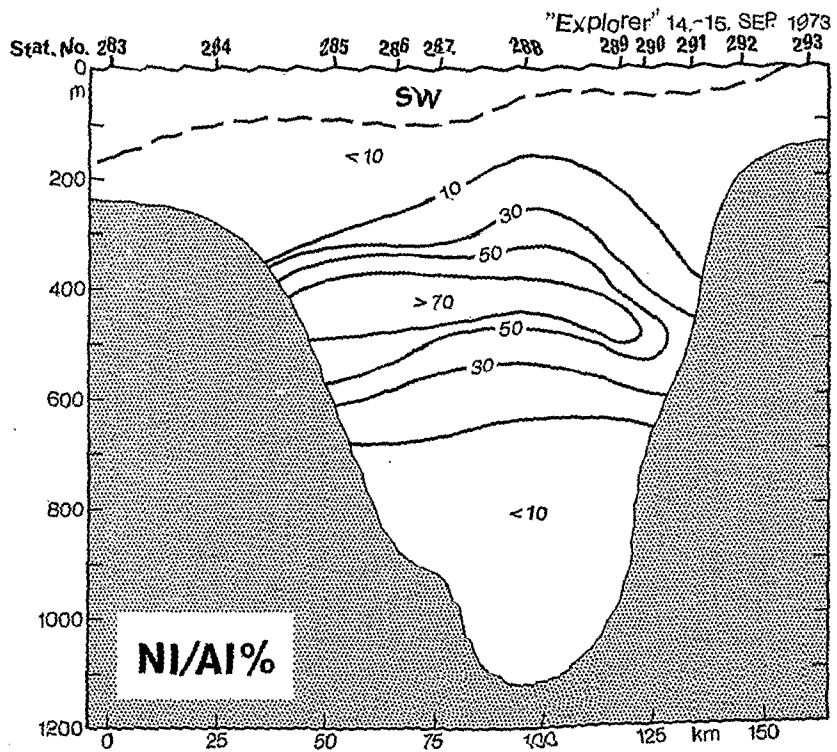
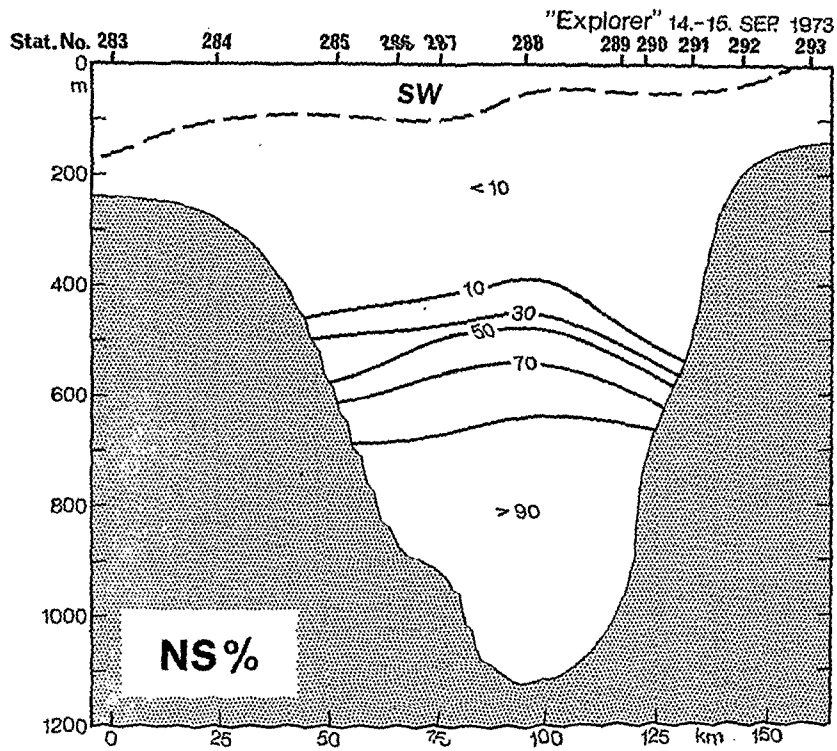



6.2 Helland-Hansen

The working area was the Faroe-Shetland channel, slightly south of EXPLORER. As for EXPLORER two waters of Atlantic type and NI/AI and NS were observed.

<u>Section</u>	<u>Stat.No.</u>	<u>Mixing triangle (see table 3)</u>
66 - 74	66 - 68	4
	69 - 74	3
83 - 86	83, 84	3
	85, 86	4
87 - 95	87	4
	88 - 95	3
101 - 109	101 - 106	3
	107 - 109	4
110 - 121	110 - 113	4
	114 - 121	3
122 - 132	122 - 131	3
	132	4
133 - 144	133 - 138	4
	139 - 144	3
144 - 155	145 - 152	3
	153 - 155	4
157 - 168	157	4
	158 - 161	3
	162 - 168	4
169 - 180	169, 170	4
	171	3
	172	4
	173 - 180	3
183 - 191	183 - 188	3
	189 - 191	4
192 - 199		3

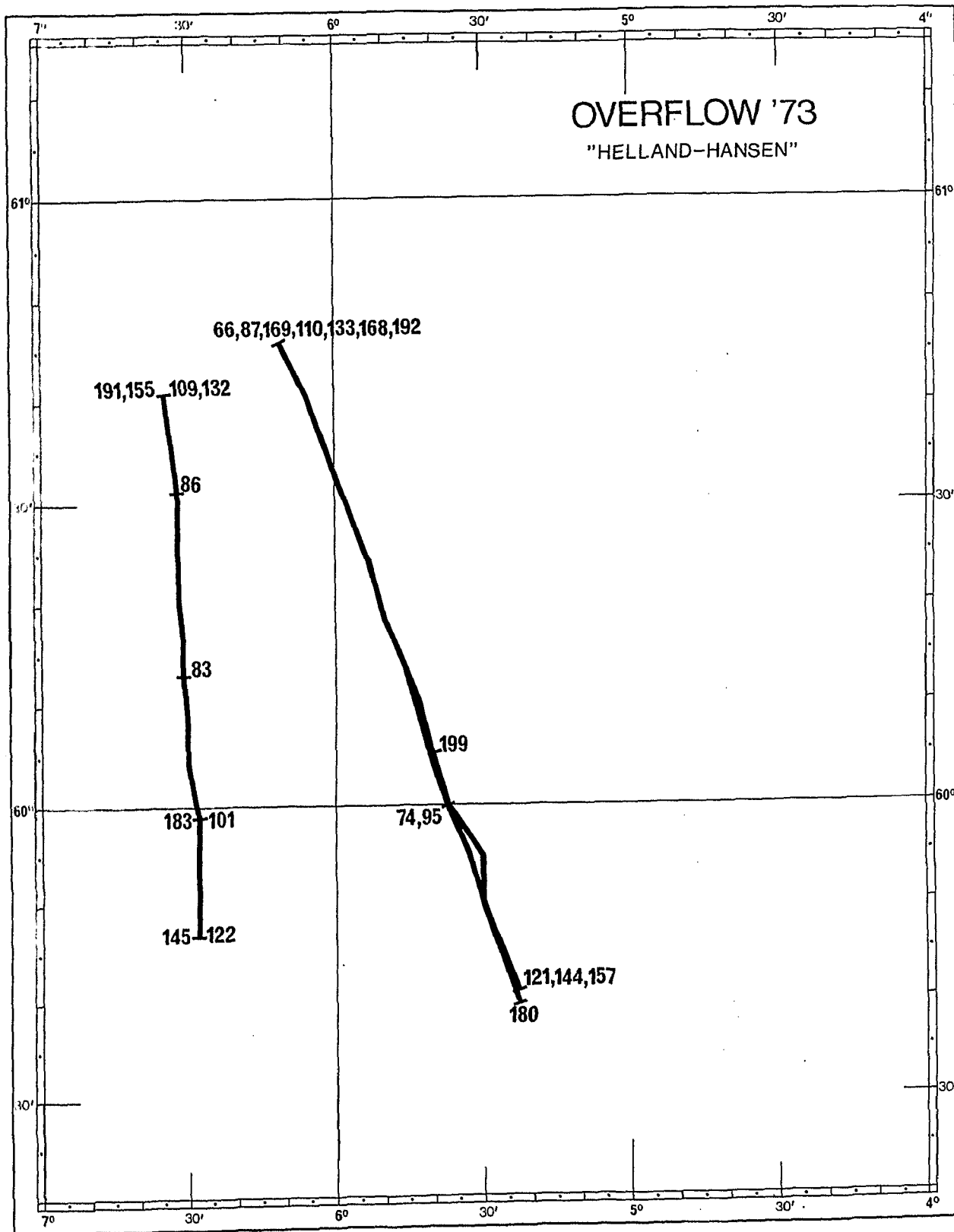

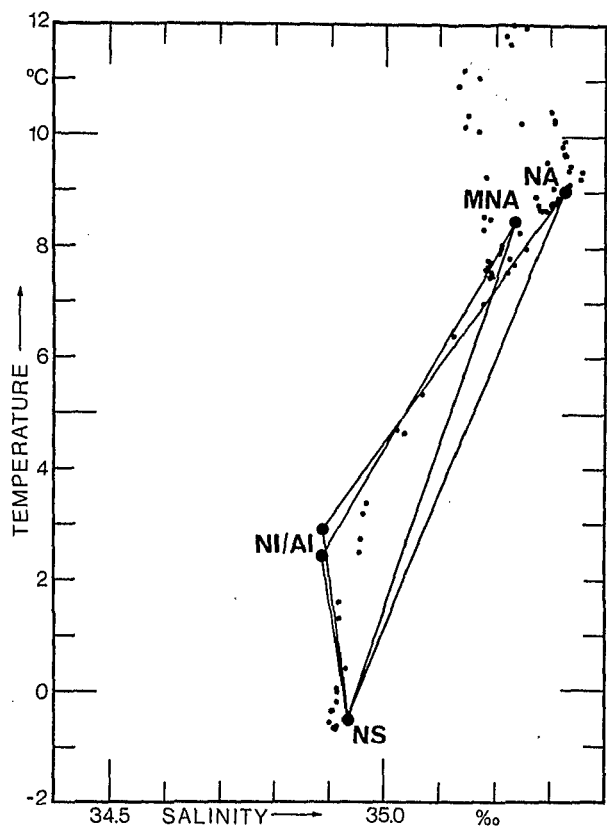

"HELLAND-HANSEN"  
15.-16.AUG.1973  
STAT.NO.66-74

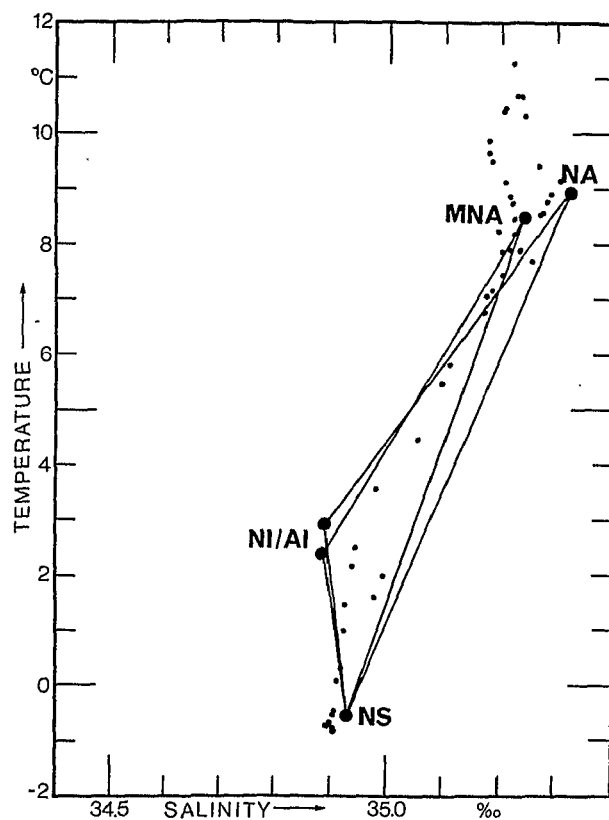

"HELLAND-HANSEN"  
16.-17.AUG.1973  
STAT.NO.83-86

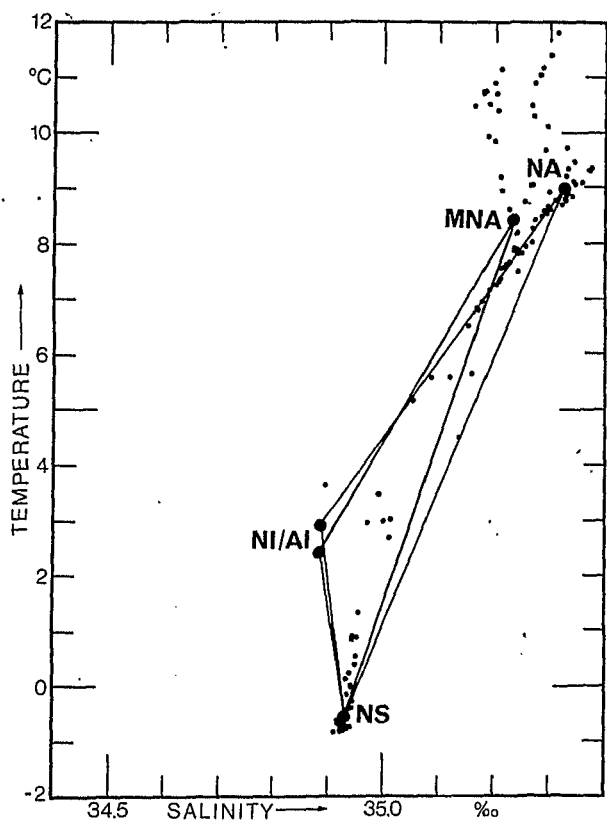

"HELLAND-HANSEN"  
20.-21.AUG.1973  
STAT.NO.87-95

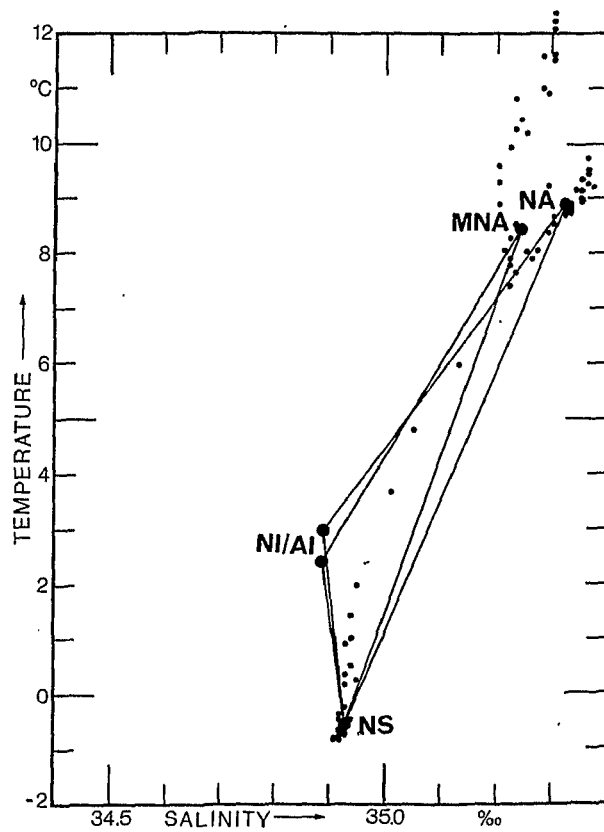

"HELLAND-HANSEN"  
21.-22.AUG.1973  
STAT.NO.101-109

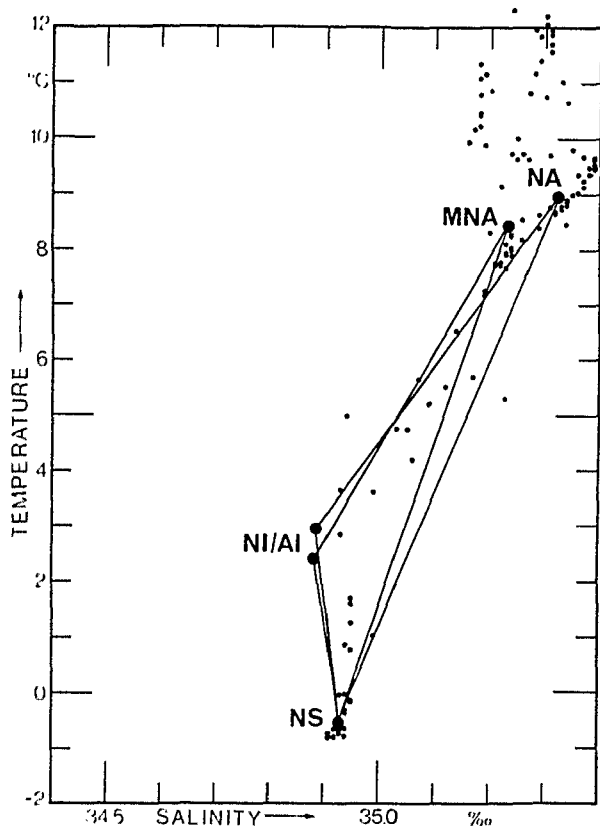

"HELLAND-HANSEN"  
22.-23.AUG.1973  
STAT.NO.110-121

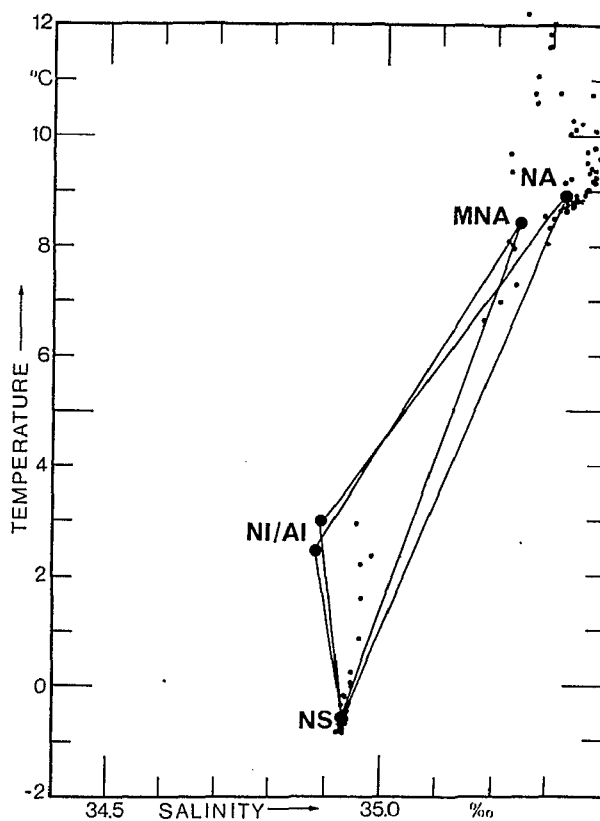

"HELLAND-HANSEN"  
23.-24.AUG.1973  
STAT.NO.122-132

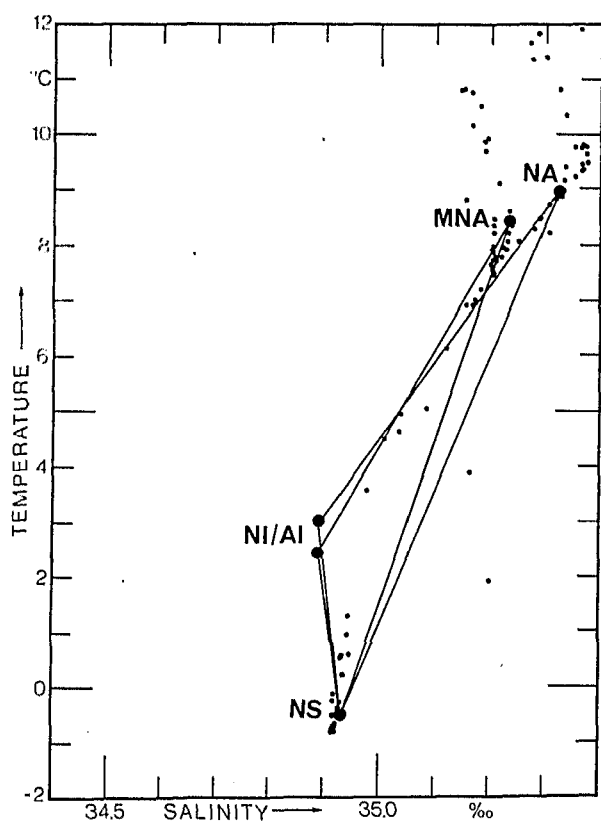

"HELLAND-HANSEN"  
24.-25.AUG.1973  
STAT.NO.133-144

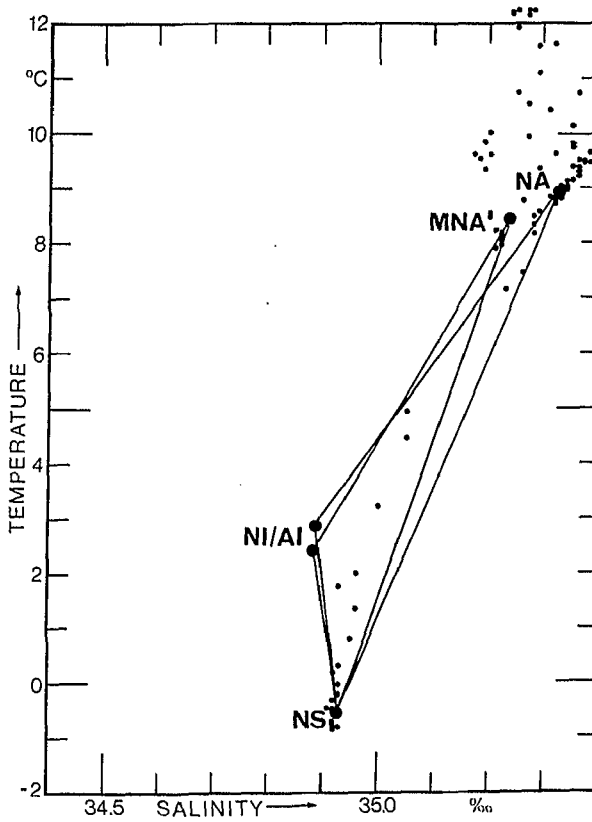

"HELLAND-HANSEN"  
25.-26.AUG.1973  
STAT.NO.145-155

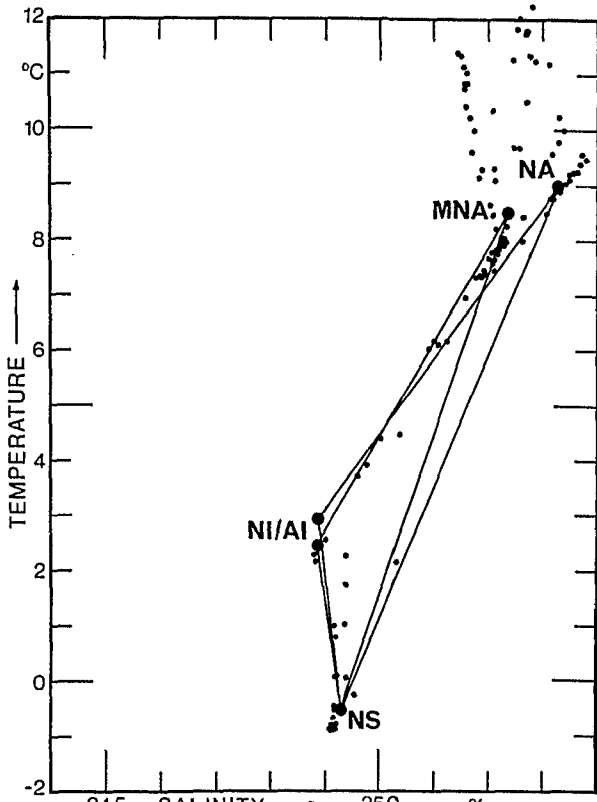

"HELLAND-HANSEN"  
27.AUG.1973  
STAT.NO.157-168

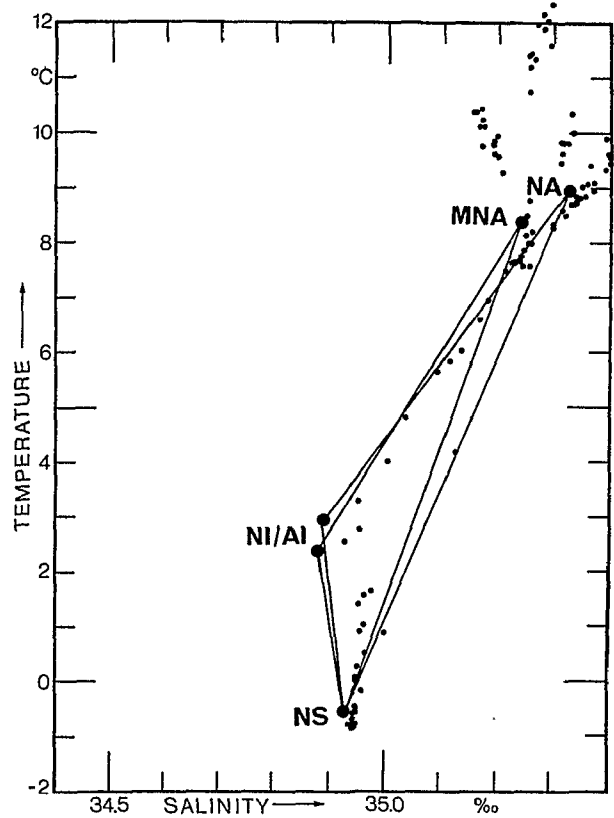

"HELLAND-HANSEN"  
3.-4.SEP.1973  
STAT.NO.169-180

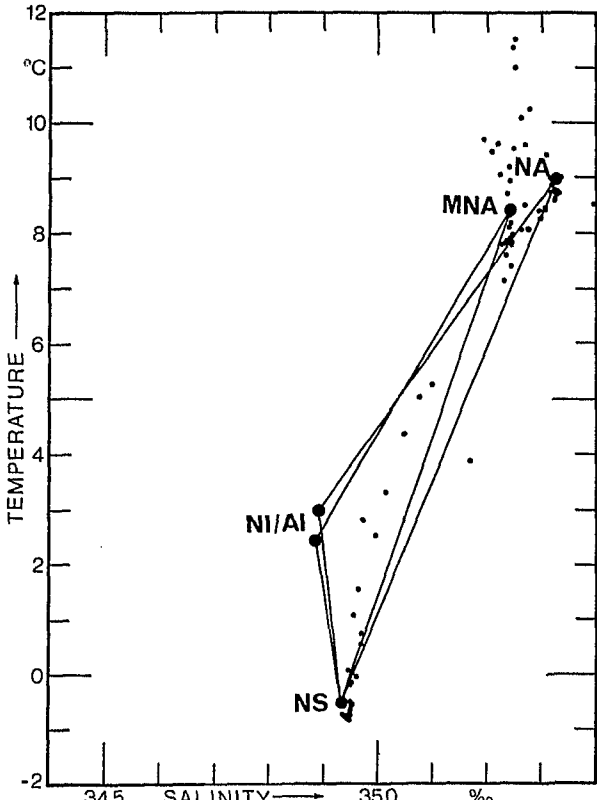

"HELLAND-HANSEN"  
4.-5.SEP.1973  
STAT.NO.183-191

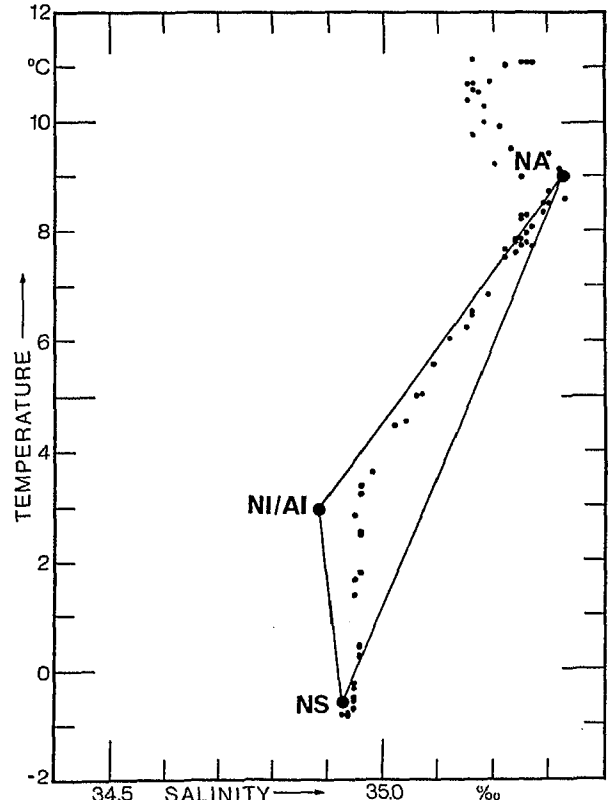

"HELLAND-HANSEN"  
5.SEP.1973  
STAT.NO.192-199

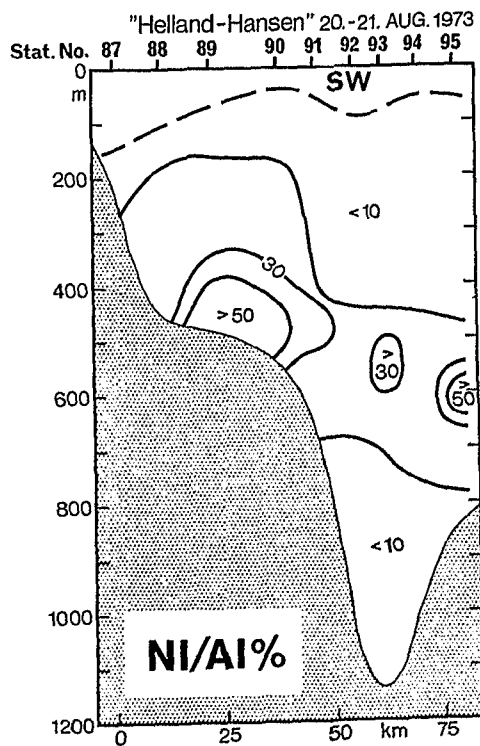
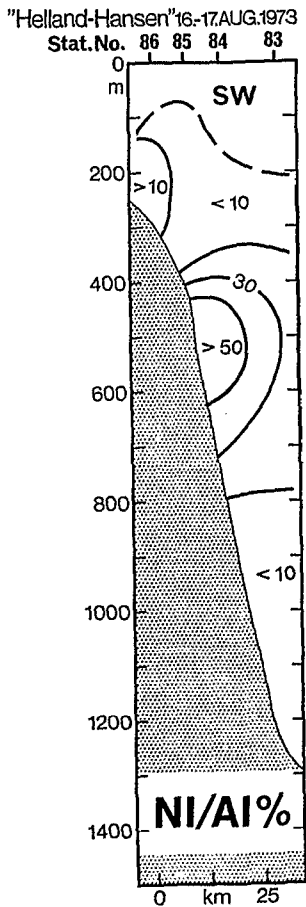
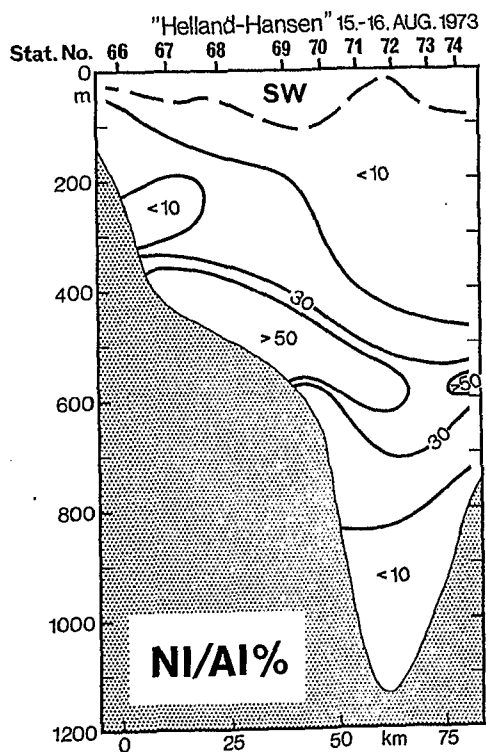
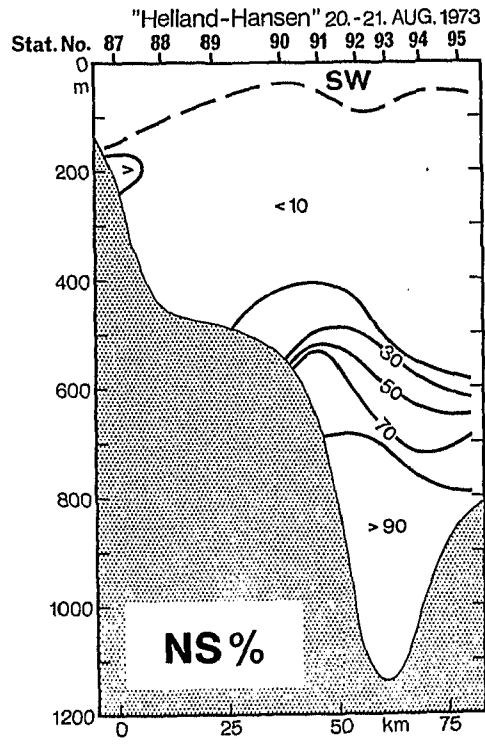
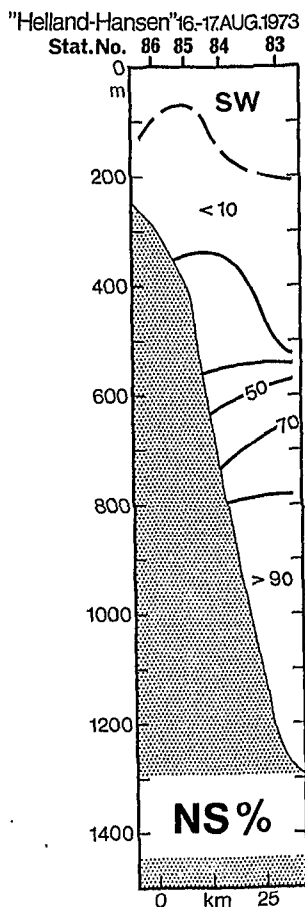
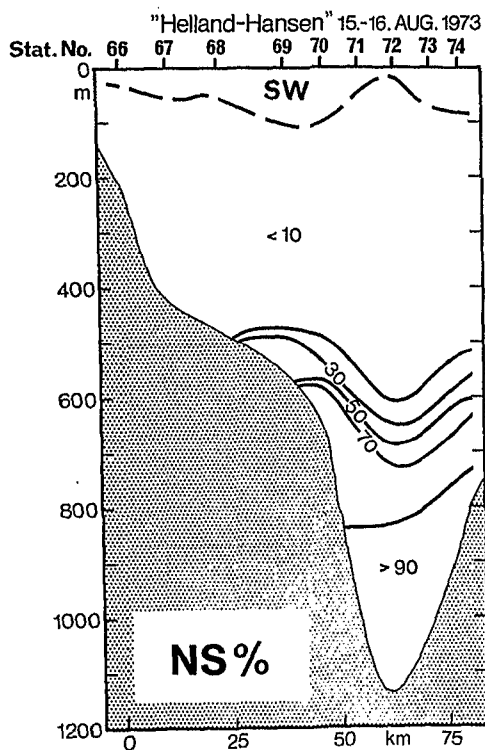

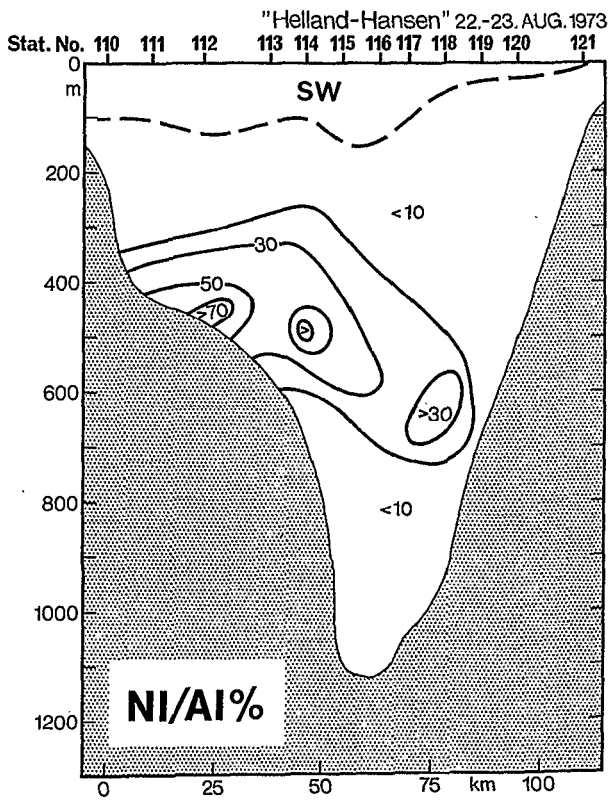
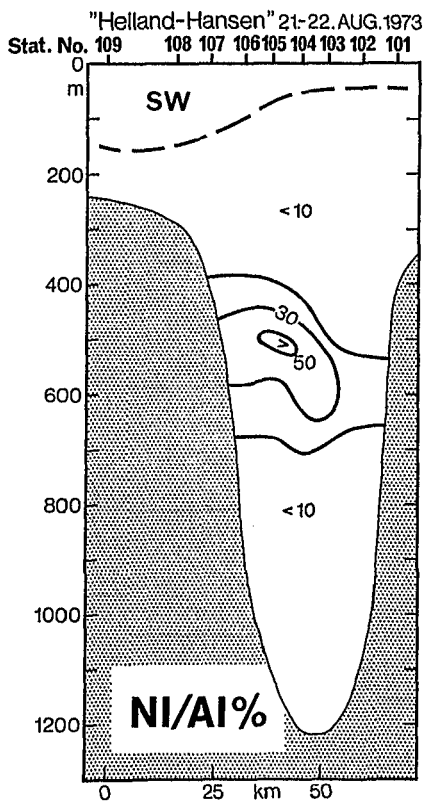
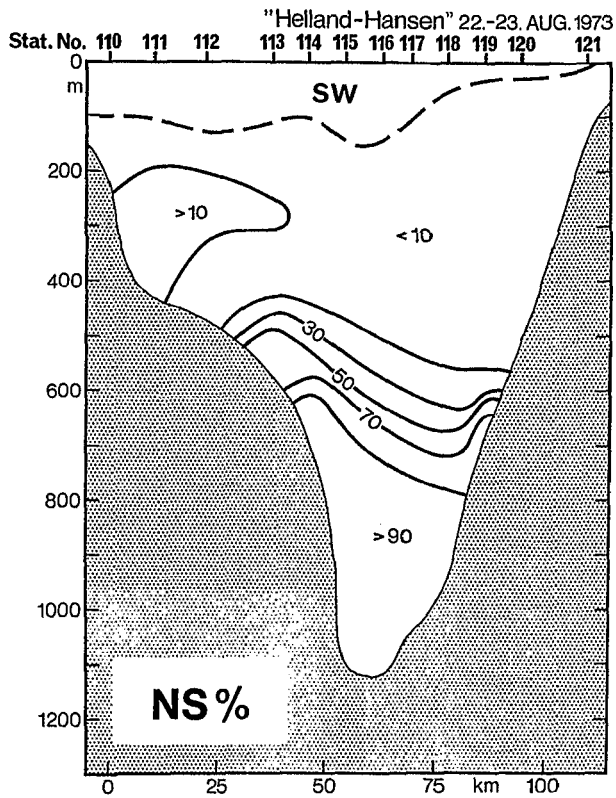
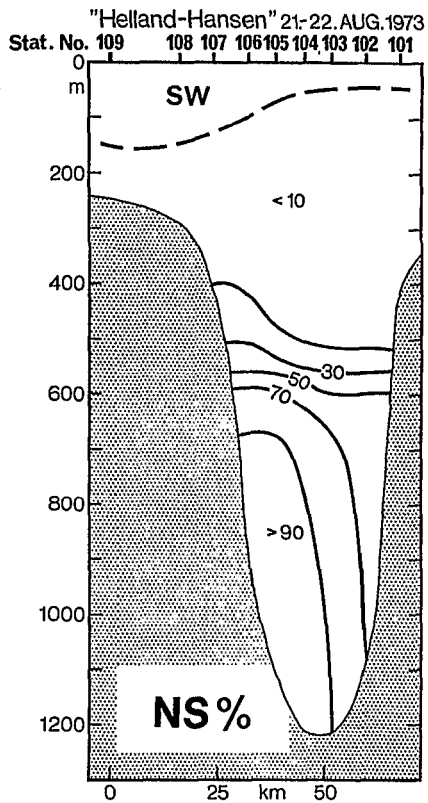

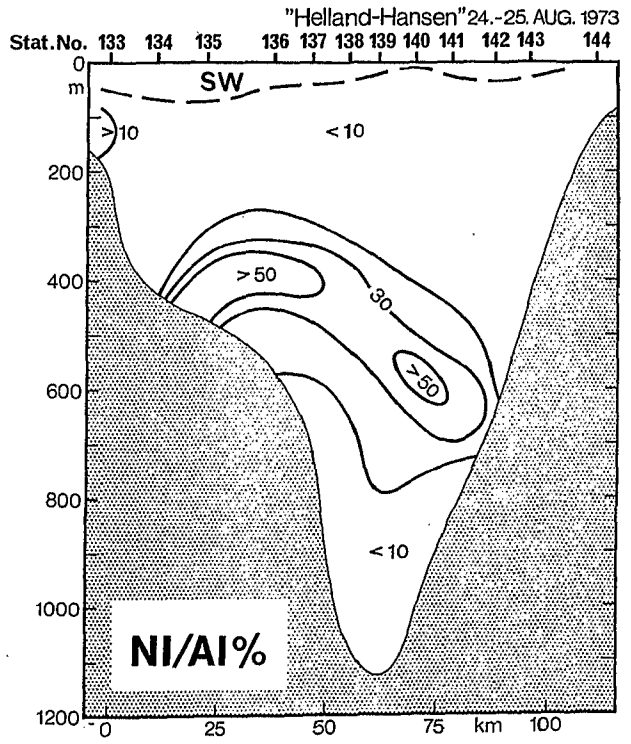
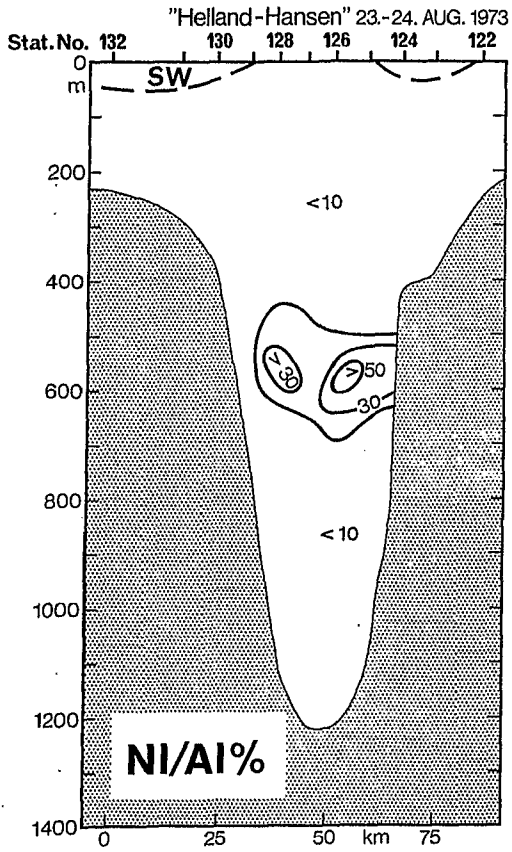
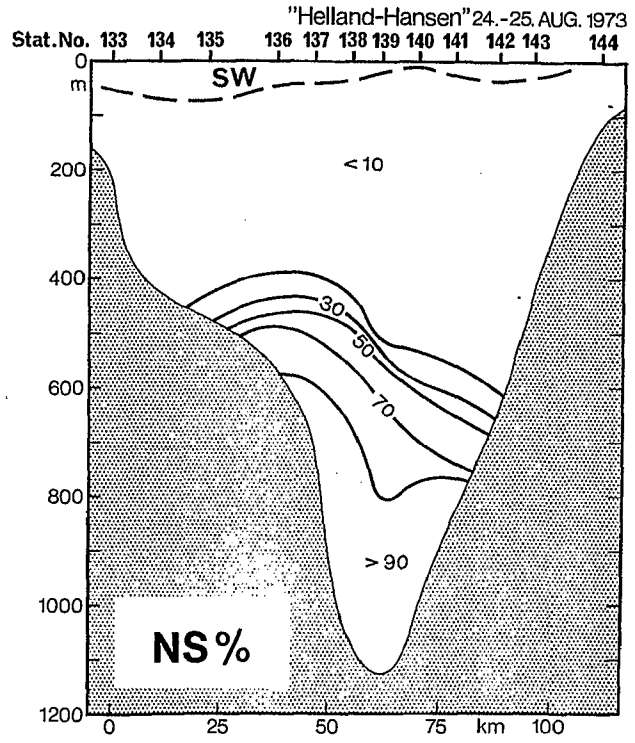
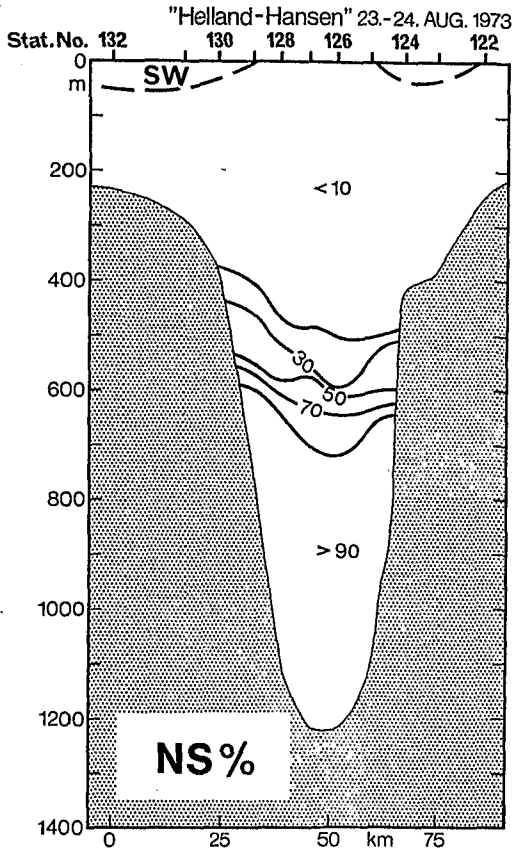



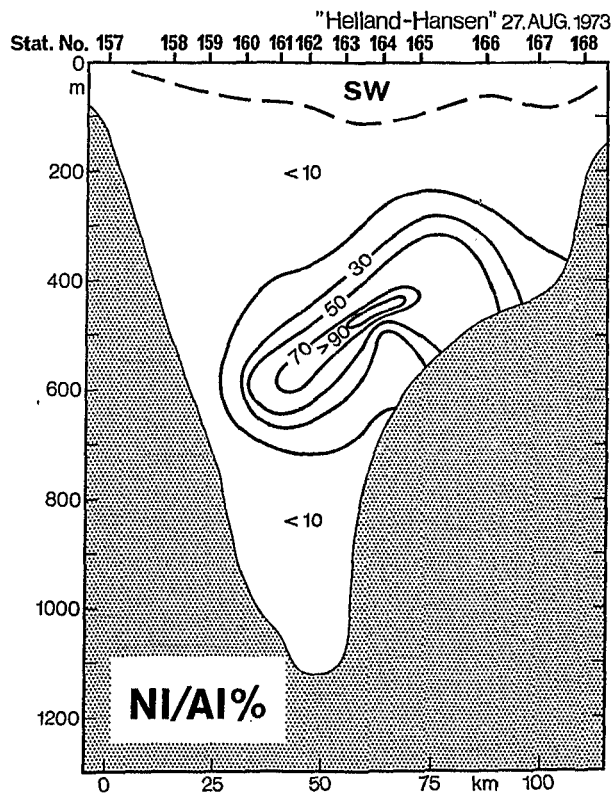
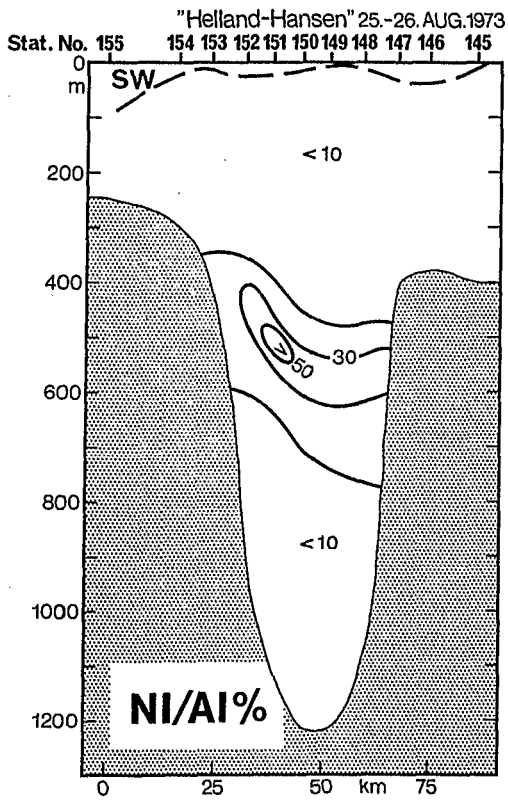
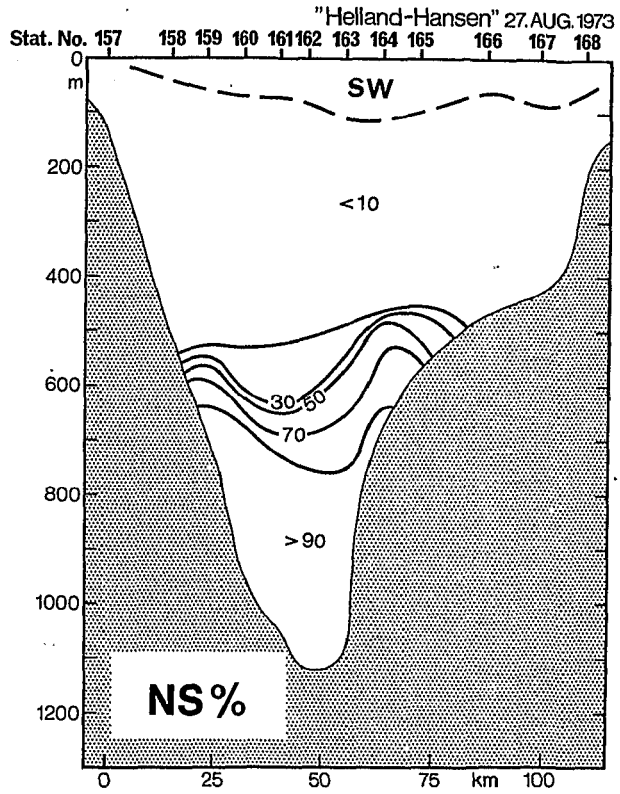
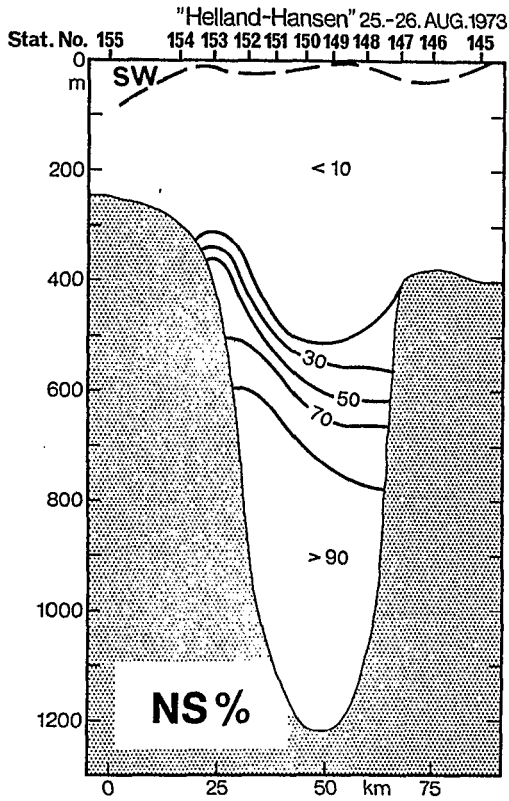

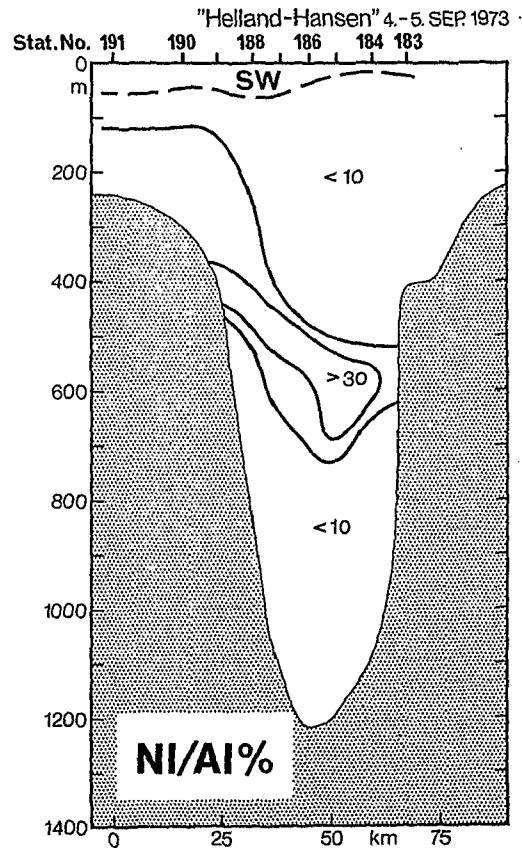
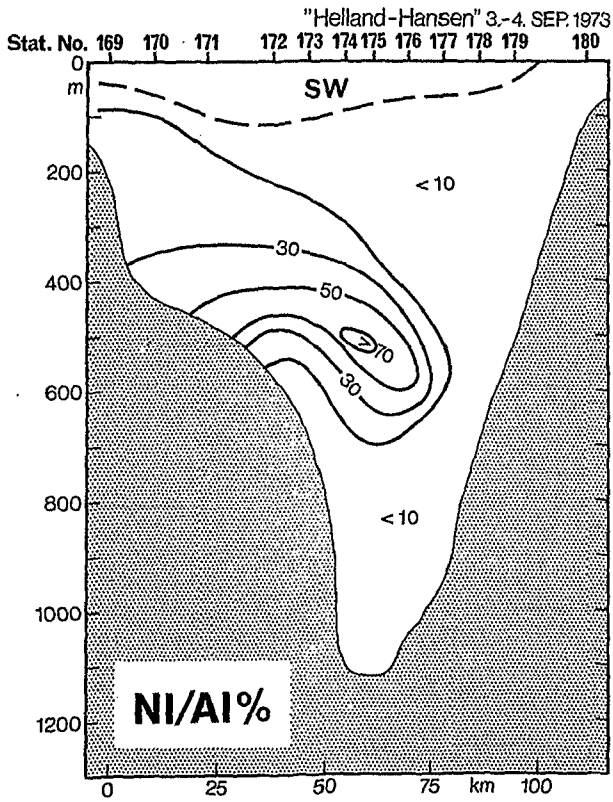
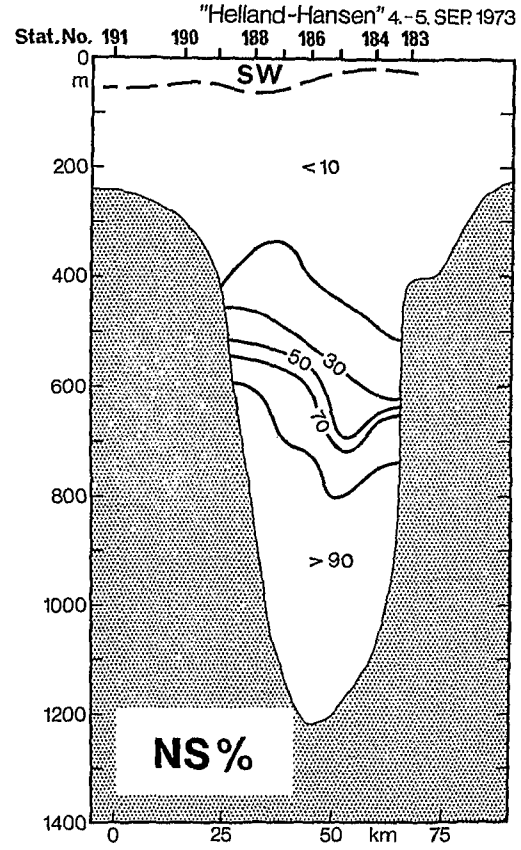
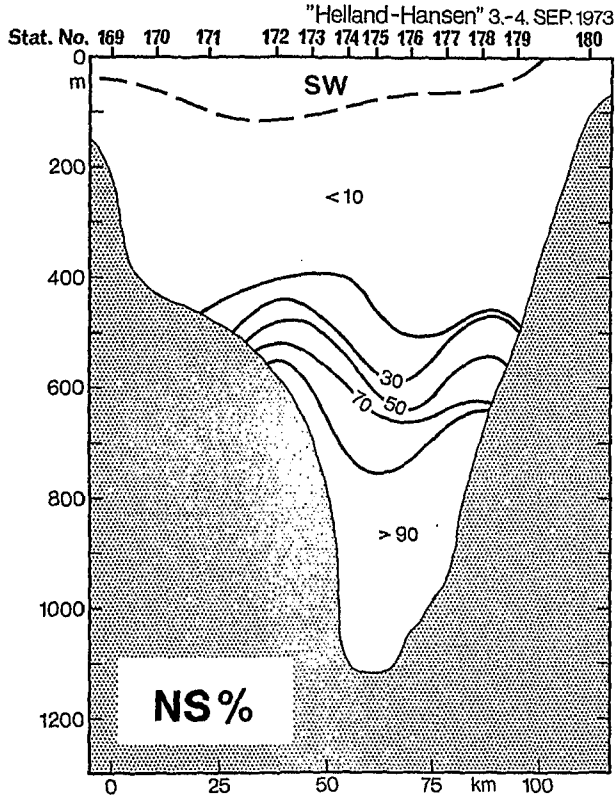

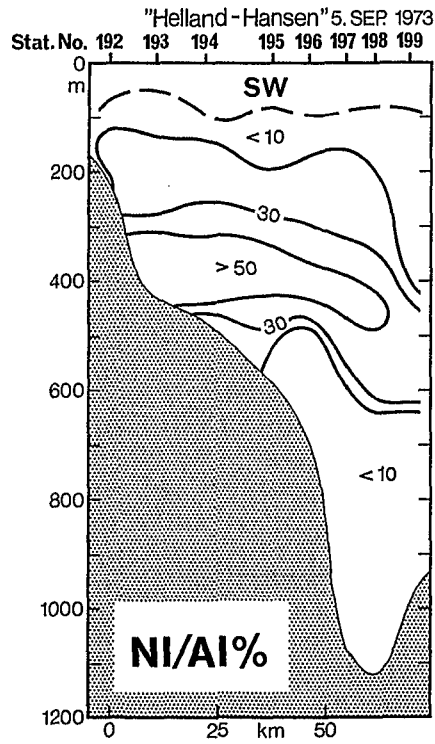
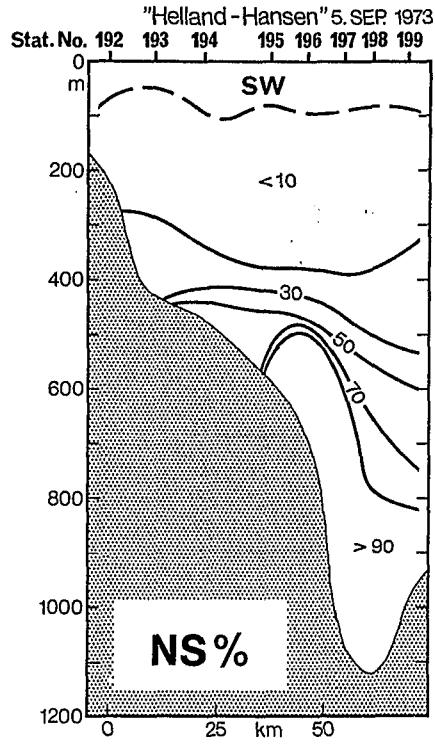

6.3 J.C. Svabo

In this area NI/AI and NS occur in smaller amounts.

Section	Stat.No.	Mixing triangle (see table 3)
101 - 112	101 - 105	3
	106 - 112	4

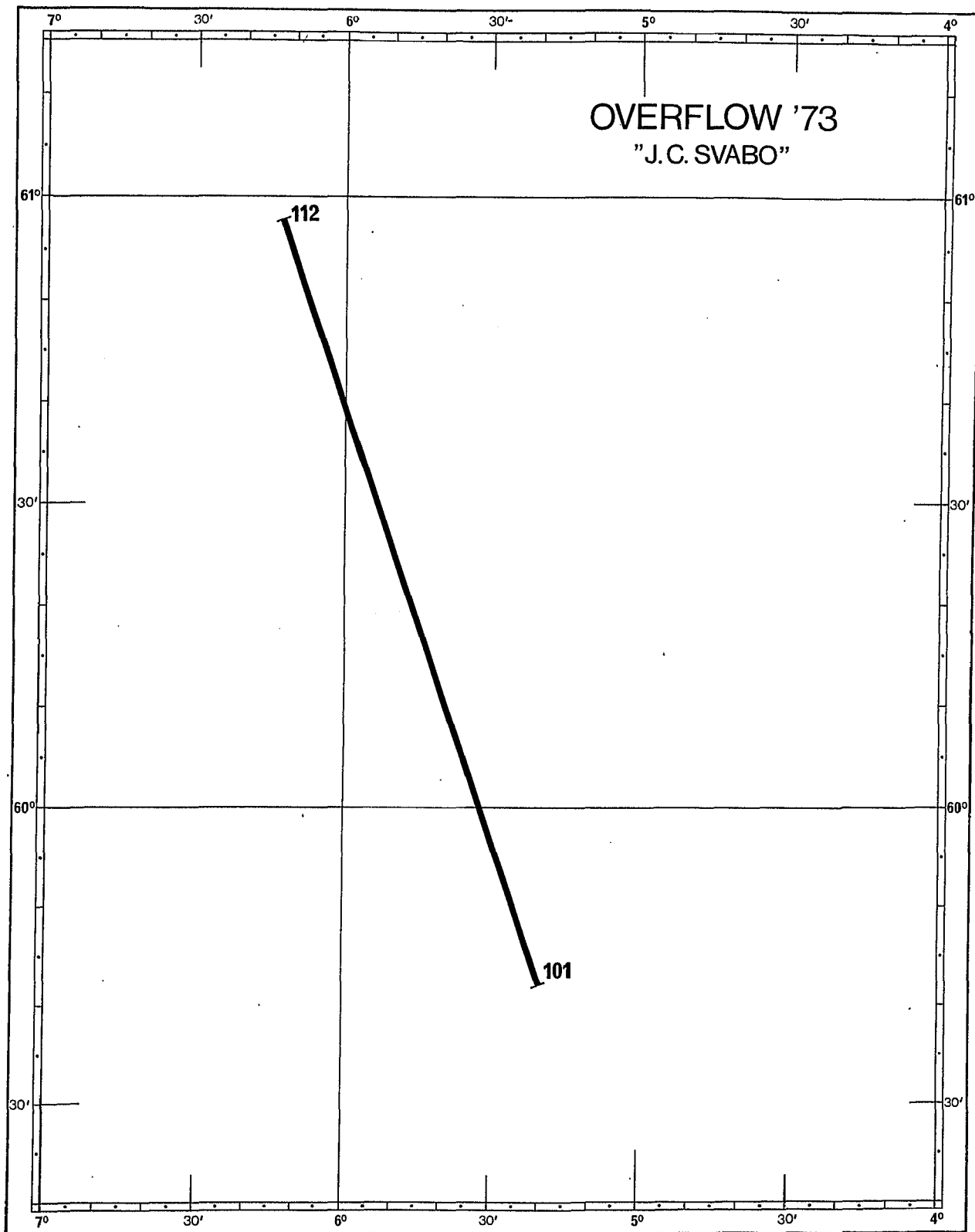

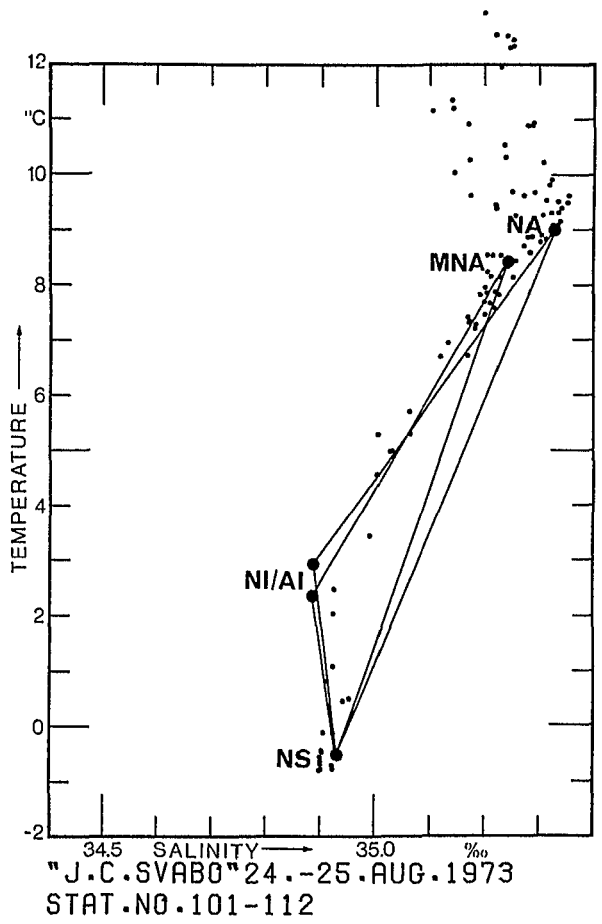

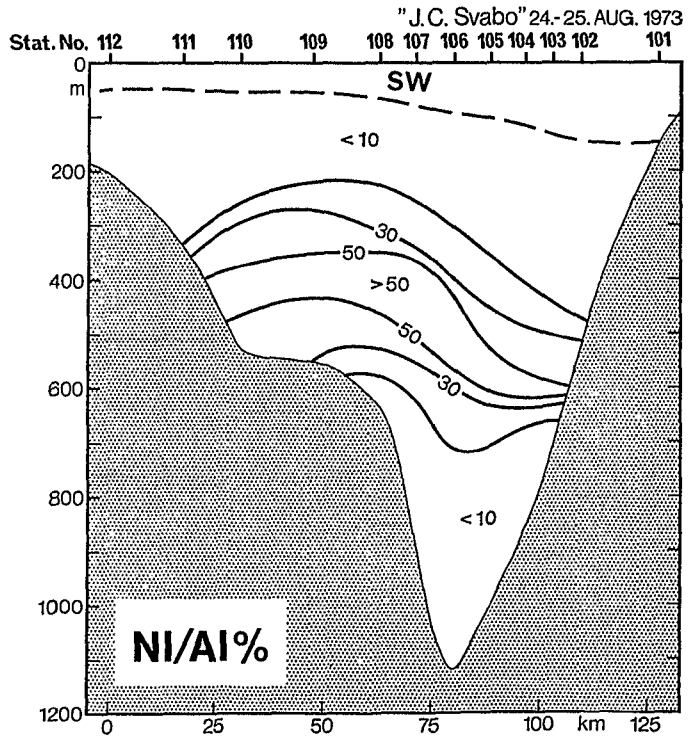
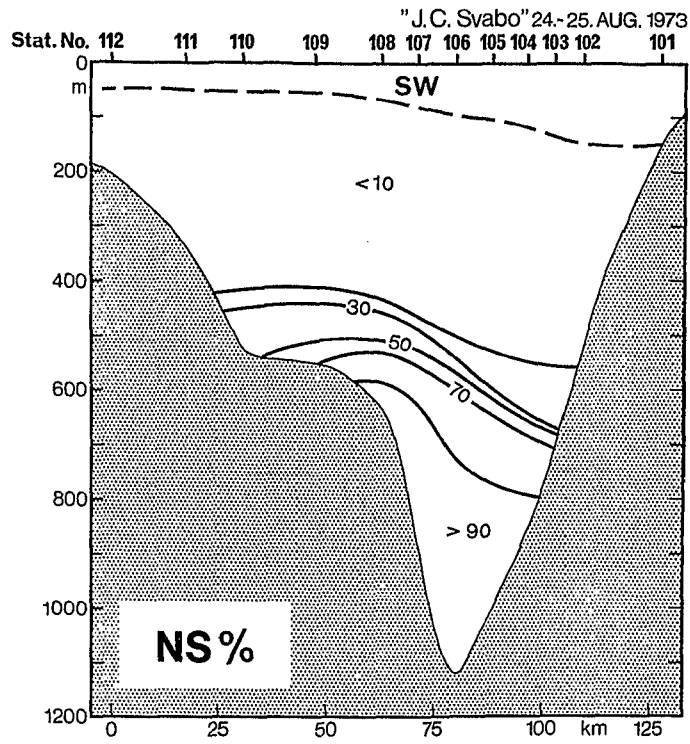

#### 6.4 Challenger

In the area of the Wyville-Thomson Ridge NA is the dominant Atlantic Water type. NI/AI and NS are observed. IS is found in the deeper parts of the Atlantic basin. From station 106 to 109 the amount of NI/AI is less 10 %.

Section	Stat.No.	Mixing triangle (see table 3)
101 - 109	101 - 105	1
	106 - 109	3
119 - 128		3
129 - 136		3
138 - 144		3
145 - 153		3
155 - 162		3
163 - 168		3
169 - 176	169 - 175	3
	176	1
176 - 182		1
182 - 187		1



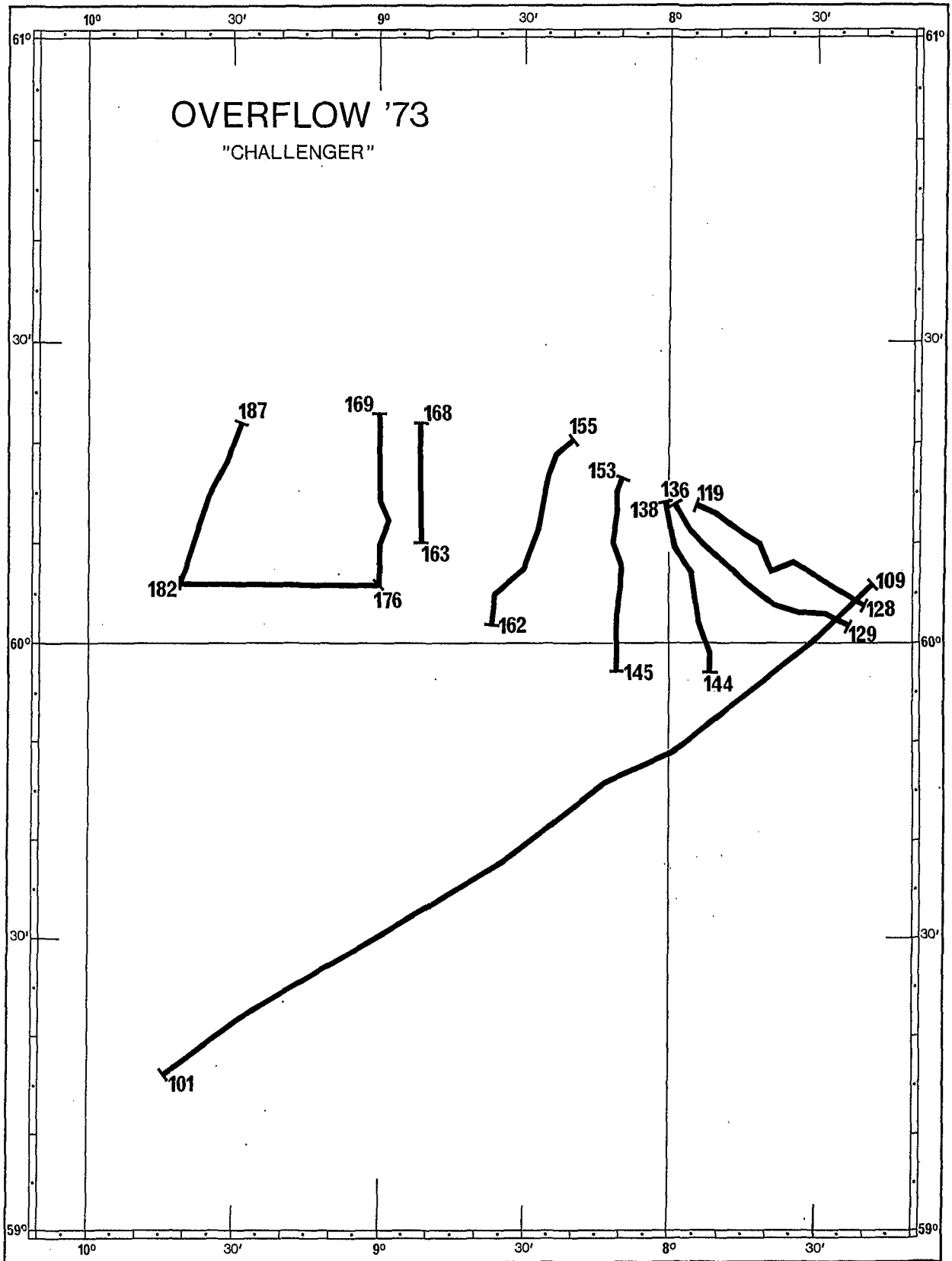

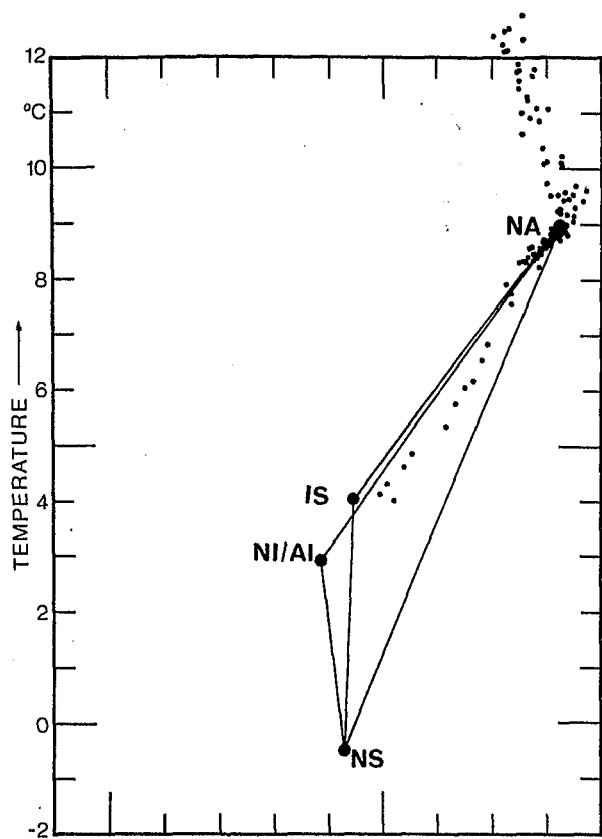

"CHALLENGER" 23.-24. AUG. 1973  
STAT. NO. 101-109

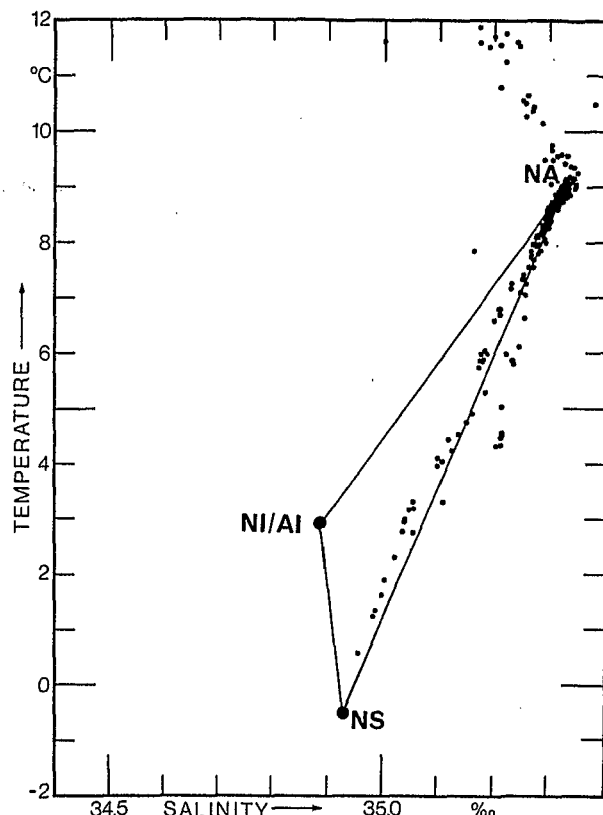

"CHALLENGER" 24.-25. AUG. 1973  
STAT. NO. 119-128

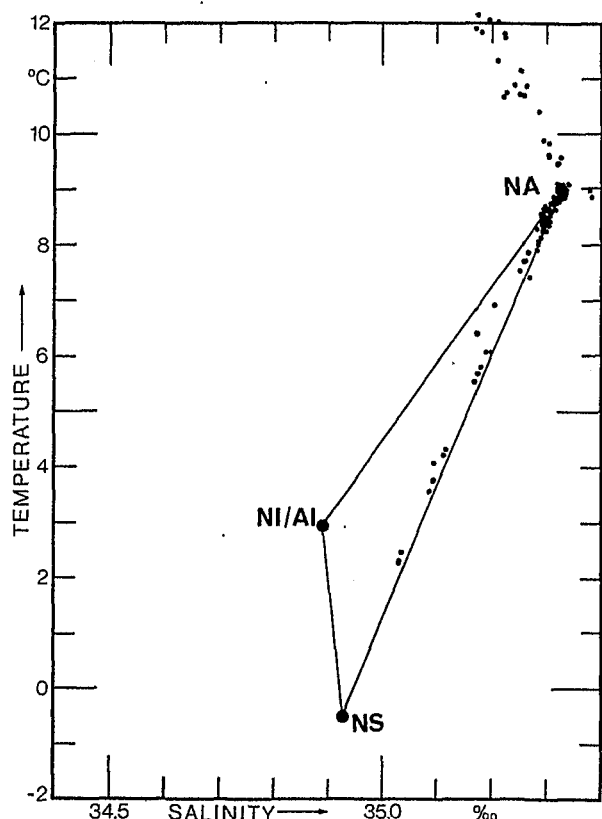

"CHALLENGER" 25. AUG. 1973  
STAT. NO. 129-136

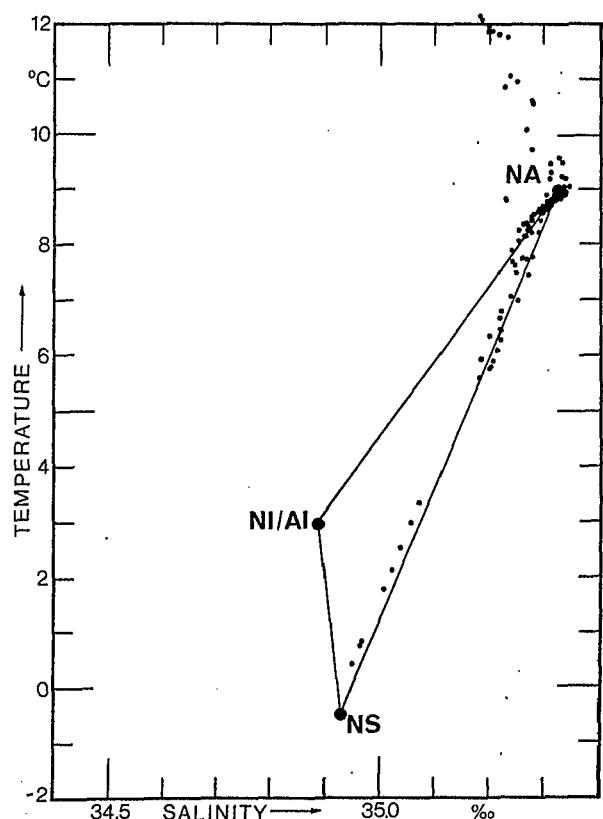

"CHALLENGER" 26. AUG. 1973  
STAT. NO. 138-144

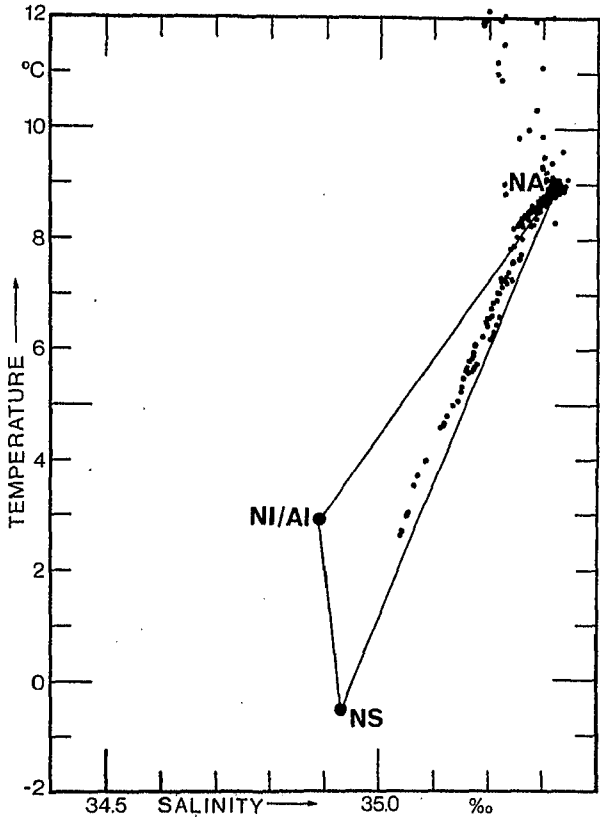

"CHALLENGER" 26.-27. AUG. 1973  
STAT. NO. 145-153

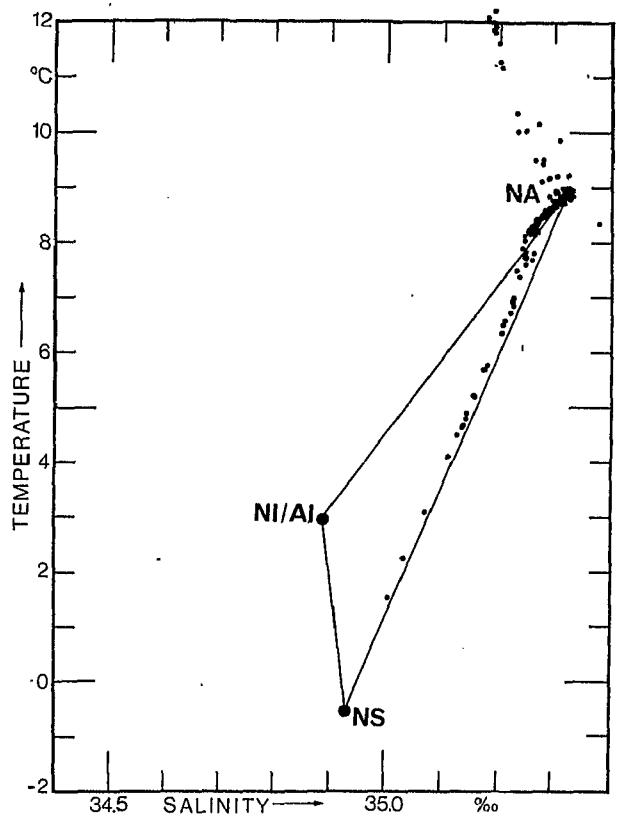

"CHALLENGER" 27. AUG. 1973  
STAT. NO. 155-162

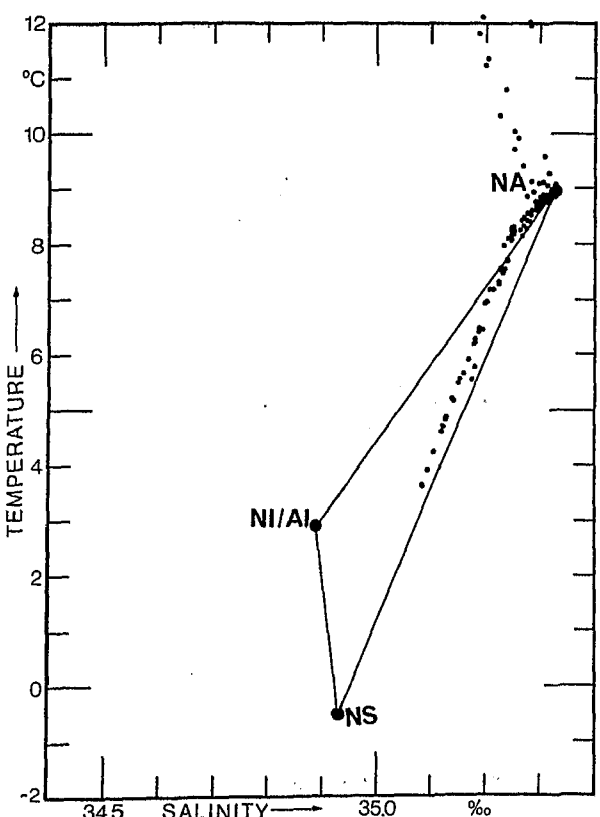

"CHALLENGER" 28. AUG. 1973  
STAT. NO. 163, 164, 166-168

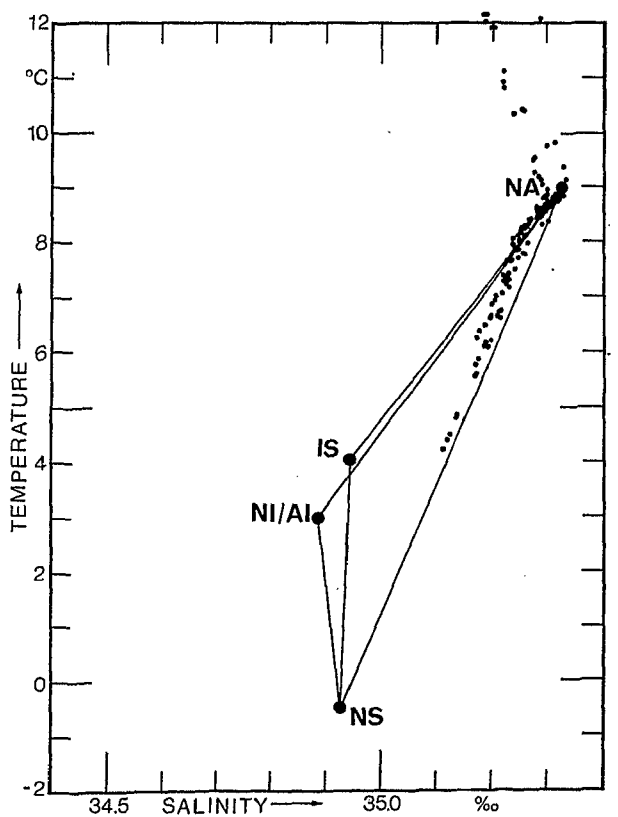

"CHALLENGER" 28. AUG. 1973  
STAT. NO. 169-176

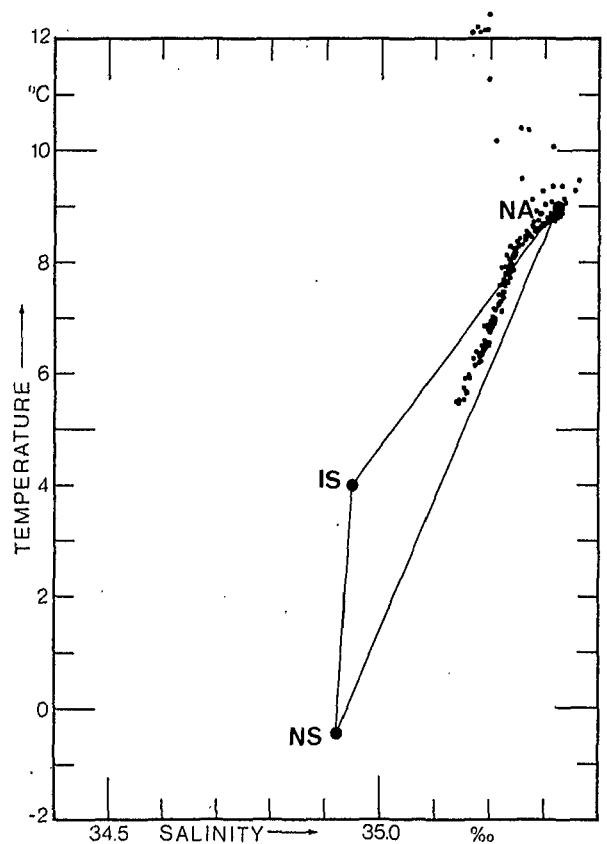

"CHALLENGER" 28.-29. AUG. 1973  
STAT. NO. 176-182

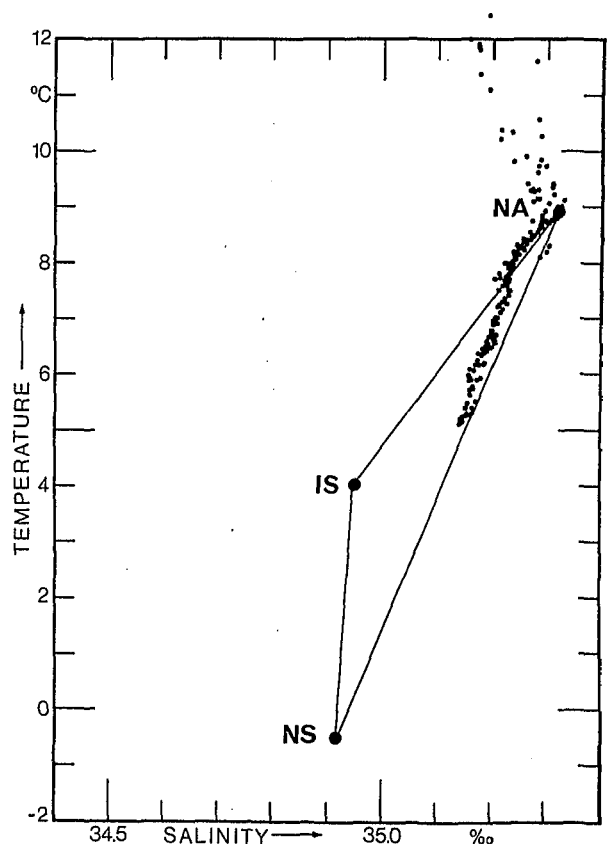

"CHALLENGER" 29. AUG. 1973  
STAT. NO. 182-187

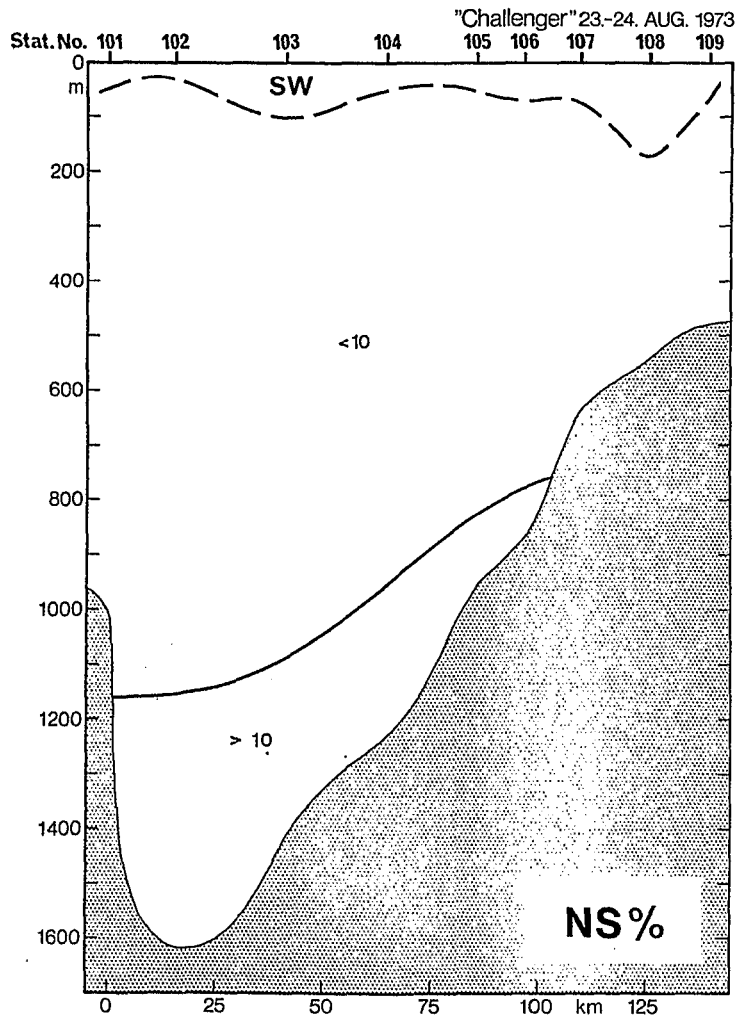

"Challenger" 24-25. AUG. 1973  
Stat.No. 119 120 122 124 126 128

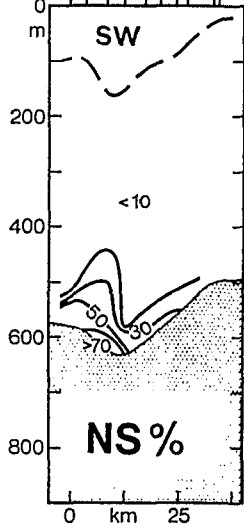

"Challenger" 25. AUG. 1973  
Stat.No. 136 134 132 130 129

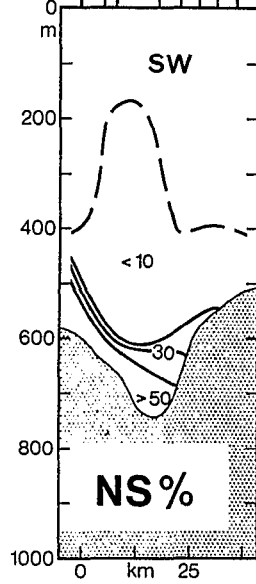

"Challenger" 26. AUG. 1973  
Stat.No. 138 140 142 144

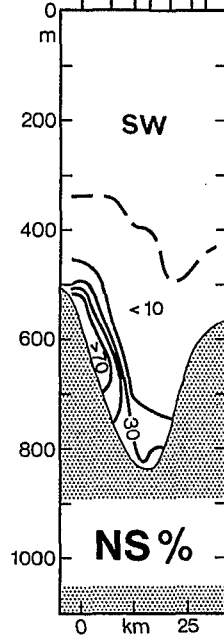

"Challenger" 26-27.AUG.1973  
Stat.No. 145 147 149 151 153

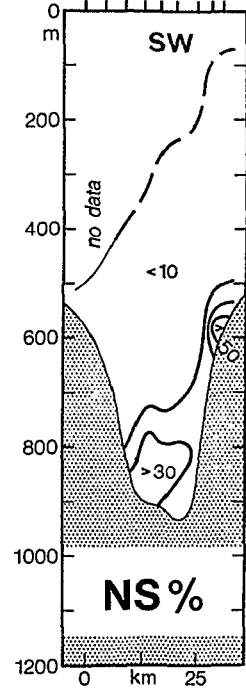

"Challenger" 24-25. AUG. 1973  
Stat.No. 119 120 122 124 126 128

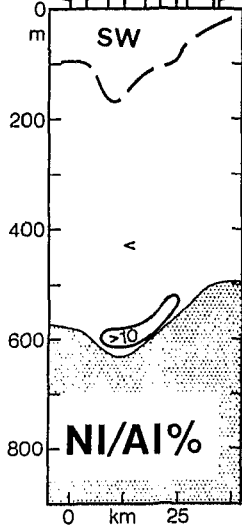

"Challenger" 25. AUG. 1973  
Stat.No. 136 134 132 130 129

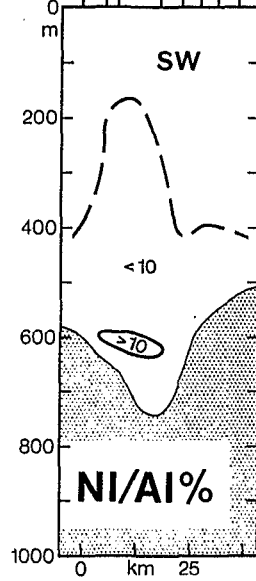

"Challenger" 26. AUG. 1973  
Stat.No. 138 140 142 144

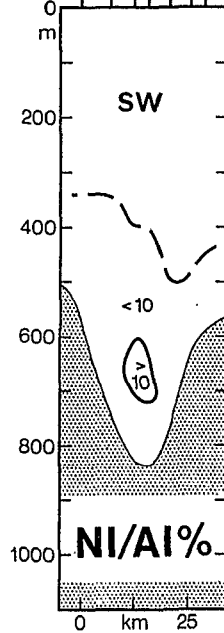

"Challenger" 26-27.AUG.1973  
Stat.No. 145 147 149 151 153

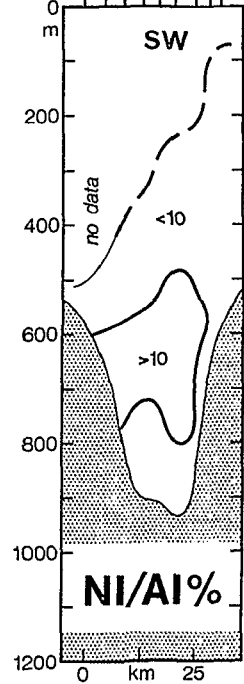

"Challenger" 27.AUG.1973  
Stat. No. 162 160 158 156 155

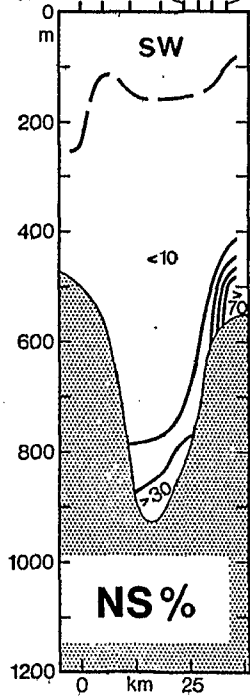

"Challenger" 28.AUG.1973  
Stat. No. 163 164 166 167 168

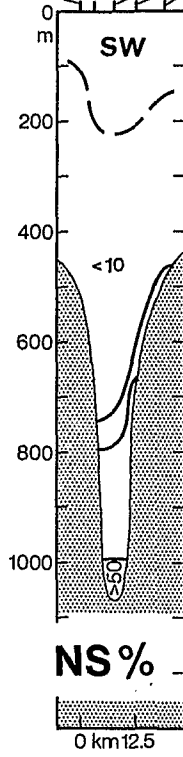

"Challenger" 28.AUG.1973  
Stat. No. 176 174 172 170 169

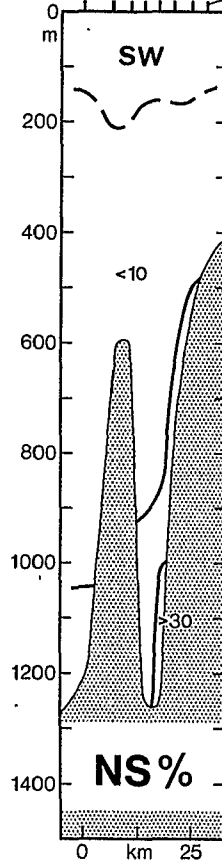

"Challenger" 27.AUG.1973  
Stat. No. 162 160 158 156 155

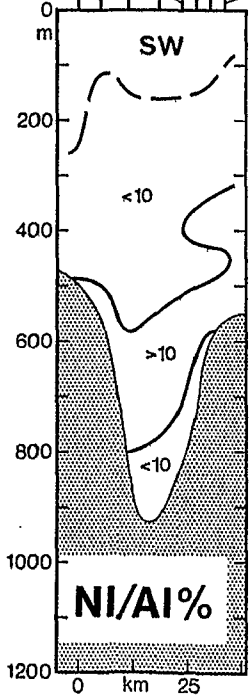

"Challenger" 28.AUG.1973  
Stat. No. 163 164 166 167 168

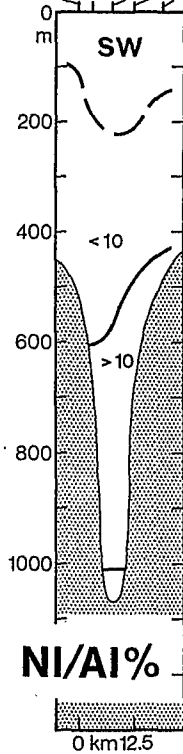

"Challenger" 28.AUG.1973  
Stat. No. 176 174 172 170 169

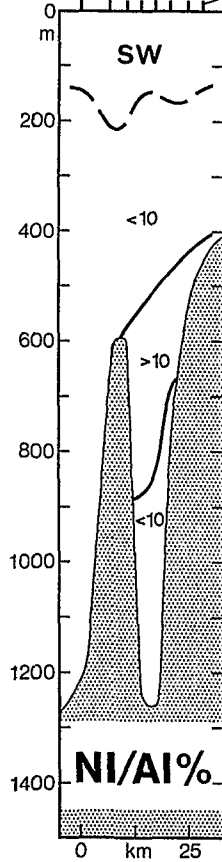

"Challenger" 28.-29.AUG.1973  
Stat. No. 182 180 178 176

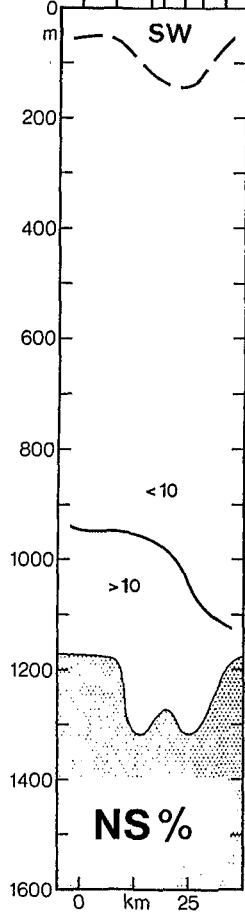

"Challenger" 29. AUG. 1973  
Stat. No. 182 183 185 187

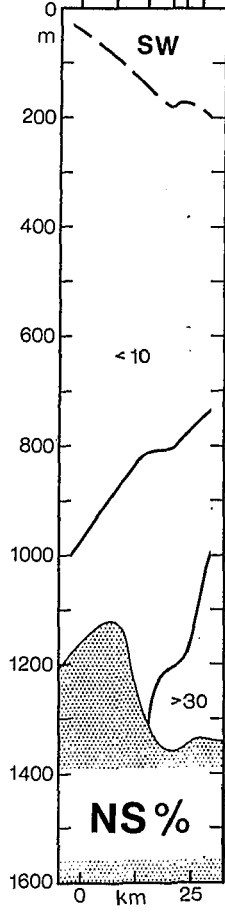



6.5 Cirolana

NA is the dominant Atlantic water, NI/AI and 143 are observed in small amounts.

Section	Stat.No.	Mixing triangle (see table 3)
all	all	3

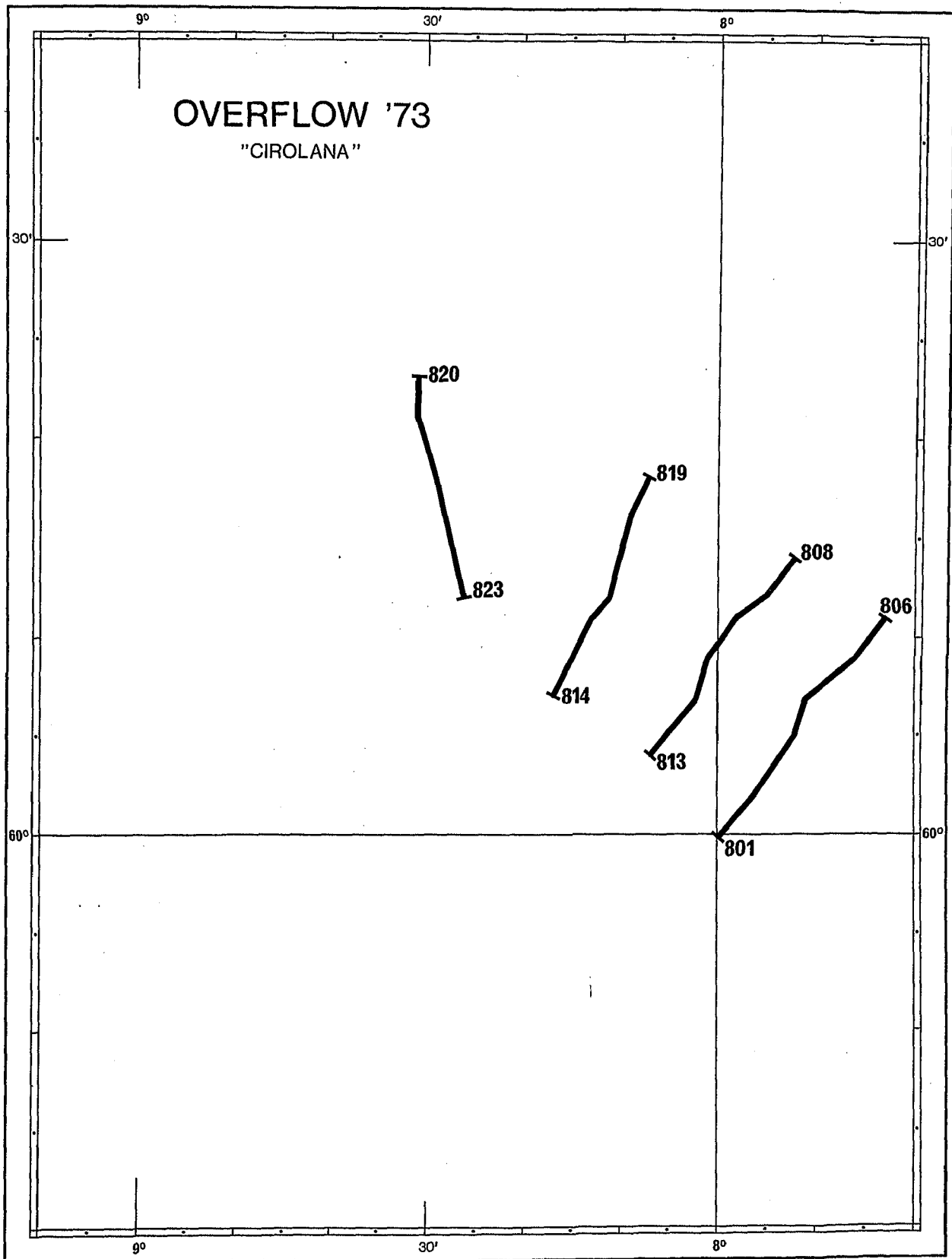

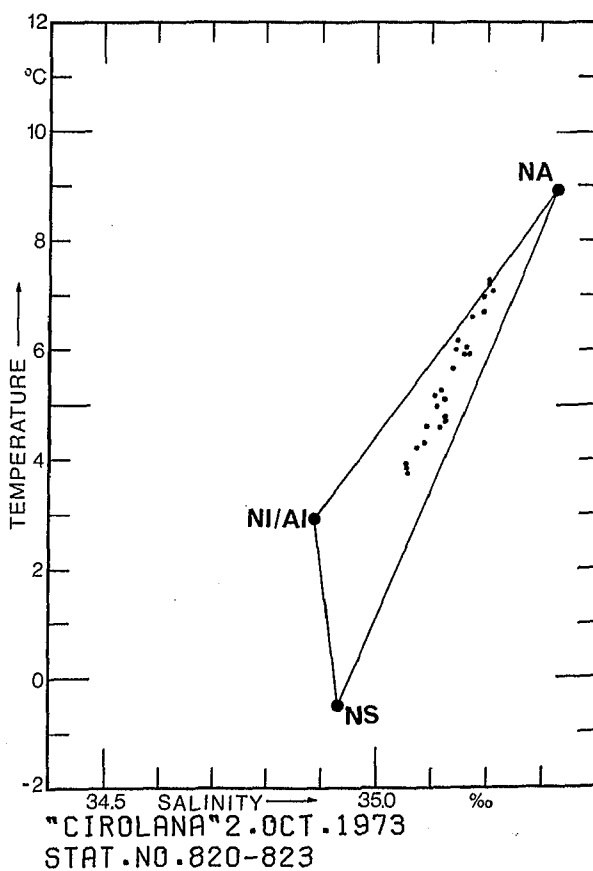
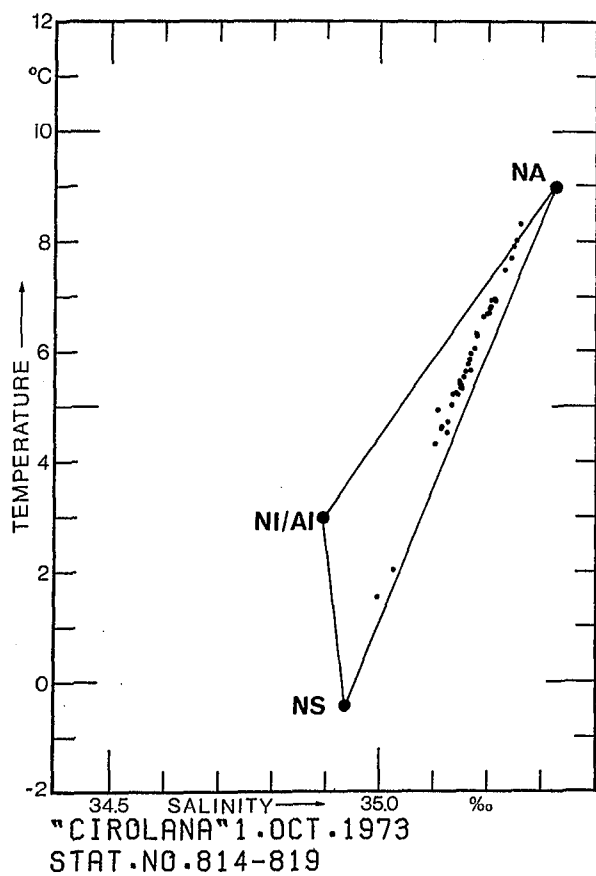
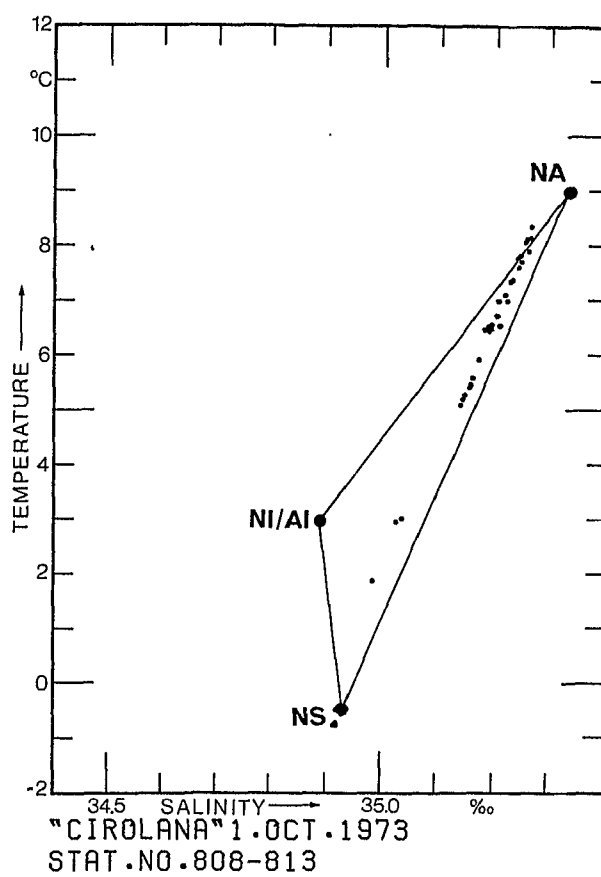
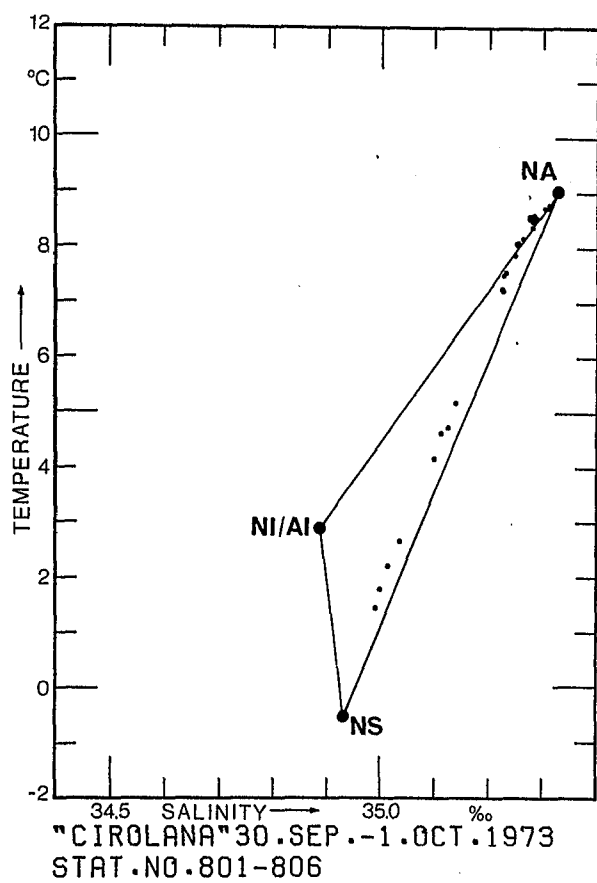

"Cirolana"  
30.SEP-1.OCT.1973  
Stat.No.801 802 804 806

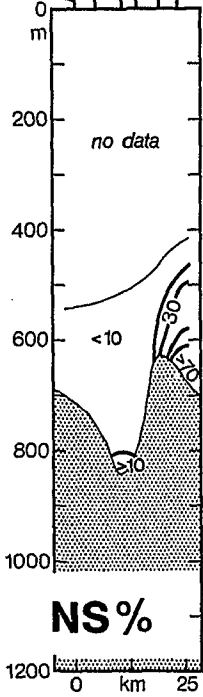

"Cirolana"  
1.OCT.1973  
Stat.No. 813 812 810 808

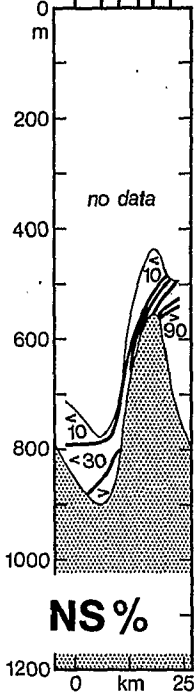

"Cirolana"  
1.OCT.1973  
Stat.No. 814 816 818 819

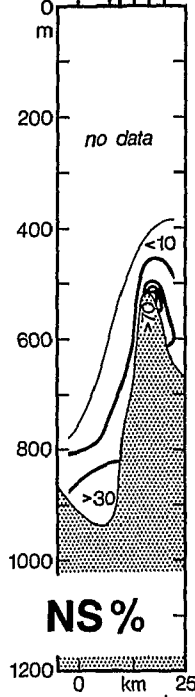

"Cirolana"  
2.OCT.1973  
Stat.No. 820 822 823

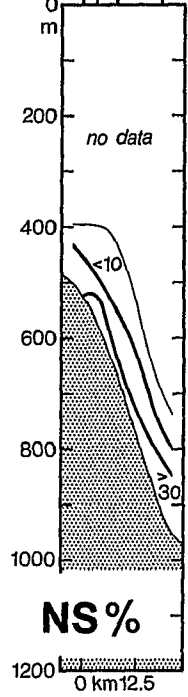

"Cirolana"  
30.SEP-1.OCT.1973  
Stat.No.801 802 804 806

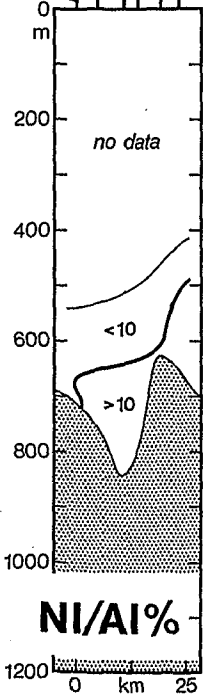

"Cirolana"  
1.OCT.1973  
Stat.No. 813 812 810 808

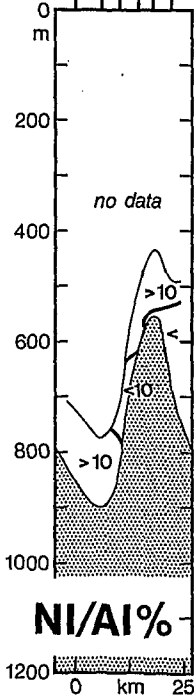

"Cirolana"  
1.OCT.1973  
Stat.No. 814 816 818 819

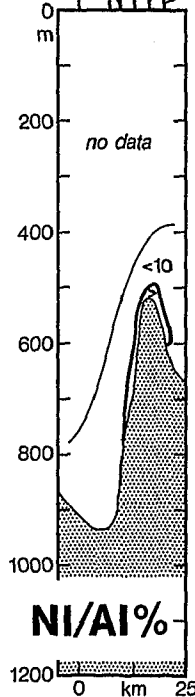

"Cirolana"  
2.OCT.1973  
Stat.No. 820 822 823

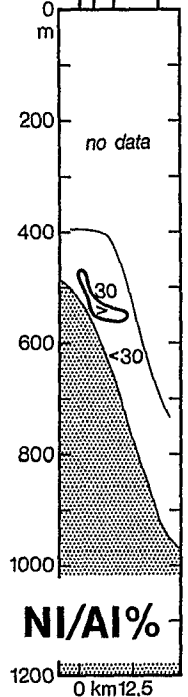

6.6 Shackleton

For the region of the Faroe-Bank Channel the Atlantic water is dominated by MNA. NI/AI and NS are observed. IS is found in the deep Atlantic basin.

Section	Stat.No.	Mixing triangle (see table 3)
211 - 219		2
220 - 226		2
227 - 233		2
234 - 240		2
240 - 244		2
246 - 253		4
254 - 257	254 - 256	4
	257	2
262 - 269		4
270 - 277		4
278 - 286		4
287 - 293		4
294 - 298		2

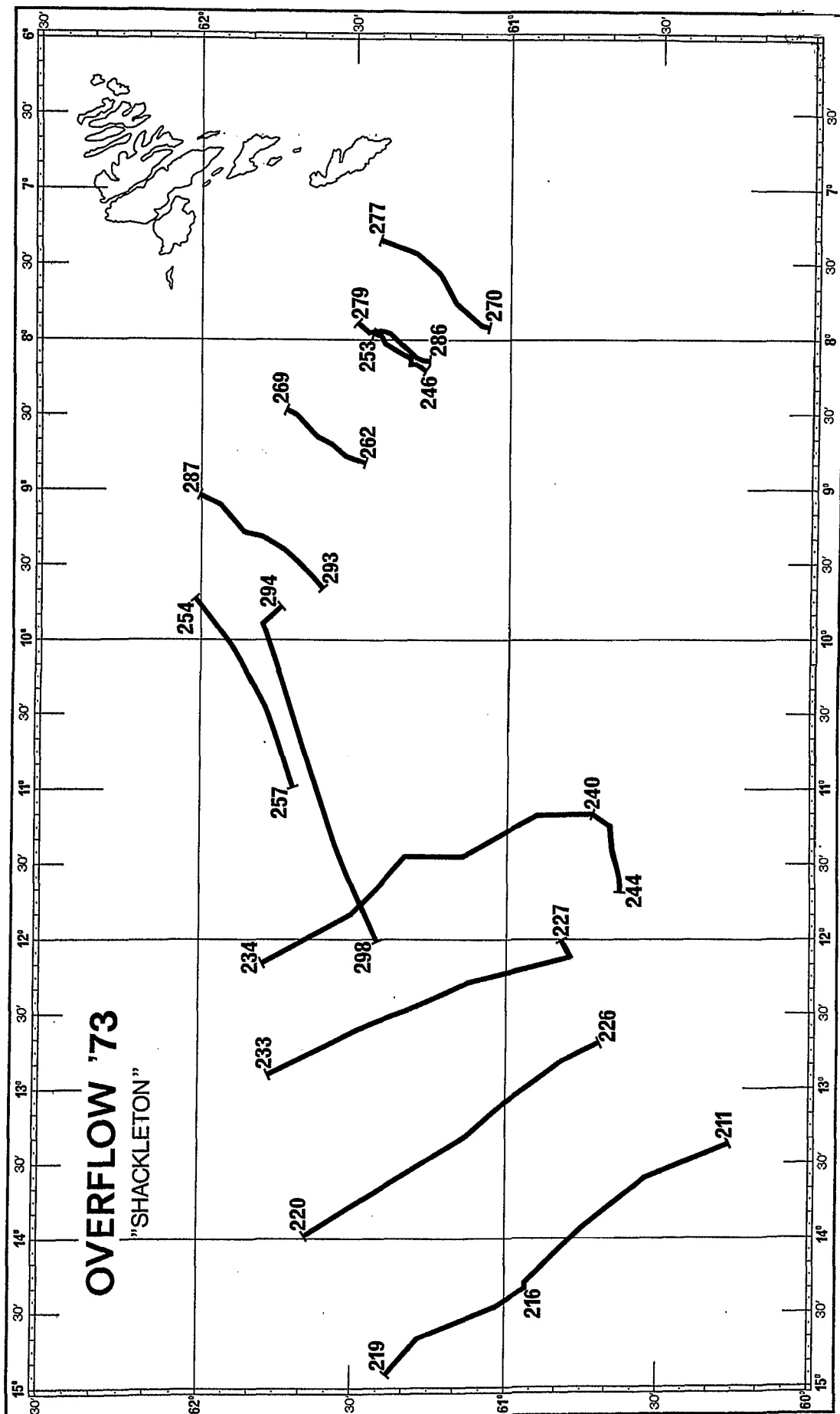

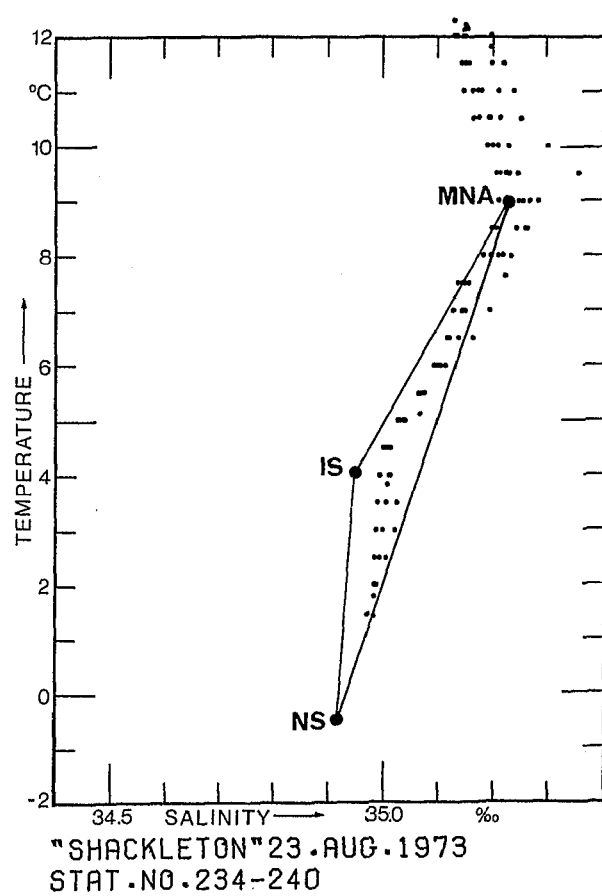
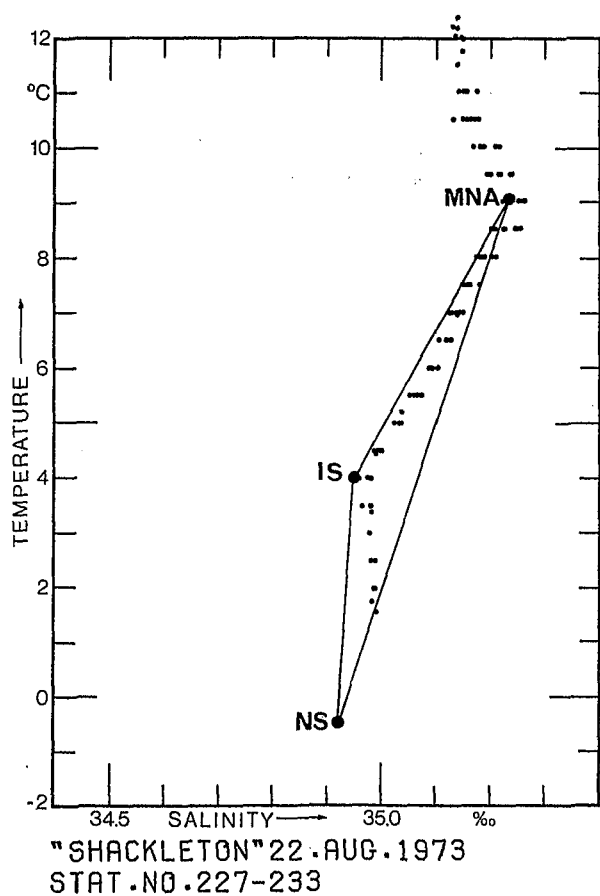
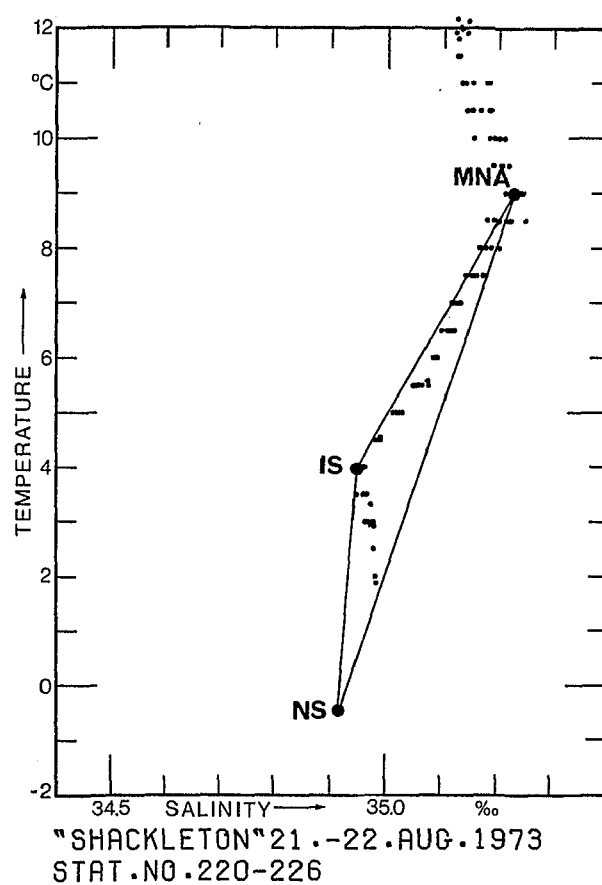
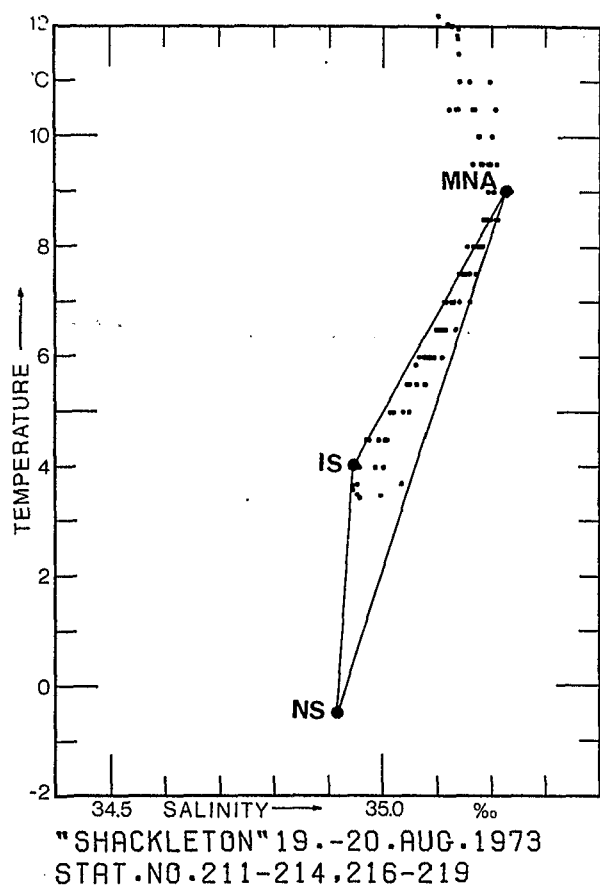

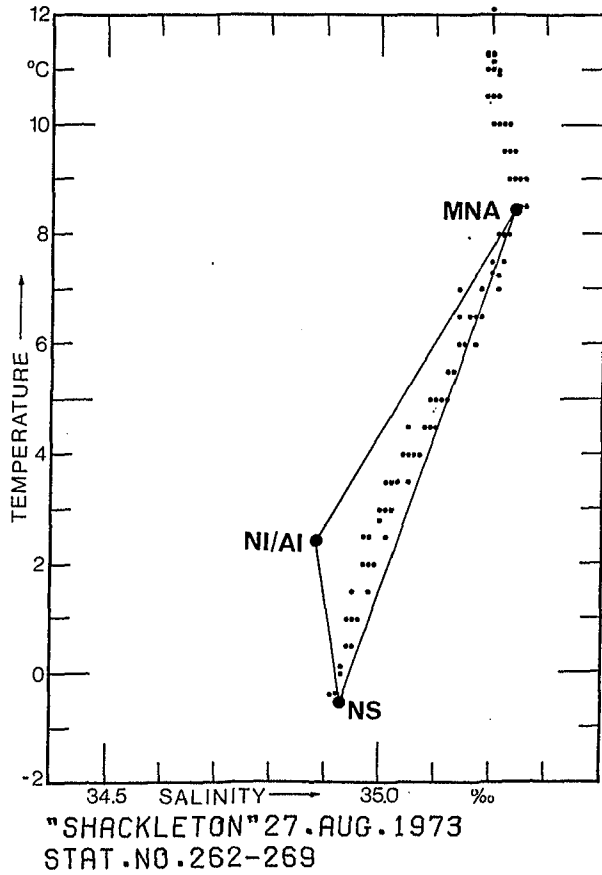
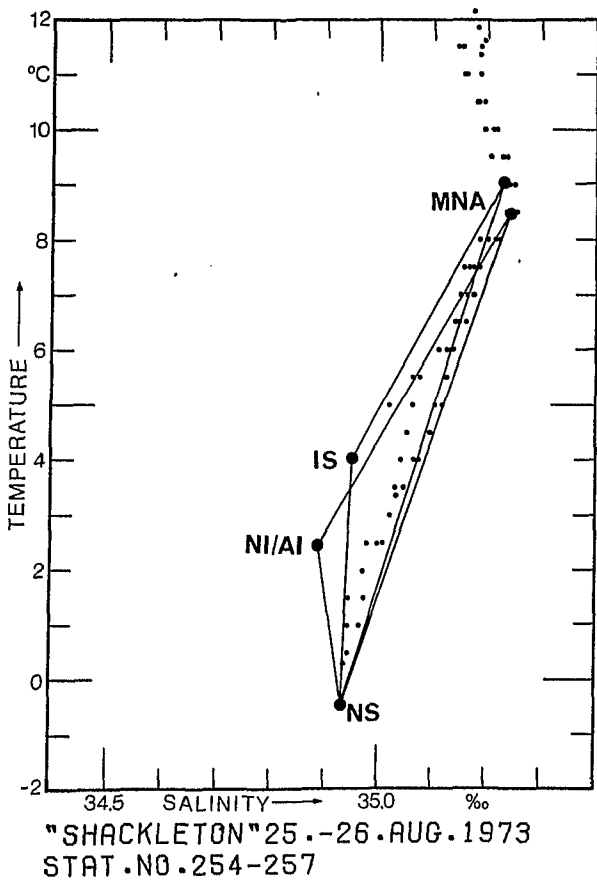
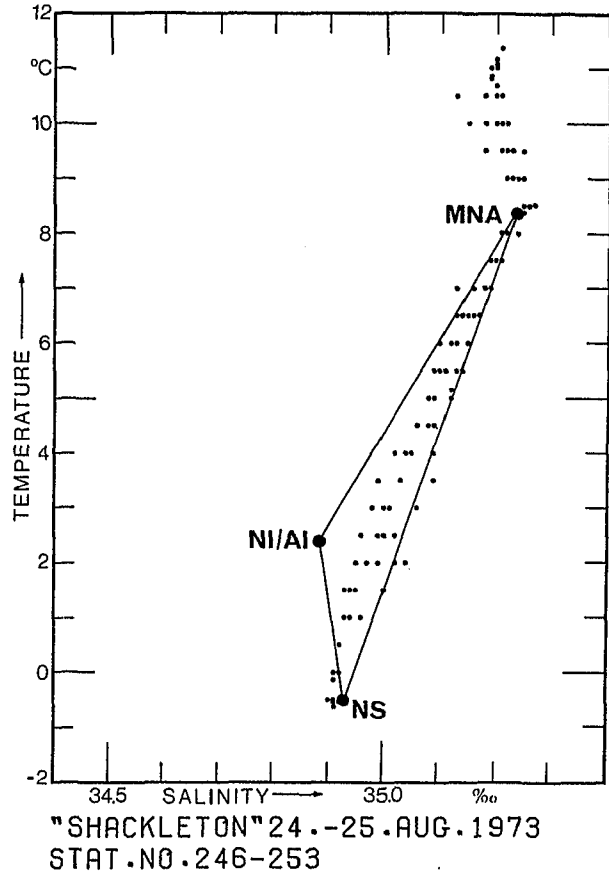
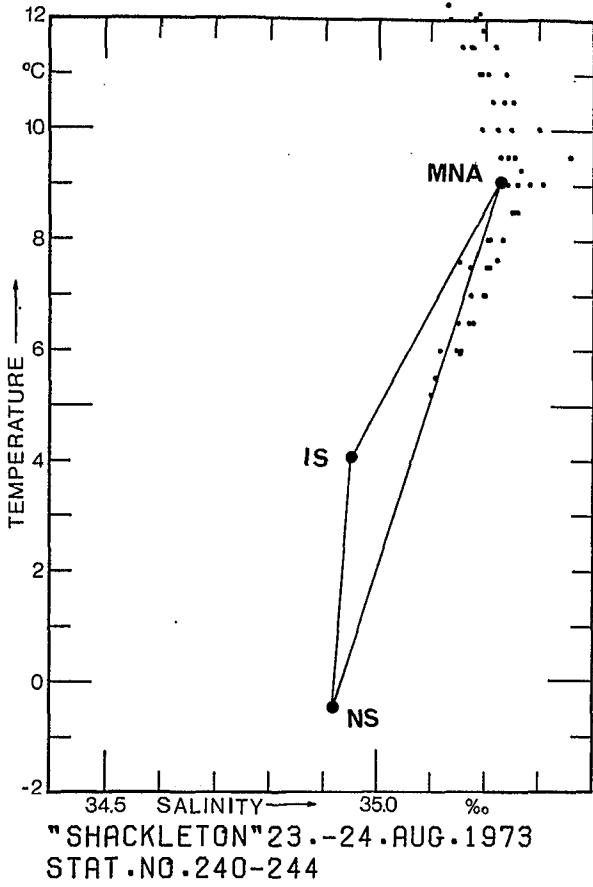



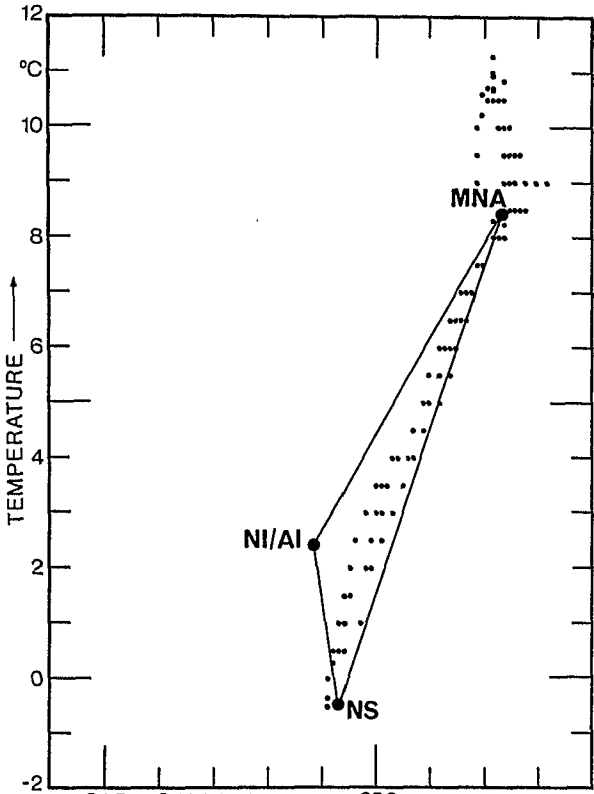

"SHACKLETON" 28.AUG.1973  
STAT.NO.270-277

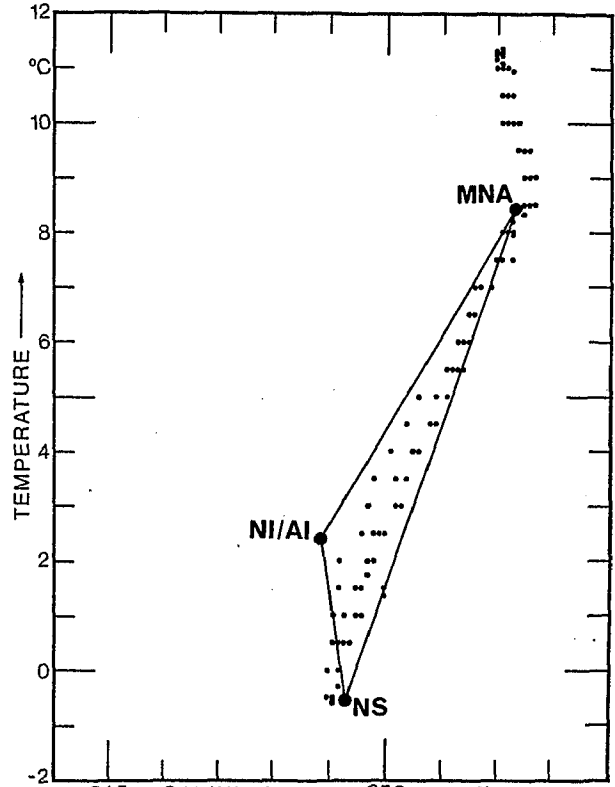

"SHACKLETON" 28.-29.AUG.1973  
STAT.NO.278-286

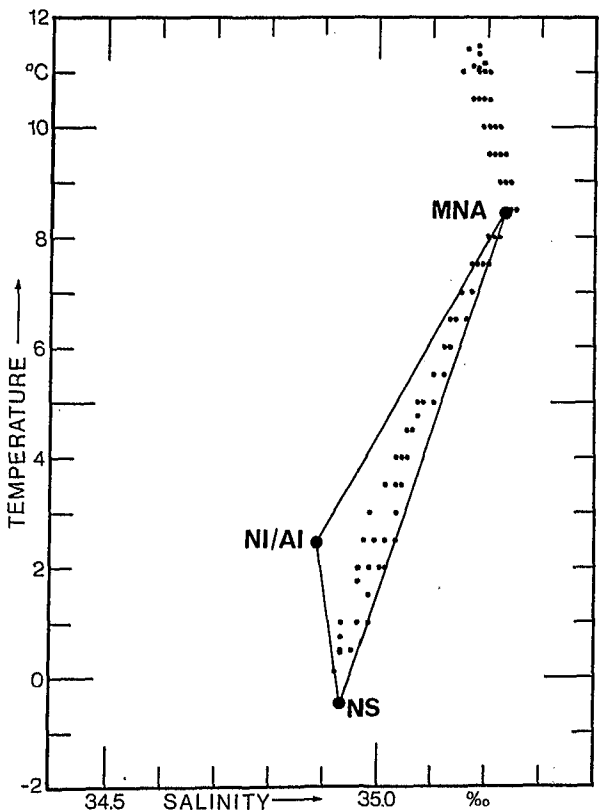

"SHACKLETON" 2.-3.SEP.1973  
STAT.NO.287-293

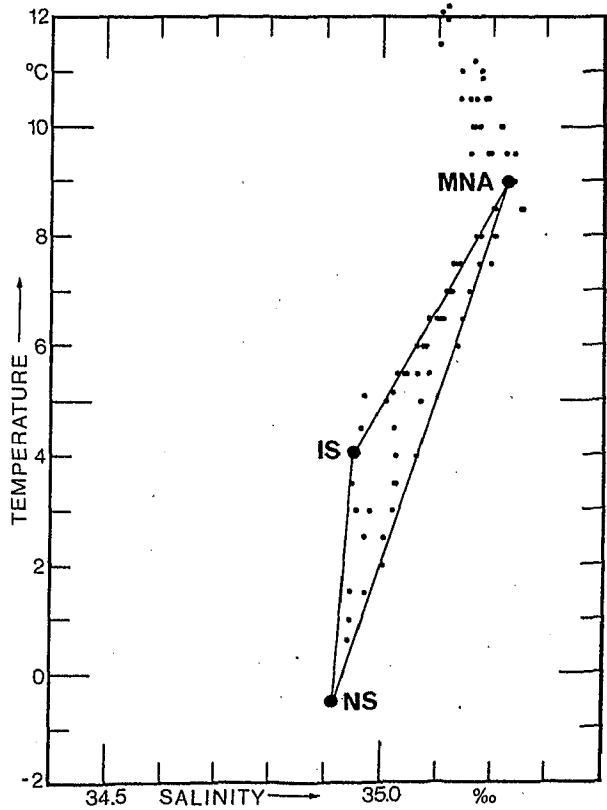

"SHACKLETON" 3.-4.SEP.1973  
STAT.NO.294-296.298

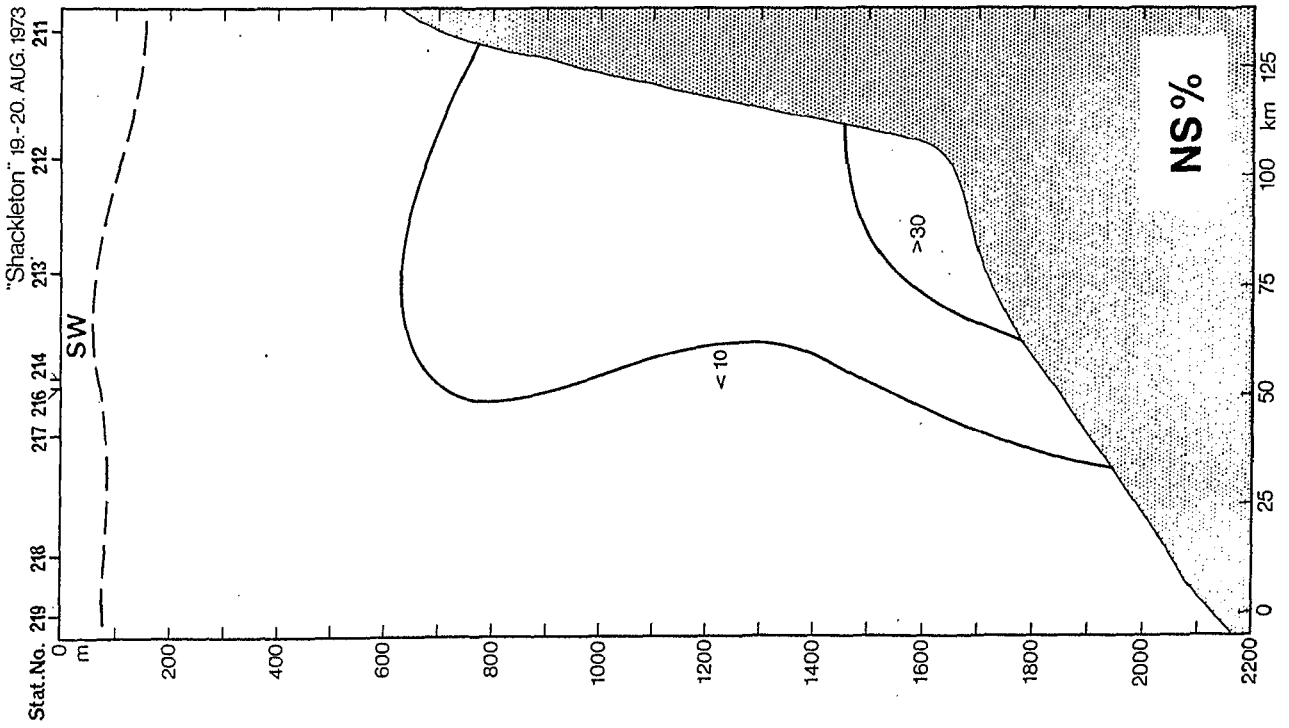
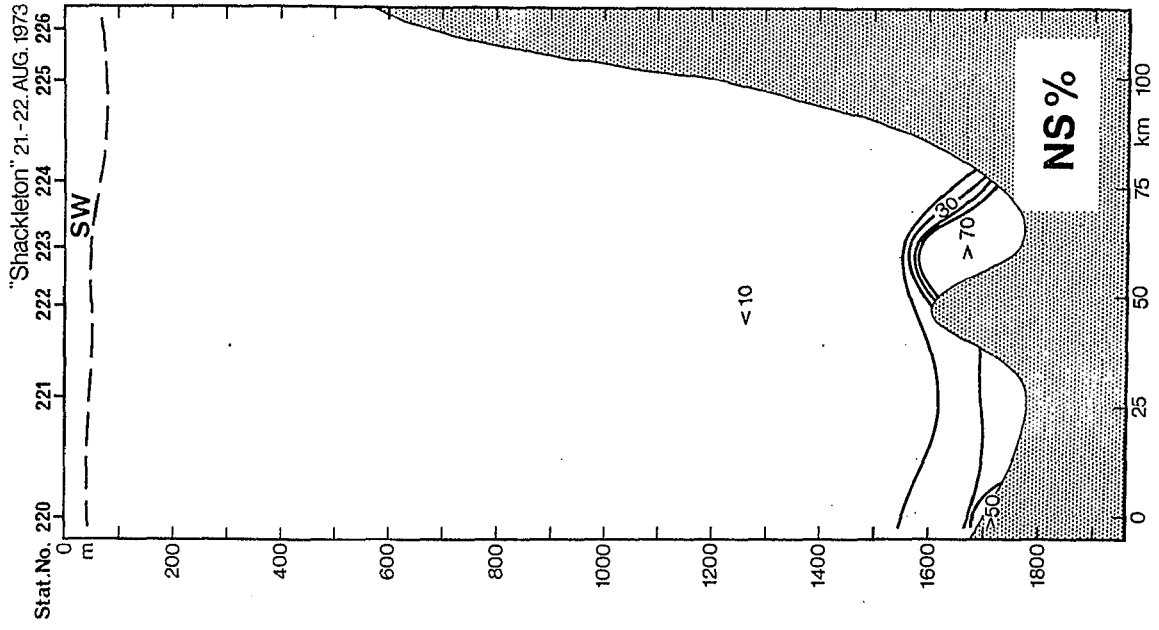

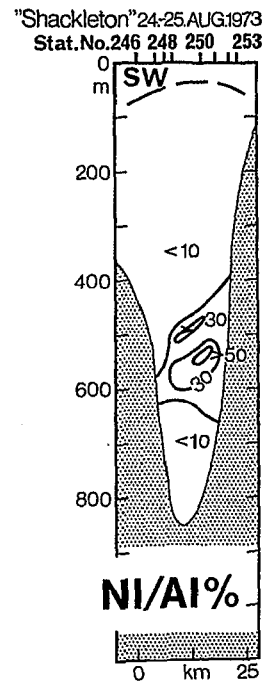
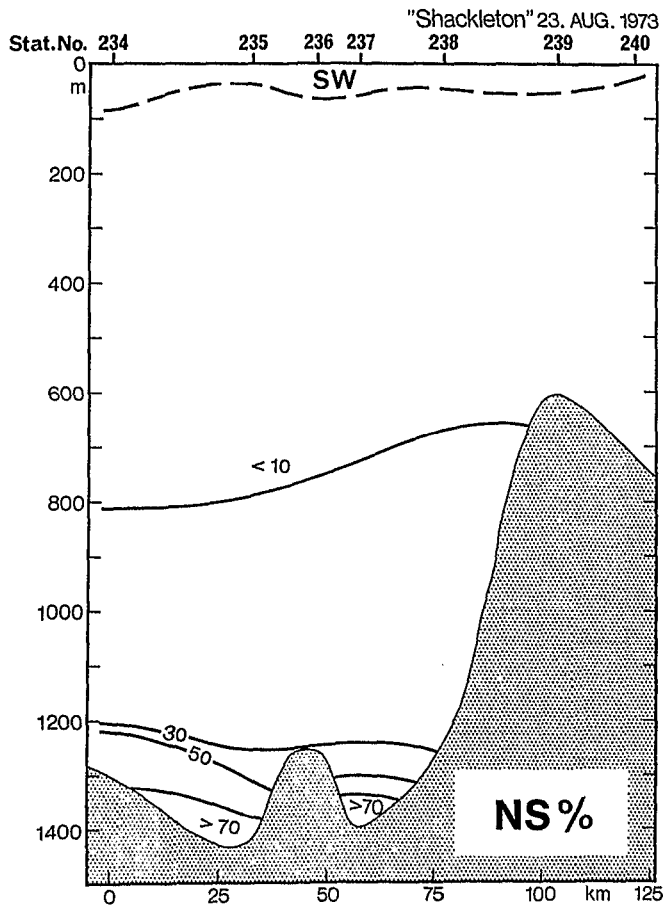
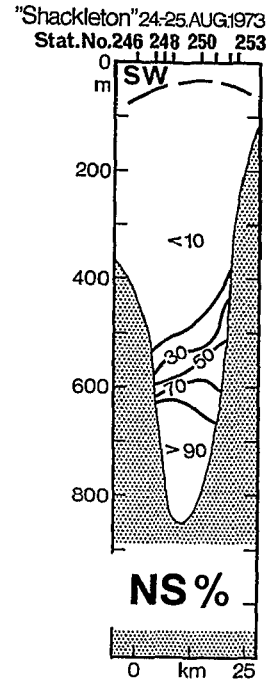
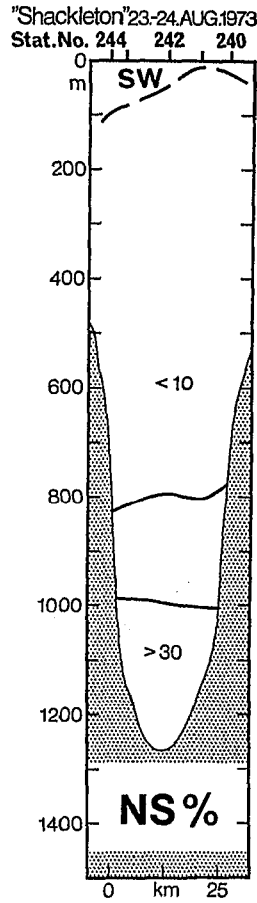
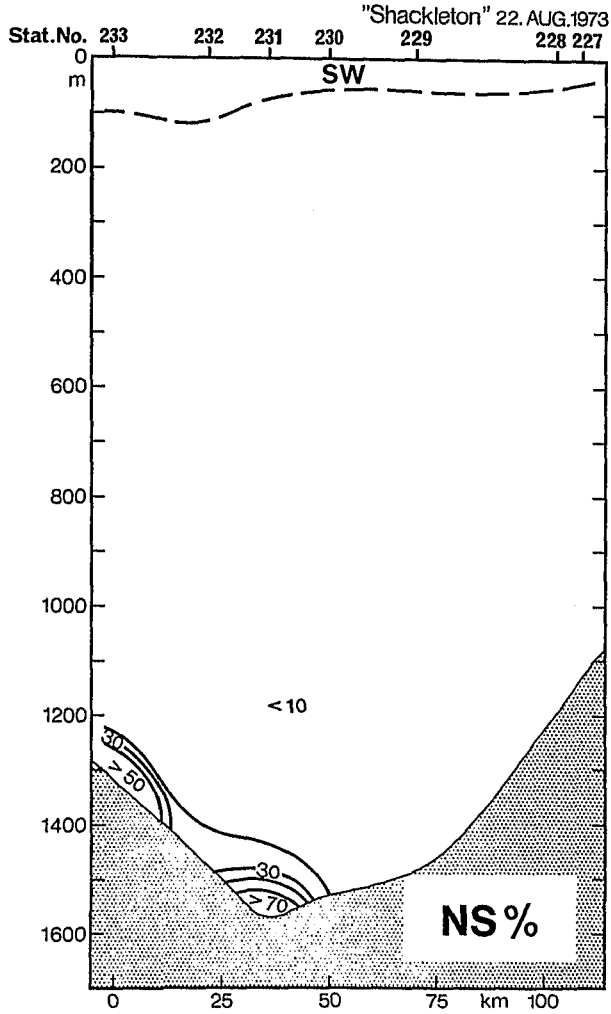

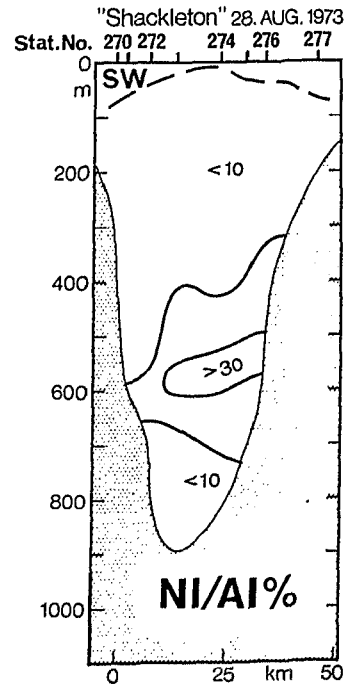
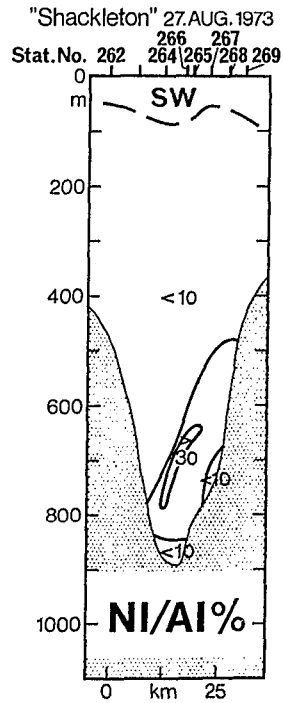
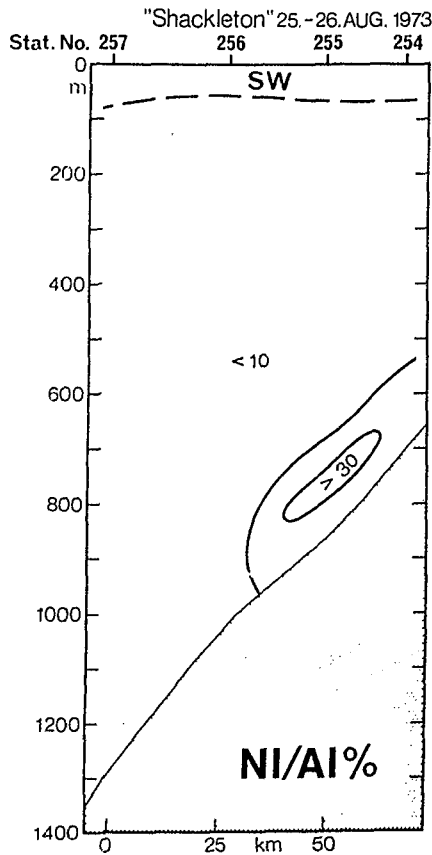
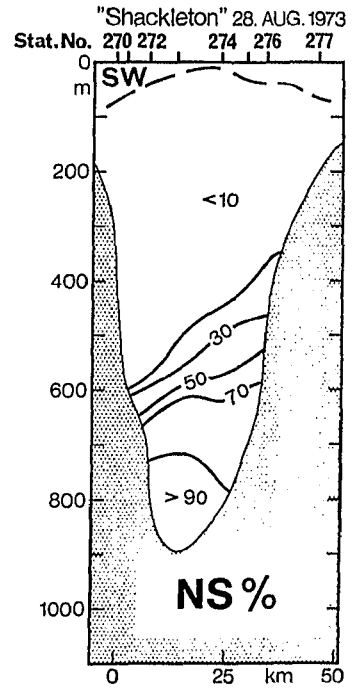
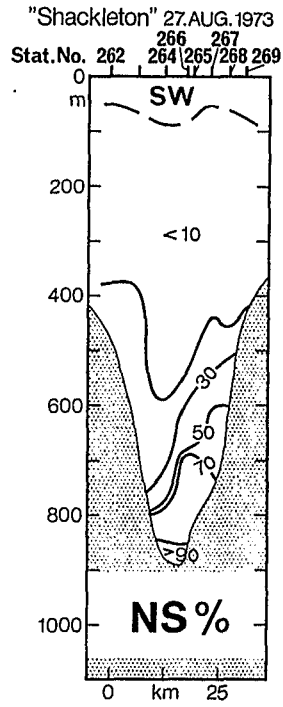
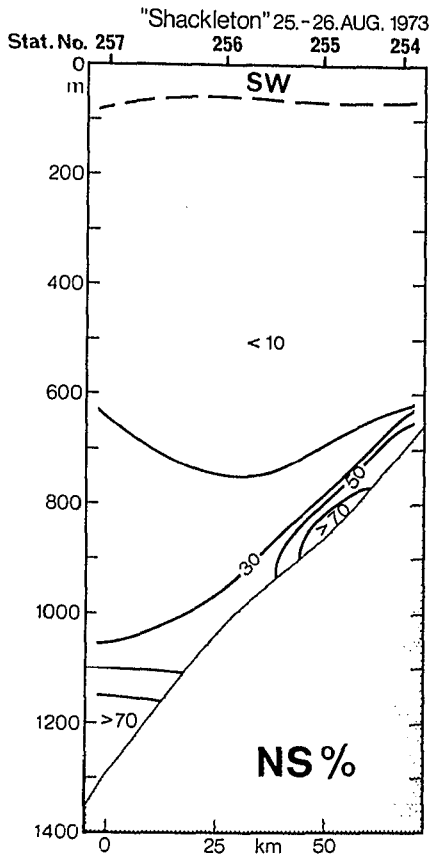

"Shackleton" 28-29 AUG. 1973  
Stat. No. 286 284 282 280 278 279

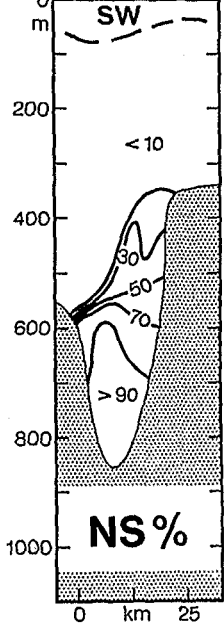

"Shackleton" 2.-3. SEP 1973  
Stat. No. 293 292 291 290 289 288 287

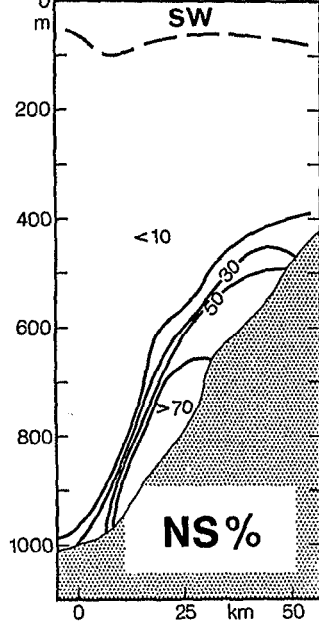

"Shackleton" 3.-4. SEP 1973  
Stat. No. 298 296 295 294

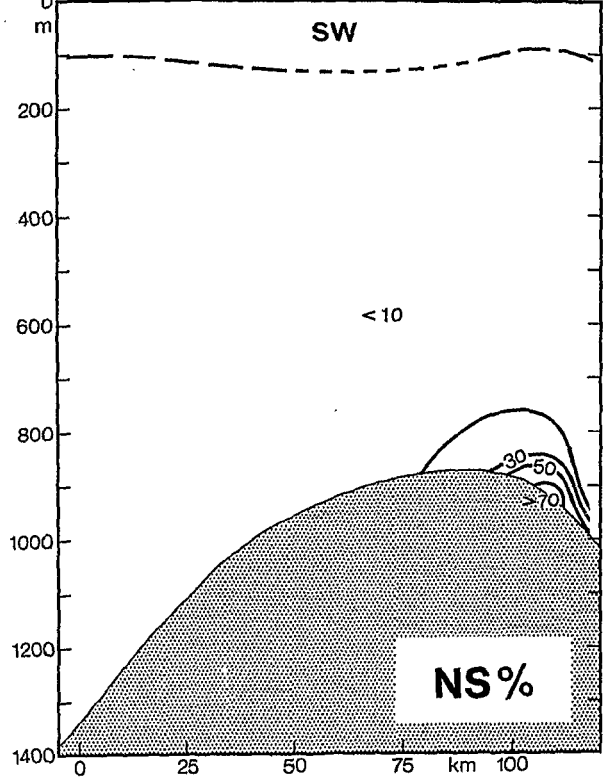

"Shackleton" 28-29 AUG. 1973  
Stat. No. 286 284 282 280 278 279

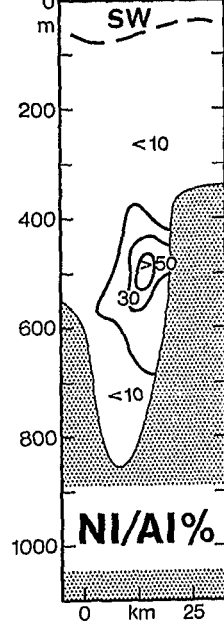

"Shackleton" 2.-3. SEP 1973  
Stat. No. 293 292 291 290 289 288 287

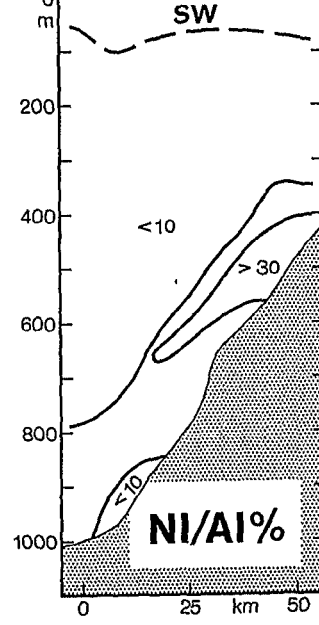

6.7 Boris Davydov

Both sections run parallel to the crest of the Iceland-Faroe ridge. Southwest of the ridge (Stat. 1 - 29) MNA, NI/AI and NS were analysed. IS is found in the Atlantic basin. In the eastern part of the northern section (Stat. 30 - 61) EIW and EIC were also observed.

Remark: Many stations have been calibrated for salinity using NS as reference.

<u>Section</u>	<u>Stat.No.</u>	<u>Mixing triangle (see table 3)</u>
1 - 29	1 - 3	4
	4 - 9	2
	10 - 16	4
	17 - 19	2
	20 - 29	4
30 - 61	30 - 32	7, 8
	33	4, 5, 8
	34	7, 8
	35	5, 8
	36	4, 5
	37	7, 8
	38	4, 5, 8
	39	5, 8
	40, 41	5, 8
	42	4, 5, 8
	43, 44	4, 5
	45 - 61	4

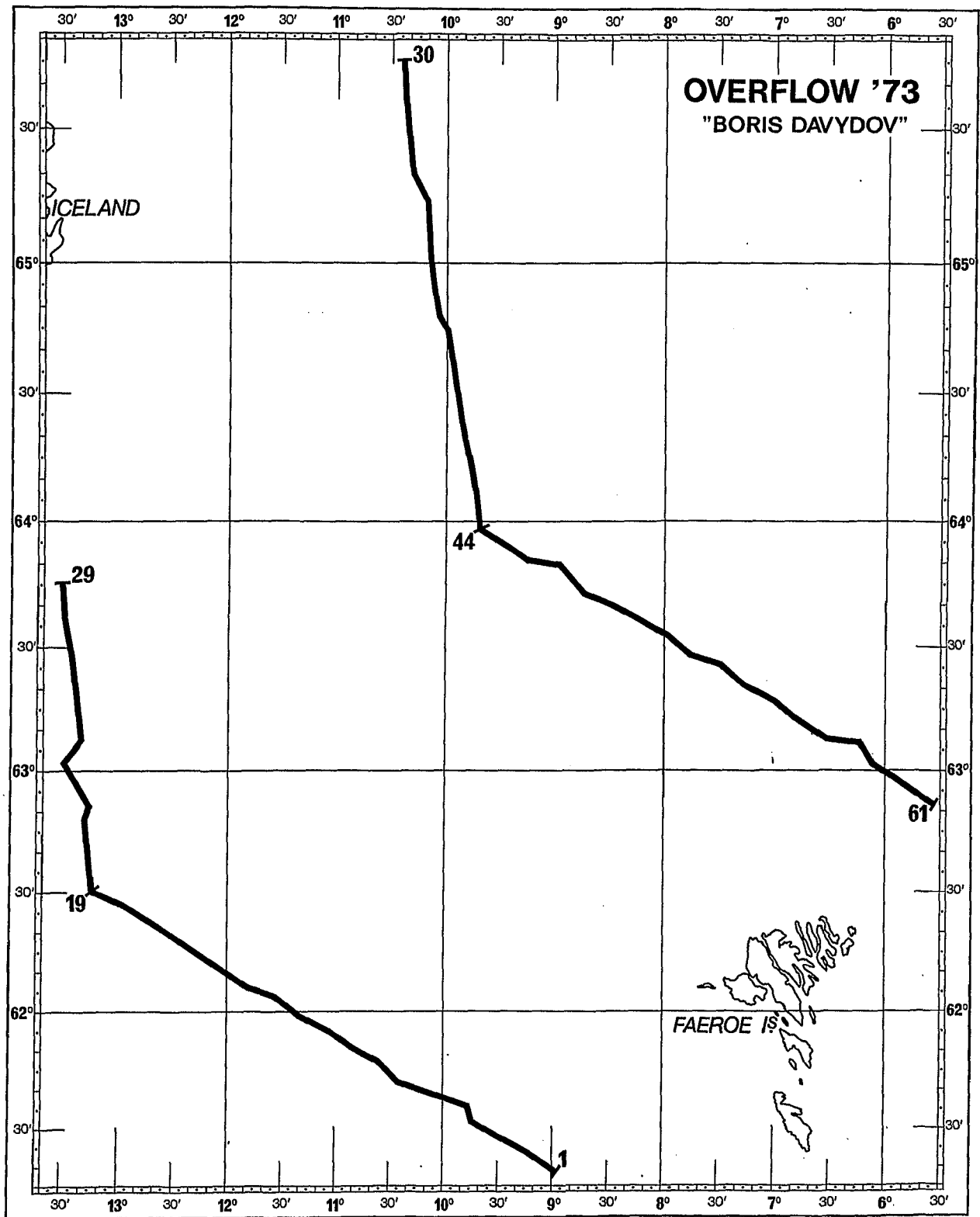

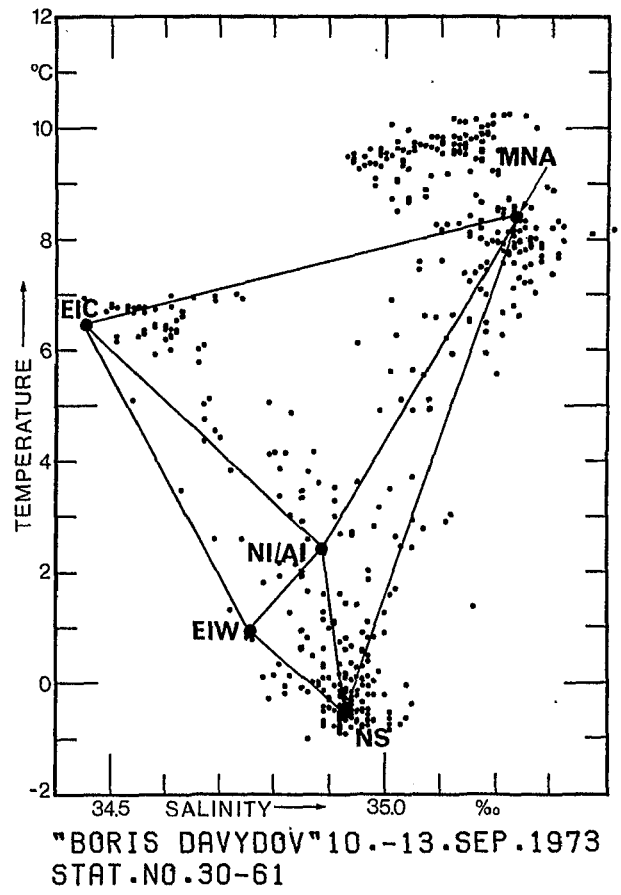
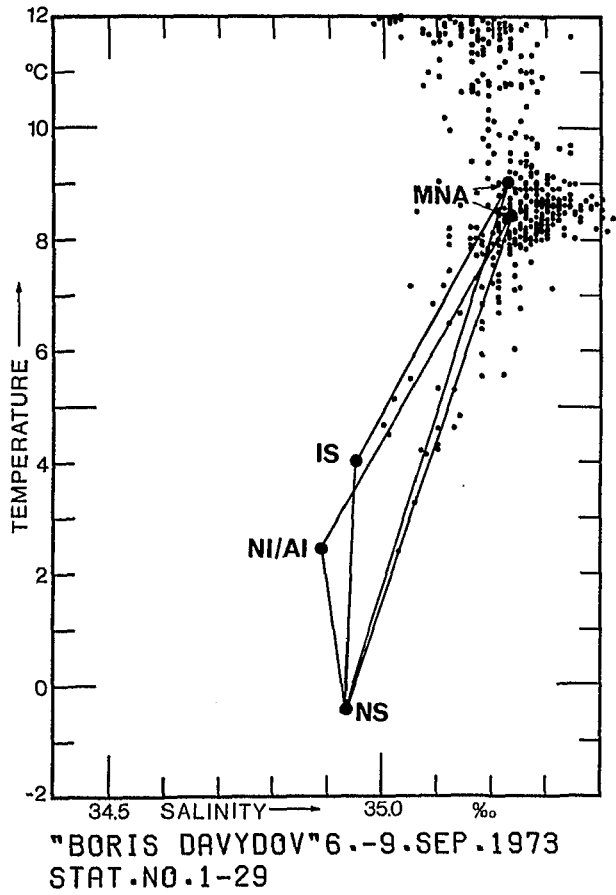



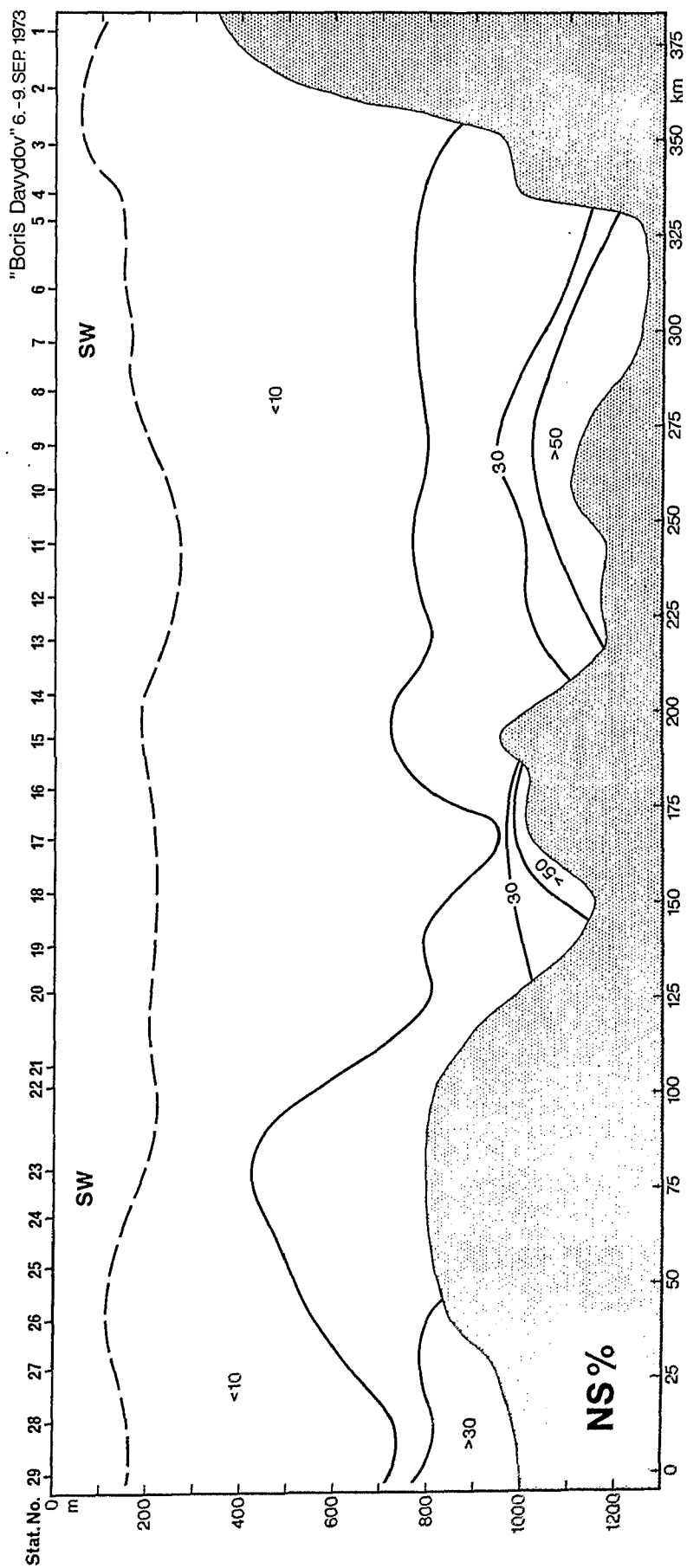

"Boris Davydov" 10.-13. SEP 1973

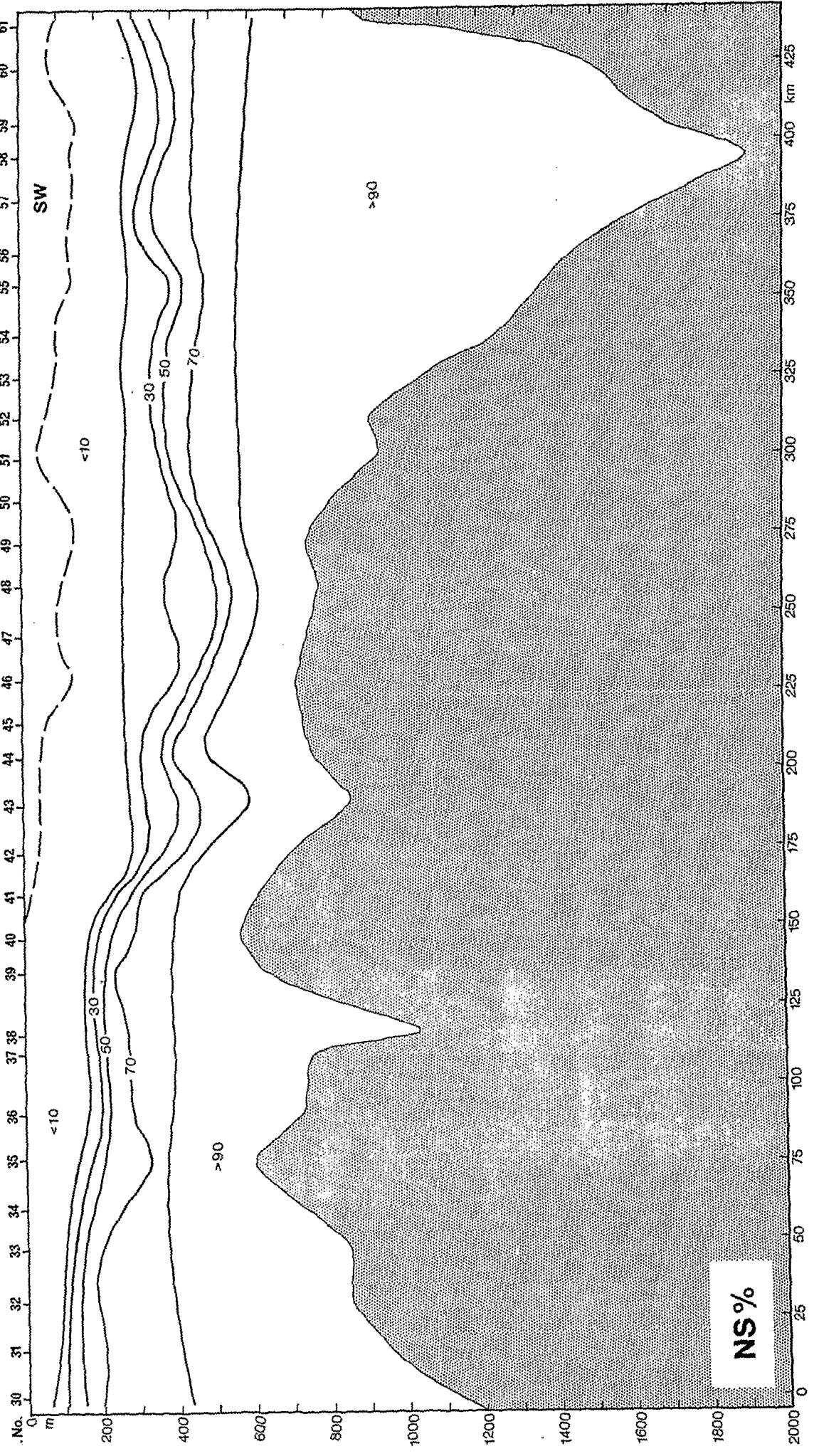

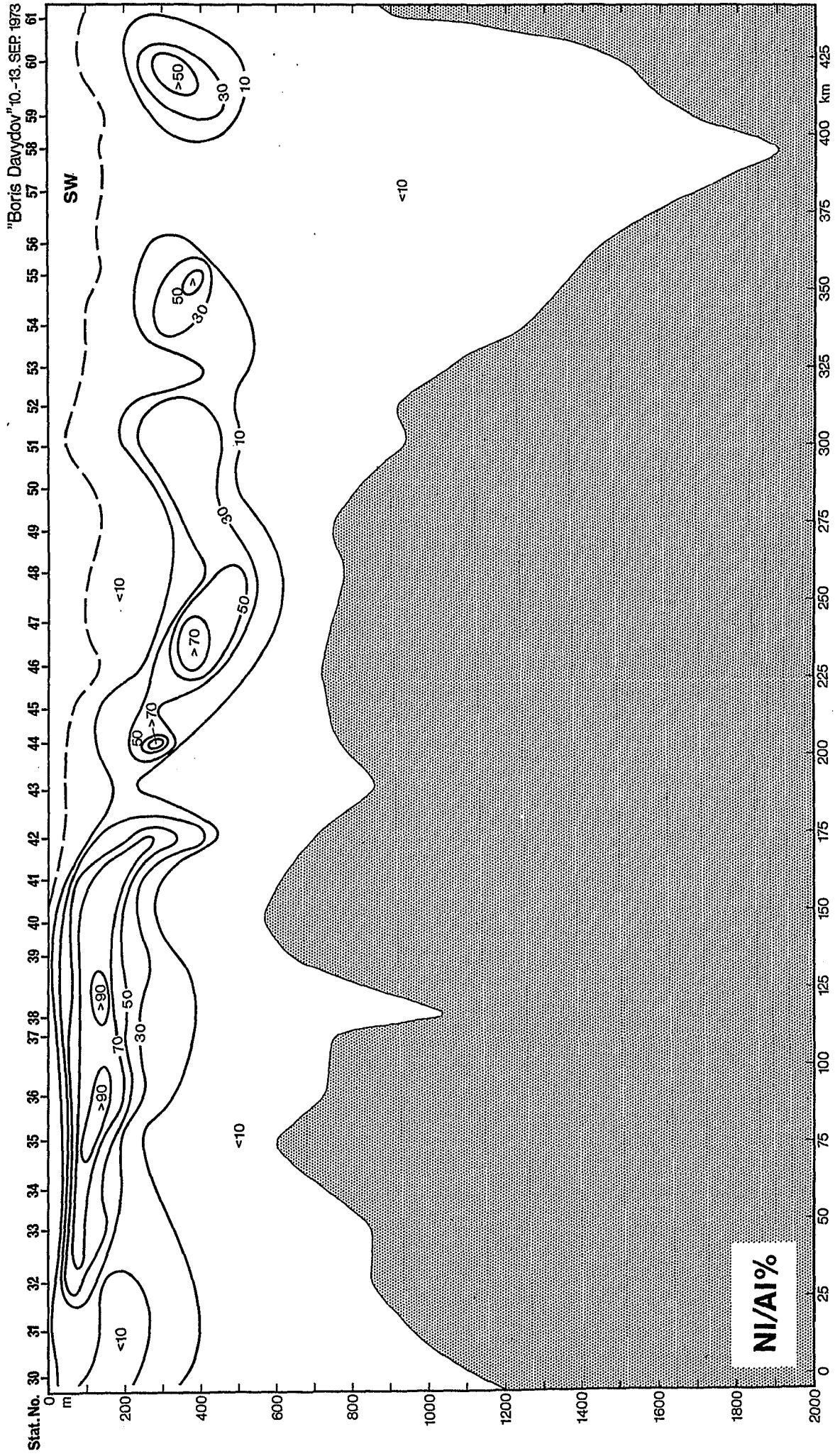

"Boris Davydov" 10.-13. SEP. 1973

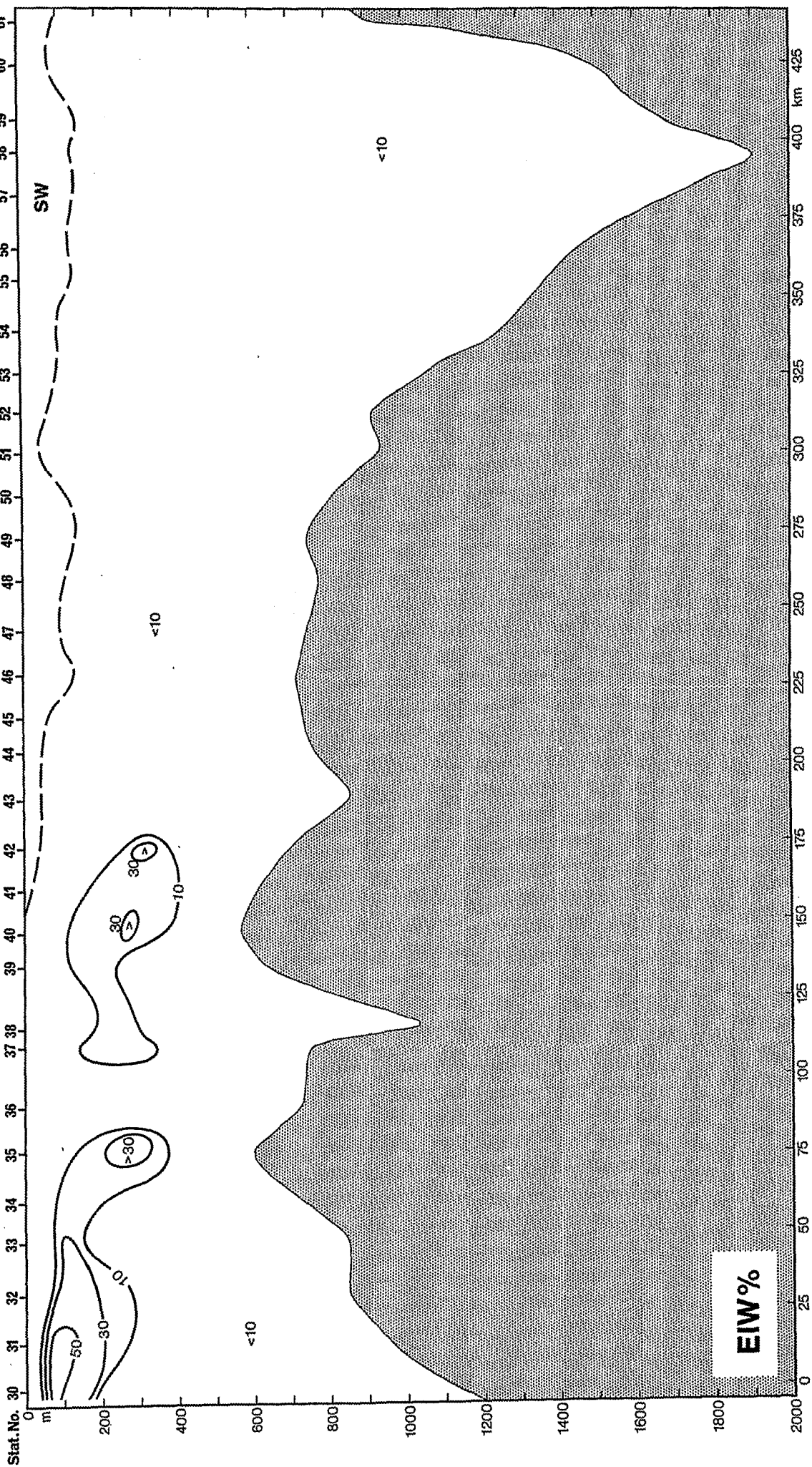

6.8 Meteor

Sections were run across the central part of the Iceland-Faroe-Ridge and parallel to it's crest. Thus all water masses of this area have been observed. They show a rather complicated horizontal structure of overflow waters. Besides NI/AI and NS, isolated amounts of EIW and EIC were found at single stations.

<u>Section</u>	<u>Stat.No.</u>	<u>Mixing triangle (see table 3)</u>
39 - 52	39, 41	4, 8
	42 - 50	4
	51, 52	1
<hr/>		
66 - 90		4
<hr/>		
169 - 181	169, 170	2
	171 - 176	4
	177 - 179	4, 5
	180	4, 5, 8
	181	5, 8
<hr/>		
182 - 202	182	4, 5
	183 - 188	4
	189	4, 5
	190, 191	4
	192, 193	4, 5
	194 - 202	4
<hr/>		
254 - 283	254	4, 5
	260	4, 5, 8
	262	5, 8
	264 - 274	4, 5
	277, 280, 283	2
<hr/>		
297 - 308	297 - 299	4, 5
	300	4, 5, 8
	301	4, 5
	302 - 308	4

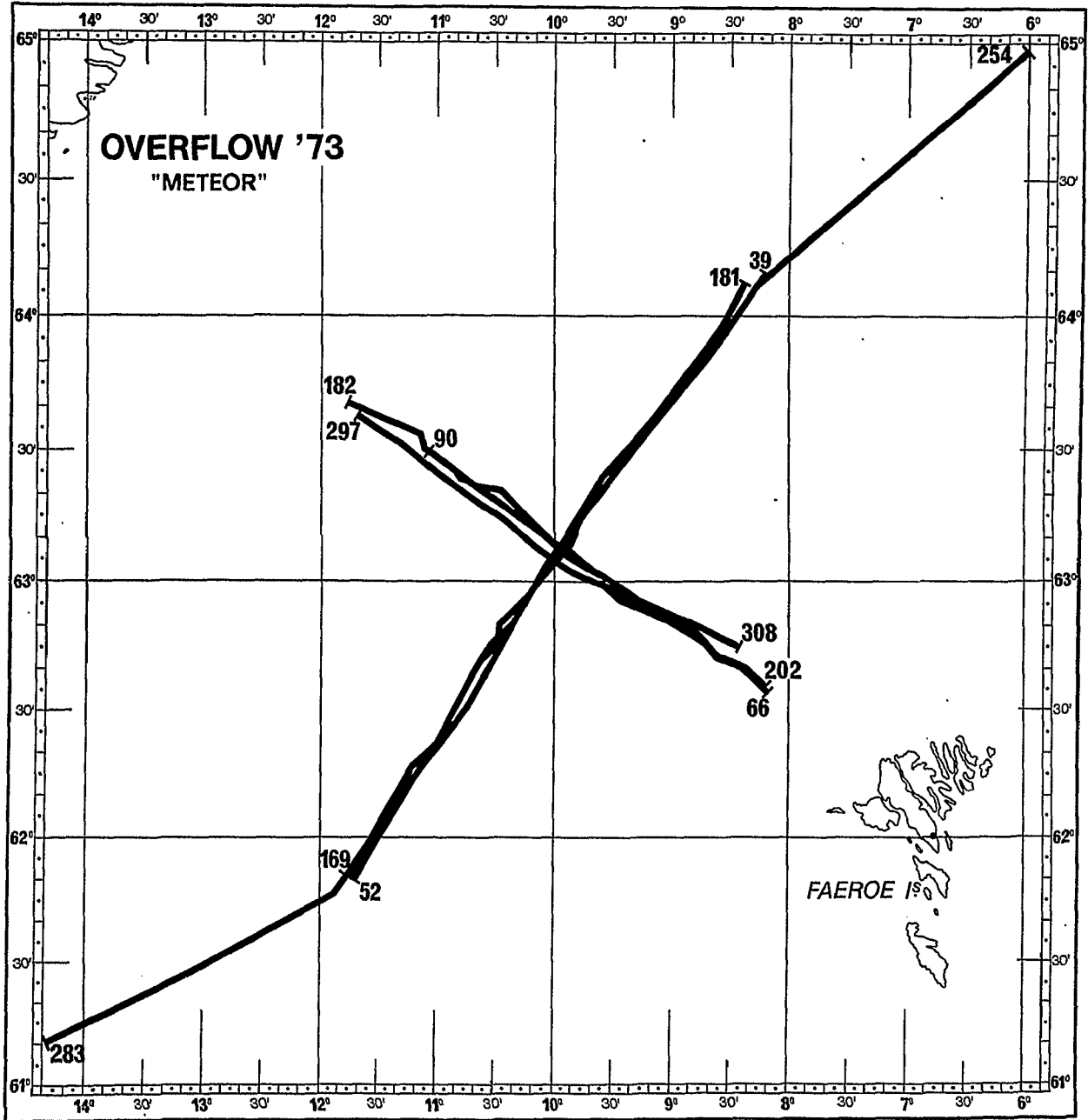

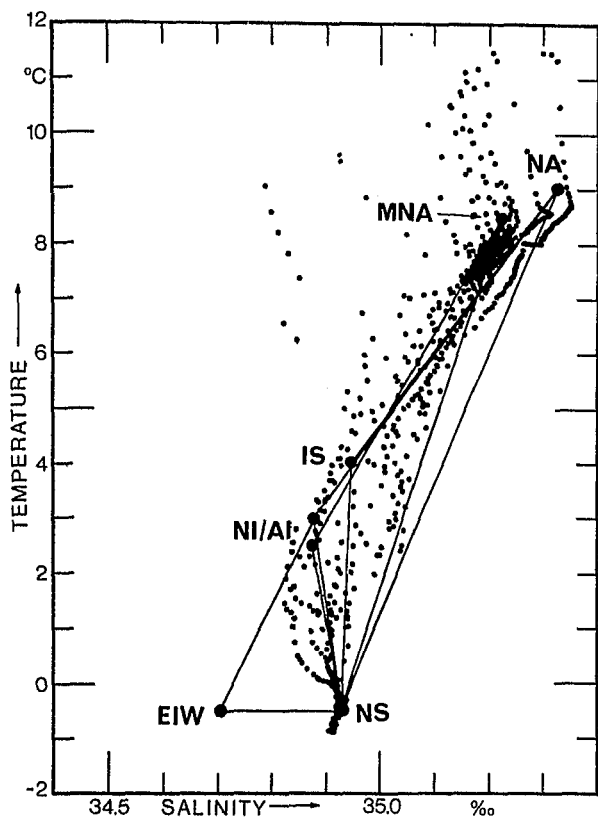

"METEOR" 16.-17. AUG. 1973  
STAT. NO. 39, 41 -52

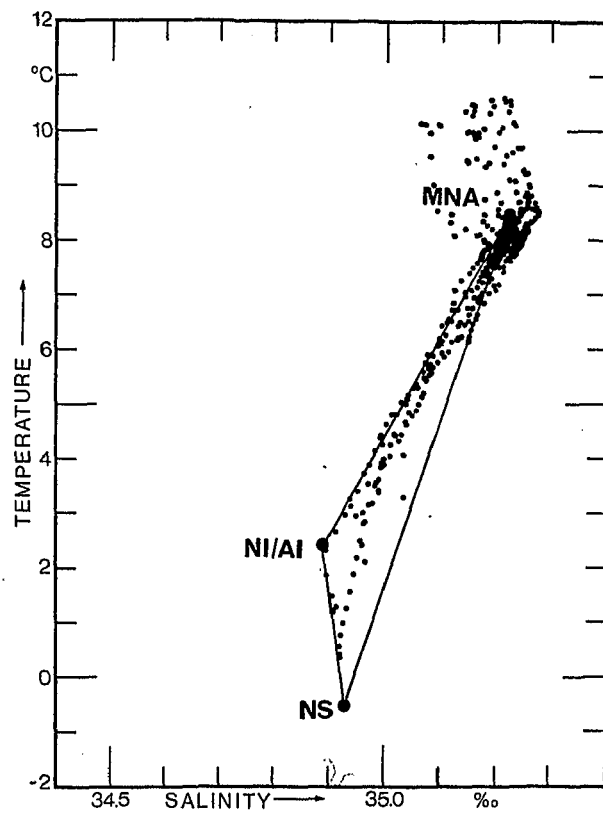

"METEOR" 18.-19. AUG. 1973  
STAT. NO. 66, 68, 70, 72, 74, 75, 77, 79,  
86, 88, 90

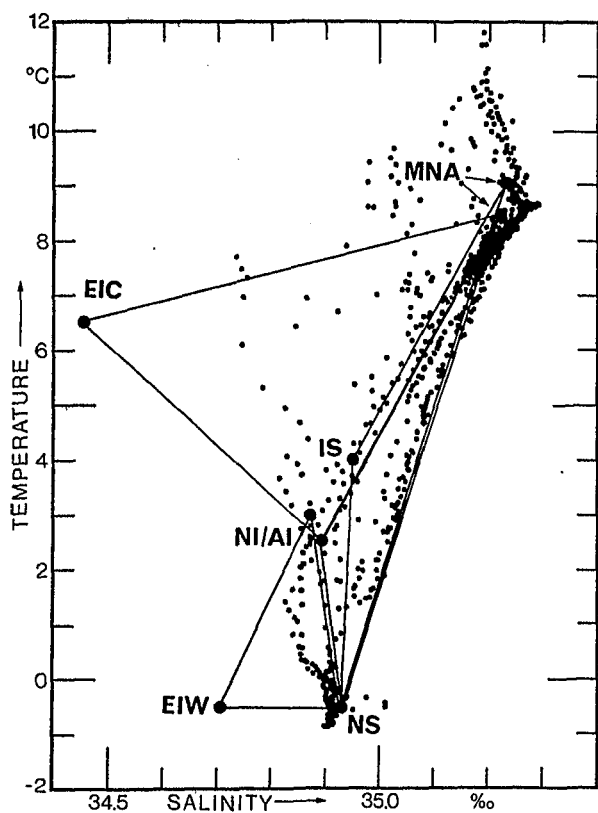

"METEOR" 24.-26. AUG. 1973  
STAT. NO. 169-181

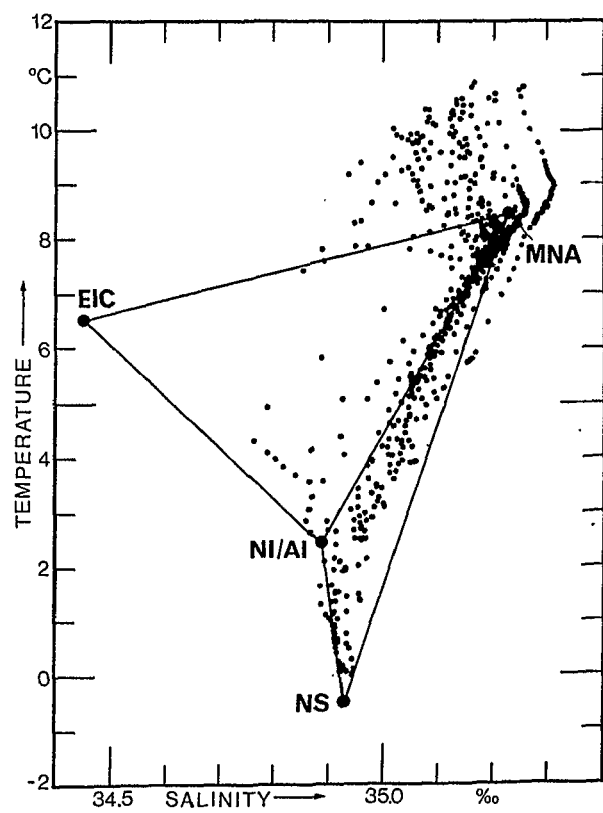

"METEOR" 26.-28. AUG. 1973  
STAT. NO. 182-202, 184a, 189a

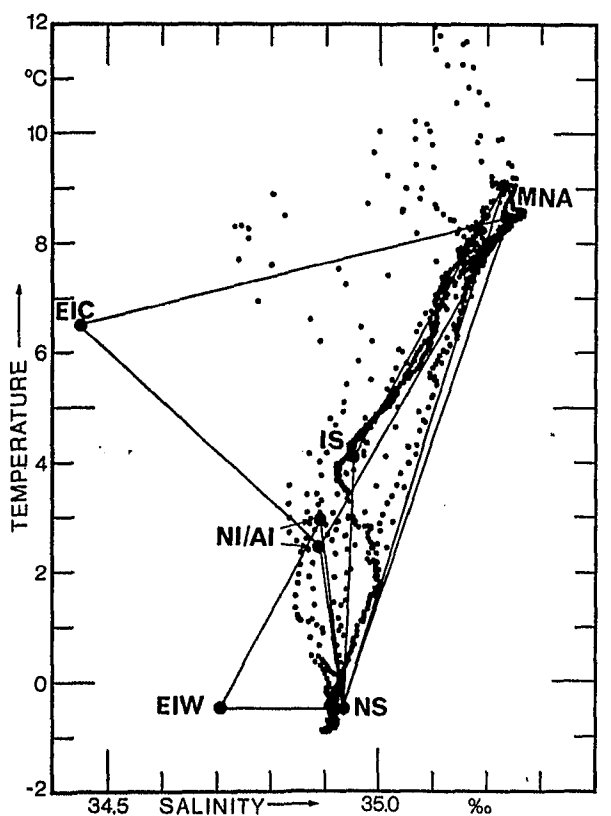

"METEOR" 4.-8. SEP. 1973  
 STAT. NO. 254, 260, 262, 264, 268, 270,  
 272, 274, 277, 280, 283

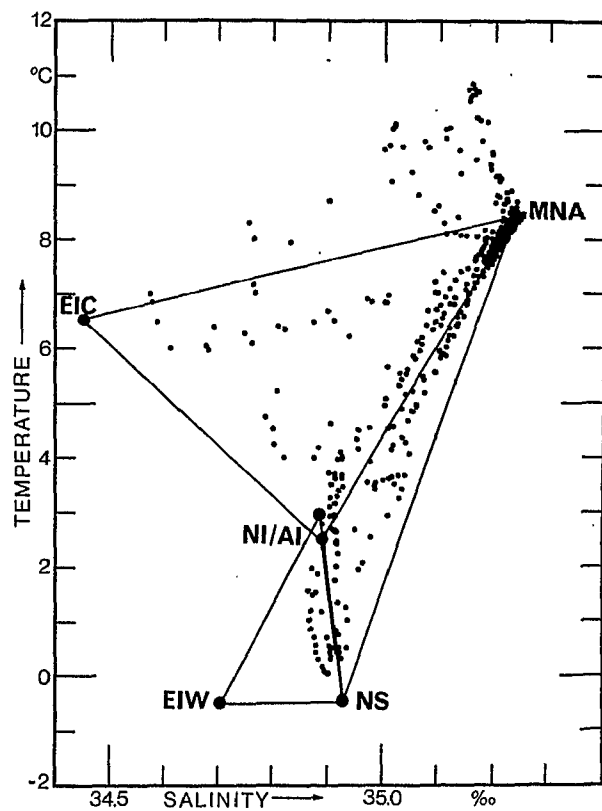

"METEOR" 10.-11. SEP. 1973  
 STAT. NO. 297-302, 304-308



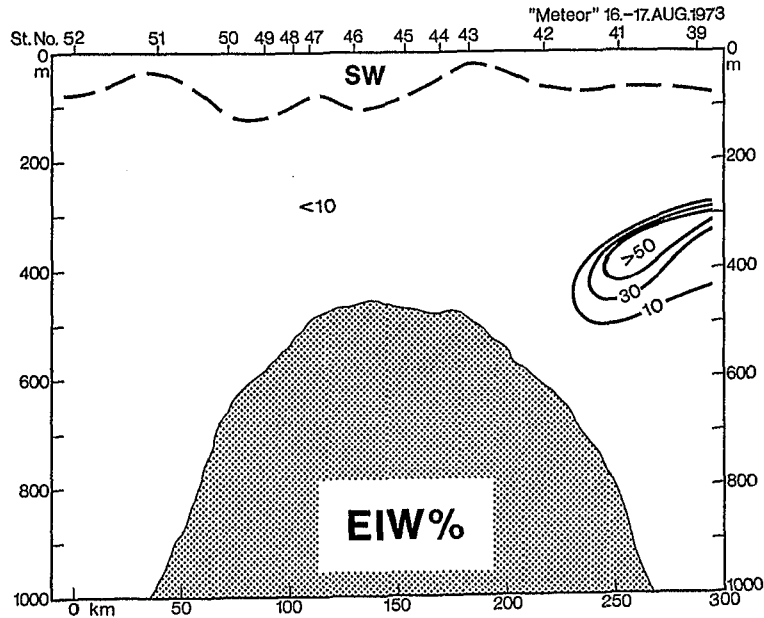
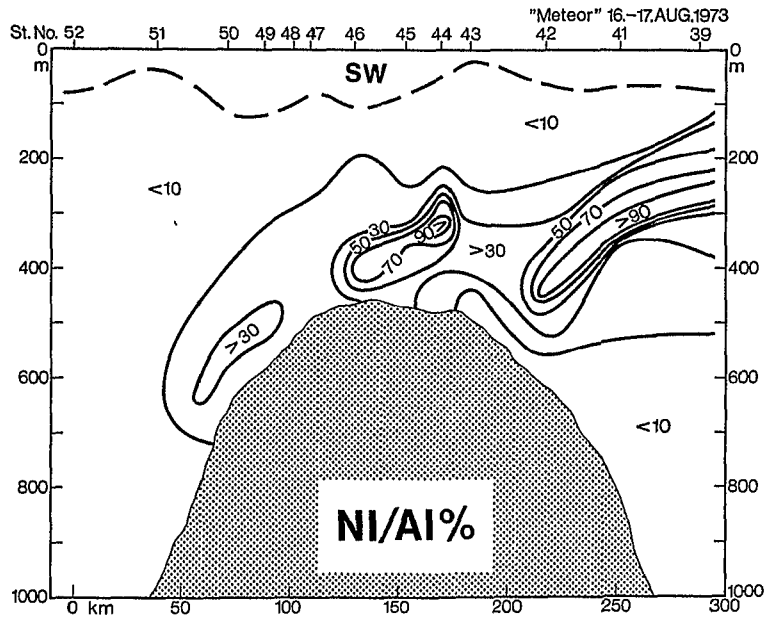
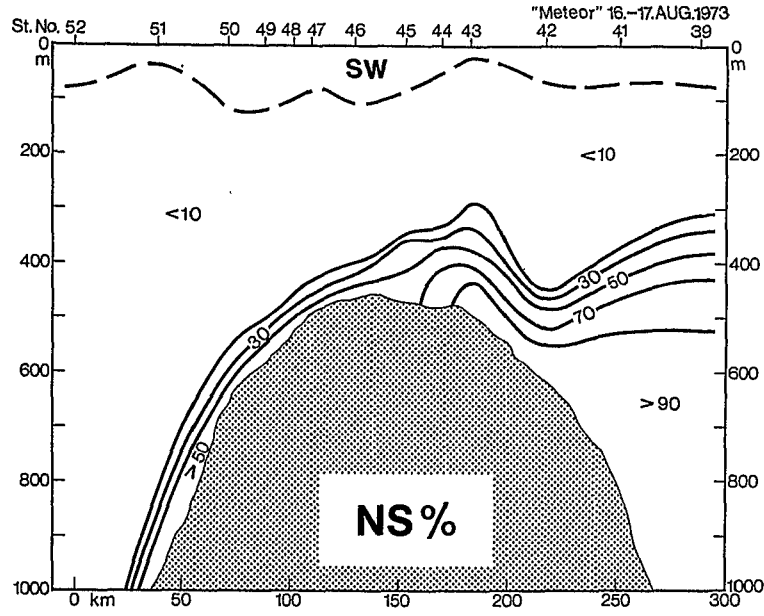

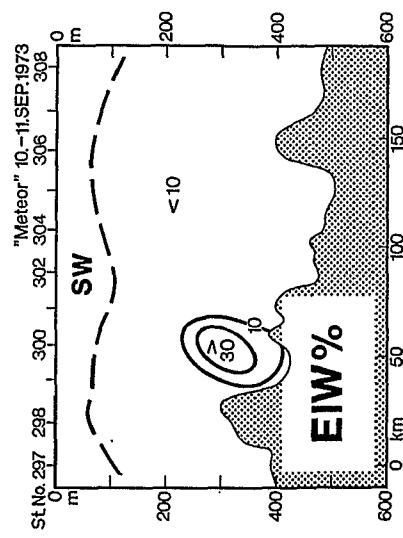
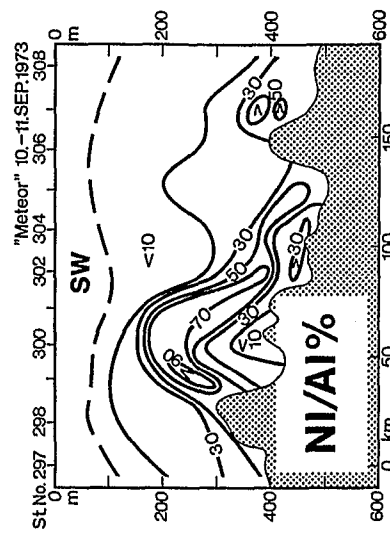
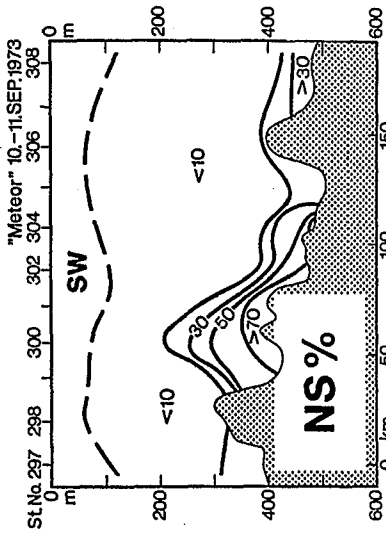
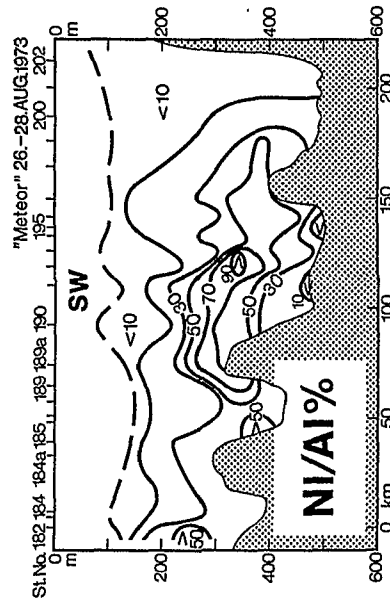
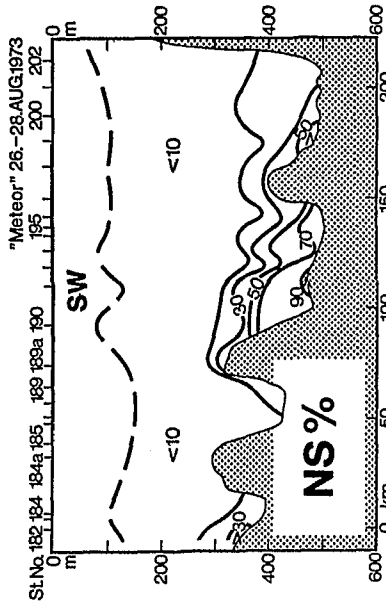
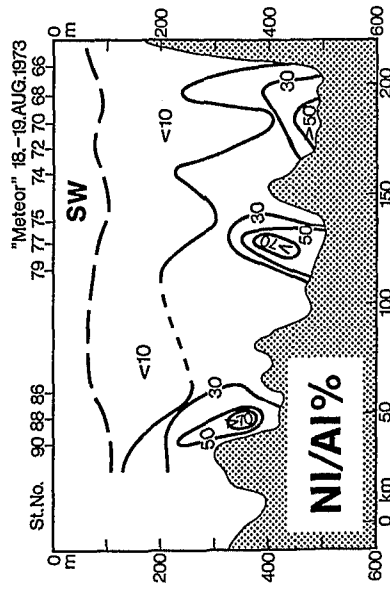
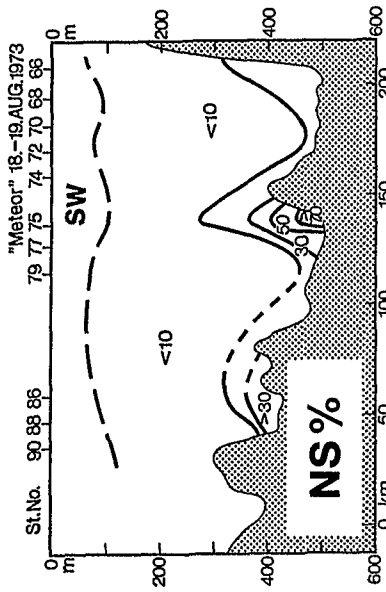

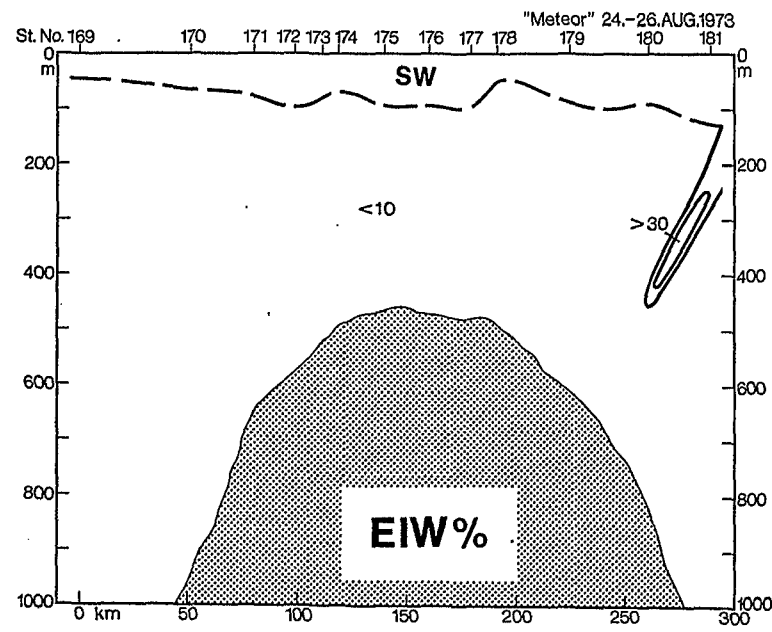
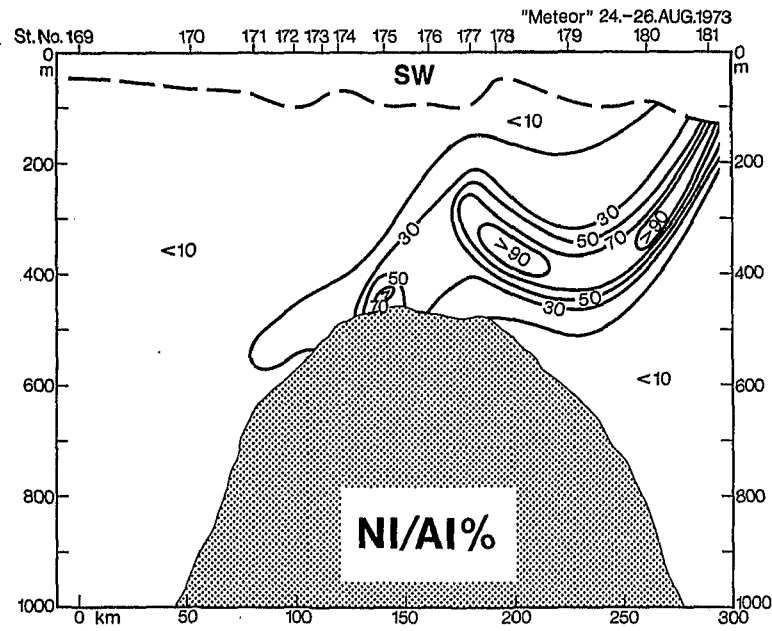
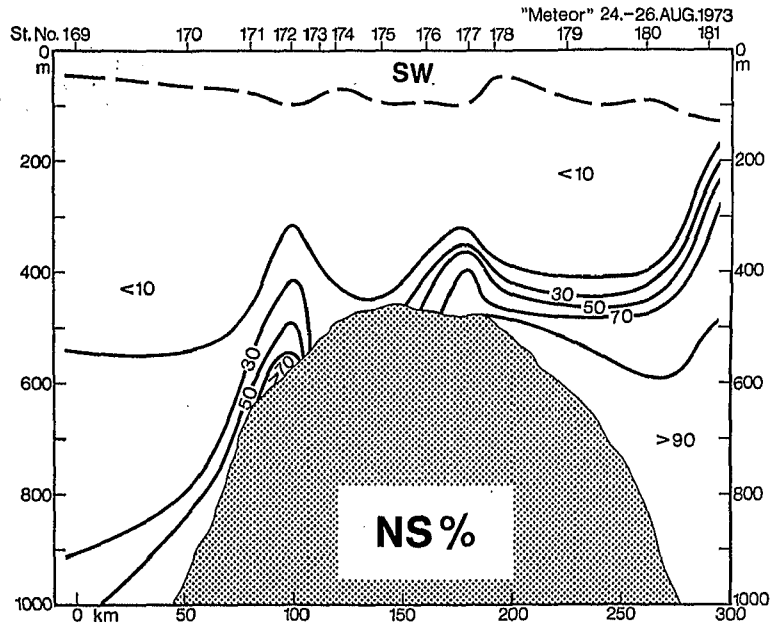

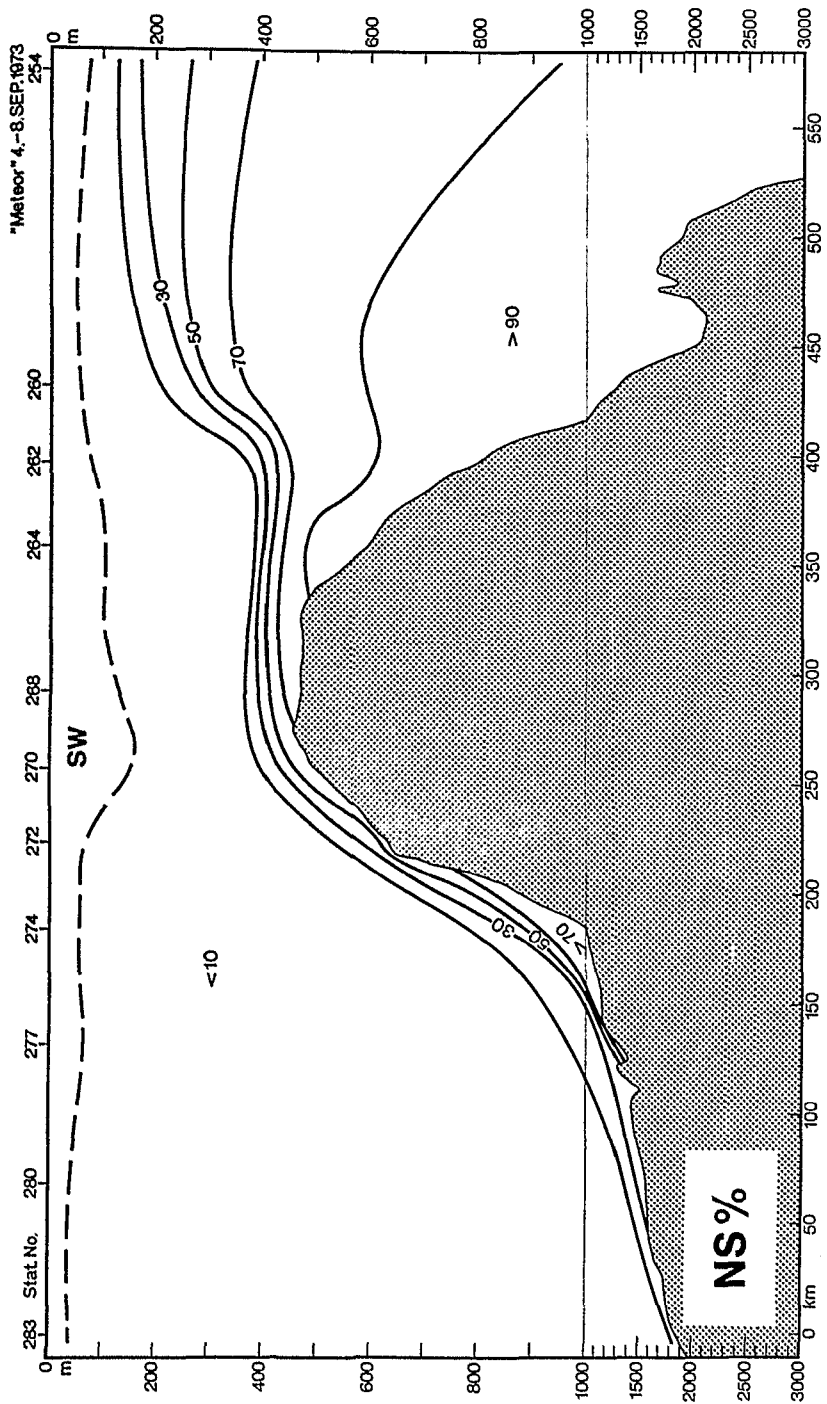

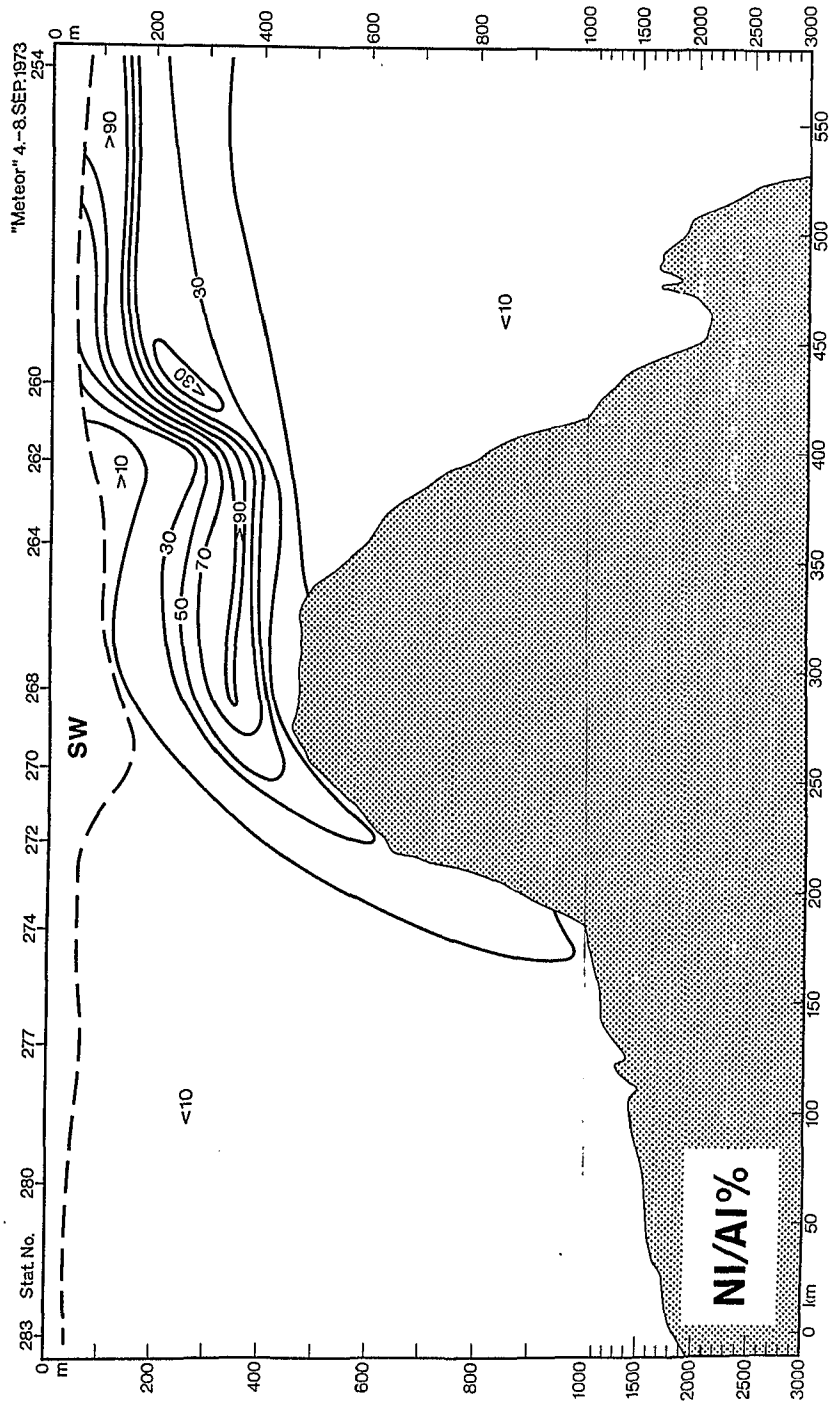

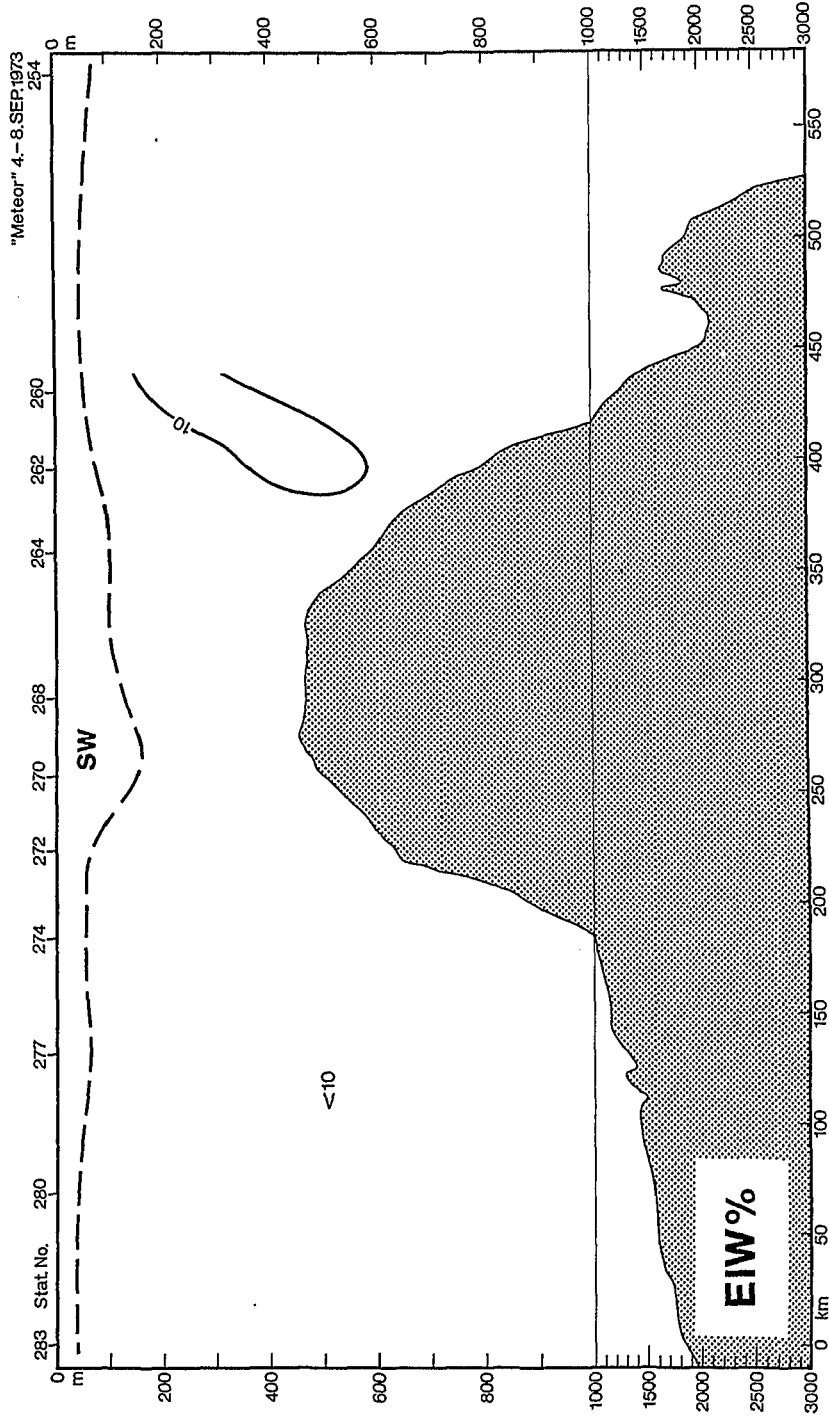

6.9 Bj. Saemundsson

The boundary between the North Atlantic water and the East-Icelandic Current is often crossed by the sections. Thus MNA, EIC, NS, NI/AI and EIW are found. From stations 354 to 358 the amount of NI/AI is less 10 %.

Section	Stat.No.	Mixing triangle (see table 3)
271 - 275	271 - 272	5
	273 - 275	6
277 - 281	277 - 280	6
	281	5
283 - 287	283, 284	5
	285 - 287	5, 7, 8
288 - 294	288, 289	5
	290, 291	5, 7
	292, 293	7
	294	5
307 - 313	307 - 309	2
	310 - 313	5
314 - 317		2
317 - 323		2
323 - 326		2
327 - 332	327 - 329	5, 7
	330 - 332	7, 8
333 - 339	333 - 335	4, 5
	336	5, 8
	337 - 339	5
340 - 346	340 - 343	5
	344 - 346	4
350 - 358	350 - 353	2
	354 - 358	5

## 6.9 (cont'd)

Section	Stat.No.	Mixing triangle (see table 3)
359 - 364	359	7
	360	5
	361	7
	362 - 364	4, 8
365 - 369		4



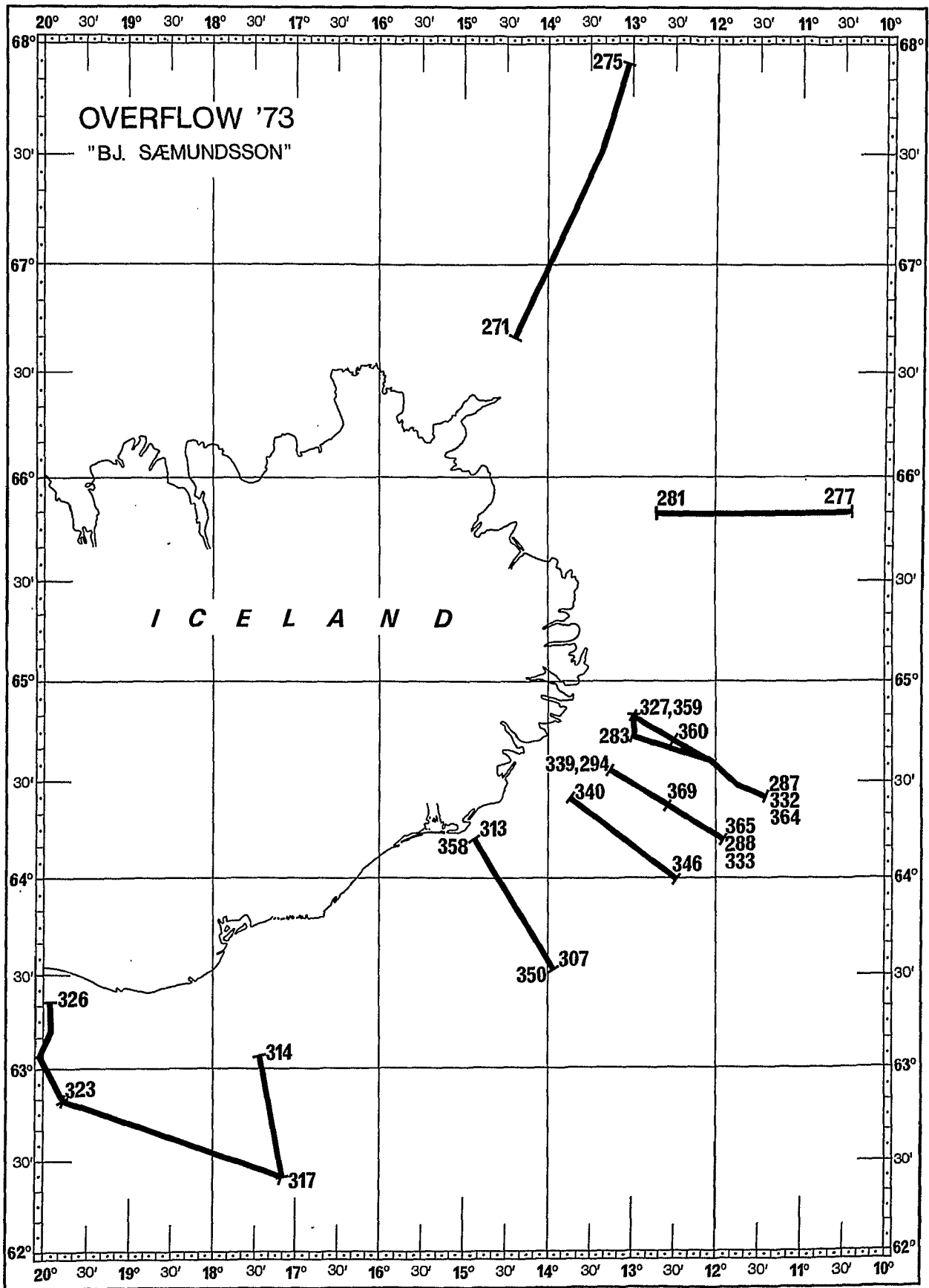

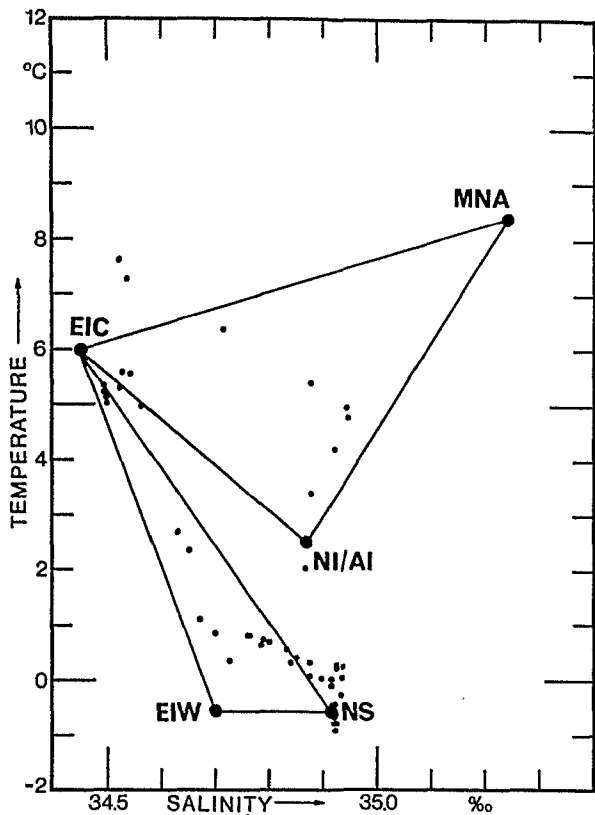

"BJARNI SAEMUNDSSON"  
16.AUG.1973  
STAT.NO.271-275

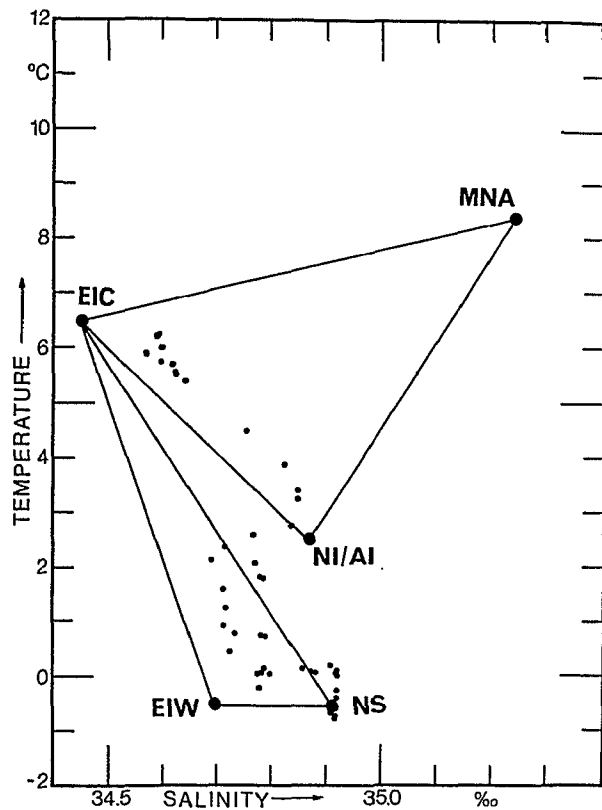

"BJARNI SAEMUNDSSON"  
17.-18.AUG.1973  
STAT.NO.277-281

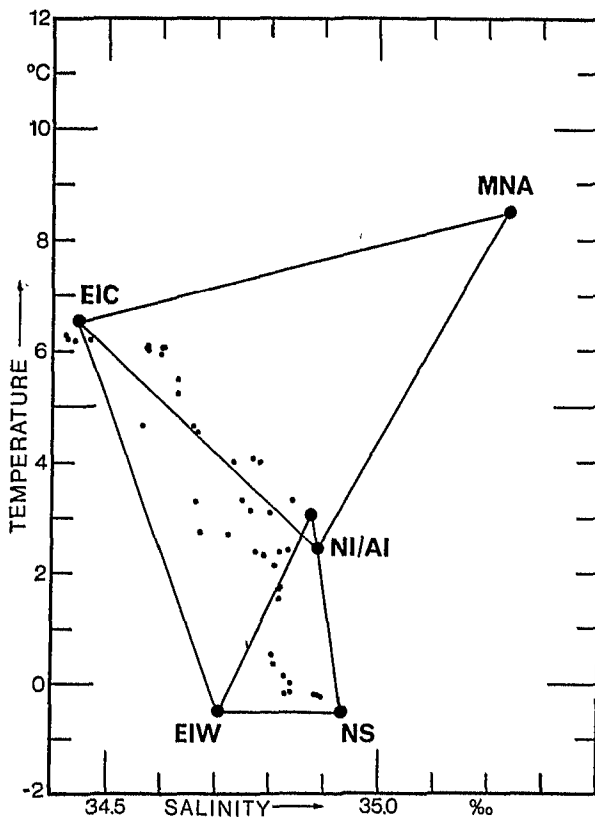

"BJARNI SAEMUNDSSON"  
19.-20.AUG.1973  
STAT.NO.283-287

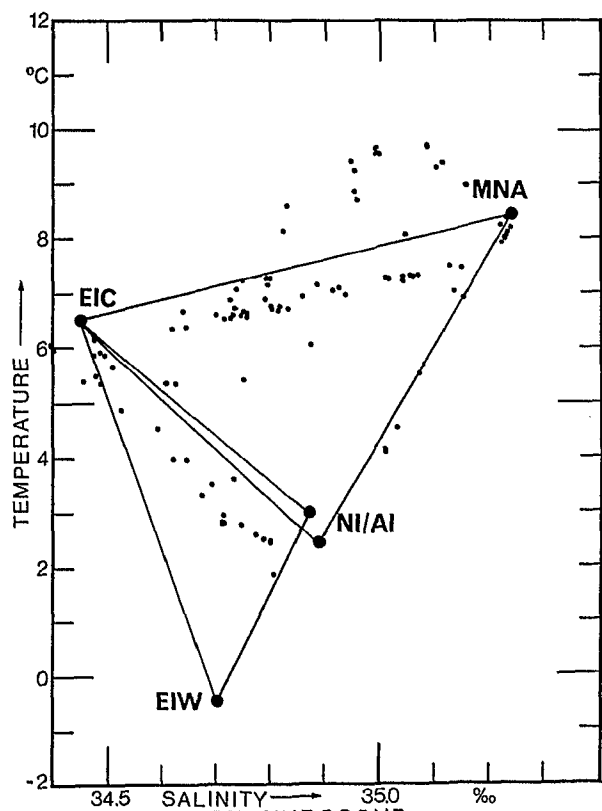

"BJARNI SAEMUNDSSON"  
20.AUG.1973  
STAT.NO.288-294

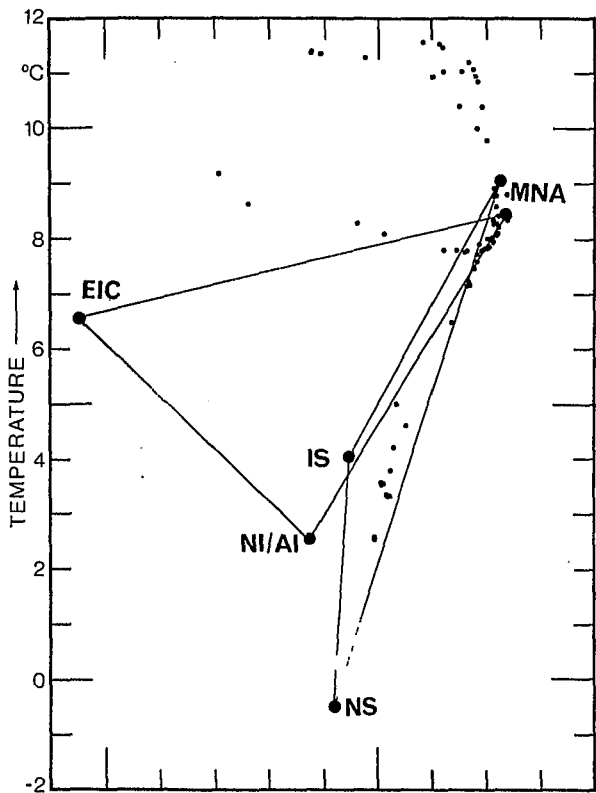

"BJARNI SAEMUNDSSON"  
23.AUG.1973  
STAT.NO.307-313

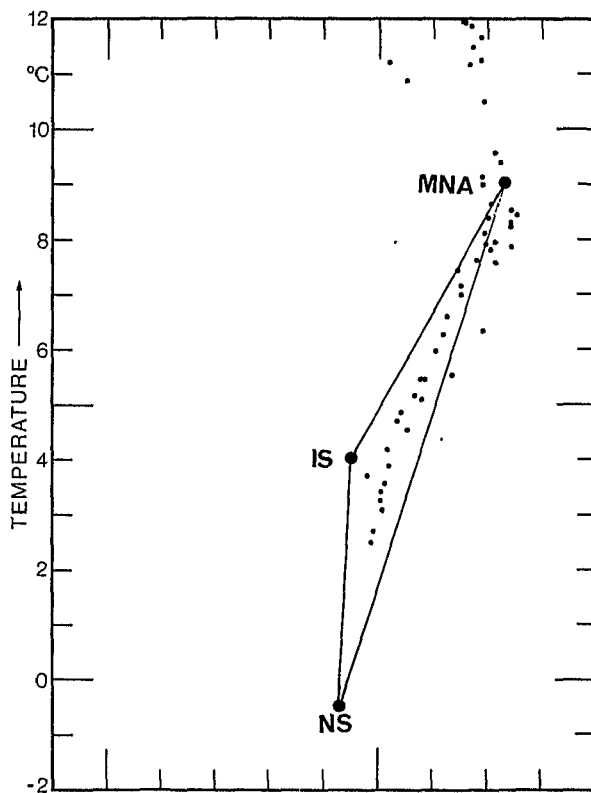

"BJARNI SAEMUNDSSON"  
24.AUG.1973  
STAT.NO.314-317

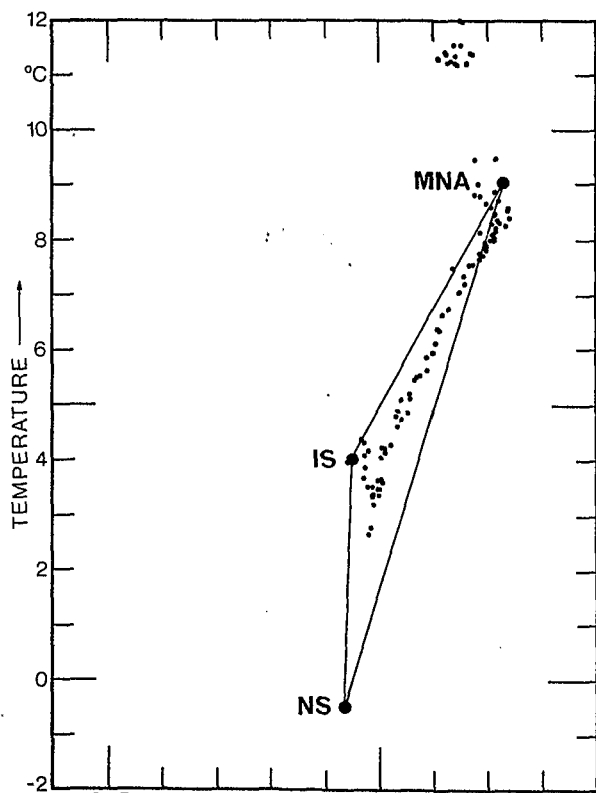

"BJARNI SAEMUNDSSON"  
24.-25.AUG.1973  
STAT.NO.317-323

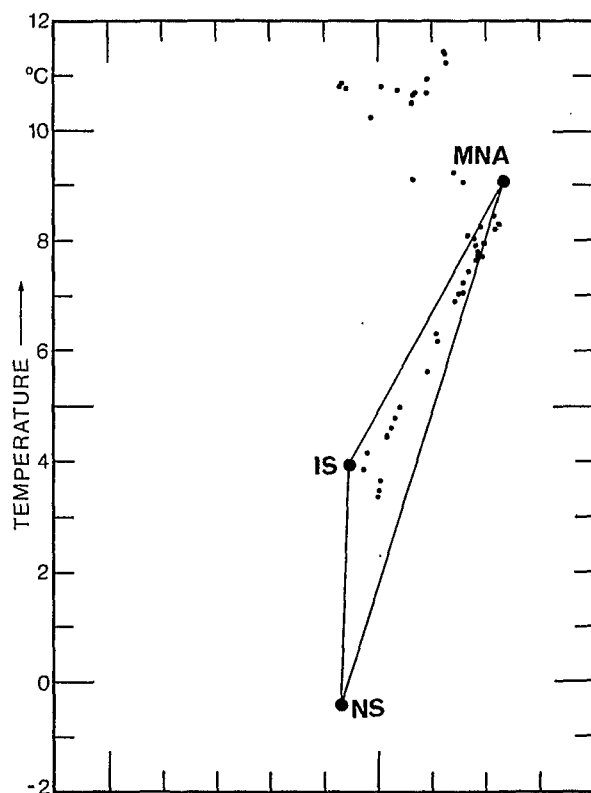

"BJARNI SAEMUNDSSON"  
25.AUG.1973  
STAT.NO.323-326

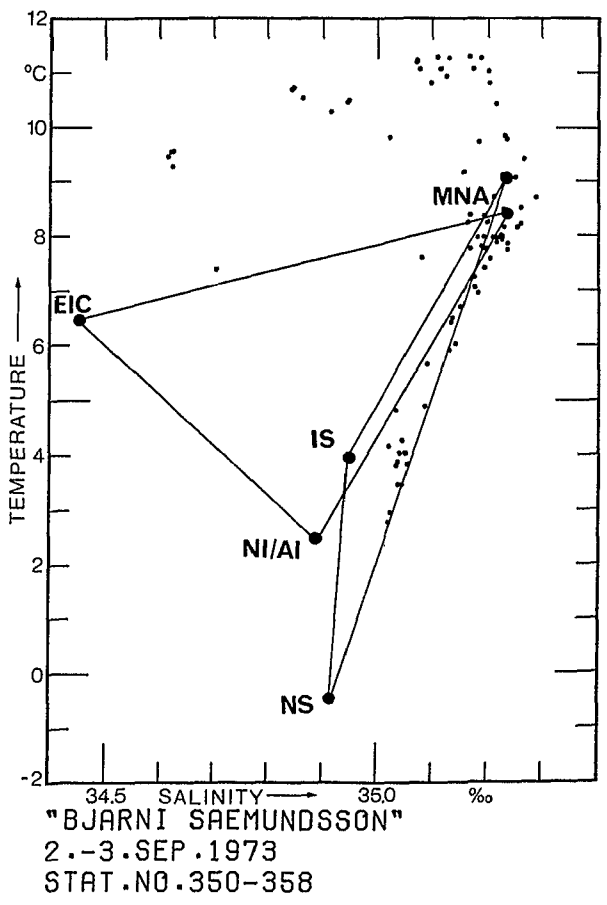
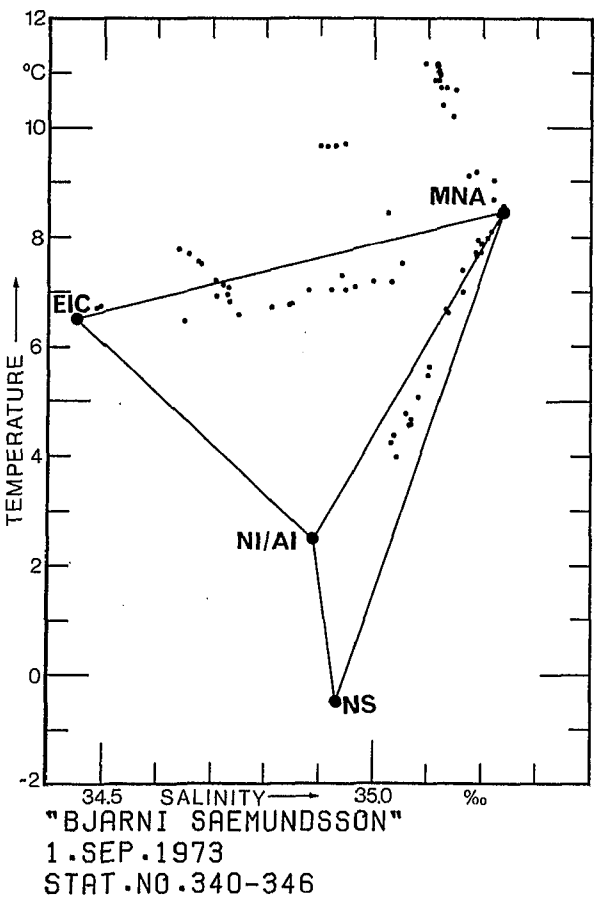
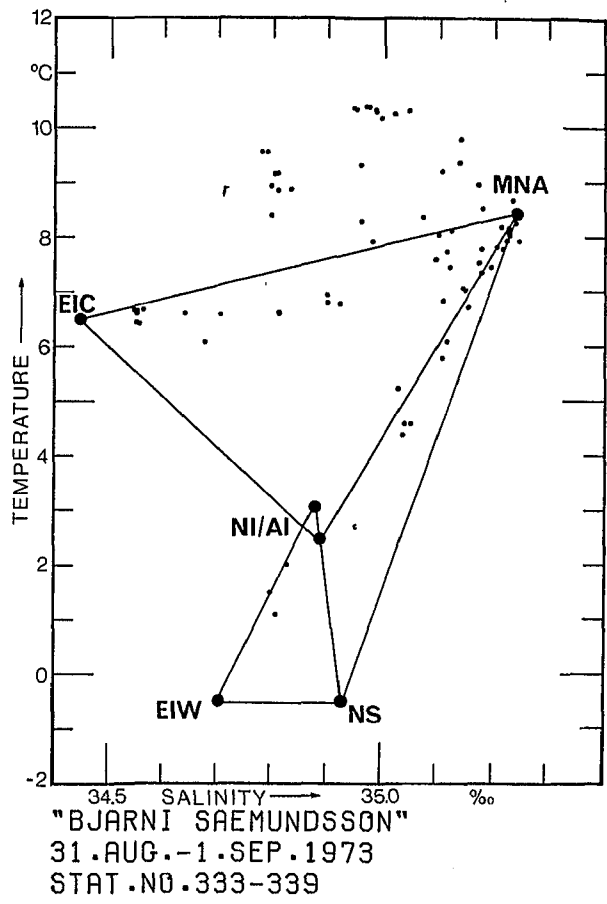
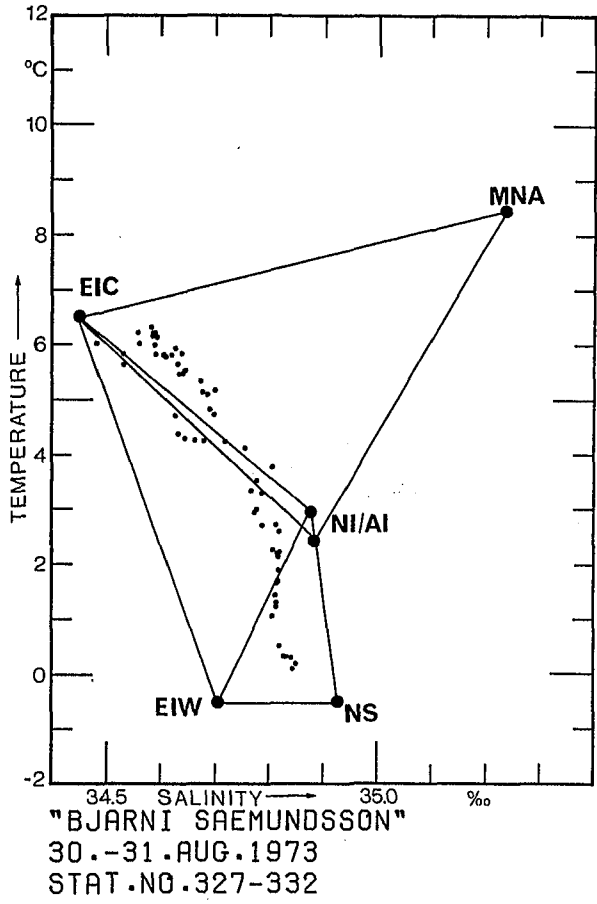

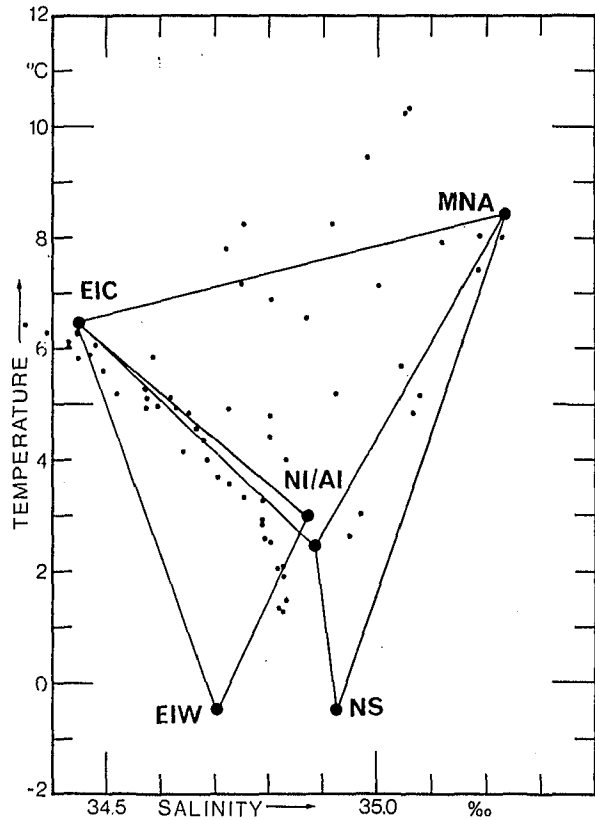

"BJARNI SAEMUNDSSON"  
4.SEP.1973  
STAT.NO.359-364

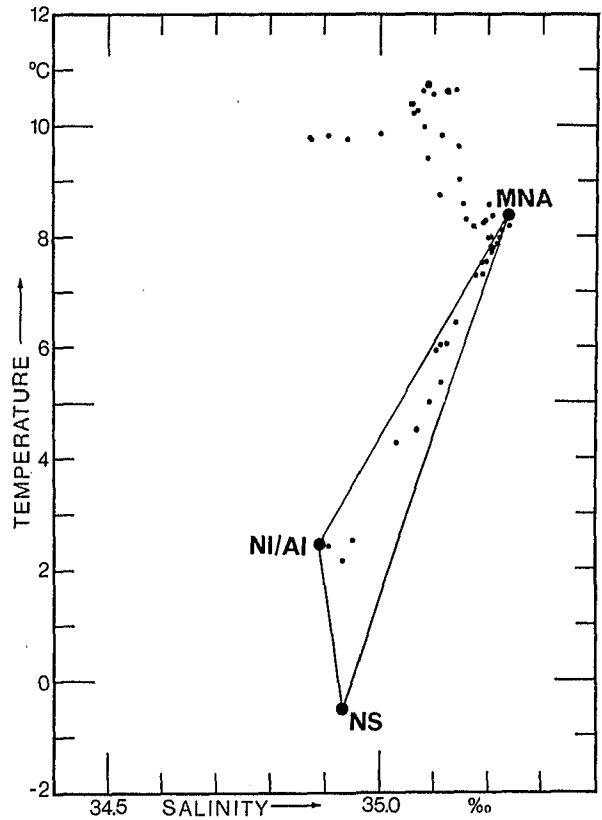

"BJARNI SAEMUNDSSON"  
4.-5.SEP.1973  
STAT.NO.365-369

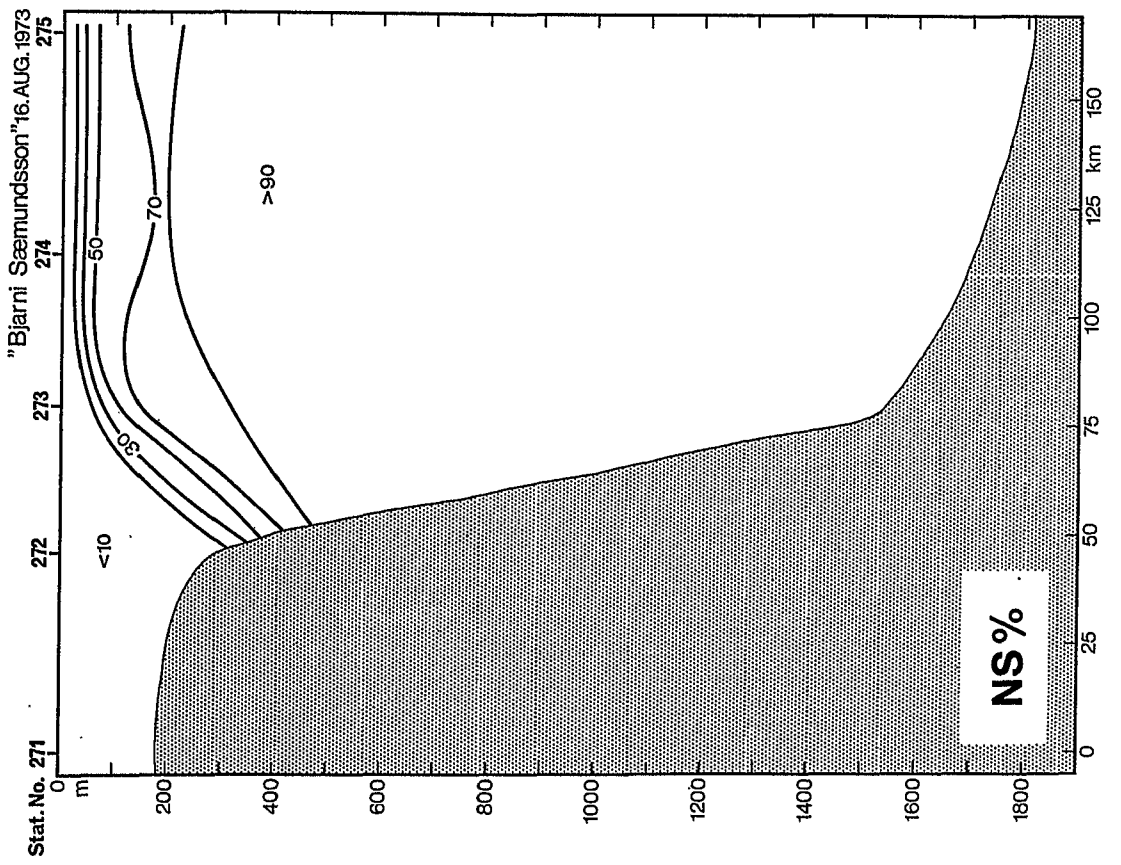
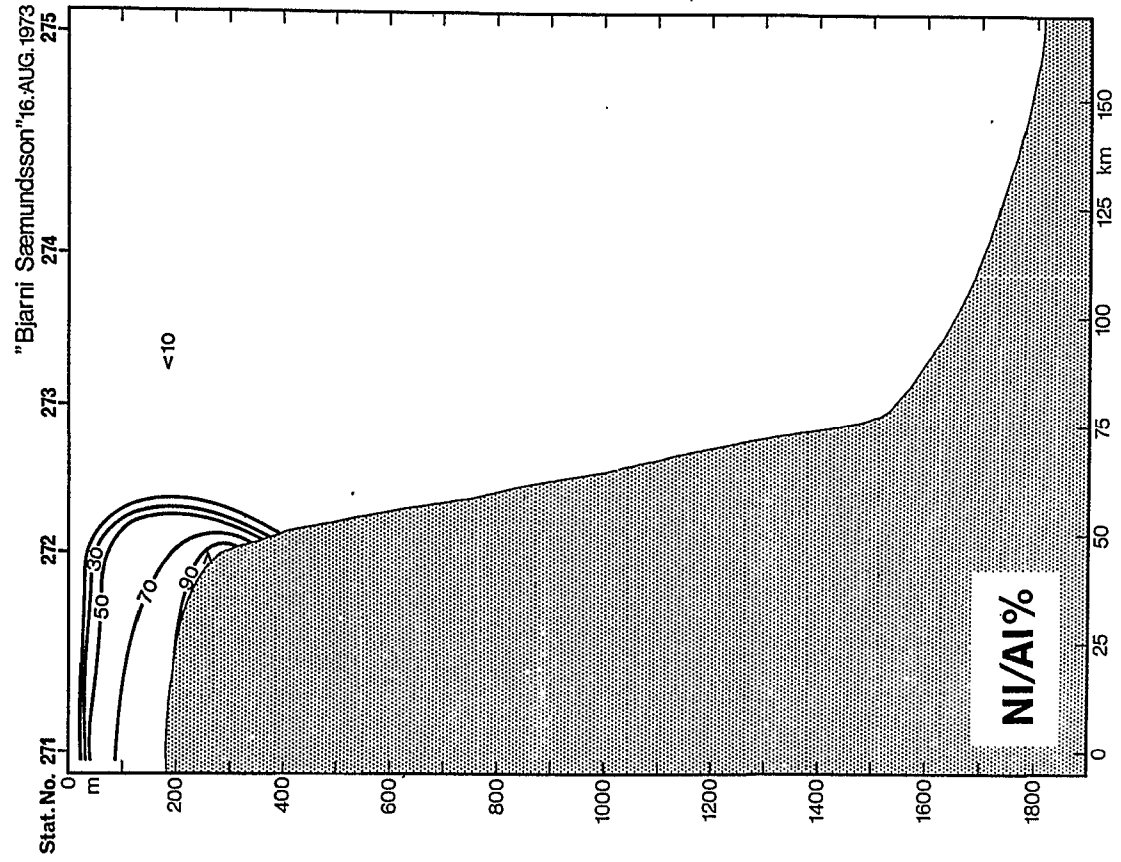

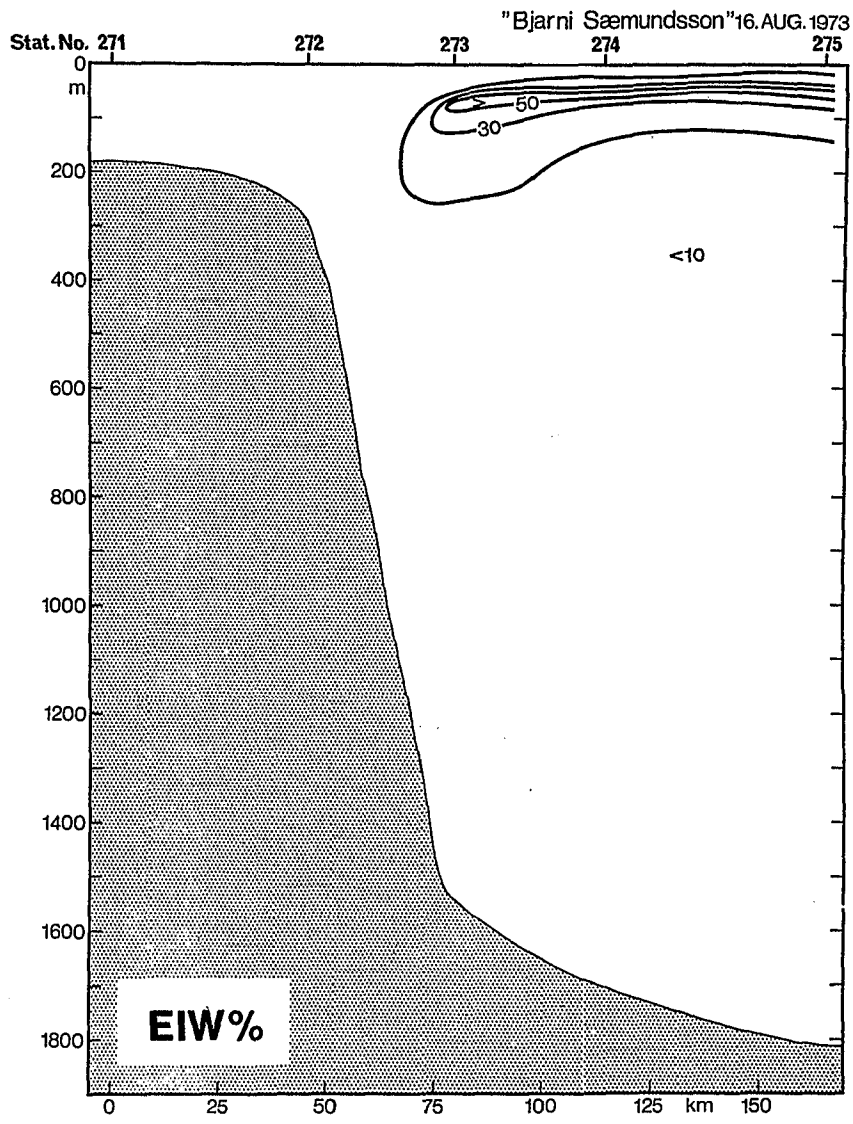

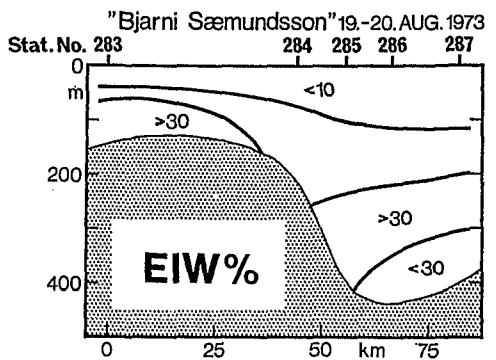
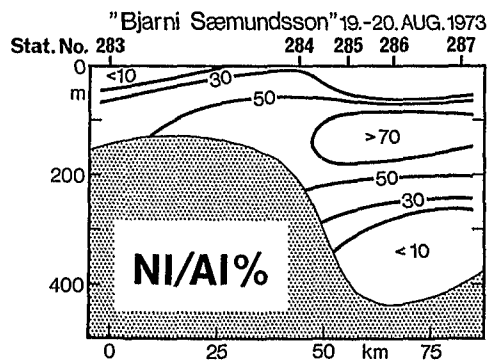
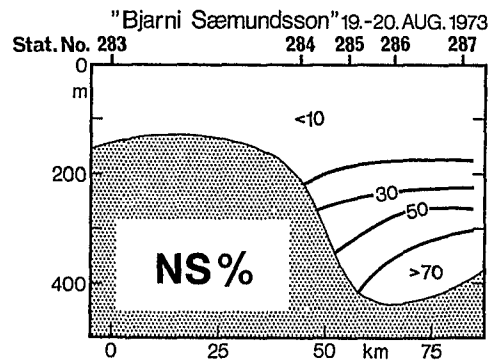
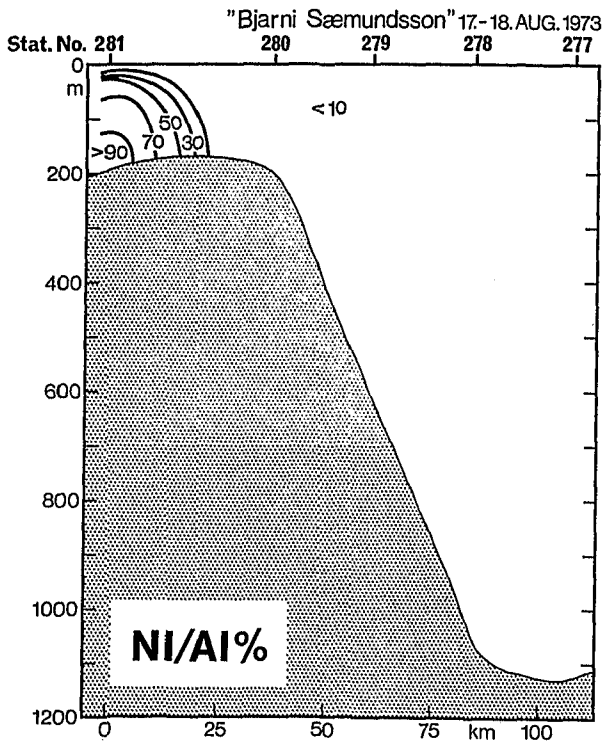
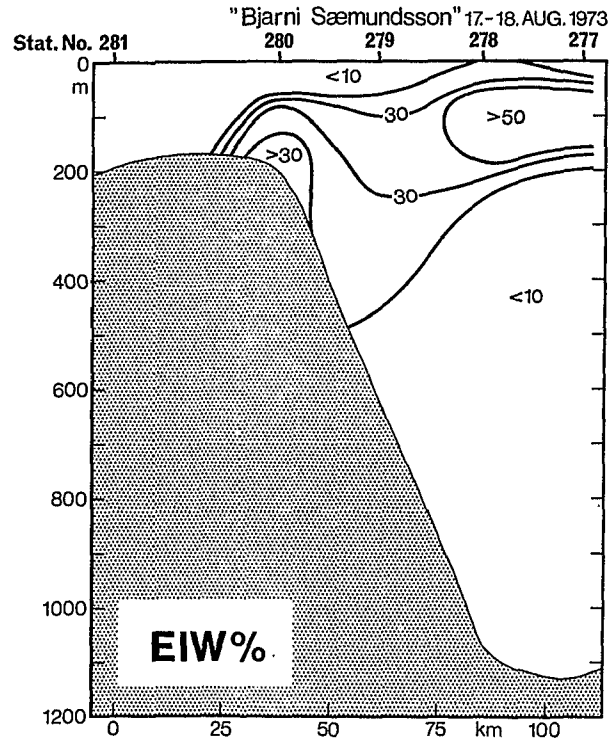
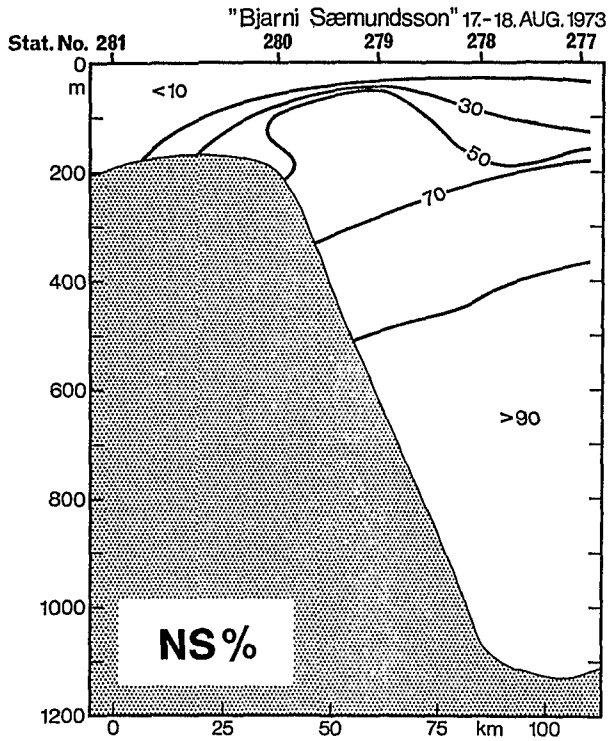



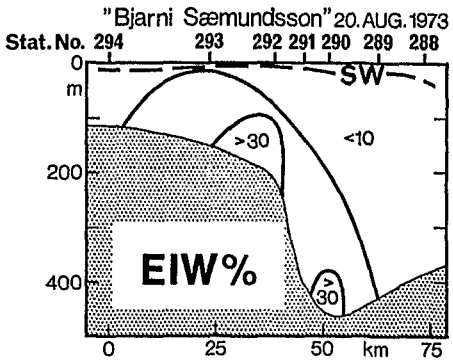
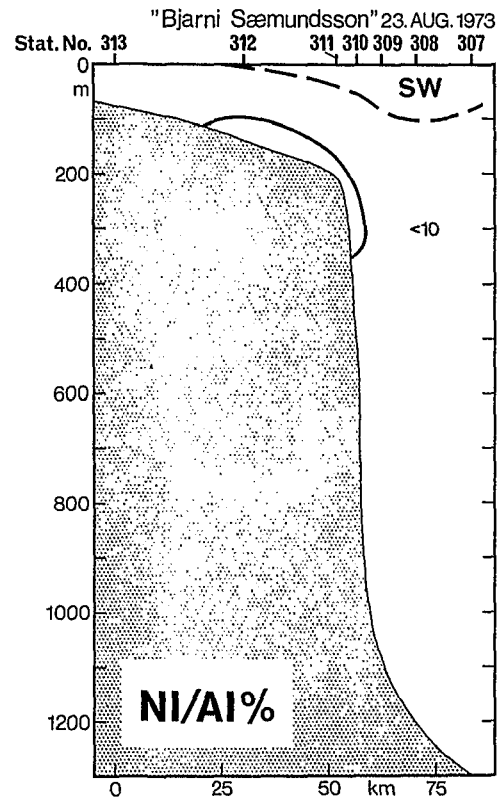
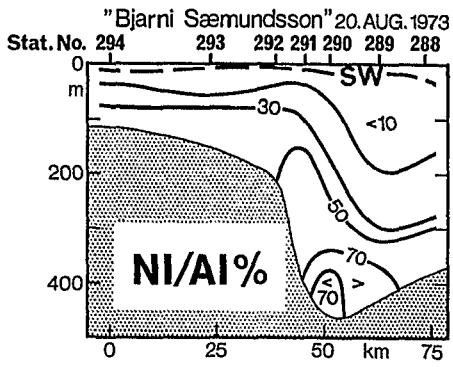
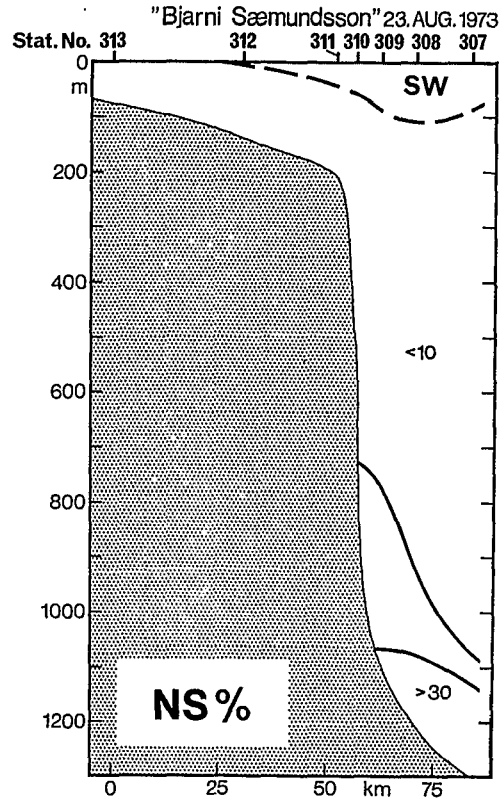
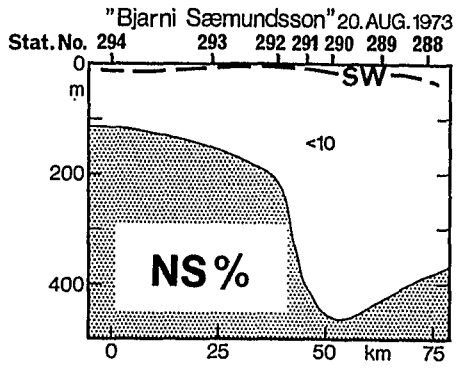

"Bjarni Saemundsson" 25.AUG.1973  
Stat.No. 325 324 323

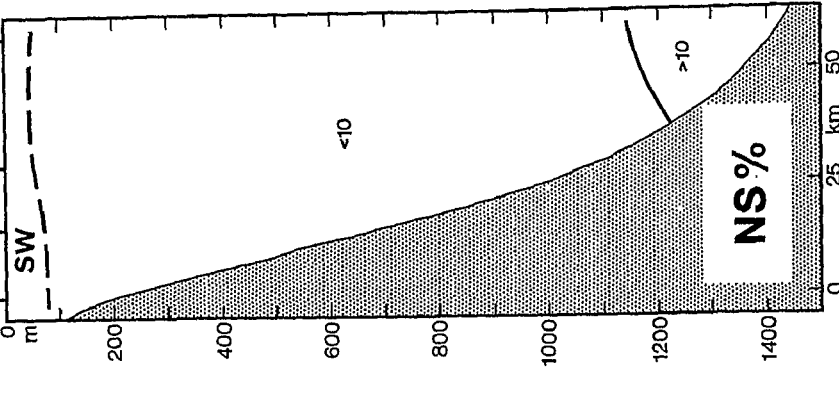

"Bjarni Saemundsson" 24.-25.AUG.1973  
Stat.No. 323 322 321 320 319 318 317

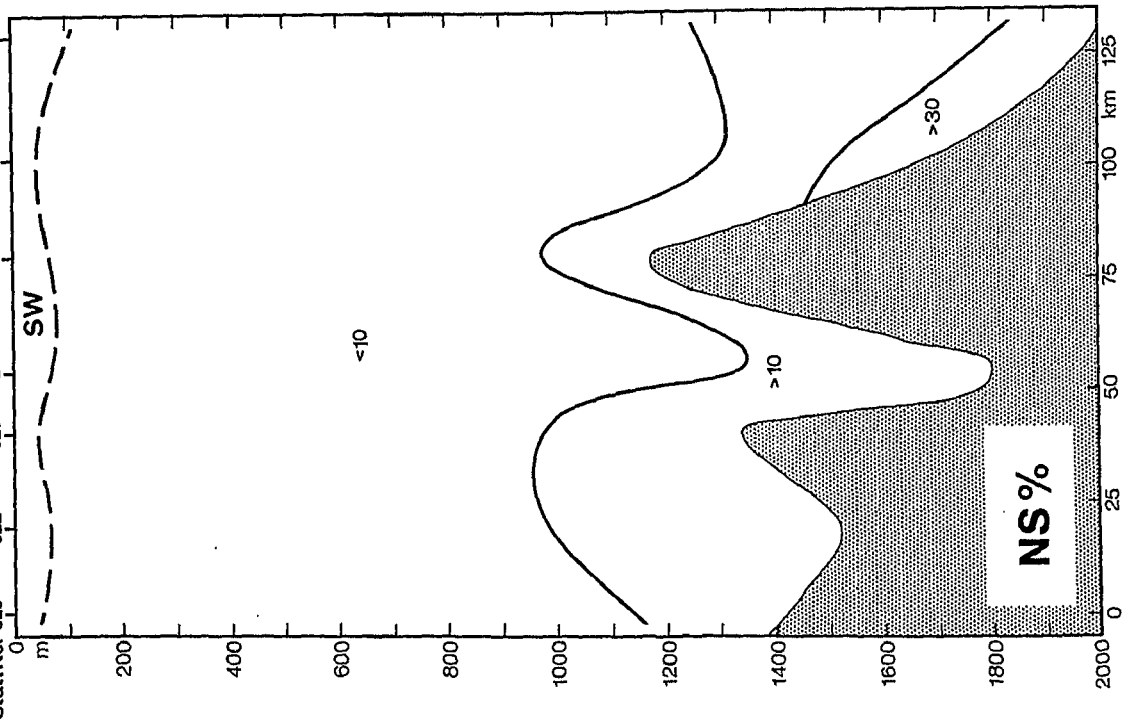

"Bjarni Saemundsson" 24.AUG.1973  
Stat.No. 314 315 316 317

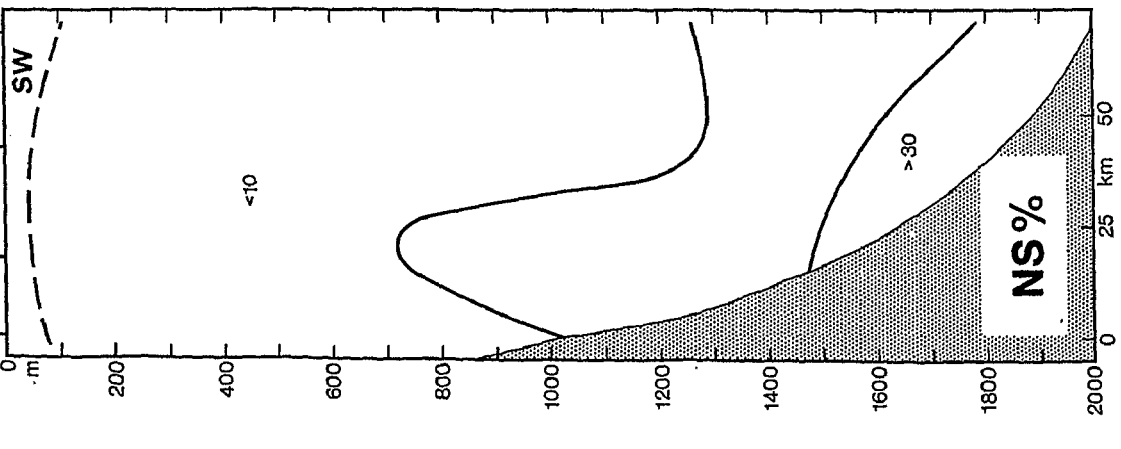

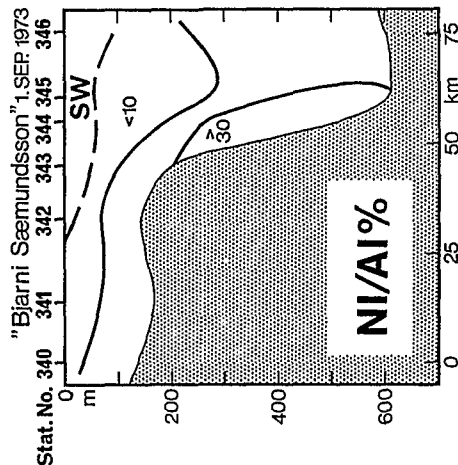
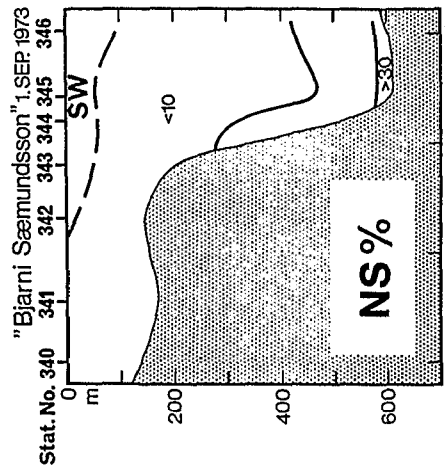
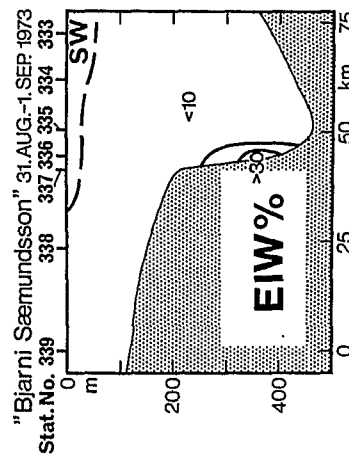
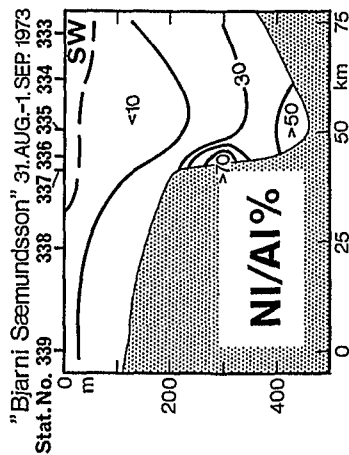
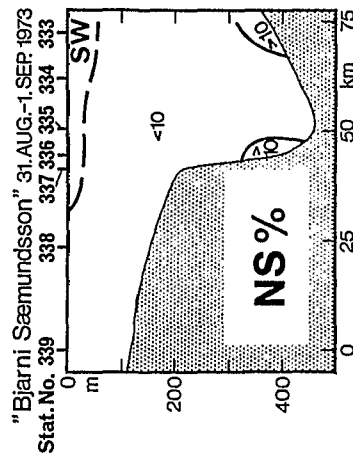
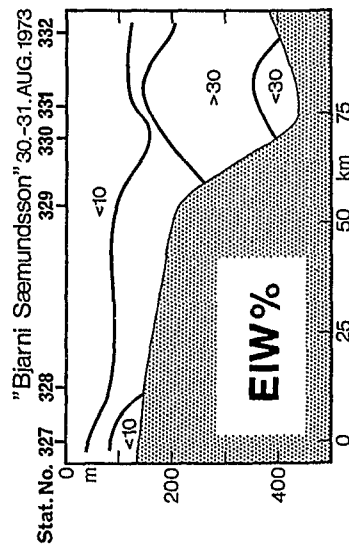
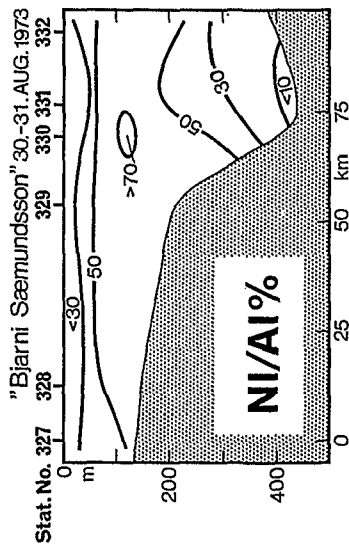
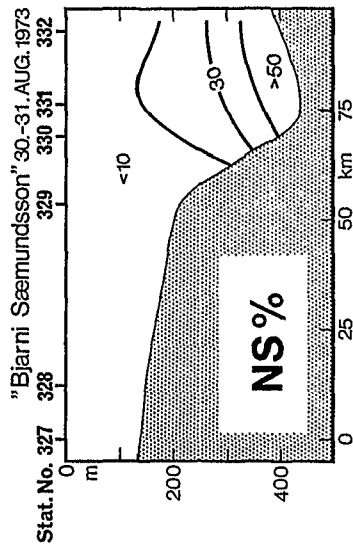

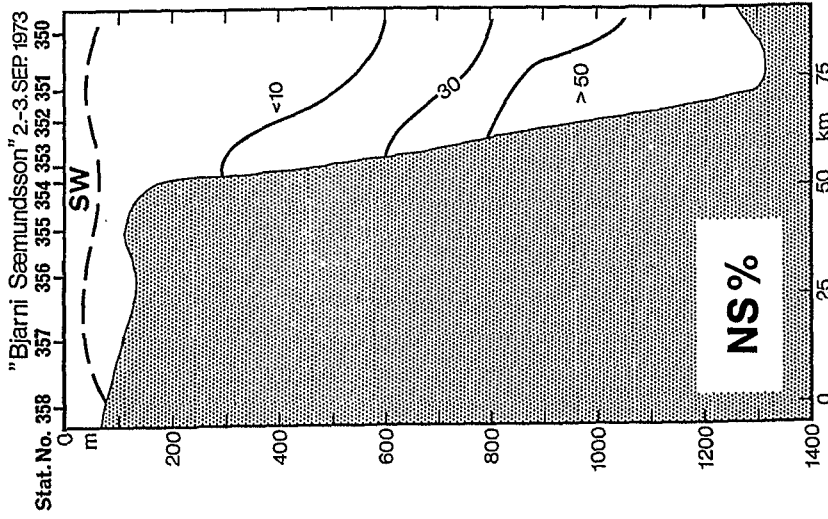
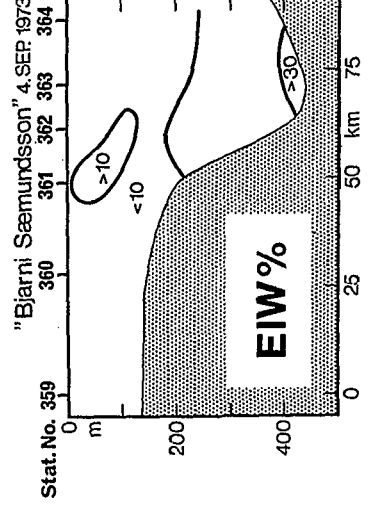
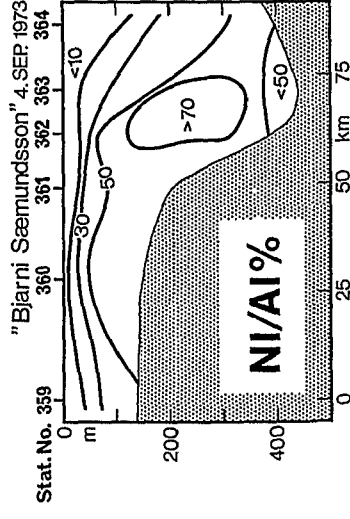
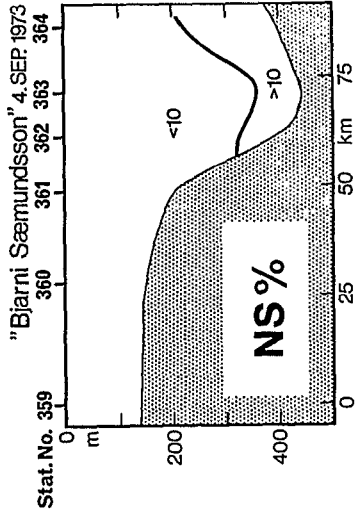
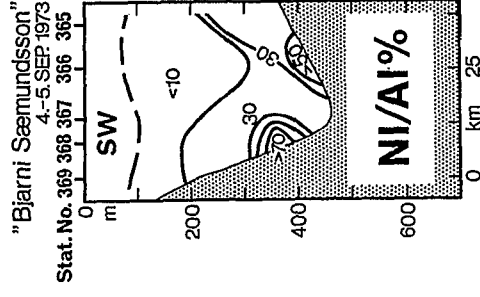
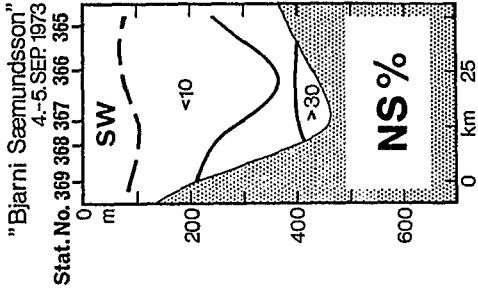

6.10 W. Herwig

Atlantic water is dominated by MNA. NS, NI/AI and EIW occur as deep overflow, and EIC at the surface. IS has not been analysed, but is found from below 800 m on the south west flank of the ridge:

Station	Stat.No.	Mixing triangle (see table 3)
1 - 6		4
101 - 106		4
201 - 206		4
7- 19	7 - 13	4, 5
	14 - 16	4, 8
	17 - 19	7, 8
107 - 119	107 - 112	4, 5
	113 - 116	4, 8
	117, 118	8
	119	4, 7, 8
207 - 219	207 - 212	4, 5
	213 - 217	4, 8
	218	7, 8
19 - 21		7, 8
119 - 122		7, 8
219 - 222		7, 8
23 - 28	23 - 25	7, 8
	26 - 28	4, 5
123 - 128	123	4, 5
	124	7, 8
	125	8
	126 - 128	4, 5
223 - 228	223, 224	4, 5
	225	8
	226	7, 8
	227, 228	4, 5

W. Herwig (cont'd)

Section	Stat.No.	Mixing triangle (see table 3)
28 - 36		4
128 - 136		4
228 - 236		4
36 - 101		4
136 - 201		4
236 - 246		4

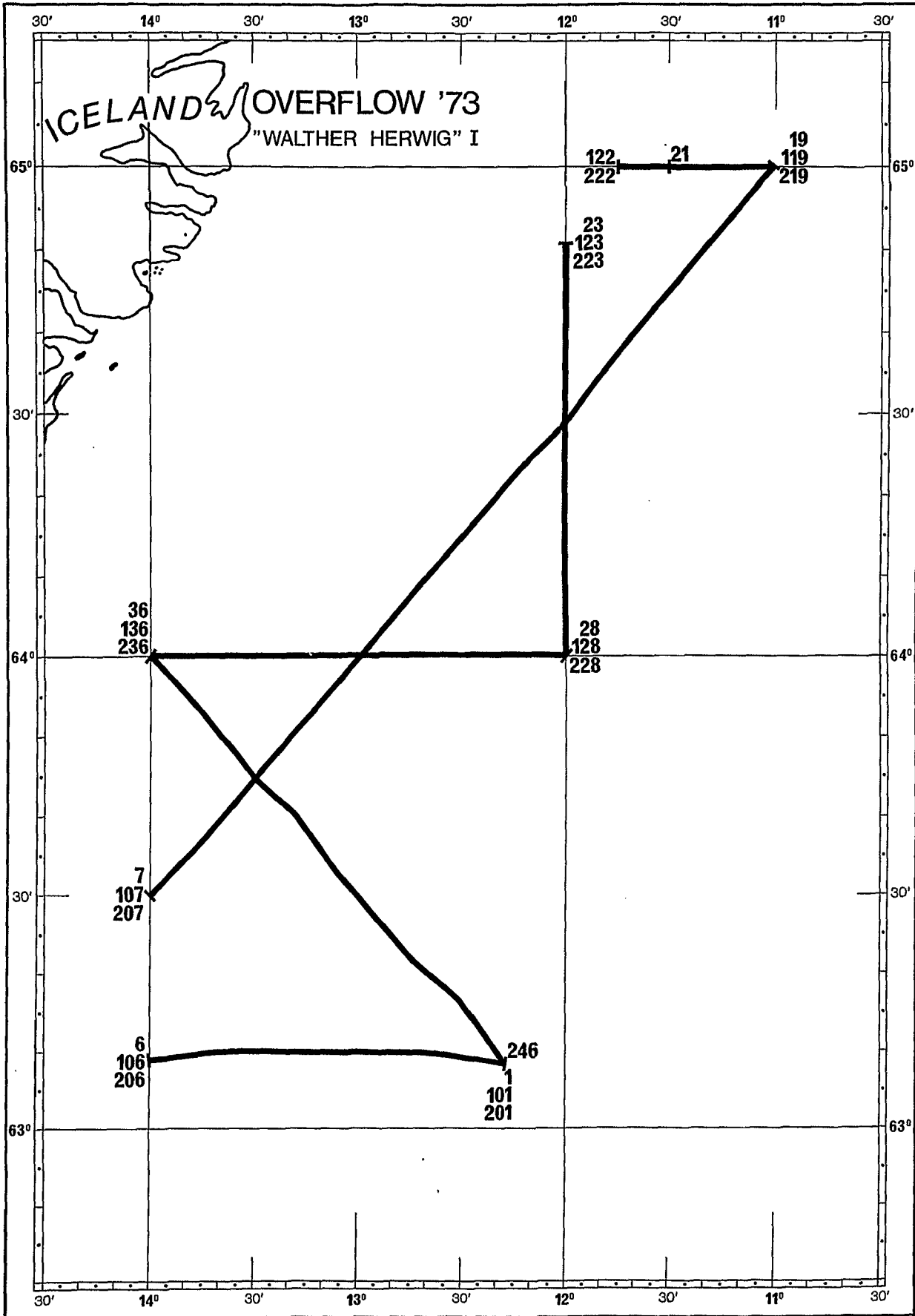

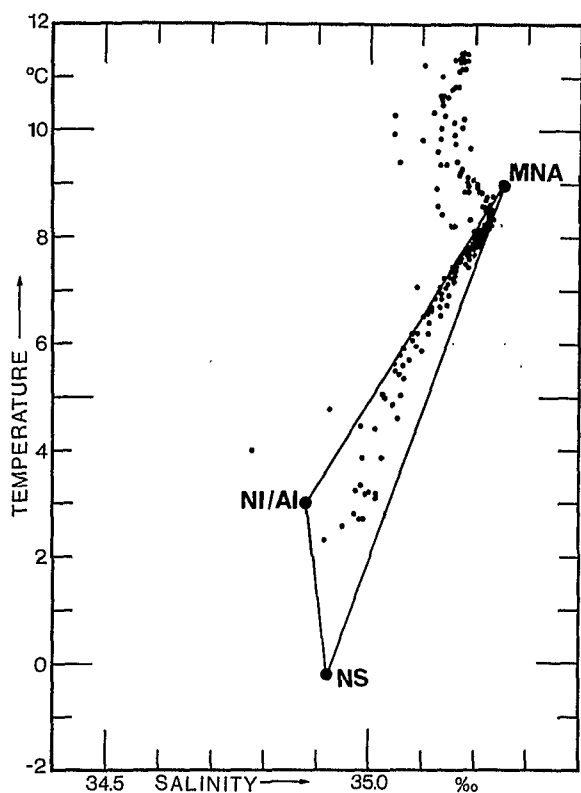

"WALTHER HERWIG", I  
13.-14.AUG.1973  
STAT.NO.1-6

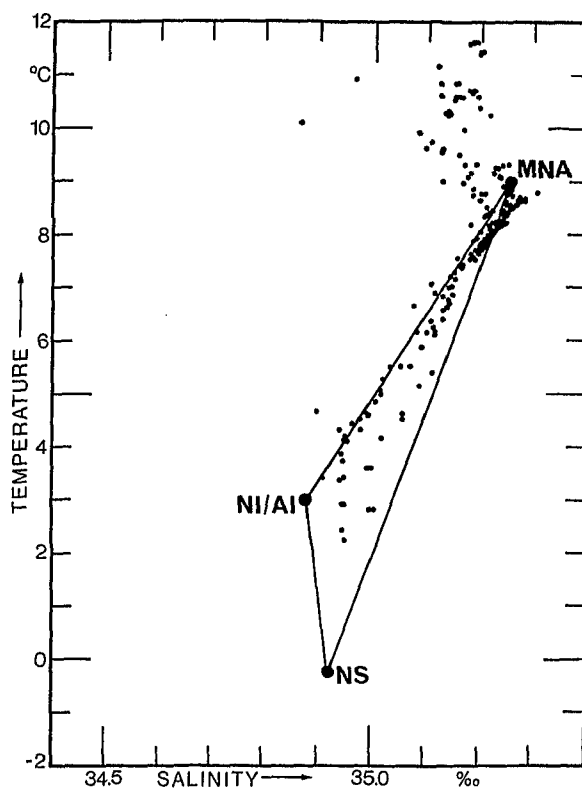

"WALTHER HERWIG", I  
18.AUG.1973  
STAT.NO.101-106

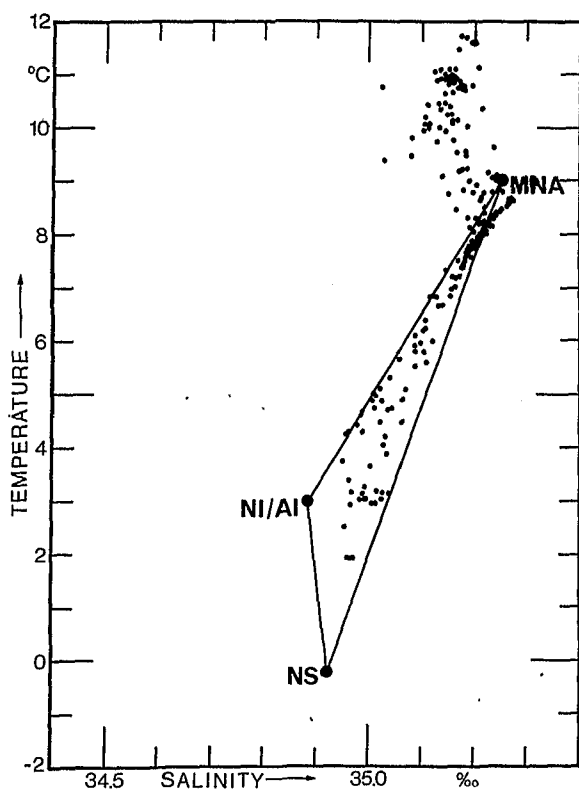

"WALTHER HERWIG", I  
25.-26.AUG.1973  
STAT.NO.201-206



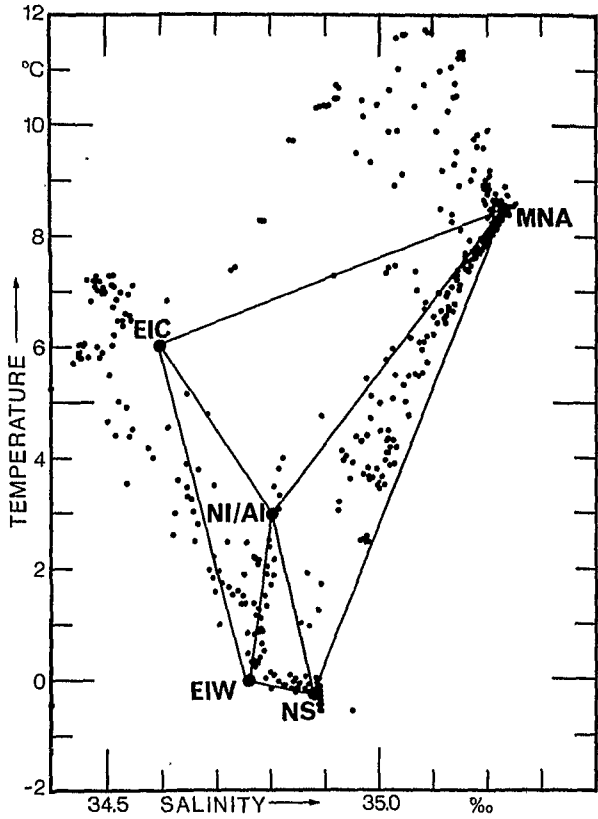

"WALTHER HERWIG", I  
14.-16.AUG.1973  
STAT.NO.7-19

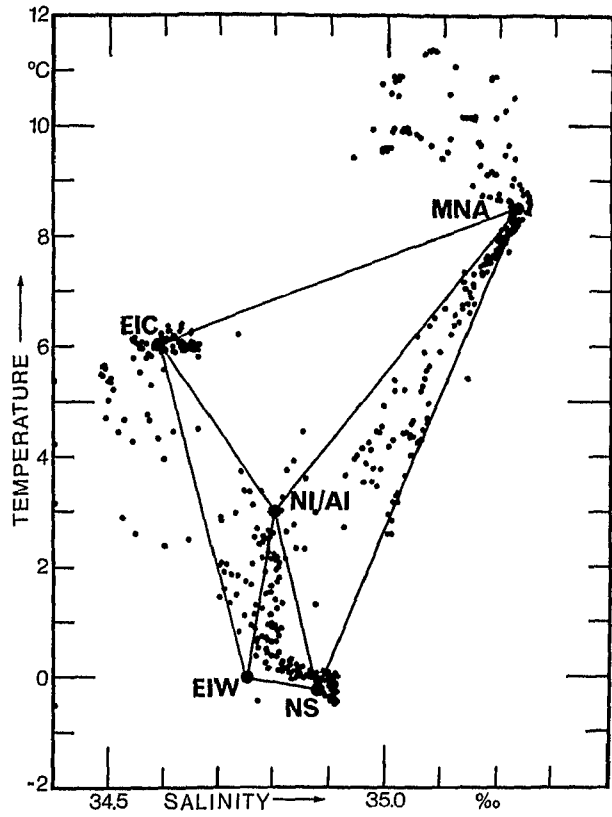

"WALTHER HERWIG", I  
19.-20.AUG.1973  
STAT.NO.107-119

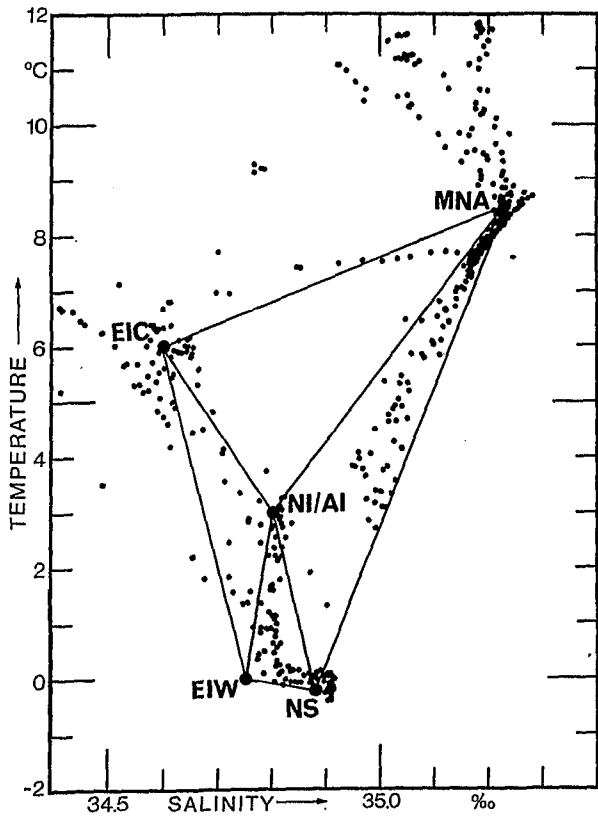

"WALTHER HERWIG", I  
26.-27.AUG.1973  
STAT.NO.207-219

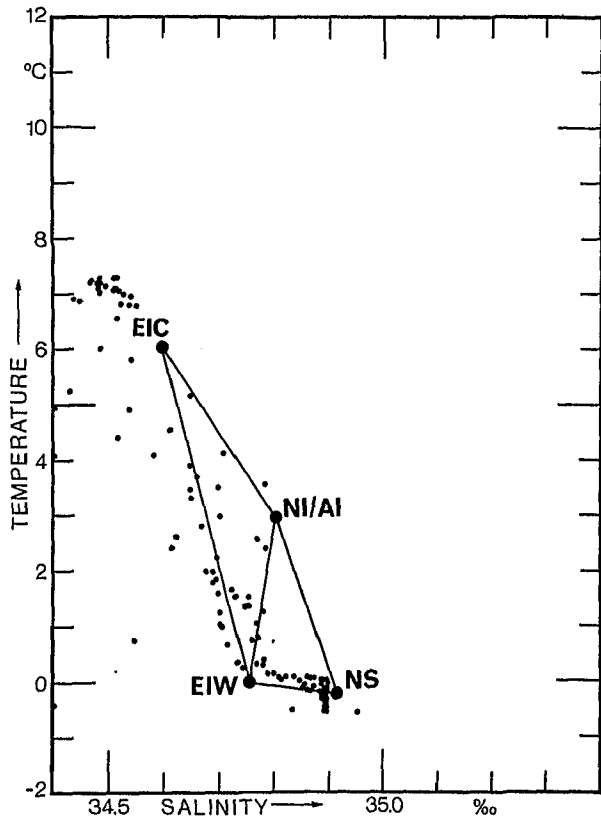

"WALTHER HERWIG", I  
16.AUG.1973  
STAT.NO.19-21

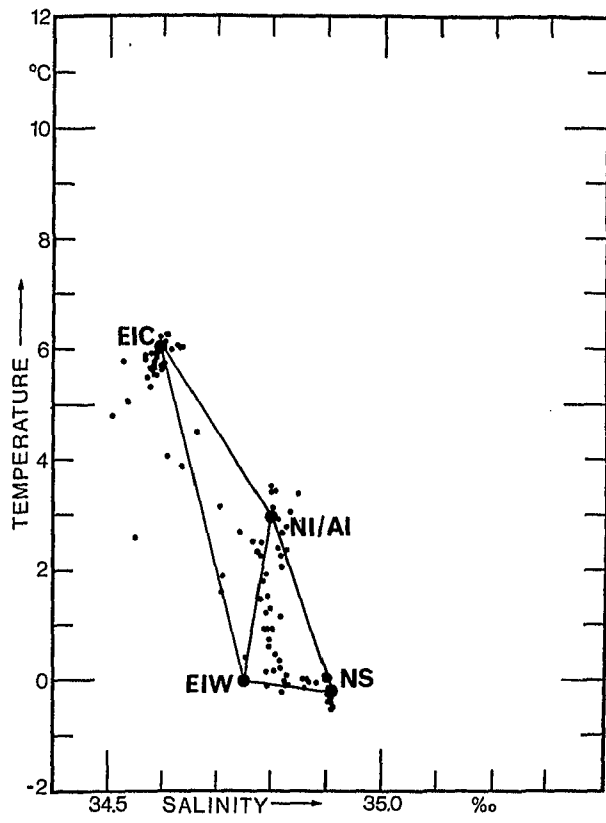

"WALTHER HERWIG", I  
20.-22.AUG.1973  
STAT.NO.119-122

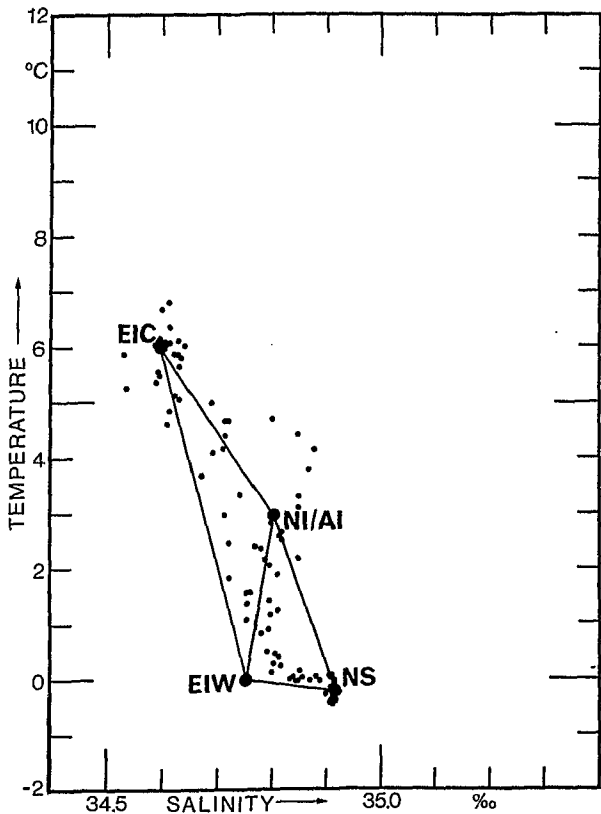

"WALTHER HERWIG", I  
27.-28.AUG.1973  
STAT.NO.219-222

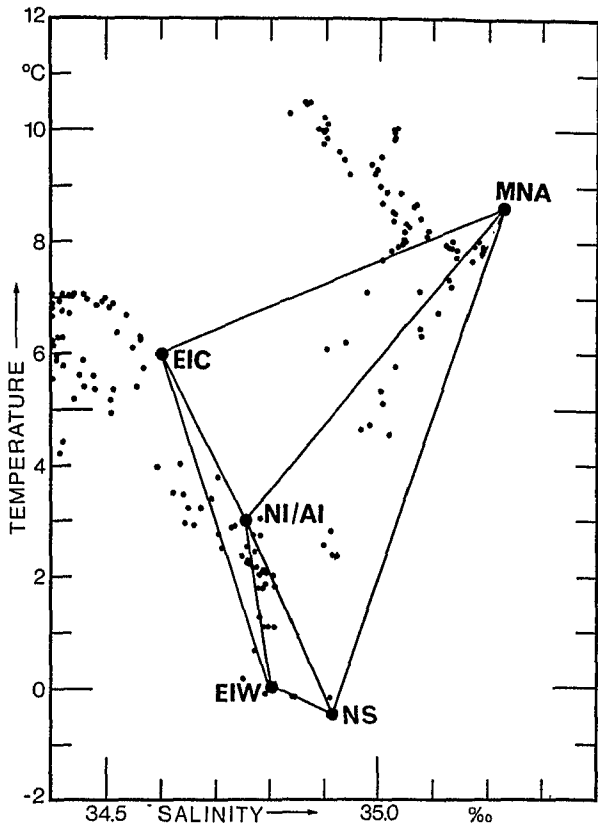

"WALTHER HERWIG", I  
16.-17.AUG.1973  
STAT.NO.23-28

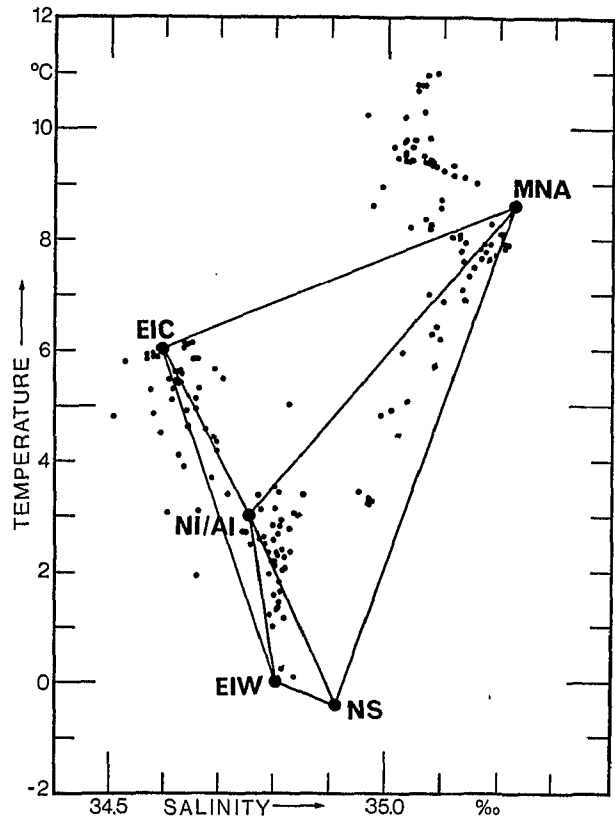

"WALTHER HERWIG", I  
22.AUG.1973  
STAT.NO.123-128

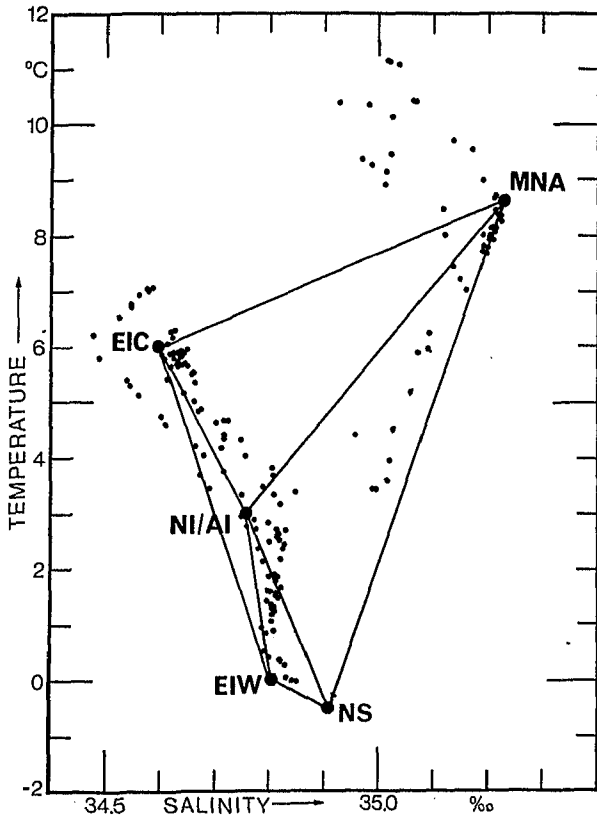

"WALTHER HERWIG", I  
28.AUG.1973  
STAT.NO.223-228

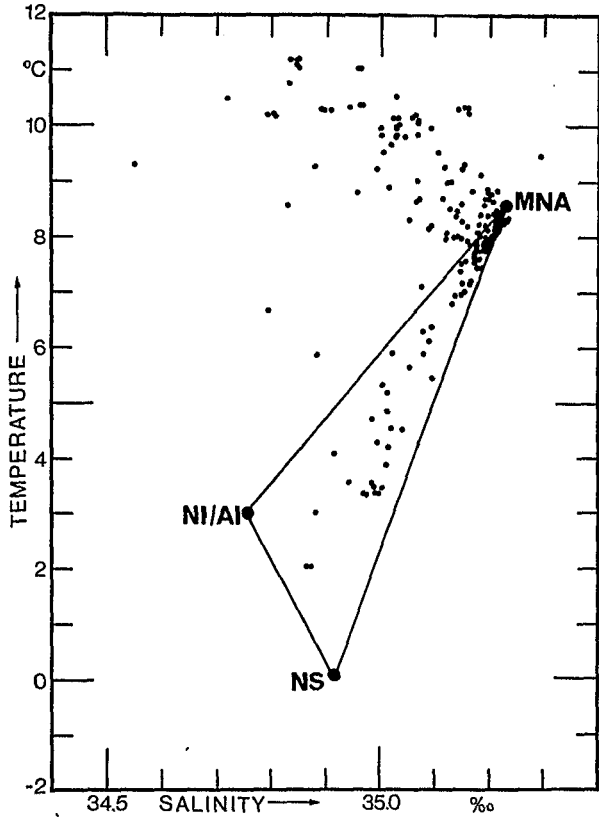

"WALTHER HERWIG", I  
17.AUG.1973  
STAT.NO.28,29,31-33,35,36

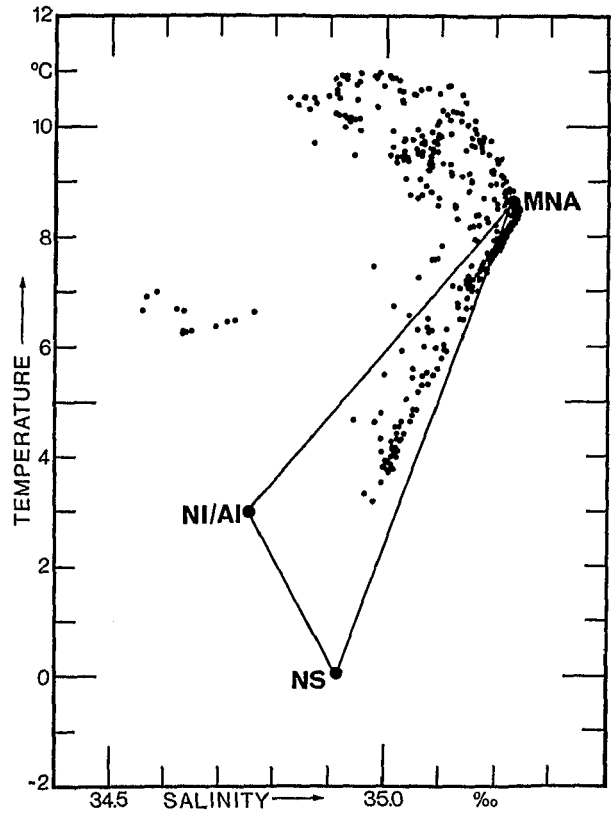

"WALTHER HERWIG", I  
22.-24.AUG.1973  
STAT.NO.128-133,135,136

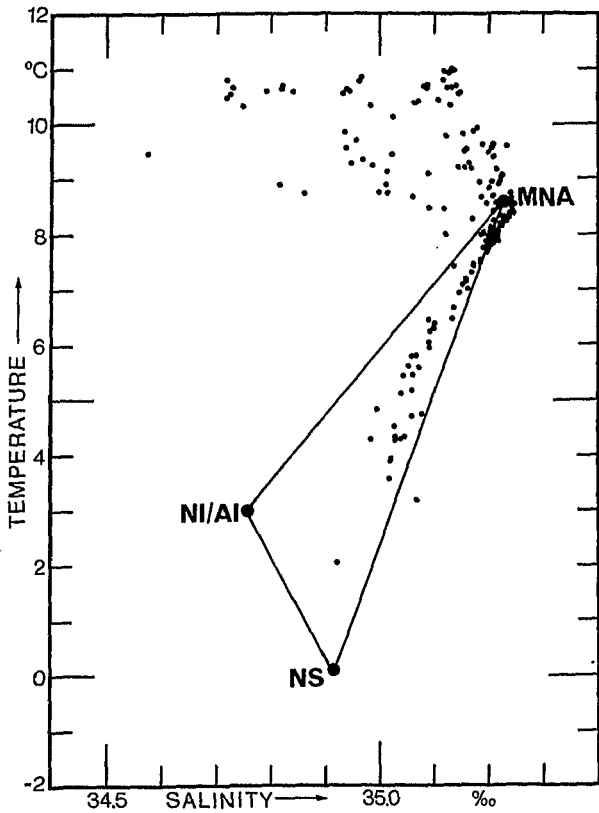

"WALTHER HERWIG", I  
28.-29.AUG.1973  
STAT.NO.228,230-233,235,236

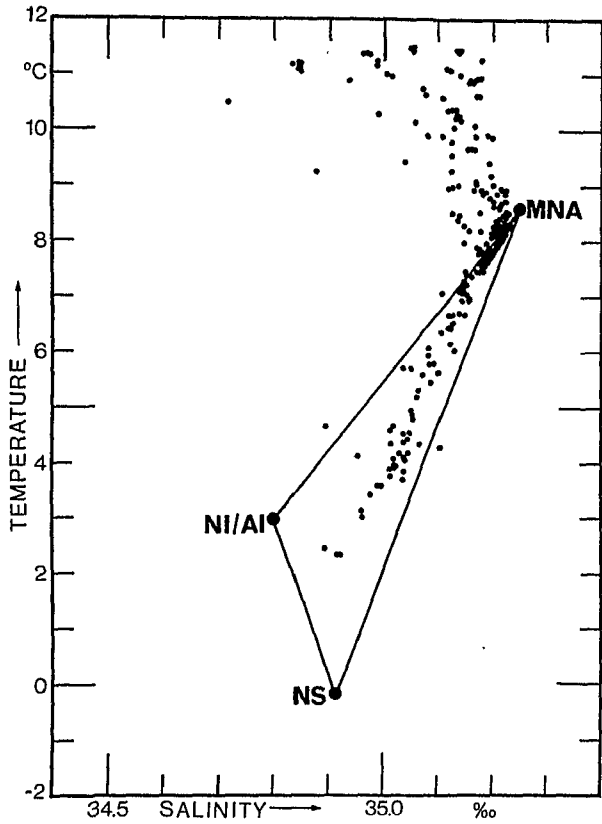

"WALTHER HERWIG", I  
17.-18.AUG.1973  
STAT.NO.36,37,39-45,101

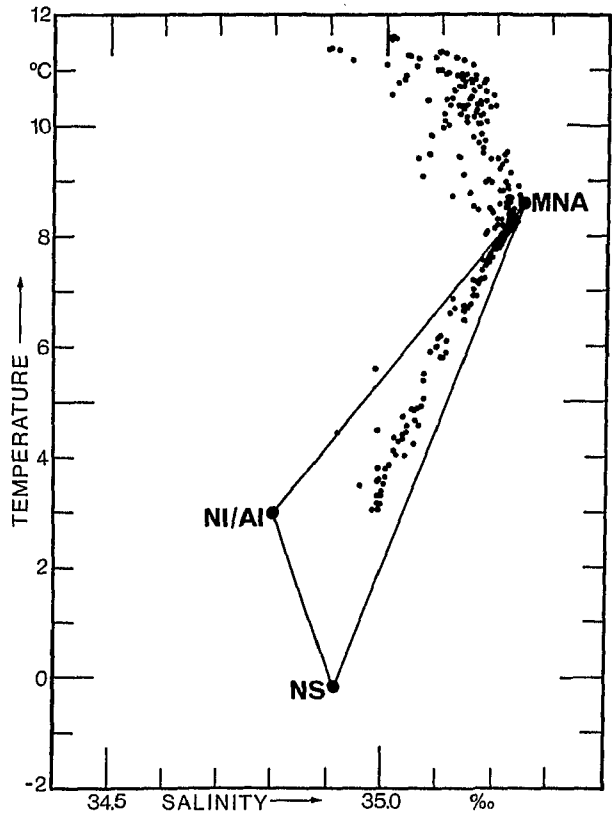

"WALTHER HERWIG", I  
24.-25.AUG.1973  
STAT.NO.136,137,139-145,201

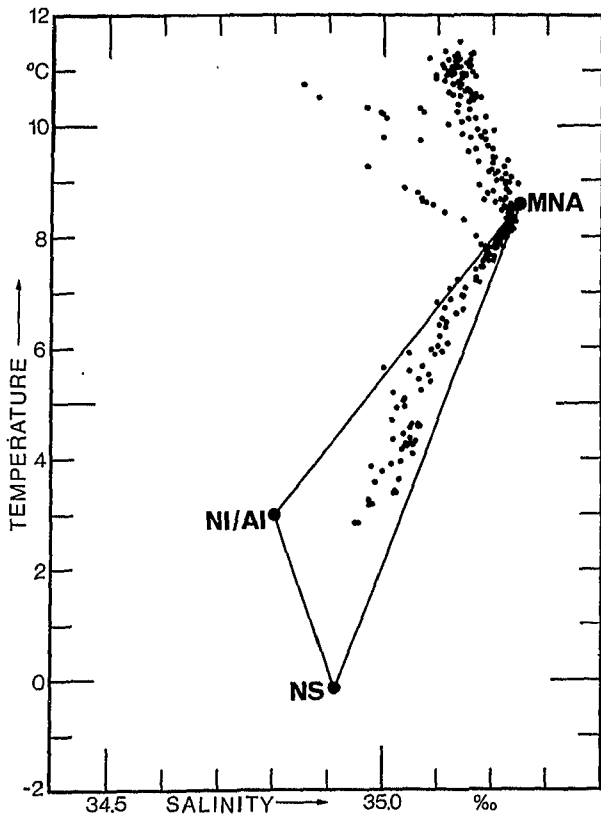

"WALTHER HERWIG", I  
29.-30.AUG.1973  
STAT.NO.236,237,239-246

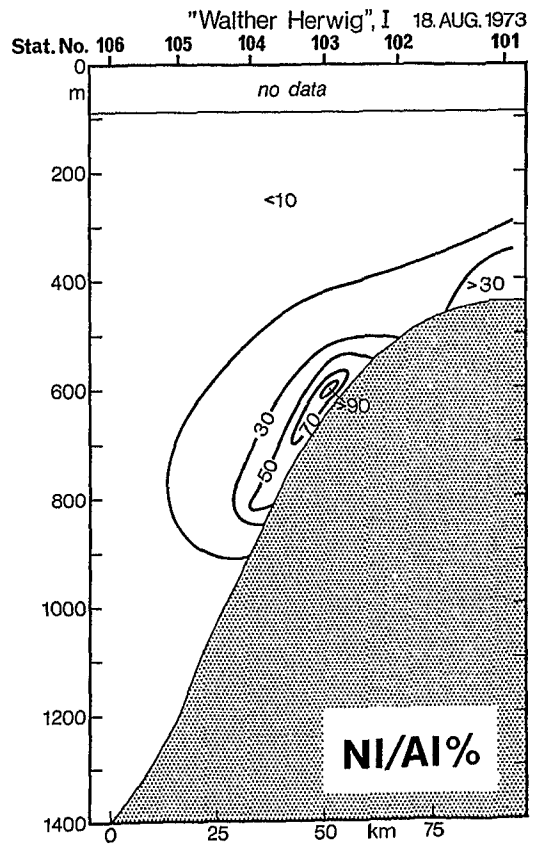
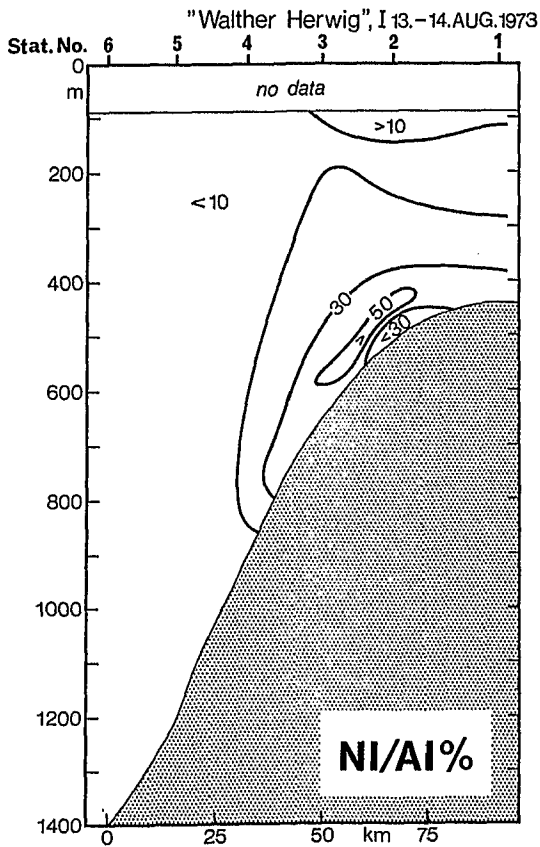
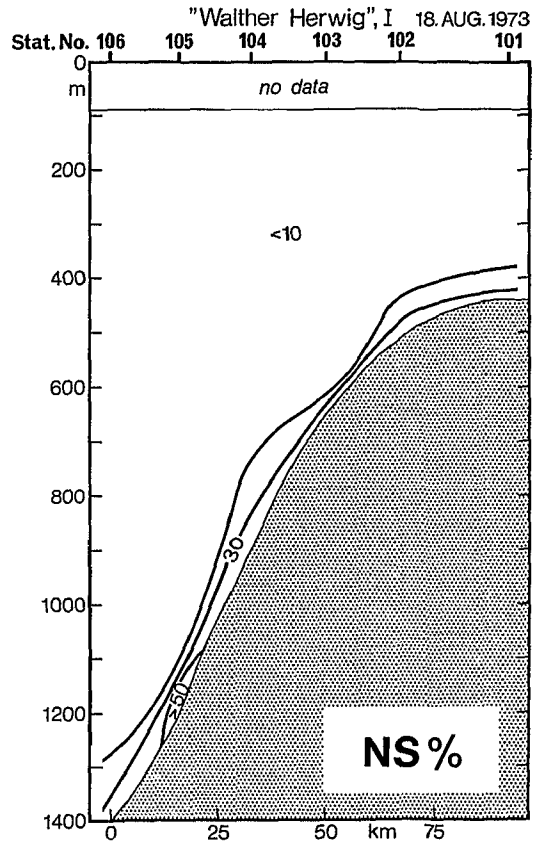
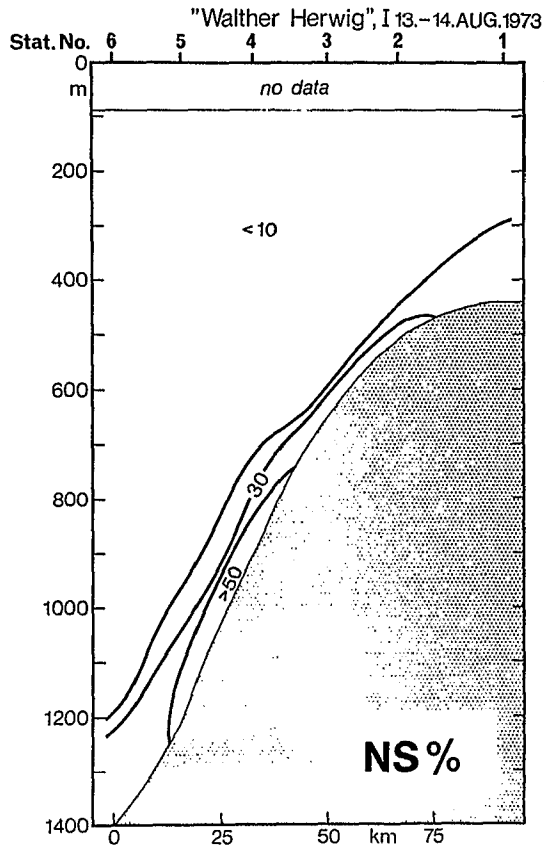

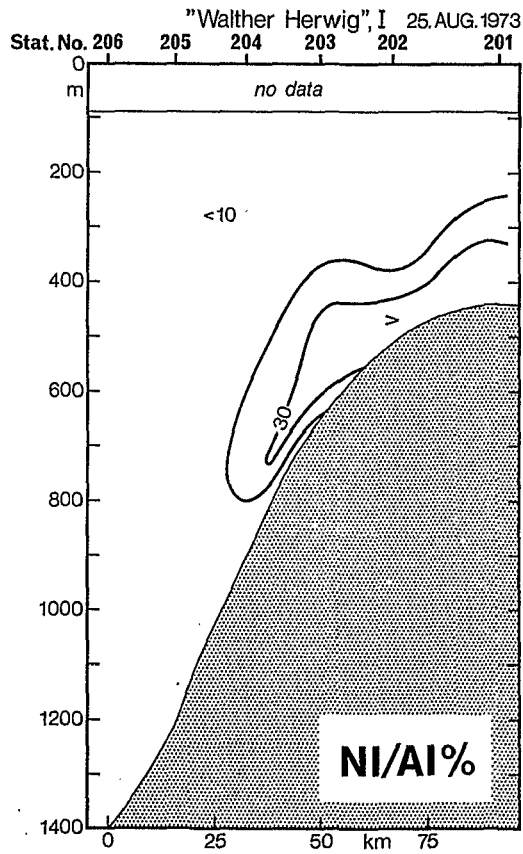
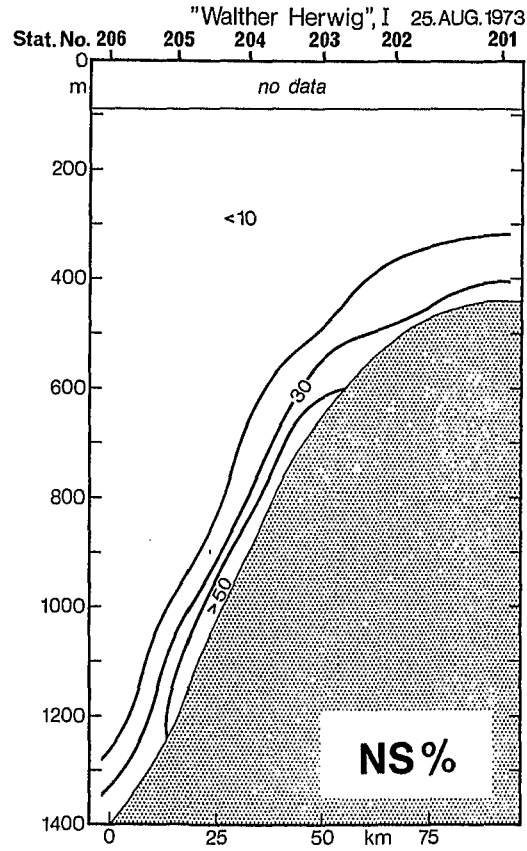

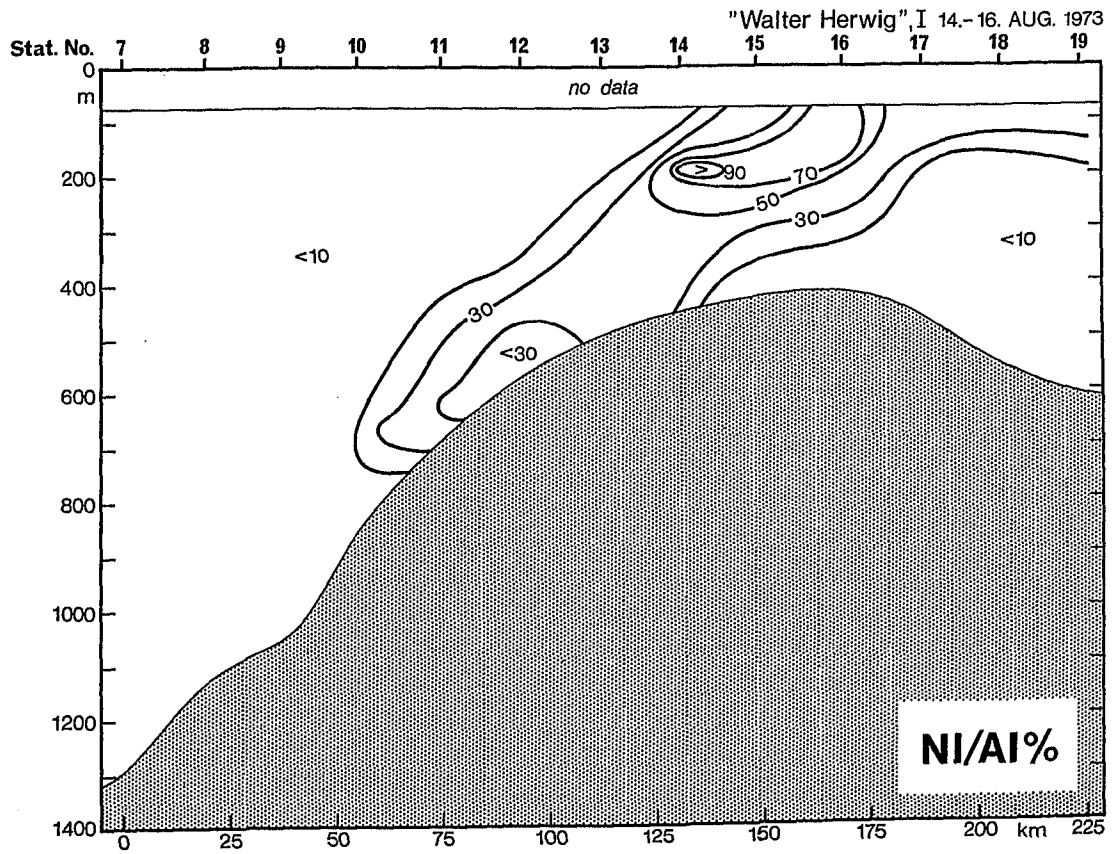
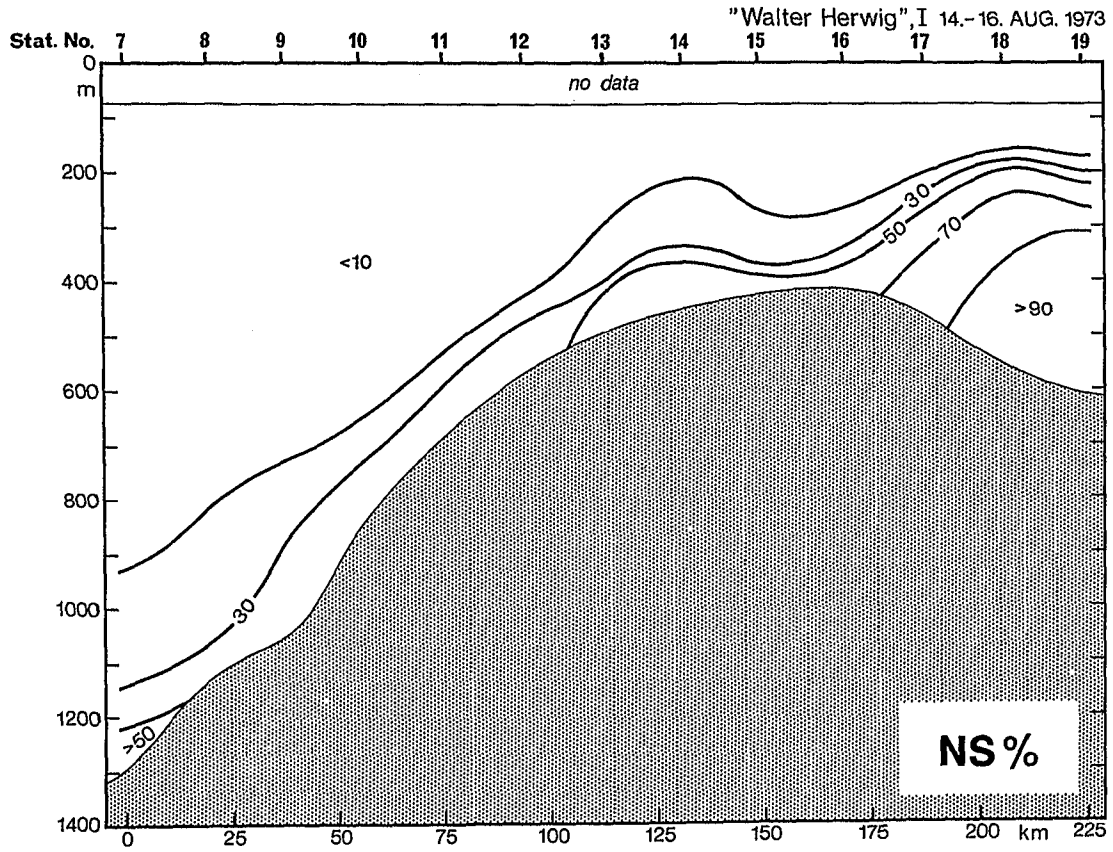



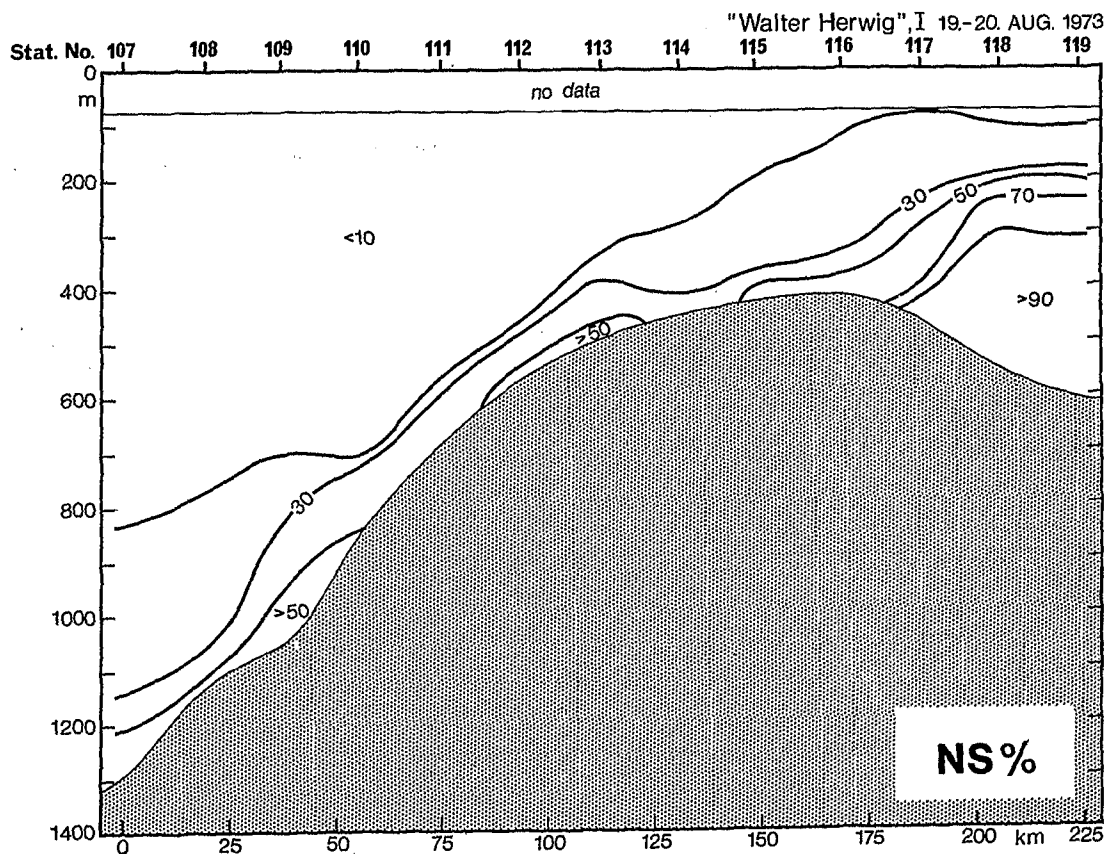
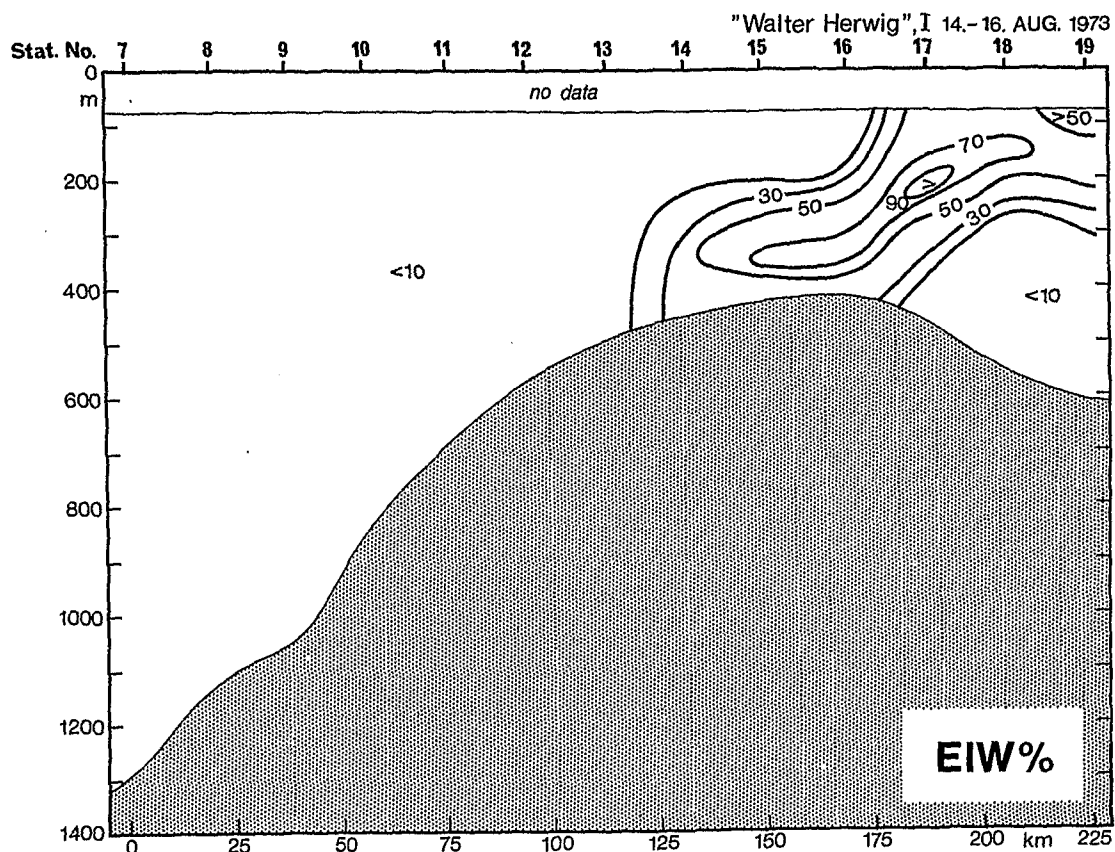

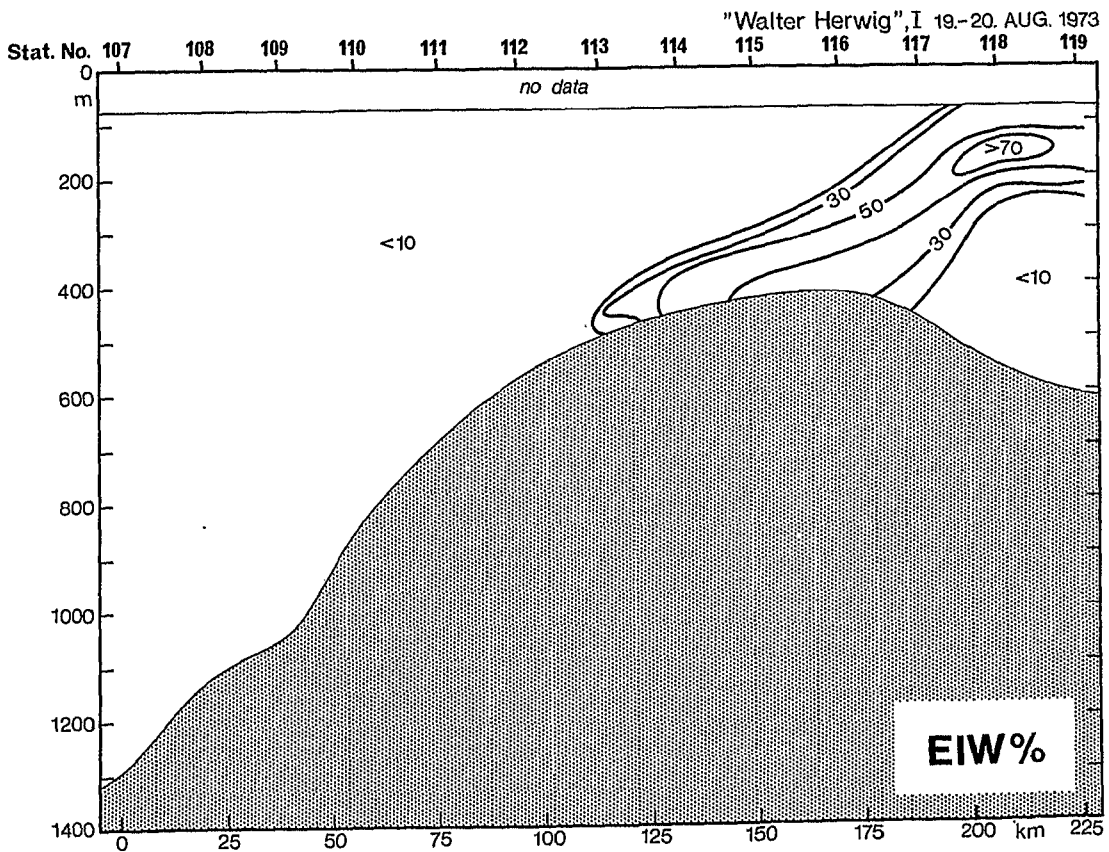
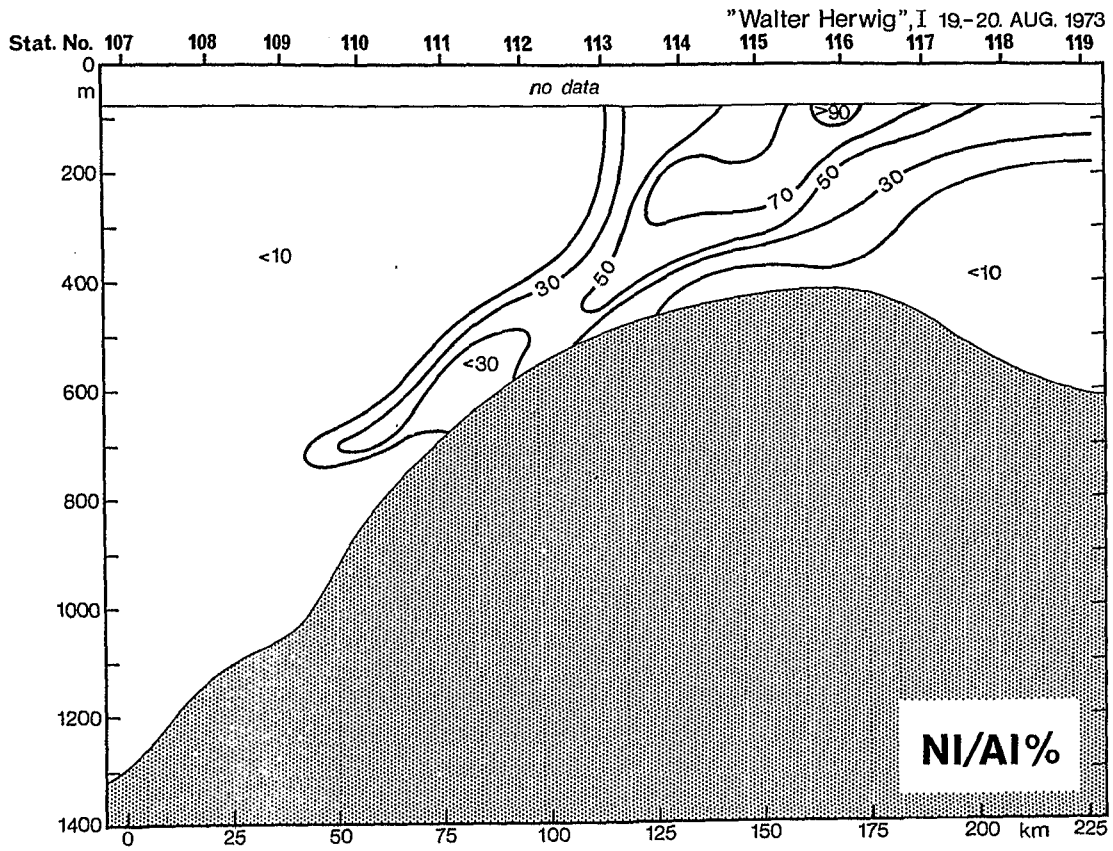

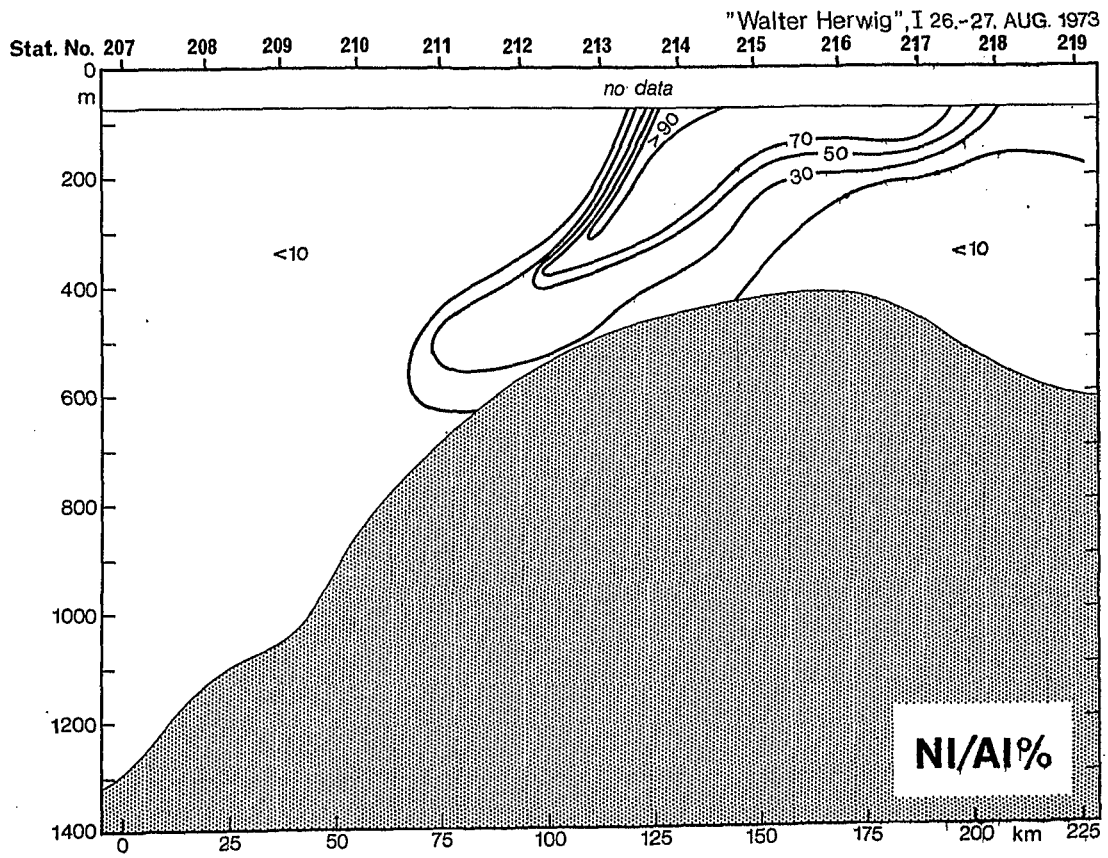
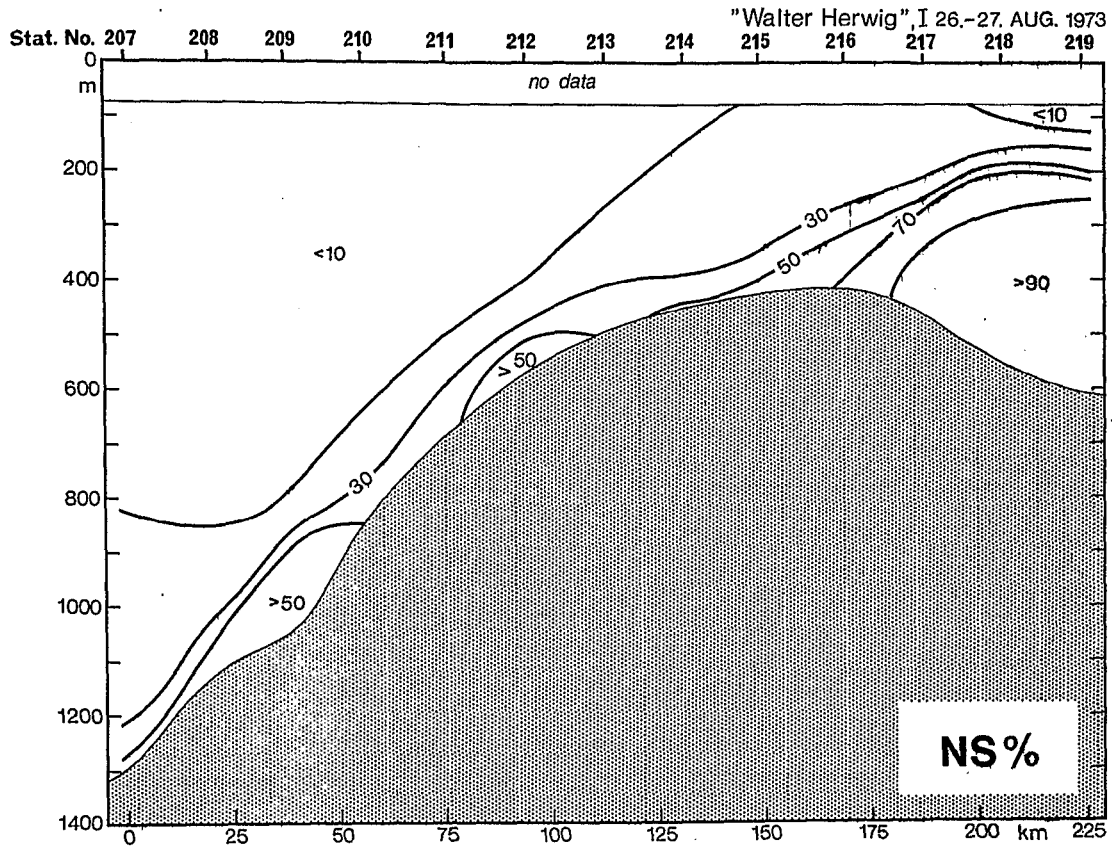

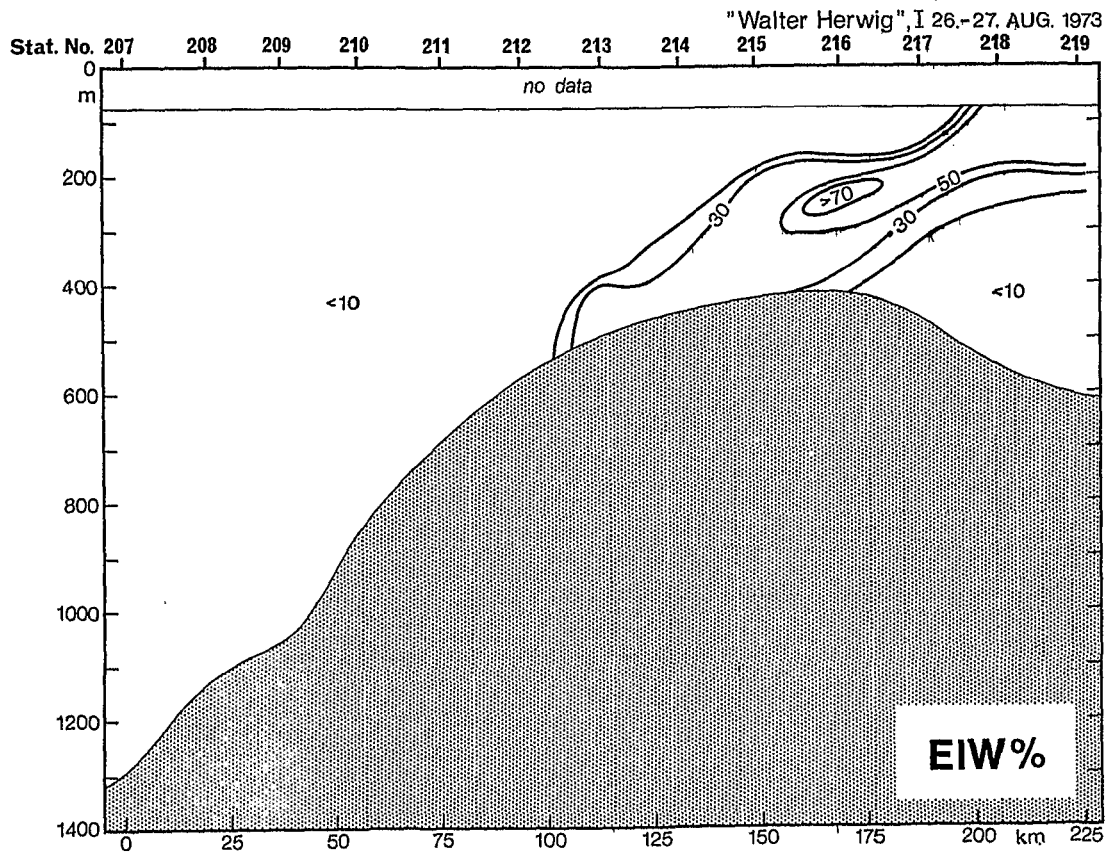

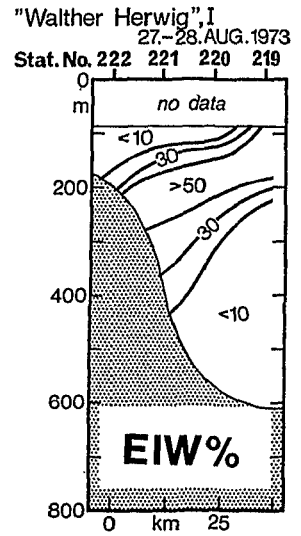
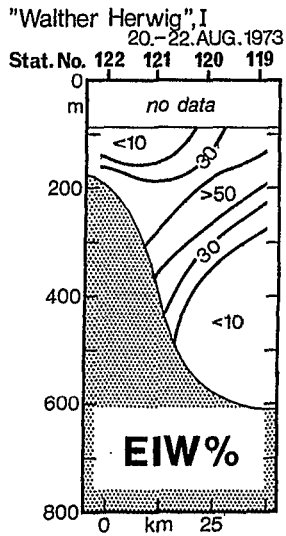
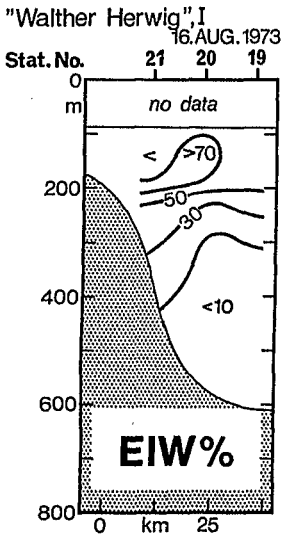
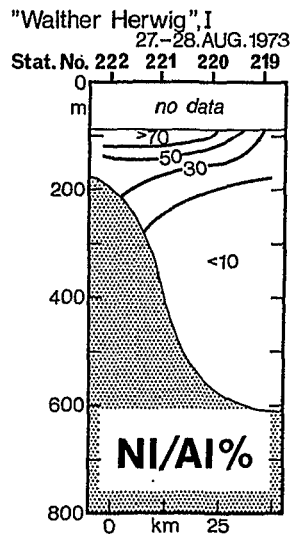
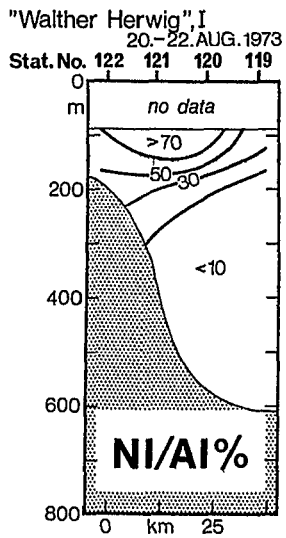
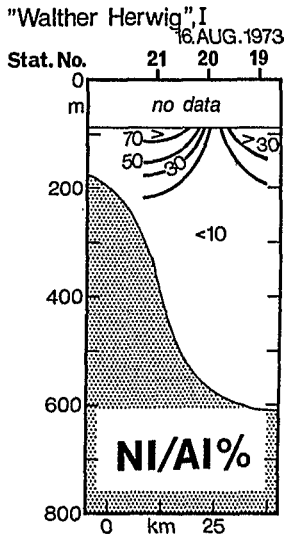
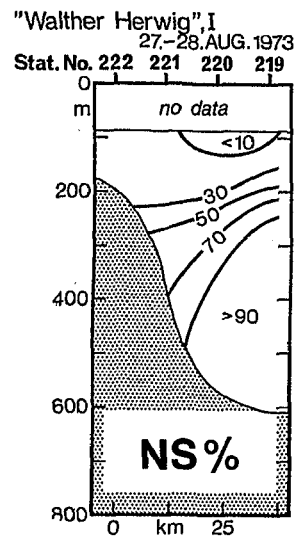
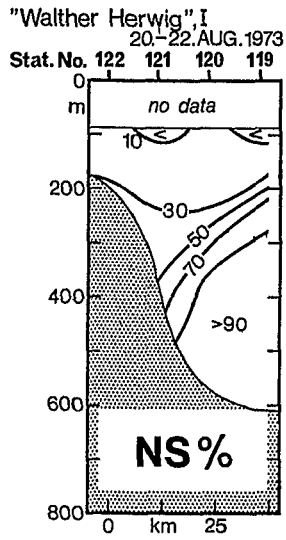
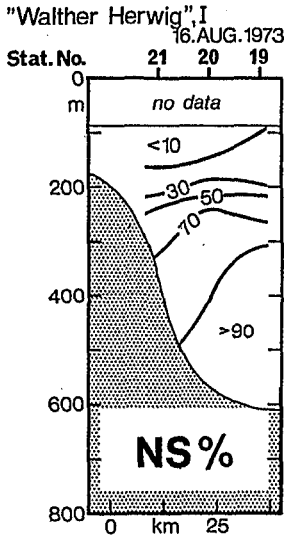

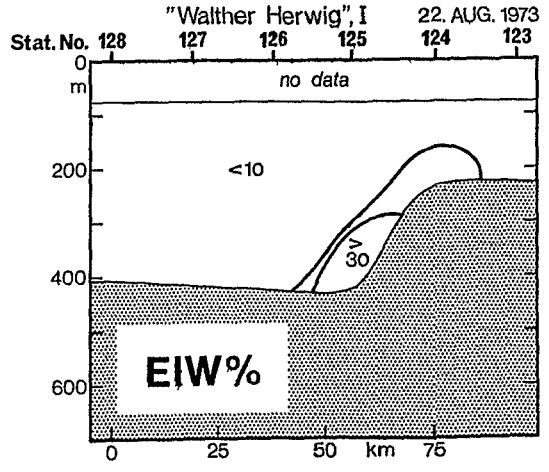
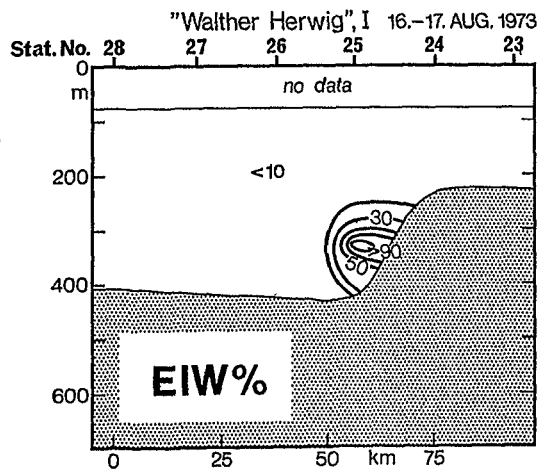
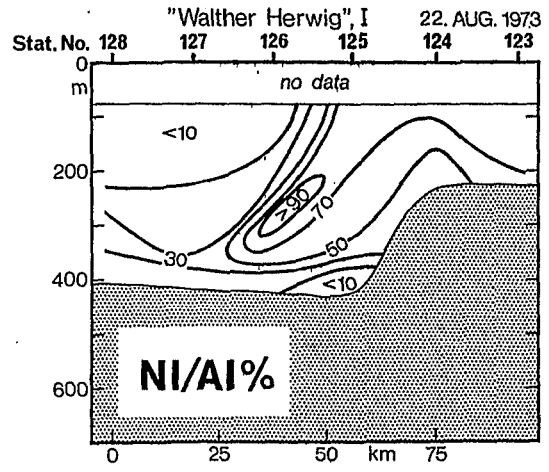
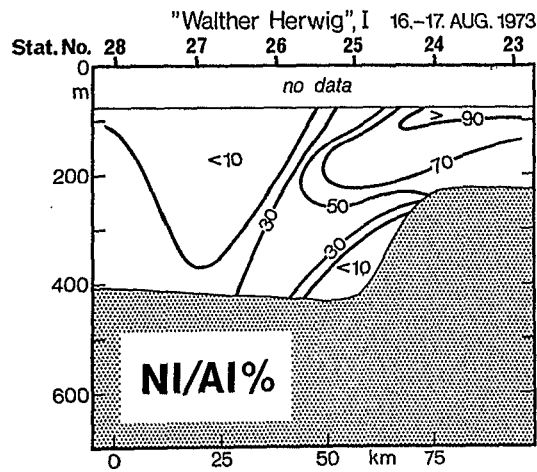
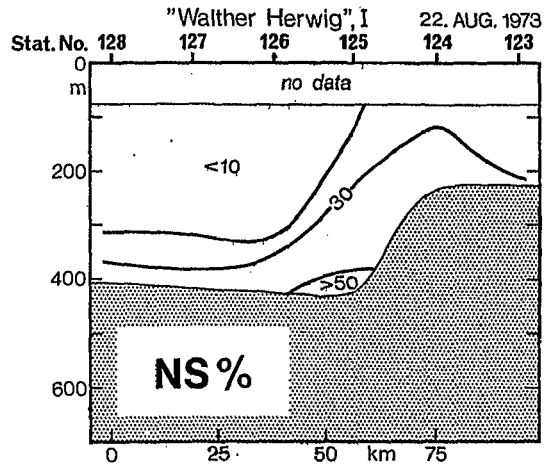
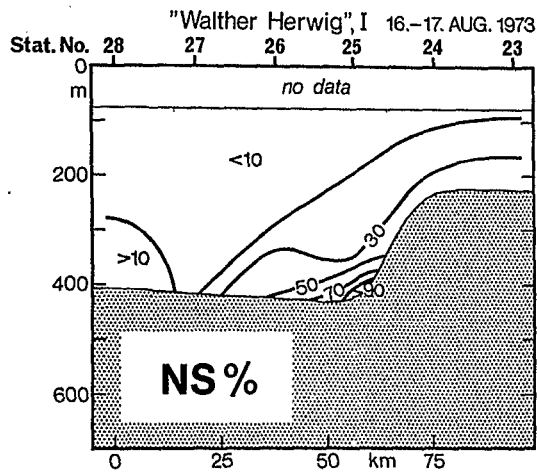

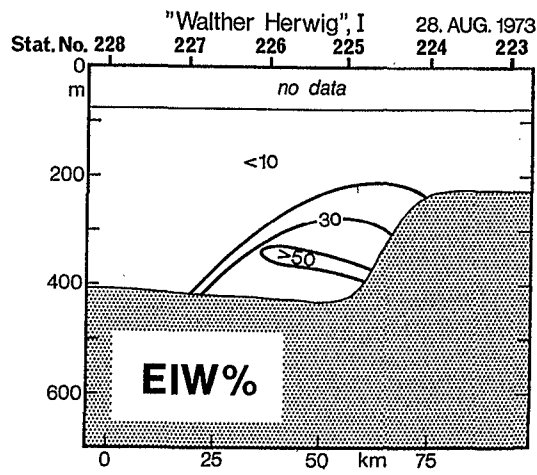
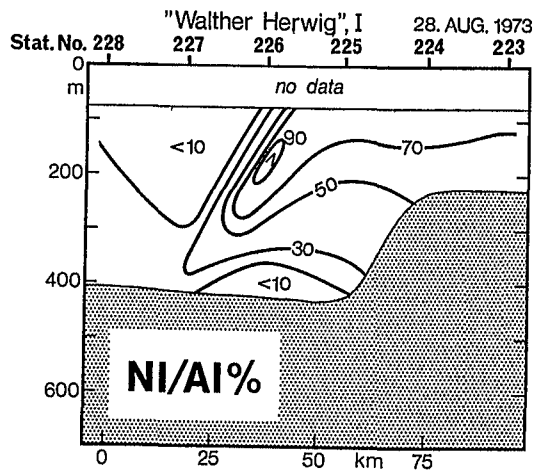
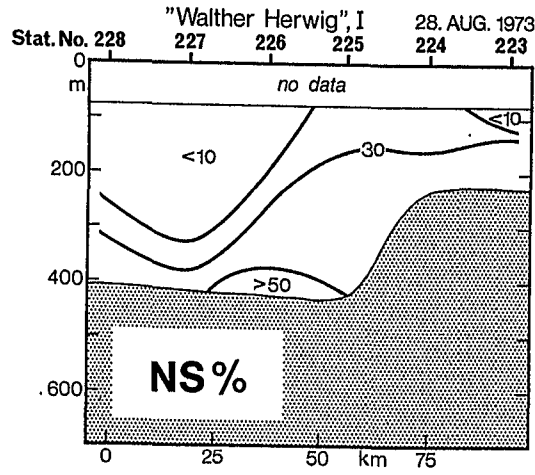

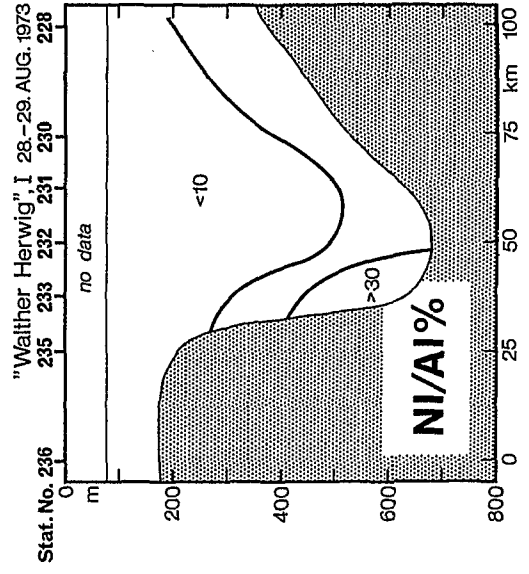
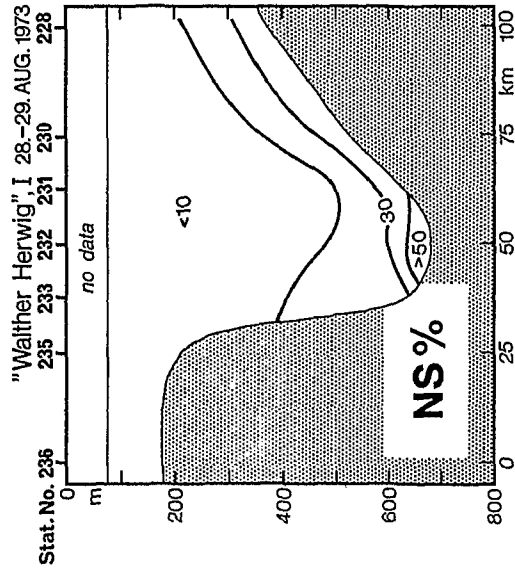
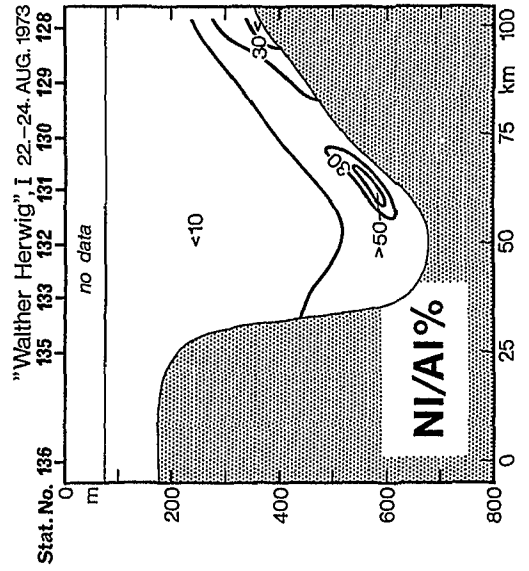
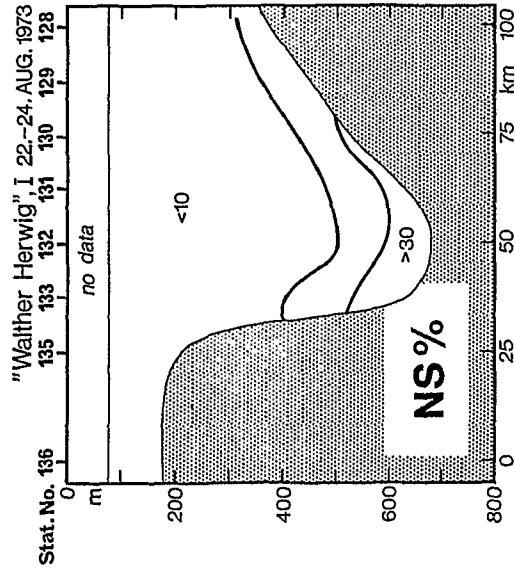
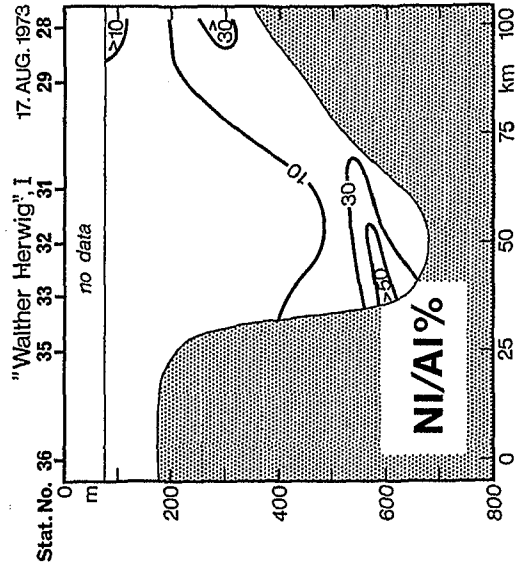
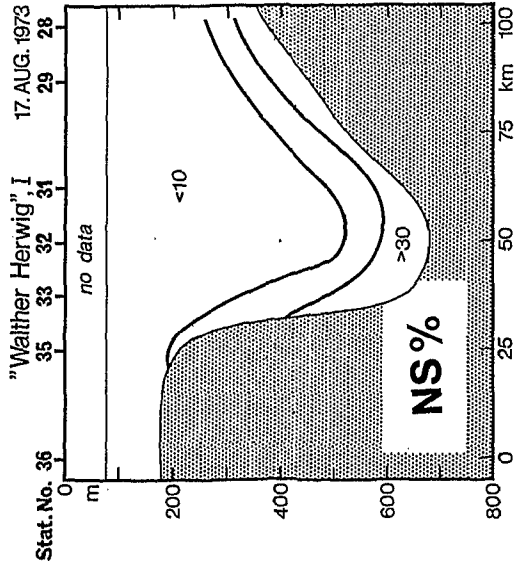



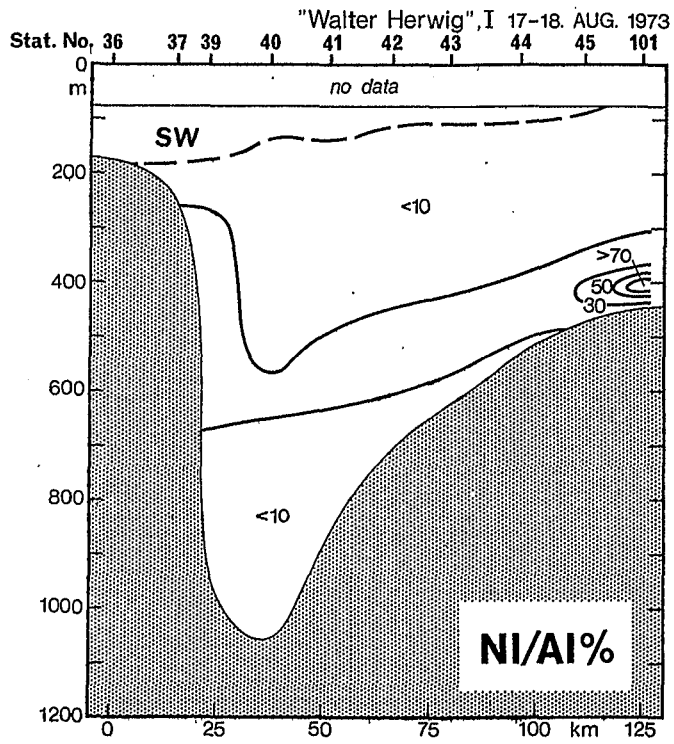
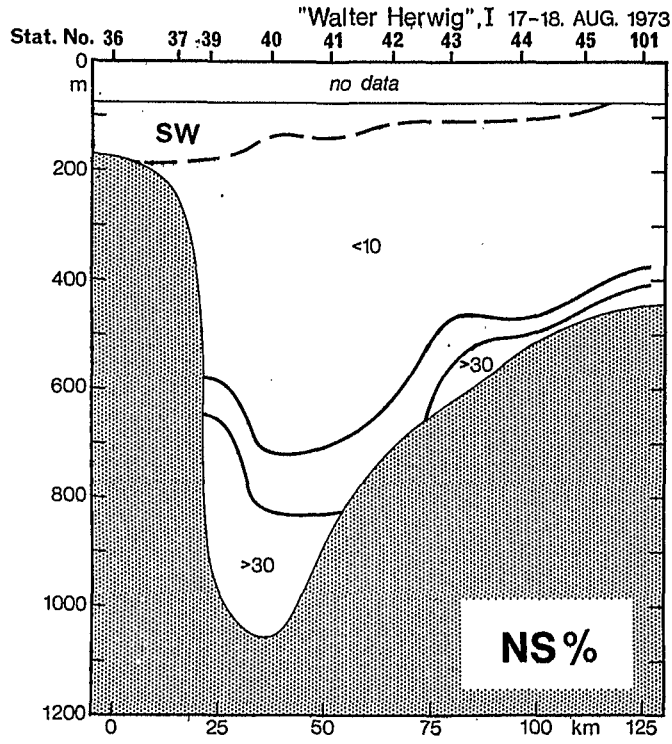

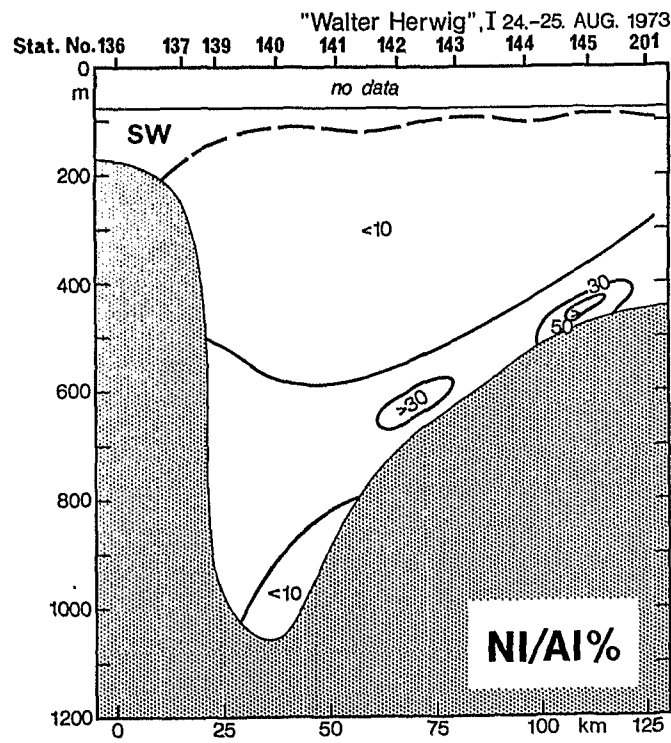
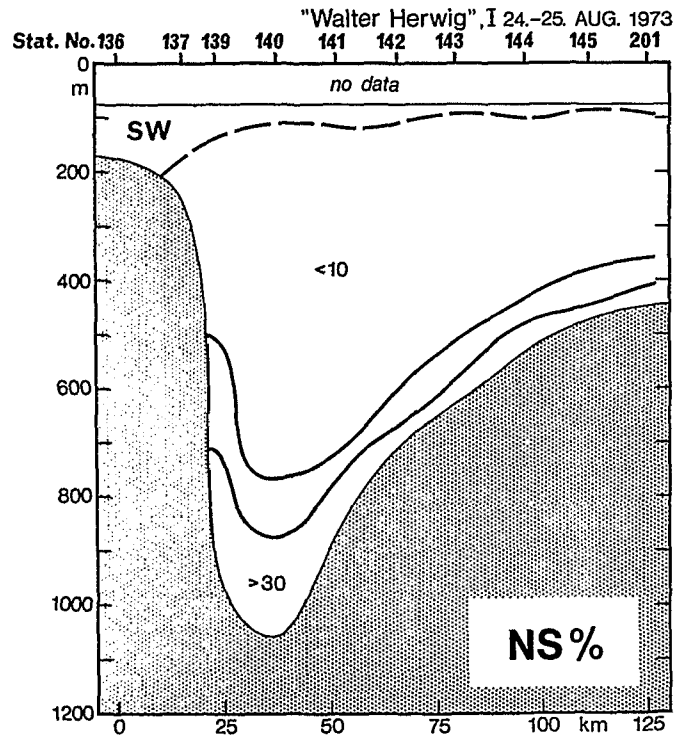

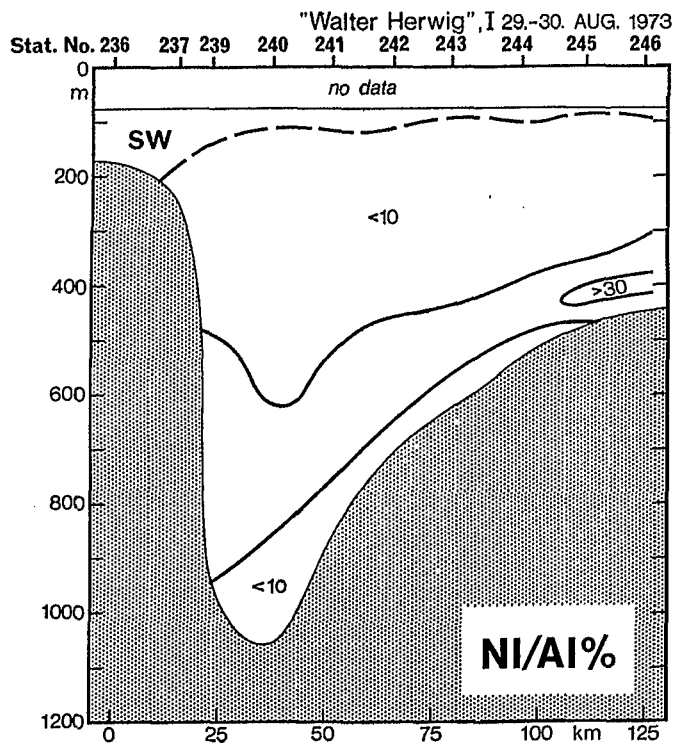
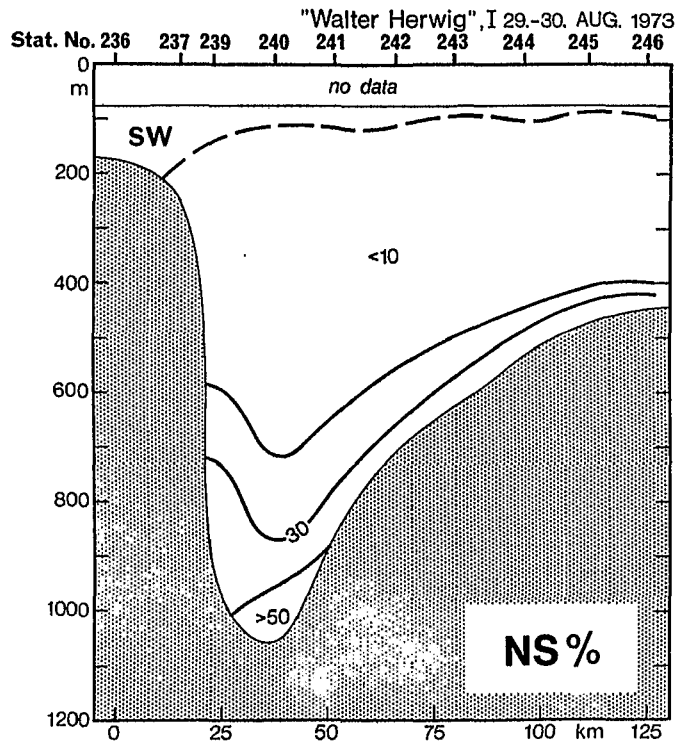

6.11 Hudson

NA is the dominant Atlantic inflow water. IS and LS are observed in the Atlantic basin. As cold overflow P was analysed for the surface at the Greenland side of the ridge, in intermediate layers AI and PI and as deep overflow NS were found. At the southern most section NS and AI could not be separated, and NS has been taken as reference.

Section	Stat.No.	Mixing triangle (see table 3)
31 - 37	31, 32	14
	33 - 37	9, 10
46 - 57	46 - 50	11, 12
	51, 52	11, 12, 13
	54.- 57	9
58 - 67	58 - 60	9
	61	12, 13
	62 - 65	11, 12, 13
	66, 67	11, 12
68 - 74	68 - 71	11, 12
	72, 73	11, 12, 13
	74	14
84 - 94	84	12
	85, 86	11, 12, 13
	87 - 93	11, 13
	94	11
94 - 104	94	11
	96 - 98	11, 13
	99 - 103	11, 13
	104	12
111 - 120	111, 112	12, 13
	113	11, 12, 13
	114 - 120	11, 13
105 - 130	105	11, 13
	109, 110, 114	11, 12, 13
	122 - 124, 127, 128, 130	11, 12, 13

## Hudson (cont'd)

Section	Stat.No.	Mixing triangles (see table 3)
138 - 145	138 - 142	9, 10
	144, 145	9
147 - 157	147, 148	9
	149 - 153	14
	154, 155	11, 12, 13
	156, 157	11, 12
157 - 167	157 - 160	11, 12
	161 - 164	11, 12, 13
	165 - 167	12
175 - 181	175	11, 12
	176 - 181	11, 13
188 - 197	188	9
	189, 190	9, 10
	191 - 195	14
	196	11, 12, 13
	197	11, 12
200 - 203		9, 10
182 - 194	182, 183	12, 13
	184	11, 12, 13
	194	11, 12

# OVERFLOW '73 "HUDSON"

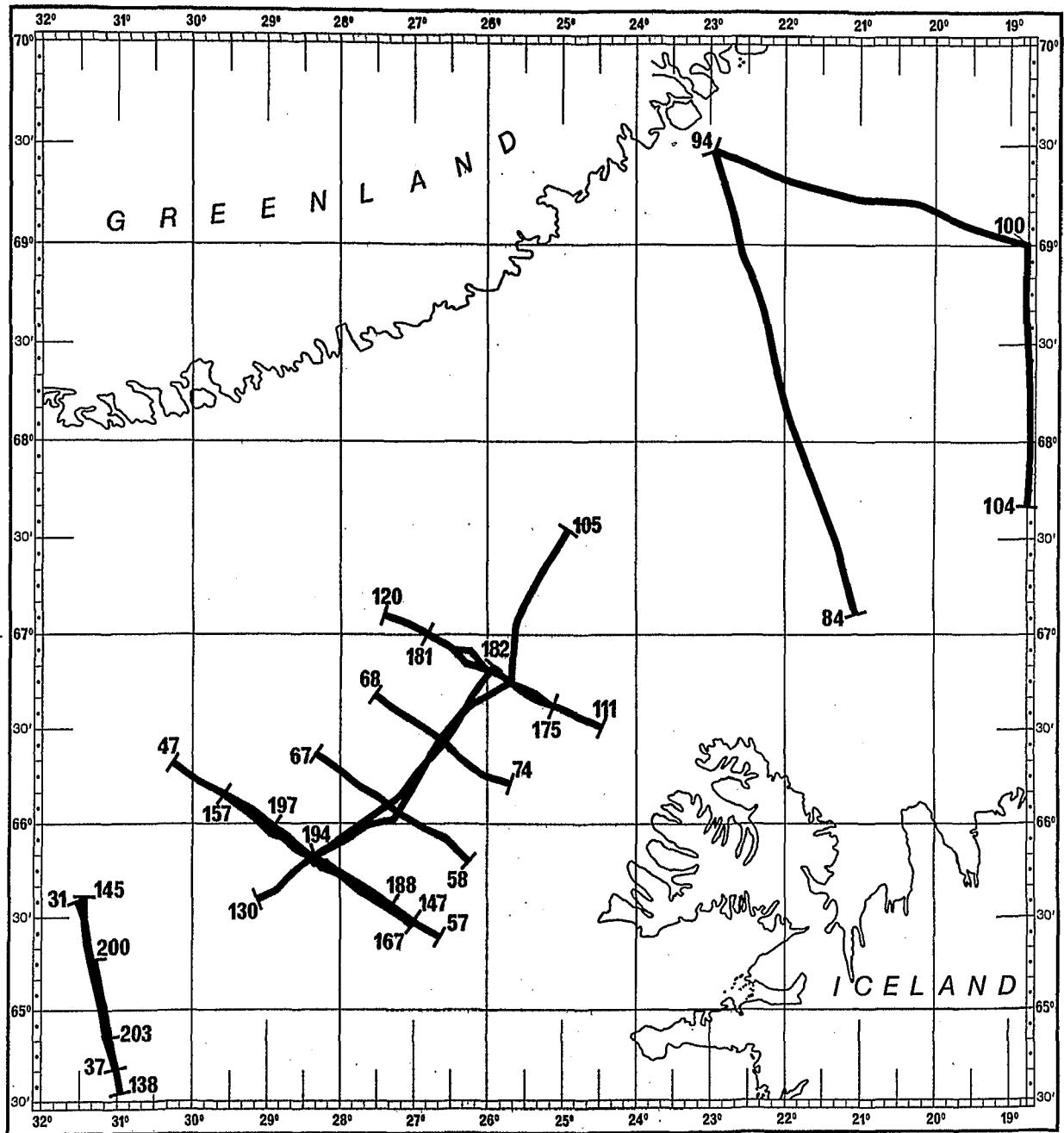

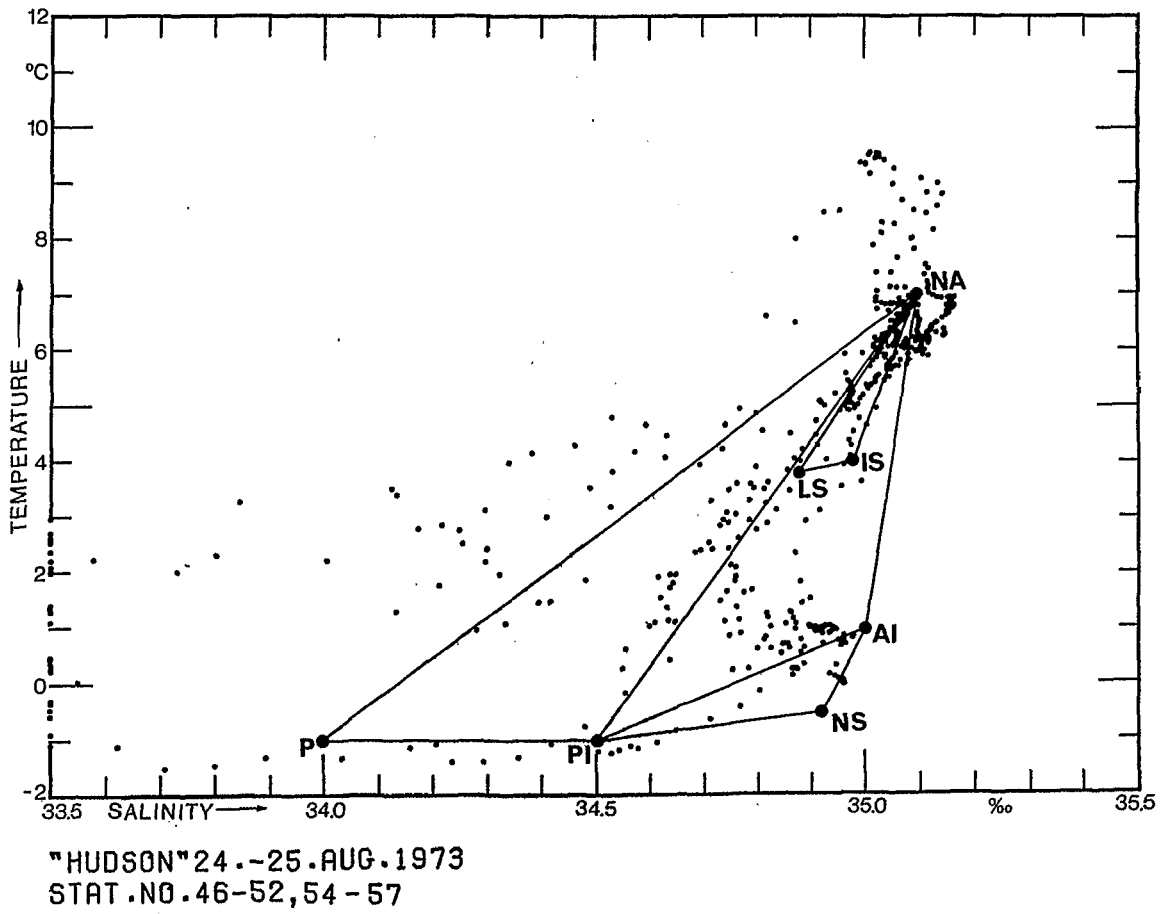
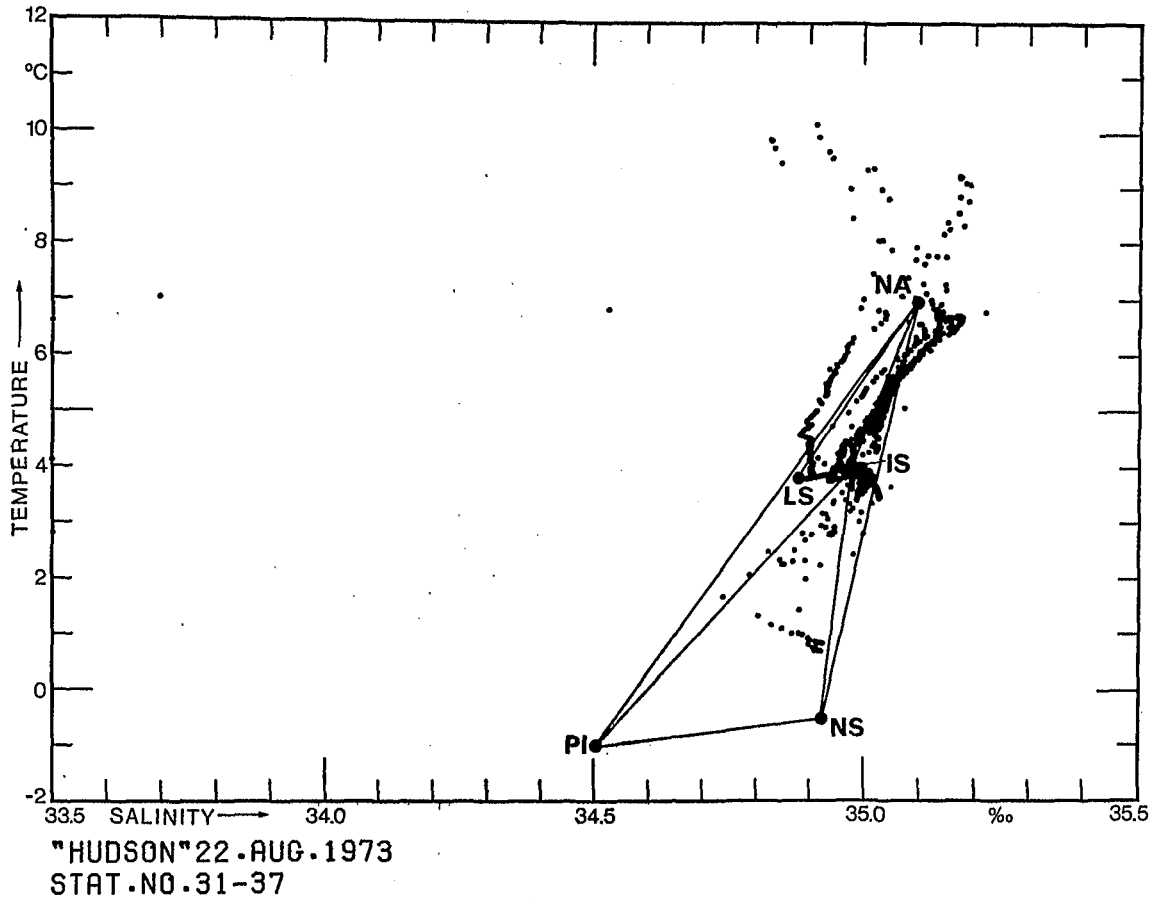

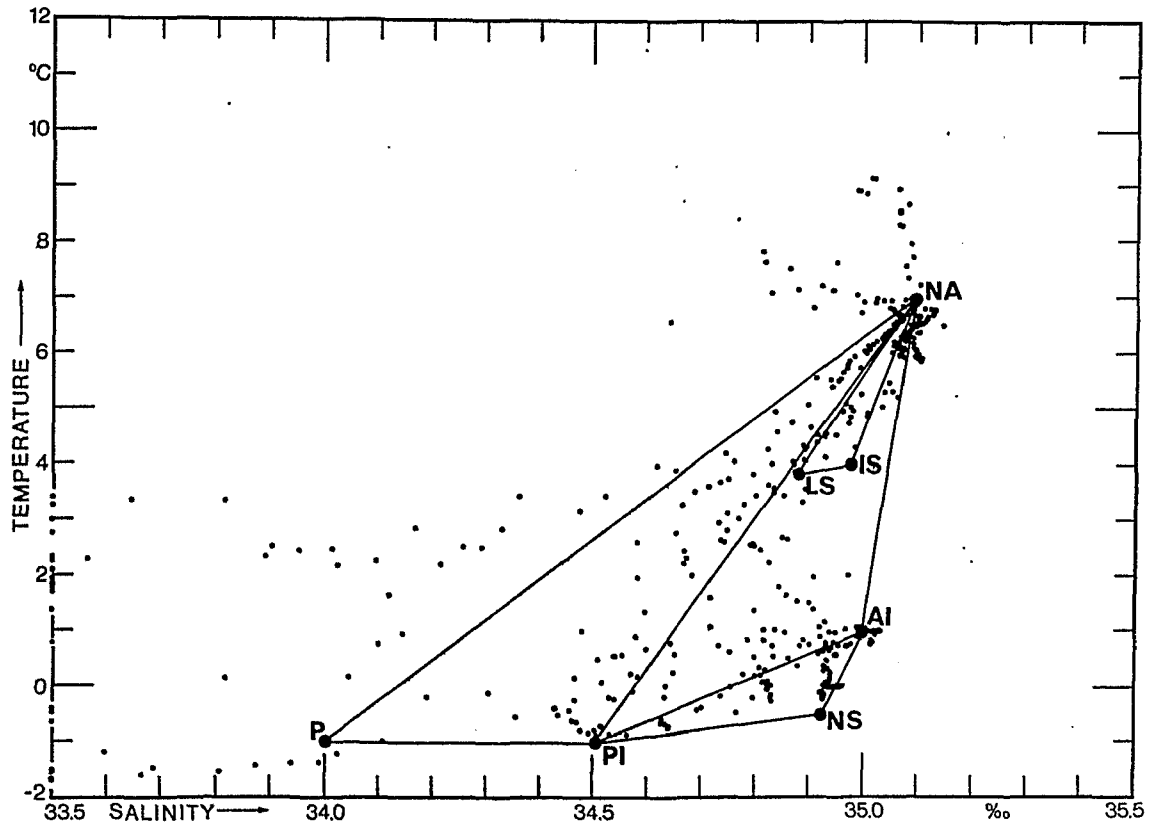

"HUDSON" 25.-26.AUG.1973  
STAT.NO.58-62,64-67

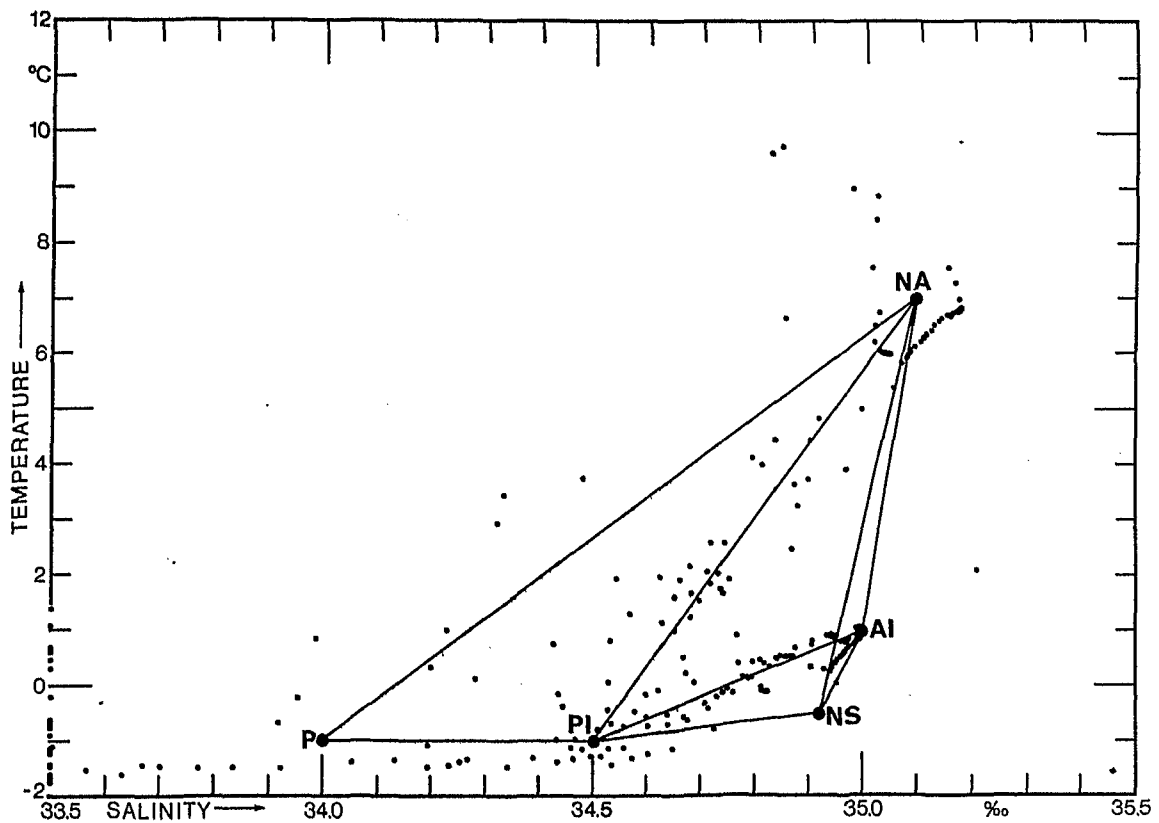

"HUDSON" 26.-27.AUG.1973  
STAT.NO.68-74



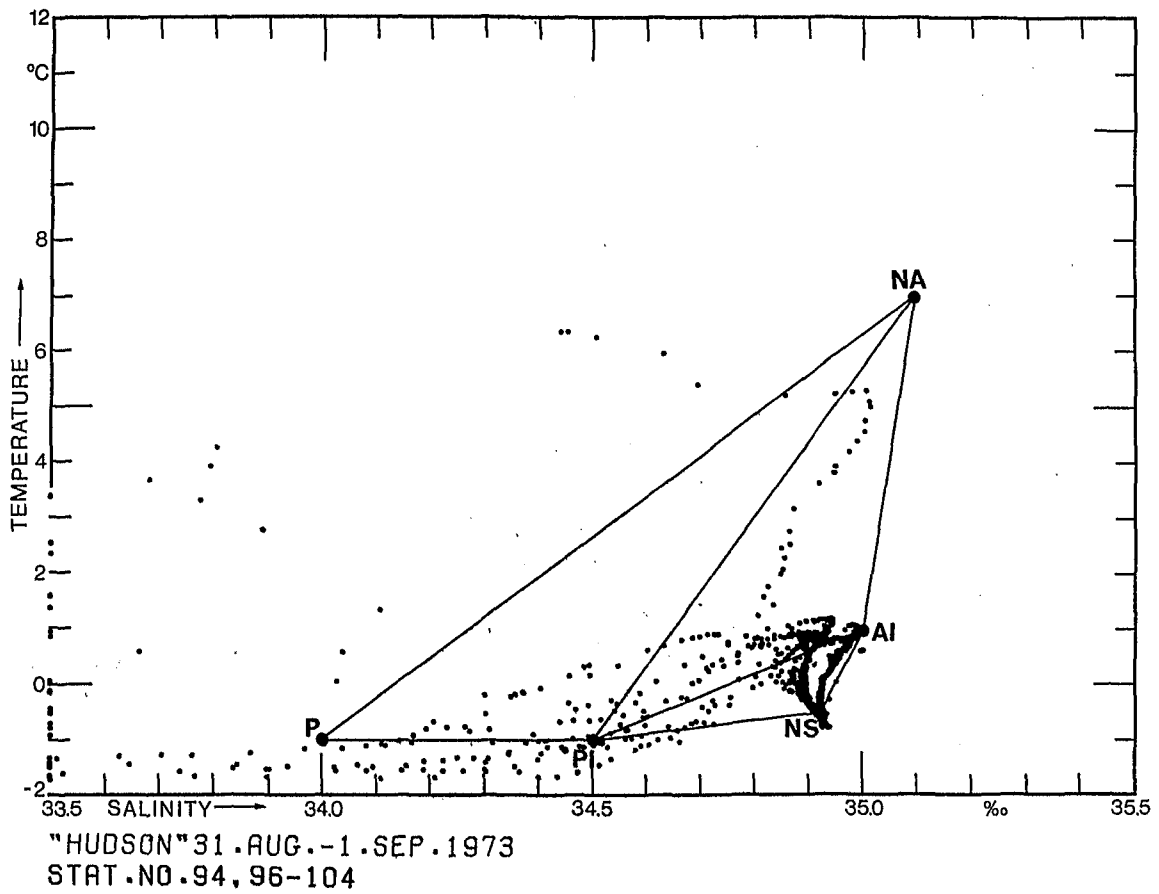
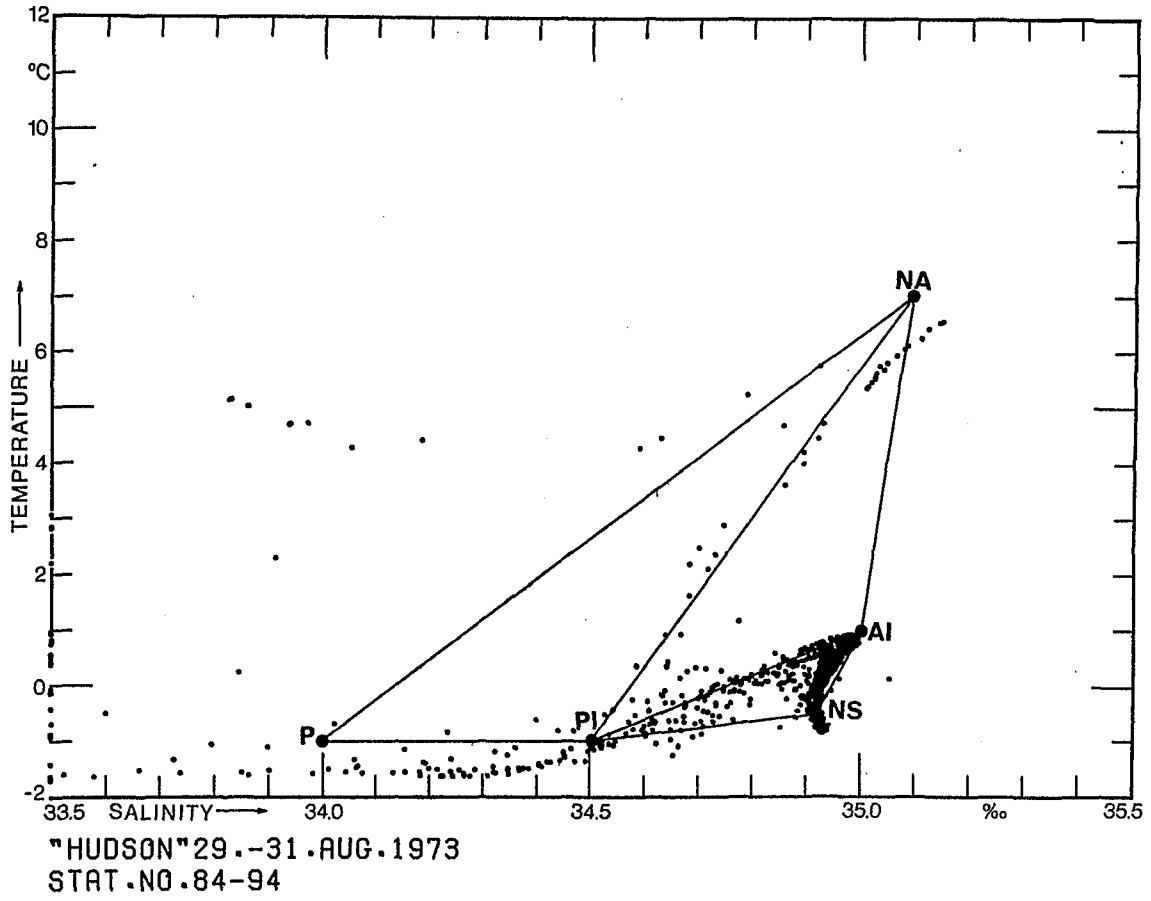

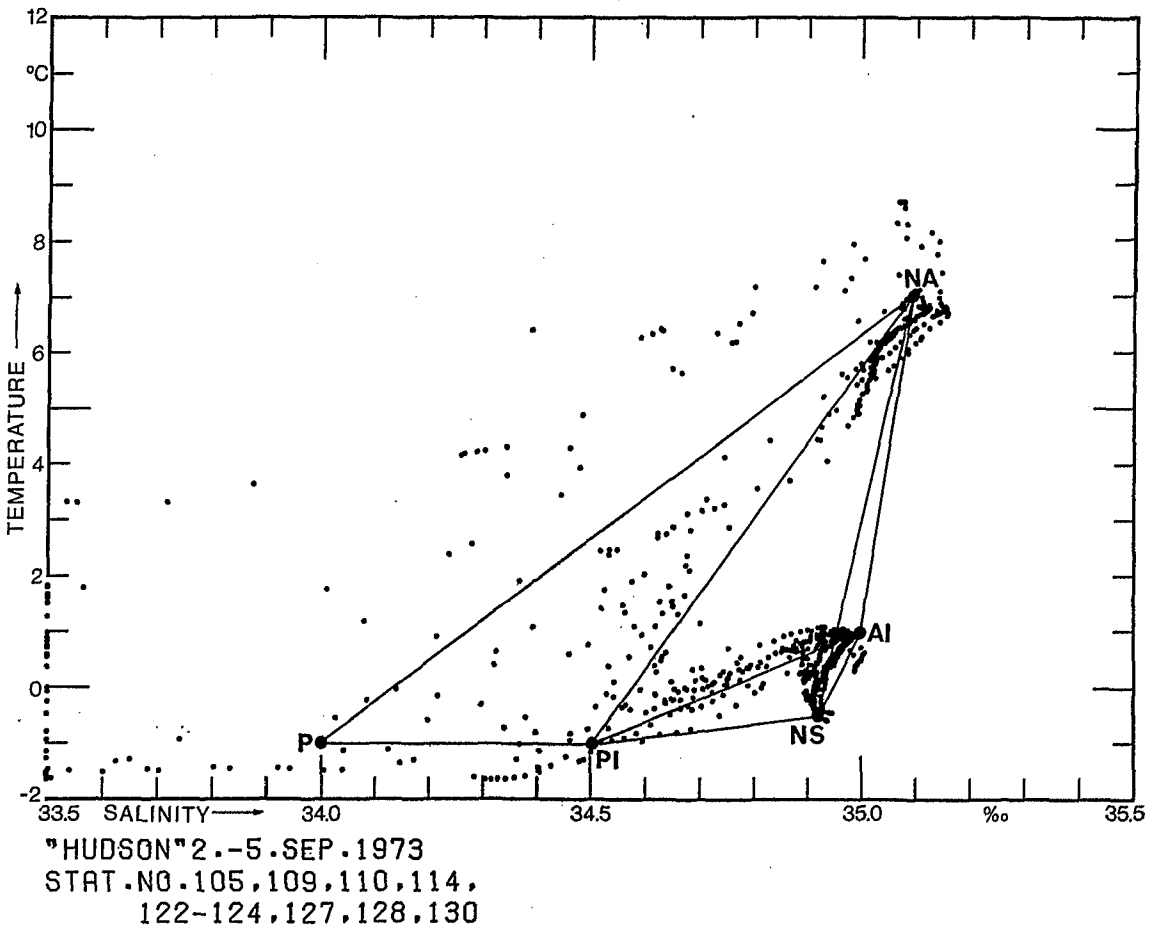
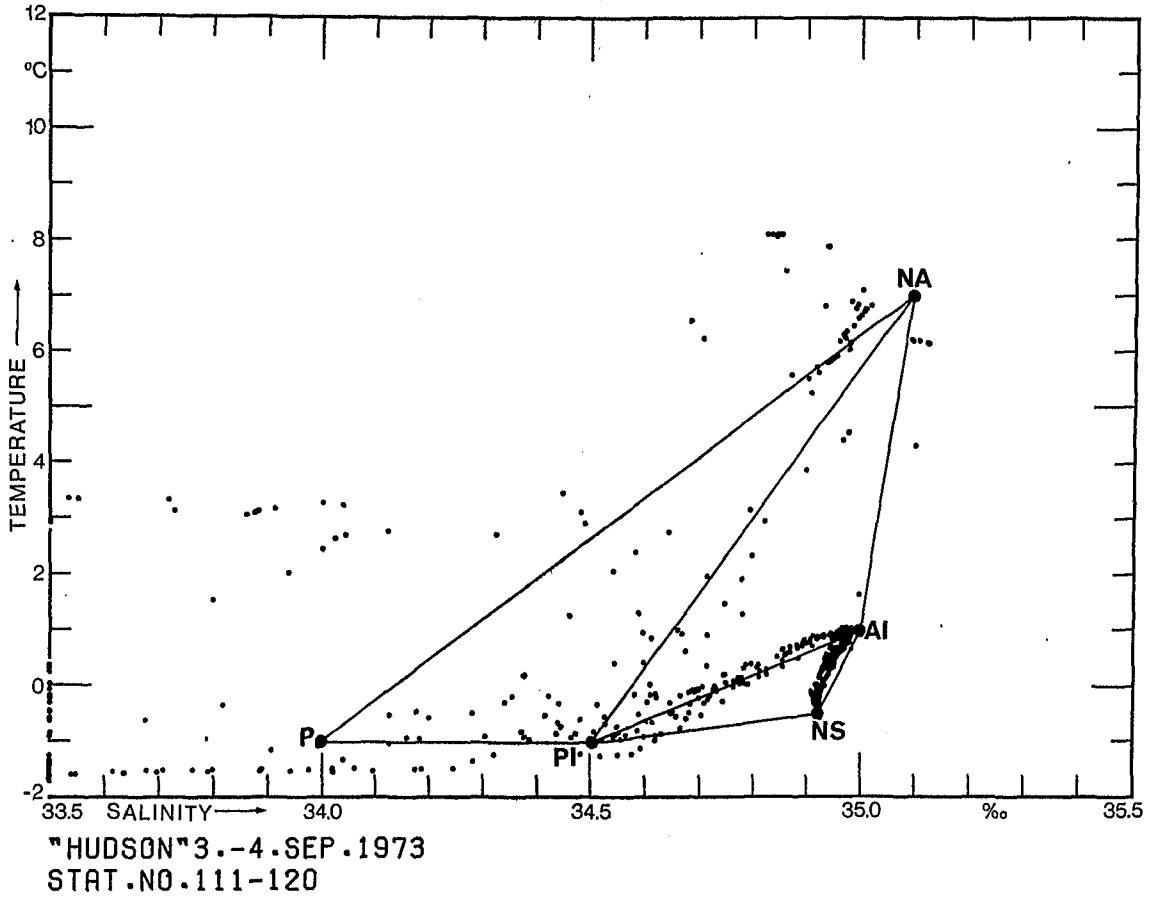

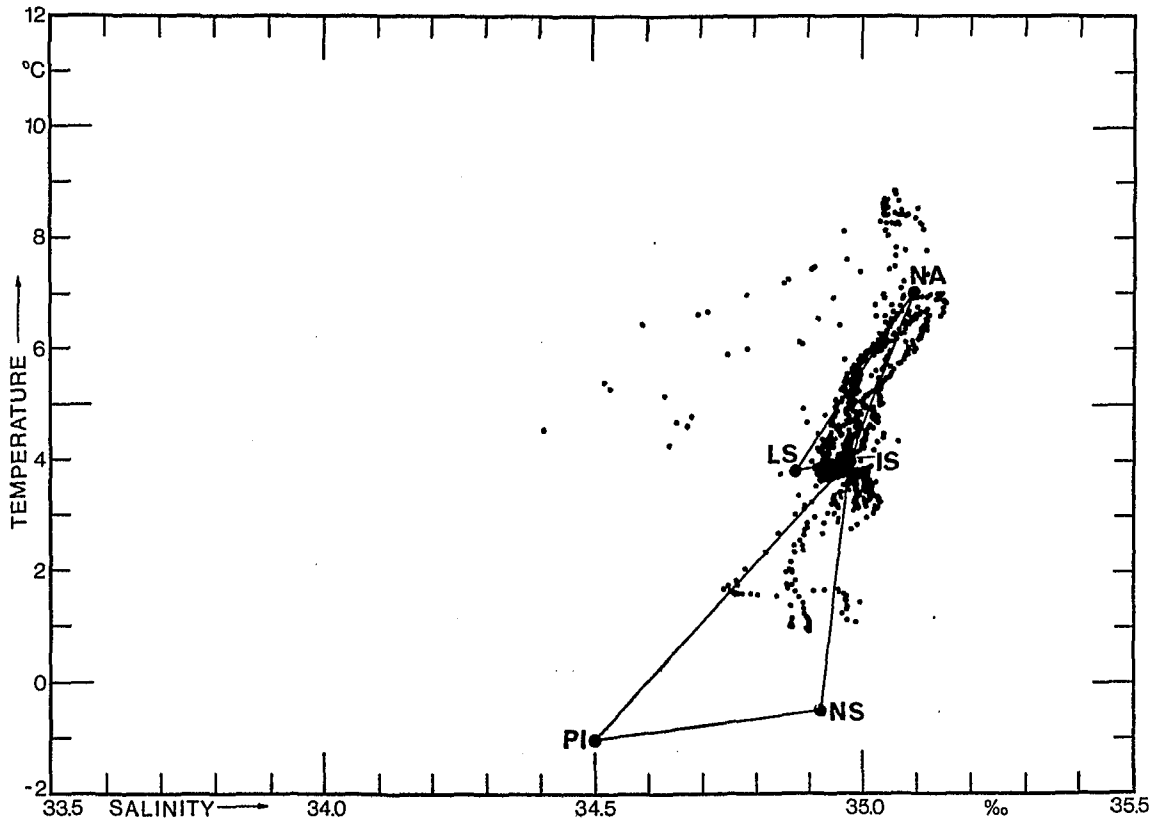

"HUDSON" 5.-6.SEP.1973  
 STAT.NO.138-142,144,145

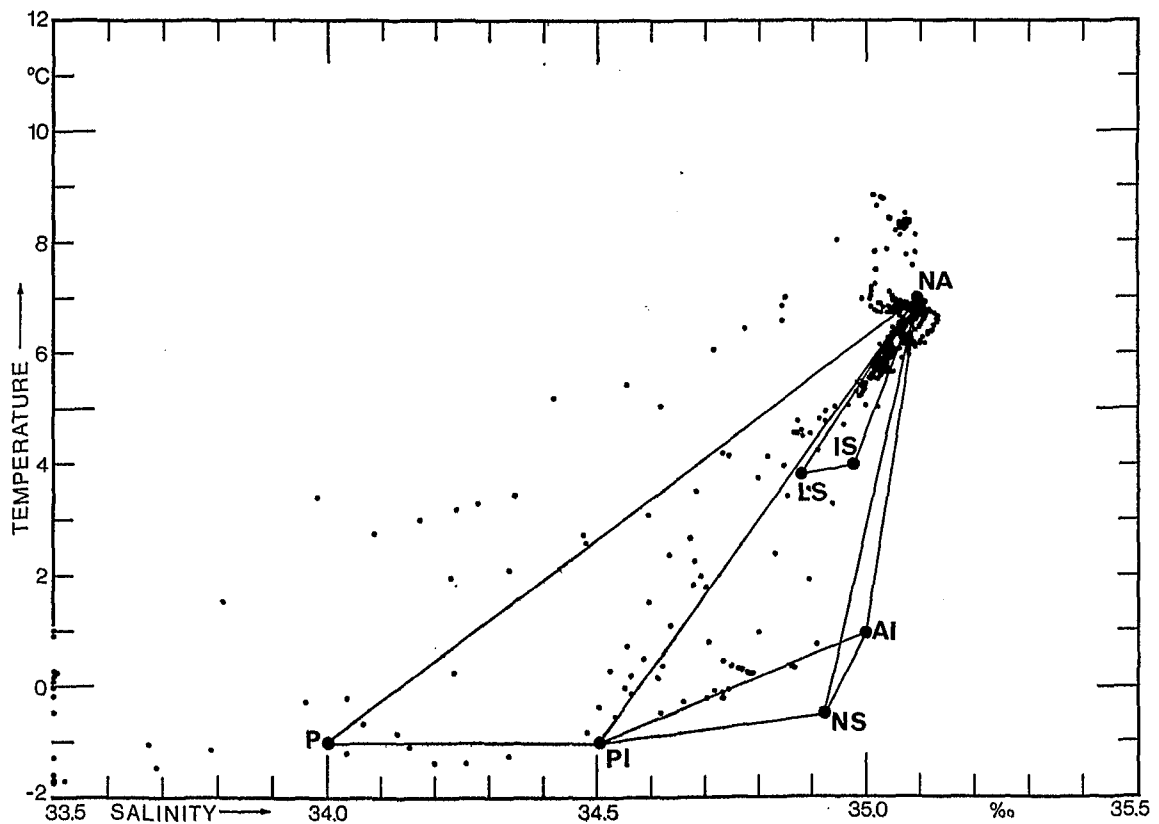

"HUDSON" 7.-8.SEP.1973  
 STAT.NO.147-157

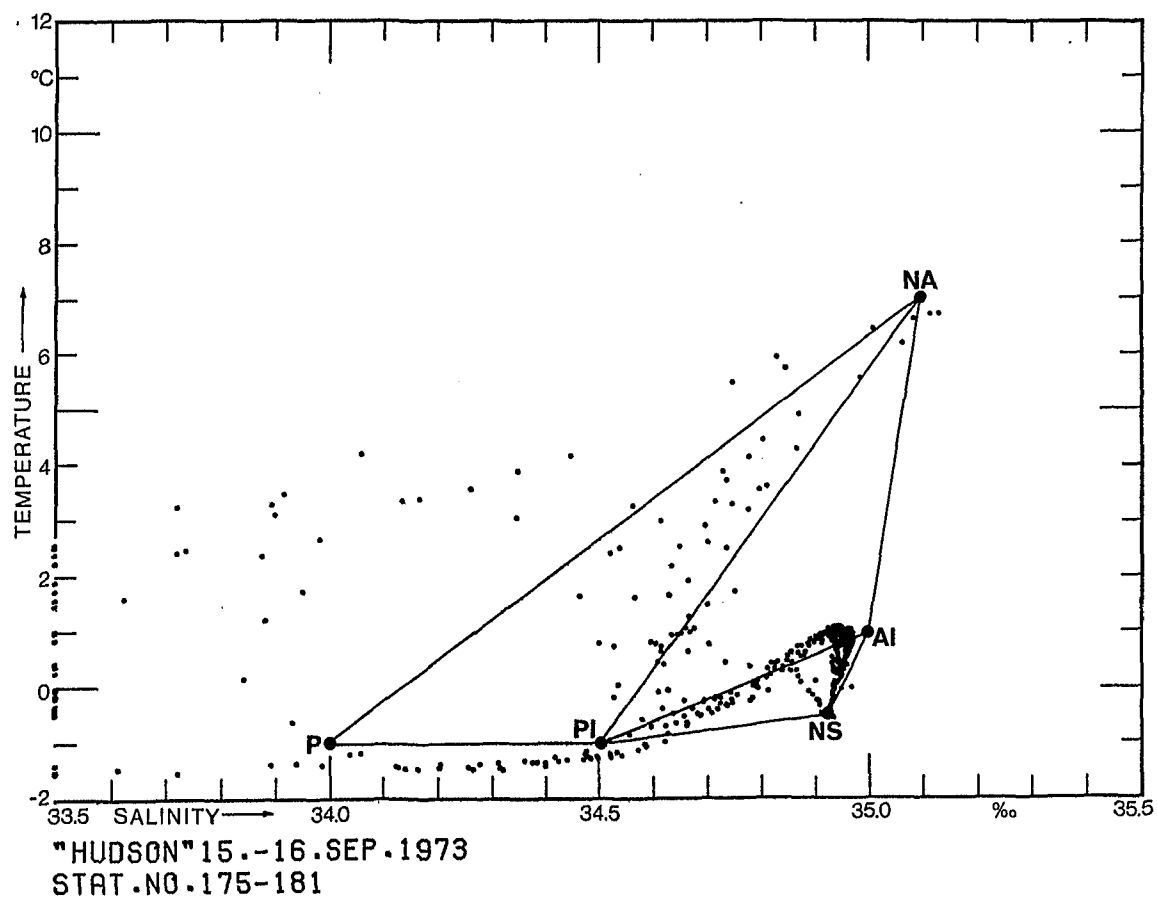
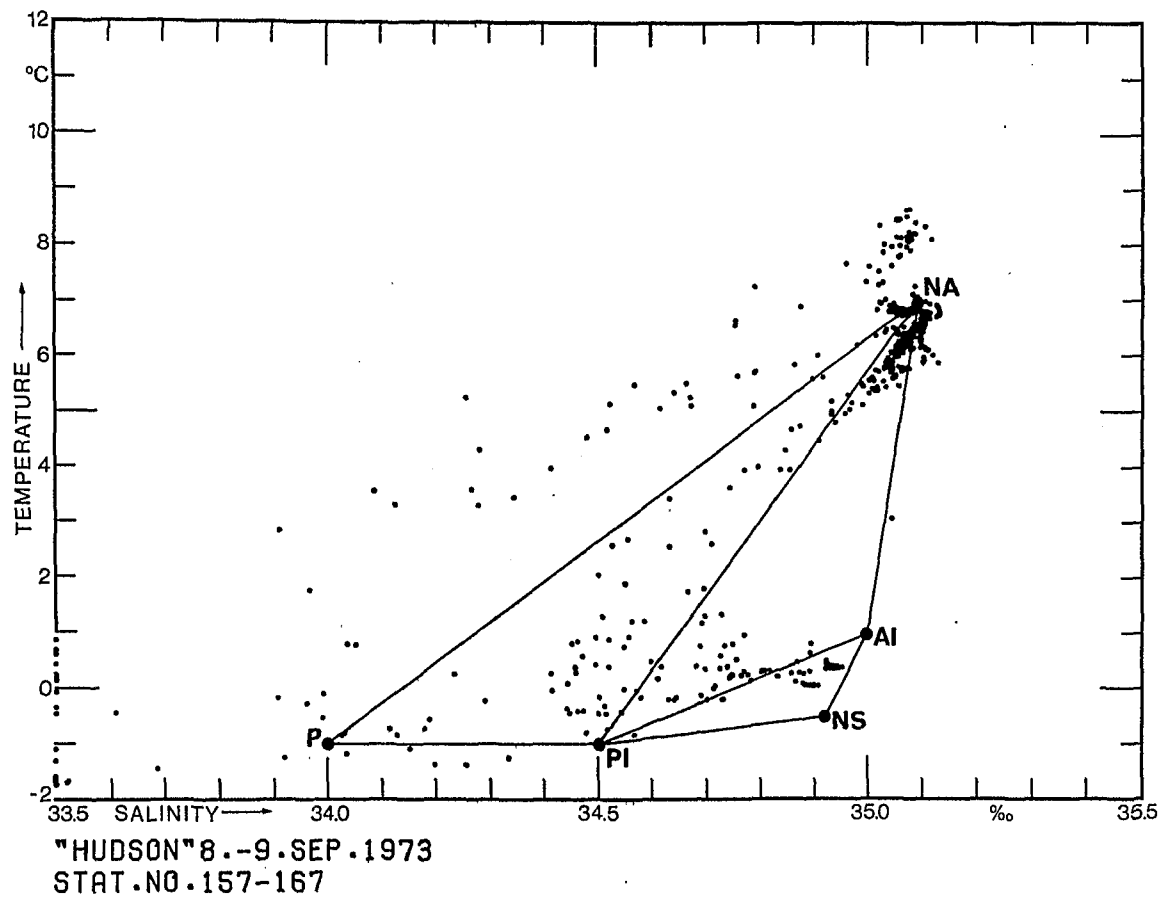

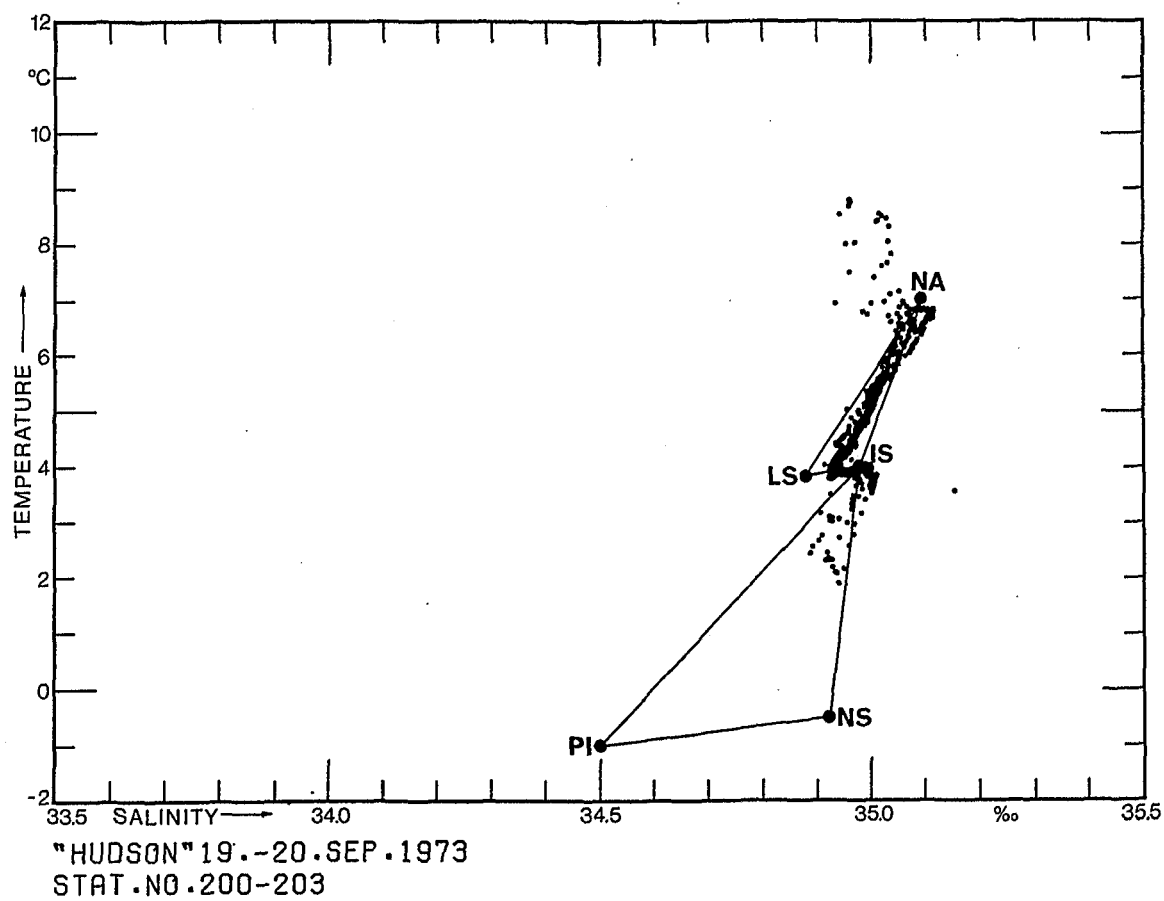
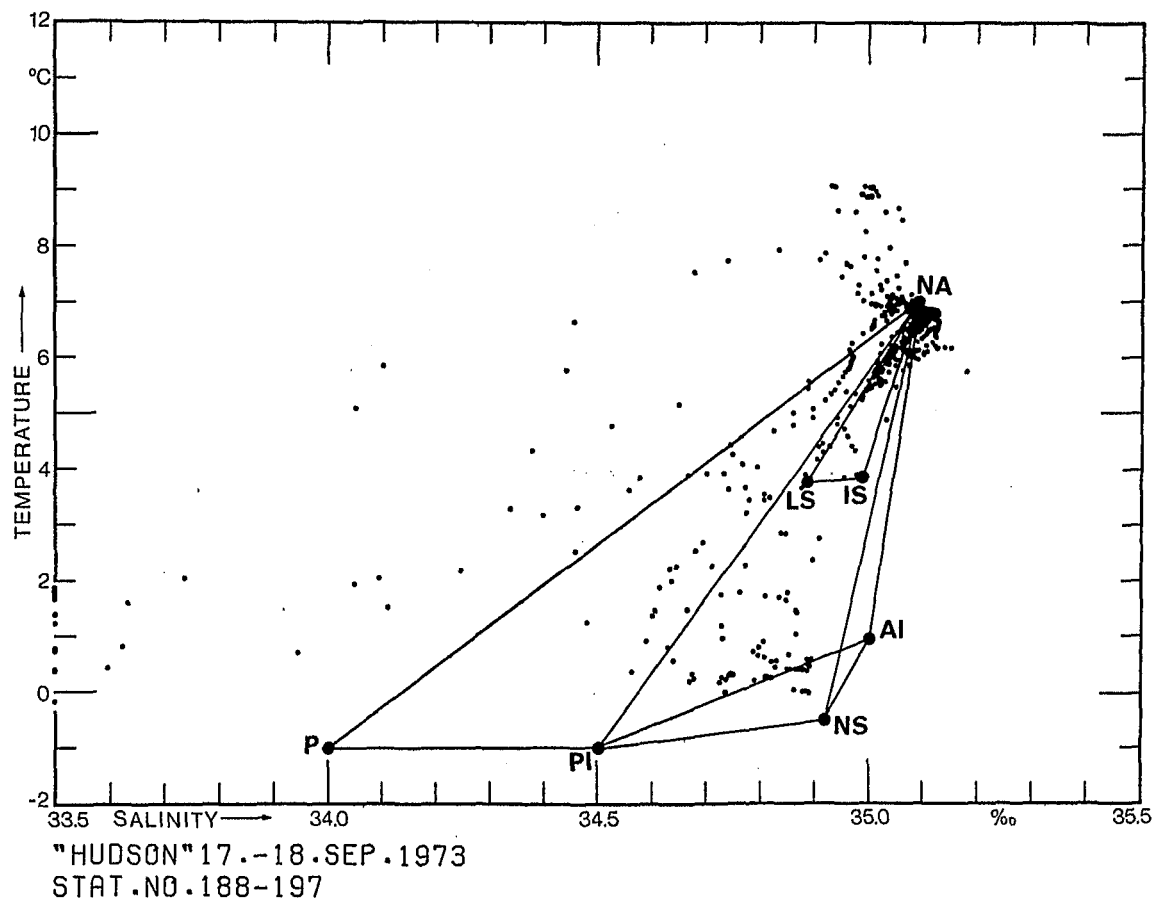

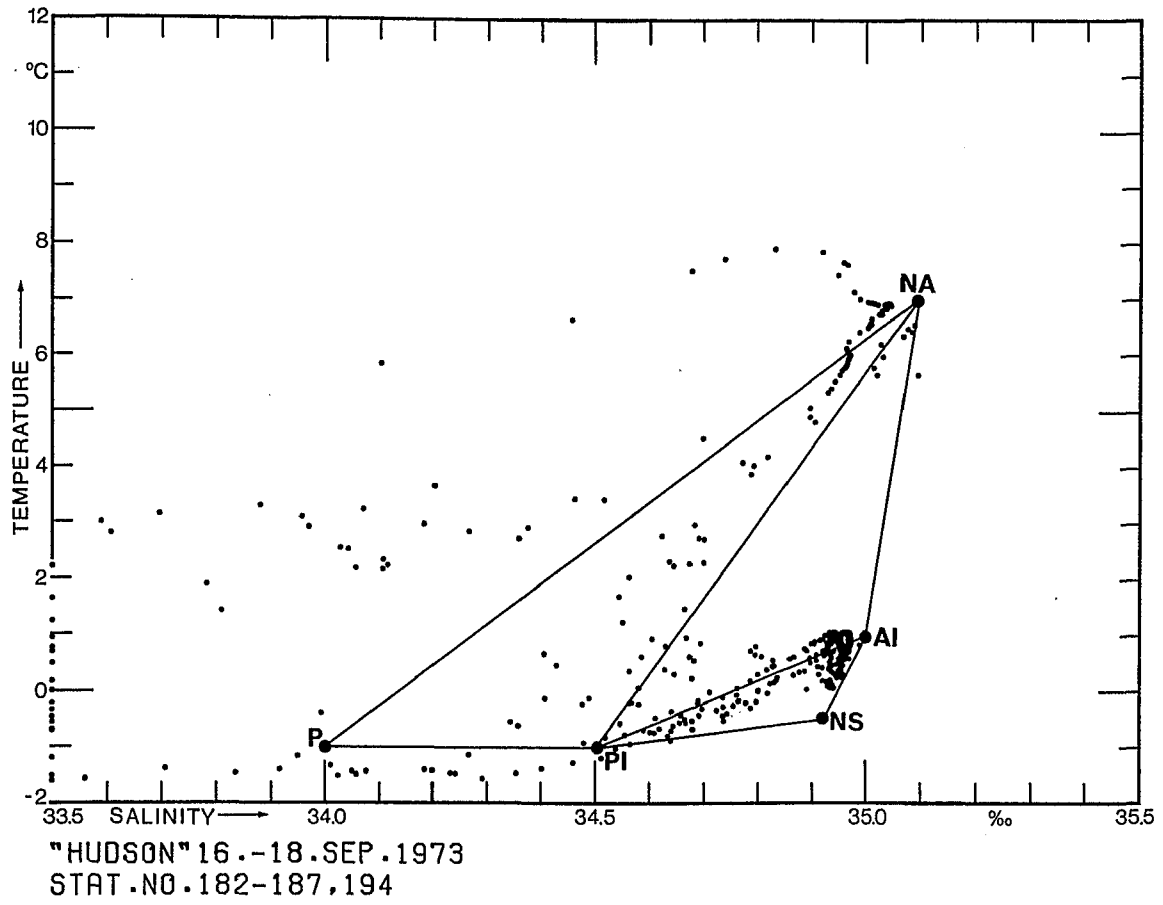

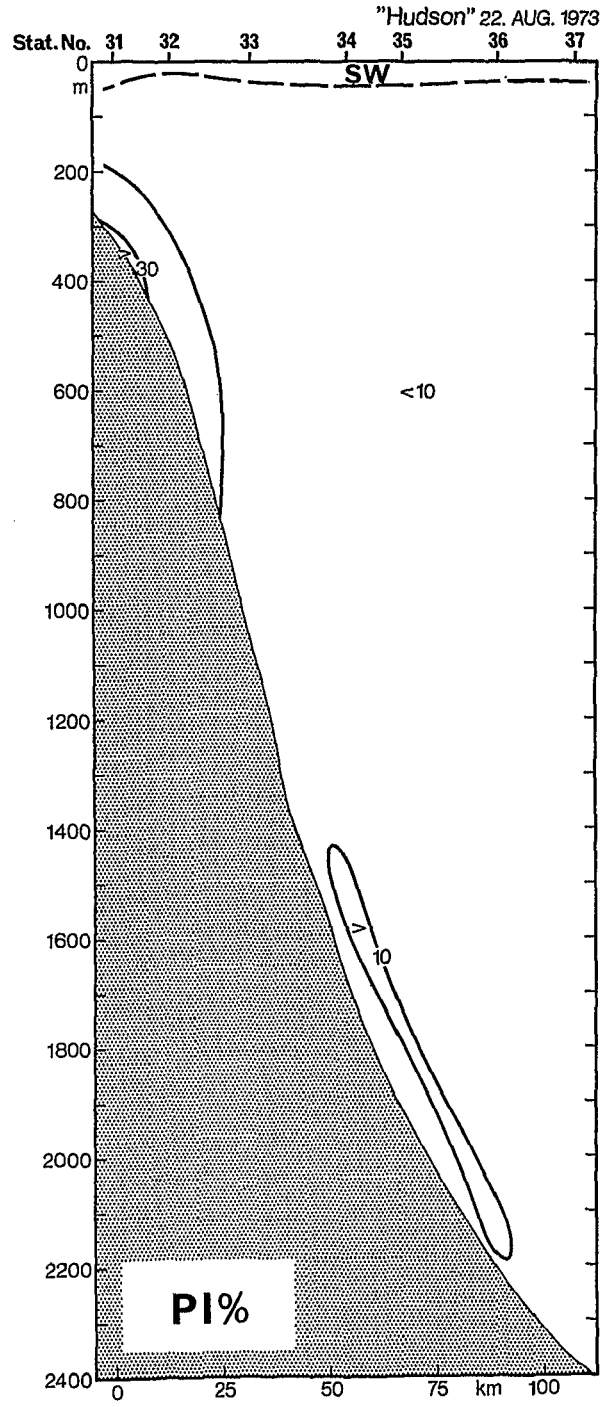
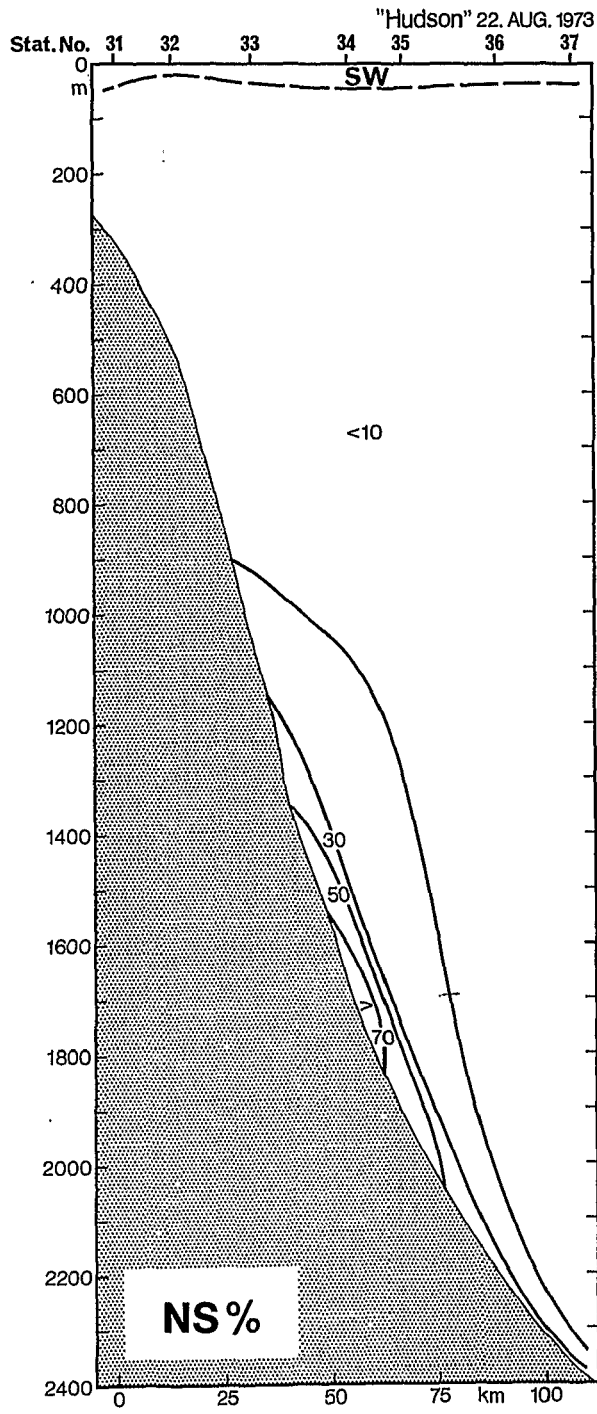

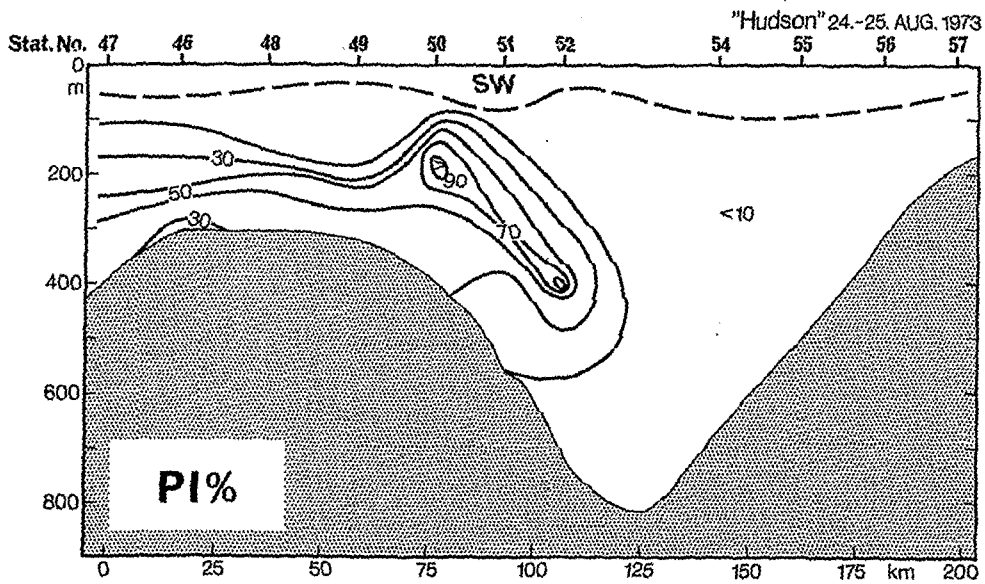
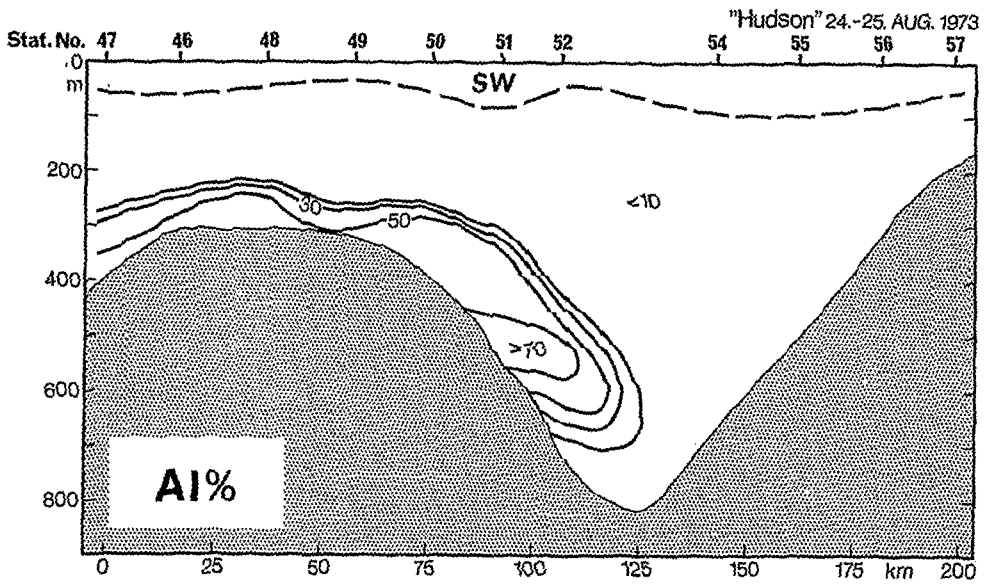
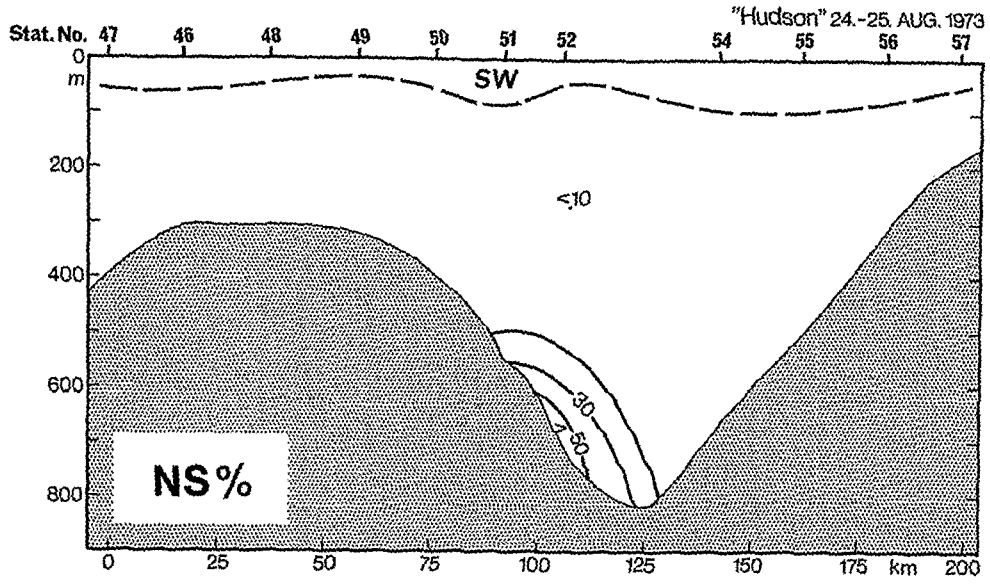



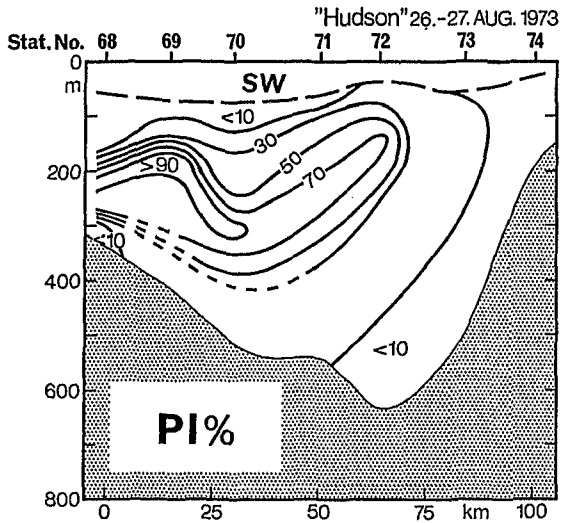
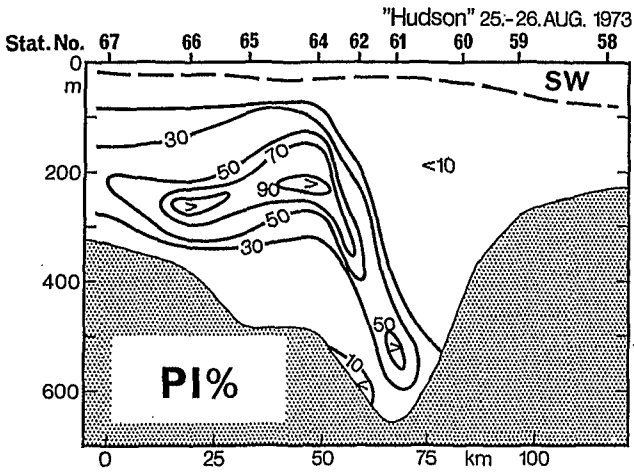
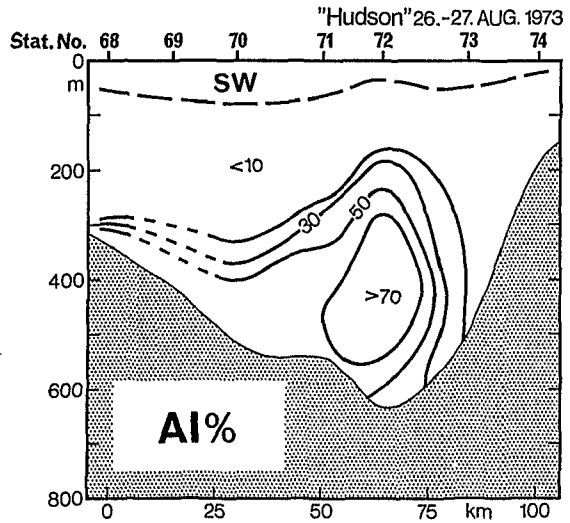
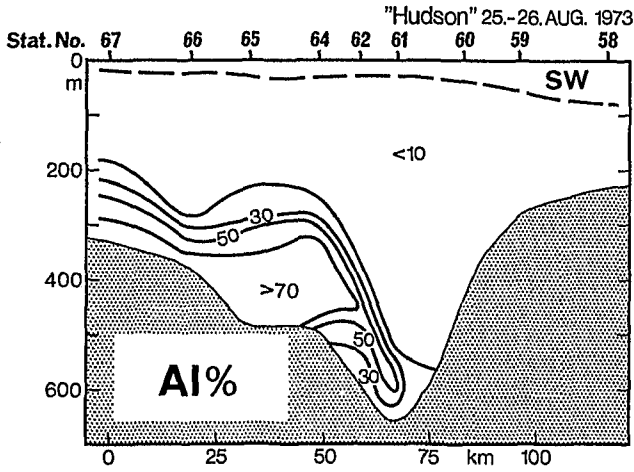
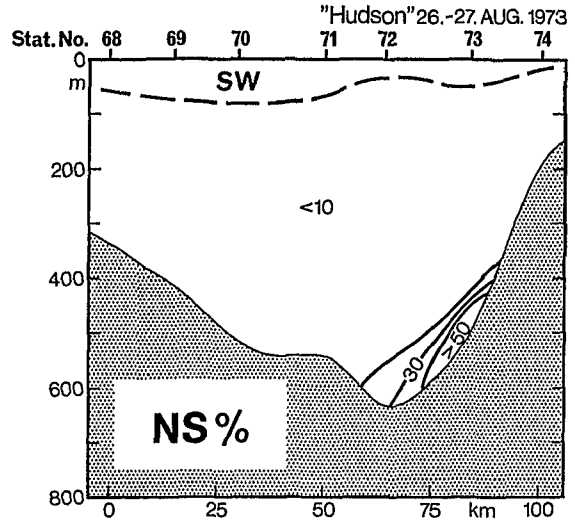
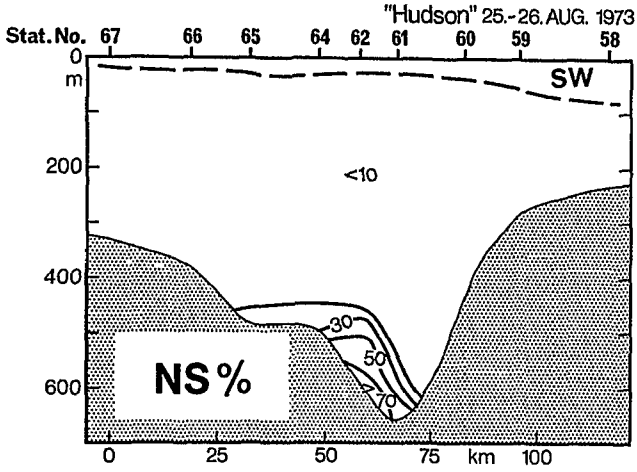

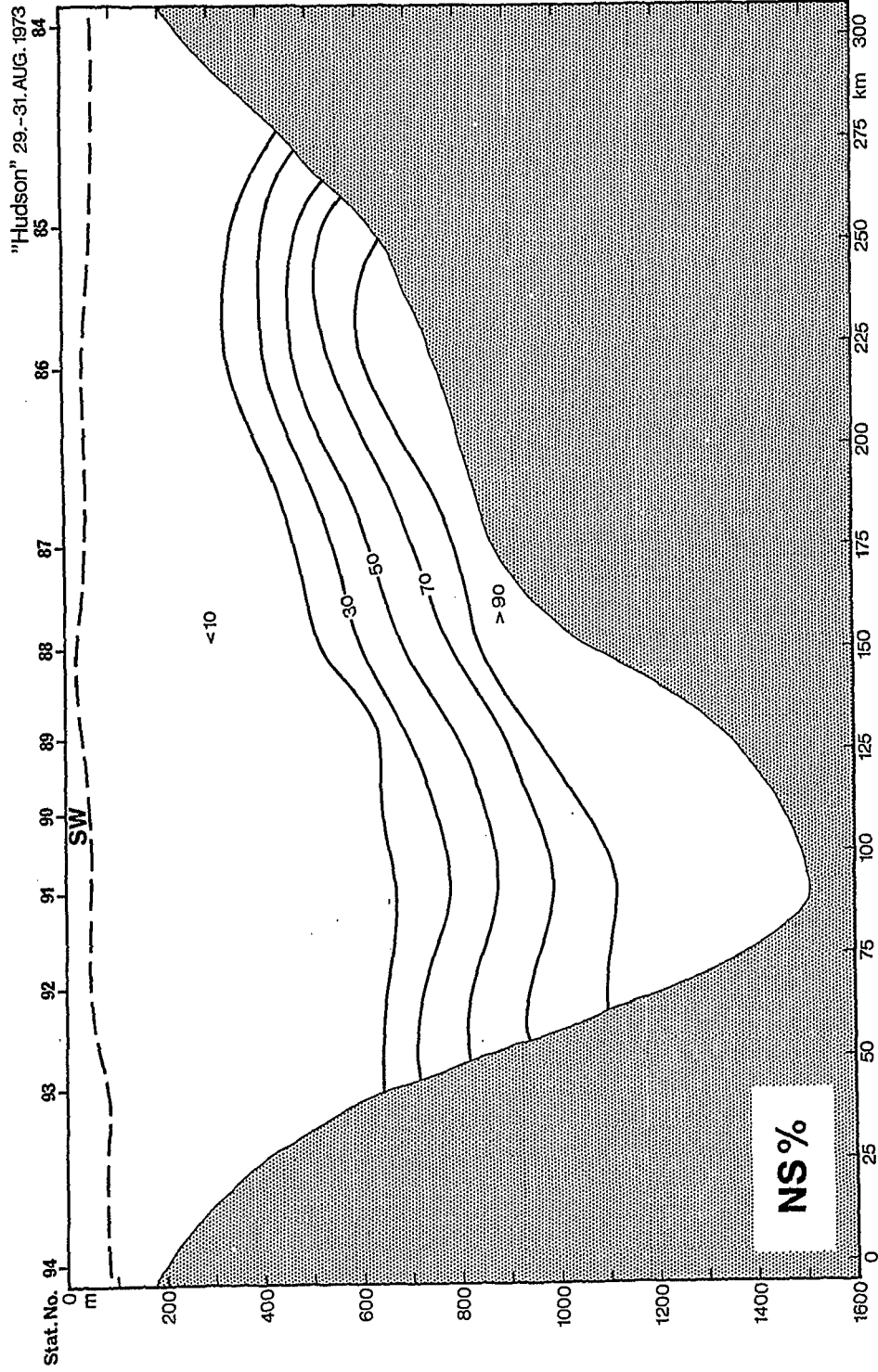

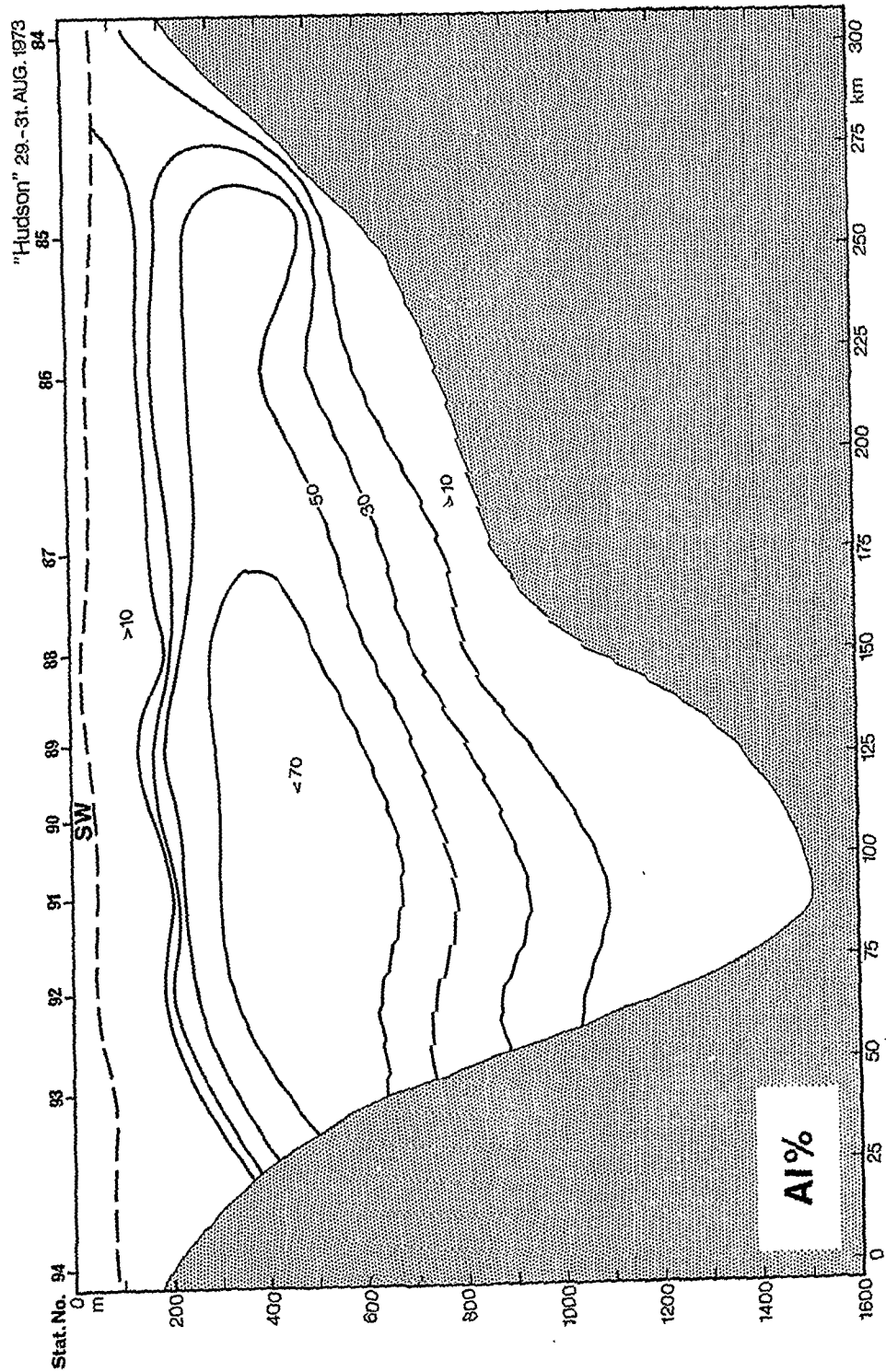

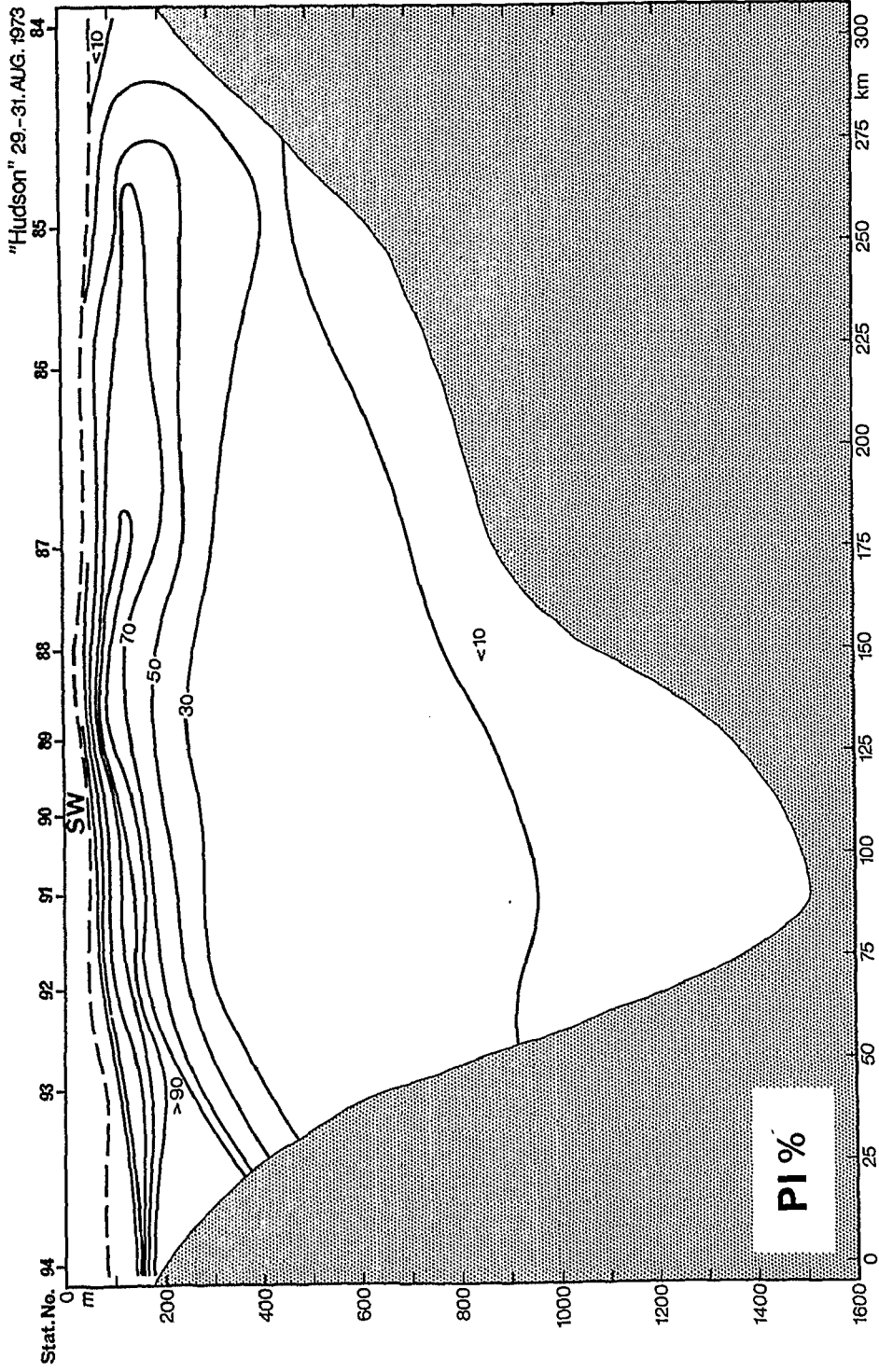

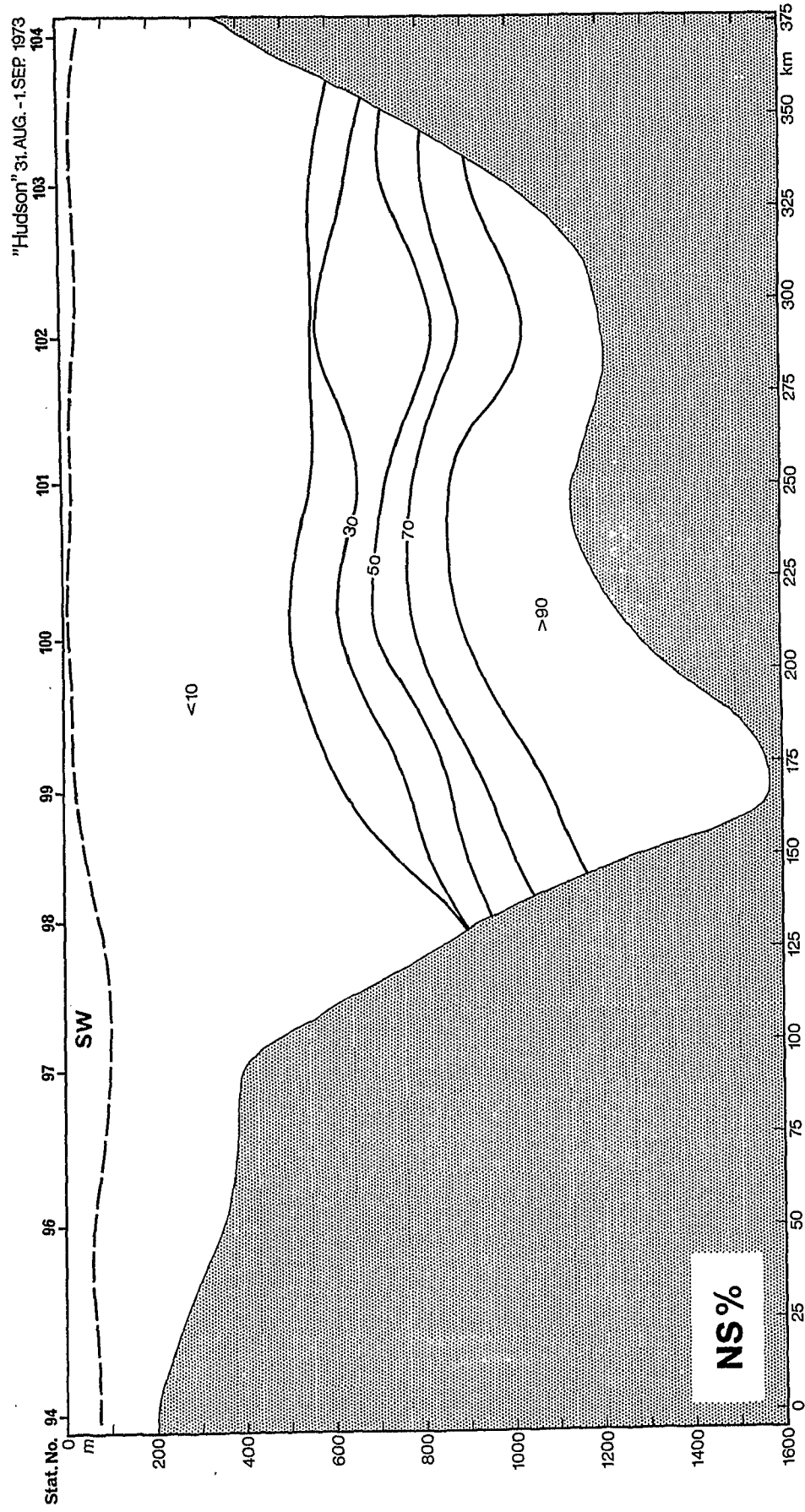

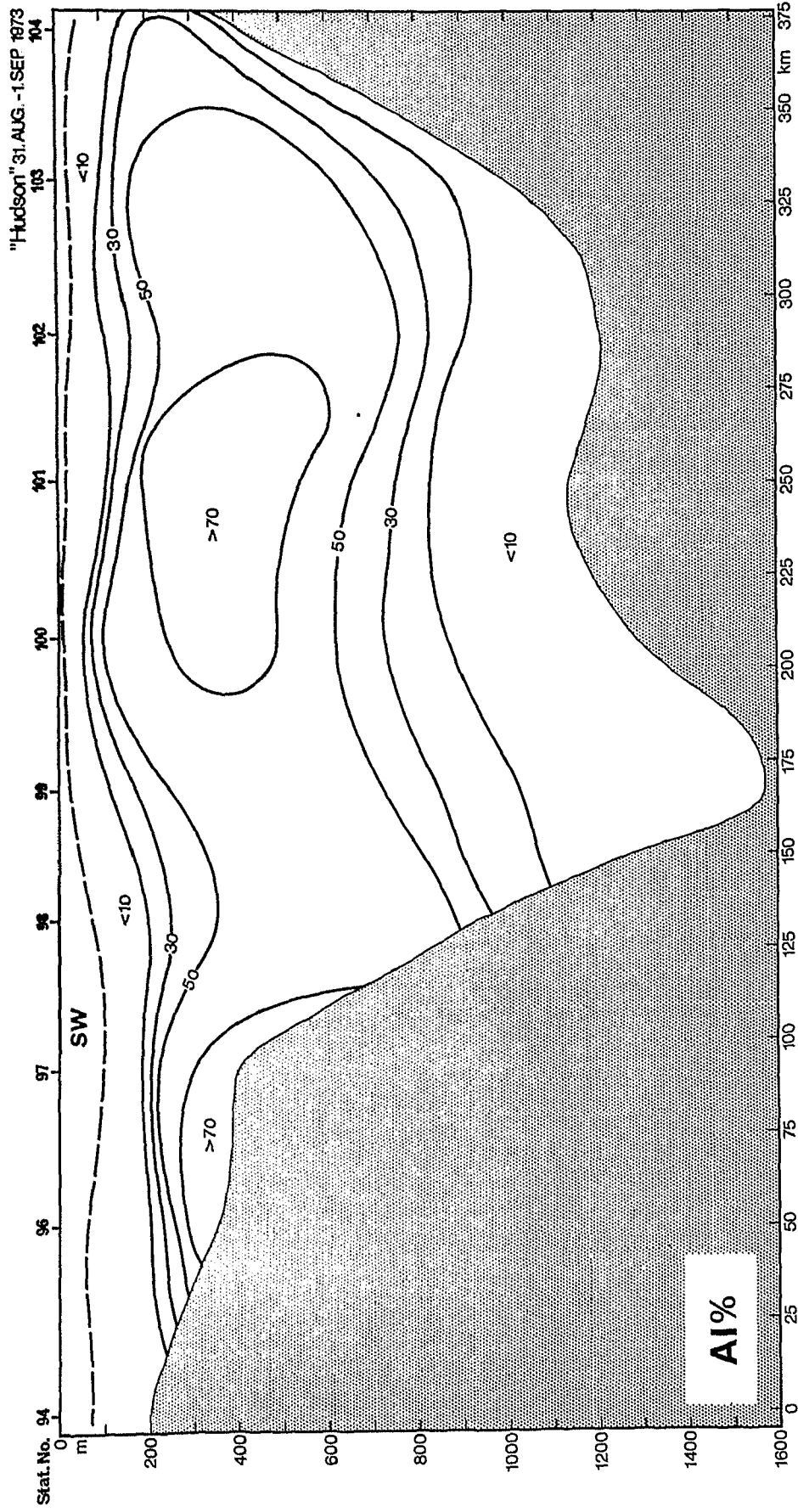

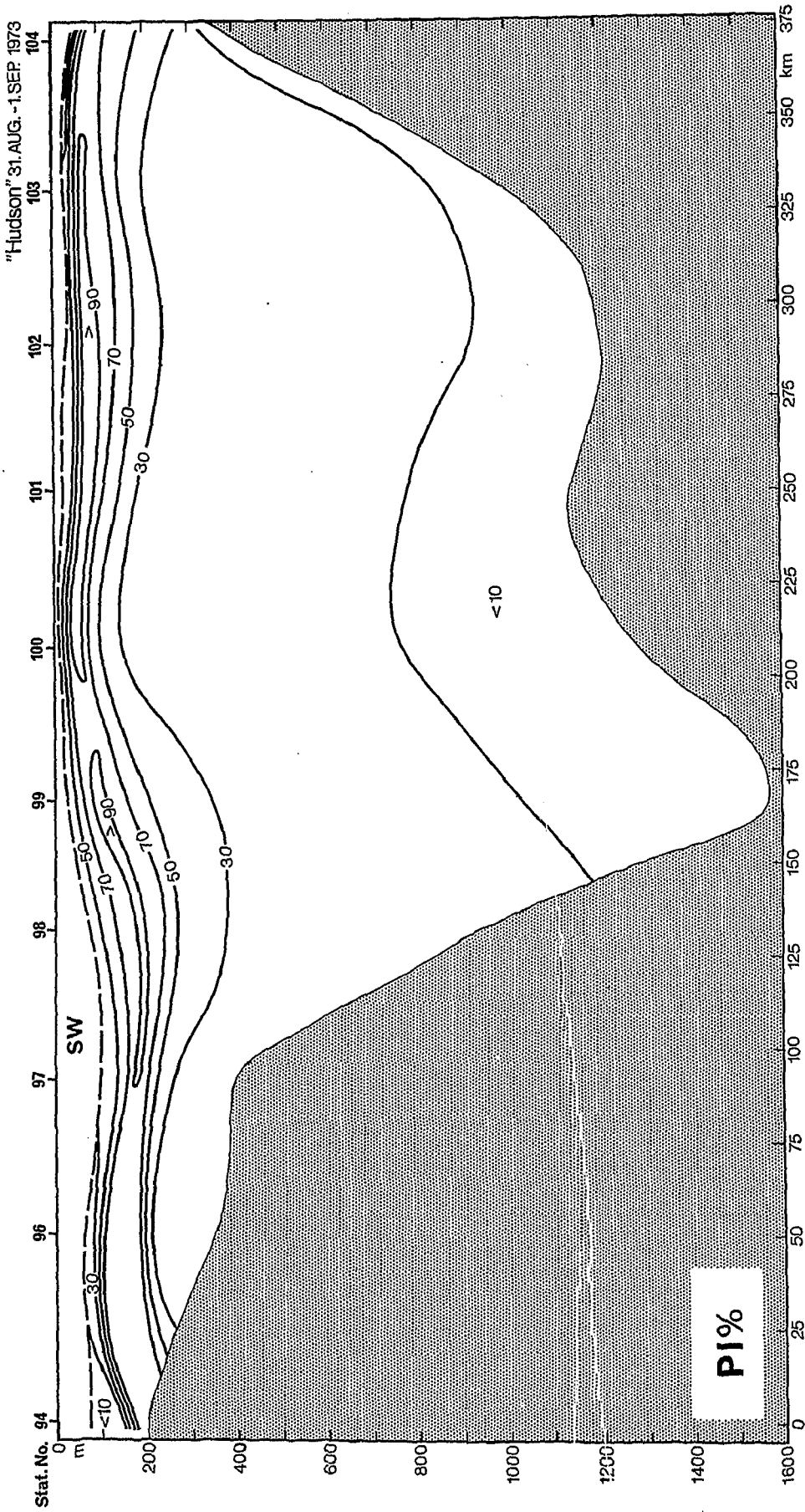

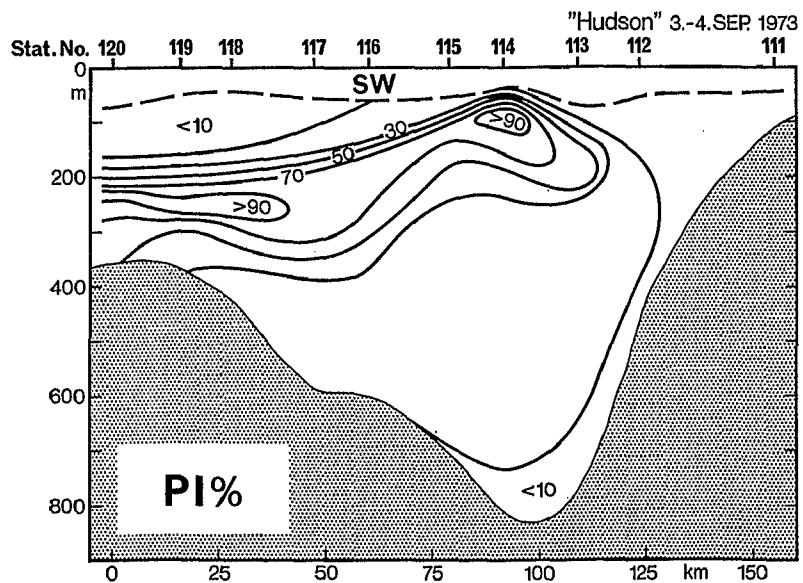
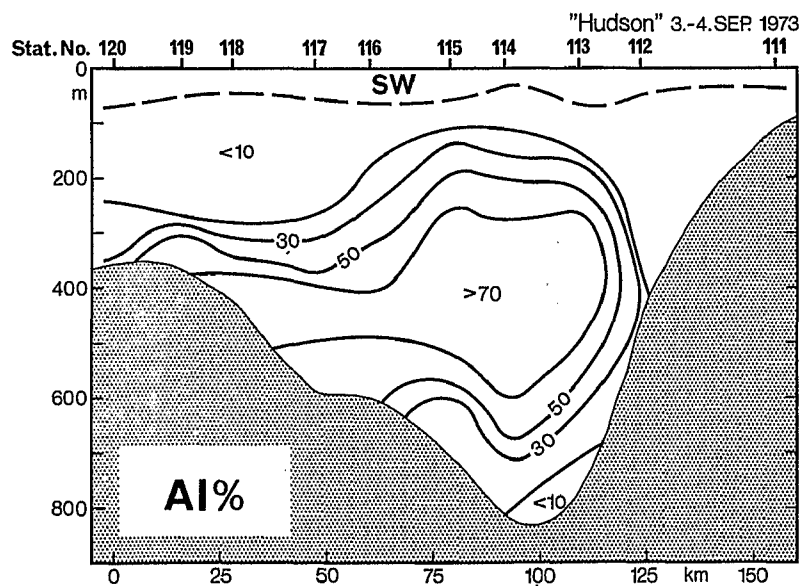
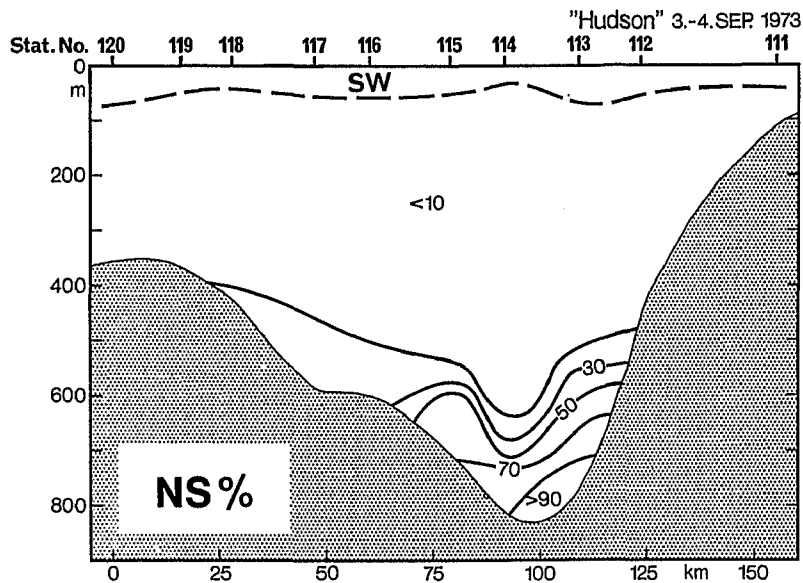



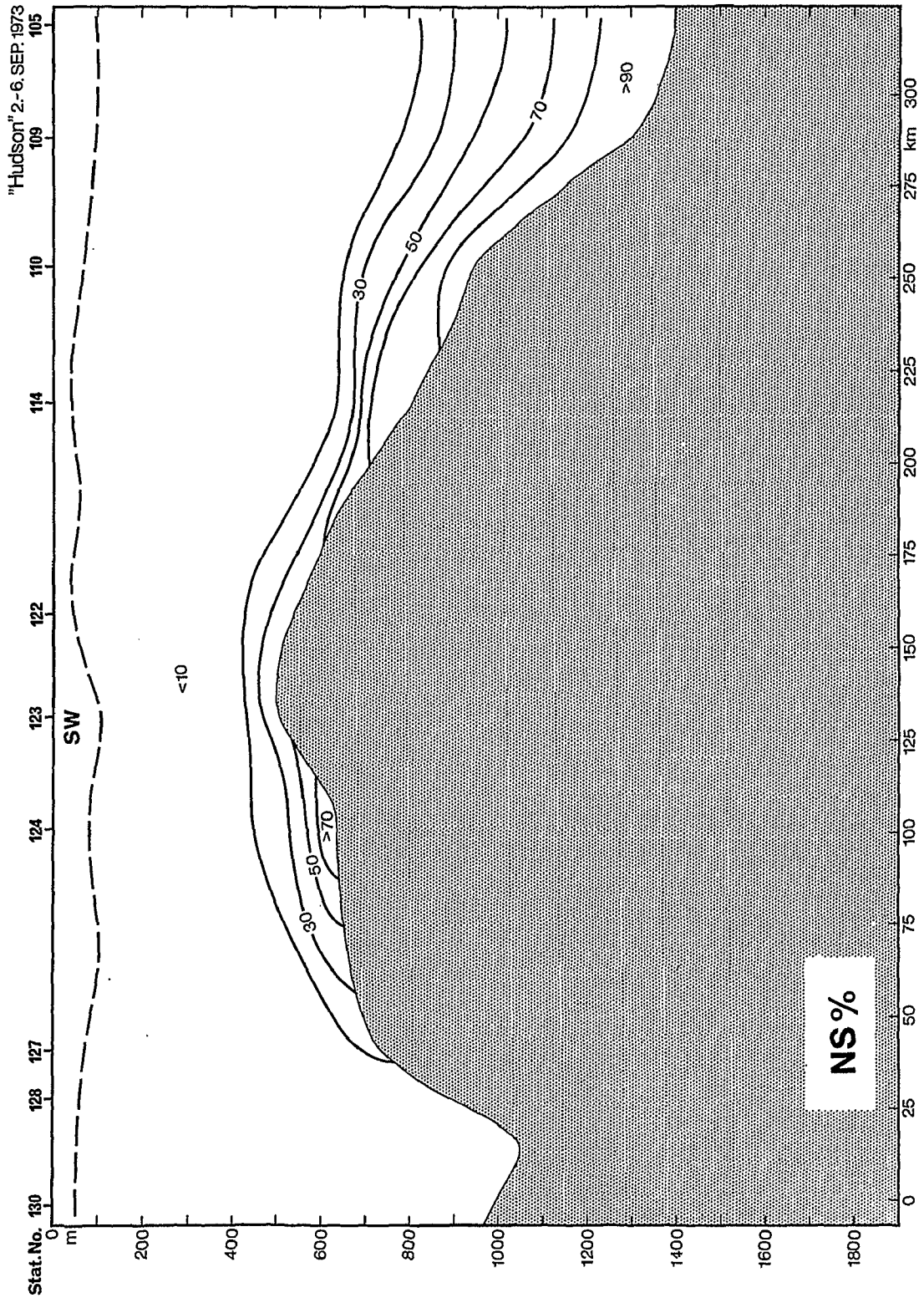

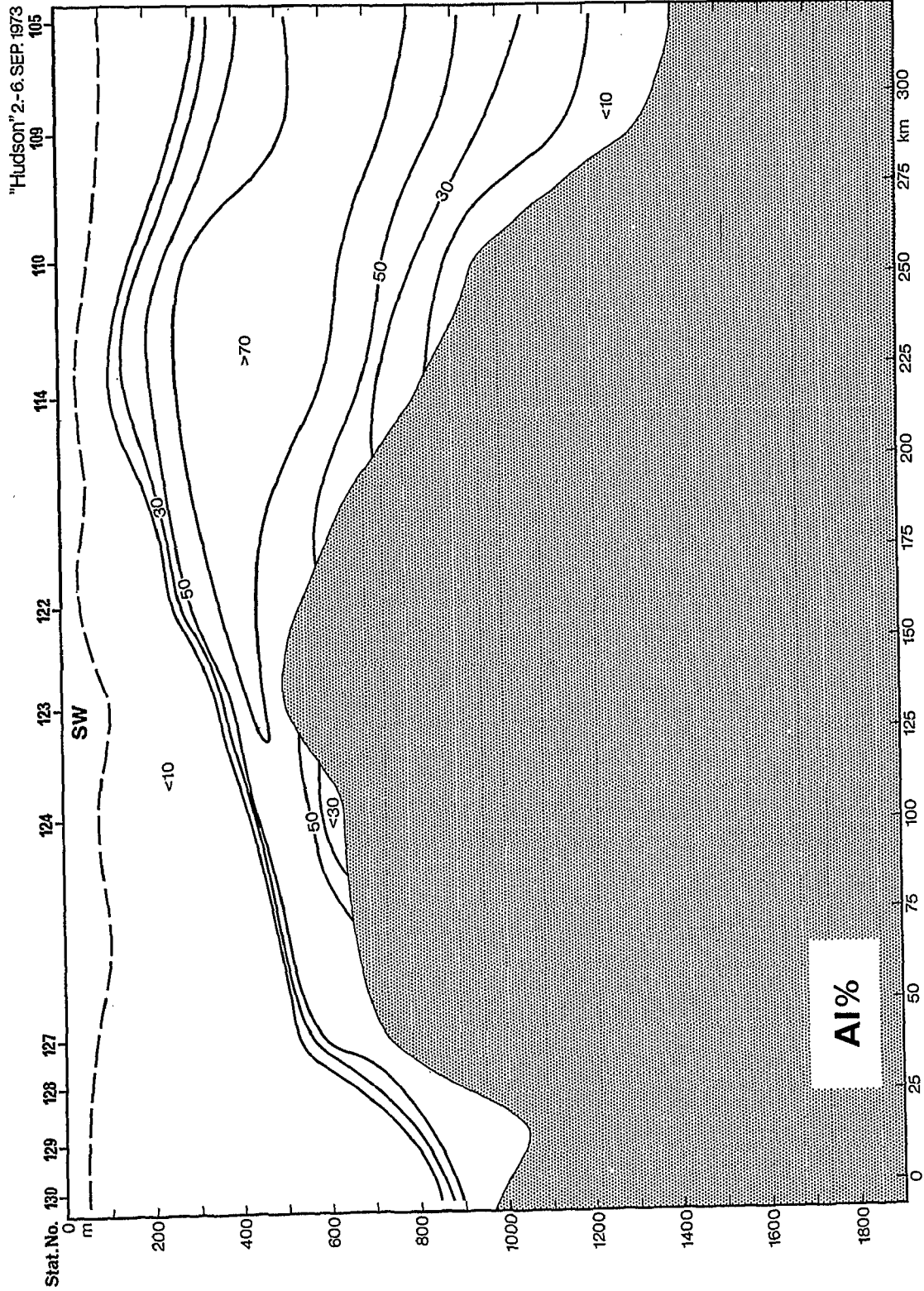

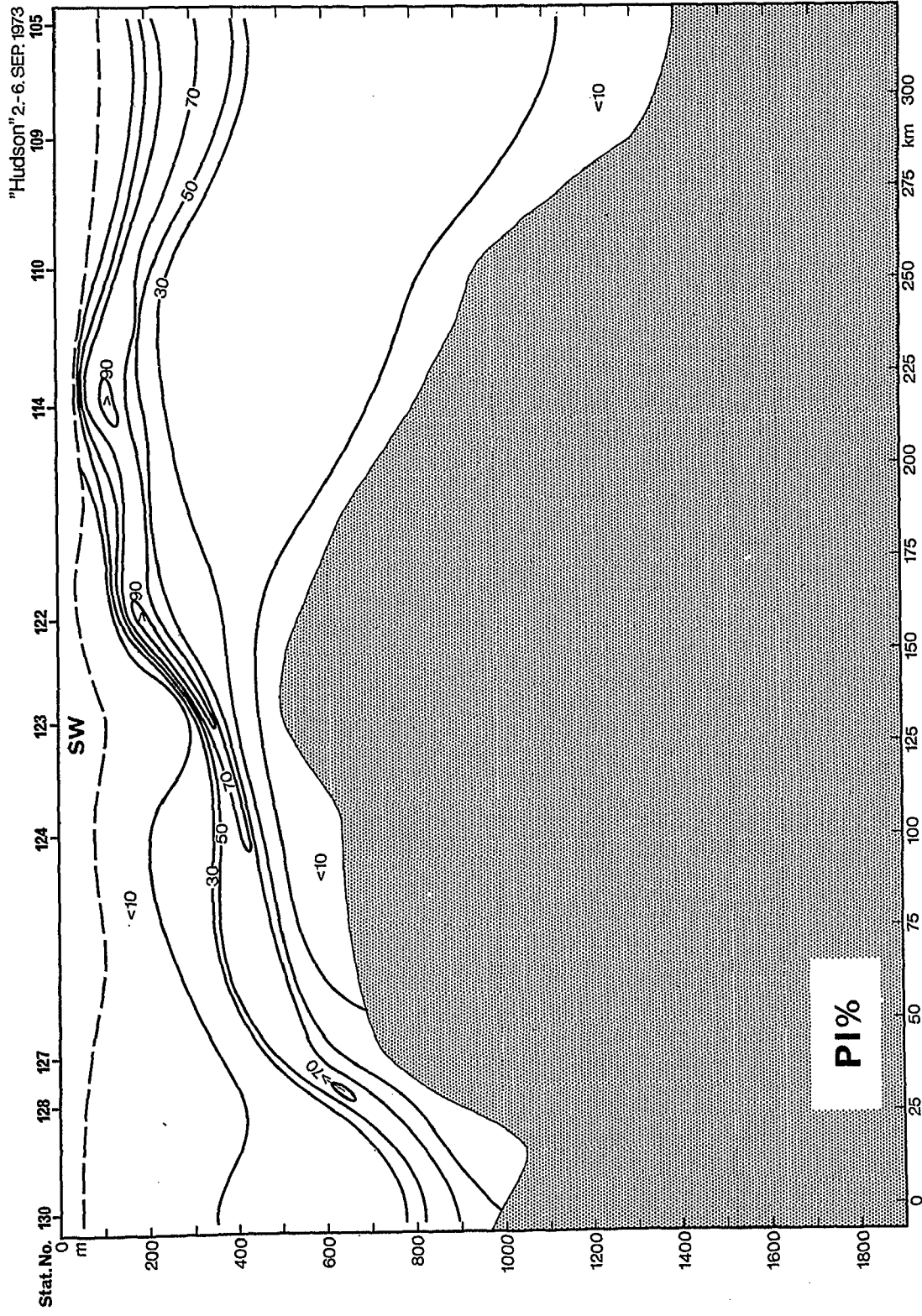

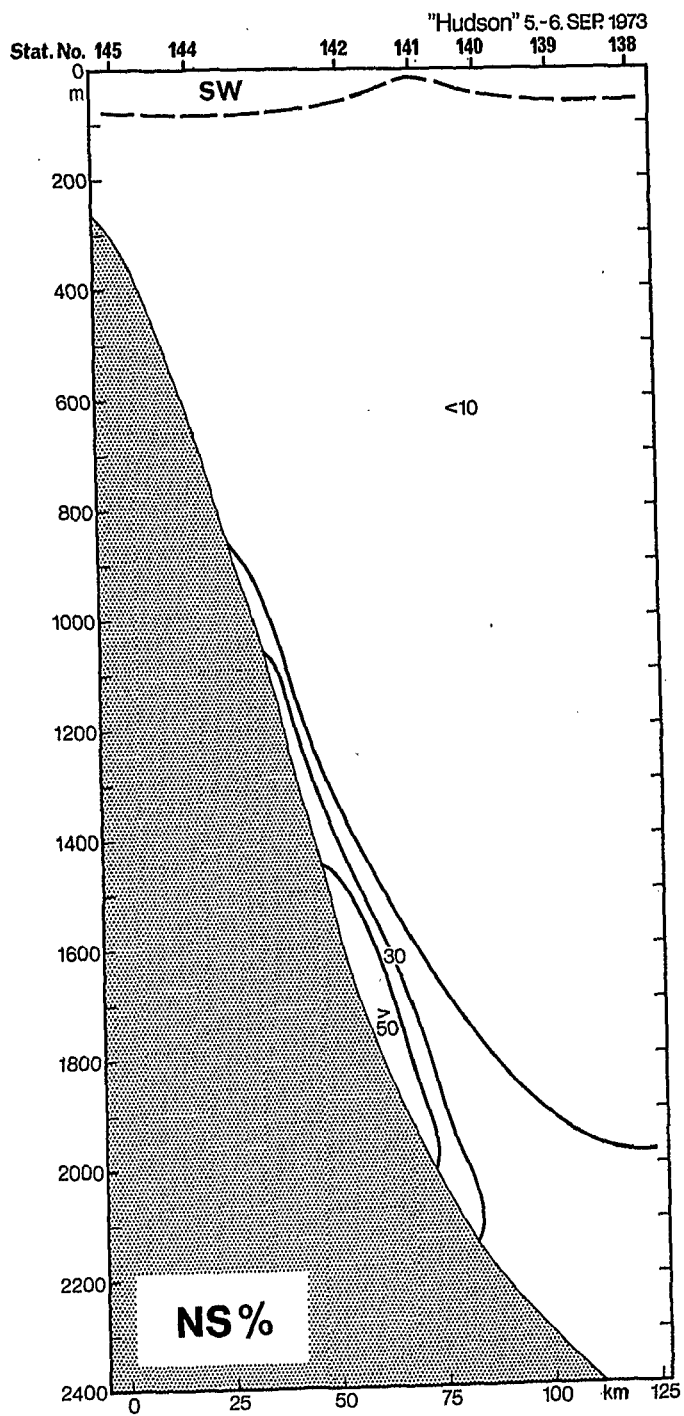

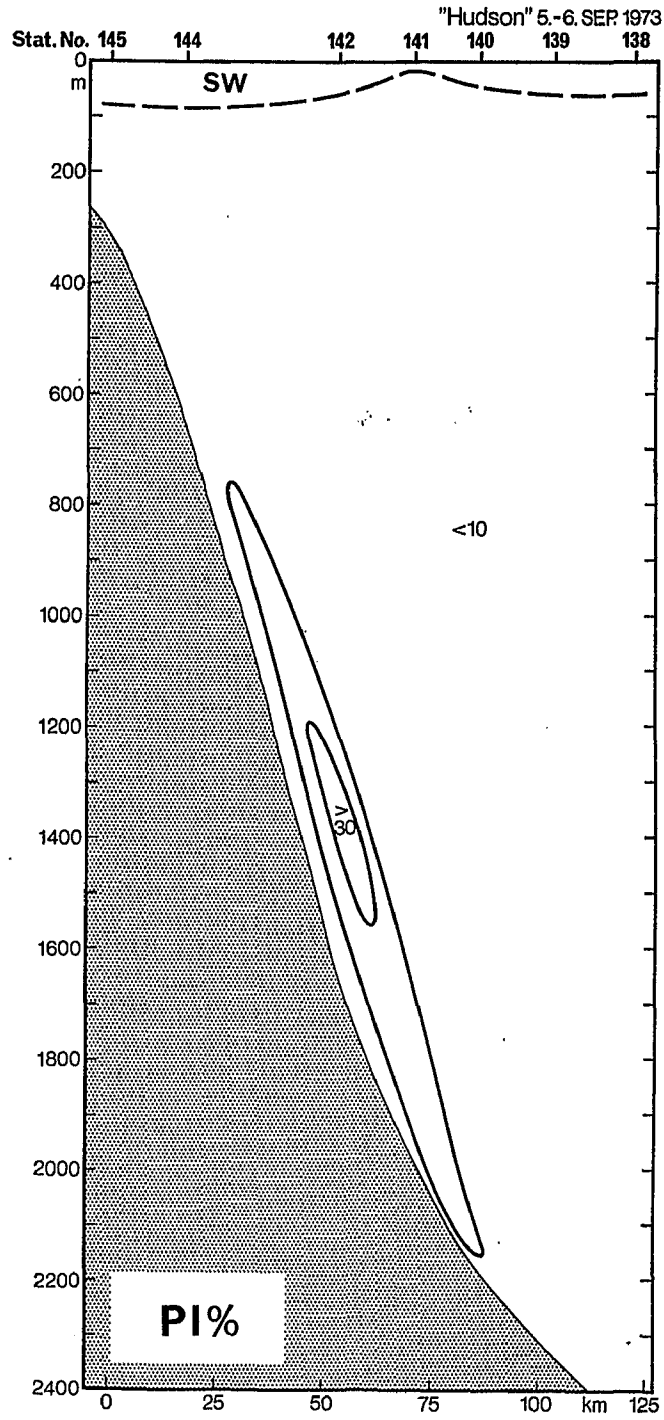

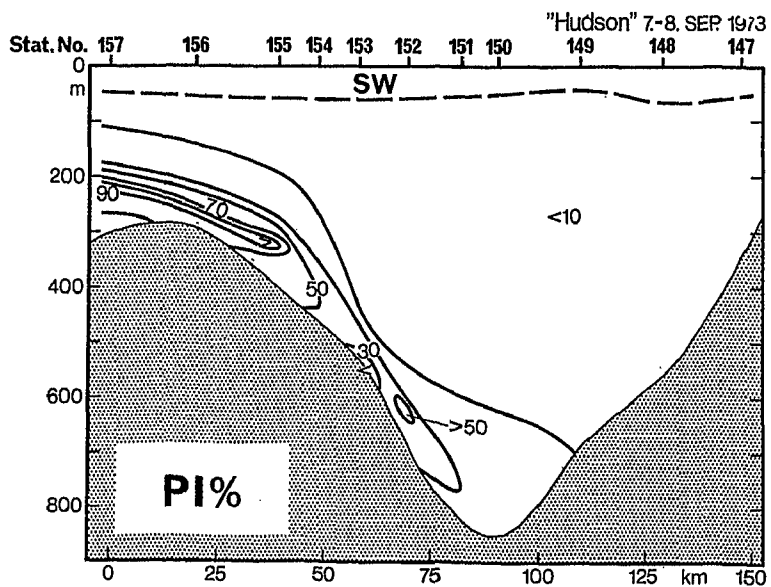
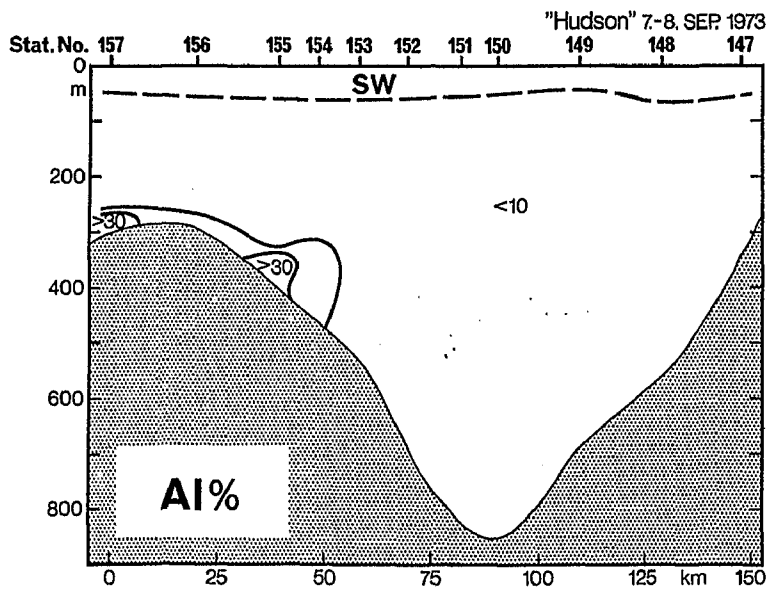
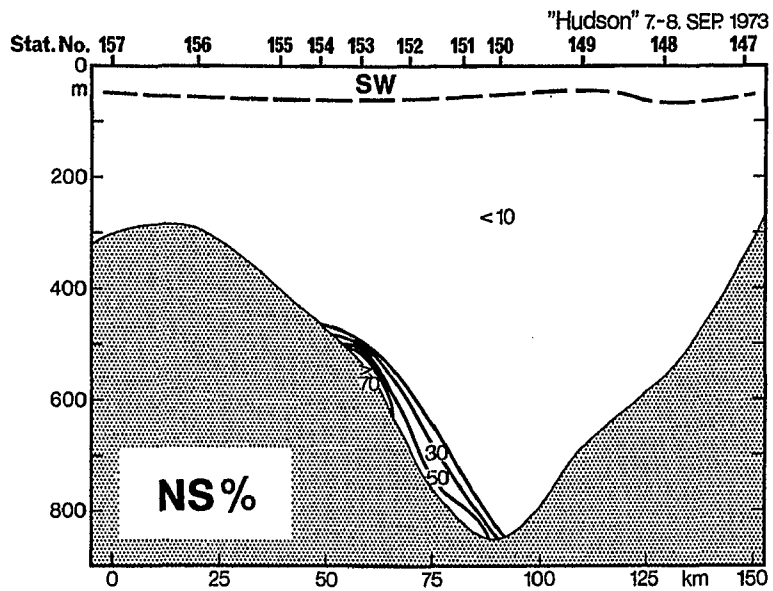

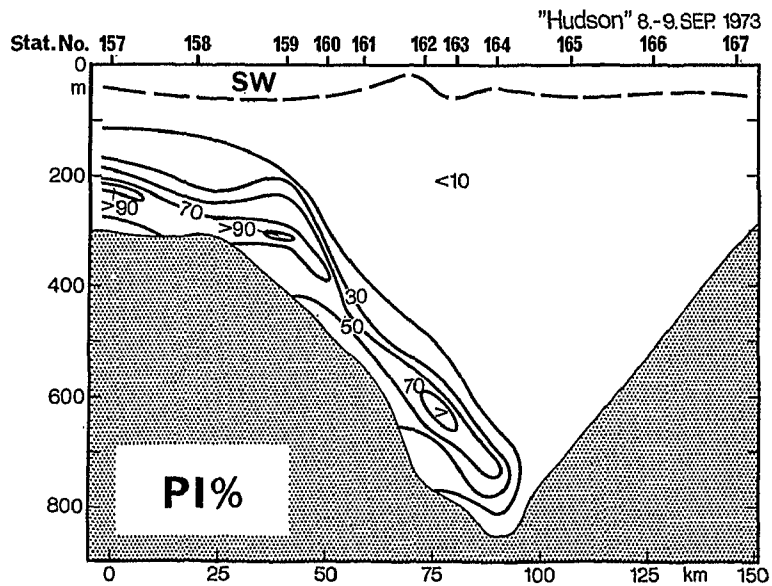
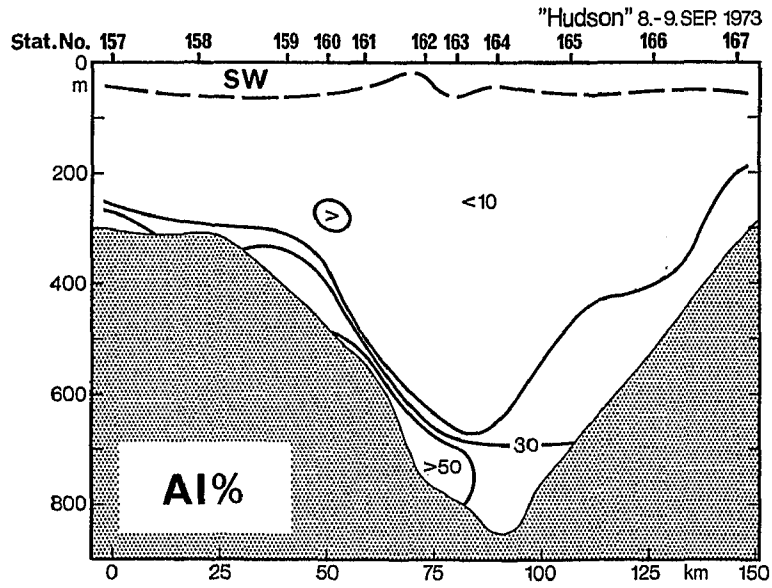
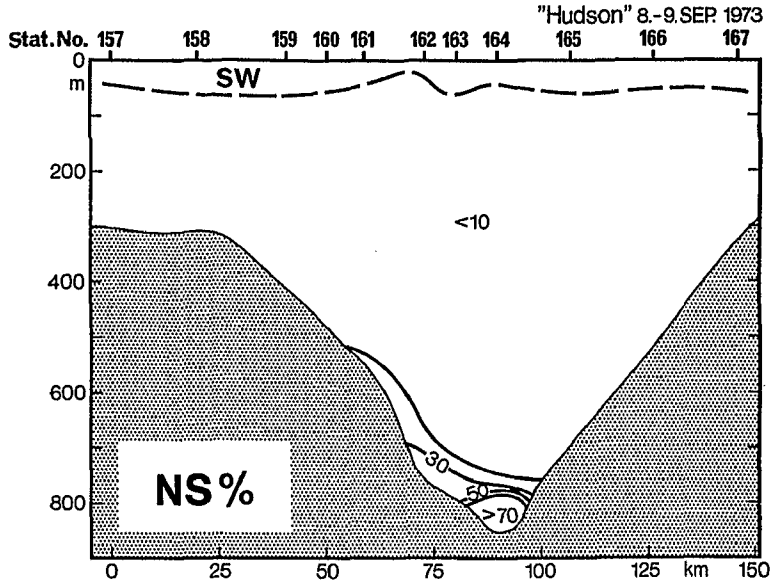

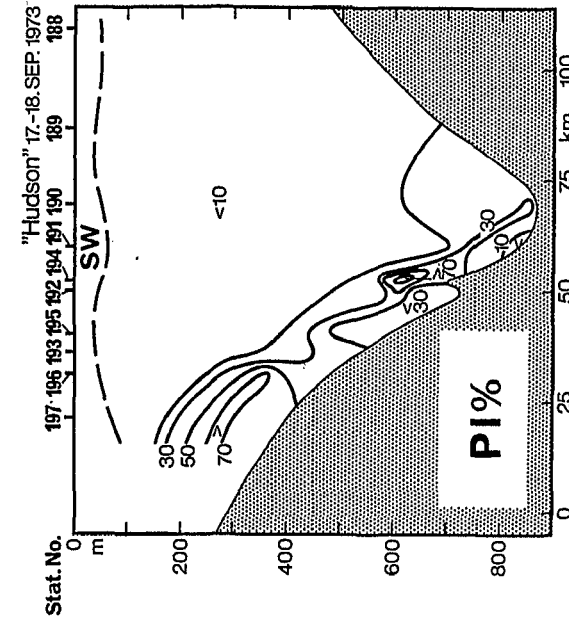
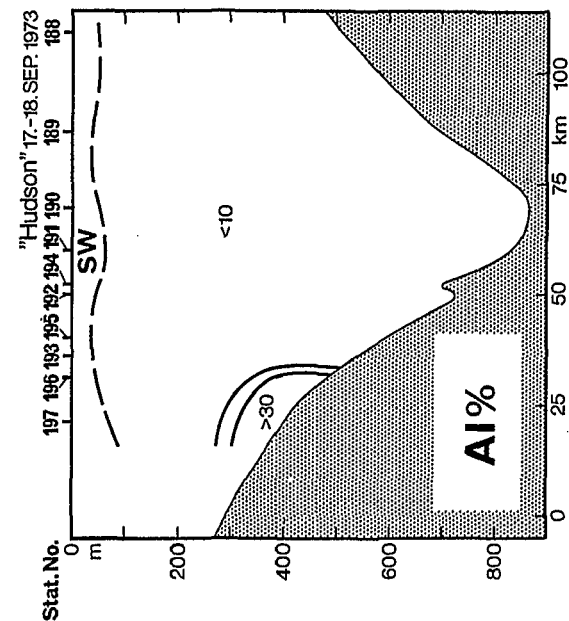
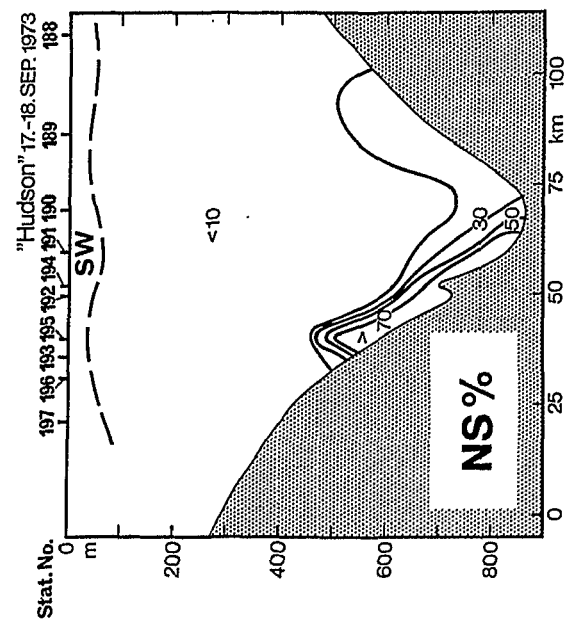
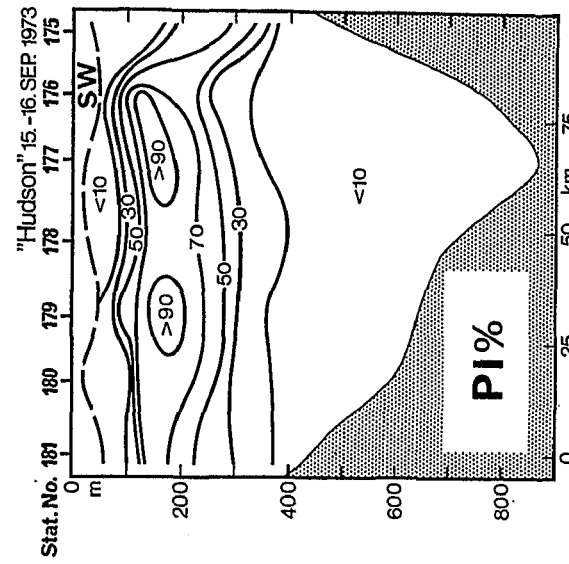
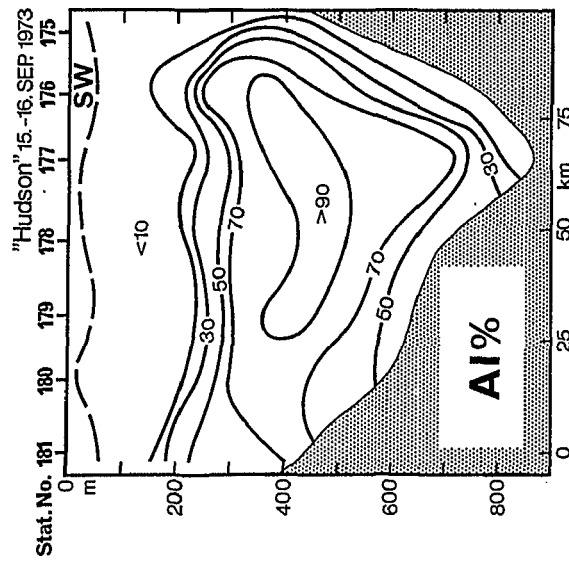
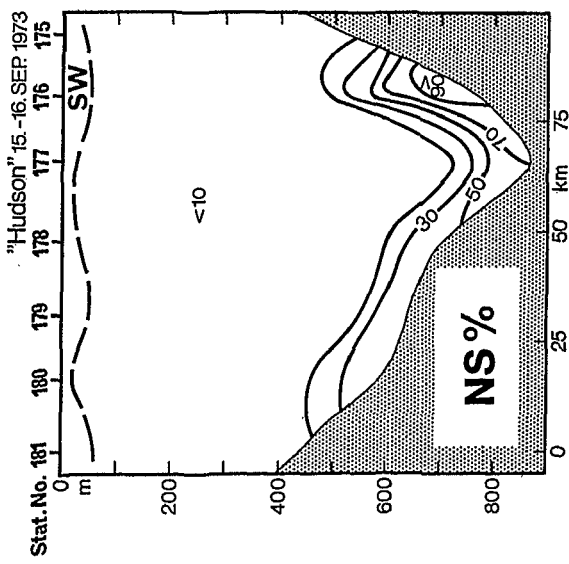



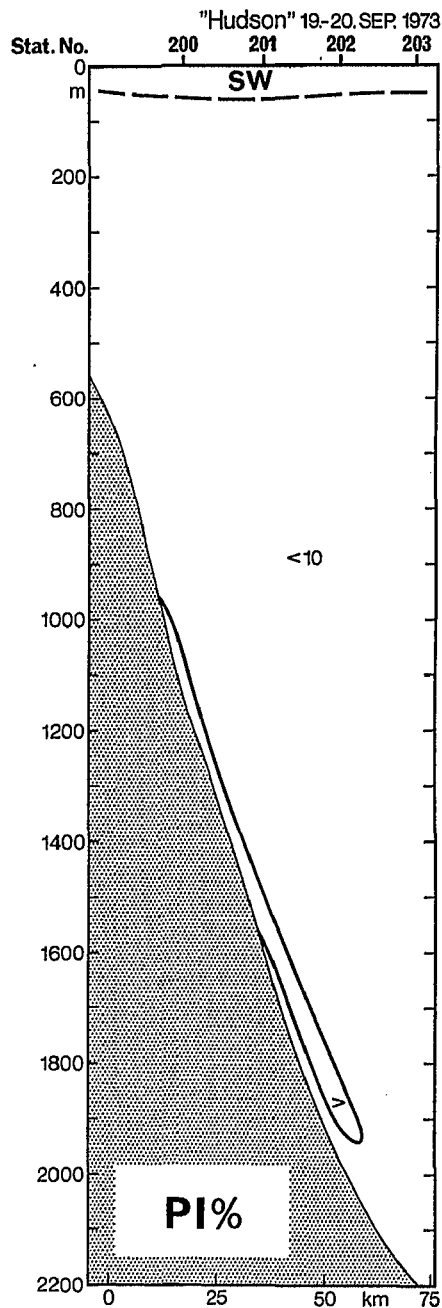
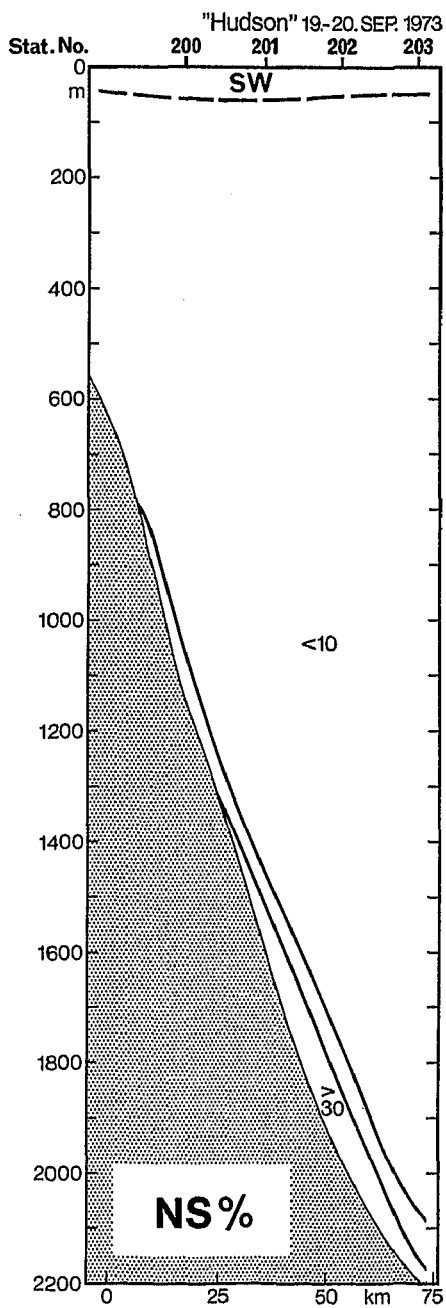

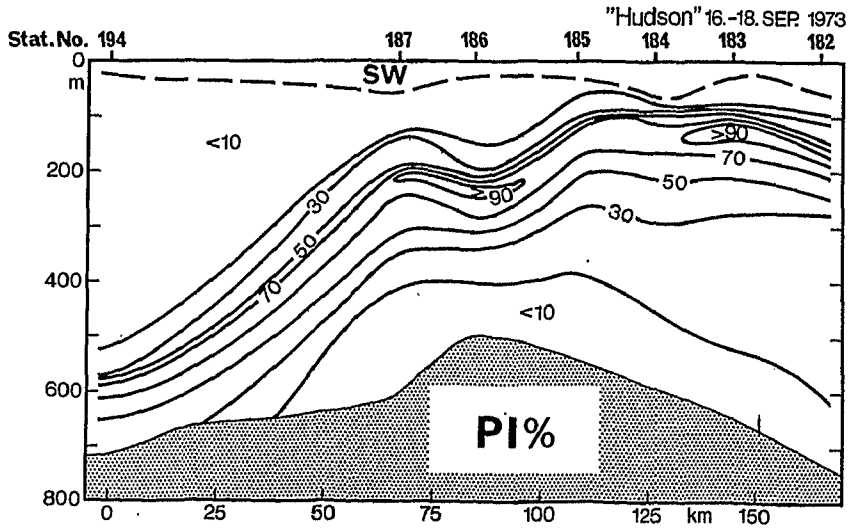
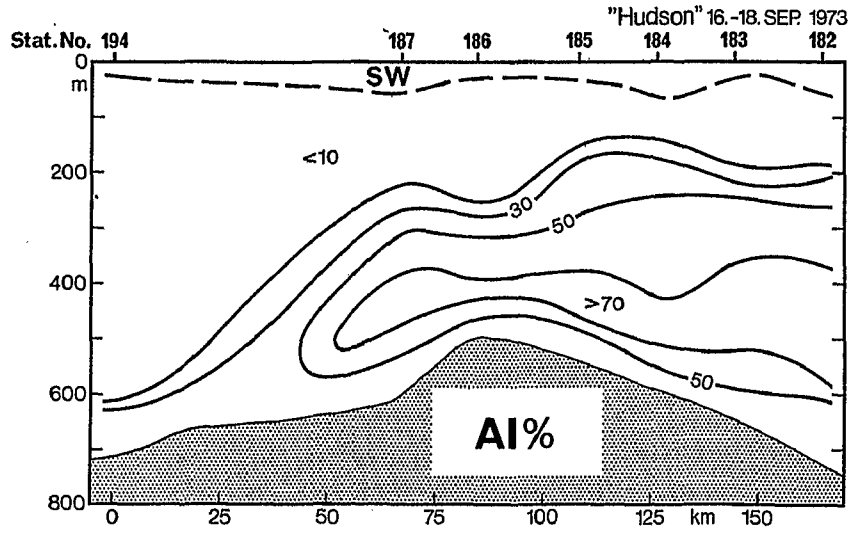
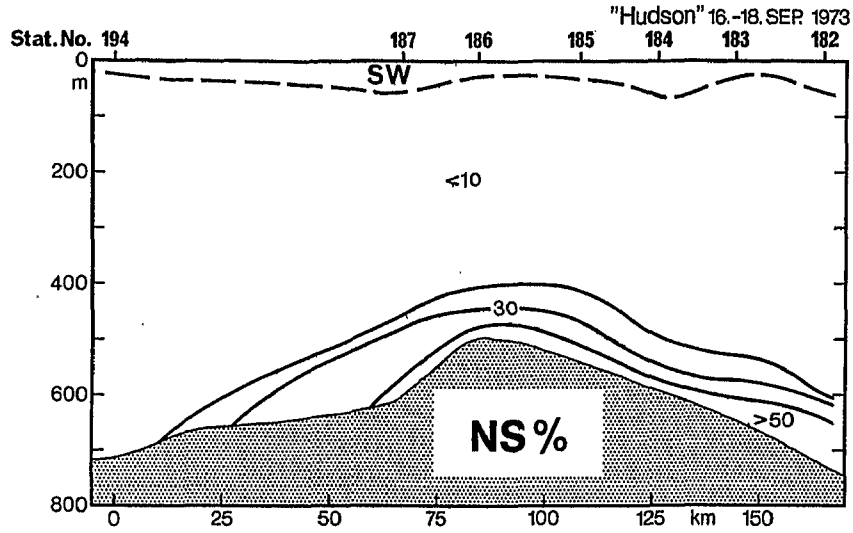

6.12 Professor Viese

The same water masses as for HUDSON occur, except of LS and IS which could not be clearly identified.

<u>Section</u>	<u>Stat.No.</u>	<u>Mixing triangles (see table 3)</u>
1 - 10	1 - 3	9
	5 - 8	14
	9, 10	11, 14
11 - 20	11 - 13	11, 12, 13
	14, 15, 17 - 19	14
21 - 29	21 - 23	14
	24	11, 14
	25 - 29	11, 12, 13
30 - 38	30 - 36	11, 12, 13
	37, 38	14
100 - 109	100 - 105	9
	106	14
	107 - 109	11, 14
110 - 119	110, 111	11, 12
	112, 113	11, 12, 13
	114 - 119	14
120 - 129	120 - 122	14
	123 - 125	11, 12, 13
	126 - 129	11, 12
130 - 139	130 - 132	11, 12
	133 - 136	11, 12, 13
	137 - 139	14
140 - 149	140, 141	14
	142 - 146	11, 12, 13
	147, 149	11
151 - 157	151	11
	152, 153	11, 12
	154	11, 12, 13
	157	14

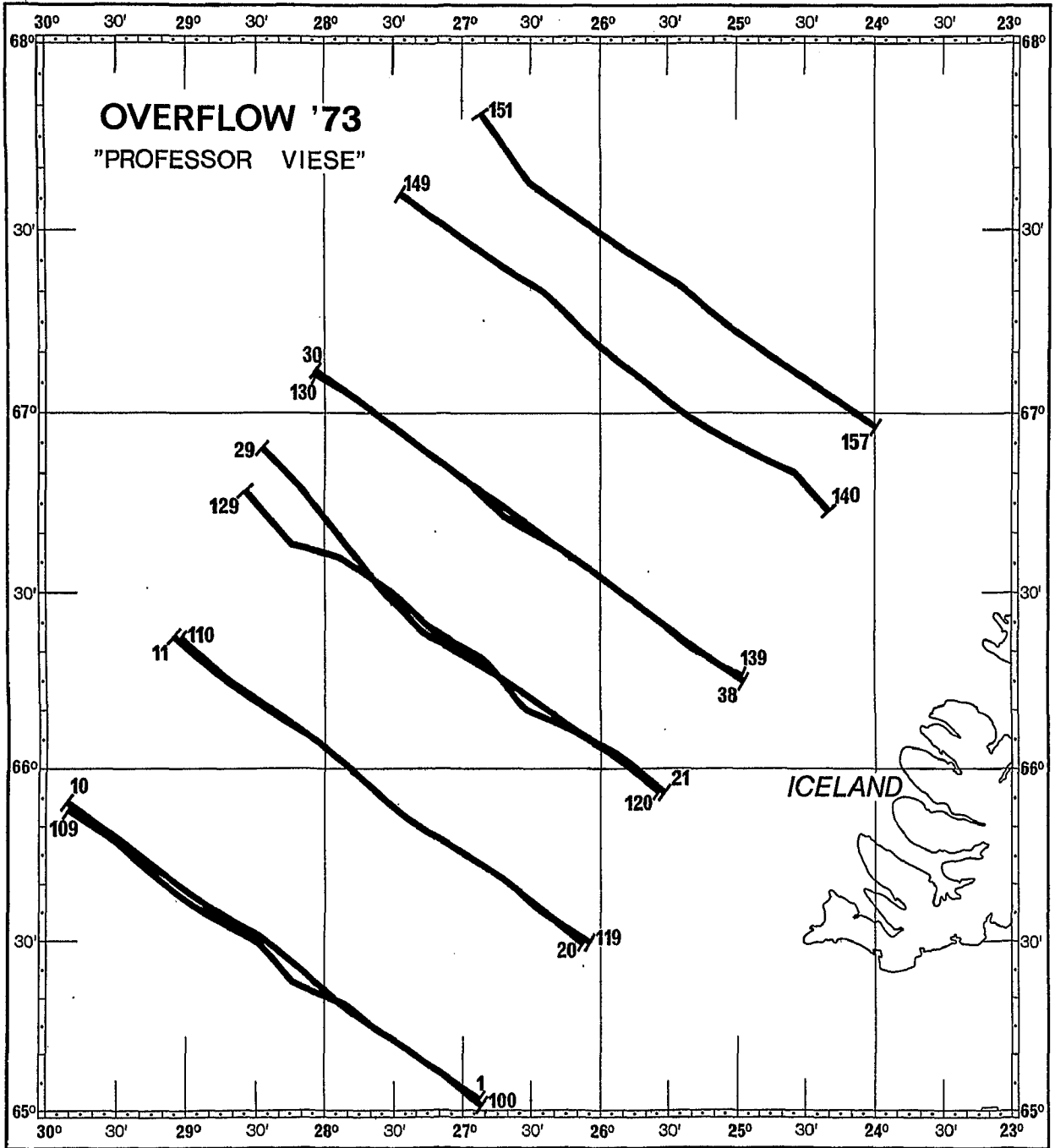

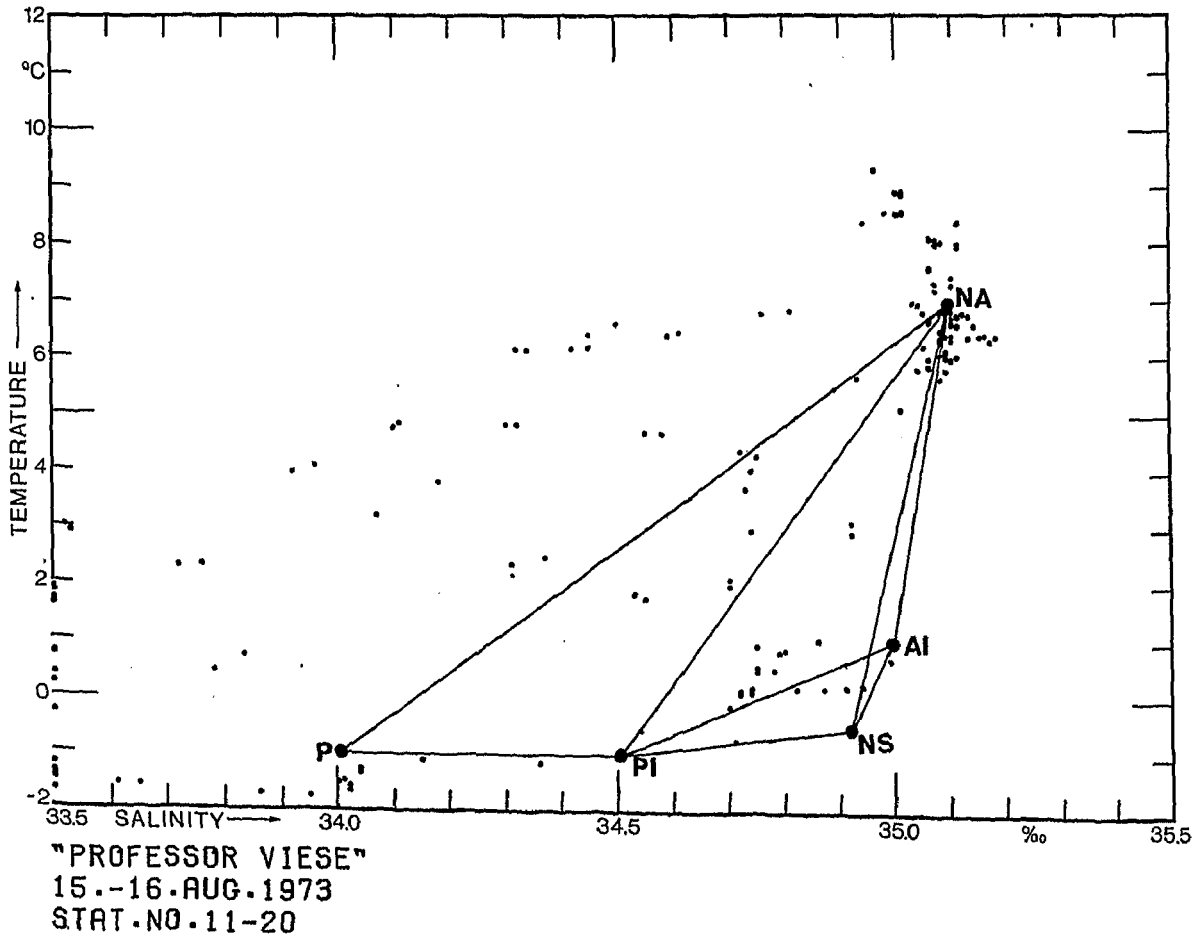
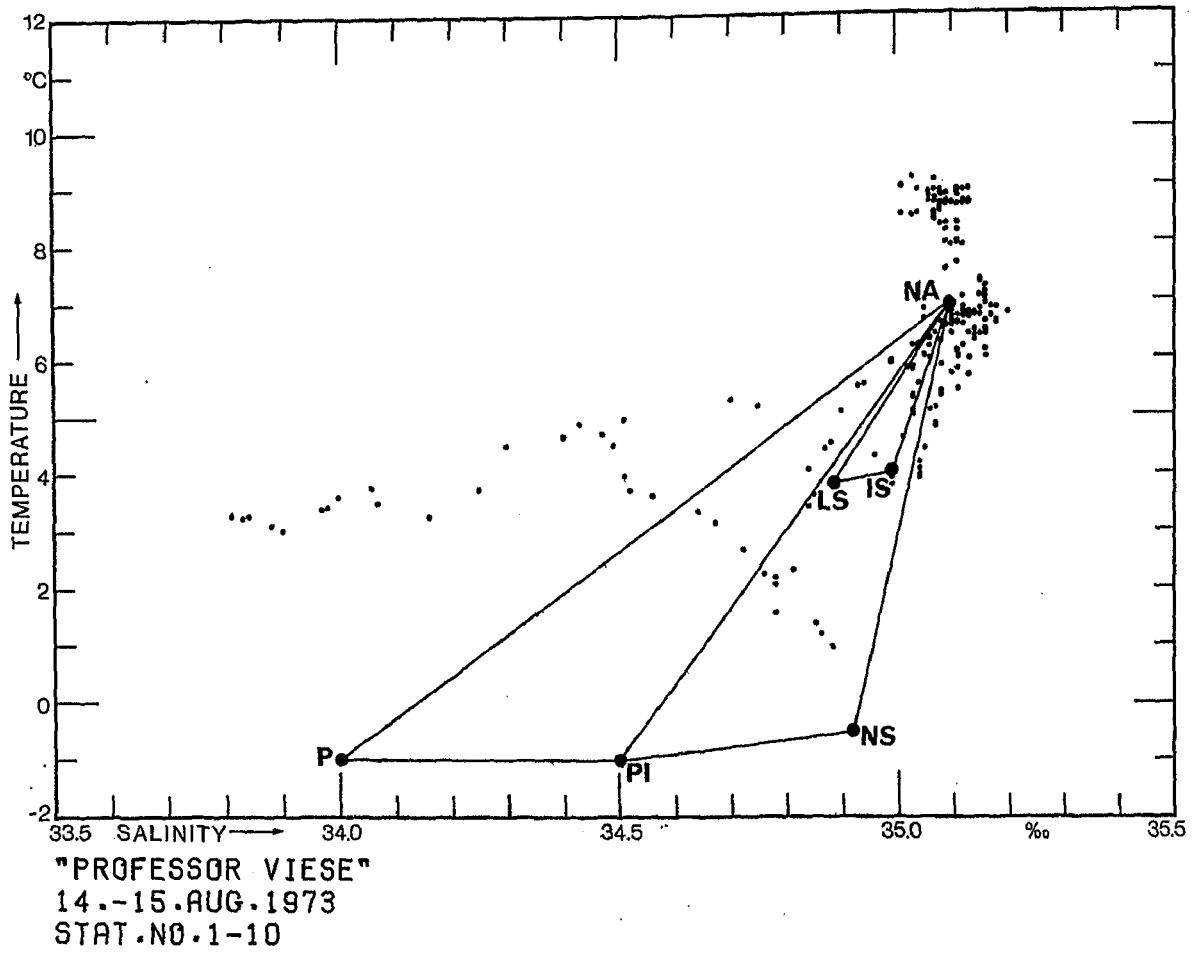

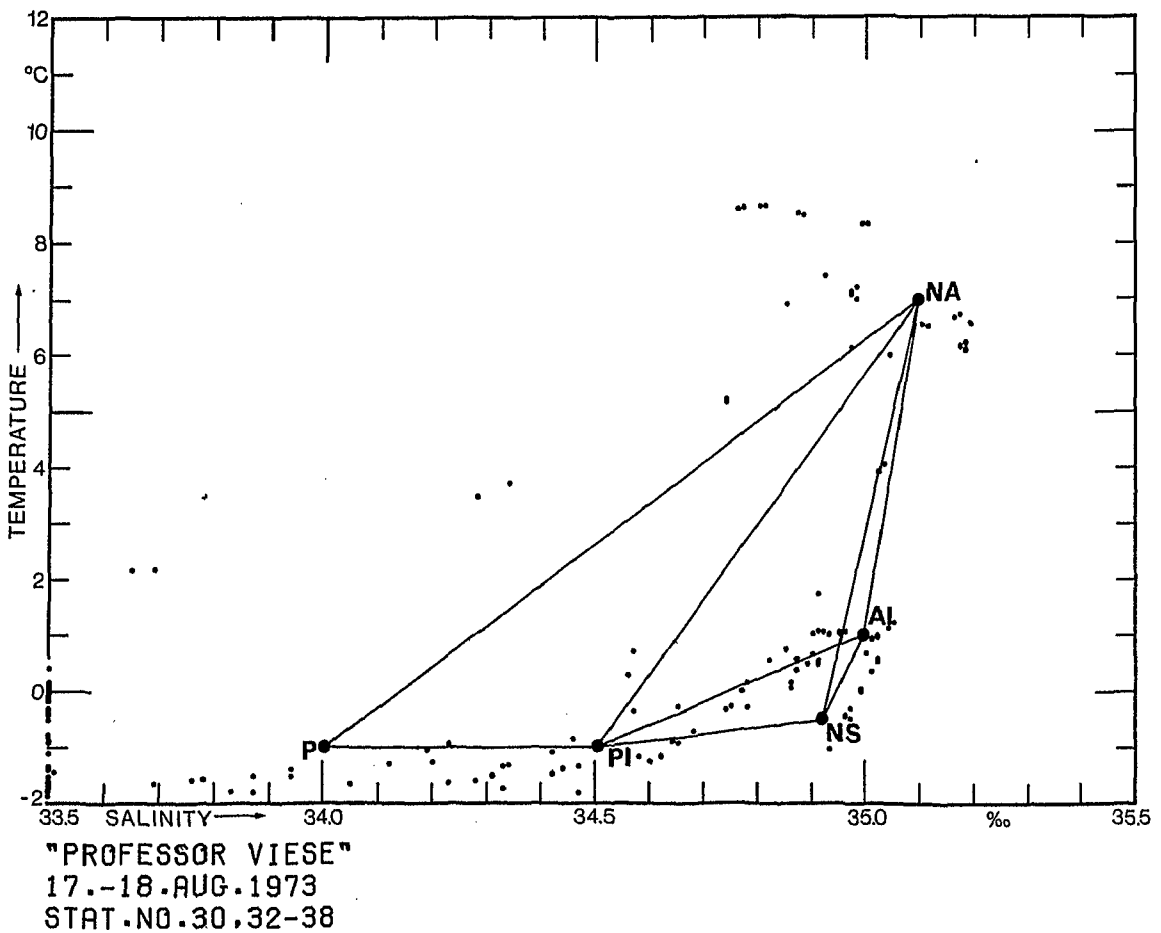
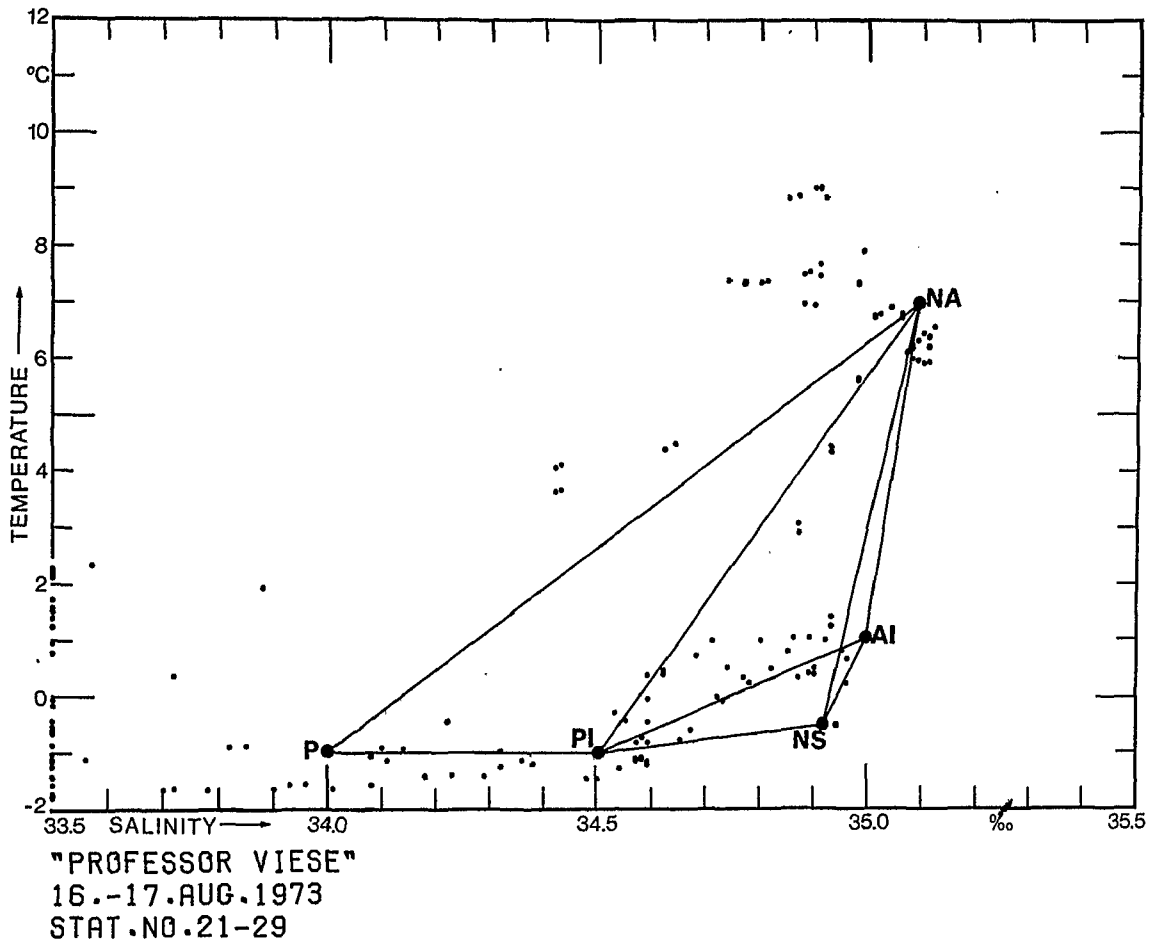

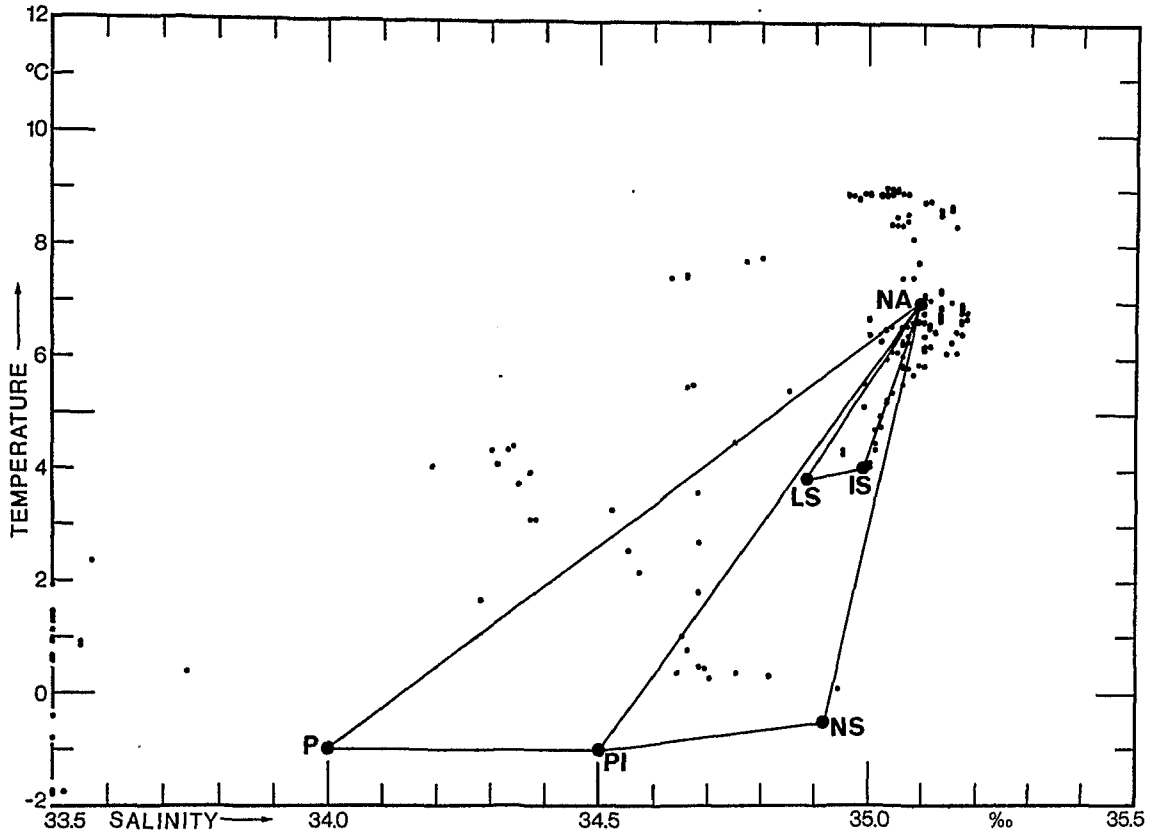

"PROFESSOR VIESE"  
9.-11.SEP.1973  
STAT.NO.100-109

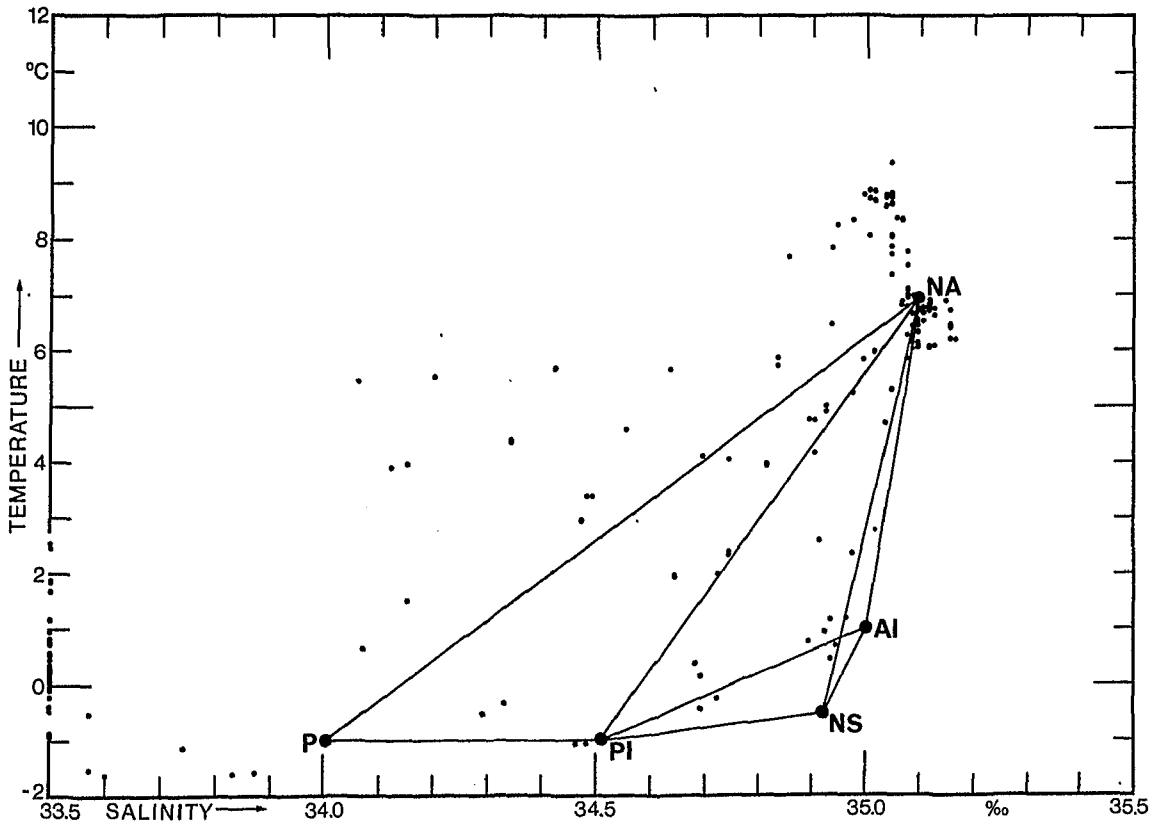

"PROFESSOR VIESE"  
11.-12.SEP.1973  
STAT.NO.110-119

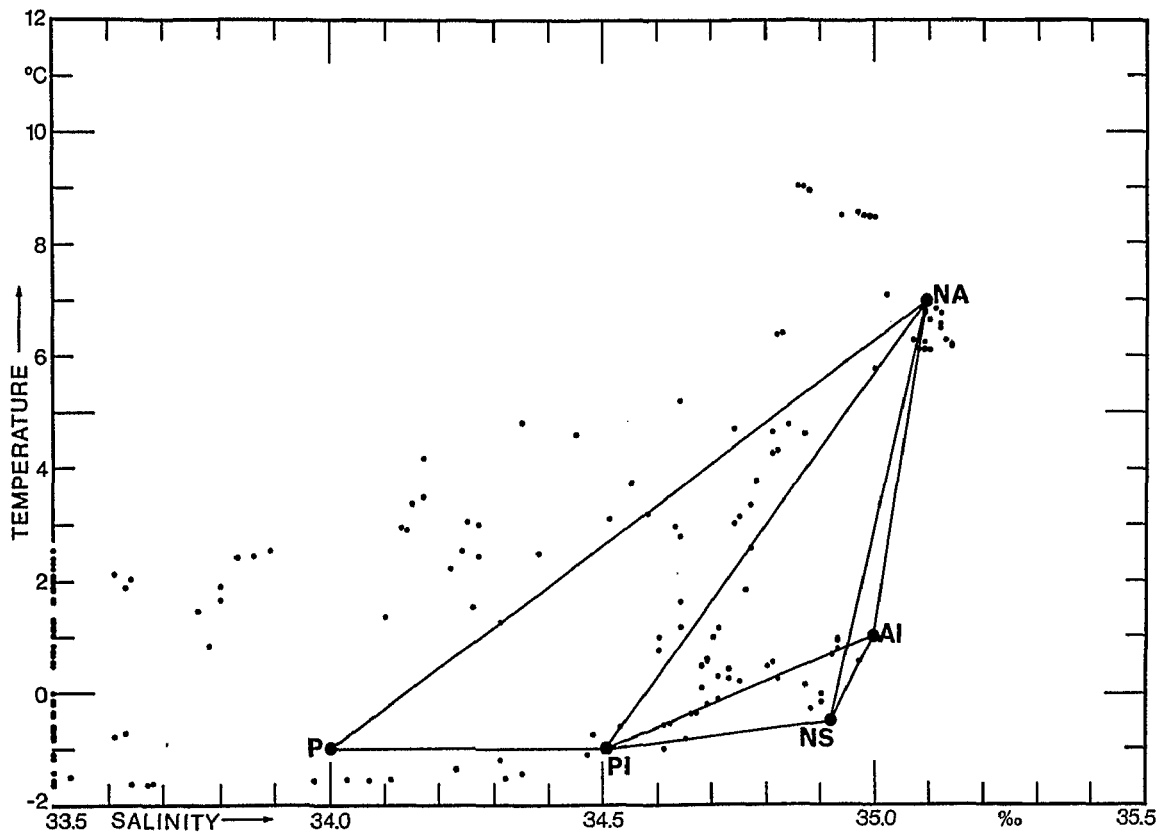

"PROFESSOR VIESE"  
12.SEP.1973  
STAT.NO.120-129

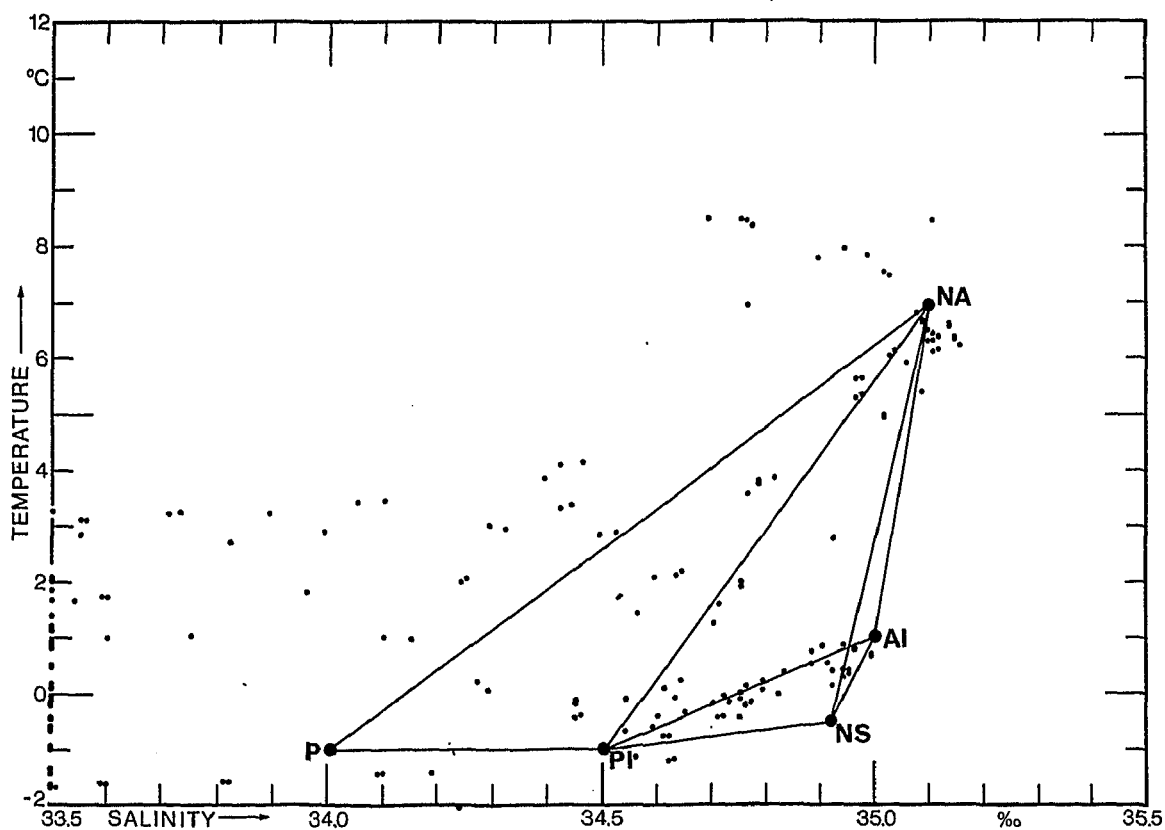

"PROFESSOR VIESE"  
13.SEP.1973  
STAT.NO.130-139



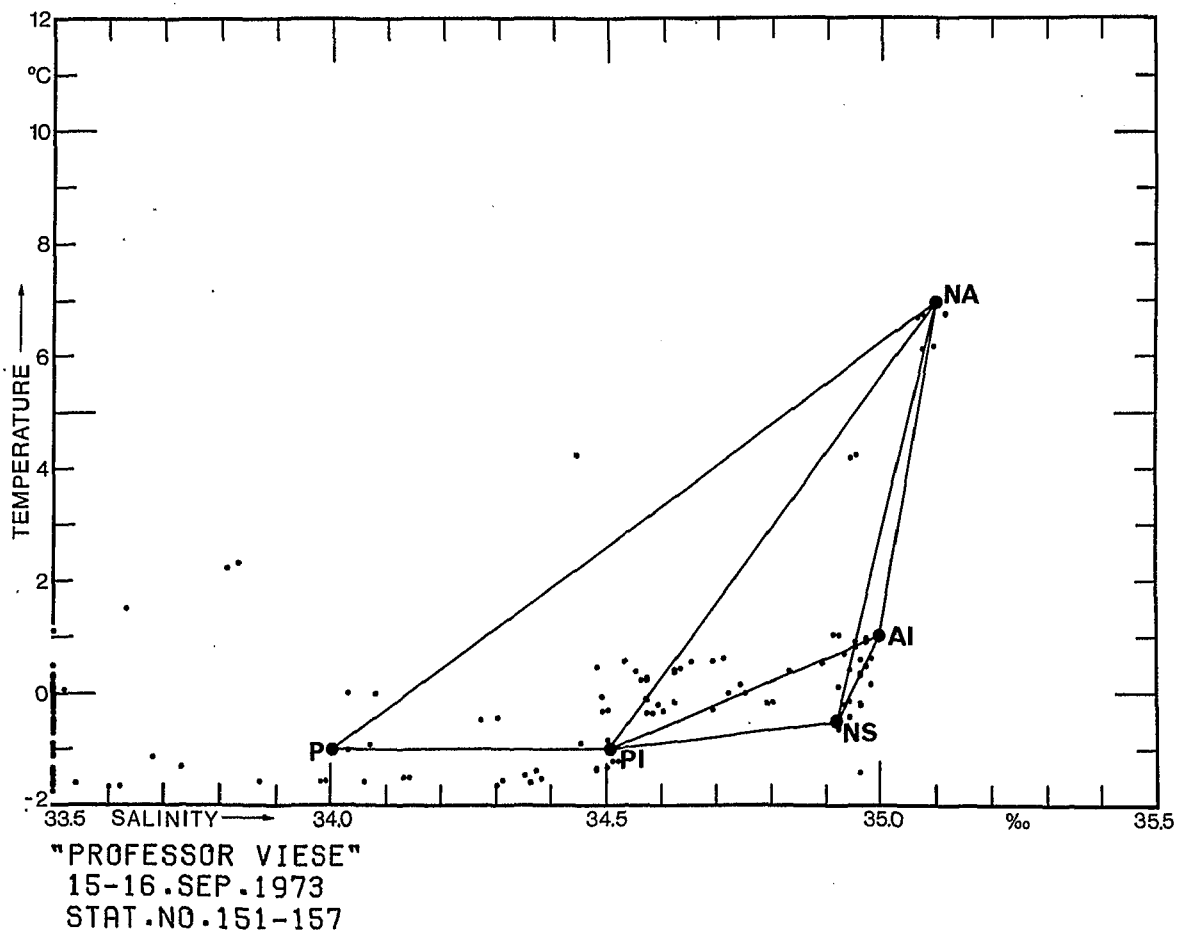
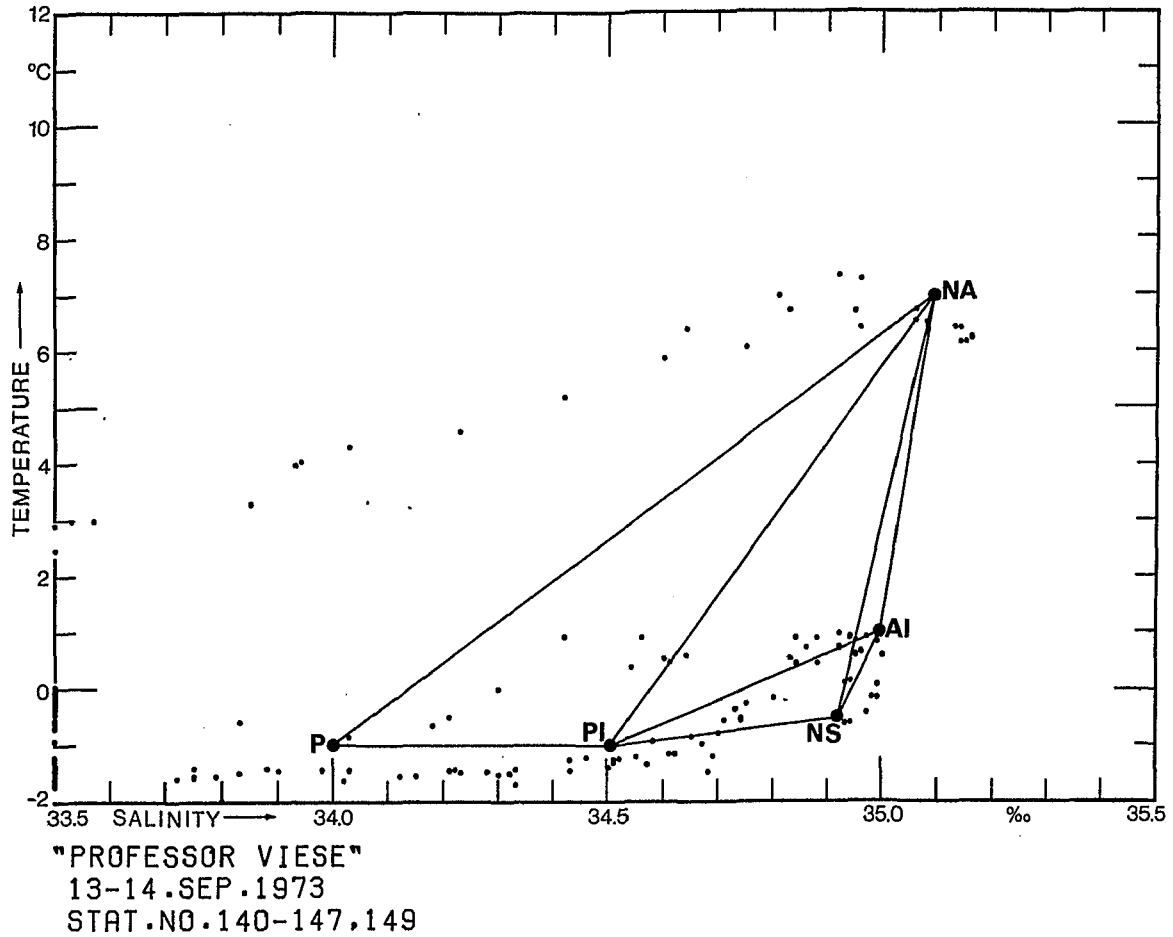

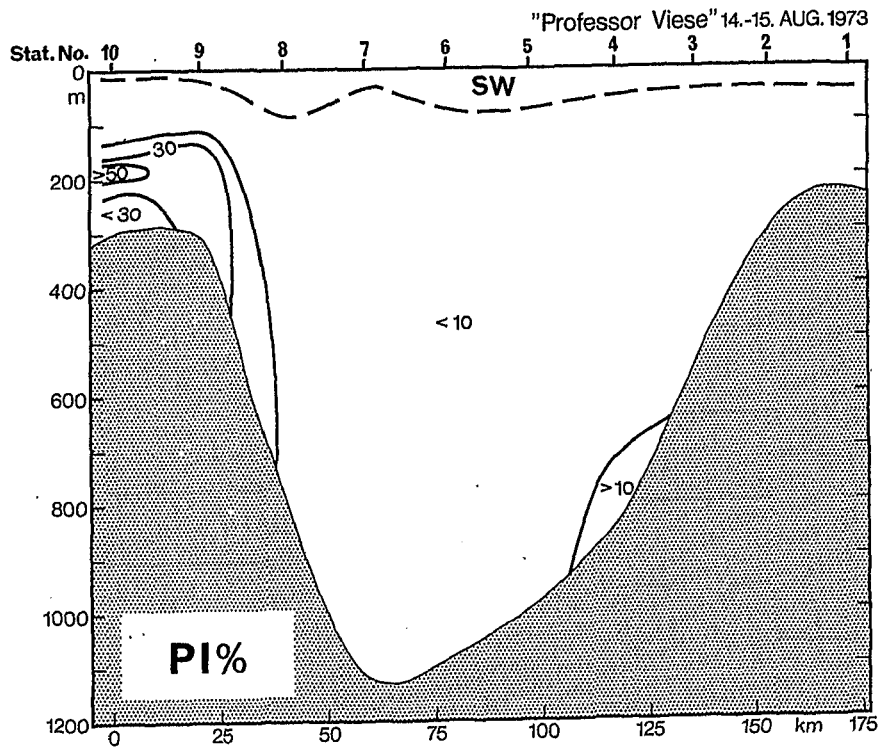
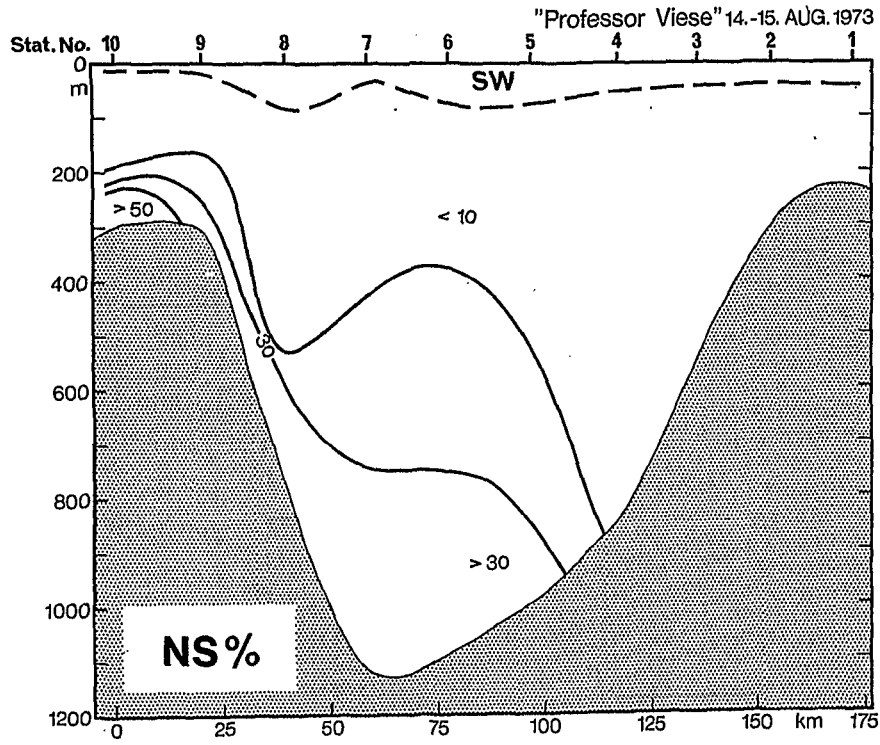

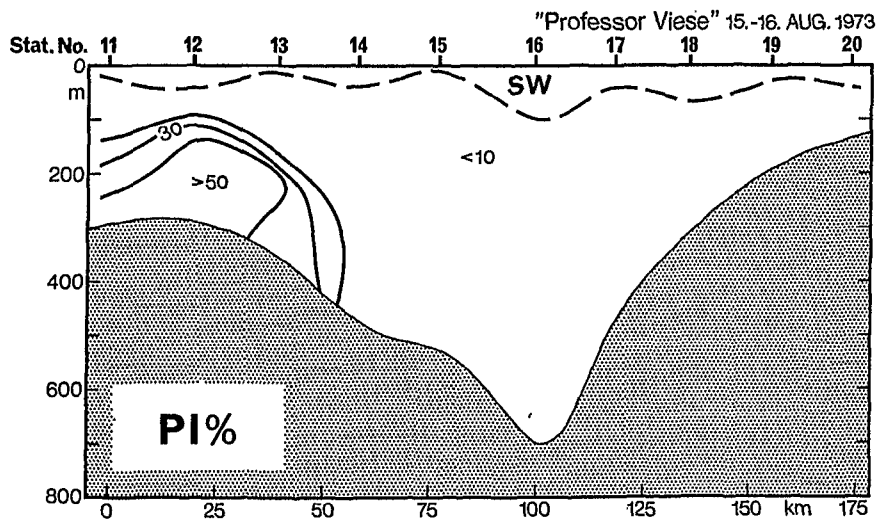
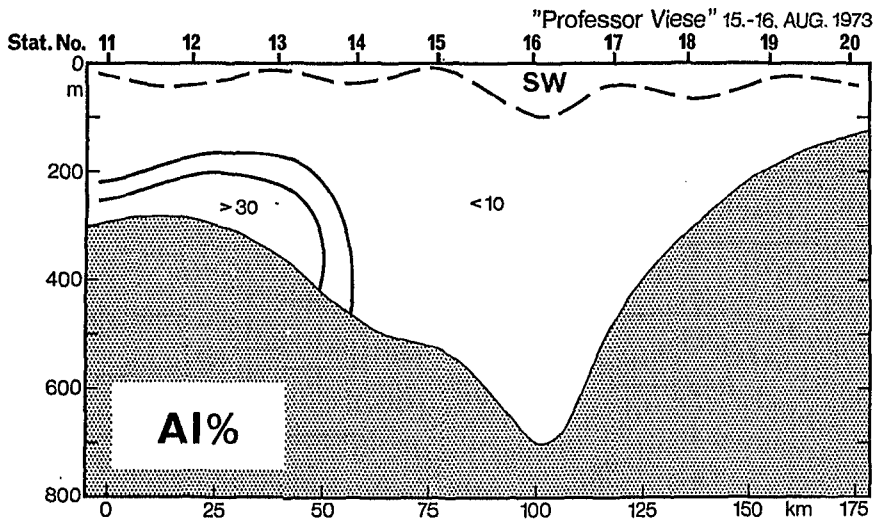
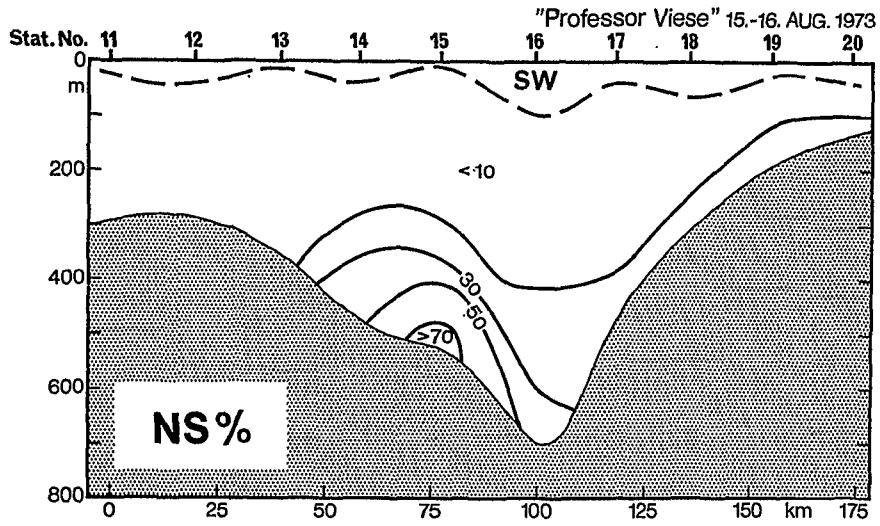

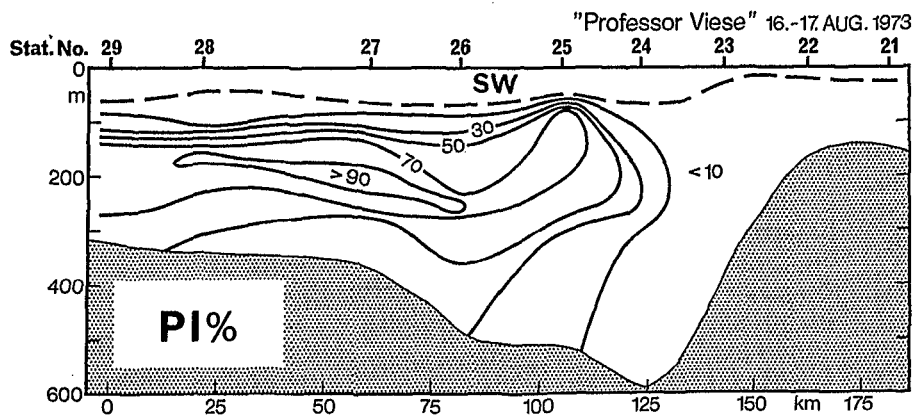
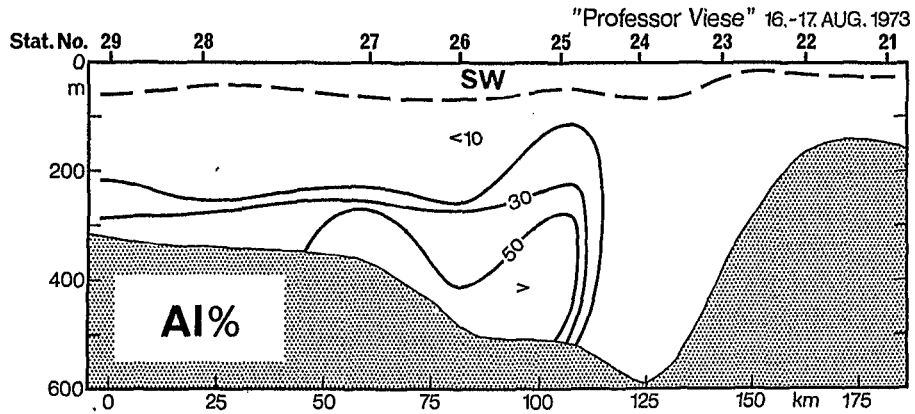
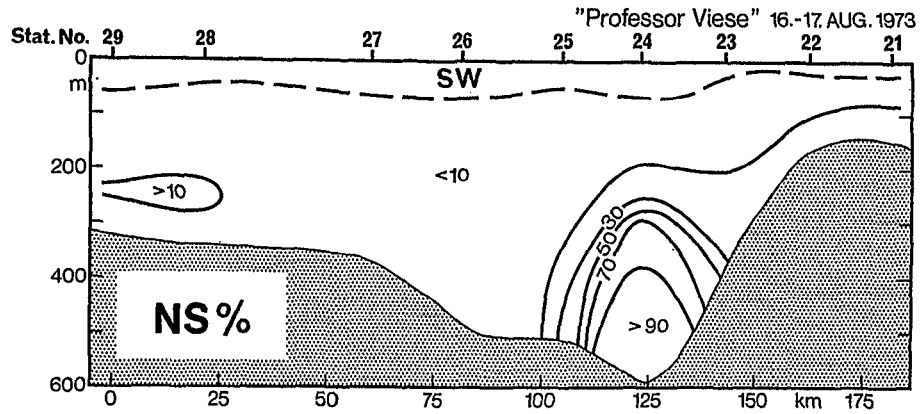

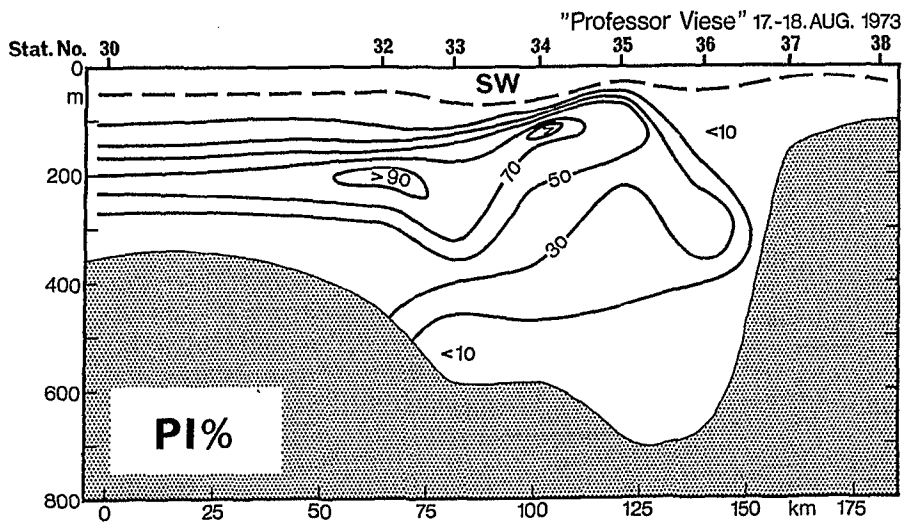
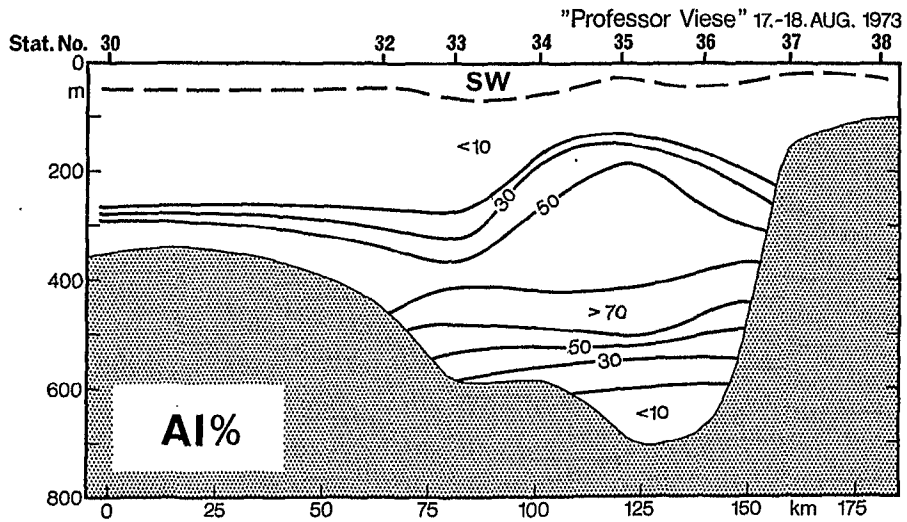
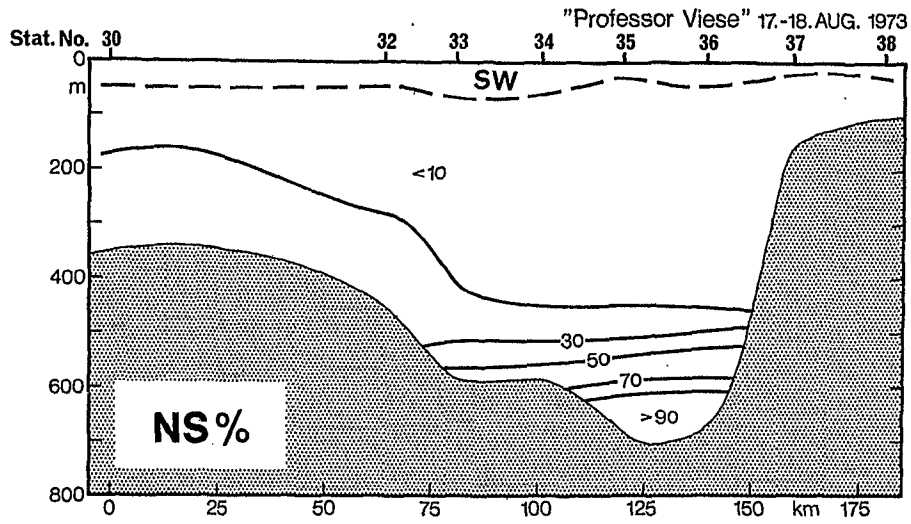

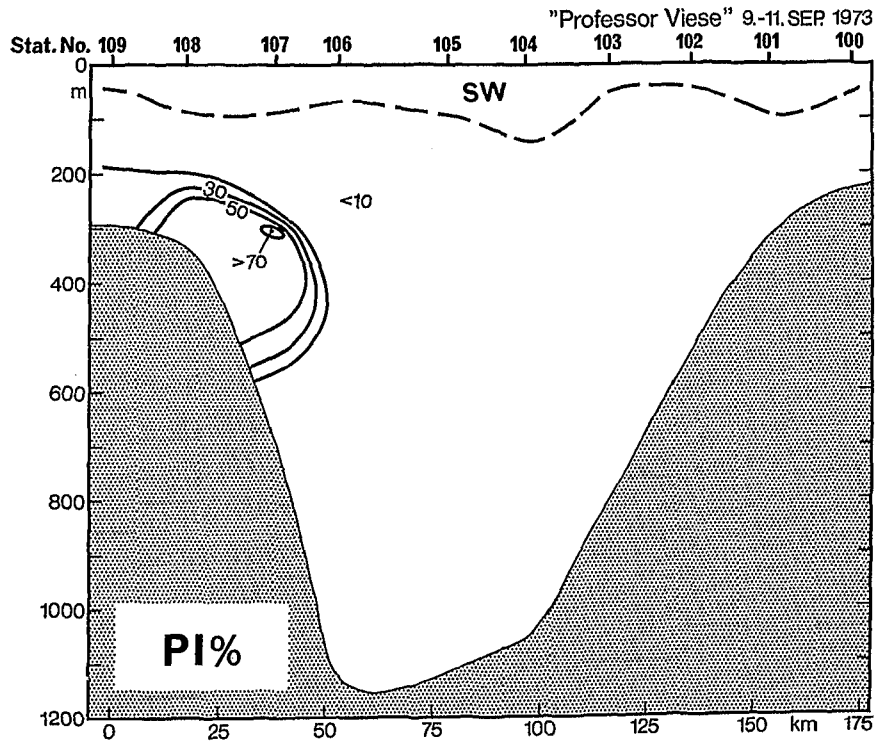
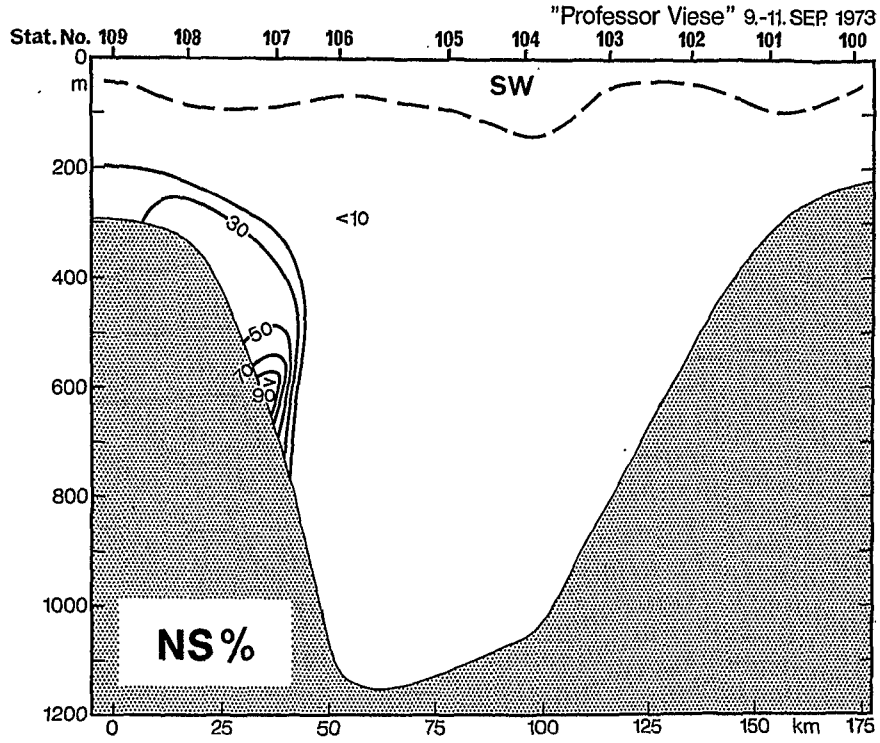

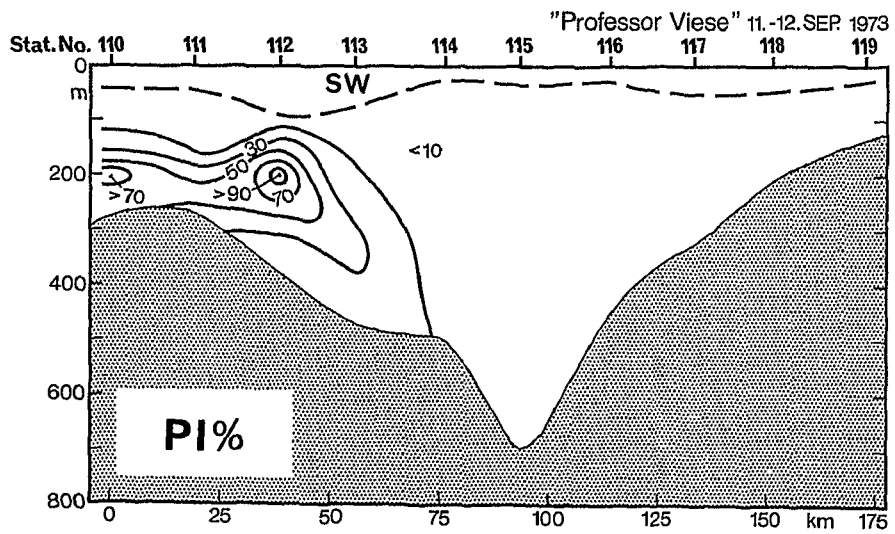
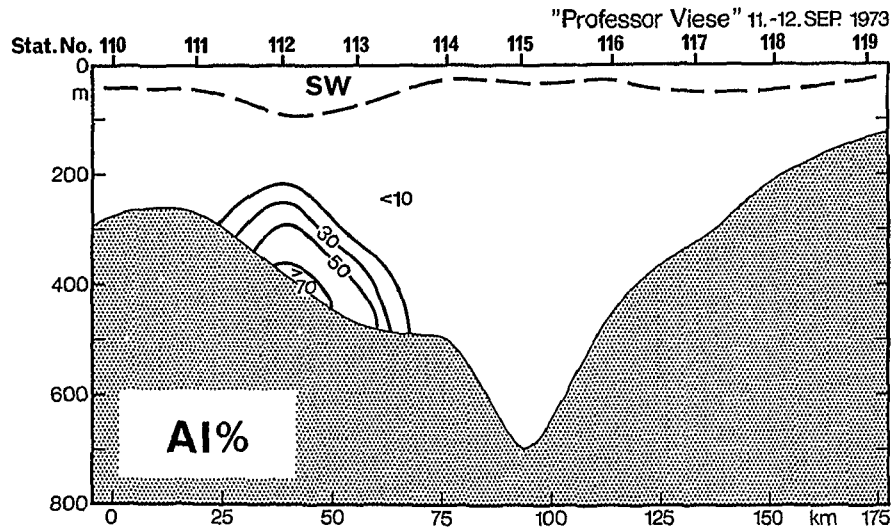
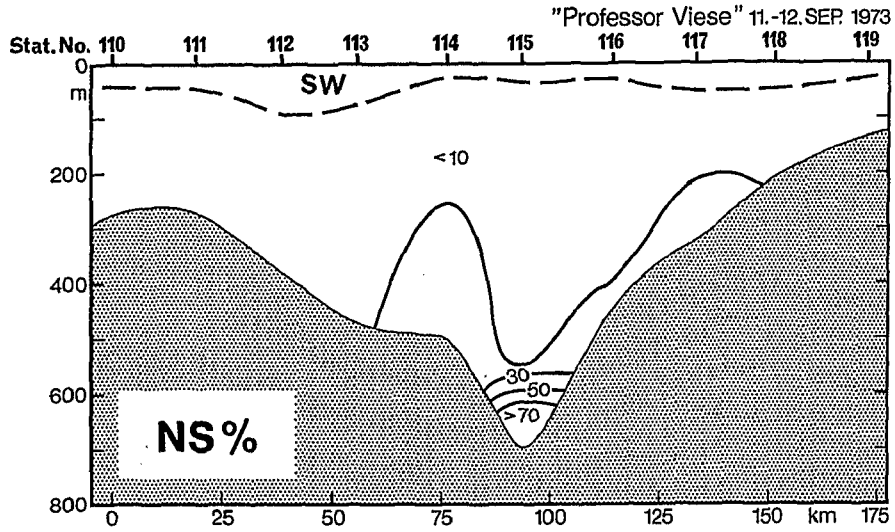

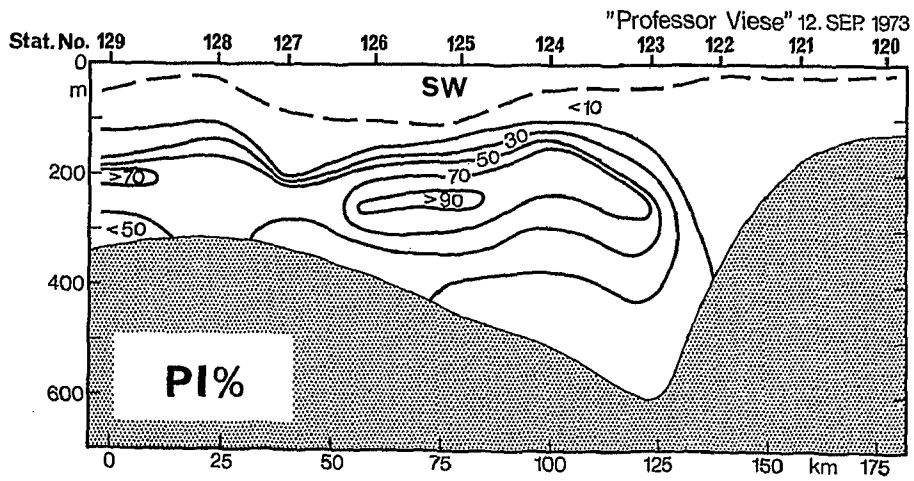
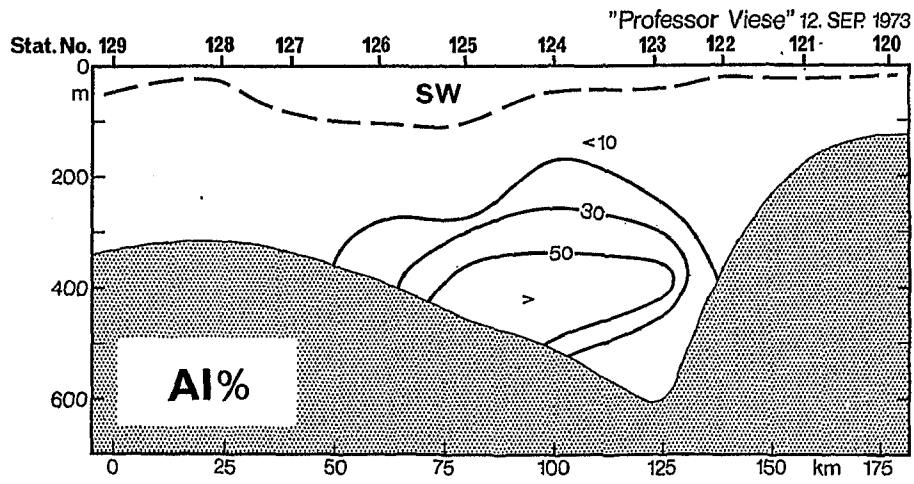
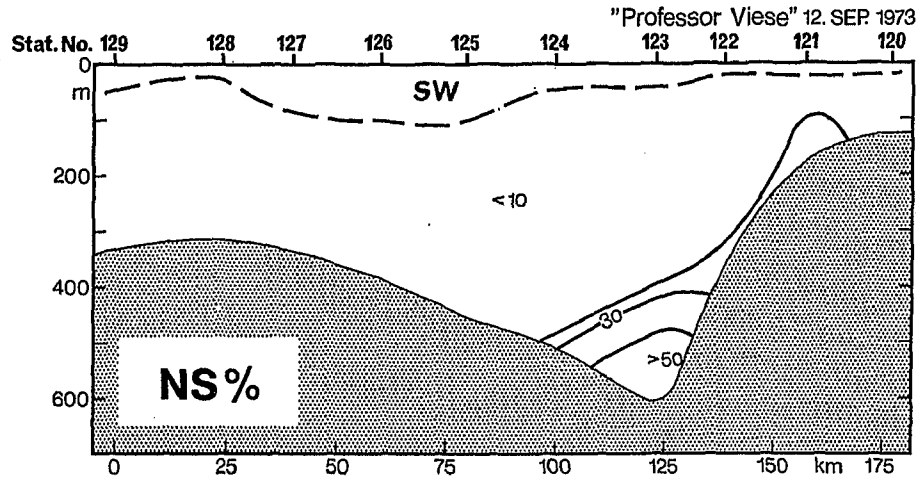



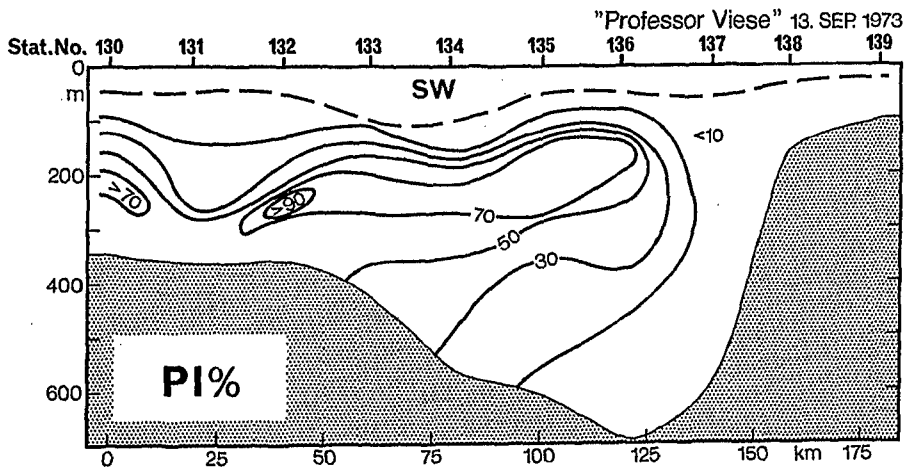
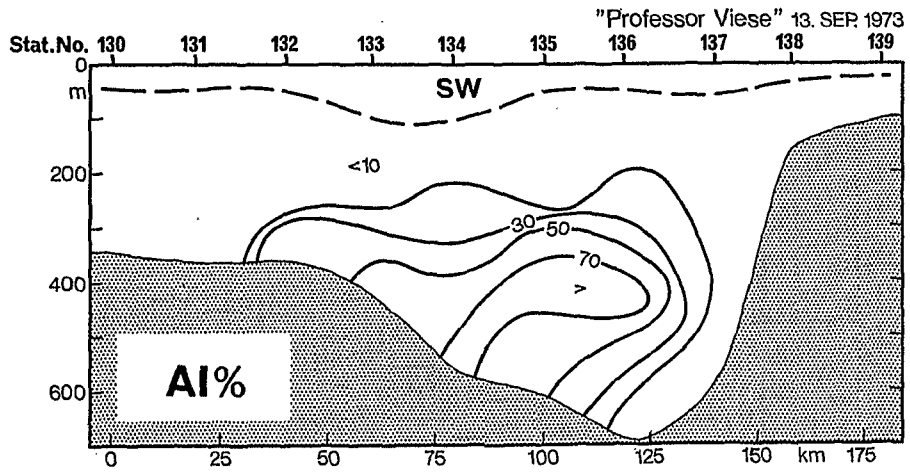
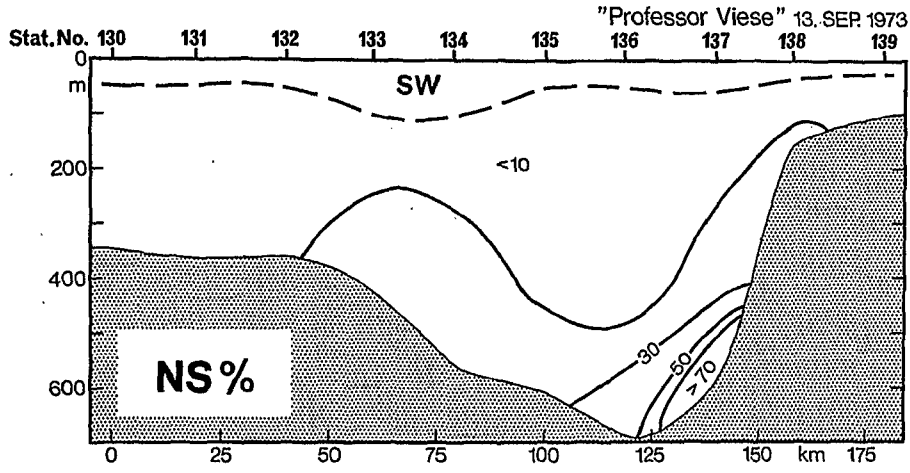

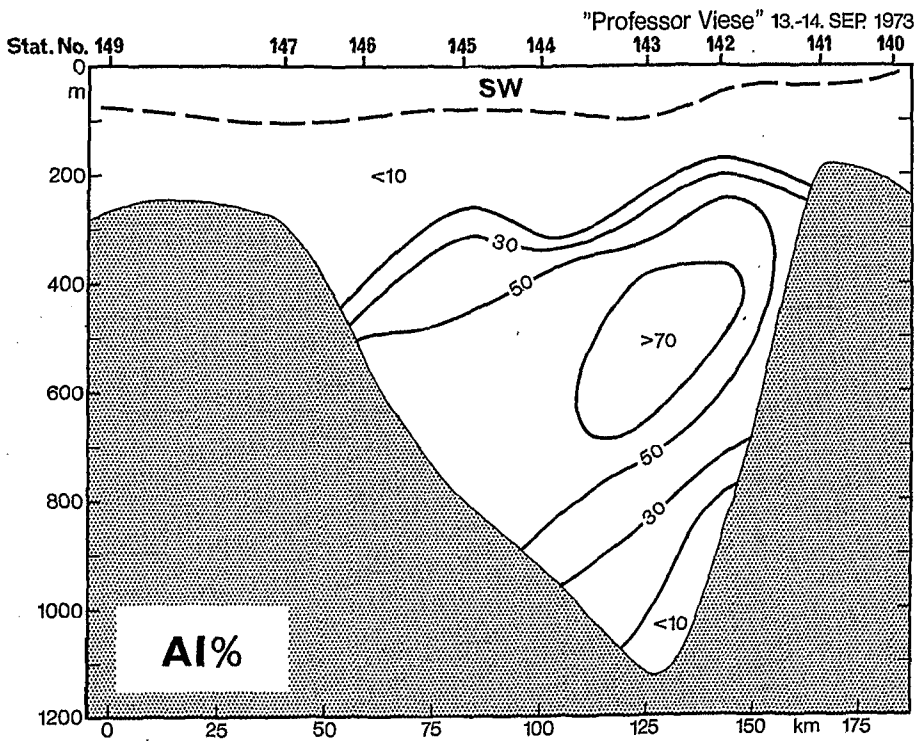
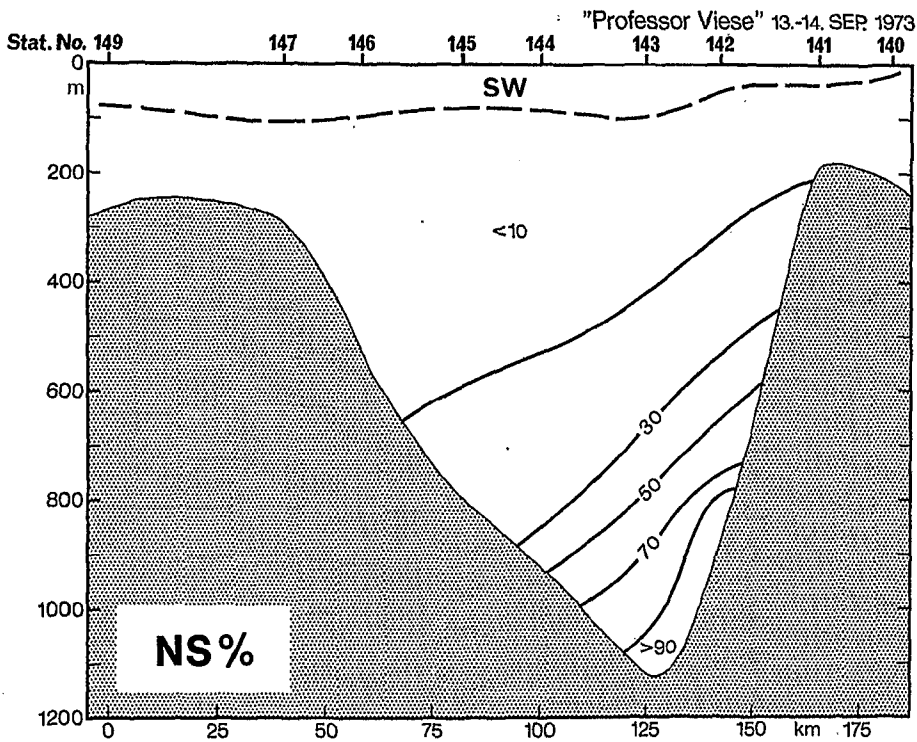

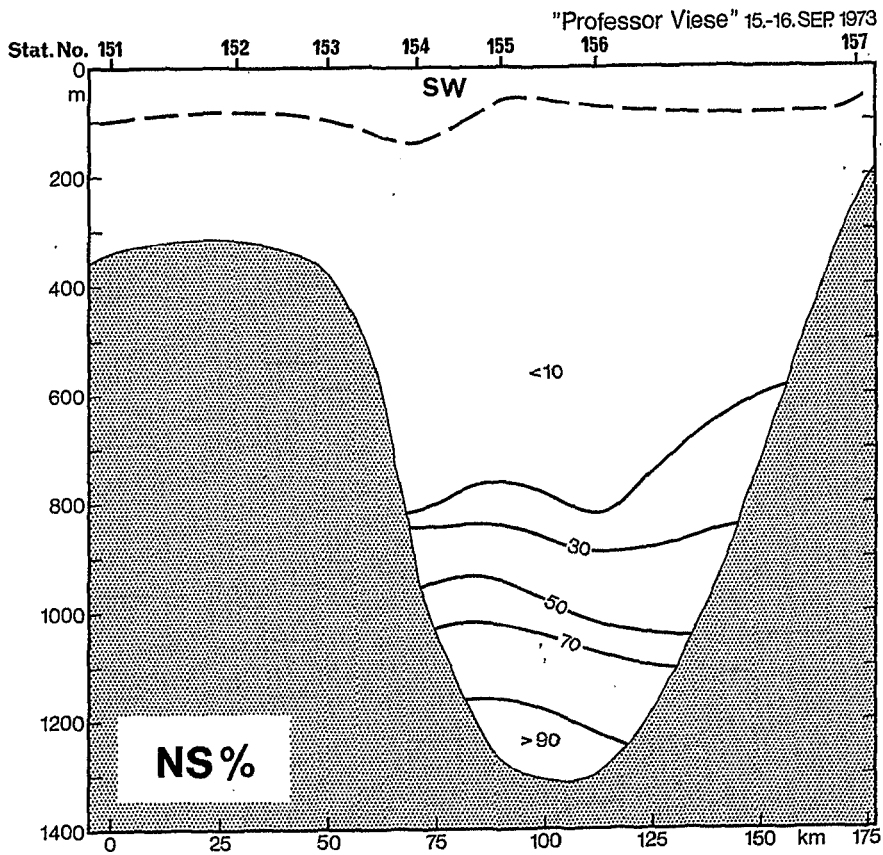
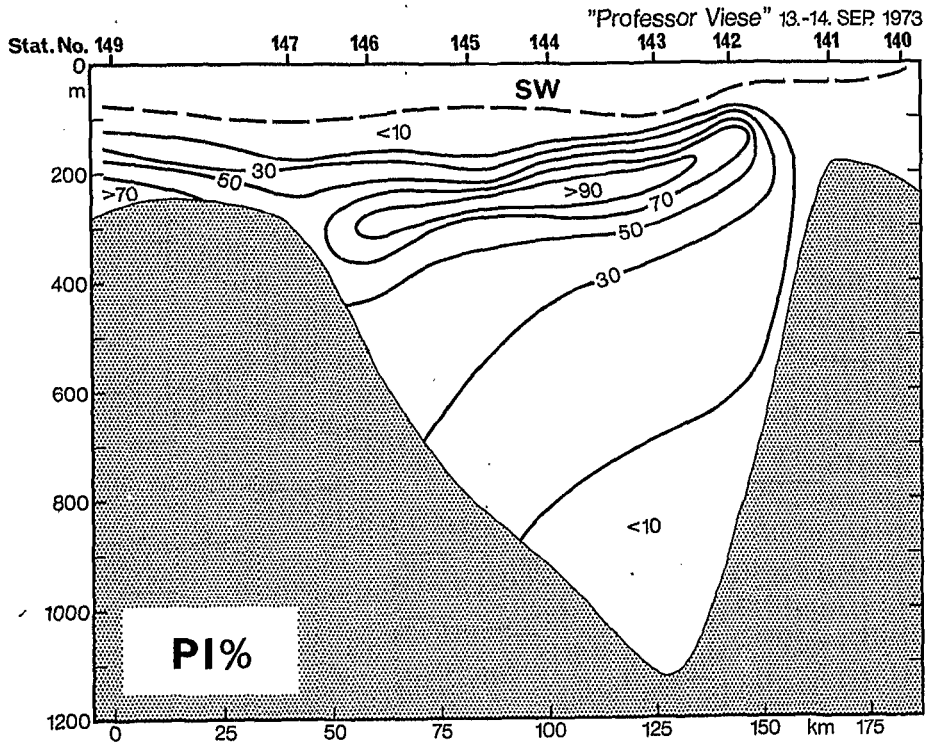

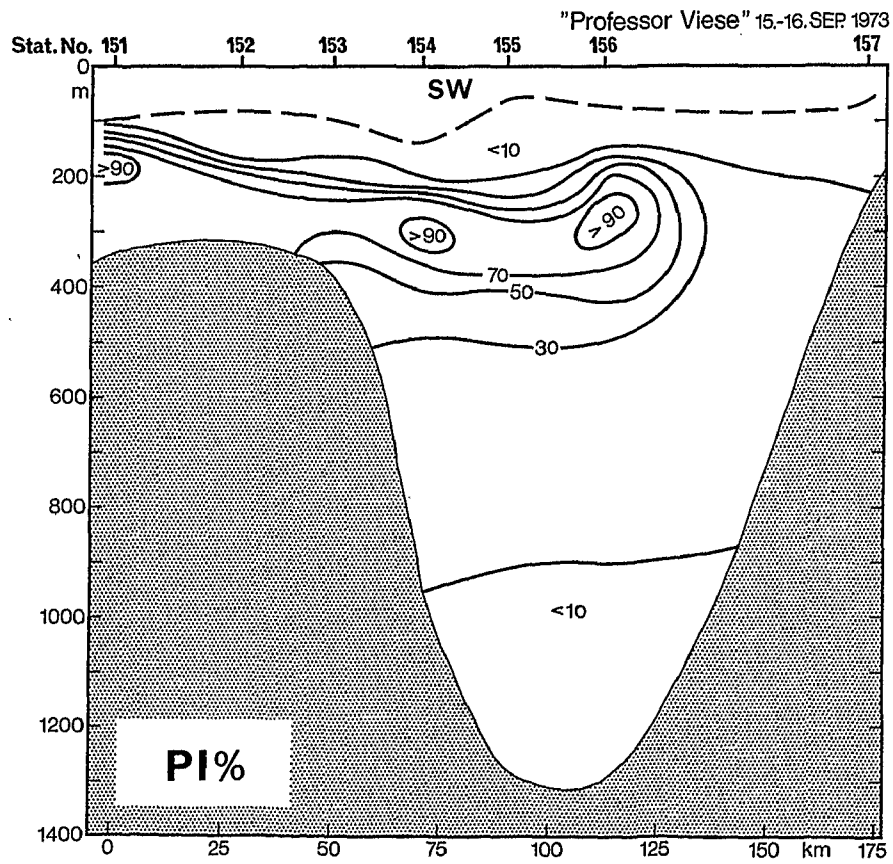
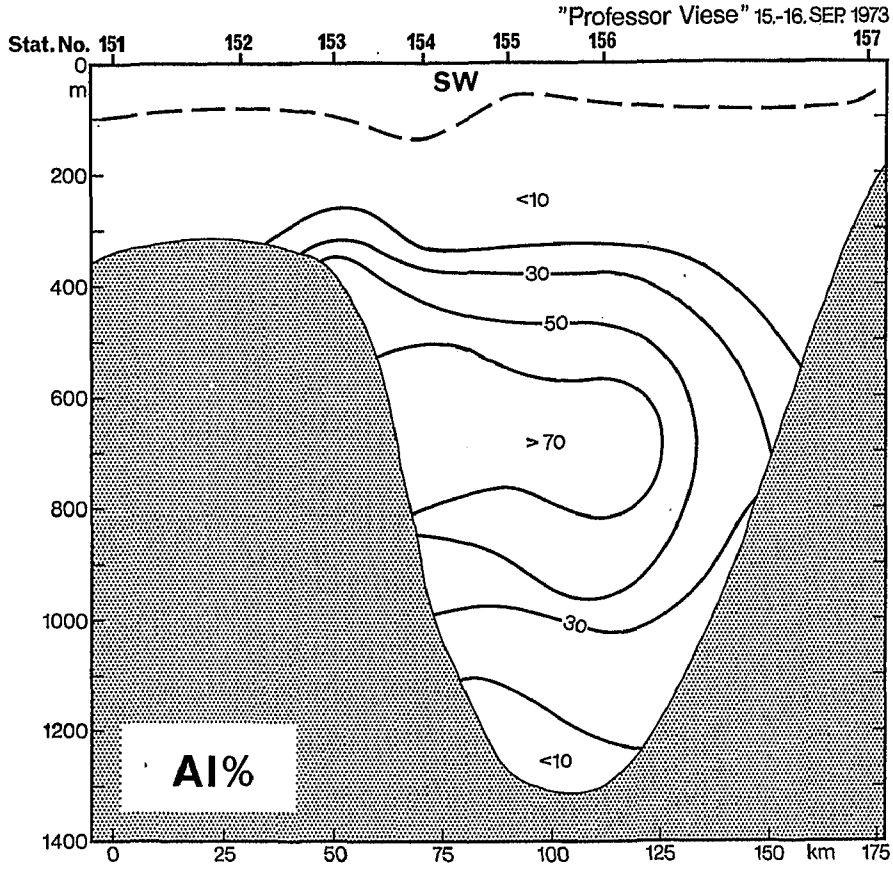

CORRIGENDUM

1. p. 14, Table 1: Replace the table by the new one, appended.
2. p. 103, after W. Herwig  
Insert: "TS-values from the upper 90 m have  
not been analysed".
3. p. 111 to 124 : In all sections the phrase "no data" is to be  
replaced by "not analysed".

(T.J. Müller)

5. Tables

Table 1 List of origin of data

Ship	Institute/Organisation
Explorer	DAFS, Marine Laboratory, Aberdeen
Helland-Hansen	Geophysical Institute, Bergen
J.C. Svabo	Institute for Physical Oceanography, Copenhagen
Challenger	SMBA, Oban; ICES
Cirolana	Fish. Lab. Lowestoft
Shackleton	IOS-Wormley
B. Davydov	Hydrogr. Serv. of the Navy, Leningrad; ICES
Meteor	Institut für Meereskunde, Kiel
Bj. Saemundsson	Marine Research Institute, Reykjavik; ICES
W. Herwig	COB, Plouzané
Hudson	Bedford Institute of Oceanography, Dartmouth
Prof. Viess	Arctic and Antarctic Research Institute, Leningrad; ICES