

Biovolumes and Size-Classes of Phytoplankton in the Baltic Sea



Helsinki Commission
Baltic Marine Environment Protection Commission

Baltic Sea Environment Proceedings No. 106

Biovolumes and size-classes of phytoplankton in the Baltic Sea



Helsinki Commission
Baltic Marine Environment Protection Commission

Authors:

Irina Olenina, Centre of Marine Research, Taikos str 26, LT-91149, Klaipeda, Lithuania
Susanna Hajdu, Dept. of Systems Ecology, Stockholm University, SE-106 91 Stockholm, Sweden
Lars Edler, SMHI, Ocean. Services, Nya Varvet 31, SE-426 71 V. Frölunda, Sweden
Agneta Andersson, Dept of Ecology and Environmental Science, Umeå University, SE-901 87 Umeå, Sweden, Umeå
Marine Sciences Centre, Umeå University, SE-910 20 Hörnefors, Sweden
Norbert Wasmund, Baltic Sea Research Institute, Seestr. 15, D-18119 Warnemünde, Germany
Susanne Busch, Baltic Sea Research Institute, Seestr. 15, D-18119 Warnemünde, Germany
Jeanette Göbel, Environmental Protection Agency (LANU), Hamburger Chaussee 25, D-24220 Flintbek, Germany
Slawomira Gromisz, Sea Fisheries Institute, Kollataja 1, 81-332, Gdynia, Poland
Siv Huseby, Umeå Marine Sciences Centre, Umeå University, SE-910 20 Hörnefors, Sweden
Maija Huttunen, Finnish Institute of Marine Research, Lyypekinkuja 3A, P.O. Box 33, FIN-00931 Helsinki, Finland
Andres Jaanus, Estonian Marine Institute, Mäealuse 10 a, 12618 Tallinn, Estonia
Pirkko Kokkonen, Finnish Environment Institute, P.O. Box 140, FIN-00251 Helsinki, Finland
Iveta Ledaine, Inst. of Aquatic Ecology, Marine Monitoring Center, University of Latvia, Daugavgrivas str. 8, Latvia
Elzbieta Niemkiewicz, Maritime Institute in Gdansk, Laboratory of Ecology, Dlugi Targ 41/42, 80-830, Gdansk, Poland

All photographs by Finnish Institute of Marine Research (FIMR)

Cover photo: *Aphanizomenon flos-aquae*

For bibliographic purposes this document should be cited to as:

Olenina, I., Hajdu, S., Edler, L., Andersson, A., Wasmund, N., Busch, S., Göbel, J., Gromisz, S., Huseby, S., Huttunen, M.,
Jaanus, A., Kokkonen, P., Ledaine, I. and Niemkiewicz, E. 2006
Biovolumes and size-classes of phytoplankton in the Baltic Sea
HELCOM Balt. Sea Environ. Proc. No. 106, 144pp.

Information included in this publication or extracts thereof
is free for citing on the condition that the complete
reference of the publication is given as stated above

Copyright 2006 by the Baltic Marine Environment Protection Commission - Helsinki Commission -

ISSN 0357-2994

Table of Contents

Preface.....	6
1 Introduction	7
2 Material and methods	9
2.1 General procedure	9
2.2 Geometric shapes and equations	9
3 Results	14
3.1 Definition of size classes	14
3.2 Measurement of “hidden” dimensions	15
3.3 Measurements of complex cell shapes	17
3.4 Biovolumes and size-classes of the Baltic Sea phytoplankton species	17
4 Discussion	18
Addendum.....	19
Acknowledgements.....	20
References.....	21
Annex 1.....	22

Preface

This report on biovolumes and size-classes of phytoplankton in the Baltic Sea has been produced by the HELCOM Phytoplankton Expert Group (PEG). Most laboratories involved in the HELCOM Baltic Monitoring Programme (COMBINE) have contributed to the work, using regional phytoplankton data. Distinct size-classes and biovolumes were agreed upon and established for most Baltic species which are possible to identify using a light microscope and the Utermöhl counting technique.

The need for a comprehensive compilation was recognised already at the beginning of the phytoplankton studies in the framework of the Baltic Monitoring Programme. Since quality assurance of data is an important component of the HELCOM monitoring programme, measures were taken to evaluate and improve the recommended methods through intercalibrations between the different partners. In 1991 HELCOM PEG was established, with the main

aim to unify methods of collection, counting and identification of phytoplankton species. Since accurate biomass estimates are important in phytoplankton monitoring, PEG also made considerable efforts to standardise size-classes and biovolumes of phytoplankton species found in the Baltic Sea.

It is recommended that the present list with biovolumes and fixed size-classes be used for the calculation of phytoplankton biomass in routine monitoring of Baltic Sea phytoplankton. This list is meant to be an integral component of HELCOM's phytoplankton counting programme, PhytoWin. The list will be updated as new information is obtained.

The use of a standardised species list with fixed size-classes and biovolumes will be a decisive measure for improving the quality of the phytoplankton counting method and the comparability of results.



1 Introduction

Phytoplankton constitutes an elementary component in aquatic ecosystems. Representing the base of the pyramid of productivity, the understanding and modelling of the aquatic ecosystem is not possible without knowledge of the species composition, productivity and biomass of phytoplankton.

The history of quantitative plankton research goes back to Hensen's (1887) pioneering study of plankton standing stock and productivity conducted in the Kiel Bight from 1883 to 1886. Up to the 1920s, microscopic counting of net samples was the conventional method. Already Lohmann (1908) discussed the unsuitability of net sampling for quantitative analysis and carried out filtration and centrifugation to enrich the water sample for microscopic analysis. The rough treatment of the delicate cells with filtration or centrifugation was replaced by a gentle sedimentation technique, using special sedimentation chambers and inverted microscopes. This method, now called the Utermöhl method (Utermöhl 1958), completed by Lund *et al.* (1958) with statistical basics of the precision of the counting method, has become the standard method for quantitative phytoplankton studies in both marine and freshwater environments.

Early monitoring programmes, starting 1902, were co-ordinated by the International Council for the Exploration of the Sea (ICES), with 4 cruises per year, covering most of the Baltic Proper. A short-coming of these early activities was the poor comparability of the data due to the variety of methods applied, concerning sampling, fixatives, counting and mode of calculation. One of the used methods was semi-quantitative, using a dominance scale of 5 classes (cf. ICES 1989). This method was more subjective than the quantitative method, and data from different locations and different seasons could not be compared (Apstein 1904). World War I put a total stop to this research. In the following decades, the main interests shifted to physico-chemical analyses and finally to environmental properties and processes, promoted by improvements in analytical methods, including primary production and chlorophyll measurements.

In the 1960s, eutrophication became obvious in the Baltic Sea. The riparian countries recognised the increasing environmental problems and

agreed to establish the Baltic Marine Environment Protection Commission (Helsinki Commission, HELCOM) in 1974. One of the aims was to investigate long-term trends in trophic conditions. Monitoring has been conducted since 1979 through the Baltic Monitoring Programme (BMP), according to a co-ordinated sampling schedule and with binding methods (Edler 1979a, HELCOM 1988). For quantitative phytoplankton analyses, the Utermöhl method was adopted, as suggested by the Baltic Marine Biologists (BMB) following the recommendation by Edler (1979a).

From the beginning of the monitoring programme, HELCOM took measures to evaluate and improve the recommended methods through intercalibrations between the different partners (Edler 1979b, Edler 1983, Niemi *et al.* 1985, HELCOM 1991). The first two intercalibration exercises in Stralsund 1979 and Rönne 1983 revealed the need for regular workshops and training courses for all persons involved in HELCOM phytoplankton counting. The third intercalibration workshop and first training course in Visby, 1990, resulted in the establishment of the HELCOM Phytoplankton Expert Group (PEG), with the aim to reduce the subjective component especially in species identification. The main goal was the improvement of individual knowledge in phytoplankton taxonomy and to agree on the use of the same name for the same taxa. A checklist of phytoplankton species found in the Baltic Sea was established already in 1984 for this purpose, (Edler *et al.* 1984). This checklist was recently revised by Hällfors (2004) and forms the basis of the species list published in this paper.

A further important step for improvement of the phytoplankton analysis has been the development of standard counting and calculation procedures. This has been enabled by computer software. Already in 1993, the Finnish Institute of Marine Research (FIMR) initiated the creation of the programme PHYTO together with the software company Kahma Ky (Helsinki). In 1994 HELCOM bought licenses of this programme for all countries participating in the monitoring of the Baltic Sea. In 2003 the programme was adapted to a user-friendly WINDOWS environment, which ensures that it will be used by all phytoplanktologists working in the combined coastal and open sea monitoring

programme of HELCOM (COMBINE).

The inadequacy of using data on cell concentrations for the estimation of the phytoplankton community has long been recognised. For observations of whole phytoplankton communities, containing a wide range of size-classes, biovolume will give a more accurate picture (Paasche 1960). However, the first data to be obtained from counting is abundance. The phytoplankton biovolume concentration has to be derived from the cell abundance and cell biovolumes. Cell volumes can be calculated from cell-size and shape by use of appropriate geometric formulas. As it is impossible to measure and calculate every individual in routine counting,

the same shape and a mean size was originally assumed for each species. This simplification, however, introduces a hardly quantifiable error into the biovolume calculation. As many species show a wide range in size, the calculation was improved by counting in appropriate size-classes. Important goals of the PEG work since 1997 have been the re-evaluation of species-specific geometric formulas and development of size-classes. The use of a standardised species list with fixed size-classes and biovolumes, will be a decisive measure to improve the quality of the phytoplankton counting method. This list is an integral component of the PhytoWin counting and calculation programme.



Achnanthes taeniata



Peridiniella catenata

2 Material and Methods

2.1 General procedure

Phytoplankton samples were collected and treated according to the standard HELCOM (1988) methods in all regions of the Baltic Sea, including the Kattegat and the major gulfs (Bothnia, Finland, Riga and Gdansk). Data received during routine monitoring between 1980 and 2003, by different national laboratories around the Baltic Sea, were mainly used. The participating laboratories presented the most common sizes of all species occurring in their regional areas, based on their earlier measurements using high magnification (400–600 times). When needed, additional measurements were performed with the ambition to measure dimensions of at least 25 cells at each laboratory. The total number of measurements varied between species, but all together more than 100 cells were measured for all dominating taxa. Data from the different laboratories were compared, and clustered cell-sizes were grouped into size-classes. In general, the arithmetic mean of each size-class was used as a standardised biovolume. In some cases there were gaps in size-classes, due to lack of measurements (e.g. *Amphiprora paludosa* v. *paludosa*, *Gyrosigma macrum*, *Suriella crumena*).

Valid names of the phytoplankton taxa were based on the recent Checklist of Baltic Sea Phytoplankton Species (Hällfors 2004) with few exceptions. The biovolume list includes only

taxa, which were measured and could be identified by light microscope. Identification to species level is not always possible in Lugol preserved material and therefore volumes for higher taxonomic ranks are also included in the list. Some newly described taxa, e.g. *Aphanothece parallelliformis* Cronberg (Cronberg 2003), and taxa found and measured after the publication of the Baltic Sea Checklist (Hällfors 2004) were also added to the list. These taxa are marked with an asterisk in the comment column.

2.2 Geometric shapes and equations

For each taxon the best fitting geometric shape and matching equation was used. The survey of phytoplankton species present in the Baltic Sea resulted in 16 basic geometric shapes to be used for the determination of the biovolume of cells. All basic shapes and equations are shown in Table 1. Many of the shapes were used already in the earlier recommendation (Edler 1979a), whereas others are new, and some have been given new names. It should be clear however, that it is not possible to classify each shape of all phytoplankton species into the few basic geometric shapes being used. The aim has been to find shapes, which require as few measurements as possible, but which at the same time reflect the shape of the organism as far as possible.

Table 1. Basic geometric shapes and formulas for the calculation of phytoplankton biovolume. Dimensions to be measured are: d: diameter, h: height, l: length, w: width.

Sphere

Volume: $V = \pi/6 * d^3$

V: volume
d: diameter

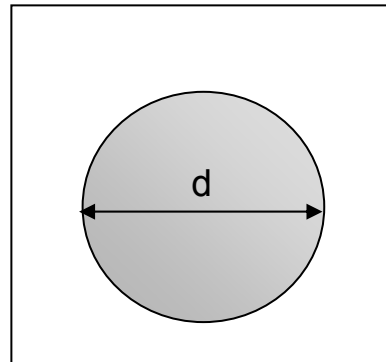

Half Sphere

Volume: $V = \pi/12 * d^3$

V: volume
d: diameter

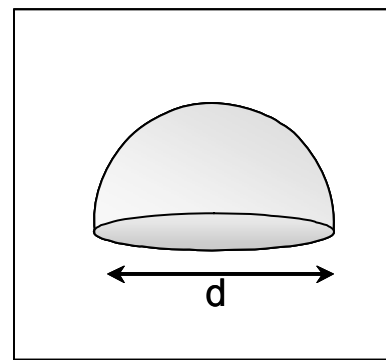

Cylinder

Volume: $V = \pi/4 * d^2 * h$

V: volume
d: diameter
h: height

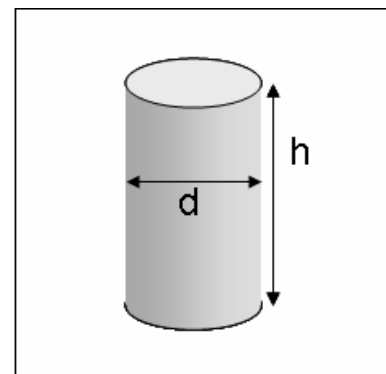

Oval Cylinder
(ellipsoid or prism on elliptic base)

Volume: $V = \pi/4 * d_1 * d_2 * h$

V: volume
d₁: large diameter
d₂: small diameter
h: height

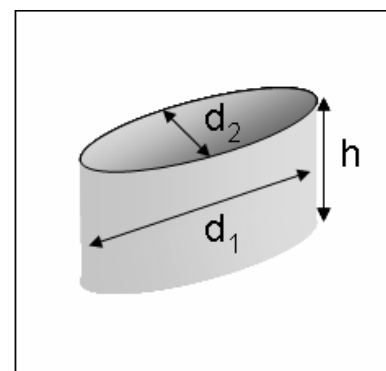

Rotational Ellipsoid

Volume: $V = \pi/6 * d^2 * h$

V: volume

d: diameter

h: height

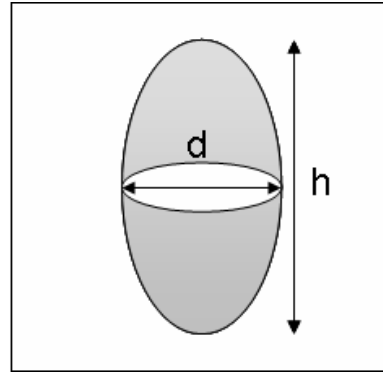

Flattened Ellipsoid

Volume: $V = \pi/6 * d_1 * d_2 * h$

V: volume

d₁: large diameter

d₂: small diameter

h: height

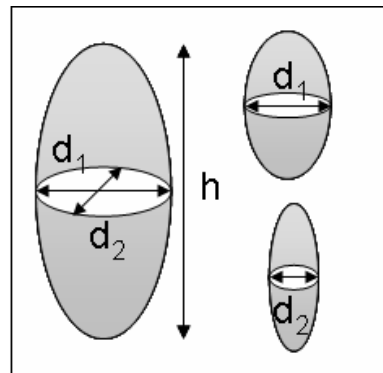

Cone

Volume: $V = \pi/12 * d^2 * h$

V: volume

d: diameter

h: height

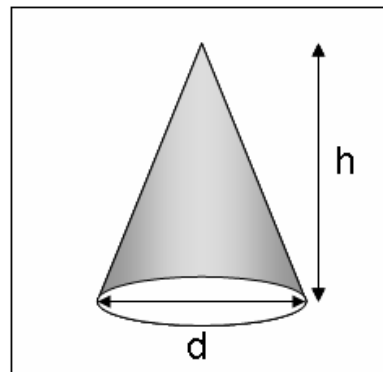

Truncated Cone

Volume: $V = \pi/12 * h * (d_1^2 + d_1 d_2 + d_2^2)$

V: volume

d₁: large diameter

d₂: small diameter

h: height

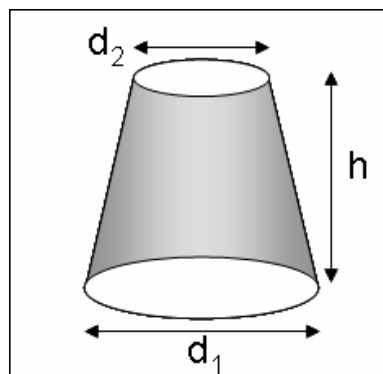

Half Cone

Volume: $V = \pi/24 * d^2 * h$

V: volume

d: diameter

h: height

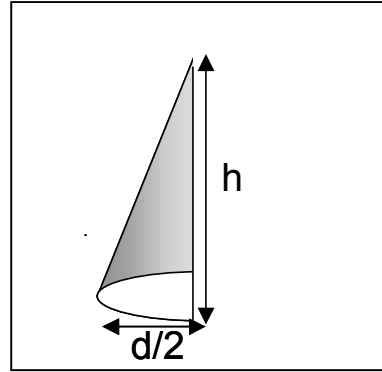

Double Cone

Volume: $V = \pi/12 * d^2 * h$

V: volume

d: diameter

h: height

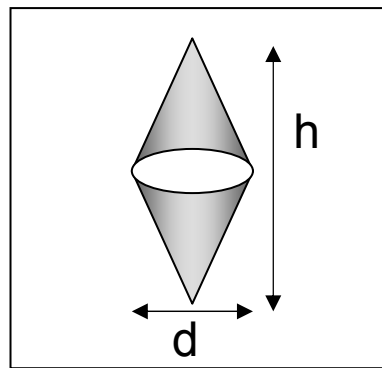

Parallelepiped

Volume: $V = l * w * h$

V: volume

l: length

h: height

w: width

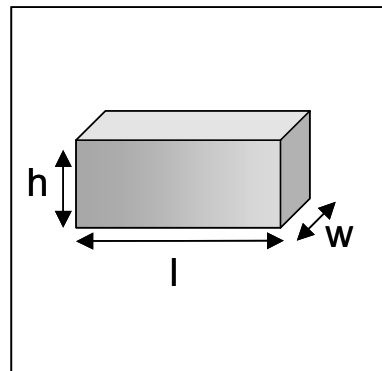

Half Parallelepiped (prism on triangular base)

Volume: $V = l * w * h / 2$

V: volume

l: length

h: height

w: width

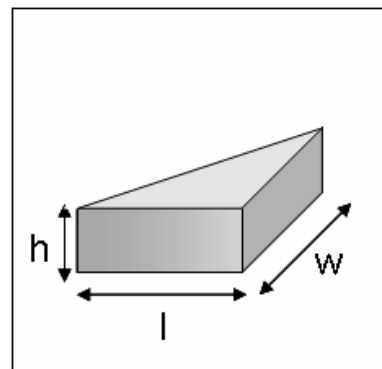

Trapezoid

Volume: $V = 1/2 * h * w * (l_1 + l_2)$

V: volume

l_1 : length

l_2 : length

h: height

w: width

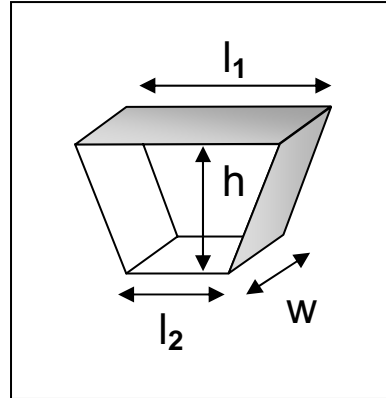

Cone with half Sphere

Volume: $V = \pi / 12 * d^2 * h$

V: volume

d: diameter

h: height

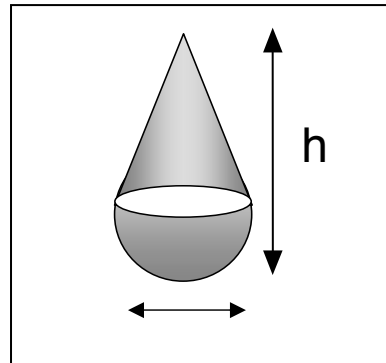

Half Cone + cut flattened Ellipsoid

Volume: $V = (\pi / 24 * d_1^2 * h_1) + (\pi / 6 * d_1 * d_2 * h_2)$

V: volume

d_1 : large diameter

d_2 : small diameter

h_1 : 0.3 * total height of cell

h_2 : 0.7 * total height of cell

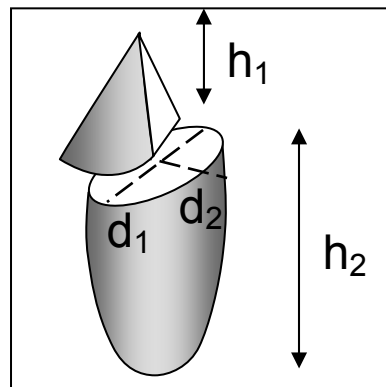

Monoraphidioid

Volume: $V = d^2 / 8 * (2b - d + a) * (\pi^2 / 6 + 1)$

V: volume

a: large diameter of ellipse

b: small diameter of ellipse

d: diameter of cell

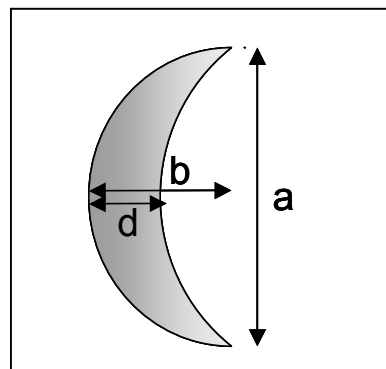

3 Results

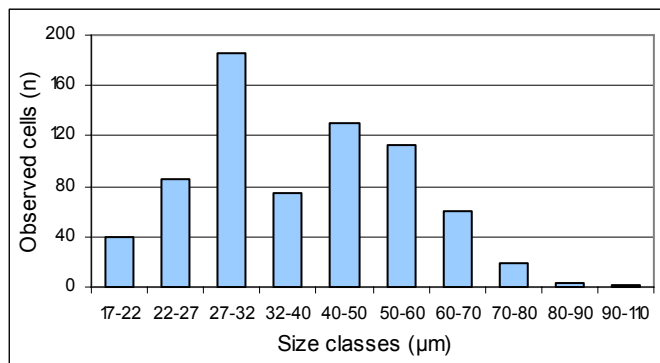

Figure 1. Distribution of cell diameter (apical axis) of *Thalassiosira baltica*.

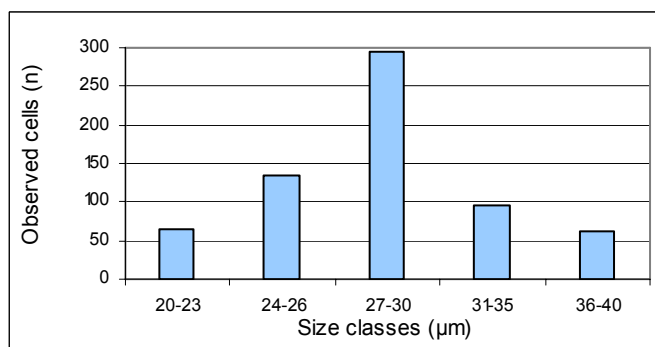

Figure 2. Distribution of cell diameter (cingulum) of *Peridiniella catenata*.

3.1 Definition of size classes

The applied number of size-classes depended on the size variation of each taxon. Taxa showing large size variations were given more size-classes than those with a low variation. As examples, size-classes are presented for three commonly occurring phytoplankton species/genera: *Thalassiosira baltica*, *Peridiniella catenata*, and *Aphanizomenon* sp. Morphometric parameters of *T. baltica* and *P. catenata* showed large size variations, while *Aphanizomenon* sp. showed a small variation.

T. baltica occurs all year round in the Baltic Sea, with a maximum occurrence during the spring bloom, when it may dominate the phytoplankton (Hällfors and Niemi 1981, Andersson *et al.* 1996, HELCOM 1996). The diameter of the valve (apical axis) was measured on 712 cells and 10 size-classes were selected to comprise aggregated size-groups. The diameter ranged from 20 to 100 µm (Figure 1). Two peaks were found, at 30 µm and 45 µm. The average diameter was 41.5 µm, the standard deviation 15.5 and the coefficient of variation was 37%.

P. catenata is one of the most common dinoflagellates during the spring bloom in the Baltic Sea (e.g. Hällfors and Niemi 1981, Andersson *et al.* 1996, HELCOM 1996) and is related to cold water (Edler *et al.* 1984). The size of 580 cells was measured, and the cell sizes were found to be normally distributed. The average cell size was 30 µm, and the coefficient of variation 18%. Five size classes were selected, which comprised clustered cell-sizes (Figure 2).

Aphanizomenon sp. is one of the most common filamentous blue-green algae in the open Baltic Sea (e.g. HELCOM 1996, Larsson *et al.* 2001). It is often referred to *A. flos-aquae*, but recent studies suggest that the Baltic *Aphanizomenon* may be a species of its own (Janson *et al.* 1994). *Aphanizomenon* sp. has its maximum during summer and autumn (e.g. Hällfors and Niemi 1981, Andersson *et al.* 1996, Wasmund 1997, Larsson *et al.* 2001). The diameter of 310 cells collected at open sea stations, ranged from 3-5.2 µm. The average diameter was 4.1 µm and the coefficient of variation ~10%. The results are in agreement with Congestri *et al.* (2003), who reported an average diameter of 4.2 µm for *Aphanizomenon* sp. (range 3-5.6 µm, coefficient of variation ~14%, n=1139). Because of this small variation the biovolume of *Aphanizomenon* sp. was based only on the average diameter.

3.2 Measurement of “hidden” dimensions

Some of the algal dimensions are seldom visible in the microscope during routine analysis. Examples of such hidden dimensions (HD) are the pervalvar axis of many diatoms and the “thickness” of e.g. *Dinophysis* and *Protoperdinium*. As the hidden dimension is needed in the calculation of the cell volume of many phytoplankton species, the HD was measured on fixed and living material. Identified HD-factors are presented in the Comments column of the species list (Annex 1).

Some examples of the relation between HD and visible dimensions are shown in Figures 3 and 4. *Thalassiosira baltica* represents centric diatoms with a cylinder shape, while *Dinophysis acuminata* is an example of a species with a flattened ellipsoid shape.

The volume of *T. baltica* is calculated as a cylinder. The HD is the pervalvar axis (PA) of the cell, and has previously been reported to be about one-third to one-half of the cell diameter (Hasle and Syvertsen 1997). The apical and pervalvar axis (HD) on 163 cells were measured and a weak correlation was found (Figure 3).

T. baltica varies considerably in diameter (20-100 μm). Factors for three size groups (small, medium and large) were calculated according to the common distribution of cell size (Table 2).

The volume of *Dinophysis* species is calculated from the equation of a flattened ellipsoid, which needs a measure of the thickness (width in ventral view) of the organism. Factors for the HD were derived from the ratio between cell thickness (HD) and the cell length (Figure 4, Table 3).

While there is a correlation between length and width (in lateral view), the HD of the cell (width in ventral view) varies. The average HD/Length factor 0.5 was used in the volume calculation because the relatively few measurements did not allow separation of smaller and larger cells.

According to the measurements taken, the Baltic Sea *D. acuminata* is more variable in size, especially in cell width (25-48 μm), than is known from the literature (30-38 μm in Larsen and Moestrup 1989). The range of the length/width ratio is also wider, 1.14 – 1.74, compared to the data in Dodge (1982).

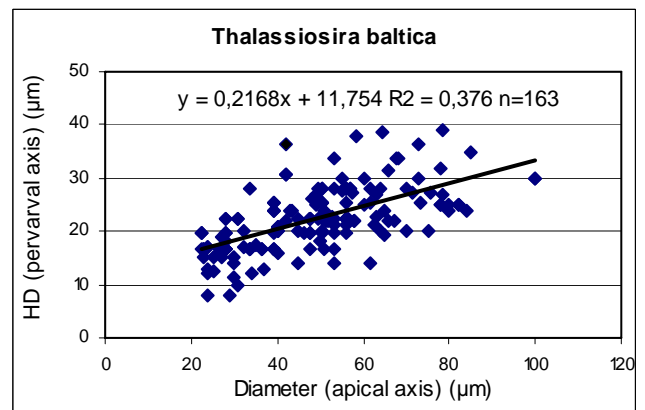

Figure 3. Relation between the hidden dimension (HD, pervalvar axis) and the diameter (apical axis) in *Thalassiosira baltica*.

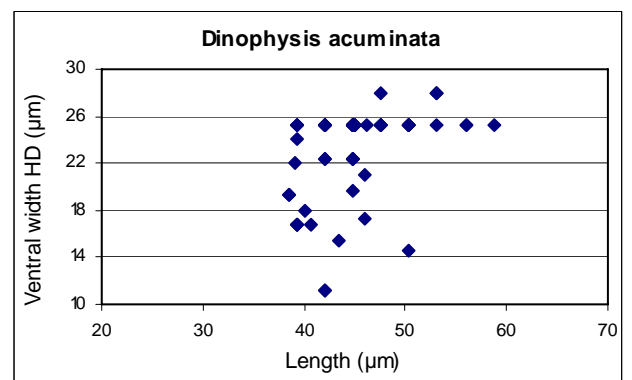
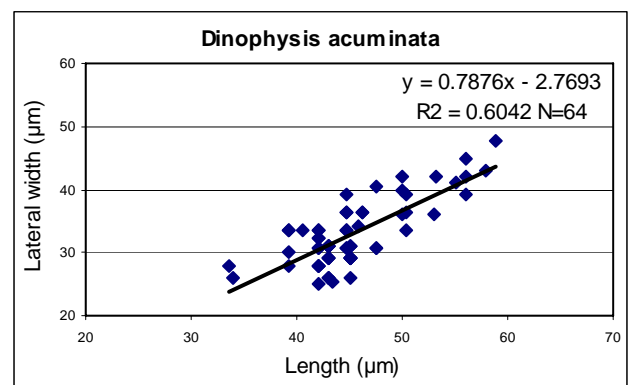

Figure 4. Relation between cell length and “lateral width” (top) and between cell length and the hidden dimension (HD, “ventral width”, bottom).

Table 2. Cell-sizes (μm) and factors calculated from direct measurements of *Thalassiosira baltica*. Bold-marked numbers used for calculation of biovolumes. AA: apical axis, PA: peralvar axis.

	<32 μm			32-70 μm			>70 μm		
	Diameter (AA)	HD (Hidden dimension) (PA)	HD/AA	Diameter (AA)	HD (Hidden dimension) (PA)	HD/AA	Diameter (AA)	HD (Hidden dimension) (PA)	HD/AA
MEDIAN	27	17	0.6	50	22	0.5	78	27	0.3
AVG	27	16	0.6	50	23	0.5	79	28	0.35
STDEV	3	4	0.1	9	5	0.1	8	5	0.1
CV %	10	23	22	18	23	26	10	18	19
MIN	22	8	0.3	32	12	0.2	70	20	0.3
MAX	31	22	0.9	68	39	0.9	100	39	0.5
n	33	33	33	109	109	109	21	21	21

Table 3. *Dinophysis acuminata* cell sizes (μm) and factors calculated from direct measurements. Bold-marked number used for calculation of biovolumes.

	Length (L)	Lateral width (W)	W/L	Length (L)	Ventral width (HD)	HD/L
MEDIAN	45	31	0.7	45	25	0.5
AVG	45	33	0.7	45	23	0.5
CV %	11	16	10.2	11	17	17
MIN	34	25	0.6	39	11	0.3
MAX	59	48	0.9	59	28	0.6
n	64	64	64	60	60	60

3.3 Measurements of complex cell shapes

In some cases, the bizarre shapes of cells require complicated equations for the biovolume calculations. For example, according to earlier recommendations and guidelines (Edler 1979a, HELCOM 1988), a model of a *Ceratium* cell is composed of 4 to 5 geometric shapes, requiring up to 12 length and diameter measurements per cell. Even with this time-consuming procedure, the biovolume cannot be adequately calculated. Especially the flattening of the cell and the excavation of the ventral side cannot be measured in fixed samples, and several assumptions have to be made.

The most relevant dimension for the cell volume is the width at the cingulum, whereas the lengths of the horns contribute much less. The size-classes defined here are based on the extensive measurements by Thomsen (1992) on the temporal variability. If the mean width of the cell for each size-class is defined, the cell volume is found from the correlations determined by Thomsen (1992).

3.4 Biovolumes and size-classes of the Baltic Sea phytoplankton species

A total of 694 taxa were analysed (Annex 1). Most of these taxa are included in the recent Checklist of Baltic Sea Phytoplankton Species (Hällfors 2004). The study generated information on taxonomic order, species/genera name (Latin name), author(s), size-classes (size-range), geometric shape of the cell, geometric equation, and measurements needed for biovolume calculation; all of which are included in the table. For convenience, the biovolumes were calculated for counting units (called cell number in the table): most often this means single cells and sometimes 100 µm threads, coenobiums and colonies of 4, 8, 16, 20, 50, 100, or 200 cells (HELCOM 1988).

As a result of the large salinity range in the Baltic Sea, the species list covers a wide range of marine and freshwater species. This may make the list too long for practical use in a laboratory conducting phytoplankton monitoring in a restricted area. By extracting suitable data from the net version of the biovolume table into a new spreadsheet the list can easily be adapted to cover the species, equations and biovolumes occurring in a specific region of the Baltic Sea.



Thalassiosira baltica



Chaetoceros wighamii

Woloszynskia halophila

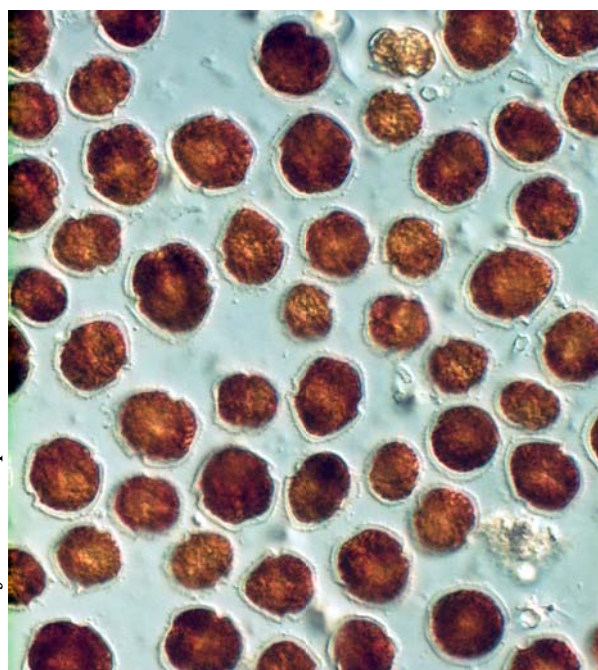

4 Discussion

During the last years, quality assurance criteria have been intensively discussed and developed in both national and international working groups. Phytoplankton monitoring data still show incoherence concerning three main aspects: the use of different names, or invalid synonyms for a specific species, the use of varying geometric forms of species and different biovolume calculations by different laboratories, and finally the severe risk that incomparability will arise when varying phytoplankton size-classes for specific species are used by the different laboratories. On the other hand, the scattering of biovolumes of a given species will most certainly vary from one locality to another and from one season to another.

In order to reduce the high variance in the results of phytoplankton analyses, standardisation of as many steps as possible of the procedures is necessary. The introduction and agreement of different size-classes, biovolume calculations and names as proposed here is the first step to overcome these problems.

Phytoplankton analyses performed in a strict and standardised way have shown to generate coefficient of variations (CV) for biomass concentrations of 27% for autotrophic microplankton and 18% for autotrophic nanoplankton (Andersson and Rudehäll 1993). These CVs may be used as measures for acceptable variability of phytoplankton analysis. A certain small-scale patchiness must be expected. Furthermore, the size and hence biovolume of a given taxon varies due to several factors. The variability and instability in size is dependent on environmental influence, e.g. light and nutrient availability, but also on the mode of the life cycle of different phytoplankton groups.

The use of 16 basic geometric shapes, as used in this study, may be too little to reflect all phytoplankton shapes accurately. The aim, however, was to find a compromise between the accurate shape and as few actual measurements of the phytoplankton cell as

possible. This undoubtedly introduces errors, but to an extent that was considered justified by the easier microscopical measurements. The use of cylindrical shape in e.g. *Rhizosolenia* spp. instead of cylinder plus two cones, which is more accurate, but adds two more measurements, may as an extreme result in a 15-20 % overestimate of the individual cell volume. Similarly, some *Chaetoceros* cells will be underestimated by about 10 %, when the volume of setae is not included. The use of agreed geometric shapes and equations will certainly improve the comparability between laboratories, as slightly different shapes and subsequent calculations of the biovolume of a given species have shown to give biovolume differences of factors 1.5 (e.g. *Dinophysis* spp.) to 6 (e.g. *Ditylum brightwellii*).

For many species in the present phytoplankton list, the cell volume is based on measured hidden dimensions. This is an improvement compared to earlier studies, where the hidden dimensions were based on assumptions (Edler 1979a, HELCOM 1988, Hillebrandt 1999, and lists created by the phytoplankton analysers themselves). The list only includes species and genera, which can be identified with the Utermöhl technique. As this list is based on the Checklist of Baltic Sea Phytoplankton Species (Hällfors 2004) it helps to provide comparable and homogeneous data sets of phytoplankton for the HELCOM area. This is an important step forward to achieve high quality and comparable phytoplankton data between different laboratories.

It is obvious that this biovolume list is not static, but a step in a dynamic process. The continuing PEG work will e.g. include upgrading of the list and estimates of carbon biomass. We suggest that the use of the list should be mandatory for laboratories contributing to the HELCOM database. In addition, it may be useful for other phytoplankton research in the Baltic or in other sea areas. This would allow for comparability of various phytoplankton investigations.

Addendum

The available digital version of the present phytoplankton list is an integral component of the phytoplankton counting programme "PhytoWin".

The programme PhytoWin and the manual are copyright by SoftWare Kahma Ky:

Software Kahma Ky
Koskelantie 35 E 47
FIN 00610 Helsinki, Finland
E-mail: software.kahma@kolumbus.fi
Tel.: +358-9 795 395



Nodularia spumigena

Acknowledgements



Anabaena lemmermannii

The authors are grateful for valuable contributions by Maciek Dubinski, Heidi Hällfors, Seija Hällfors, Reija Jokipii, Käte Kunert, Eugenia Lange, Susanna Minnhagen, Maija Niemelä, and Barbara Witek. We would also like to thank the Baltic Marine Environment Protection Commission – HELCOM for financial support and the Finnish Environment Institute, Finnish Institute of Marine Research, Centre of Marine Research in Klaipeda, the Swedish Centres of Marine Sciences, Baltic Sea Research Institute in Rostock, Estonian Marine Institute, Institute of Aquatic Ecology, University of Latvia and the Institute of Oceanography, University of Gdansk for organization of Phytoplankton Expert Group Meetings.

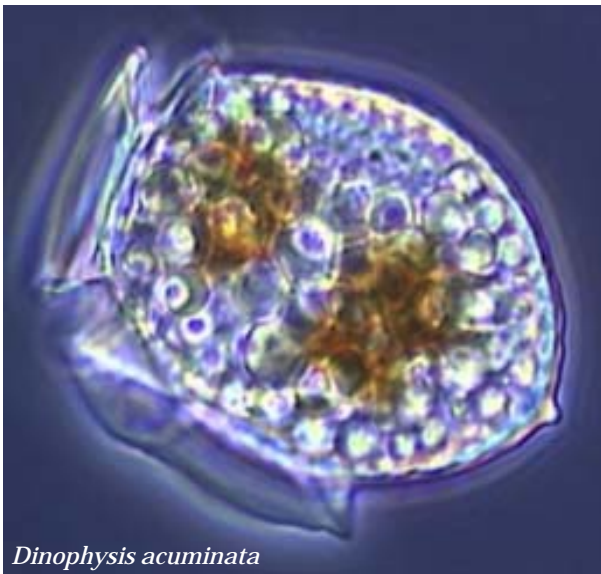

Dinophysis acuminata



Dinophysis norvegica

References

- Apstein, C., 1904. Die Schätzungsmethode in der Planktonforschung. *Wiss. Meeresunters., Abt. Kiel*. **8**: 105-123.
- Andersson, A. Rudehäll, Å., 1993. Proportion of plankton biomass in particulate organic carbon in the northern Baltic Sea. *Mar. Ecol. Prog. Ser.* **95**: 133-139.
- Andersson, A., Hajdu, S., Haecky, P., Kuparinen, J., Wikner, J., 1996. Succession and growth limitation of phytoplankton in the Gulf of Bothnia (Baltic Sea). *Mar. Biol.* **126**: 791-801.
- Congestri, R., Capucci, E. and Albertano, P., 2003. Morphometric variability of the genus *Nodularia* (Cyanophyceae) in the Baltic natural communities. *Aquat. Microb. Ecol.* **32**: 251-259.
- Cronberg, G., 2003. New and interesting cyanoprokaryotes from temperate, brackish ponds and the Baltic Sea. *Algological Studies* **109**: 197-211.
- Dodge, J. D., 1982. Marine Dinoflagellates of the British Isles. Her Majesty's Stationery Office, London, 303 pp.
- Edler, L., (ed.). 1979a. Recommendations for marine biological studies in the Baltic Sea. Phytoplankton and chlorophyll. *The Baltic Marine Biologists Publ. No 5*, 1-38pp.
- Edler, L., 1979b. Phytoplankton counts. Results and analysis of the intercalibration experiments. *Interim Baltic Marine Environment Protection Commission*, 1-20pp.
- Edler, L., 1983. Report of the phytoplankton counting working group. In: Second Biological Intercalibration Workshop. Baltic Marine Environment Protection Commission - Helsinki Commission. *Baltic Sea Environ. Proc.* No **9**, pp. 29-48.
- Edler, L., Hällfors, G. and Niemi, Å., 1984. A preliminary check-list of the phytoplankton of the Baltic Sea. *Acta Bot. Fennica* **128**: 1-26.
- Hasle, G. and Syvertsen, E.E., 1997. Marine Diatoms. Chapter 2. In: Tomas, C. R. (ed.) Identifying Marine Phytoplankton. Academic Press, San Diego, pp. 5-385.
- Hällfors, G. and Niemi, Å., 1981. Vegetation and primary production. In: Voipio, A. (ed.). The Baltic Sea. *Elsevier Oceanography Series*, **30**. Elsevier, Amsterdam, pp. 220-238.
- Hällfors, G., 2004. Checklist of Baltic Sea Phytoplankton Species (including some heterotrophic protistan groups) - *Balt. Sea Environ. Proc.* No **95**, 208 pp.
- HELCOM, 1988. Guidelines for the Baltic Monitoring Programme for the third stage. Part D. Biological determinands. *Balt. Sea Environ. Proc.* **27 D**, 161 pp.
- HELCOM, 1991. Third biological intercalibration workshop, 27-31 August 1990, Visby, Sweden. *Balt. Sea Environ. Proc.* **38**, 153 pp.
- HELCOM, 1996. Third periodic assessment of the state of the marine environment of the Baltic Sea, 1986-93; Background document. *Balt. Sea Environ. Proc.* **64 B**, 252 pp..
- Hensen, V., 1887. Über die Bestimmung des Plankton's oder des im Meer treibenden Materials an Pflanzen und Thieren. *Bericht d. Kommission z. Wiss. Untersuch. deutscher Meere.* **5**, 108 pp.
- Hillebrand, H., Dürselen, C.-D., Kirschtel, D., Pollingher, U. and T. Zohary., 1999. Biovolume calculation for pelagic and benthic microalgae. *J. Phycol.* **35**: 403-424.
- ICES, 1989. Baltic Sea patchiness experiment - PEX '86-. Part I: General report (2 volumes). In: *Cooperative Research Report*. International Council for the Exploration of the Sea, Copenhagen.
- Janson, S., Carpenter, E. J. and Bergman, B., 1994. Fine structure and immunolocalisation of proteins in *Aphanizomenon* sp. from the Baltic Sea. *Europ. J. Phycol.* **29**: 203- 211.
- Larsen, J. and Moestrup, Ø., 1989. Guide to Toxic and Potentially toxic Marine Algae. The Fish Inspection Service, Ministry of Fisheries, Copenhagen, 61 pp.
- Larsson, U., Hajdu, S., Walve, J. and Elmgren, R., 2001. Baltic nitrogen fixation estimated from the summer increase in upper mixed layer total nitrogen. *Limnol. Oceanogr.* **46**: 811-820.
- Lohmann, H., 1908. Untersuchungen zur Feststellung des vollständigen Gehaltes des Meeres an Plankton. *Wiss. Meeresuntersuchungen Kiel N.F.* **10**: 130-370.
- Lund, J. W. C., Kipling, C. and LeCren, E.D., 1958. The inverted microscope method of estimating algal numbers and the statistical basis of estimations by counting. *Hydrobiologia* **11**: 143-147.
- Niemi, Å., Melvasalo, T. and Heinonen, P., 1985. Phytoplankton counting techniques and primary production measurements - comments on the results of intercalibration. *Aqua Fennica* **15**: 89-103.
- Paasche, E., 1960. On the Relationship between Primary Production and Standing Stock of Phytoplankton. *Extrait du Journal du Conseil International Pour l'Exploration de la Mer* Vol XXVI. No **1**: 33-48.
- Thomsen, H. A., (ed.). 1992. Plankton i de indre danske farvande. *Havforskning fra Miljøstyrelsen*. Miljøministeriet Miljøstyrelsen. 331 pp.
- Utermöhl, H., 1958. Zur Vervollkommnung der quantitativen Phytoplankton-Methodik. *Ass. intern. Limnol. théor.* **9**: 1-38.
- Wasmund, N., 1997. Occurrence of cyanobacterial blooms in the Baltic Sea in relation to environmental conditions. *Int. Revue ges. Hydrobiol.* **82**: 169-184.

Annex 1

Biovolumes and size-classes of phytoplankton species in the Baltic Sea

See the attached table in PDF format or view the annex in Excel format on:

http://www.helcom.fi/groups/monas/en_GB/biovolumes/

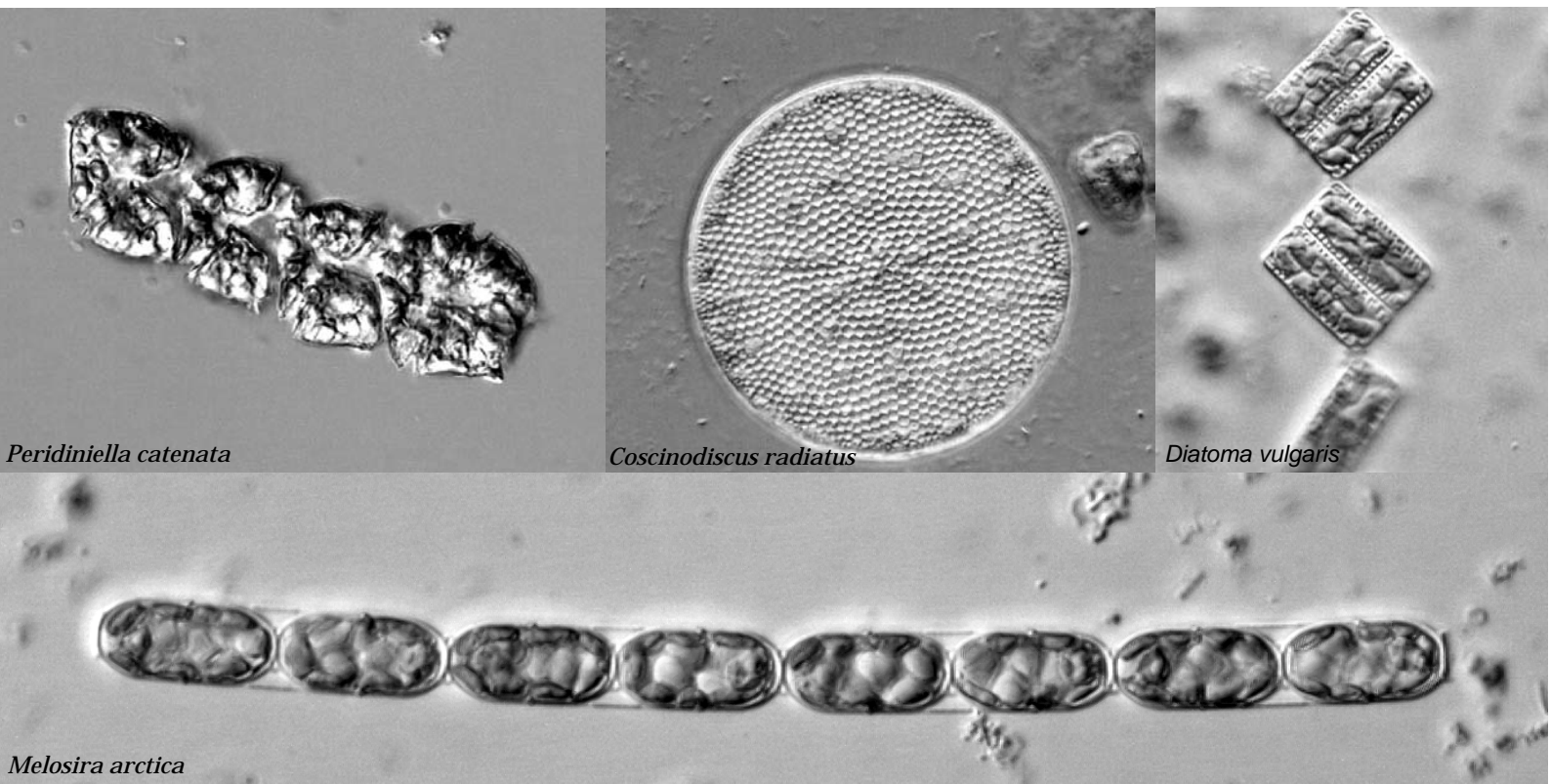

		Trophy	Geometric shape	Size class No	Cell size range, μm	Length, μm		Width μm	Height μm	Diameter, μm		Number of cells/ counting unit	Calculated volume, μm^3	Comment
						l ₁	l ₂	w	h	d ₁	d ₂			
Division CYANOPHYTA (CYANOBACTERIA)														
Class Nostocophyceae (Cyanophyceae)														
Order CHROCOCCALES														
<i>Aphanocapsa conferta</i>	(W. et G.S West) Komarkova-Legnerova et Cronberg 1994	A	sphere	1	cell: 1.5-2.4					1.8		1	3.1	*
<i>Aphanocapsa conferta</i>	(W. et G.S West) Komarkova-Legnerova et Cronberg 1994	A	sphere	2	cell: 1.5-2.4					1.8		20	61	*
<i>Aphanocapsa conferta</i>	(W. et G.S West) Komarkova-Legnerova et Cronberg 1994	A	sphere	3	cell: 1.5-2.4					1.8		50	153	*
<i>Aphanocapsa conferta</i>	(W. et G.S West) Komarkova-Legnerova et Cronberg 1994	A	sphere	4	cell: 1.5-2.4					1.8		100	305	*
<i>Aphanocapsa conferta</i>	(W. et G.S West) Komarkova-Legnerova et Cronberg 1994	A	sphere	5	cell: 1.5-2.4					1.8		200	610	*
<i>Aphanocapsa delicatissima</i>	W. & G.S. West 1912	A	sphere	1	cell: 0.5-1.2					0.9		1	0.3	
<i>Aphanocapsa delicatissima</i>	W. & G.S. West 1912	A	sphere	2	cell: 0.5-1.2					0.9		20	6.4	
<i>Aphanocapsa delicatissima</i>	W. & G.S. West 1912	A	sphere	3	cell: 0.5-1.2					0.9		50	16	
<i>Aphanocapsa delicatissima</i>	W. & G.S. West 1912	A	sphere	4	cell: 0.5-1.2					0.9		100	32	
<i>Aphanocapsa delicatissima</i>	W. & G.S. West 1912	A	sphere	5	cell: 0.5-1.2					0.9		200	64	
<i>Aphanocapsa delicatissima</i>	W. & G.S. West 1912	A	sphere	6	cell: 0.5-1.2					0.9		400	129	
<i>Aphanocapsa delicatissima</i>	W. & G.S. West 1912	A	sphere	7	cell: 0.5-1.2					0.9		600	193	
<i>Aphanocapsa elachista</i>	W. & G.S. West 1894	A	sphere	1	cell: 1.3-2					1.7		1	2.4	
<i>Aphanocapsa elachista</i>	W. & G.S. West 1894	A	sphere	2	cell: 1.3-2					1.7		20	47	
<i>Aphanocapsa elachista</i>	W. & G.S. West 1894	A	sphere	3	cell: 1.3-2					1.7		50	118	
<i>Aphanocapsa elachista</i>	W. & G.S. West 1894	A	sphere	4	cell: 1.3-2					1.7		100	235	
<i>Aphanocapsa elachista</i>	W. & G.S. West 1894	A	sphere	5	cell: 1.3-2					1.7		200	470	
<i>Aphanocapsa holsatica</i>	(Lemmermann) Cronberg & Komárek 1994	A	sphere	1	cell: 1					1		1	0.5	
<i>Aphanocapsa holsatica</i>	(Lemmermann) Cronberg & Komárek 1994	A	sphere	2	cell: 1					1		20	10	

		Trophy	Geometric shape	Size class No	Cell size range, μm	Length, μm		Width μm	Height μm	Diameter, μm		Number of cells/ counting unit	Calculated volume, μm^3	Comment
						l ₁	l ₂	w	h	d ₁	d ₂			
<i>Aphanocapsa holsatica</i>	(Lemmermann) Cronberg & Komárek 1994	A	sphere	3	cell: 1					1		50	26	
<i>Aphanocapsa holsatica</i>	(Lemmermann) Cronberg & Komárek 1994	A	sphere	4	cell: 1					1		100	52	
<i>Aphanocapsa holsatica</i>	(Lemmermann) Cronberg & Komárek 1994	A	sphere	5	cell: 1					1		200	105	
<i>Aphanocapsa incerta</i>	(Lemmermann) Cronberg & Komárek 1994	A	sphere	1	cell: 1					1		1	0.5	
<i>Aphanocapsa incerta</i>	(Lemmermann) Cronberg & Komárek 1994	A	sphere	2	cell: 1					1		20	10	
<i>Aphanocapsa incerta</i>	(Lemmermann) Cronberg & Komárek 1994	A	sphere	3	cell: 1					1		50	26	
<i>Aphanocapsa incerta</i>	(Lemmermann) Cronberg & Komárek 1994	A	sphere	4	cell: 1					1		100	52	
<i>Aphanocapsa incerta</i>	(Lemmermann) Cronberg & Komárek 1994	A	sphere	5	cell: 1					1		200	105	
<i>Aphanocapsa planctonica</i>	(G.M. Smith) Komárek & Anagnostidis 1995	A	sphere	1	cell: 2-3					2.5		1	8.2	
<i>Aphanocapsa planctonica</i>	(G.M. Smith) Komárek & Anagnostidis 1995	A	sphere	2	cell: 2-3					2.5		20	164	
<i>Aphanocapsa planctonica</i>	(G.M. Smith) Komárek & Anagnostidis 1995	A	sphere	3	cell: 2-3					2.5		50	409	
<i>Aphanocapsa planctonica</i>	(G.M. Smith) Komárek & Anagnostidis 1995	A	sphere	4	cell: 2-3					2.5		100	818	
<i>Aphanocapsa planctonica</i>	(G.M. Smith) Komárek & Anagnostidis 1995	A	sphere	5	cell: 2-3					2.5		200	1 635	
<i>Aphanocapsa reinboldii</i>	(P. Richter) Komárek & Anagnostidis 1995	A	sphere	1	cell: 3-4					3.5		1	22	
<i>Aphanocapsa reinboldii</i>	(P. Richter) Komárek & Anagnostidis 1995	A	sphere	2	cell: 3-4					3.5		20	449	
<i>Aphanocapsa reinboldii</i>	(P. Richter) Komárek & Anagnostidis 1995	A	sphere	3	cell: 3-4					3.5		50	1 122	
<i>Aphanocapsa reinboldii</i>	(P. Richter) Komárek & Anagnostidis 1995	A	sphere	4	cell: 3-4					3.5		100	2 244	
<i>Aphanocapsa reinboldii</i>	(P. Richter) Komárek & Anagnostidis 1995	A	sphere	5	cell: 3-4					3.5		200	4 488	
<i>Aphanocapsa rivularis</i>	(Carmichael) Rabenhorst 1865	A	sphere	1	cell: 0.8-4					2.4		1	7.2	
<i>Aphanocapsa rivularis</i>	(Carmichael) Rabenhorst 1865	A	sphere	2	cell: 0.8-4					2.4		20	145	

		Trophy	Geometric shape	Size class No	Cell size range, μm	Length, μm		Width μm	Height μm	Diameter, μm		Number of cells/ counting unit	Calculated volume, μm^3	Comment
						l ₁	l ₂	w	h	d ₁	d ₂			
<i>Aphanocapsa rivularis</i>	(Carmichael) Rabenhorst 1865	A	sphere	3	cell: 0.8-4					2.4		50	362	
<i>Aphanocapsa rivularis</i>	(Carmichael) Rabenhorst 1865	A	sphere	4	cell: 0.8-4					2.4		100	723	
<i>Aphanocapsa rivularis</i>	(Carmichael) Rabenhorst 1865	A	sphere	5	cell: 0.8-4					2.4		200	1 447	
<i>Aphanocapsa spp.</i>		A	sphere	1	cell: 1-2					1.5		1	1.8	
<i>Aphanocapsa spp.</i>		A	sphere	2	cell: 1-2					1.5		20	35	
<i>Aphanocapsa spp.</i>		A	sphere	3	cell: 1-2					1.5		50	88	
<i>Aphanocapsa spp.</i>		A	sphere	4	cell: 1-2					1.5		100	177	
<i>Aphanocapsa spp.</i>		A	sphere	5	cell: 1-2					1.5		200	353	
<i>Aphanocapsa spp.</i>		A	sphere	6	cell: 2-4					3		1	14	
<i>Aphanocapsa spp.</i>		A	sphere	7	cell: 2-4					3		20	283	
<i>Aphanocapsa spp.</i>		A	sphere	8	cell: 2-4					3		50	707	
<i>Aphanocapsa spp.</i>		A	sphere	9	cell: 2-4					3		100	1 413	
<i>Aphanocapsa spp.</i>		A	sphere	10	cell: 2-4					3		200	2 826	
<i>Aphanothece bachmannii</i>	Komárková-Legnerová & Cronberg 1994	A	rotational ellipsoid	1	cell: 0.8-2x0.5-1				1.25	0.9		1	0.5	
<i>Aphanothece bachmannii</i>	Komárková-Legnerová & Cronberg 1994	A	rotational ellipsoid	2	cell: 0.8-2x0.5-1				1.25	0.9		20	11	
<i>Aphanothece bachmannii</i>	Komárková-Legnerová & Cronberg 1994	A	rotational ellipsoid	3	cell: 0.8-2x0.5-1				1.25	0.9		50	26	
<i>Aphanothece bachmannii</i>	Komárková-Legnerová & Cronberg 1994	A	rotational ellipsoid	4	cell: 0.8-2x0.5-1				1.25	0.9		100	53	
<i>Aphanothece bachmannii</i>	Komárková-Legnerová & Cronberg 1994	A	rotational ellipsoid	5	cell: 0.8-2x0.5-1				1.25	0.9		200	106	
<i>Aphanothece castagnei</i>	(Kützing) Rabenhorst 1865	A	rotational ellipsoid	1	cell: 4-8x2-4.8				6	3.9		1	48	
<i>Aphanothece castagnei</i>	(Kützing) Rabenhorst 1865	A	rotational ellipsoid	2	cell: 4-8x2-4.8				6	3.9		20	955	
<i>Aphanothece castagnei</i>	(Kützing) Rabenhorst 1865	A	rotational ellipsoid	3	cell: 4-8x2-4.8				6	3.9		50	2 388	

		Trophy	Geometric shape	Size class No	Cell size range, μm	Length, μm		Width μm	Height μm	Diameter, μm		Number of cells/ counting unit	Calculated volume, μm^3	Comment
						l ₁	l ₂	w	h	d ₁	d ₂			
<i>Aphanothece castagnei</i>	(Kützing) Rabenhorst 1865	A	rotational ellipsoid	4	cell: 4-8x2-4.8				6	3.9		100	4 776	
<i>Aphanothece castagnei</i>	(Kützing) Rabenhorst 1865	A	rotational ellipsoid	5	cell: 4-8x2-4.8				6	3.9		200	9 552	
<i>Aphanothece clathrata</i>	W. & G.S. West 1906	A	rotational ellipsoid	1	cell: 0.8-3.5x0.4-2				2.5	1.2		1	1.9	
<i>Aphanothece clathrata</i>	W. & G.S. West 1906	A	rotational ellipsoid	2	cell: 0.8-3.5x0.4-2				2.5	1.2		20	38	
<i>Aphanothece clathrata</i>	W. & G.S. West 1906	A	rotational ellipsoid	3	cell: 0.8-3.5x0.4-2				2.5	1.2		50	94	
<i>Aphanothece clathrata</i>	W. & G.S. West 1906	A	rotational ellipsoid	4	cell: 0.8-3.5x0.4-2				2.5	1.2		100	188	
<i>Aphanothece clathrata</i>	W. & G.S. West 1906	A	rotational ellipsoid	5	cell: 0.8-3.5x0.4-2				2.5	1.2		200	377	
<i>Aphanothece minutissima</i>	(W. West) Komárková-Legnerová & Cronberg 1994	A	rotational ellipsoid	1	cell: 1-2x0.8-1				1.5	0.9		1	0.6	
<i>Aphanothece minutissima</i>	(W. West) Komárková-Legnerová & Cronberg 1994	A	rotational ellipsoid	2	cell: 1-2x0.8-1				1.5	0.9		20	13	
<i>Aphanothece minutissima</i>	(W. West) Komárková-Legnerová & Cronberg 1994	A	rotational ellipsoid	3	cell: 1-2x0.8-1				1.5	0.9		50	32	
<i>Aphanothece minutissima</i>	(W. West) Komárková-Legnerová & Cronberg 1994	A	rotational ellipsoid	4	cell: 1-2x0.8-1				1.5	0.9		100	64	
<i>Aphanothece minutissima</i>	(W. West) Komárková-Legnerová & Cronberg 1994	A	rotational ellipsoid	5	cell: 1-2x0.8-1				1.5	0.9		200	127	
<i>Aphanothece smithii</i>	Komárková-Legnerová & Cronberg 1994	A	rotational ellipsoid	1	cell: 2-3.5x1-1.5				2.75	1.3		1	2.2	

		Trophy	Geometric shape	Size class No	Cell size range, μm	Length, μm		Width μm	Height μm	Diameter, μm		Number of cells/ counting unit	Calculated volume, μm^3	Comment
						l ₁	l ₂	w	h	d ₁	d ₂			
<i>Aphanothece smithii</i>	Komárková-Legnerová & Cronberg 1994	A	rotational ellipsoid	2	cell: 2-3.5x1-1.5				2.75	1.3		20	45	
<i>Aphanothece smithii</i>	Komárková-Legnerová & Cronberg 1994	A	rotational ellipsoid	3	cell: 2-3.5x1-1.5				2.75	1.3		50	112	
<i>Aphanothece smithii</i>	Komárková-Legnerová & Cronberg 1994	A	rotational ellipsoid	4	cell: 2-3.5x1-1.5				2.75	1.3		100	225	
<i>Aphanothece smithii</i>	Komárková-Legnerová & Cronberg 1994	A	rotational ellipsoid	5	cell: 2-3.5x1-1.5				2.75	1.3		200	450	
<i>Aphanothece stagnina</i>	(Sprengel) A. Braun in Rabenhorst 1865	A	rotational ellipsoid	1	cell: 3.8-9x3-5				6.4	4		1	54	
<i>Aphanothece stagnina</i>	(Sprengel) A. Braun in Rabenhorst 1865	A	rotational ellipsoid	2	cell: 3.8-9x3-5				6.4	4		20	1 072	
<i>Aphanothece stagnina</i>	(Sprengel) A. Braun in Rabenhorst 1865	A	rotational ellipsoid	3	cell: 3.8-9x3-5				6.4	4		50	2 679	
<i>Aphanothece stagnina</i>	(Sprengel) A. Braun in Rabenhorst 1865	A	rotational ellipsoid	4	cell: 3.8-9x3-5				6.4	4		100	5 359	
<i>Aphanothece stagnina</i>	(Sprengel) A. Braun in Rabenhorst 1865	A	rotational ellipsoid	5	cell: 3.8-9x3-5				6.4	4		200	10 718	
<i>Aphanothece parallelliformis</i>	Cronberg 2003	A	cylinder		cell: 1.5-2x0.8-1				1.8	0.9		1	1.1	
<i>Aphanothece spp.</i>		A	rotational ellipsoid	1	cell: 1-2				2	1		1	1.0	
<i>Aphanothece spp.</i>		A	rotational ellipsoid	2	cell: 1-2				2	1		20	21	
<i>Aphanothece spp.</i>		A	rotational ellipsoid	3	cell: 1-2				2	1		50	52	

	Trophy	Geometric shape	Size class No	Cell size range, μm	Length, μm		Width μm	Height μm	Diameter, μm		Number of cells/ counting unit	Calculated volume, μm^3	Comment
					l ₁	l ₂	w	h	d ₁	d ₂			
<i>Aphanothece spp.</i>	A	rotational ellipsoid	4	cell: 1-2				2	1		100	105	
<i>Aphanothece spp.</i>	A	rotational ellipsoid	5	cell: 1-2				2	1		200	209	
<i>Aphanothece spp.</i>	A	rotational ellipsoid	6	cell: 2-4				3	2		1	6.3	
<i>Aphanothece spp.</i>	A	rotational ellipsoid	7	cell: 2-4				3	2		20	126	
<i>Aphanothece spp.</i>	A	rotational ellipsoid	8	cell: 2-4				3	2		50	314	
<i>Aphanothece spp.</i>	A	rotational ellipsoid	9	cell: 2-4				3	2		100	628	
<i>Aphanothece spp.</i>	A	rotational ellipsoid	10	cell: 2-4				3	2		200	1 256	
<i>Chroococcales</i> , unidentified	A	sphere	1	cell: <2					1.5		1	1.8	
<i>Chroococcales</i> , unidentified	A	sphere	2	cell: <2					1.5		20	35	
<i>Chroococcales</i> , unidentified	A	sphere	3	cell: <2					1.5		50	88	
<i>Chroococcales</i> , unidentified	A	sphere	4	cell: <2					1.5		100	177	
<i>Chroococcales</i> , unidentified	A	sphere	5	cell: <2					1.5		200	353	
<i>Chroococcales</i> , unidentified	A	sphere	6	cell: 2-3					2.5		1	8.2	
<i>Chroococcales</i> , unidentified	A	sphere	7	cell: 2-3					2.5		20	164	
<i>Chroococcales</i> , unidentified	A	sphere	8	cell: 2-3					2.5		50	409	
<i>Chroococcales</i> , unidentified	A	sphere	9	cell: 2-3					2.5		100	818	

	Trophy	Geometric shape	Size class No	Cell size range, μm	Length, μm		Width μm	Height μm	Diameter, μm		Number of cells/ counting unit	Calculated volume, μm^3	Comment
					l ₁	l ₂	w	h	d ₁	d ₂			
<i>Chroococcales</i> , unidentified	A	sphere	10	cell: 2-3					2.5		200	1 635	
<i>Chroococcales</i> , unidentified	A	rotational ellipsoid	11	cell: <2				2	1		1	1.0	
<i>Chroococcales</i> , unidentified	A	rotational ellipsoid	12	cell: <2				2	1		20	21	
<i>Chroococcales</i> , unidentified	A	rotational ellipsoid	13	cell: <2				2	1		50	52	
<i>Chroococcales</i> , unidentified	A	rotational ellipsoid	14	cell: <2				2	1		100	105	
<i>Chroococcales</i> , unidentified	A	rotational ellipsoid	15	cell: <2				2	1		200	209	
<i>Chroococcus aphanocapsoides</i>	Skuja 1964	A	sphere	1	cell: 2				2		1	4.2	
<i>Chroococcus aphanocapsoides</i>	Skuja 1964	A	sphere	2	cell: 3				3		1	14	
<i>Chroococcus cumulatus</i>	Bachmann 1921	A	sphere		cell: 5-7				6		1	113	
<i>Chroococcus dispersus</i>	(von Keissler) Lemmermann 1904	A	sphere	1	cell: 3				3		1	14	
<i>Chroococcus dispersus</i>	(von Keissler) Lemmermann 1904	A	sphere	2	cell: 4				4		1	33	
<i>Chroococcus distans</i>	(G.M. Smith) Komárková-Legnerová & Cronberg 1994	A	sphere		cell: 5.5-7.5				6.5		1	144	
<i>Chroococcus limneticus</i>	Lemmermann 1898	A	sphere	1	cell: 6-8				7		1	180	
<i>Chroococcus limneticus</i>	Lemmermann 1898	A	sphere	2	cell: 8-12				10		1	523	
<i>Chroococcus microscopicus</i>	Komárková-Legnerová & Cronberg 1994	A	sphere	1	cell: 0.7-1				0.9		1	0.3	
<i>Chroococcus microscopicus</i>	Komárková-Legnerová & Cronberg 1994	A	sphere	2	cell: 0.7-1				0.9		20	6.4	
<i>Chroococcus microscopicus</i>	Komárková-Legnerová & Cronberg 1994	A	sphere	3	cell: 0.7-1				0.9		50	16	
<i>Chroococcus microscopicus</i>	Komárková-Legnerová & Cronberg 1994	A	sphere	4	cell: 0.7-1				0.9		100	32	
<i>Chroococcus microscopicus</i>	Komárková-Legnerová & Cronberg 1994	A	sphere	5	cell: 0.7-1				0.9		200	64	

		Trophy	Geometric shape	Size class No	Cell size range, μm	Length, μm		Width μm	Height μm	Diameter, μm		Number of cells/ counting unit	Calculated volume, μm^3	Comment
						l ₁	l ₂	w	h	d ₁	d ₂			
<i>Chroococcus minimus</i>	(von Keissler) Lemmermann 1904	A	sphere		cell: 1.7-3					2.5		1	8.2	
<i>Chroococcus minor</i>	(Kützing) Nägeli 1849	A	sphere		cell: 3-4					3.5		1	22	
<i>Chroococcus minutus</i>	(Kützing) Nägeli 1849	A	sphere		cell: 4-10					6		1	113	
<i>Chroococcus turgidus</i>	(Kützing) Nägeli 1849	A	sphere	1	cell: 6-10					8.7		1	345	
<i>Chroococcus turgidus</i>	(Kützing) Nägeli 1849	A	sphere	2	cell: 10-20					15		1	1 766	
<i>Chroococcus turgidus</i>	(Kützing) Nägeli 1849	A	sphere	3	cell: 20-30					25		1	8 177	
<i>Chroococcus spp.</i>		A	sphere	1	cell: <2					1		1	0.5	
<i>Chroococcus spp.</i>		A	sphere	2	cell: 2-4					3		1	14	
<i>Chroococcus spp.</i>		A	sphere	3	cell: 4-6					5		1	65	
<i>Chroococcus spp.</i>		A	sphere	4	cell: 6-8					7		1	180	
<i>Chroococcus spp.</i>		A	sphere	5	cell: 8-10					9		1	382	
<i>Chroococcus spp.</i>		A	sphere	6	cell: 10-20					15		1	1 766	
<i>Chroococcus spp.</i>		A	sphere	7	cell: 20-30					25		1	8 177	
<i>Coelomoron pusillum</i>	(van Goor) Komárek 1989	A	rotational ellipsoid	1	cell: 2x3				3	2		1	6.3	
<i>Coelomoron pusillum</i>	(van Goor) Komárek 1989	A	rotational ellipsoid	2	cell: 2x3				3	2		10	63	
<i>Coelomoron pusillum</i>	(van Goor) Komárek 1989	A	rotational ellipsoid	3	cell: 2x3				3	2		20	126	
<i>Coelomoron spp.</i>		A	rotational ellipsoid	1	cell: 2x3				3	2		1	6.3	
<i>Coelomoron spp.</i>		A	rotational ellipsoid	2	cell: 2x3				3	2		10	63	
<i>Coelomoron spp.</i>		A	rotational ellipsoid	3	cell: 2x3				3	2		20	126	
<i>Coelosphaerium dubium</i>	Grunow in Rabenhorst 1865	A	sphere	1	cell: 5-7					6		1	113	
<i>Coelosphaerium dubium</i>	Grunow in Rabenhorst 1865	A	sphere	2	cell: 5-7					6		20	2 261	
<i>Coelosphaerium dubium</i>	Grunow in Rabenhorst 1865	A	sphere	3	cell: 5-7					6		50	5 652	
<i>Coelosphaerium dubium</i>	Grunow in Rabenhorst 1865	A	sphere	4	cell: 5-7					6		100	11 304	
<i>Coelosphaerium dubium</i>	Grunow in Rabenhorst 1865	A	sphere	5	cell: 5-7					6		200	22 608	
<i>Coelosphaerium kuetzingianum</i>	Nägeli 1849	A	sphere	1	cell: 2-4					3		1	14	

		Trophy	Geometric shape	Size class No	Cell size range, μm	Length, μm		Width μm	Height μm	Diameter, μm		Number of cells/ counting unit	Calculated volume, μm^3	Comment
						l ₁	l ₂	w	h	d ₁	d ₂			
<i>Coelosphaerium kuetzingianum</i>	Nägeli 1849	A	sphere	2	cell: 2-4					3		20	283	
<i>Coelosphaerium kuetzingianum</i>	Nägeli 1849	A	sphere	3	cell: 2-4					3		50	707	
<i>Coelosphaerium kuetzingianum</i>	Nägeli 1849	A	sphere	4	cell: 2-4					3		100	1 413	
<i>Coelosphaerium kuetzingianum</i>	Nägeli 1849	A	sphere	5	cell: 2-4					3		200	2 826	
<i>Coelosphaerium minutissimum</i>	Lemmermann 1900	A	sphere	1	cell: 1.4					1.4		1	1.4	
<i>Coelosphaerium minutissimum</i>	Lemmermann 1900	A	sphere	2	cell: 1.4					1.4		20	29	
<i>Coelosphaerium minutissimum</i>	Lemmermann 1900	A	sphere	3	cell: 1.4					1.4		50	72	
<i>Coelosphaerium minutissimum</i>	Lemmermann 1900	A	sphere	4	cell: 1.4					1.4		100	144	
<i>Coelosphaerium minutissimum</i>	Lemmermann 1900	A	sphere	5	cell: 1.4					1.4		200	287	
<i>Coelosphaerium subarcticum</i>	Komárek & Komárková-Legnerová 1992	A	sphere	1	cell: 1.2-1.6					1.4		1	1.4	
<i>Coelosphaerium subarcticum</i>	Komárek & Komárková-Legnerová 1992	A	sphere	2	cell: 1.2-1.6					1.4		20	29	
<i>Coelosphaerium subarcticum</i>	Komárek & Komárková-Legnerová 1992	A	sphere	3	cell: 1.2-1.6					1.4		50	72	
<i>Coelosphaerium subarcticum</i>	Komárek & Komárková-Legnerová 1992	A	sphere	4	cell: 1.2-1.6					1.4		100	144	
<i>Coelosphaerium subarcticum</i>	Komárek & Komárková-Legnerová 1992	A	sphere	5	cell: 1.2-1.6					1.4		200	287	
<i>Coelosphaerium spp.</i>		A	sphere	1	cell: 1-2					1.5		1	1.8	
<i>Coelosphaerium spp.</i>		A	sphere	2	cell: 1-2					1.5		20	35	
<i>Coelosphaerium spp.</i>		A	sphere	3	cell: 1-2					1.5		50	88	
<i>Coelosphaerium spp.</i>		A	sphere	4	cell: 1-2					1.5		100	177	
<i>Coelosphaerium spp.</i>		A	sphere	5	cell: 1-2					1.5		200	353	
<i>Coelosphaerium spp.</i>		A	sphere	6	cell: 2-4					3		1	14	
<i>Coelosphaerium spp.</i>		A	sphere	7	cell: 2-4					3		20	283	
<i>Coelosphaerium spp.</i>		A	sphere	8	cell: 2-4					3		50	707	
<i>Coelosphaerium spp.</i>		A	sphere	9	cell: 2-4					3		100	1 413	
<i>Coelosphaerium spp.</i>		A	sphere	10	cell: 2-4					3		200	2 826	
<i>Cyanodictyon balticum</i>	Cronberg 2003	A	cylinder	1	cell: 1x1.5				1.2	1		1	0.9	*

		Trophy	Geometric shape	Size class No	Cell size range, μm	Length, μm		Width μm	Height μm	Diameter, μm		Number of cells/ counting unit	Calculated volume, μm^3	Comment
						l ₁	l ₂	w	h	d ₁	d ₂			
<i>Cyanodictyon balticum</i>	Cronberg 2003	A	cylinder	2	cell: 1x1.5				1.2	1		20	19	*
<i>Cyanodictyon balticum</i>	Cronberg 2003	A	cylinder	3	cell: 1x1.5				1.2	1		50	47	*
<i>Cyanodictyon balticum</i>	Cronberg 2003	A	cylinder	4	cell: 1x1.5				1.2	1		100	94	*
<i>Cyanodictyon balticum</i>	Cronberg 2003	A	cylinder	5	cell: 1x1.5				1.2	1		200	188	*
<i>Cyanodictyon imperfectum</i>	Cronberg & Weibull 1981	A	sphere	1	cell: 0.4-1					0.8		1	0.3	
<i>Cyanodictyon imperfectum</i>	Cronberg & Weibull 1981	A	sphere	2	cell: 0.4-1					0.8		20	5.4	
<i>Cyanodictyon imperfectum</i>	Cronberg & Weibull 1981	A	sphere	3	cell: 0.4-1					0.8		50	13	
<i>Cyanodictyon imperfectum</i>	Cronberg & Weibull 1981	A	sphere	4	cell: 0.4-1					0.8		100	27	
<i>Cyanodictyon imperfectum</i>	Cronberg & Weibull 1981	A	sphere	5	cell: 0.4-1					0.8		200	54	
<i>Cyanodictyon imperfectum</i>	Cronberg & Weibull 1981	A	sphere	6	cell: 0.4-1					0.8		400	107	
<i>Cyanodictyon planctonicum</i>	Meyer 1994	A	rotational ellipsoid	1	cell: 0.8-1x1-2				1.5	0.9		1	0.6	
<i>Cyanodictyon planctonicum</i>	Meyer 1994	A	rotational ellipsoid	2	cell: 0.8-1x1-2				1.5	0.9		20	13	
<i>Cyanodictyon planctonicum</i>	Meyer 1994	A	rotational ellipsoid	3	cell: 0.8-1x1-2				1.5	0.9		50	32	
<i>Cyanodictyon planctonicum</i>	Meyer 1994	A	rotational ellipsoid	4	cell: 0.8-1x1-2				1.5	0.9		100	64	
<i>Cyanodictyon planctonicum</i>	Meyer 1994	A	rotational ellipsoid	5	cell: 0.8-1x1-2				1.5	0.9		200	127	
<i>Cyanodictyon reticulatum</i>	(Lemmermann) Geitler 1925	A	sphere	1	cell: 1-1.5					1.3		1	1.0	
<i>Cyanodictyon reticulatum</i>	(Lemmermann) Geitler 1925	A	sphere	2	cell: 1-1.5					1.3		20	20	
<i>Cyanodictyon reticulatum</i>	(Lemmermann) Geitler 1925	A	sphere	3	cell: 1-1.5					1.3		50	51	
<i>Cyanodictyon reticulatum</i>	(Lemmermann) Geitler 1925	A	sphere	4	cell: 1-1.5					1.3		100	102	
<i>Cyanodictyon reticulatum</i>	(Lemmermann) Geitler 1925	A	sphere	5	cell: 1-1.5					1.3		200	204	
<i>Cyanodictyon tubiforme</i>	Cronberg 1988	A	rotational ellipsoid	1	cell: 1.9-2.2x2.2-3.8				3	2		1	6.3	*
<i>Cyanodictyon tubiforme</i>	Cronberg 1988	A	rotational ellipsoid	2	cell: 1.9-2.2x2.2-3.8				3	2		20	126	*
<i>Cyanodictyon tubiforme</i>	Cronberg 1988	A	rotational ellipsoid	3	cell: 1.9-2.2x2.2-3.8				3	2		50	314	*

		Trophy	Geometric shape	Size class No	Cell size range, μm	Length, μm		Width μm	Height μm	Diameter, μm		Number of cells/ counting unit	Calculated volume, μm^3	Comment
						l ₁	l ₂	w	h	d ₁	d ₂			
<i>Cyanodictyon tubiforme</i>	Cronberg 1988	A	rotational ellipsoid	4	cell: 1.9-2.2x2.2-3.8				3	2		100	628	*
<i>Cyanodictyon tubiforme</i>	Cronberg 1988	A	rotational ellipsoid	5	cell: 1.9-2.2x2.2-3.8				3	2		200	1 256	*
<i>Cyanodictyon spp.</i>		A	sphere	1	cell: 1-3					2		1	4.2	
<i>Cyanodictyon spp.</i>		A	sphere	2	cell: 1-3					2		20	84	
<i>Cyanodictyon spp.</i>		A	sphere	3	cell: 1-3					2		50	209	
<i>Cyanodictyon spp.</i>		A	sphere	4	cell: 1-3					2		100	419	
<i>Cyanodictyon spp.</i>		A	sphere	5	cell: 1-3					2		200	837	
<i>Cyanodictyon spp.</i>		A	cylinder	6	cell: 1x1.5				1.2	1.0		1	0.9	
<i>Cyanodictyon spp.</i>		A	cylinder	7	cell: 1x1.5				1.2	1.0		20	19	
<i>Cyanodictyon spp.</i>		A	cylinder	8	cell: 1x1.5				1.2	1.0		50	47	
<i>Cyanodictyon spp.</i>		A	cylinder	9	cell: 1x1.5				1.2	1.0		100	94	
<i>Cyanodictyon spp.</i>		A	cylinder	10	cell: 1x1.5				1.2	1.0		200	188	
<i>Cyanonephron styloides</i>	Hickel 1985	A	rotational ellipsoid	1	cell: 0.8-1.2x2-5.5				3	1		1	1.6	
<i>Cyanonephron styloides</i>	Hickel 1985	A	rotational ellipsoid	2	cell: 0.8-1.2x2-5.5				3	1		20	31	
<i>Cyanonephron styloides</i>	Hickel 1985	A	rotational ellipsoid	3	cell: 0.8-1.2x2-5.5				3	1		50	79	
<i>Cyanonephron styloides</i>	Hickel 1985	A	rotational ellipsoid	4	cell: 0.8-1.2x2-5.5				3	1		100	157	
<i>Cyanonephron styloides</i>	Hickel 1985	A	rotational ellipsoid	5	cell: 0.8-1.2x2-5.5				3	1		200	314	
<i>Cyanonephron spp.</i>		A	rotational ellipsoid	1	cell: 0.8-1.2x2-5.5				3	1		1	1.6	
<i>Cyanonephron spp.</i>		A	rotational ellipsoid	2	cell: 0.8-1.2x2-5.5				3	1		20	31	
<i>Cyanonephron spp.</i>		A	rotational ellipsoid	3	cell: 0.8-1.2x2-5.5				3	1		50	79	

		Trophy	Geometric shape	Size class No	Cell size range, μm	Length, μm		Width μm	Height μm	Diameter, μm		Number of cells/ counting unit	Calculated volume, μm^3	Comment
						l ₁	l ₂	w	h	d ₁	d ₂			
<i>Cyanonephron spp.</i>		A	rotational ellipsoid	4	cell: 0.8-1.2x2-5.5				3	1		100	157	
<i>Cyanonephron spp.</i>		A	rotational ellipsoid	5	cell: 0.8-1.2x2-5.5				3	1		200	314	
<i>Eucapsis alpina</i>	Clements & Shantz 1909	A	sphere		cell: 5-7					6		1	113	
<i>Eucapsis minuta</i>	Fritsch 1912	A	sphere		cell: 2-4					3		1	14	
<i>Eucapsis spp.</i>		A	sphere		cell: 2-4					3		1	14	
<i>Gomphosphaeria aponina</i>	Kützing 1836	A	rotational ellipsoid	1	cell: 8-12x4-6.5				10	5.2		1	142	
<i>Gomphosphaeria aponina</i>	Kützing 1836	A	rotational ellipsoid	2	cell: 8-12x4-6.5				10	5.2		20	2 830	
<i>Gomphosphaeria aponina</i>	Kützing 1836	A	rotational ellipsoid	3	cell: 8-12x4-6.5				10	5.2		50	7 075	
<i>Gomphosphaeria salina</i>	Komárek & Hindák 1988	A	rotational ellipsoid	1	cell: 10.4-15x4-6(10)				12.7	5		1	166	
<i>Gomphosphaeria salina</i>	Komárek & Hindák 1988	A	rotational ellipsoid	2	cell: 10.4-15x4-6(10)				12.7	5		20	3 323	
<i>Gomphosphaeria salina</i>	Komárek & Hindák 1988	A	rotational ellipsoid	3	cell: 10.4-15x4-6(10)				12.7	5		50	8 308	
<i>Gomphosphaeria spp.</i>		A	rotational ellipsoid	1	cell: 3-4x6-8				7	3.5		1	45	
<i>Gomphosphaeria spp.</i>		A	rotational ellipsoid	2	cell: 3-4x6-8				7	3.5		20	898	
<i>Gomphosphaeria spp.</i>		A	rotational ellipsoid	3	cell: 3-4x6-8				7	3.5		50	2 244	
<i>Lemmermanniella pallida</i>	(Lemmermann) Geitler 1942	A	cylinder	1	cell: 0.5-1.6x1.1-3.7				3	1		1	2.4	
<i>Lemmermanniella pallida</i>	(Lemmermann) Geitler 1942	A	cylinder	2	cell: 0.5-1.6x1.1-3.7				3	1		20	47	

	Trophy	Geometric shape	Size class No	Cell size range, μm	Length, μm		Width μm	Height μm	Diameter, μm		Number of cells/ counting unit	Calculated volume, μm^3	Comment	
					l ₁	l ₂	w	h	d ₁	d ₂				
<i>Lemmermanniella pallida</i>	(Lemmermann) Geitler 1942	A	cylinder	3	cell: 0.5-1.6x1.1-3.7				3	1		50	118	
<i>Lemmermanniella pallida</i>	(Lemmermann) Geitler 1942	A	cylinder	4	cell: 0.5-1.6x1.1-3.7				3	1		100	236	
<i>Lemmermanniella pallida</i>	(Lemmermann) Geitler 1942	A	cylinder	5	cell: 0.5-1.6x1.1-3.7				3	1		200	471	
<i>Lemmermanniella parva</i>	Hindák 1985	A	cylinder	1	cell: 0.8-1x1-1.8				1.4	0.9		1	0.9	
<i>Lemmermanniella parva</i>	Hindák 1985	A	cylinder	2	cell: 0.8-1x1-1.8				1.4	0.9		20	18	
<i>Lemmermanniella parva</i>	Hindák 1985	A	cylinder	3	cell: 0.8-1x1-1.8				1.4	0.9		50	45	
<i>Lemmermanniella parva</i>	Hindák 1985	A	cylinder	4	cell: 0.8-1x1-1.8				1.4	0.9		100	89	
<i>Lemmermanniella parva</i>	Hindák 1985	A	cylinder	5	cell: 0.8-1x1-1.8				1.4	0.9		200	178	
<i>Lemmermanniella spp.</i>		A	cylinder	1	cell: 0.5-3				2	1		1	1.6	
<i>Lemmermanniella spp.</i>		A	cylinder	2	cell: 0.5-3				2	1		20	31	
<i>Lemmermanniella spp.</i>		A	cylinder	3	cell: 0.5-3				2	1		50	79	
<i>Lemmermanniella spp.</i>		A	cylinder	4	cell: 0.5-3				2	1		100	157	
<i>Lemmermanniella spp.</i>		A	cylinder	5	cell: 0.5-3				2	1		200	314	
<i>Merismopedia elegans</i>	A. Braun in Kützing 1849	A	rotational ellipsoid	1	cell: 5-9x5-7				7	6		1	132	
<i>Merismopedia elegans</i>	A. Braun in Kützing 1849	A	rotational ellipsoid	2	cell: 5-9x5-7				7	6		4	528	
<i>Merismopedia glauca</i>	(Ehrenberg) Kützing 1845	A	sphere	1	cell: 3-6					5		1	65	
<i>Merismopedia glauca</i>	(Ehrenberg) Kützing 1845	A	sphere	2	cell: 3-6					5		4	262	
<i>Merismopedia punctata</i>	Meyen 1839	A	sphere	1	cell: 2.5-3.6					3		1	14	
<i>Merismopedia punctata</i>	Meyen 1839	A	sphere	2	cell: 2.5-3.6					3		4	57	
<i>Merismopedia punctata</i>	Meyen 1839	A	sphere	3	cell: 2.5-3.6					3		16	226	
<i>Merismopedia tenuissima</i>	Lemmermann 1898	A	sphere	1	cell: 0.4-2.5					1.5		1	1.8	
<i>Merismopedia tenuissima</i>	Lemmermann 1898	A	sphere	2	cell: 0.4-2.5					1.5		16	28	
<i>Merismopedia tenuissima</i>	Lemmermann 1898	A	sphere	3	cell: 0.4-2.5					1.5		32	57	
<i>Merismopedia tenuissima</i>	Lemmermann 1898	A	sphere	4	cell: 0.4-2.5					1.5		64	113	
<i>Merismopedia tenuissima</i>	Lemmermann 1898	A	sphere	5	cell: 0.4-2.5					1.5		96	170	
<i>Merismopedia warmingiana</i>	(Lagerheim) Geitler 1932	A	sphere	1	cell: 0.5-1.2					0.8		1	0.3	
<i>Merismopedia warmingiana</i>	(Lagerheim) Geitler 1932	A	sphere	2	cell: 0.5-1.2					0.8		4	1.1	
<i>Merismopedia warmingiana</i>	(Lagerheim) Geitler 1932	A	sphere	3	cell: 0.5-1.2					0.8		8	2.1	

		Trophy	Geometric shape	Size class No	Cell size range, μm	Length, μm		Width μm	Height μm	Diameter, μm		Number of cells/ counting unit	Calculated volume, μm^3	Comment
						l ₁	l ₂	w	h	d ₁	d ₂			
<i>Merismopedia warmingiana</i>	(Lagerheim) Geitler 1932	A	sphere	4	cell: 0.5-1.2					0.8		16	4.3	
<i>Merismopedia warmingiana</i>	(Lagerheim) Geitler 1932	A	sphere	5	cell: 0.5-1.2					0.8		32	8.6	
<i>Merismopedia warmingiana</i>	(Lagerheim) Geitler 1932	A	sphere	6	cell: 0.5-1.2					0.8		64	17	
<i>Merismopedia spp.</i>		A	sphere	1	cell: <0.5					0.5		1	0.1	
<i>Merismopedia spp.</i>		A	sphere	2	cell: <0.5					0.5		4	0.3	
<i>Merismopedia spp.</i>		A	sphere	3	cell: <0.5					0.5		8	0.5	
<i>Merismopedia spp.</i>		A	sphere	4	cell: <0.5					0.5		16	1.0	
<i>Merismopedia spp.</i>		A	sphere	5	cell: <0.5					0.5		32	2.1	
<i>Merismopedia spp.</i>		A	sphere	6	cell: <0.5					0.5		64	4.2	
<i>Merismopedia spp.</i>		A	sphere	7	cell: 0.5-3					1.8		1	2.8	
<i>Merismopedia spp.</i>		A	sphere	8	cell: 0.5-3					1.8		4	11	
<i>Merismopedia spp.</i>		A	sphere	9	cell: 0.5-3					1.8		8	22	
<i>Merismopedia spp.</i>		A	sphere	10	cell: 0.5-3					1.8		16	45	
<i>Merismopedia spp.</i>		A	sphere	11	cell: 0.5-3					1.8		32	90	
<i>Merismopedia spp.</i>		A	sphere	12	cell: 0.5-3					1.8		64	180	
<i>Microcystis aeruginosa</i>	(Kützing) Kützing 1846	A	sphere	1	cell: 4-6					5		1	65	
<i>Microcystis aeruginosa</i>	(Kützing) Kützing 1846	A	sphere	2	cell: 4-6					5		20	1 308	
<i>Microcystis aeruginosa</i>	(Kützing) Kützing 1846	A	sphere	3	cell: 4-6					5		50	3 271	
<i>Microcystis aeruginosa</i>	(Kützing) Kützing 1846	A	sphere	4	cell: 4-6					5		100	6 542	
<i>Microcystis flos-aquae</i>	(Wittrock in Wittrock & Nordstedt) Kirchner 1900	A	sphere	1	cell: 3.5-4.8					4		1	33	
<i>Microcystis flos-aquae</i>	(Wittrock in Wittrock & Nordstedt) Kirchner 1900	A	sphere	2	cell: 3.5-4.8					4		20	670	
<i>Microcystis flos-aquae</i>	(Wittrock in Wittrock & Nordstedt) Kirchner 1900	A	sphere	3	cell: 3.5-4.8					4		50	1 675	
<i>Microcystis flos-aquae</i>	(Wittrock in Wittrock & Nordstedt) Kirchner 1900	A	sphere	4	cell: 3.5-4.8					4		100	3 349	
<i>Microcystis ichtyoblabe</i>	Kützing 1843	A	sphere	1	cell: 2-3.2					2.6		1	9.2	
<i>Microcystis ichtyoblabe</i>	Kützing 1843	A	sphere	2	cell: 2-3.2					2.6		20	184	
<i>Microcystis ichtyoblabe</i>	Kützing 1843	A	sphere	3	cell: 2-3.2					2.6		50	460	
<i>Microcystis ichtyoblabe</i>	Kützing 1843	A	sphere	4	cell: 2-3.2					2.6		100	920	
<i>Microcystis novacekii</i>	(Komárek) Compère 1974	A	sphere	1	cell: 3-5.5					4.2		1	39	
<i>Microcystis novacekii</i>	(Komárek) Compère 1974	A	sphere	2	cell: 3-5.5					4.2		20	775	
<i>Microcystis novacekii</i>	(Komárek) Compère 1974	A	sphere	3	cell: 3-5.5					4.2		50	1 939	
<i>Microcystis novacekii</i>	(Komárek) Compère 1974	A	sphere	4	cell: 3-5.5					4.2		100	3 877	

		Trophy	Geometric shape	Size class No	Cell size range, μm	Length, μm		Width μm	Height μm	Diameter, μm		Number of cells/ counting unit	Calculated volume, μm^3	Comment
						l ₁	l ₂	w	h	d ₁	d ₂			
<i>Microcystis viridis</i>	(A. Braun <i>in</i> Rabenhorst) Lemmermann 1902	A	sphere	1	cell: 3.5-7					5		1	65	
<i>Microcystis viridis</i>	(A. Braun <i>in</i> Rabenhorst) Lemmermann 1902	A	sphere	2	cell: 3.5-7					5		4	262	
<i>Microcystis viridis</i>	(A. Braun <i>in</i> Rabenhorst) Lemmermann 1902	A	sphere	3	cell: 3.5-7					5		20	1 308	
<i>Microcystis viridis</i>	(A. Braun <i>in</i> Rabenhorst) Lemmermann 1902	A	sphere	4	cell: 3.5-7					5		50	3 271	
<i>Microcystis viridis</i>	(A. Braun <i>in</i> Rabenhorst) Lemmermann 1902	A	sphere	5	cell: 3.5-7					5		100	6 542	
<i>Microcystis wesenbergii</i>	(Komárek) Komárek <i>in</i> Kondrat'eva 1968	A	sphere	1	cell: 4-7					5		1	65	
<i>Microcystis wesenbergii</i>	(Komárek) Komárek <i>in</i> Kondrat'eva 1968	A	sphere	2	cell: 4-7					5		20	1 308	
<i>Microcystis wesenbergii</i>	(Komárek) Komárek <i>in</i> Kondrat'eva 1968	A	sphere	3	cell: 4-7					5		50	3 271	
<i>Microcystis wesenbergii</i>	(Komárek) Komárek <i>in</i> Kondrat'eva 1968	A	sphere	4	cell: 4-7					5		100	6 542	
<i>Microcystis spp.</i>		A	sphere	1	cell: 1-3					2		1	4.2	
<i>Microcystis spp.</i>		A	sphere	2	cell: 1-3					2		20	84	
<i>Microcystis spp.</i>		A	sphere	3	cell: 1-3					2		50	209	
<i>Microcystis spp.</i>		A	sphere	4	cell: 1-3					2		100	419	
<i>Microcystis spp.</i>		A	sphere	5	cell: 3-7					5		1	65	
<i>Microcystis spp.</i>		A	sphere	6	cell: 3-7					5		20	1 308	
<i>Microcystis spp.</i>		A	sphere	7	cell: 3-7					5		50	3 271	
<i>Microcystis spp.</i>		A	sphere	8	cell: 3-7					5		100	6 542	
<i>Pannus spumososus</i>	Hickel 1991	A	sphere	1	cell: 1-1.5					1.3		1	1.0	
<i>Pannus spumososus</i>	Hickel 1991	A	sphere	2	cell: 1-1.5					1.3		20	20	
<i>Pannus spumososus</i>	Hickel 1991	A	sphere	3	cell: 1-1.5					1.3		50	51	
<i>Pannus spp.</i>		A	sphere		cell: 1-1.5					1.3		1	1.0	
<i>Pannus spp.</i>		A	sphere		cell: 1-1.5					1.3		20	20	
<i>Pannus spp.</i>		A	sphere		cell: 1-1.5					1.3		50	51	
<i>Radiocystis geminata</i>	Skuja 1948	A	rotational ellipsoid	1	cell: 3x4				4	3		1	19	
<i>Radiocystis geminata</i>	Skuja 1948	A	rotational ellipsoid	2	cell: 3x4				4	3		10	188	

		Trophy	Geometric shape	Size class No	Cell size range, μm	Length, μm		Width μm	Height μm	Diameter, μm		Number of cells/ counting unit	Calculated volume, μm^3	Comment
						l ₁	l ₂	w	h	d ₁	d ₂			
<i>Radiocystis geminata</i>	Skuja 1948	A	rotational ellipsoid	3	cell: 3x4				4	3		20	377	
<i>Radiocystis geminata</i>	Skuja 1948	A	rotational ellipsoid	4	cell: 3x4				4	3		50	942	
<i>Rhabdoderma lineare</i>	Schmidle & Lauterborn 1900	A	cylinder	1	cell: 4-10x1.5-3				7	2.8		1	43	
<i>Rhabdoderma lineare</i>	Schmidle & Lauterborn 1900	A	cylinder	2	cell: 4-10x1.5-3				7	2.8		20	862	
<i>Rhabdoderma spp.</i>		A	cylinder	1	cell: 4-10x1.5-3				8	1.6		1	16	
<i>Rhabdoderma spp.</i>		A	cylinder	2	cell: 4-10x1.5-3				8	1.6		20	322	
<i>Snowella atomus</i>	Komárek & Hindák 1988	A	sphere	1	cell: 0.6-1.4					1		1	0.5	
<i>Snowella atomus</i>	Komárek & Hindák 1988	A	sphere	2	cell: 0.6-1.4					1		10	5.2	
<i>Snowella atomus</i>	Komárek & Hindák 1988	A	sphere	3	cell: 0.6-1.4					1		20	10	
<i>Snowella atomus</i>	Komárek & Hindák 1988	A	sphere	4	cell: 0.6-1.4					1		50	26	
<i>Snowella fennica</i>	Komárek & Komárková-Legnerová 1992	A	rotational ellipsoid	1	cell: 2.8-4.2x1.2-2.8				3	2		1	6.3	
<i>Snowella fennica</i>	Komárek & Komárková-Legnerová 1992	A	rotational ellipsoid	2	cell: 2.8-4.2x1.2-2.8				3	2		10	63	
<i>Snowella fennica</i>	Komárek & Komárková-Legnerová 1992	A	rotational ellipsoid	3	cell: 2.8-4.2x1.2-2.8				3	2		20	126	
<i>Snowella fennica</i>	Komárek & Komárková-Legnerová 1992	A	rotational ellipsoid	4	cell: 2.8-4.2x1.2-2.8				3	2		50	314	
<i>Snowella lacustris</i>	(R. Chodat) Komárek & Hindák 1988	A	rotational ellipsoid	1	cell: 2-4x1.5-3.5				3	2.5		1	10	
<i>Snowella lacustris</i>	(R. Chodat) Komárek & Hindák 1988	A	rotational ellipsoid	2	cell: 2-4x1.5-3.5				3	2.5		10	98	
<i>Snowella lacustris</i>	(R. Chodat) Komárek & Hindák 1988	A	rotational ellipsoid	3	cell: 2-4x1.5-3.5				3	2.5		20	196	
<i>Snowella lacustris</i>	(R. Chodat) Komárek & Hindák 1988	A	rotational ellipsoid	4	cell: 2-4x1.5-3.5				3	2.5		50	491	
<i>Snowella litoralis</i>	(Häyrén) Komárek & Hindák 1988	A	sphere	1	cell: 2.4-4					3.2		1	17	

		Trophy	Geometric shape	Size class No	Cell size range, μm	Length, μm		Width μm	Height μm	Diameter, μm		Number of cells/ counting unit	Calculated volume, μm^3	Comment
						l ₁	l ₂	w	h	d ₁	d ₂			
<i>Snowella litoralis</i>	(Häyrén) Komárek & Hindák 1988	A	sphere	2	cell: 2.4-4					3.2		10	171	
<i>Snowella litoralis</i>	(Häyrén) Komárek & Hindák 1988	A	sphere	3	cell: 2.4-4					3.2		20	343	
<i>Snowella litoralis</i>	(Häyrén) Komárek & Hindák 1988	A	sphere	4	cell: 2.4-4					3.2		50	857	
<i>Snowella septentrionalis</i>	Komárek & Hindák 1988	A	sphere	1	cell: 1.2-3.4					2.3		1	6.4	
<i>Snowella septentrionalis</i>	Komárek & Hindák 1988	A	sphere	2	cell: 1.2-3.4					2.3		10	64	
<i>Snowella septentrionalis</i>	Komárek & Hindák 1988	A	sphere	3	cell: 1.2-3.4					2.3		20	127	
<i>Snowella septentrionalis</i>	Komárek & Hindák 1988	A	sphere	4	cell: 1.2-3.4					2.3		50	318	
<i>Snowella spp.</i>		A	sphere	1	cell: 1-4					2.5		1	8.2	
<i>Snowella spp.</i>		A	sphere	2	cell: 1-4					2.5		10	82	
<i>Snowella spp.</i>		A	sphere	3	cell: 1-4					2.5		20	164	
<i>Snowella spp.</i>		A	sphere	4	cell: 1-4					2.5		50	409	
<i>Synechococcus sp.</i>		A	sphere	3	cell: 2					2		1	4.2	
<i>Synechococcus sp.</i>		A	sphere	4	cell: 2					2		10	42	
<i>Synechococcus sp.</i>		A	sphere	5	cell: 3					3		1	14	
<i>Synechococcus sp.</i>		A	sphere	6	cell: 3					3		10	141	
<i>Woronichinia compacta</i>	(Lemmermann) Komárek & Hindák 1988	A	rotational ellipsoid	1	cell: 3-5.6x1.5-3.4				4.5	2.5		1	15	
<i>Woronichinia compacta</i>	(Lemmermann) Komárek & Hindák 1988	A	rotational ellipsoid	2	cell: 3-5.6x1.5-3.4				4.5	2.5		10	147	
<i>Woronichinia compacta</i>	(Lemmermann) Komárek & Hindák 1988	A	rotational ellipsoid	3	cell: 3-5.6x1.5-3.4				4.5	2.5		20	294	
<i>Woronichinia compacta</i>	(Lemmermann) Komárek & Hindák 1988	A	rotational ellipsoid	4	cell: 3-5.6x1.5-3.4				4.5	2.5		50	736	
<i>Woronichinia elorantae</i>	Komárek & Komárková-Legnerová 1992	A	rotational ellipsoid	1	cell: 2.5-3x1.6-2				2.8	1.8		1	4.7	
<i>Woronichinia elorantae</i>	Komárek & Komárková-Legnerová 1992	A	rotational ellipsoid	2	cell: 2.5-3x1.6-2				2.8	1.8		10	47	
<i>Woronichinia elorantae</i>	Komárek & Komárková-Legnerová 1992	A	rotational ellipsoid	3	cell: 2.5-3x1.6-2				2.8	1.8		20	95	

		Trophy	Geometric shape	Size class No	Cell size range, μm	Length, μm		Width μm	Height μm	Diameter, μm		Number of cells/ counting unit	Calculated volume, μm^3	Comment
						l ₁	l ₂	w	h	d ₁	d ₂			
<i>Woronichinia elorantae</i>	Komárek & Komárková-Legnerová 1992	A	rotational ellipsoid	4	cell: 2.5-3x1.6-2				2.8	1.8		50	237	
<i>Woronichinia fusca</i>	(Skuja) Komárek & Hindák 1988	A	rotational ellipsoid	1	cell: 3-5x2.5-4				4	3.3		1	22	
<i>Woronichinia fusca</i>	(Skuja) Komárek & Hindák 1988	A	rotational ellipsoid	2	cell: 3-5x2.5-4				4	3.3		10	221	
<i>Woronichinia fusca</i>	(Skuja) Komárek & Hindák 1988	A	rotational ellipsoid	3	cell: 3-5x2.5-4				4	3.3		20	442	
<i>Woronichinia fusca</i>	(Skuja) Komárek & Hindák 1988	A	rotational ellipsoid	4	cell: 3-5x2.5-4				4	3.3		50	1 106	
<i>Woronichinia karelica</i>	Komárek & Komárková-Legnerová 1992	A	rotational ellipsoid	1	cell: 3-4.2x1.5-2				3.6	1.8		1	6.1	
<i>Woronichinia karelica</i>	Komárek & Komárková-Legnerová 1992	A	rotational ellipsoid	2	cell: 3-4.2x1.5-2				3.6	1.8		10	61	
<i>Woronichinia karelica</i>	Komárek & Komárková-Legnerová 1992	A	rotational ellipsoid	3	cell: 3-4.2x1.5-2				3.6	1.8		20	122	
<i>Woronichinia karelica</i>	Komárek & Komárková-Legnerová 1992	A	rotational ellipsoid	4	cell: 3-4.2x1.5-2				3.6	1.8		50	305	
<i>Woronichinia naegeliana</i>	(Unger) Elenkin 1933	A	rotational ellipsoid	1	cell: 4.5-6x1.5-5				5	3		1	24	
<i>Woronichinia naegeliana</i>	(Unger) Elenkin 1933	A	rotational ellipsoid	2	cell: 4.5-6x1.5-5				5	3		10	236	
<i>Woronichinia naegeliana</i>	(Unger) Elenkin 1933	A	rotational ellipsoid	3	cell: 4.5-6x1.5-5				5	3		20	471	
<i>Woronichinia naegeliana</i>	(Unger) Elenkin 1933	A	rotational ellipsoid	4	cell: 4.5-6x1.5-5				5	3		50	1 178	

	Trophy	Geometric shape	Size class No	Cell size range, µm	Length, µm		Width µm	Height µm	Diameter, µm		Number of cells/ counting unit	Calculated volume, µm ³	Comment
					l ₁	l ₂	w	h	d ₁	d ₂			
<i>Woronichinia</i> spp.	A	rotational ellipsoid	1	cell: 2-5				3	2		1	6.3	
<i>Woronichinia</i> spp.	A	rotational ellipsoid	2	cell: 2-5				3	2		10	63	
<i>Woronichinia</i> spp.	A	rotational ellipsoid	3	cell: 2-5				3	2		20	126	
<i>Woronichinia</i> spp.	A	rotational ellipsoid	4	cell: 2-5				3	2		50	314	
Order OSCILLATORIALES													
<i>Limnothrix planctonica</i>	(Woloszynska) Meffert 1988	A	cylinder	1	fil.: 2x100			100	2		1	314	
<i>Limnothrix planctonica</i>	(Woloszynska) Meffert 1988	A	cylinder	2	fil.: 2.5x100			100	2.5		1	491	
<i>Limnothrix planctonica</i>	(Woloszynska) Meffert 1988	A	cylinder	3	fil.: 3x100			100	3		1	707	
<i>Limnothrix redekei</i>	(Van Goor) Meffert 1988	A	cylinder	1	fil.: 2x100			100	2		1	314	
<i>Limnothrix redekei</i>	(Van Goor) Meffert 1988	A	cylinder	2	fil.: 3x100			100	3		1	707	
<i>Limnothrix</i> spp.		A	cylinder	1	fil.: 1.5x100			100	1.5		1	177	
<i>Limnothrix</i> spp.		A	cylinder	2	fil.: 2x100			100	2		1	314	
<i>Limnothrix</i> spp.		A	cylinder	3	fil.: 2.5x100			100	2.5		1	491	
<i>Limnothrix</i> spp.		A	cylinder	4	fil.: 3x100			100	3		1	707	
<i>Lyngbya aestuarii</i>	(Mertens in Jürgens) Liebman ex Gomont 1892	A	cylinder		fil.: 8x100			100	8		1	5 024	
<i>Oscillatoria chlorina</i>	Kützing ex Gomont 1892	A	cylinder		fil.: 4x100			100	4		1	1 256	
<i>Oscillatoria limosa</i>	C.A. Agardh ex Gomont 1892	A	cylinder		fil.: 10x100			100	10		1	7 850	
<i>Oscillatoria limosa</i>	C.A. Agardh ex Gomont 1892	A	cylinder		fil.: 12x100			100	12		1	11 304	
<i>Oscillatoriales</i> , unidentified		A	cylinder	1	fil.: 1x100			100	1		1	79	
<i>Oscillatoriales</i> , unidentified		A	cylinder	2	fil.: 1.5x100			100	1.5		1	177	
<i>Oscillatoriales</i> , unidentified		A	cylinder	3	fil.: 2x100			100	2		1	314	
<i>Oscillatoriales</i> , unidentified		A	cylinder	4	fil.: 2.5x100			100	2.5		1	491	
<i>Oscillatoriales</i> , unidentified		A	cylinder	5	fil.: 3x100			100	3		1	707	
<i>Oscillatoriales</i> , unidentified		A	cylinder	6	fil.: 5x100			100	5		1	1 963	
<i>Oscillatoriales</i> , unidentified		A	cylinder	7	fil.: 7x100			100	7		1	3 847	
<i>Phormidium amphibium</i>	(C.A. Agardh ex Gomont) Anagnostidis & Komárek 1988	A	cylinder		fil.: 3.5x100			100	3.5		1	962	
<i>Phormidium</i> spp.		A	cylinder	1	fil.: 1.5x100			100	1.5		1	177	
<i>Phormidium</i> spp.		A	cylinder	2	fil.: 3x100			100	3		1	707	

	Trophy	Geometric shape	Size class No	Cell size range, μm	Length, μm		Width μm	Height μm	Diameter, μm		Number of cells/ counting unit	Calculated volume, μm^3	Comment
					l ₁	l ₂	w	h	d ₁	d ₂			
<i>Phormidium</i> spp.	A	cylinder	3	fil.: 4x100				100	4		1	1 256	
<i>Phormidium</i> spp.	A	cylinder	4	fil.: 6x100				100	6		1	2 826	
<i>Phormidium</i> spp.	A	cylinder	5	fil.: 7x100				100	7		1	3 847	
<i>Phormidium</i> spp.	A	cylinder	6	fil.: 10x100				100	10		1	7 850	
<i>Planktolyngbya contorta</i>	(Lemmermann) Anagnostidis & Komárek 1988	A	cylinder	fil.: 1.5x100				100	1.5		1	177	
<i>Planktolyngbya lacustris</i>	(Lemmermann) Anagnostidis & Komárek 1988	A	cylinder	fil.: 1.5x100				100	1.5		1	177	
<i>Planktolyngbya limnetica</i>	(Lemmermann) Komárková-Legnerová & Cronberg 1992	A	cylinder	1	fil.: 1x100			100	1		1	79	
<i>Planktolyngbya limnetica</i>	(Lemmermann) Komárková-Legnerová & Cronberg 1992	A	cylinder	2	fil.: 2x100			100	2		1	314	
<i>Planktolyngbya</i> spp.		A	cylinder	1	fil.: 1.5x100			100	1.5		1	177	
<i>Planktolyngbya</i> spp.		A	cylinder	2	fil.: 2x100			100	2		1	314	
<i>Planktolyngbya</i> spp.		A	cylinder	3	fil.: 2.5x100			100	2.5		1	491	
<i>Planktothrix agardhii</i>	(Gomont) Anagnostidis & Komárek 1988	A	cylinder	1	fil.: 3.5x100			100	3.5		1	962	
<i>Planktothrix agardhii</i>	(Gomont) Anagnostidis & Komárek 1988	A	cylinder	2	fil.: 5x100			100	5		1	1 963	
<i>Planktothrix mougeotii</i>	(Bory ex Gomont) Anagnostidis & Komárek 1988	A	cylinder		fil.: 5x100			100	5		1	1 963	
<i>Planktothrix</i> spp.		A	cylinder	1	fil.: 4x100			100	4		1	1 256	
<i>Planktothrix</i> spp.		A	cylinder	2	fil.: 6x100			100	6		1	2 826	
<i>Planktothrix</i> spp.		A	cylinder	3	fil.: 8x100			100	8		1	5 024	
<i>Prochlorotrix</i> spp.		A	cylinder		fil.: 1.5x100			100	1.5		1	177	*
<i>Pseudanabaena acicularis</i>	(Nygaard) Anagnostidis et Komarek 1988	A	cylinder		fil.: 1.5x100			100	1.5		1	177	*
<i>Pseudanabaena limnetica</i>	(Lemmermann) Komárek 1974	A	cylinder	1	fil.: 1x100			100	1		1	79	
<i>Pseudanabaena limnetica</i>	(Lemmermann) Komárek 1974	A	cylinder	2	fil.: 1.5x100			100	1.5		1	177	
<i>Pseudanabaena mucicola</i>	(Naumann & Huber-Pestalozzi) Bourrelly 1970	A	cylinder		fil.: 2x100			100	2		1	314	
<i>Pseudanabaena</i> spp.		A	cylinder	1	fil.: 0.5x100			100	0.5		1	20	
<i>Pseudanabaena</i> spp.		A	cylinder	2	fil.: 1.5x100			100	1.5		1	177	
<i>Pseudanabaena</i> spp.		A	cylinder	3	fil.: 2x100			100	2		1	314	
<i>Romeria</i> spp.		A	cylinder	1	fil.: 0.5x100			100	0.5		1	20	
<i>Romeria</i> spp.		A	cylinder	2	fil.: 1x100			100	1		1	79	

	Trophy	Geometric shape	Size class No	Cell size range, μm	Length, μm		Width μm	Height μm	Diameter, μm		Number of cells/ counting unit	Calculated volume, μm^3	Comment
					l ₁	l ₂	w	h	d ₁	d ₂			
<i>Spirulina major</i>	Kützing ex Gomont 1892	A	cylinder		fil.: 1.5x100			100	1.5		1	177	
<i>Spirulina subsalsa</i>	Ørsted ex Gomont 1892	A	cylinder		fil.: 1.5x100			100	1.5		1	177	
<i>Spirulina spp.</i>		A	cylinder	1	fil.: 1.5x100			100	1.5		1	177	
<i>Spirulina spp.</i>		A	cylinder	2	fil.: 2x100			100	2		1	314	
<i>Tychonema tenue</i>	(Skuja) Anagnostidis & Komárek 1988	A	cylinder		fil.: 4-5x100			100	4.5		1	1 590	
<i>Achroonema lentum</i>	Skuja 1956	H	cylinder		fil.: 2x100			100	2		1	314	
<i>Achroonema proteiforme</i>	Skuja 1956	H	cylinder	1	fil.: 1-2x100			100	1.5		1	177	
Order NOSTOCALES													
<i>Anabaena affinis</i>	Lemmermann 1897	A	chain of spheres		fil.: 8x100	100			8.5		1	3 781	1
<i>Anabaena baltica</i>	J. Schmidt 1899	A	chain of spheres	1	fil.: 3x100	100			3		1	471	1
<i>Anabaena baltica</i>	J. Schmidt 1899	A	chain of spheres	2	fil.: 6x100	100			5.8		1	1 760	1
<i>Anabaena circinalis</i>	Rabenhorst ex Bornet & Flahault 1886	A	chain of spheres		fil.: 11x100	100			11		1	6 332	1
<i>Anabaena crassa</i>	(Lemmermann) Komárková & Cronberg 1992	A	chain of spheres		fil.: 11x100	100			11		1	6 332	1
<i>Anabaena cylindrica</i>	Lemmermann 1896	A	cylinder	1	fil.: 3-4x100			100	3.5		1	962	
<i>Anabaena cylindrica</i>	Lemmermann 1896	A	cylinder	2	fil.: 4-5x100			100	4.5		1	1 590	
<i>Anabaena flos-aquae</i>	(Lyngbye) Brébisson in Brébisson & Godey ex Bornet & Flahault 1886	A	chain of spheres	1	fil.: 4x100	100			4		1	837	1
<i>Anabaena flos-aquae</i>	(Lyngbye) Brébisson in Brébisson & Godey ex Bornet & Flahault 1886	A	chain of spheres	2	fil.: 5x100	100			5		1	1 308	1
<i>Anabaena inaequalis</i>	Kützing ex Bornet & Flahault 1886	A	chain of spheres	1	fil.: 4x100	100			4		1	837	1
<i>Anabaena inaequalis</i>	Kützing ex Bornet & Flahault 1886	A	chain of spheres	2	fil.: 5x100	100			5		1	1 308	1
<i>Anabaena lemmermannii</i>	P. Richter in Lemmermann 1903	A	chain of spheres		fil.: 5x100	100			5		1	1 308	1
<i>Anabaena macrospora</i>	Klebahn 1895	A	chain of spheres		fil.: 6-7x100	100			6.5		1	2 211	1
<i>Anabaena oscillarioides</i>	Bory ex Bornet & Flahault 1886	A	chain of spheres		fil.: 5x100	100			5		1	1 308	1
<i>Anabaena planctonica</i>	Brunnthaler 1903	A	chain of spheres	1	fil.: 10x100	100			10		1	5 233	1

		Trophy	Geometric shape	Size class No	Cell size range, μm	Length, μm		Width μm	Height μm	Diameter, μm		Number of cells/ counting unit	Calculated volume, μm^3	Comment
						l ₁	l ₂	w	h	d ₁	d ₂			
<i>Anabaena planctonica</i>	Brunnthaler 1903	A	chain of spheres	2	fil.: 12x100	100				12		1	7 536	1
<i>Anabaena smithii</i>	(Komárek) M. Watanabe 1991	A	chain of spheres			100				9		1	4 239	1
<i>Anabaena spiroides</i>	Klebahn 1895	A	chain of spheres		fil.: 5x100	100				5		1	1 308	1
<i>Anabaena torulosa</i>	(Carmichael ex Harvey in Hooker) Lagerheim ex Bornet & Flahault 1886	A	chain of spheres		fil.: 4-5x100	100				4.6		1	1 107	1
<i>Anabaena spp.</i>		A	chain of spheres	1	fil.: 4-5x100	100				4.5		1	1 060	1
<i>Anabaena spp.</i>		A	chain of spheres	2	fil.: 5-7x100	100				6		1	1 884	1
<i>Anabaena spp.</i>		A	chain of spheres	3	fil.: 7-9x100	100				8		1	3 349	1
<i>Anabaena spp.</i>		A	chain of spheres	4	fil.: 9-12x100	100				11		1	6 332	1
<i>Anabaena spp.</i>		A	cylinder	5	fil.: 3-4x100			100	3.5			1	962	
<i>Anabaena spp.</i>		A	cylinder	6	fil.: 4-5x100			100	4.5			1	1 590	
<i>Anabaenopsis elenkinii</i>	V. Miller 1923	A	cylinder		fil.: 5.8x100			100	5.8			1	2 641	
<i>Anabaenopsis spp.</i>		A	chain of spheres	1	fil.: 4-5x100	100				4.5		1	1 060	1
<i>Anabaenopsis spp.</i>		A	chain of spheres	2	fil.: 5-6x100	100				5.5		1	1 583	1
<i>Aphanizomenon flos-aquae</i>	(L.) Ralfs ex Bornet & Flahault 1886	A	cylinder		fil.: 5x100			100	5			1	1 963	
<i>Aphanizomenon gracile</i>	(Lemmermann) Lemmermann 1910	A	cylinder		fil.: 2.5-3x100			100	2.8			1	615	
<i>Aphanizomenon hungaricum</i>	Komarkova-Legnerova & Matyas	A	cylinder		fil.: 6x100			100	6			1	2 826	*
<i>Aphanizomenon issatschenkoi</i>	(Usacev) Proschkina-Lavrenko 1962	A	cylinder		fil.: 3x100			100	3			1	707	
<i>Aphanizomenon issatschenkoi</i>	(Usacev) Proschkina-Lavrenko 1963	A	cylinder		fil.: 4.5x100			100	4.5			1	1 590	
<i>Aphanizomenon klebahnii</i>	(Elenkin) Pechar & Kalina 2000	A	cylinder		fil.: 5x100			100	5			1	1 963	
<i>Aphanizomenon skujae</i>	Komarkova-Legnerova & Cronberg 1992	A	cylinder		fil.: 2x100			100	2			1	314	*
<i>Aphanizomenon yezoense</i>	Watanabe 1991	A	cylinder		fil.: 3x100			100	3			1	707	
<i>Aphanizomenon sp.</i>		A	cylinder		fil.: 4x100			100	4			1	1 256	2

	Trophy	Geometric shape	Size class No	Cell size range, μm	Length, μm		Width μm	Height μm	Diameter, μm		Number of cells/ counting unit	Calculated volume, μm^3	Comment
					l ₁	l ₂	w	h	d ₁	d ₂			
<i>Aphanizomenon</i> spp.		A cylinder	1	fil.: 2x100				100	2		1	314	
<i>Aphanizomenon</i> spp.		A cylinder	2	fil.: 2.5x100				100	3		1	491	
<i>Aphanizomenon</i> spp.		A cylinder	3	fil.: 3x100				100	3		1	707	
<i>Aphanizomenon</i> spp.		A cylinder	4	fil.: 5x100				100	5		1	1 963	
<i>Gloeotrichia echinulata</i>	J.E. Smith ex P. Richter 1894	A cylinder		fil.: 6x100				100	6		1	2 826	
<i>Gloeotrichia</i> spp.		A cylinder	1	fil.: 6x100				100	6		1	2 826	
<i>Gloeotrichia</i> spp.		A cylinder	2	fil.: 8x100				100	8		1	5 024	
<i>Gloeotrichia</i> spp.		A cylinder	3	fil.: 9x100				100	9		1	6 359	
<i>Nodularia baltica</i>	Komárek <i>et al.</i> 1993	A cylinder		fil.: 6x100				100	6		1	2 826	
<i>Nodularia harveyana</i>	Thuret ex Bornet & Flahault 1886	A cylinder		fil.: 4-5x100				100	4.5		1	1 590	
<i>Nodularia litorea</i>	(Kützing) Thuret ex Komárek <i>et al.</i> 1993	A cylinder		fil.: 10-18x100				100	14		1	15 386	
<i>Nodularia spumigena</i>	Mertens ex Bornet & Flahault 1886	A cylinder	1	fil.: 6-8x100				100	7		1	3 847	
<i>Nodularia spumigena</i>	Mertens ex Bornet & Flahault 1886	A cylinder	2	fil.: 8-10x100				100	9		1	6 359	
<i>Nodularia spumigena</i>	Mertens ex Bornet & Flahault 1886	A cylinder	3	fil.: 10-12x100				100	11		1	9 499	
<i>Nodularia</i> spp.		A cylinder	1	fil.: 4-6x100				100	5		1	1 963	
<i>Nodularia</i> spp.		A cylinder	2	fil.: 6-8x100				100	7		1	3 847	
<i>Nodularia</i> spp.		A cylinder	3	fil.: 8-10x100				100	9		1	6 359	
<i>Nodularia</i> spp.		A cylinder	4	fil.: 10-12x100				100	11		1	9 499	
Division CRYPTOPHYTA													
Class Cryptophyceae													
Order CRYPTOMONADALES													
<i>Chroomonas</i> spp.		A flattened ellipsoid	1	cell: 4x9	9				4	3	1	57	
<i>Chroomonas</i> spp.		A flattened ellipsoid	2	cell: 7x12	12				7	5.6	1	246	
<i>Cryptomonas erosa</i>	Ehrenberg 1832	A flattened ellipsoid		cell: 26x14	26				14	11.2	1	2 134	
<i>Cryptomonas obovata</i>	Skuja 1948	A flattened ellipsoid	1	cell: 15-17	16				8	6.4	1	429	
<i>Cryptomonas obovata</i>	Skuja 1948	A flattened ellipsoid	2	cell: 17-20	18				10	8	1	754	
<i>Cryptomonas obovata</i>	Skuja 1948	A flattened ellipsoid	3	cell: 20-26	23				12	9.6	1	1 387	

		Trophy	Geometric shape	Size class No	Cell size range, μm	Length, μm		Width μm	Height μm	Diameter, μm		Number of cells/ counting unit	Calculated volume, μm^3	Comment
						l ₁	l ₂	w	h	d ₁	d ₂			
<i>Cryptomonas obovata</i>	Skuja 1948	A	flattened ellipsoid	4	cell: 26-29	28				14	11.2	1	2 298	
<i>Cryptomonas obovata</i>	Skuja 1948	A	flattened ellipsoid	5	cell: 29-35	33				17	11.9	1	3 494	
<i>Cryptomonas ovata</i>	Ehrenberg 1832	A	flattened ellipsoid	1	cell: 13-16	14				7	6	1	308	
<i>Cryptomonas ovata</i>	Ehrenberg 1832	A	flattened ellipsoid	2	cell: 16-20	19				13	8.4	1	1 086	
<i>Cryptomonas ovata</i>	Ehrenberg 1832	A	flattened ellipsoid	3	cell: 20-26	24				13	8.4	1	1 372	
<i>Cryptomonas ovata</i>	Ehrenberg 1832	A	flattened ellipsoid	4	cell: 26-29	29				14.5	8.4	1	1 849	
<i>Cryptomonas ovata</i>	Ehrenberg 1832	A	flattened ellipsoid	5	cell: 29-35	32				15.5	8.4	1	2 180	
<i>Cryptomonas platyuris</i>	Skuja 1948	A	flattened ellipsoid		cell: 26-30x15-16	28				15.2	10	1	2 227	
<i>Cryptomonas spp.</i>		A	flattened ellipsoid	1	cell: 16-18x7-8	17				7.5	6	1	400	
<i>Cryptomonas spp.</i>		A	flattened ellipsoid	2	cell: 20-26x10-13	23				11.5	9.2	1	1 273	
<i>Cryptomonas spp.</i>		A	flattened ellipsoid	3	cell: 26-30x13-14	28				13.5	10.8	1	2 136	
<i>Cryptomonas spp.</i>		A	flattened ellipsoid	4	cell: 30-35x15-18	32.5				16.5	13.2	1	3 704	
<i>Cryptomonas spp.</i>		A	cone + half sphere	5	cell: 8-12x4-5				10	4.5		1	65	
<i>Cryptomonas spp.</i>		A	cone + half sphere	6	cell: 12-17x6				15	6		1	170	
<i>Cryptomonas spp.</i>		A	cone + half sphere	7	cell: 17-22x6				20	6		1	217	
<i>Cryptomonas spp.</i>		A	cone + half sphere	8	cell: 30-35x20-25				30	23		1	5 744	
<i>Hemiselmis virescens</i>	Droop 1955	A	cone + half sphere		cell: 4-6x3				5	3		1	15	

	Trophy	Geometric shape	Size class No	Cell size range, μm	Length, μm		Width μm	Height μm	Diameter, μm		Number of cells/ counting unit	Calculated volume, μm^3	Comment
					l ₁	l ₂	w	h	d ₁	d ₂			
<i>Hemiselmis</i> spp.		A cone + half sphere		cell: 4-6x3				5	3		1	15	
<i>Komma caudata</i>	(Geitler) Hill 1991	A cone + half sphere		cell: 7-9x4-5				8	4.5		1	54	
<i>Plagioselmis prolonga</i>	Butcher 1967	A cone + half sphere	1	cell: 5-7x3-4				6	3.5		1	25	
<i>Plagioselmis prolonga</i>	Butcher 1967	A cone + half sphere	2	cell: 7-9x4-5				8	4.5		1	54	
<i>Plagioselmis prolonga</i>	Butcher 1967	A cone + half sphere	3	cell: 7-9x5-7				8	6		1	104	
<i>Plagioselmis</i> spp.		A cone + half sphere	1	cell: 5-7x3-4				6	3.5		1	25	
<i>Plagioselmis</i> spp.		A cone + half sphere	2	cell: 7-9x4-5				8	4.5		1	54	
<i>Plagioselmis</i> spp.		A cone + half sphere	3	cell: 7-9x5-7				8	6		1	104	
<i>Rhodomonas baltica</i>	Karsten 1898	A cone + half sphere		cell: 30x12				30	12		1	1 356	
<i>Rhodomonas lacustris</i> v. <i>lacustris</i>	Pascher & Ruttner in Pascher 1913	A cone + half sphere		cell: 12-14x7				13	7		1	212	
<i>Rhodomonas lacustris</i> v. <i>nannoplantica</i>	(Skuja) Javornický 1976	A cone + half sphere		cell: 7-9x4-6				8	5		1	69	
<i>Rhodomonas marina</i>	(Dangeard) Lemmermann 1908	A cone + half sphere		cell: 20x6				20	6		1	217	
<i>Rhodomonas salina</i>	(Wislouch) Hill & Wetherbee 1989	A cone + half sphere		cell: 12x6				12	6		1	141	

	Trophy	Geometric shape	Size class No	Cell size range, μm	Length, μm		Width μm	Height μm	Diameter, μm		Number of cells/ counting unit	Calculated volume, μm^3	Comment
					l ₁	l ₂	w	h	d ₁	d ₂			
<i>Rhodomonas</i> spp.	A	cone + half sphere	1	cell: 7-9x4-6				8	5		1	69	
<i>Rhodomonas</i> spp.	A	cone + half sphere	2	cell: 11-14x5-6				13	5.5		1	125	
<i>Teleaulax acuta</i>	(Butcher) Hill 1991	A cone + half sphere	1	cell: 12-15x5-6				13	5.5		1	125	
<i>Teleaulax acuta</i>	(Butcher) Hill 1991	A cone + half sphere	2	cell: 13-16x6-7				14	6.5		1	191	
<i>Teleaulax acuta</i>	(Butcher) Hill 1991	A cone + half sphere	3	cell: 15-18x7-8				17	7.5		1	305	
<i>Teleaulax amphioxeia</i>	(Conrad) Hill 1992	A cone + half sphere	1	cell: 8-10x4-5				9	4.5		1	60	
<i>Teleaulax amphioxeia</i>	(Conrad) Hill 1992	A cone + half sphere	2	cell: 10-12x5-6				11	5.5		1	109	
<i>Teleaulax amphioxeia</i>	(Conrad) Hill 1992	A cone + half sphere	3	cell: 12-16x6-8				14	7		1	224	
<i>Teleaulax</i> spp.	A	cone + half sphere	1	cell: 8-11x4-5				9	4.5		1	60	
<i>Teleaulax</i> spp.	A	cone + half sphere	2	cell: 11-15x5-6				13	5.5		1	125	
<i>Teleaulax</i> spp.	A	cone + half sphere	3	cell: 13-16x6-7				14	6.5		1	191	
<i>Teleaulax</i> spp.	A	cone + half sphere	4	cell: 15-19x6-8				17	7.5		1	305	
<i>Cryptomonadales</i> , unidentified	A	cone + half sphere	1	cell: 3x2				3	2		1	4.2	

	Trophy	Geometric shape	Size class No	Cell size range, μm	Length, μm		Width μm	Height μm	Diameter, μm		Number of cells/ counting unit	Calculated volume, μm^3	Comment
					l ₁	l ₂	w	h	d ₁	d ₂			
<i>Cryptomonadales</i> , unidentified	A	cone + half sphere	2	cell: 6x3.5				6	3.5		1	25	
<i>Cryptomonadales</i> , unidentified	A	cone + half sphere	3	cell: 8x4.5				8	4.5		1	54	
<i>Cryptomonadales</i> , unidentified	A	cone + half sphere	3	cell: 10x5				10	5		1	82	
<i>Cryptomonadales</i> , unidentified	A	cone + half sphere	4	cell: 10-12x7				11	7		1	186	
<i>Cryptomonadales</i> , unidentified	A	cone + half sphere	5	cell: 15x10				15	10		1	523	
Division DINOPHYTA (PYRROPHYTA)													
Class Dinophyceae													
Order PROROCENTRALES													
<i>Prorocentrum balticum</i>	(Lohmann) Loeblich III 1970	A	sphere-10%	1	cell: 10				10		1	471	
<i>Prorocentrum balticum</i>	(Lohmann) Loeblich III 1970	A	sphere-10%	2	cell: 13				13		1	1 035	
<i>Prorocentrum balticum</i>	(Lohmann) Loeblich III 1970	A	sphere-10%	3	cell: 15				15		1	1 590	
<i>Prorocentrum lima</i>	(Ehrenberg) Dodge 1975	A	flattened ellipsoid		cell: 50x60	60			50	28	1	43 960	
<i>Prorocentrum micans</i>	Ehrenberg 1833	A	flattened ellipsoid	1	cell: 50x30	50			30	16.5	1	12 953	
<i>Prorocentrum micans</i>	Ehrenberg 1833	A	flattened ellipsoid	2	cell: 60x40	60			40	22	1	27 632	
<i>Prorocentrum minimum</i>	(Pavillard) Schiller 1933	A	cone-10%	1	cell: 16-18x14-16				17	15	1	901	
<i>Prorocentrum minimum</i>	(Pavillard) Schiller 1933	A	cone-10%	2	cell: 18-20x16-17				19	16.5	1	1 218	
<i>Prorocentrum minimum</i>	(Pavillard) Schiller 1933	A	cone-10%	3	cell: 20-22x17-19				21	18	1	1 602	
<i>Prorocentrum spp.</i>		A	cone-10%	1	cell: 18-20x10-12				19	11	1	541	

	Trophy	Geometric shape	Size class No	Cell size range, µm	Length, µm		Width µm	Height µm	Diameter, µm		Number of cells/ counting unit	Calculated volume, µm ³	Comment	
					l ₁	l ₂	w	h	d ₁	d ₂				
<i>Prorocentrum spp.</i>	A	cone-10%	2	cell: 18-20x16-17				19	16.5		1	1 218		
<i>Prorocentrum spp.</i>	A	cone-10%	3	cell: 22-25x19-21				22.5	20		1	2 120		
<i>Prorocentrum spp.</i>	A	flattened ellipsoid	4	cell: 50x30	50				30	16.5	1	12 953		
<i>Prorocentrum spp.</i>	A	flattened ellipsoid	5	cell: 60x40	60				40	22	1	27 632		
Order DINOPHYSALES														
<i>Dinophysis acuminata</i>	Claparède & Lachmann 1859	M	flattened ellipsoid	1	cell: 28-32	30				21	15	1	4 946	HD fact.=0.5
<i>Dinophysis acuminata</i>	Claparède & Lachmann 1859	M	flattened ellipsoid	2	cell: 33-37	35				25	17.5	1	8 014	HD fact.=0.5
<i>Dinophysis acuminata</i>	Claparède & Lachmann 1859	M	flattened ellipsoid	3	cell: 38-42	40				29	20	1	12 141	HD fact.=0.5
<i>Dinophysis acuminata</i>	Claparède & Lachmann 1859	M	flattened ellipsoid	4	cell: 43-47	45				32	22.5	1	16 956	HD fact.=0.5
<i>Dinophysis acuminata</i>	Claparède & Lachmann 1859	M	flattened ellipsoid	5	cell: 48-52	50				36	25	1	23 550	HD fact.=0.5
<i>Dinophysis acuminata</i>	Claparède & Lachmann 1859	M	flattened ellipsoid	6	cell: 53-57	55				40	27.5	1	31 662	HD fact.=0.5
<i>Dinophysis acuta</i>	Ehrenberg 1839	M	flattened ellipsoid	1	cell: 55-57	56				41	28	1	33 644	HD fact.=0.5
<i>Dinophysis acuta</i>	Ehrenberg 1839	M	flattened ellipsoid	2	cell: 58-60	59				43	29.5	1	39 167	HD fact.=0.5
<i>Dinophysis acuta</i>	Ehrenberg 1839	M	flattened ellipsoid	3	cell: 61-65	63				46	31.5	1	47 774	HD fact.=0.5
<i>Dinophysis acuta</i>	Ehrenberg 1839	M	flattened ellipsoid	4	cell: 75	75				55	37.5	1	80 953	HD fact.=0.5
<i>Dinophysis acuta</i>	Ehrenberg 1839	M	flattened ellipsoid	5	cell: 85	85				62	42.5	1	117 214	HD fact.=0.5
<i>Dinophysis dens</i>	Pavillard 1915	M	flattened ellipsoid		cell: 45-50	48				28	19.6	1	13 786	HD fact.=0.7
<i>Dinophysis norvegica</i>	Claparède & Lachmann 1859	M	flattened ellipsoid	1	cell: 40-50	45				31	20.3	1	14 784	HD fact.=0.45
<i>Dinophysis norvegica</i>	Claparède & Lachmann 1859	M	flattened ellipsoid	2	cell: 50-60	55				37	27.5	1	29 287	HD fact.=0.5
<i>Dinophysis norvegica</i>	Claparède & Lachmann 1859	M	flattened ellipsoid	3	cell: 60-70	65				44	32.5	1	48 644	HD fact.=0.5

		Trophy	Geometric shape	Size class No	Cell size range, μm	Length, μm		Width μm	Height μm	Diameter, μm		Number of cells/ counting unit	Calculated volume, μm^3	Comment
						l ₁	l ₂	w	h	d ₁	d ₂			
<i>Dinophysis norvegica</i>	Claperède & Lachmann 1859	M	flattened ellipsoid	4	cell: 70-80	75				51	37.5	1	75 066	HD fact.=0.5
<i>Dinophysis rotundata</i>	Claperède & Lachmann 1859	H	flattened ellipsoid	1	cell: 30-35	32.5				29	8.1	1	4 042	3; 7; HD fact.=0,25
<i>Dinophysis rotundata</i>	Claperède & Lachmann 1859	H	flattened ellipsoid	2	cell: 35-40	37				33	9.3	1	5 964	3; 7; HD fact.=0,25
<i>Dinophysis rotundata</i>	Claperède & Lachmann 1859	H	flattened ellipsoid	3	cell: 40-45	43				39	10.8	1	9 362	3; 7; HD fact.=0,25
<i>Dinophysis rotundata</i>	Claperède & Lachmann 1859	H	flattened ellipsoid	4	cell: 45-55	50				45	12.5	1	14 719	3; 7; HD fact.=0,25
<i>Dinophysis tripos</i>	Gourret 1883	M	flattened ellipsoid		cell: 75	75				40	24	1	37 680	HD fact.=0.6
<i>Dinophysis spp.</i>		M	flattened ellipsoid	1	cell: 15-20	18				13	8.1	1	961	HD fact.=0.45
<i>Dinophysis spp.</i>		M	flattened ellipsoid	2	cell: 20-25	23				16	10.4	1	2 006	HD fact.=0.45
<i>Dinophysis spp.</i>		M	flattened ellipsoid	3	cell: 25-30	28				20	12.6	1	3 619	HD fact.=0.45
<i>Dinophysis spp.</i>		M	flattened ellipsoid	4	cell: 30-40	35				25	15.8	1	7 068	HD fact.=0.45
<i>Dinophysis spp.</i>		M	flattened ellipsoid	5	cell: 40-45	43				30	19.4	1	13 107	HD fact.=0.45
<i>Dinophysis spp.</i>		M	flattened ellipsoid	6	cell: 45-50	48				34	21.6	1	18 231	HD fact.=0.45
<i>Dinophysis spp.</i>		M	flattened ellipsoid	7	cell: 50-60	55				39	24.8	1	27 427	HD fact.=0.45
Order GYMNODINIALES														
<i>Amphidinium carterae</i>	Hulburt 1957	A	flattened ellipsoid		cell: 15-20x8-10	17				9	5.4	1	432	
<i>Amphidinium crassum</i>	Lohmann 1908	H	flattened ellipsoid	1	cell: 20-24x10-14	22.5				12	8	1	1 136	
<i>Amphidinium crassum</i>	Lohmann 1908	H	flattened ellipsoid	2	cell: 25-30x15-20	27.5				17	11.4	1	2 787	
<i>Amphidinium longum</i>	Lohmann 1908	H	flattened ellipsoid		cell: 30-35x10-12	32				11	7.4	1	1 358	
<i>Amphidinium pellucidum</i>	Herdman 1922	H	flattened ellipsoid		cell: 38-43x20-25	40				22	14.7	1	6 788	
<i>Amphidinium sphenoides</i>	Wulff 1916	H	2 cones		cell: 36x8.5				36	8.5		1	681	
<i>Amphidinium sphenoides</i>	Wulff 1916	H	2 cones		cell: 36x14				36	14		1	1 846	

	Trophy	Geometric shape	Size class No	Cell size range, μm	Length, μm		Width μm	Height μm	Diameter, μm		Number of cells/ counting unit	Calculated volume, μm^3	Comment
					l ₁	l ₂	w	h	d ₁	d ₂			
<i>Amphidinium sphenoides</i>	Wulff 1916	H	2 cones	cell: 45x15				45	15		1	2 649	
<i>Amphidinium spp.</i>		A/H	flattened ellipsoid	1 cell: <10	8				6	3.9	1	92	HD fact.=0.7
<i>Amphidinium spp.</i>		A/H	flattened ellipsoid	2 cell: 10-15	13				9	6.4	1	394	HD fact.=0.7
<i>Amphidinium spp.</i>		A/H	flattened ellipsoid	3 cell: 15-20	18				13	8.8	1	1 047	HD fact.=0.7
<i>Amphidinium spp.</i>		A/H	flattened ellipsoid	4 cell: 20-25	22.5				14	9.5	1	1 502	HD fact.=0.7
<i>Amphidinium spp.</i>		A/H	flattened ellipsoid	5 cell: 25-30	27.5				16	11.2	1	2 579	HD fact.=0.7
<i>Amphidinium spp.</i>		A/H	flattened ellipsoid	6 cell: 30-40	35				25	17.2	1	7 696	HD fact.=0.7
<i>Amphidinium spp.</i>		A/H	flattened ellipsoid	7 cell: 40-45	43				30	21.1	1	14 272	HD fact.=0.7
<i>Amphidinium spp.</i>		A/H	flattened ellipsoid	8 cell: 45-50	48				34	23.5	1	19 852	HD fact.=0.7
<i>Gymnodinium album</i>	Lindemann 1928	A	flattened ellipsoid	cell: 15x10	15				10	10	1	785	
<i>Gymnodinium aureolum</i>	(Hulburt) G. Hansen 2000	A	flattened ellipsoid	1 cell: 20-25	23				20	15	1	3 611	
<i>Gymnodinium aureolum</i>	(Hulburt) G. Hansen 2000	A	flattened ellipsoid	2 cell: 26-30	28				23	19	1	6 404	
<i>Gymnodinium galatheanum</i>	Braarud 1957	A	rotational ellipsoid	cell: 13-17x10				13	10		1	680	
<i>Gymnodinium gracile</i>	Bergh 1881	H	flattened ellipsoid	1 cell: 70x30	70				30	21	1	23 079	HD fact.=0.7
<i>Gymnodinium gracile</i>	Bergh 1881	H	flattened ellipsoid	2 cell: 90x50	90				50	35	1	82 425	HD fact.=0.7
<i>Gymnodinium gracile</i>	Bergh 1881	H	flattened ellipsoid	2 cell: 100x60	100				60	42	1	131 880	HD fact.=0.7
<i>Gymnodinium sanguineum</i>	Hirasaka 1924	A	flattened ellipsoid	1 cell: 60x40	60				40	28	1	35 168	HD fact.=0.7
<i>Gymnodinium sanguineum</i>	Hirasaka 1924	A	flattened ellipsoid	2 cell: 80x40	80				40	28	1	46 891	HD fact.=0.7
<i>Gymnodinium sanguineum</i>	Hirasaka 1924	A	flattened ellipsoid	3 cell: 90x45	90				45	31.5	1	66 764	HD fact.=0.7
<i>Gymnodinium simplex</i>	(Lohmann) Kofoid & Swezy 1921	A	flattened ellipsoid	1 cell: 8x6	8				6	4.2	1	106	HD fact.=0.7

		Trophy	Geometric shape	Size class No	Cell size range, μm	Length, μm		Width μm	Height μm	Diameter, μm		Number of cells/ counting unit	Calculated volume, μm^3	Comment
						l ₁	l ₂	w	h	d ₁	d ₂			
<i>Gymnodinium simplex</i>	(Lohmann) Kofoid & Swezy 1921	A	flattened ellipsoid	2	cell: 10x8-9	10				8.5	6	1	265	HD fac.=0.7
<i>Gymnodinium simplex</i>	(Lohmann) Kofoid & Swezy 1921	A	flattened ellipsoid	3	cell: 14x8-10	14				9	6.3	1	415	HD fac.=0.7
<i>Gymnodinium vestificii</i>	Schütt 1895	H	2 cones	1	cell: 19x12				19	12		1	716	
<i>Gymnodinium vestificii</i>	Schütt 1895	H	2 cones	2	cell: 25x12				25	12		1	942	
<i>Gymnodinium vestificii</i>	Schütt 1895	H	2 cones	3	cell: 29x14				29	14		1	1 487	
<i>Gymnodinium vestificii</i>	Schütt 1895	H	2 cones	4	cell: 35x14				35	14		1	1 795	
<i>Gymnodinium vestificii</i>	Schütt 1895	H	2 cones	5	cell: 47x15				47	15		1	2 767	
<i>Gymnodinium spp.</i>		A/H	flattened ellipsoid	1	cell: 5-10x4-6	7.5				5	4	1	72	HD fac.=0.67
<i>Gymnodinium spp.</i>		A/H	flattened ellipsoid	2	cell: 10-15x7-10	12.5				9	6	1	336	HD fac.=0.67
<i>Gymnodinium spp.</i>		A/H	flattened ellipsoid	3	cell: 15-20x11-13	17.5				12	8	1	921	HD fac.=0.67
<i>Gymnodinium spp.</i>		A/H	flattened ellipsoid	4	cell: 20-25x14-17	22.5				16	11	1	1 957	HD fac.=0.67
<i>Gymnodinium spp.</i>		A/H	flattened ellipsoid	5	cell: 25-35x18-23	30				21	14	1	4 639	HD fac.=0.67
<i>Gymnodinium spp.</i>		A/H	flattened ellipsoid	6	cell: 35-45x30-34	40				32	21	1	14 362	HD fac.=0.67
<i>Gymnodinium spp.</i>		A/H	flattened ellipsoid	7	cell: 45-55x38-42	50				40	27	1	28 051	HD fac.=0.67
<i>Gymnodinium spp.</i>		A/H	flattened ellipsoid	8	cell: 55-65x44-50	60				48	32	1	48 472	HD fac.=0.67
<i>Gymnodinium spp.</i>		A/H	flattened ellipsoid	9	cell: 65-75x54-58	70				56	38	1	76 971	HD fac.=0.67
<i>Gymnodinium spp.</i>		A/H	flattened ellipsoid	10	cell: 75-85x62-68	80				64	43	1	114 896	HD fac.=0.67
<i>Gymnodinium spp.</i>		A/H	flattened ellipsoid	11	cell: 85-100x72-76	93				74	50	1	177 606	HD fac.=0.67
<i>Gymnodinium spp.</i>		A/H	flattened ellipsoid	12	cell: 35-45x18-22	40				20	13	1	5 610	HD fac.=0.67
<i>Gymnodinium spp.</i>		A/H	flattened ellipsoid	13	cell: 45-55x23-27	50				25	17	1	10 957	HD fac.=0.67
<i>Gymnodinium spp.</i>		A/H	flattened ellipsoid	14	cell: 55-65x28-32	60				30	20	1	18 934	HD fac.=0.67
<i>Gymnodinium spp.</i>		A/H	flattened ellipsoid	15	cell: 65-75x33-37	70				35	23	1	30 067	HD fac.=0.67

	Trophy	Geometric shape	Size class No	Cell size range, μm	Length, μm		Width μm	Height μm	Diameter, μm		Number of cells/ counting unit	Calculated volume, μm^3	Comment	
					l ₁	l ₂	w	h	d ₁	d ₂				
<i>Gymnodinium</i> spp.		A/H	flattened ellipsoid	16	cell: 75-85x38-42	80				40	27	1	44 881	HD fac.=0.67
<i>Gymnodinium</i> spp.		A/H	flattened ellipsoid	17	cell: 85-100x43-48	92.5				46.3	31	1	69 377	HD fac.=0.67
<i>Gyrodinium fusiforme</i>	Kofoid & Swezy 1921	H	flattened ellipsoid	1	cell: 70-80x18-22	75				20	13	1	10 519	HD fac.=0.67
<i>Gyrodinium fusiforme</i>	Kofoid & Swezy 1921	H	flattened ellipsoid	2	cell: 70-80x22-27	75				25	17	1	16 436	HD fac.=0.67
<i>Gyrodinium fusiforme</i>	Kofoid & Swezy 1921	H	flattened ellipsoid	3	cell: 70-80x27-32	75				30	20	1	23 668	HD fac.=0.67
<i>Gyrodinium fusiforme</i>	Kofoid & Swezy 1921	H	flattened ellipsoid	4	cell: 70-80x32-37	75				35	23	1	32 214	HD fac.=0.67
<i>Gyrodinium resplendens</i>	Hulburt 1957	A	flattened ellipsoid		cell: 45-50x20-25	48				22	15	1	8 146	HD fac.=0.67
<i>Gyrodinium spirale</i>	(Bergh) Kofoid & Swezy 1921	H	2 cones	1	cell: 70-100x18-22				85	20		1	8 897	
<i>Gyrodinium spirale</i>	(Bergh) Kofoid & Swezy 1921	H	2 cones	2	cell: 70-100x22-27				85	25		1	13 901	
<i>Gyrodinium spirale</i>	(Bergh) Kofoid & Swezy 1921	H	2 cones	3	cell: 70-100x27-32				85	30		1	20 018	
<i>Gyrodinium spirale</i>	(Bergh) Kofoid & Swezy 1921	H	2 cones	4	cell: 70-100x32-37				85	35		1	27 246	
<i>Gyrodinium spirale</i>	(Bergh) Kofoid & Swezy 1921	H	2 cones	5	cell: 70-100x37-42				85	40		1	35 587	
<i>Gyrodinium spirale</i>	(Bergh) Kofoid & Swezy 1921	H	2 cones	6	cell: 100-150x37-42				130	40		1	54 427	
<i>Gyrodinium spirale</i>	(Bergh) Kofoid & Swezy 1921	H	2 cones	7	cell: 100-150x42-47				130	45		1	68 884	
<i>Gyrodinium spirale</i>	(Bergh) Kofoid & Swezy 1921	H	2 cones	8	cell: 100-150x47-52				130	50		1	85 042	
<i>Gyrodinium</i> spp.		A/H	flattened ellipsoid	1	cell: 5-10x4-6	7.5				5.3	4	1	72	HD fac.=0.67
<i>Gyrodinium</i> spp.		A/H	flattened ellipsoid	2	cell: 10-15x7-10	12.5				8.8	6	1	336	HD fac.=0.67
<i>Gyrodinium</i> spp.		A/H	flattened ellipsoid	3	cell: 15-20x11-13	17.5				12.3	8	1	921	HD fac.=0.67
<i>Gyrodinium</i> spp.		A/H	flattened ellipsoid	4	cell: 20-25x14-17	22.5				15.8	11	1	1 957	HD fac.=0.67
<i>Gyrodinium</i> spp.		A/H	flattened ellipsoid	5	cell: 25-35x18-23	30				21	14	1	4 639	HD fac.=0.67
<i>Gyrodinium</i> spp.		A/H	flattened ellipsoid	6	cell: 35-45x30-34	40				32	21	1	14 362	HD fac.=0.67
<i>Gyrodinium</i> spp.		A/H	flattened ellipsoid	7	cell: 45-55x38-42	50				40	27	1	28 051	HD fac.=0.67

		Trophy	Geometric shape	Size class No	Cell size range, μm	Length, μm		Width μm	Height μm	Diameter, μm		Number of cells/ counting unit	Calculated volume, μm^3	Comment
						l ₁	l ₂	w	h	d ₁	d ₂			
<i>Gyrodinium spp.</i>		A/H	flattened ellipsoid	8	cell: 55-65x44-50	60				48	32	1	48 472	HD fac.=0.67
<i>Gyrodinium spp.</i>		A/H	flattened ellipsoid	9	cell: 65-75x54-58	70				56	38	1	76 971	HD fac.=0.67
<i>Gyrodinium spp.</i>		A/H	flattened ellipsoid	10	cell: 75-85x62-68	80				64	43	1	114 896	HD fac.=0.67
<i>Gyrodinium spp.</i>		A/H	flattened ellipsoid	11	cell: 85-100x72-76	92.5				74	50	1	177 606	HD fac.=0.67
<i>Gyrodinium spp.</i>		A/H	flattened ellipsoid	12	cell: 35-45x18-22	40				20	13	1	5 610	HD fac.=0.67
<i>Gyrodinium spp.</i>		A/H	flattened ellipsoid	13	cell: 45-55x23-27	50				25	17	1	10 957	HD fac.=0.67
<i>Gyrodinium spp.</i>		A/H	flattened ellipsoid	14	cell: 55-65x28-32	60				30	20	1	18 934	HD fac.=0.67
<i>Gyrodinium spp.</i>		A/H	flattened ellipsoid	15	cell: 65-75x33-37	70				35	23	1	30 067	HD fac.=0.67
<i>Gyrodinium spp.</i>		A/H	flattened ellipsoid	16	cell: 75-85x38-42	80				40	27	1	44 881	HD fac.=0.67
<i>Gyrodinium spp.</i>		A/H	flattened ellipsoid	17	cell: 85-100x43-48	92.5				46.3	31	1	69 377	HD fac.=0.67
<i>Katodinium glaucum</i>	(Lebour) Loeblich III 1965	H	half cone + cut flattened ellipsoid	1	cell: 22x16	22				16	8	1	1 253	HD fac.=0.5
<i>Katodinium glaucum</i>	(Lebour) Loeblich III 1965	H	half cone + cut flattened ellipsoid	2	cell: 33-36x14-15	34.5				14.5	7	1	1 613	HD fac.=0.5
<i>Katodinium glaucum</i>	(Lebour) Loeblich III 1965	H	half cone + cut flattened ellipsoid	3	cell: 25-30x20-22	27				21	11	1	2 648	HD fac.=0.5
<i>Katodinium glaucum</i>	(Lebour) Loeblich III 1965	H	half cone + cut flattened ellipsoid	5	cell: 31-33x23-25	32				24	12	1	4 100	HD fac.=0.5
<i>Katodinium glaucum</i>	(Lebour) Loeblich III 1965	H	half cone + cut flattened ellipsoid	4	cell: 50x20	50				20	10	1	4 448	HD fac.=0.5

		Trophy	Geometric shape	Size class No	Cell size range, μm	Length, μm		Width μm	Height μm	Diameter, μm		Number of cells/ counting unit	Calculated volume, μm^3	Comment
						l ₁	l ₂	w	h	d ₁	d ₂			
<i>Katodinium glaucum</i>	(Lebour) Loeblich III 1965	H	half cone + cut flattened ellipsoid	6	cell: 34-36x26-30	35				28	14	1	6 103	HD fac.=0.5
<i>Katodinium spp.</i>		A/H	half cone + cut flattened ellipsoid	1	cell: 33x14	33				14	7	1	1 439	HD fac.=0.5
<i>Katodinium spp.</i>		A/H	half cone + cut flattened ellipsoid	2	cell: 36x15	36				15	8	1	1 802	HD fac.=0.5
<i>Katodinium spp.</i>		A/H	half cone + cut flattened ellipsoid	3	cell: 50x20	50				20	10	1	4 448	HD fac.=0.5
<i>Polykrikos schwartzii</i>	Bütschli 1873	H	cylinder	1	cell: 40x80				80	40		1	100 480	
<i>Polykrikos schwartzii</i>	Bütschli 1873	H	cylinder	2	cell: 50x60				60	50		1	117 750	
<i>Polykrikos schwartzii</i>	Bütschli 1873	H	cylinder	3	cell: 55x75				75	55		1	178 097	
<i>Polykrikos schwartzii</i>	Bütschli 1873	H	cylinder	4	cell: 60x100				100	60		1	282 600	
<i>Polykrikos schwartzii</i>	Bütschli 1873	H	cylinder	5	cell: 75x160				160	75		1	706 500	
<i>Proterothropsis vigilans</i>	Marshall 1926	H	flattened ellipsoid	1	cell: 20x30	30				20	9	1	2 826	
<i>Proterothropsis vigilans</i>	Marshall 1926	H	flattened ellipsoid	2	cell: 22x42	42				22	10	1	4 836	
<i>Torodinium robustum</i>	Kofoid & Swezy 1921	A	flattened ellipsoid		cell: 22x42	42				22	10	1	4 836	
<i>Gymnodiniales spp.</i>		A/H	sphere-10%	1	cell: <10					10		1	471	
<i>Gymnodiniales spp.</i>		A/H	sphere-10%	2	cell: 10-15					12		1	814	
<i>Gymnodiniales spp.</i>		A/H	sphere-10%	3	cell: 15-20					17		1	2 314	
<i>Gymnodiniales spp.</i>		A/H	sphere-10%	4	cell: 20-27					25		1	7 359	
<i>Gymnodiniales spp.</i>		A/H	sphere-10%	5	cell: 27-40					30		1	12 717	
<i>Gymnodiniales spp.</i>		A/H	sphere-10%	6	cell: 40-50					45		1	42 920	

		Trophy	Geometric shape	Size class No	Cell size range, μm	Length, μm		Width μm	Height μm	Diameter, μm		Number of cells/ counting unit	Calculated volume, μm^3	Comment
						l ₁	l ₂	w	h	d ₁	d ₂			
<i>Gymnodiniales spp.</i>		A/H	sphere-10%	7	cell: 50-70					60		1	101 736	
<i>Gymnodiniales spp.</i>		A/H	sphere-10%	8	cell: 70					70		1	161 553	
<i>Gymnodiniales spp.</i>		A/H	2 cones	9	cell: <10				10	8		1	167	
<i>Gymnodiniales spp.</i>		A/H	2 cones	10	cell: 10-15				12.5	10		1	327	
<i>Gymnodiniales spp.</i>		A/H	2 cones	11	cell: 15-20				17.5	14		1	898	
<i>Gymnodiniales spp.</i>		A/H	2 cones	12	cell: 20-27				23.5	18.8		1	2 173	
<i>Gymnodiniales spp.</i>		A/H	2 cones	13	cell: 27-40				34	27.2		1	6 582	
<i>Gymnodiniales spp.</i>		A/H	2 cones	14	cell: 40-50				45	36		1	15 260	
<i>Gymnodiniales spp.</i>		A/H	2 cones	15	cell: 50-70				60	48		1	36 173	
<i>Gymnodiniales spp.</i>		A/H	2 cones	16	cell: 70				70	56		1	57 441	
<i>Gymnodiniales spp.</i>		A/H	rotational ellipsoid	17	cell: <10				10	8		1	335	
<i>Gymnodiniales spp.</i>		A/H	rotational ellipsoid	18	cell: 10-15				12	9		1	509	
<i>Gymnodiniales spp.</i>		A/H	rotational ellipsoid	19	cell: 15-20				17	11.9		1	1 260	
<i>Gymnodiniales spp.</i>		A/H	rotational ellipsoid	20	cell: 20-27				25	16.3		1	3 455	
<i>Gymnodiniales spp.</i>		A/H	rotational ellipsoid	21	cell: 27-40				32	19.2		1	6 173	
<i>Gymnodiniales spp.</i>		A/H	rotational ellipsoid	22	cell: 40-50				45	24.8		1	14 426	
<i>Gymnodiniales spp.</i>		A/H	rotational ellipsoid	23	cell: 50-70				60	30		1	28 260	
<i>Gymnodiniales spp.</i>		A/H	rotational ellipsoid	24	cell: 70				70	28		1	28 721	
Order OXYRRHINALES														
<i>Oxyrrhis marina</i>	Dujardin 1841	H	flattened ellipsoid		cell: 14x8	14				8	5	1	293	
Order NOCTILUCALES														

		Trophy	Geometric shape	Size class No	Cell size range, μm	Length, μm		Width μm	Height μm	Diameter, μm		Number of cells/ counting unit	Calculated volume, μm^3	Comment
						l ₁	l ₂	w	h	d ₁	d ₂			
<i>Noctiluca scintillans</i>	(Macartney) Kofoid & Swezy 1921	H	sphere	1	cell: 300-500					400		1	33493333	
<i>Noctiluca scintillans</i>	(Macartney) Kofoid & Swezy 1921	H	sphere	2	cell: 500-700					600		1	113040000	
<i>Noctiluca scintillans</i>	(Macartney) Kofoid & Swezy 1921	H	sphere	3	cell: 700-900					800		1	267946667	
<i>Noctiluca scintillans</i>	(Macartney) Kofoid & Swezy 1921	H	sphere	4	cell: 900-1100					1000		1	523333333	
<i>Pronoctiluca pelagica</i>	Fabre-Domerque 1889	H	flattened ellipsoid		cell: 45x12	35				12	10	1	2 198	4
Order PHYTODINIALES (BLASTODINIALES)														
<i>Dissodinium pseudolunula</i>	Swift ex Elbrächter & Drebes 1978	A	monoraphidoid	1	cell: 20-23					22		1	32 500	5; 6
<i>Dissodinium pseudolunula</i>	Swift ex Elbrächter & Drebes 1978	A	monoraphidoid	2	cell: 24-26					25		1	43 000	5; 6
<i>Dissodinium pseudolunula</i>	Swift ex Elbrächter & Drebes 1978	A	monoraphidoid	3	cell: 27-31					29		1	55 000	5; 6
Order PERIDINIALES														
<i>Diplopsalis lenticula</i>	Bergh 1881	H	sphere	1	cell: 30					30		1	14 130	
<i>Diplopsalis lenticula</i>	Bergh 1881	H	sphere	2	cell: 45					45		1	47 689	
<i>Durinskia baltica</i>	(Levander) Carty & E. R. Cox 1986	A	sphere-20%	1	cell: 18-22					20		1	3 349	
<i>Durinskia baltica</i>	(Levander) Carty & E. R. Cox 1986	A	sphere-20%	2	cell: 23-27					25		1	6 542	
<i>Durinskia baltica</i>	(Levander) Carty & E. R. Cox 1986	A	sphere-20%	3	cell: 28-32					30		1	11 304	
<i>Glenodinium danicum</i>	Paulsen 1907	A	flattened ellipsoid		cell: 18-22	20				20	13	1	2 805	HD fac.=0.67
<i>Glenodinium paululum</i>	Lindemann 1928	A	flattened ellipsoid		cell: 20-25	22.5				18	12	1	2 556	HD fac.=0.67
<i>Glenodinium spp.</i>		A/H	flattened ellipsoid	1	cell: 5-10x4-6	7.5				5	4	1	72	HD fac.=0.67
<i>Glenodinium spp.</i>		A/H	flattened ellipsoid	2	cell: 10-15x7-10	12.5				8.8	6	1	336	HD fac.=0.67
<i>Glenodinium spp.</i>		A/H	flattened ellipsoid	3	cell: 15-20x11-13	17.5				12.3	8	1	921	HD fac.=0.67
<i>Glenodinium spp.</i>		A/H	flattened ellipsoid	4	cell: 20-25x14-17	22.5				15.8	11	1	1 957	HD fac.=0.67

		Trophy	Geometric shape	Size class No	Cell size range, μm	Length, μm		Width μm	Height μm	Diameter, μm		Number of cells/ counting unit	Calculated volume, μm^3	Comment
						l ₁	l ₂	w	h	d ₁	d ₂			
<i>Glenodinium spp.</i>		A/H	flattened ellipsoid	5	cell: 25-35x18-23	30				21	14	1	4 639	HD fac.=0.67
<i>Glenodinium spp.</i>		A/H	flattened ellipsoid	6	cell: 35-45x30-34	40				32	21	1	14 362	HD fac.=0.67
<i>Glenodinium spp.</i>		A/H	flattened ellipsoid	7	cell: 45-55x38-42	50				40	27	1	28 051	HD fac.=0.67
<i>Glenodinium spp.</i>		A/H	flattened ellipsoid	8	cell: 55-65x44-50	60				48	32	1	48 472	HD fac.=0.67
<i>Glenodinium spp.</i>		A/H	flattened ellipsoid	9	cell: 35-45x18-22	40				20	13	1	5 610	HD fac.=0.67
<i>Glenodinium spp.</i>		A/H	flattened ellipsoid	10	cell: 45-55x23-27	50				25	17	1	10 957	HD fac.=0.67
<i>Glenodinium spp.</i>		A/H	flattened ellipsoid	11	cell: 55-65x28-32	60				30	20	1	18 934	HD fac.=0.67
<i>Glenodinium spp.</i>		A/H	flattened ellipsoid	12	cell: 65-75x33-37	70				35	23	1	30 067	HD fac.=0.67
<i>Glenodinium spp.</i>		A/H	flattened ellipsoid	13	cell: 75-85x38-42	80				40	27	1	44 881	HD fac.=0.67
<i>Glenodinium spp.</i>		A/H	flattened ellipsoid	14	cell: 85-100x43-48	92.5				46.3	31	1	69 377	HD fac.=0.67
<i>Glenodinium spp.</i>		A/H	sphere-25%	15	cell: 5-10					7.5		1	166	
<i>Glenodinium spp.</i>		A/H	sphere-25%	16	cell: 10-15					12.5		1	767	
<i>Glenodinium spp.</i>		A/H	sphere-25%	17	cell: 15-20					17.5		1	2 104	
<i>Glenodinium spp.</i>		A/H	sphere-25%	18	cell: 20-25					22.5		1	4 471	
<i>Glenodinium spp.</i>		A/H	sphere-25%	19	cell: 25-35					30		1	10 598	
<i>Glenodinium spp.</i>		A/H	sphere-25%	20	cell: 35-45					40		1	25 120	
<i>Glenodinium spp.</i>		A/H	sphere-25%	21	cell: 45-55					50		1	49 063	
<i>Heterocapsa cf. minima</i>	Pomroy 1989	A	2 cones	1	cell: 7-9				8	7		1	103	
<i>Heterocapsa cf. minima</i>	Pomroy 1989	A	2 cones	2	cell: 9-11				10	8		1	167	
<i>Heterocapsa rotundata</i>	(Lohmann) Hansen 1995	A	cone + half sphere	1	cell: 10-12x5-7				11	6		1	132	

		Trophy	Geometric shape	Size class No	Cell size range, μm	Length, μm		Width μm	Height μm	Diameter, μm		Number of cells/ counting unit	Calculated volume, μm^3	Comment
						l ₁	l ₂	w	h	d ₁	d ₂			
<i>Heterocapsa rotundata</i>	(Lohmann) Hansen 1995	A	cone + half sphere	2	cell: 12-15x7-10				13.5	8.5		1	336	
<i>Heterocapsa triquetra</i>	(Ehrenberg) Stein 1883	M	2 cones	1	cell: 15-17x8				16	8		1	268	
<i>Heterocapsa triquetra</i>	(Ehrenberg) Stein 1883	M	2 cones	2	cell: 17-19x11				18	11		1	570	
<i>Heterocapsa triquetra</i>	(Ehrenberg) Stein 1883	M	2 cones	3	cell: 19-21x14-15				20	14.5		1	1 100	
<i>Heterocapsa triquetra</i>	(Ehrenberg) Stein 1883	M	2 cones	4	cell: 22-24x15				23	15		1	1 354	
<i>Heterocapsa triquetra</i>	(Ehrenberg) Stein 1883	M	2 cones	5	cell: 25-28x17-21				27	19		1	2 550	
<i>Heterocapsa triquetra</i>	(Ehrenberg) Stein 1883	M	2 cones	6	cell: 32-34x21-23				33	22		1	4 179	
<i>Heterocapsa spp.</i>		A	cone + half sphere	1	cell: 10-12x 5-7				11	6		1	132	
<i>Heterocapsa spp.</i>		A	cone + half sphere	2	cell: 12-15x 7-10				13.5	8.5		1	336	
<i>Heterocapsa spp.</i>		A	2 cones	3	cell: 15-17x 8				16	8		1	268	
<i>Heterocapsa spp.</i>		A	2 cones	4	cell: 17-19 x11				18	11		1	570	
<i>Heterocapsa spp.</i>		A	2 cones	5	cell: 20x14-15				20	14.5		1	1 100	
<i>Heterocapsa spp.</i>		A	2 cones	6	cell: 23x15				23	15		1	1 354	
<i>Heterocapsa spp.</i>		A	2 cones	7	cell: 25-28x17-21				27	19		1	2 550	
<i>Heterocapsa spp.</i>		A	2 cones	8	cell: 32-34x21-23				33	22		1	4 179	
<i>Kryptoperidinium foliaceum</i>	(Stein) Lindemann 1924	A	sphere- 25%		cell: 30					30		1	10 598	
<i>Oblea rotunda</i>	(Lebour) Balech ex Sourmia 1973	H	sphere- 10%		cell: 30					30		1	12 717	
<i>Oblea rotunda complex</i>		A/H	sphere- 10%	1	cell: 22-28					25		1	7 359	
<i>Oblea rotunda complex</i>		A/H	sphere- 10%	2	cell: 28-33					30		1	12 717	
<i>Oblea rotunda complex</i>		A/H	sphere- 10%	3	cell: 34-36					35		1	20 194	
<i>Pentapharsodinium dalei</i>	Indelicato & Loeblich III 1986	A	cone + half sphere	1	cell: <15				14	10		1	497	
<i>Pentapharsodinium dalei</i>	Indelicato & Loeblich III 1986	A	cone + half sphere	2	cell: 15-20				18	14		1	1 282	

		Trophy	Geometric shape	Size class No	Cell size range, μm	Length, μm		Width μm	Height μm	Diameter, μm		Number of cells/ counting unit	Calculated volume, μm^3	Comment
						l ₁	l ₂	w	h	d ₁	d ₂			
<i>Pentapharsodinium dalei</i>	Indelicato & Loeblich III 1986	A	cone + half sphere	3	cell: 20-25				23	20		1	3 454	
<i>Peridinium cinctum</i>	(O.F. Müller) Ehrenberg 1838	A	sphere- 20%		cell: 45					45		1	38 151	
<i>Peridinium inconspicuum</i>	Lemmermann 1899	A	flattened ellipsoid		cell: 20x30	30				20	13	1	4 208	
<i>Preperidinium meunieri</i>	(Pavillard) Elbrächter 1993	H	flattened ellipsoid	1	cell: 48x28	48				28	19	1	13 195	
<i>Preperidinium meunieri</i>	(Pavillard) Elbrächter 1993	H	flattened ellipsoid	2	cell: 55x38	55				38	25	1	27 847	
<i>Protoperidinium achromaticum</i>	(Levander) Balech 1974	H	sphere- 10%	1	cell: 33-37					35		1	20 194	
<i>Protoperidinium achromaticum</i>	(Levander) Balech 1974	H	sphere- 10%	2	cell: 38-42					40		1	30 144	
<i>Protoperidinium bipes</i>	(Paulsen) Balech 1974	H	half cone	1	cell: 18-22x12-14				20	13		1	442	
<i>Protoperidinium bipes</i>	(Paulsen) Balech 1974	H	half cone	2	cell: 23-26x17-21				25	19		1	1 181	
<i>Protoperidinium bipes</i>	(Paulsen) Balech 1974	H	half cone	3	cell: 27-30x22-26				28	24		1	2 110	
<i>Protoperidinium breve</i>	(Paulsen) Balech 1974	H	sphere- 10%	1	cell: 23-27					25		1	7 359	
<i>Protoperidinium breve</i>	(Paulsen) Balech 1974	H	sphere- 10%	2	cell: 28-32					30		1	12 717	
<i>Protoperidinium breve</i>	(Paulsen) Balech 1974	H	sphere- 10%	3	cell: 33-37					35		1	20 194	
<i>Protoperidinium breve</i>	(Paulsen) Balech 1974	H	sphere- 10%	4	cell: 38-42					40		1	30 144	
<i>Protoperidinium breve</i>	(Paulsen) Balech 1974	H	sphere- 10%	5	cell: 43-47					45		1	42 920	
<i>Protoperidinium breve</i>	(Paulsen) Balech 1974	H	sphere- 10%	6	cell: 48-52					50		1	58 875	
<i>Protoperidinium brevipes</i>	(Paulsen) Balech 1974	H	cone + half sphere	1	cell: 18-22				20	20		1	3 140	
<i>Protoperidinium brevipes</i>	(Paulsen) Balech 1974	H	cone + half sphere	2	cell: 23-29				26	26		1	6 899	
<i>Protoperidinium brevipes</i>	(Paulsen) Balech 1974	H	cone + half sphere	3	cell: 30-35				34	31		1	12 447	

		Trophy	Geometric shape	Size class No	Cell size range, μm	Length, μm		Width μm	Height μm	Diameter, μm		Number of cells/ counting unit	Calculated volume, μm^3	Comment
						l ₁	l ₂	w	h	d ₁	d ₂			
<i>Protoperidinium brevipes</i>	(Paulsen) Balech 1974	H	cone + half sphere	4	cell: 36-40				37	37		1	19 881	
<i>Protoperidinium claudicans</i>	(Paulsen) Balech 1974	H	cone + half sphere	1	cell: 83x55				83	55		1	87 465	
<i>Protoperidinium claudicans</i>	(Paulsen) Balech 1974	H	cone + half sphere	2	cell: 84x72				84	72		1	162 778	
<i>Protoperidinium claudicans</i>	(Paulsen) Balech 1974	H	cone + half sphere	3	cell: 85x65				85	65		1	129 901	
<i>Protoperidinium conicoides</i>	(Paulsen) Balech 1973	H	cone + half sphere	1	cell: 44-48				46	46		1	38 204	
<i>Protoperidinium conicoides</i>	(Paulsen) Balech 1973	H	cone + half sphere	2	cell: 48-52				50	50		1	49 063	
<i>Protoperidinium conicoides</i>	(Paulsen) Balech 1973	H	cone + half sphere	3	cell: 52-57				55	55		1	65 302	
<i>Protoperidinium conicum</i>	(Gran) Balech 1974	H	cone + half sphere	1	cell: 52-57				55	55		1	65 302	
<i>Protoperidinium conicum</i>	(Gran) Balech 1974	H	cone + half sphere	2	cell: 57-62				60	50		1	55 604	
<i>Protoperidinium conicum</i>	(Gran) Balech 1974	H	cone + half sphere	3	cell: 72-77				75	75		1	165 586	
<i>Protoperidinium conicum</i>	(Gran) Balech 1974	H	cone + half sphere	4	cell: 77-82				80	80		1	200 960	
<i>Protoperidinium conicum</i>	(Gran) Balech 1974	H	cone + half sphere	5	cell: 87-92				90	90		1	286 133	
<i>Protoperidinium curvipes</i>	(Ostenfeld) Balech 1974	H	cone + half sphere		cell: 75-85				70	70		1	134 628	

		Trophy	Geometric shape	Size class No	Cell size range, μm	Length, μm		Width μm	Height μm	Diameter, μm		Number of cells/ counting unit	Calculated volume, μm^3	Comment
						l ₁	l ₂	w	h	d ₁	d ₂			
<i>Protoperidinium denticulatum</i>	(Gran & Braarud) Balech 1974	H	flattened ellipsoid - 20%		cell: 45-55	50				30	23	1	14 130	
<i>Protoperidinium depressum</i>	(J.W. Bailey) Balech 1974	H	(cone + half sphere)- 20%	1	cell: 65-75				110	70		1	148 731	
<i>Protoperidinium depressum</i>	(J.W. Bailey) Balech 1974	H	(cone + half sphere)- 20%	2	cell: 95-105				100	100		1	314 000	
<i>Protoperidinium depressum</i>	(J.W. Bailey) Balech 1974	H	(cone + half sphere)- 20%	3	cell: 105-115				110	110		1	417 934	
<i>Protoperidinium depressum</i>	(J.W. Bailey) Balech 1974	H	(cone + half sphere)- 20%	4	cell: 115-130				125	90		1	288 252	
<i>Protoperidinium depressum</i>	(J.W. Bailey) Balech 1974	H	(cone + half sphere)- 20%	5	cell: 130-150				140	115		1	546 766	
<i>Protoperidinium divergens</i>	(Ehrenberg) Balech 1974	H	(cone + half sphere)- 20%	1	cell: 80x60				80	60		1	82 896	
<i>Protoperidinium divergens</i>	(Ehrenberg) Balech 1974	H	(cone + half sphere)- 20%	2	cell: 85x65				85	65		1	103 921	
<i>Protoperidinium divergens</i>	(Ehrenberg) Balech 1974	H	(cone + half sphere)- 20%	3	cell: 83x70				83	70		1	121 037	
<i>Protoperidinium granii</i>	(Ostenfeld) Balech 1974	H	(cone + half sphere)- 20%	1	cell: 25-27				35	25		1	6 215	

		Trophy	Geometric shape	Size class No	Cell size range, μm	Length, μm		Width μm	Height μm	Diameter, μm		Number of cells/ counting unit	Calculated volume, μm^3	Comment
						l ₁	l ₂	w	h	d ₁	d ₂			
<i>Protoperidinium granii</i>	(Ostenfeld) Balech 1974	H	(cone + half sphere)-20%	2	cell: 28-30				37	29		1	9 067	
<i>Protoperidinium granii</i>	(Ostenfeld) Balech 1974	H	(cone + half sphere)-20%	3	cell: 31-33				39	32		1	11 790	
<i>Protoperidinium granii</i>	(Ostenfeld) Balech 1974	H	(cone + half sphere)-20%	4	cell: 34-36				40	35		1	14 745	
<i>Protoperidinium granii</i>	(Ostenfeld) Balech 1974	H	(cone + half sphere)-20%	5	cell: 37-39				41	38		1	18 137	
<i>Protoperidinium granii</i>	(Ostenfeld) Balech 1974	H	(cone + half sphere)-20%	6	cell: 40-42				42	41		1	21 993	
<i>Protoperidinium granii</i>	(Ostenfeld) Balech 1974	H	(cone + half sphere)-20%	7	cell: 43-45				47	44		1	27 964	
<i>Protoperidinium leonis</i>	(Pavillard) Balech 1974	H	2 cones-30%		cell: 60				60	60		1	39 564	
<i>Protoperidinium longispinum</i>	(Kofoid) Balech 1974	H	(cone + half sphere)-20%		cell: 70-90				80	60		1	82 896	
<i>Protoperidinium minutum</i>	(Kofoid) Loeblich III 1969	H	sphere-20%	1	cell: 38-42					40		1	26 795	
<i>Protoperidinium minutum</i>	(Kofoid) Loeblich III 1969	H	sphere-20%	2	cell: 43-48					46		1	40 751	
<i>Protoperidinium oblongum</i>	(Aurivillius) Parke & Dodge in Parke & Dixon 1976	H	(cone + half sphere)-20%	1	cell: 75-85				80	60		1	82 896	

		Trophy	Geometric shape	Size class No	Cell size range, μm	Length, μm		Width μm	Height μm	Diameter, μm		Number of cells/ counting unit	Calculated volume, μm^3	Comment
						l ₁	l ₂	w	h	d ₁	d ₂			
<i>Protoperidinium oblongum</i>	(Aurivillius) Parke & Dodge in Parke & Dixon 1976	H	(cone + half sphere)-20%	2	cell: 85-95				90	50		1	60 183	
<i>Protoperidinium oblongum</i>	(Aurivillius) Parke & Dodge in Parke & Dixon 1976	H	(cone + half sphere)-20%	3	cell: 95-105				100	70		1	138 474	
<i>Protoperidinium oblongum</i>	(Aurivillius) Parke & Dodge in Parke & Dixon 1976	H	(cone + half sphere)-20%	4	cell: 105-115				110	65		1	126 032	
<i>Protoperidinium oblongum</i>	(Aurivillius) Parke & Dodge in Parke & Dixon 1976	H	(cone + half sphere)-20%	5	cell: 130-150				140	110		1	493 922	
<i>Protoperidinium pallidum</i>	(Ostenfeld) Balech 1973	H	(cone + half sphere)-20%	1	cell: 52-57				70	55		1	61 740	
<i>Protoperidinium pallidum</i>	(Ostenfeld) Balech 1973	H	(cone + half sphere)-20%	2	cell: 57-62				80	60		1	82 896	
<i>Protoperidinium pallidum</i>	(Ostenfeld) Balech 1973	H	(cone + half sphere)-20%	3	cell: 67-72				90	70		1	128 217	
<i>Protoperidinium pellucidum</i>	Bergh 1881	H	(cone + half sphere)-25%	1	cell: 35-37				42	36		1	15 260	
<i>Protoperidinium pellucidum</i>	Bergh 1881	H	(cone + half sphere)-25%	2	cell: 38-40				60	40		1	25 120	
<i>Protoperidinium pellucidum</i>	Bergh 1881	H	(cone + half sphere)-25%	3	cell: 41-43				52	42		1	25 272	

		Trophy	Geometric shape	Size class No	Cell size range, μm	Length, μm		Width μm	Height μm	Diameter, μm		Number of cells/ counting unit	Calculated volume, μm^3	Comment
						l ₁	l ₂	w	h	d ₁	d ₂			
<i>Protoperidinium pellucidum</i>	Bergh 1881	H	(cone + half sphere)-25%	4	cell: 44-46				47	45		1	27 620	
<i>Protoperidinium pellucidum</i>	Bergh 1881	H	(cone + half sphere)-25%	5	cell: 47-49				55	48		1	35 721	
<i>Protoperidinium pellucidum</i>	Bergh 1881	H	(cone + half sphere)-25%	6	cell: 50-52				52	52		1	41 391	
<i>Protoperidinium pentagonum</i>	(Gran) Balech 1974	H	2 cones-30%		cell: 80x60				80	60		1	52 752	
<i>Protoperidinium pyriforme</i>	(Paulsen) Balech 1974	H	cone + half sphere		cell: 50x40				50	40		1	29 307	
<i>Protoperidinium steinii</i>	(E. Jørgensen) Balech 1974	H	(cone + half sphere)-25%	1	cell: 32-37				30	35		1	11 419	
<i>Protoperidinium steinii</i>	(E. Jørgensen) Balech 1974	H	(cone + half sphere)-25%	2	cell: 37-42				50	40		1	21 980	
<i>Protoperidinium subinerve</i>	(Paulsen) Loeblich III 1969	H	(cone + half sphere)-25%	1	cell: 40x40				40	40		1	18 840	
<i>Protoperidinium subinerve</i>	(Paulsen) Loeblich III 1969	H	(cone + half sphere)-25%	2	cell: 46x44				46	44		1	25 836	
<i>Protoperidinium subinerve</i>	(Paulsen) Loeblich III 1969	H	(cone + half sphere)-25%	3	cell: 60x50				60	50		1	41 703	

		Trophy	Geometric shape	Size class No	Cell size range, μm	Length, μm		Width μm	Height μm	Diameter, μm		Number of cells/ counting unit	Calculated volume, μm^3	Comment
						l ₁	l ₂	w	h	d ₁	d ₂			
<i>Protoperidinium thorianum</i>	(Paulsen) Balech 1973	H	rotational ellipsoid-20%	1	cell: 60x50				60	50		1	62 800	
<i>Protoperidinium thorianum</i>	(Paulsen) Balech 1973	H	rotational ellipsoid-20%	2	cell: 70x60				70	60		1	105 504	
<i>Protoperidinium spp.</i>		H	(cone + half sphere)-25%	1	cell: 20x15				20	15		1	1 214	
<i>Protoperidinium spp.</i>		H	(cone + half sphere)-25%	2	cell: 25x20				25	20		1	2 748	
<i>Protoperidinium spp.</i>		H	(cone + half sphere)-25%	3	cell: 30x25				30	25		1	5 213	
<i>Protoperidinium spp.</i>		H	(cone + half sphere)-25%	4	cell: 35x30				35	30		1	8 831	
<i>Protoperidinium spp.</i>		H	(cone + half sphere)-25%	5	cell: 45x30				40	35		1	13 823	
<i>Protoperidinium spp.</i>		H	(cone + half sphere)-25%	6	cell: 45x40				45	40		1	20 410	
<i>Protoperidinium spp.</i>		H	(cone + half sphere)-25%	7	cell: 50x45				50	45		1	28 812	
<i>Protoperidinium spp.</i>		H	(cone + half sphere)-25%	8	cell: 55x50				55	50		1	39 250	

	Trophy	Geometric shape	Size class No	Cell size range, μm	Length, μm		Width μm	Height μm	Diameter, μm		Number of cells/ counting unit	Calculated volume, μm^3	Comment
					l ₁	l ₂	w	h	d ₁	d ₂			
<i>Protoperdinium spp.</i>	H	(cone + half sphere)-25%	9	cell: 60x50				60	55		1	51 945	
<i>Scrippsiella hangoei</i>	(Schiller) Larsen <i>in</i> Larsen <i>et al.</i> 1995	A sphere	1	cell: 16-18					16		1	2 144	
<i>Scrippsiella hangoei</i>	(Schiller) Larsen <i>in</i> Larsen <i>et al.</i> 1995	A sphere	2	cell: 19-21					20		1	4 187	
<i>Scrippsiella hangoei</i>	(Schiller) Larsen <i>in</i> Larsen <i>et al.</i> 1995	A sphere	3	cell: 22-24					23		1	6 367	
<i>Scrippsiella hangoei</i>	(Schiller) Larsen <i>in</i> Larsen <i>et al.</i> 1995	A sphere	4	cell: 25-27					26		1	9 198	
<i>Scrippsiella hangoei</i>	(Schiller) Larsen <i>in</i> Larsen <i>et al.</i> 1995	A sphere	5	cell: 28-30					29		1	12 764	
<i>Scrippsiella hangoei</i>	(Schiller) Larsen <i>in</i> Larsen <i>et al.</i> 1995	A rotational ellipsoid	6	cell: 18x20				20	18		1	3 391	
<i>Scrippsiella hangoei</i>	(Schiller) Larsen <i>in</i> Larsen <i>et al.</i> 1995	A rotational ellipsoid	7	cell: 22x25				25	22		1	6 332	
<i>Scrippsiella hangoei</i>	(Schiller) Larsen <i>in</i> Larsen <i>et al.</i> 1995	A rotational ellipsoid	8	cell: 26x30				30	26		1	10 613	
<i>Scrippsiella trochoidea</i>	(Stein) Loeblich III 1976	A cone + half sphere	1	cell: 15x17				17.4	14.5		1	1 356	
<i>Scrippsiella trochoidea</i>	(Stein) Loeblich III 1976	A cone + half sphere	2	cell: 25x25				25	25		1	6 133	
<i>Scrippsiella trochoidea</i>	(Stein) Loeblich III 1976	A cone + half sphere	3	cell: 28x30				30	28		1	9 026	
<i>Peridinales spp.</i>		A/H sphere-20%	1	cell: <10					8		1	214	
<i>Peridinales spp.</i>		A/H sphere-20%	2	cell: 10-15					12		1	723	
<i>Peridinales spp.</i>		A/H sphere-20%	3	cell: 15-20					17		1	2 057	
<i>Peridinales spp.</i>		A/H sphere-20%	4	cell: 20-27					25		1	6 542	

	Trophy	Geometric shape	Size class No	Cell size range, μm	Length, μm		Width μm	Height μm	Diameter, μm		Number of cells/ counting unit	Calculated volume, μm^3	Comment
					l ₁	l ₂	w	h	d ₁	d ₂			
<i>Peridinales spp.</i>	A/H	sphere-20%	5	cell: 27-40					32		1	13 719	
<i>Peridinales spp.</i>	A/H	sphere-20%	6	cell: 40-50					45		1	38 151	
<i>Peridinales spp.</i>	A/H	sphere-20%	7	cell: 50-70					60		1	90 432	
<i>Peridinales spp.</i>	A/H	sphere-20%	8	cell: 70					70		1	143 603	
<i>Peridinales spp.</i>	A/H	2 cones	9	cell: <10				10	8		1	167	
<i>Peridinales spp.</i>	A/H	2 cones	10	cell: 10-15				12	9		1	254	
<i>Peridinales spp.</i>	A/H	2 cones	11	cell: 15-20				17	11.9		1	630	
<i>Peridinales spp.</i>	A/H	2 cones	12	cell: 20-27				25	16.3		1	1 727	
<i>Peridinales spp.</i>	A/H	2 cones	13	cell: 27-40				32	19.2		1	3 087	
<i>Peridinales spp.</i>	A/H	2 cones	14	cell: 40-50				45	24.8		1	7 213	
<i>Peridinales spp.</i>	A/H	2 cones	15	cell: 50-70				60	30		1	14 130	
<i>Peridinales spp.</i>	A/H	2 cones	16	cell: 70				70	28		1	14 360	
<i>Peridinales spp.</i>	A/H	rotational ellipsoid	17	cell: <10				10	8		1	335	
<i>Peridinales spp.</i>	A/H	rotational ellipsoid	18	cell: 10-15				12	9		1	509	
<i>Peridinales spp.</i>	A/H	rotational ellipsoid	19	cell: 15-20				17	11.9		1	1 260	
<i>Peridinales spp.</i>	A/H	rotational ellipsoid	20	cell: 20-27				25	16.3		1	3 455	
<i>Peridinales spp.</i>	A/H	rotational ellipsoid	21	cell: 27-40				32	19.2		1	6 173	
<i>Peridinales spp.</i>	A/H	rotational ellipsoid	22	cell: 40-50				45	24.8		1	14 426	
<i>Peridinales spp.</i>	A/H	rotational ellipsoid	23	cell: 50-70				60	30		1	28 260	
<i>Peridinales spp.</i>	A/H	rotational ellipsoid	24	cell: 70				70	28		1	28 721	

	Trophy	Geometric shape	Size class No	Cell size range, μm	Length, μm		Width μm	Height μm	Diameter, μm		Number of cells/ counting unit	Calculated volume, μm^3	Comment
					l ₁	l ₂	w	h	d ₁	d ₂			
Order GONYAULACALES													
<i>Alexandrium minutum</i>	Halim 1960	A	rotational ellipsoid	1	cell: 23-25			24	24		1	7 235	6
<i>Alexandrium minutum</i>	Halim 1960	A	rotational ellipsoid	2	cell: 26-29			27	28		1	11 078	6
<i>Alexandrium ostenfeldii</i>	(Paulsen) Balech & Tangen 1985	A	rotational ellipsoid	1	cell: 32-37			35	34		1	21 174	6
<i>Alexandrium ostenfeldii</i>	(Paulsen) Balech & Tangen 1985	A	rotational ellipsoid	2	cell: 50-55			54	50		1	70 650	6
<i>Alexandrium tamarensense</i>	(Lebour) Balech 1995	A	rotational ellipsoid	1	cell: 25-27			25	26		1	8 844	6
<i>Alexandrium tamarensense</i>	(Lebour) Balech 1995	A	rotational ellipsoid	2	cell: 28-30			35	30		1	16 485	6
<i>Alexandrium tamarensense</i>	(Lebour) Balech 1995	A	rotational ellipsoid	3	cell: 31-32			33	32		1	17 684	6
<i>Alexandrium spp.</i>		A	rotational ellipsoid	1	cell: 23-25			24	24		1	7 235	6
<i>Alexandrium spp.</i>		A	rotational ellipsoid	2	cell: 26-29			27	28		1	11 078	6
<i>Alexandrium spp.</i>		A	rotational ellipsoid	3	cell: 30-32			33	31		1	16 596	6
<i>Amylax triacantha</i>	(E. Jørgensen) Sournia 1984	A	(cone + half sphere)-25%	1	cell: 35-45x23-26			40	25		1	6 439	
<i>Amylax triacantha</i>	(E. Jørgensen) Sournia 1984	A	(cone + half sphere)-25%	2	cell: 45-55x27-30			50	29		1	10 645	

		Trophy	Geometric shape	Size class No	Cell size range, μm	Length, μm		Width μm	Height μm	Diameter, μm		Number of cells/ counting unit	Calculated volume, μm^3	Comment
						l ₁	l ₂	w	h	d ₁	d ₂			
<i>Amylax triacantha</i>	(E. Jørgensen) Sournia 1984	A	(cone + half sphere)-25%	3	cell: 35-45x34-37				40	35		1	13 823	
<i>Amylax triacantha</i>	(E. Jørgensen) Sournia 1984	A	(cone + half sphere)-25%	4	cell: 47-57x35-40				52	38		1	20 120	
<i>Ceratium furca</i>	(Ehrenberg) Claparède & Lachmann 1859	A		1	cell: 35-45					40		1	30 000	5; 6
<i>Ceratium furca</i>	(Ehrenberg) Claparède & Lachmann 1859	A		2	cell: 45-55					50		1	50 000	5; 6
<i>Ceratium furca</i>	(Ehrenberg) Claparède & Lachmann 1859	A		3	cell: 55-65					60		1	75 000	5; 6
<i>Ceratium fusus</i>	(Ehrenberg) Dujardin 1841	A		1	cell: 15-25					20		1	12 000	5; 6
<i>Ceratium fusus</i>	(Ehrenberg) Dujardin 1841	A		2	cell: 25-35					22		1	27 000	5; 6
<i>Ceratium hirundinella</i>	(O.F. Müller) Schrank 1793	A		1	cell: 110-130					55		1	15 377	5; 7
<i>Ceratium hirundinella</i>	(O.F. Müller) Schrank 1793	A		2	cell: 130-150					55		1	20 403	5; 7
<i>Ceratium hirundinella</i>	(O.F. Müller) Schrank 1793	A		2	cell: 150-180					55		1	25 532	5; 7
<i>Ceratium horridum</i>	(P.T. Cleve) Gran 1902	A		1	cell: 40x200-250					40		1	44 526	5; 6
<i>Ceratium horridum</i>	(P.T. Cleve) Gran 1902	A		2	cell: 50x200-250					50		1	75 961	5; 6
<i>Ceratium horridum</i>	(P.T. Cleve) Gran 1902	A		3	cell: 60x200-250					60		1	123 146	5; 6
<i>Ceratium lineatum</i>	(Ehrenberg) P.T. Cleve 1899	A		1	cell: 25-30					25		1	9 000	5; 6
<i>Ceratium lineatum</i>	(Ehrenberg) P.T. Cleve 1899	A		2	cell: 30-35					30		1	13 000	5; 6
<i>Ceratium lineatum</i>	(Ehrenberg) P.T. Cleve 1899	A		3	cell: 35-40					35		1	17 000	5; 6
<i>Ceratium lineatum</i>	(Ehrenberg) P.T. Cleve 1899	A		4	cell: 40-45					40		1	20 000	5; 6
<i>Ceratium lineatum</i>	(Ehrenberg) P.T. Cleve 1899	A		5	cell: 45-50					50		1	28 000	5; 6
<i>Ceratium longipes</i>	(J.W. Bailey) Gran 1902	A		1	cell: 45-55					50		1	58 000	5; 6
<i>Ceratium longipes</i>	(J.W. Bailey) Gran 1902	A		2	cell: 55-65					60		1	101 250	5; 6
<i>Ceratium macroceros</i>	(Ehrenberg) Vanhöffen 1897	A		1	cell: 40-50					45		1	41 258	5; 6
<i>Ceratium macroceros</i>	(Ehrenberg) Vanhöffen 1897	A		2	cell: 50-60					55		1	60 000	5; 6
<i>Ceratium tripos</i>	(O.F. Müller) Nitzsch 1817	A		1	cell: 30-40					35		1	23 200	5; 6
<i>Ceratium tripos</i>	(O.F. Müller) Nitzsch 1817	A		2	cell: 40-50					45		1	40 300	5; 6
<i>Ceratium tripos</i>	(O.F. Müller) Nitzsch 1817	A		3	cell: 50-60					55		1	63 800	5; 6
<i>Ceratium tripos</i>	(O.F. Müller) Nitzsch 1817	A		4	cell: 60-70					65		1	104 100	5; 6
<i>Ceratium tripos</i>	(O.F. Müller) Nitzsch 1817	A		5	cell: 70-80					75		1	174 800	5; 6
<i>Ceratium tripos</i>	(O.F. Müller) Nitzsch 1817	A		5	cell: 80-90					85		1	210 000	5; 6
<i>Cladopyxis claytonii</i>	R.W. Holmes 1956	A	sphere	1	cell: 14-20					17		1	2 571	
<i>Cladopyxis claytonii</i>	R.W. Holmes 1956	A	sphere	2	cell: 20-25					22.4		1	5 882	

	Trophy	Geometric shape	Size class No	Cell size range, μm	Length, μm		Width μm	Height μm	Diameter, μm		Number of cells/ counting unit	Calculated volume, μm^3	Comment	
					l ₁	l ₂	w	h	d ₁	d ₂				
<i>Cladopyxis setifera</i>	Lohmann 1902	A	sphere	1	cell: 10					10		1	523	
<i>Cladopyxis setifera</i>	Lohmann 1902	A	sphere	2	cell: 15					15		1	1 766	
<i>Cladopyxis setifera</i>	Lohmann 1902	A	sphere	3	cell: 17					17		1	2 571	
<i>Cladopyxis setifera</i>	Lohmann 1902	A	sphere	4	cell: 21					21		1	4 847	
<i>Gonyaulax digitale</i>	(Pouchet) Kofoid 1911	A	cone + half sphere	1	cell: 26x44				44	26		1	10 083	
<i>Gonyaulax digitale</i>	(Pouchet) Kofoid 1911	A	cone + half sphere	2	cell: 36x56				56	36		1	25 095	
<i>Gonyaulax digitale</i>	(Pouchet) Kofoid 1911	A	cone + half sphere	3	cell: 43-46x54-60				57	44.5		1	41 065	
<i>Gonyaulax polygramma</i>	Stein 1883	A	cone + half sphere		cell: 30				30	30		1	10 598	
<i>Gonyaulax spinifera</i>	(Claparède & Lachmann) Diesing 1866	A	cone + half sphere	1	cell: 30				35	30		1	11 775	6
<i>Gonyaulax spinifera</i>	(Claparède & Lachmann) Diesing 1866	A	cone + half sphere	2	cell: 35				35	35		1	16 828	6
<i>Gonyaulax spinifera</i>	(Claparède & Lachmann) Diesing 1866	A	cone + half sphere	3	cell: 40				40	40		1	25 120	6
<i>Gonyaulax verior</i>	Sournia 1973	A	(cone + half sphere)- 25%	1	cell: 24x40				40	24		1	5 878	
<i>Gonyaulax verior</i>	Sournia 1973	A	(cone + half sphere)- 25%	2	cell: 50x64				64	50		1	43 666	
<i>Gonyaulax verior</i>	Sournia 1973	A	(cone + half sphere)- 25%	3	cell: 60-64x70-72				71	62		1	76 947	
<i>Gonyaulax spp.</i>		A	sphere- 25%	1	cell: 20-25					22		1	4 179	

	Trophy	Geometric shape	Size class No	Cell size range, μm	Length, μm		Width μm	Height μm	Diameter, μm		Number of cells/ counting unit	Calculated volume, μm^3	Comment
					l ₁	l ₂	w	h	d ₁	d ₂			
<i>Gonyaulax</i> spp.		A sphere-25%	2	cell: 25-35					30		1	10 598	
<i>Gonyaulax</i> spp.		A sphere-25%	3	cell: 35-45					40		1	25 120	
<i>Gonyaulax</i> spp.		A sphere-25%	4	cell: 45-55					50		1	49 063	
<i>Lingulodinium polyedrum</i>	(Stein) Dodge 1989	A rotational ellipsoid	1	cell: 30x30				30	30		1	14 130	
<i>Lingulodinium polyedrum</i>	(Stein) Dodge 1989	A rotational ellipsoid	2	cell: 34x38				38	34		1	22 989	
<i>Lingulodinium polyedrum</i>	(Stein) Dodge 1989	A rotational ellipsoid	3	cell: 37x44				44	37		1	31 524	
<i>Lingulodinium polyedrum</i>	(Stein) Dodge 1989	A rotational ellipsoid	4	cell: 41x50				50	41		1	43 986	
<i>Peridiniella catenata</i>	(Levander) Balech 1977	A half sphere	1	cell: 20-23					22		1	2 786	
<i>Peridiniella catenata</i>	(Levander) Balech 1977	A half sphere	2	cell: 24-26					25		1	4 089	
<i>Peridiniella catenata</i>	(Levander) Balech 1977	A half sphere	3	cell: 27-30					28		1	5 744	
<i>Peridiniella catenata</i>	(Levander) Balech 1977	A half sphere	4	cell: 31-35					33		1	9 404	
<i>Peridiniella catenata</i>	(Levander) Balech 1977	A half sphere	5	cell: 36-40					38		1	14 358	
<i>Protoceratium reticulatum</i>	(Claparède & Lachmann) Bütschli 1885	A sphere-10%	1	cell: 23					23		1	5 731	
<i>Protoceratium reticulatum</i>	(Claparède & Lachmann) Bütschli 1885	A sphere-10%	2	cell: 30					30		1	12 717	
<i>Protoceratium reticulatum</i>	(Claparède & Lachmann) Bütschli 1885	A sphere-10%	3	cell: 34-35					34.5		1	19 341	
<i>Pyrophacus horologicum</i>	Stein 1883	A flattened ellipsoid-20%	1	cell: 60-70	32				65	60	1	52 250	
<i>Pyrophacus horologicum</i>	Stein 1883	A flattened ellipsoid-20%	2	cell: 70-80	37				75	70	1	81 326	

		Trophy	Geometric shape	Size class No	Cell size range, μm	Length, μm		Width μm	Height μm	Diameter, μm		Number of cells/ counting unit	Calculated volume, μm^3	Comment
						l ₁	l ₂	w	h	d ₁	d ₂			
<i>Pyrophacus horologicum</i>	Stein 1883	A	flattened ellipsoid-20%	3	cell: 80-90	42				85	80	1	119 571	
<i>Dinophyceae</i> cysts			sphere	1	cell: <10					10		1	523	
<i>Dinophyceae</i> cysts			sphere	2	cell: 10-15					12.5		1	1 022	
<i>Dinophyceae</i> cysts			sphere	3	cell: 15-20					17.5		1	2 805	
<i>Dinophyceae</i> cysts			sphere	4	cell: 20-25					22.5		1	5 961	
<i>Dinophyceae</i> cysts			sphere	5	cell: 25-30					27.5		1	10 884	
<i>Dinophyceae</i> cysts			sphere	6	cell: 40					40		1	33 493	
<i>Dinophyceae</i> cysts			sphere	7	cell: 45					45		1	47 689	
<i>Dinophyceae</i> cysts			sphere	8	cell: 50					50		1	65 417	
Division HAPTOPHYTA														
Class Prymnesiophyceae (Haptophyceae)														
Order PRYMNESIALES														
<i>Acanthoica quattropsina</i>	Lohmann 1903	M	rotational ellipsoid		cell: 7-8x14				14	7.5		1	412	
<i>Chrysochromulina hirta</i>	Manton 1978	M	sphere		cell: 7					7		1	180	
<i>Chrysochromulina polylepis</i>	Manton & Parke 1962	M	flattened ellipsoid	1	cell: 7-10	8				6.3	5	1	133	
<i>Chrysochromulina polylepis</i>	Manton & Parke 1962	M	flattened ellipsoid	2	cell: 10-13	11				7	6	1	242	
<i>Chrysochromulina polylepis</i>	Manton & Parke 1962	M	flattened ellipsoid	3	cell: 13-16	15				8	7	1	440	
<i>Chrysochromulina</i> spp.		M	sphere	1	cell: 2-4					3		1	14	
<i>Chrysochromulina</i> spp.		M	sphere	2	cell: 4-6					5		1	65	
<i>Chrysochromulina</i> spp.		M	flattened ellipsoid	3	cell: 4-6	5				5	2.7	1	35	
<i>Chrysochromulina</i> spp.		M	flattened ellipsoid	4	cell: 6-10	8				6.3	5	1	132	
<i>Chrysochromulina</i> spp.		M	flattened ellipsoid	5	cell: 10-15	12				9	8	1	452	
<i>Emiliana huxleyi</i>	(Lohmann) Hay & Mohler 1967	A	sphere	1	cell: 2-4					3		1	14	
<i>Emiliana huxleyi</i>	(Lohmann) Hay & Mohler 1967	A	sphere	2	cell: 4-6					5		1	65	

		Trophy	Geometric shape	Size class No	Cell size range, μm	Length, μm		Width μm	Height μm	Diameter, μm		Number of cells/ counting unit	Calculated volume, μm^3	Comment
						l ₁	l ₂	w	h	d ₁	d ₂			
<i>Phaeocystis globosa</i>	Scherffel 1899	A	sphere-10%		cell: 6					6		1	102	*
<i>Phaeocystis pouchetii</i>	(Hariot) Lagerheim 1893	A	sphere	1	cell: 4-6					5		1	65	
<i>Phaeocystis pouchetii</i>	(Hariot) Lagerheim 1893	A	sphere	2	cell: 7-9					8		1	268	
<i>Phaeocystis spp.</i>		A	sphere		cell: 4-5					4.5		1	48	
<i>Pleurochrysis carterae</i>	(Braarud & Fagerland) Christensen 1978	A	sphere		cell: 10-12					11.2		1	735	
<i>Pleurochrysis spp.</i>		A	sphere		cell: 10-12					11.2		1	735	
<i>Prymnesium spp.</i>		M	rotational ellipsoid		cell: 10-12				11	8		1	368	
Order PAVLOVALES														
<i>Pavlova spp.</i>		A	flattened ellipsoid		cell: 7-9	8				6	4	1	88	
Division CHRYSOPHYTA (HETEROKONTOPHYTA)														
Class Chrysophyceae														
Order OCHROMONADALES														
<i>Dinobryon balticum</i>	(Schütt) Lemmermann 1901	M	rotational ellipsoid	1	cell: 2x10				10	2		1	21	
<i>Dinobryon balticum</i>	(Schütt) Lemmermann 1901	M	rotational ellipsoid	2	cell: 4-5x7-12				9.6	4.5		1	102	
<i>Dinobryon balticum</i>	(Schütt) Lemmermann 1901	M	rotational ellipsoid	3	cell: 6x12				12	6		1	226	
<i>Dinobryon bavaricum</i>	Imhof 1890	M	rotational ellipsoid		cell: 6x10-12				11.2	6		1	211	
<i>Dinobryon cylindricum</i>	Imhof 1890	M	rotational ellipsoid		cell: 5.6x8.4				8.4	5.6		1	138	
<i>Dinobryon divergens</i>	Imhof 1890	M	rotational ellipsoid	1	cell: 4x7				7	4		1	59	
<i>Dinobryon divergens</i>	Imhof 1890	M	rotational ellipsoid	2	cell: 7x14				14	7		1	359	

		Trophy	Geometric shape	Size class No	Cell size range, μm	Length, μm		Width μm	Height μm	Diameter, μm		Number of cells/ counting unit	Calculated volume, μm^3	Comment
						l ₁	l ₂	w	h	d ₁	d ₂			
<i>Dinobryon faculiferum</i>	(Willén) Willén 1992	M	rotational ellipsoid	1	cell: 3x7				7	3		1	33	
<i>Dinobryon faculiferum</i>	(Willén) Willén 1992	M	rotational ellipsoid	2	cell: 4x8				8	4		1	67	
<i>Dinobryon faculiferum</i>	(Willén) Willén 1992	M	rotational ellipsoid	3	cell: 5x7				7	5		1	92	
<i>Dinobryon spp.</i>		M	rotational ellipsoid	1	cell: 3x4				4	3		1	19	
<i>Dinobryon spp.</i>		M	rotational ellipsoid	2	cell: 4x5				5	4		1	42	
<i>Paraphysomonas spp.</i>		H	sphere	1	cell: 3-5					4		1	33	
<i>Paraphysomonas spp.</i>		H	sphere	2	cell: 5-10					7		1	180	
<i>Uroglena americana</i>	Calkins 1892	A	flattened ellipsoid		cell: 8-10	8.7				5	3	1	68	
<i>Uroglena spp.</i>		A	sphere		cell: 3-5					4		1	33	
Order PEDINELLALES														
<i>Apedinella radians</i>	(Lohmann) Campbell 1973	A	sphere	1	cell: 7-8					7.5		1	221	
<i>Apedinella radians</i>	(Lohmann) Campbell 1973	A	sphere	2	cell: 8-9					8.5		1	321	
<i>Apedinella radians</i>	(Lohmann) Campbell 1973	A	sphere	3	cell: 9-10					9.5		1	449	
<i>Apedinella radians</i>	(Lohmann) Campbell 1973	A	sphere	3	cell: 10-11					10.5		1	606	
<i>Pseudopedinella elastica</i>	Skuja 1948	A	sphere	1	cell: 10					10		1	523	
<i>Pseudopedinella elastica</i>	Skuja 1948	A	sphere	2	cell: 12					12		1	904	
<i>Pseudopedinella pyriforme</i>	N. Carter 1937	A	sphere	1	cell: 6					6		1	113	
<i>Pseudopedinella pyriforme</i>	N. Carter 1937	A	sphere	2	cell: 8					8		1	268	
<i>Pseudopedinella tricostata</i>	(Rouchijajnen) Thomsen 1988	A	sphere	1	cell: 4					4		1	33	
<i>Pseudopedinella tricostata</i>	(Rouchijajnen) Thomsen 1988	A	sphere	2	cell: 5					5		1	65	
<i>Pseudopedinella tricostata</i>	(Rouchijajnen) Thomsen 1988	A	sphere	3	cell: 6					6		1	113	
<i>Pseudopedinella spp.</i>		A	sphere	1	cell: 4					4		1	33	
<i>Pseudopedinella spp.</i>		A	sphere	2	cell: 6					6		1	113	
<i>Pseudopedinella spp.</i>		A	sphere	3	cell: 8					8		1	268	
<i>Pseudopedinella spp.</i>		A	sphere	4	cell: 10					10		1	523	

	Trophy	Geometric shape	Size class No	Cell size range, μm	Length, μm		Width μm	Height μm	Diameter, μm		Number of cells/ counting unit	Calculated volume, μm^3	Comment
					l ₁	l ₂	w	h	d ₁	d ₂			
<i>Pseudopedinella</i> spp.	A	sphere	5	cell: 12					12		1	904	
Class Dicyochophyceae													
Order DICTYOCHEALES													
<i>Dictyocha speculum</i>	Ehrenberg 1839	A	half sphere	cell: 20					20		1	2 093	
Class Synurophyceae													
Order SYNURALES													
<i>Mallomonas acaroides</i>	Ruttner <i>in</i> Pascher 1913	A	flattened ellipsoid	cell: 15-20x10-13	16.8				12.2	10	1	1 073	
<i>Mallomonas akrokomos</i>	Ruttner <i>in</i> Pascher 1913	A	cone	cell: 20-22x6-7				21	6.5		1	232	
<i>Mallomonas caudata</i>	Iwanoff 1899 emend. W. Krieger 1930	A	cone + half sphere	cell: 40-45x20-25				42	22		1	6 712	
<i>Synura uvella</i>	Ehrenberg <i>emend.</i> Korshikov 1929	A	cone + half sphere	cell: 8x10				10	8.4		1	262	
<i>Synura uvella</i>	Ehrenberg <i>emend.</i> Korshikov 1929	A	cone + half sphere	cell: 15x15				15	15		1	1 325	
<i>Synura</i> spp.		A	cone + half sphere	cell: 8x5				8	5		1	69	
Class Diatomophyceae (Bacillariophyceae)													
Order EUPODISCALES (BIDDULPHIALES, CENTRALES)													
<i>Actinocyclus normanii</i> f. <i>normanii</i>	(Gregory <i>in</i> Greville) Hustedt 1957	A	cylinder	cell: 22-27				25	25		1	12 266	6
<i>Actinocyclus normanii</i> f. <i>normanii</i>	(Gregory <i>in</i> Greville) Hustedt 1957	A	cylinder	cell: 28-32				28	30		1	19 782	6
<i>Actinocyclus normanii</i> f. <i>normanii</i>	(Gregory <i>in</i> Greville) Hustedt 1957	A	cylinder	cell: 33-37				29	35		1	27 887	6
<i>Actinocyclus normanii</i> f. <i>normanii</i>	(Gregory <i>in</i> Greville) Hustedt 1957	A	cylinder	cell: 38-42				35	40		1	43 960	6
<i>Actinocyclus normanii</i> f. <i>normanii</i>	(Gregory <i>in</i> Greville) Hustedt 1957	A	cylinder	cell: 43-47				30	45		1	47 689	6

	Trophy	Geometric shape	Size class No	Cell size range, μm	Length, μm		Width μm	Height μm	Diameter, μm		Number of cells/ counting unit	Calculated volume, μm^3	Comment	
					l ₁	l ₂	w	h	d ₁	d ₂				
<i>Actinocyclus normanii</i> f. <i>normanii</i>	(Gregory in Greville) Hustedt 1957	A	cylinder	6	cell: 48-52				42	50		1	82 425	6
<i>Actinocyclus normanii</i> f. <i>subsalsus</i>	(Juhlin-Dannfelt) Hustedt 1957	A	cylinder	1	cell: 18-22				22	20		1	6 908	6
<i>Actinocyclus normanii</i> f. <i>subsalsus</i>	(Juhlin-Dannfelt) Hustedt 1957	A	cylinder	2	cell: 22-27				25	25		1	12 266	6
<i>Actinocyclus normanii</i> f. <i>subsalsus</i>	(Juhlin-Dannfelt) Hustedt 1957	A	cylinder	3	cell: 28-32				28	30		1	19 782	6
<i>Actinocyclus normanii</i> f. <i>subsalsus</i>	(Juhlin-Dannfelt) Hustedt 1957	A	cylinder	4	cell: 33-37				26	35		1	25 002	6
<i>Actinocyclus normanii</i> f. <i>subsalsus</i>	(Juhlin-Dannfelt) Hustedt 1957	A	cylinder	5	cell: 38-42				35	40		1	43 960	6
<i>Actinocyclus normanii</i> f. <i>subsalsus</i>	(Juhlin-Dannfelt) Hustedt 1957	A	cylinder	6	cell: 43-47				32	45		1	50 868	6
<i>Actinocyclus octonarius</i> v. <i>octonarius</i>	Ehrenberg 1838	A	cylinder	1	cell: 22-27				23.75	25		1	11 652	6
<i>Actinocyclus octonarius</i> v. <i>octonarius</i>	Ehrenberg 1838	A	cylinder	2	cell: 28-32				29	30		1	20 489	6
<i>Actinocyclus octonarius</i> v. <i>octonarius</i>	Ehrenberg 1838	A	cylinder	3	cell: 33-37				33.25	35		1	31 974	6
<i>Actinocyclus octonarius</i> v. <i>octonarius</i>	Ehrenberg 1838	A	cylinder	4	cell: 38-42				38	40		1	47 728	6
<i>Actinocyclus octonarius</i> v. <i>octonarius</i>	Ehrenberg 1838	A	cylinder	5	cell: 43-50				42.75	45		1	67 956	6
<i>Actinocyclus octonarius</i> v. <i>octonarius</i>	Ehrenberg 1838	A	cylinder	6	cell: 50-60				35.75	55		1	84 893	6
<i>Actinocyclus octonarius</i> v. <i>octonarius</i>	Ehrenberg 1838	A	cylinder	7	cell: 60-70				42.25	65		1	140 127	6
<i>Actinocyclus octonarius</i> v. <i>octonarius</i>	Ehrenberg 1838	A	cylinder	8	cell: 70-90				52	80		1	261 248	6
<i>Actinocyclus octonarius</i> v. <i>octonarius</i>	Ehrenberg 1838	A	cylinder	9	cell: 90-110				65	100		1	510 250	6
<i>Actinocyclus octonarius</i> v. <i>octonarius</i>	Ehrenberg 1838	A	cylinder	10	cell: 110-130				65	120		1	734 760	6
<i>Actinocyclus octonarius</i> v. <i>octonarius</i>	Ehrenberg 1838	A	cylinder	11	cell: 130-150				91	140		1	1 400 126	6
<i>Actinocyclus octonarius</i> v. <i>crassus</i>	(W. Smith) Hendey 1954	A	cylinder	1	cell: 18-22				25	20		1	7 850	6
<i>Actinocyclus octonarius</i> v. <i>crassus</i>	(W. Smith) Hendey 1954	A	cylinder	2	cell: 22-27				28	25		1	13 738	6

	Trophy	Geometric shape	Size class No	Cell size range, μm	Length, μm		Width μm	Height μm	Diameter, μm		Number of cells/ counting unit	Calculated volume, μm^3	Comment	
					l ₁	l ₂	w	h	d ₁	d ₂				
<i>Actinocyclus octonarius</i> v. <i>crassus</i>	(W. Smith) Hende y 1954	A	cylinder	3	cell: 28-32				32	30		1	22 608	6
<i>Actinocyclus octonarius</i> v. <i>crassus</i>	(W. Smith) Hende y 1954	A	cylinder	4	cell: 33-37				38	35		1	36 542	6
<i>Actinocyclus octonarius</i> v. <i>crassus</i>	(W. Smith) Hende y 1954	A	cylinder	5	cell: 38-42				45	40		1	56 520	6
<i>Actinocyclus octonarius</i> v. <i>crassus</i>	(W. Smith) Hende y 1954	A	cylinder	6	cell: 43-47				48	45		1	76 302	6
<i>Actinocyclus octonarius</i> v. <i>crassus</i>	(W. Smith) Hende y 1954	A	cylinder	7	cell: 48-52				50	50		1	98 125	6
<i>Actinocyclus octonarius</i> v. <i>tenellus</i>	(Brébisson) Hende y 1954	A	cylinder	1	cell: 15-20				22.4	16.8		1	4 963	6
<i>Actinocyclus octonarius</i> v. <i>tenellus</i>	(Brébisson) Hende y 1954	A	cylinder	2	cell: 21-23				22	22		1	8 359	6
<i>Actinocyclus octonarius</i> v. <i>tenellus</i>	(Brébisson) Hende y 1954	A	cylinder	3	cell: 24-27				30	25		1	14 719	6
<i>Actinocyclus octonarius</i> v. <i>tenellus</i>	(Brébisson) Hende y 1954	A	cylinder	4	cell: 28-32				31	31		1	23 386	6
<i>Actinocyclus octonarius</i> v. <i>tenellus</i>	(Brébisson) Hende y 1954	A	cylinder	5	cell: 33-40				36	36		1	36 625	6
<i>Actinocyclus</i> spp.		A	cylinder	1	cell: 18-22				20	20		1	6 280	6
<i>Actinocyclus</i> spp.		A	cylinder	2	cell: 22-27				23.75	25		1	11 652	6
<i>Actinocyclus</i> spp.		A	cylinder	3	cell: 28-32				29	30		1	20 489	6
<i>Actinocyclus</i> spp.		A	cylinder	4	cell: 33-37				33.25	35		1	31 974	6
<i>Actinocyclus</i> spp.		A	cylinder	5	cell: 38-42				38	40		1	47 728	6
<i>Actinocyclus</i> spp.		A	cylinder	6	cell: 43-50				42.75	45		1	67 956	6
<i>Actinocyclus</i> spp.		A	cylinder	7	cell: 50-60				35.75	55		1	84 893	6
<i>Actinocyclus</i> spp.		A	cylinder	8	cell: 60-70				42.25	65		1	140 127	6
<i>Actinocyclus</i> spp.		A	cylinder	9	cell: 70-90				52	80		1	261 248	6
<i>Actinocyclus</i> spp.		A	cylinder	10	cell: 90-110				65	100		1	510 250	6
<i>Actinoptychus senarius</i>	(Ehrenberg) Ehrenberg 1843	A	cylinder		cell: 30-40				25	35		1	24 041	
<i>Attheya decora</i>	T. West 1860	A	oval cylinder	1	cell: 14x18				18	14	4	1	791	
<i>Attheya decora</i>	T. West 1860	A	oval cylinder	2	cell: 16x20				20	16	4	1	1 005	
<i>Attheya decora</i>	T. West 1860	A	oval cylinder	3	cell: 20x20				20	20	4	1	1 256	
<i>Attheya decora</i>	T. West 1860	A	oval cylinder	4	cell: 20x28				28	20	5	1	2 198	

		Trophy	Geometric shape	Size class No	Cell size range, μm	Length, μm		Width μm	Height μm	Diameter, μm		Number of cells/ counting unit	Calculated volume, μm^3	Comment
						l ₁	l ₂	w	h	d ₁	d ₂			
<i>Attheya decora</i>	T. West 1860	A	oval cylinder	5	cell: 20x31				31	20	14	1	6 814	
<i>Attheya longicornis</i>	Crawford & Gardner 1994	A	oval cylinder		cell: 7-8x4-5				8	4	4	1	100	*
<i>Attheya septentrionalis</i>	(Østrup) Crawford in Crawford, Gardner & Medlin 1994	A	oval cylinder		cell: 7-8x4-5				8	4	4	1	100	
<i>Aulacoseira granulata</i> v. <i>granulata</i>	(Ehrenberg) Simonsen 1979	A	cylinder	1	cell: 4x22				22.4	4		1	281	
<i>Aulacoseira granulata</i> v. <i>granulata</i>	(Ehrenberg) Simonsen 1979	A	cylinder	2	cell: 8x28				28	8		1	1 407	
<i>Aulacoseira granulata</i> v. <i>angustissima</i>	(O. Müller) Simonsen 1979	A	cylinder	1	cell: 3.5x25				25	3.5		1	240	
<i>Aulacoseira granulata</i> v. <i>angustissima</i>	(O. Müller) Simonsen 1979	A	cylinder	2	cell: 5x22				22.4	5		1	440	
<i>Aulacoseira granulata</i> v. <i>angustissima</i>	(O. Müller) Simonsen 1979	A	cylinder	3	cell: 5x28				28	5		1	550	
<i>Aulacoseira granulata</i> v. <i>angustissima</i>	(O. Müller) Simonsen 1979	A	cylinder	4	cell: 5x38				37.8	5		1	742	
<i>Aulacoseira islandica</i> ssp. <i>islandica</i>	(Ehrenberg) Simonsen 1979	A	cylinder	1	cell: 6x12				12	6		1	339	
<i>Aulacoseira islandica</i> ssp. <i>islandica</i>	(Ehrenberg) Simonsen 1979	A	cylinder	2	cell: 8x11				11.4	8.4		1	631	
<i>Aulacoseira islandica</i> ssp. <i>islandica</i>	(Ehrenberg) Simonsen 1979	A	cylinder	3	cell: 10x22				22.4	9.8		1	1 689	
<i>Aulacoseira islandica</i> ssp. <i>islandica</i>	(Ehrenberg) Simonsen 1979	A	cylinder	4	cell: 14x22				22.4	14		1	3 446	
<i>Aulacoseira islandica</i> ssp. <i>islandica</i>	(Ehrenberg) Simonsen 1979	A	cylinder	5	cell: 19x22				22.4	19.6		1	6 755	
<i>Aulacoseira islandica</i> ssp. <i>helvetica</i>	(O. Müller) Simonsen 1979	A	cylinder	1	cell: 6x12				12	6		1	339	
<i>Aulacoseira islandica</i> ssp. <i>helvetica</i>	(O. Müller) Simonsen 1979	A	cylinder	2	cell: 7x20				19.6	7		1	754	
<i>Aulacoseira italica</i>	(Ehrenberg) Simonsen 1979	A	cylinder	1	cell: 6x23				23.2	5.6		1	571	
<i>Aulacoseira italica</i>	(Ehrenberg) Simonsen 1979	A	cylinder	2	cell: 11x28				28	11.2		1	2 757	
<i>Cerataulina pelagica</i>	(P.T. Cleve) Hendey 1937	A	cylinder	1	cell: 5x45-50				47.5	5		1	932	
<i>Cerataulina pelagica</i>	(P.T. Cleve) Hendey 1937	A	cylinder	2	cell: 10x30-40				35	10		1	2 748	
<i>Cerataulina pelagica</i>	(P.T. Cleve) Hendey 1937	A	cylinder	3	cell: 10x70-80				75	10		1	5 888	
<i>Cerataulina pelagica</i>	(P.T. Cleve) Hendey 1937	A	cylinder	4	cell: 15-17x35-50				42.5	16		1	8 541	
<i>Cerataulina pelagica</i>	(P.T. Cleve) Hendey 1937	A	cylinder	5	cell: 15x60-70				65	15		1	11 481	

	Trophy	Geometric shape	Size class No	Cell size range, μm	Length, μm		Width μm	Height μm	Diameter, μm		Number of cells/ counting unit	Calculated volume, μm^3	Comment	
					l ₁	l ₂	w	h	d ₁	d ₂				
<i>Cerataulina pelagica</i>	(P.T. Cleve) Hende y 1937	A	cylinder	6	cell: 15-16x100				100	15.5		1	18 860	
<i>Cerataulina pelagica</i>	(P.T. Cleve) Hende y 1937	A	cylinder	7	cell: 20x40-60				50	20		1	15 700	
<i>Cerataulina pelagica</i>	(P.T. Cleve) Hende y 1937	A	cylinder	8	cell: 20-21x70-80				79	20.5		1	26 062	
<i>Cerataulina pelagica</i>	(P.T. Cleve) Hende y 1937	A	cylinder	9	cell: 20x100				100	20		1	31 400	
<i>Cerataulina pelagica</i>	(P.T. Cleve) Hende y 1937	A	cylinder	10	cell: 21-22x110-130				120	21.5		1	43 544	
<i>Cerataulina pelagica</i>	(P.T. Cleve) Hende y 1937	A	cylinder	11	cell: 26-28x80-90				85	27		1	48 643	
<i>Cerataulina pelagica</i>	(P.T. Cleve) Hende y 1937	A	cylinder	12	cell: 30x40-50				45	30		1	31 793	
<i>Cerataulina pelagica</i>	(P.T. Cleve) Hende y 1937	A	cylinder	13	cell: 30x60-80				70	30		1	49 455	
<i>Cerataulina pelagica</i>	(P.T. Cleve) Hende y 1937	A	cylinder	14	cell: 40x40-50				45	40		1	56 520	
<i>Cerataulina pelagica</i>	(P.T. Cleve) Hende y 1937	A	cylinder	15	cell: 40x60-80				70	40		1	87 920	
<i>Cerataulina pelagica</i>	(P.T. Cleve) Hende y 1937	A	cylinder	16	cell: 40x90-100				95	40		1	119 320	
<i>Chaetoceros affinis</i>	Lauder 1864	A	oval cylinder	1	cell: 8x20				20	8	8	1	1 005	
<i>Chaetoceros affinis</i>	Lauder 1864	A	oval cylinder	2	cell: 12-15x15-18				16.5	13.5	11	1	1 923	
<i>Chaetoceros affinis</i>	Lauder 1864	A	oval cylinder	3	cell: 15x25				25	15	10	1	2 944	
<i>Chaetoceros anastomosans v. externa</i>	(Gran) Hustedt 1930	A	oval cylinder		cell: 9x16				16	9	6	1	678	
<i>Chaetoceros borealis</i>	J.W. Bailey 1854	A	oval cylinder	1	cell: 8-12x19				19	11	9	1	1 534	HD fac.=0.85
<i>Chaetoceros borealis</i>	J.W. Bailey 1854	A	oval cylinder	2	cell: 13-16x30				30	15	13	1	4 504	HD fac.=0.85
<i>Chaetoceros borealis</i>	J.W. Bailey 1854	A	oval cylinder	3	cell: 17-20x26				26	18	15	1	5 621	HD fac.=0.85
<i>Chaetoceros borealis</i>	J.W. Bailey 1854	A	oval cylinder	4	cell: 21-24x22				22	22	19	1	7 105	HD fac.=0.85
<i>Chaetoceros borealis</i>	J.W. Bailey 1854	A	oval cylinder	5	cell: 25-28x26				26	26	22	1	11 728	HD fac.=0.85
<i>Chaetoceros borealis</i>	J.W. Bailey 1854	A	oval cylinder	6	cell: 29-32x30				28	30	26	1	16 815	HD fac.=0.85
<i>Chaetoceros brevis</i>	Schütt 1895	A	oval cylinder	1	cell: 18-22x8				8	22	18	1	2 487	
<i>Chaetoceros brevis</i>	Schütt 1895	A	oval cylinder	2	cell: 18-22x11				11	22	18	1	3 419	
<i>Chaetoceros brevis</i>	Schütt 1895	A	oval cylinder	3	cell: 18-22x14				14	22	18	1	4 352	

		Trophy	Geometric shape	Size class No	Cell size range, μm	Length, μm		Width μm	Height μm	Diameter, μm		Number of cells/ counting unit	Calculated volume, μm^3	Comment
						l ₁	l ₂	w	h	d ₁	d ₂			
<i>Chaetoceros brevis</i>	Schütt 1895	A	oval cylinder	4	cell: 18-22x16				16	22	18	1	4 974	
<i>Chaetoceros brevis</i>	Schütt 1895	A	oval cylinder	5	cell: 18-22x19				19	22	18	1	5 906	
<i>Chaetoceros calcitrans</i>	(Paulsen) Takano 1968	A	oval cylinder	1	cell: 3x3				3	3	3	1	20	
<i>Chaetoceros calcitrans</i>	(Paulsen) Takano 1968	A	oval cylinder	2	cell: 5x8				8	5	5	1	157	
<i>Chaetoceros calcitrans</i>	(Paulsen) Takano 1968	A	oval cylinder	3	cell: 7x8				8	7	5	1	220	
<i>Chaetoceros calcitrans</i>	(Paulsen) Takano 1968	A	oval cylinder	4	cell: 9x9				9	9	6	1	356	
<i>Chaetoceros ceratosporus</i> v. <i>ceratosporus</i>	Ostenfeld 1910	A	oval cylinder	1	cell: 5x3-5				4	5	4	1	67	HD fac.=0.85
<i>Chaetoceros ceratosporus</i> v. <i>ceratosporus</i>	Ostenfeld 1910	A	oval cylinder	2	cell: 6-7x9-11				10	6.5	6	1	282	HD fac.=0.85
<i>Chaetoceros ceratosporus</i> v. <i>ceratosporus</i>	Ostenfeld 1910	A	oval cylinder	3	cell: 7x13				13	7	6	1	425	HD fac.=0.85
<i>Chaetoceros ceratosporus</i> v. <i>ceratosporus</i>	Ostenfeld 1910	A	oval cylinder	4	cell: 11x14				14	11	10	1	1 185	HD fac.=0.7
<i>Chaetoceros compressus</i>	Lauder 1864	A	oval cylinder	1	cell: 5x5				5	5	4	1	83	HD fac.=0.85
<i>Chaetoceros compressus</i>	Lauder 1864	A	oval cylinder	2	cell: 6-7x11-15				13	6.5	6	1	366	HD fac.=0.85
<i>Chaetoceros compressus</i>	Lauder 1864	A	oval cylinder	3	cell: 8x8				8	8	7	1	342	HD fac.=0.85
<i>Chaetoceros compressus</i>	Lauder 1864	A	oval cylinder	4	cell: 10x14				14	10	9	1	934	HD fac.=0.85
<i>Chaetoceros constrictus</i>	Gran 1897	A	oval cylinder	1	cell: 14-15x15				15	15	14	1	2 473	
<i>Chaetoceros constrictus</i>	Gran 1897	A	oval cylinder	2	cell: 16x16				16	16	16	1	3 215	
<i>Chaetoceros constrictus</i>	Gran 1897	A	oval cylinder	3	cell: 14-19x19				19	19	14	1	3 967	
<i>Chaetoceros constrictus</i>	Gran 1897	A	oval cylinder	4	cell: 15-30x30				30	30	15	1	10 598	
<i>Chaetoceros contortus</i>	Schütt 1895	A	oval cylinder	1	cell: 7-12x12				12	12	7	1	791	
<i>Chaetoceros contortus</i>	Schütt 1895	A	oval cylinder	2	cell: 6-9x12				12	9	6	1	509	

		Trophy	Geometric shape	Size class No	Cell size range, μm	Length, μm		Width μm	Height μm	Diameter, μm		Number of cells/ counting unit	Calculated volume, μm^3	Comment
						l ₁	l ₂	w	h	d ₁	d ₂			
<i>Chaetoceros contortus</i>	Schütt 1895	A	oval cylinder	3	cell: 7-14x19				19	14	7	1	1 462	
<i>Chaetoceros convolutus</i>	Castracane 1886	A	oval cylinder	1	cell: 16x19				19	16	16	1	3 818	
<i>Chaetoceros convolutus</i>	Castracane 1886	A	oval cylinder	2	cell: 20x41				41	20	20	1	12 874	
<i>Chaetoceros crinitus</i>	Schütt 1895	A	oval cylinder	1	cell: 8x22				22	8	8	1	1 105	
<i>Chaetoceros crinitus</i>	Schütt 1895	A	oval cylinder	2	cell: 6x6				6	6	6	1	170	
<i>Chaetoceros curvisetus</i>	P.T. Cleve 1889	A	oval cylinder	1	cell: 15				15	15	8	1	1 325	HD fac.=0.5
<i>Chaetoceros curvisetus</i>	P.T. Cleve 1889	A	oval cylinder	2	cell: 25				16	25	13	1	3 925	HD fac.=0.5
<i>Chaetoceros curvisetus</i>	P.T. Cleve 1889	A	oval cylinder	3	cell: 30				20	30	15	1	7 065	HD fac.=0.5
<i>Chaetoceros danicus</i>	P.T.Cleve 1889	A	oval cylinder	1	cell: 10x11				11.2	9.8	7	1	633	HD fac.=0.75
<i>Chaetoceros danicus</i>	P.T.Cleve 1889	A	oval cylinder	2	cell: 15-16x12-17				14.5	15.5	12	1	2 051	HD fac.=0.75
<i>Chaetoceros danicus</i>	P.T.Cleve 1889	A	oval cylinder	3	cell: 17-18x11-13				12	17.5	13	1	2 164	HD fac.=0.75
<i>Chaetoceros danicus</i>	P.T.Cleve 1889	A	oval cylinder	4	cell: 17-18x15-16				16.5	17	13	1	2 807	HD fac.=0.75
<i>Chaetoceros danicus</i>	P.T.Cleve 1889	A	oval cylinder	5	cell: 17-18x19-23				22.4	17	13	1	3 811	HD fac.=0.75
<i>Chaetoceros danicus</i>	P.T.Cleve 1889	A	oval cylinder	6	cell: 20x14-17				15.5	20	15	1	3 650	HD fac.=0.75
<i>Chaetoceros danicus</i>	P.T.Cleve 1889	A	oval cylinder	7	cell: 20x22-26				24	20	15	1	5 652	HD fac.=0.75
<i>Chaetoceros danicus</i>	P.T.Cleve 1889	A	oval cylinder	8	cell: 22-23x16-17				16.5	22.5	17	1	4 918	HD fac.=0.75
<i>Chaetoceros danicus</i>	P.T.Cleve 1889	A	oval cylinder	9	cell: 25x20				20	25	19	1	7 359	HD fac.=0.75
<i>Chaetoceros debilis</i>	P.T. Cleve 1894	A	oval cylinder	1	cell: 12.5-15x7				7	15	11	1	927	HD fac.=0.75
<i>Chaetoceros debilis</i>	P.T. Cleve 1894	A	oval cylinder	2	cell: 11-17.5x15				10	17.5	13	1	1 803	HD fac.=0.75
<i>Chaetoceros debilis</i>	P.T. Cleve 1894	A	oval cylinder	3	cell: 15-20x15				15	20	15	1	3 533	HD fac.=0.75

		Trophy	Geometric shape	Size class No	Cell size range, μm	Length, μm		Width μm	Height μm	Diameter, μm		Number of cells/ counting unit	Calculated volume, μm^3	Comment
						l ₁	l ₂	w	h	d ₁	d ₂			
<i>Chaetoceros debilis</i>	P.T. Cleve 1894	A	oval cylinder	4	cell: 20x15				15	20	15	1	3 533	HD fac.=0.75
<i>Chaetoceros debilis</i>	P.T. Cleve 1894	A	oval cylinder	5	cell: 33x12				12	33	25	1	7 694	HD fac.=0.75
<i>Chaetoceros decipiens</i>	P.T. Cleve 1873	A	oval cylinder	1	cell: 10-15x11				11	15	10	1	1 295	
<i>Chaetoceros decipiens</i>	P.T. Cleve 1873	A	oval cylinder	2	cell: 16x21				21	16	16	1	4 220	
<i>Chaetoceros decipiens</i>	P.T. Cleve 1873	A	oval cylinder	3	cell: 21-27.5x16				16	27.5	21	1	7 253	
<i>Chaetoceros decipiens</i>	P.T. Cleve 1873	A	oval cylinder	4	cell: 30x19				19	30	30	1	13 424	
<i>Chaetoceros decipiens</i>	P.T. Cleve 1873	A	oval cylinder	5	cell: 30-70x22				22	70	30	1	36 267	
<i>Chaetoceros diadema</i>	(Ehrenberg) Gran 1897	A	oval cylinder	1	cell: 10-20x17				17	20	15	1	4 004	HD fac.=0.75
<i>Chaetoceros diadema</i>	(Ehrenberg) Gran 1897	A	oval cylinder	2	cell: 18-20x15				15	20	15	1	3 533	HD fac.=0.75
<i>Chaetoceros diadema</i>	(Ehrenberg) Gran 1897	A	oval cylinder	3	cell: 15-20x30				30	20	15	1	7 065	HD fac.=0.75
<i>Chaetoceros diadema</i>	(Ehrenberg) Gran 1897	A	oval cylinder	4	cell: 15-20x20				20	20	15	1	4 710	HD fac.=0.75
<i>Chaetoceros diadema</i>	(Ehrenberg) Gran 1897	A	oval cylinder	5	cell: 25-34x27				27	34	26	1	18 376	HD fac.=0.75
<i>Chaetoceros didymus v. didymus</i>	Ehrenberg 1845	A	oval cylinder	1	cell: 15-25x10-18				14	20	10	1	2 198	HD fac.=0.5
<i>Chaetoceros didymus v. didymus</i>	Ehrenberg 1845	A	oval cylinder	2	cell: 25-35x18-25				21.5	30	15	1	7 595	HD fac.=0.5
<i>Chaetoceros gracilis</i>	Schütt 1895	A	oval cylinder	1	cell: 5x6				6	3	2	1	34	HD fac.=0.8
<i>Chaetoceros gracilis</i>	Schütt 1895	A	oval cylinder	2	cell: 4x5				5	4	3	1	50	HD fac.=0.8
<i>Chaetoceros gracilis</i>	Schütt 1895	A	oval cylinder	3	cell: 5x7				7.25	5	4	1	114	HD fac.=0.8
<i>Chaetoceros gracilis</i>	Schütt 1895	A	oval cylinder	4	cell: 6x8				8	6	5	1	181	HD fac.=0.8
<i>Chaetoceros holsaticus</i>	Schütt 1895	A	oval cylinder	1	cell: 6x8				8	6	5	1	170	HD fac.=0.75
<i>Chaetoceros holsaticus</i>	Schütt 1895	A	oval cylinder	2	cell: 7-8x8				8	7.5	6	1	265	HD fac.=0.75

		Trophy	Geometric shape	Size class No	Cell size range, μm	Length, μm		Width μm	Height μm	Diameter, μm		Number of cells/ counting unit	Calculated volume, μm^3	Comment
						l ₁	l ₂	w	h	d ₁	d ₂			
<i>Chaetoceros holsaticus</i>	Schütt 1895	A	oval cylinder	3	cell: 8-9x8-12				10	8.5	6	1	425	HD fac.=0.75
<i>Chaetoceros holsaticus</i>	Schütt 1895	A	oval cylinder	4	cell: 10-12x9-12				10.5	11	8	1	748	HD fac.=0.75
<i>Chaetoceros holsaticus</i>	Schütt 1895	A	oval cylinder	5	cell: 13-14x10-12				11	13.5	10	1	1 180	HD fac.=0.75
<i>Chaetoceros holsaticus</i>	Schütt 1895	A	oval cylinder	6	cell: 15x10				10	15	11	1	1 325	HD fac.=0.75
<i>Chaetoceros impressus</i>	K.G. Jensen & Moestrup 1998	A	oval cylinder	1	cell: 16-18x12-13				12.5	17	13	1	2 127	HD fac.=0.75
<i>Chaetoceros impressus</i>	K.G. Jensen & Moestrup 1998	A	oval cylinder	2	cell: 16-18x20-22				21	16.8	13	1	3 722	HD fac.=0.8
<i>Chaetoceros impressus</i>	K.G. Jensen & Moestrup 1998	A	oval cylinder	3	cell: 18-20x18-20				19	18.5	15	1	4 084	HD fac.=0.8
<i>Chaetoceros impressus</i>	K.G. Jensen & Moestrup 1998	A	oval cylinder	4	cell: 20x23-27m				25	20	15	1	5 888	HD fac.=0.75
<i>Chaetoceros impressus</i>	K.G. Jensen & Moestrup 1998	A	oval cylinder	5	cell: 25x20				20	25	19	1	7 359	HD fac.=0.75
<i>Chaetoceros lacinosus</i>	Schütt 1895	A	oval cylinder	1	cell: 6-8x13-21				17	7	7	1	654	
<i>Chaetoceros lacinosus</i>	Schütt 1895	A	oval cylinder	2	cell: 9-13x13-21				18	11	10	1	1 554	
<i>Chaetoceros lacinosus</i>	Schütt 1895	A	oval cylinder	3	cell: 14-18x13-21				18	15	12	1	2 543	
<i>Chaetoceros lacinosus</i>	Schütt 1895	A	oval cylinder	4	cell: 18-20x16-28				21	19	13	1	4 072	
<i>Chaetoceros lauderi</i>	Ralfs in Lauder 1864	A	oval cylinder	1	cell: 15-17x28				28	16	9	1	3 165	
<i>Chaetoceros lauderi</i>	Ralfs in Lauder 1864	A	oval cylinder	2	cell: 17-19x32				32	18	9	1	4 069	
<i>Chaetoceros lauderi</i>	Ralfs in Lauder 1864	A	oval cylinder	3	cell: 20-22x44				44	21	12	1	8 704	
<i>Chaetoceros lorenzianus</i>	Grunow 1863	A	oval cylinder	1	cell: 12x34				34	12	9	1	2 883	
<i>Chaetoceros lorenzianus</i>	Grunow 1863	A	oval cylinder	2	cell: 24x48				48	24	14	1	12 660	
<i>Chaetoceros lorenzianus</i>	Grunow 1863	A	oval cylinder	3	cell: 30x30				30	30	19	1	13 424	
<i>Chaetoceros minimus</i>	(Levander) Marino, Giuffrè, Montresor & Zingone 1991	A	cylinder		cell: 4x22				21.5	3.8		1	244	

		Trophy	Geometric shape	Size class No	Cell size range, μm	Length, μm		Width μm	Height μm	Diameter, μm		Number of cells/ counting unit	Calculated volume, μm^3	Comment
						l ₁	l ₂	w	h	d ₁	d ₂			
<i>Chaetoceros muelleri</i>	Lemmermann 1898	A	oval cylinder		cell: 7x9				9	7	6	1	297	
<i>Chaetoceros seiracanthus</i>	Gran 1897	A	oval cylinder	1	cell: 6-8x9-11				10	7	6	1	330	
<i>Chaetoceros seriacanthus</i>	Gran 1897	A	oval cylinder	2	cell: 12-14x9-11				9	13	9	1	827	
<i>Chaetoceros seriacanthus</i>	Gran 1897	A	oval cylinder	3	cell: 15-16x9-11				10	15	11	1	1 295	
<i>Chaetoceros similis</i>	P.T. Cleve 1896	A	oval cylinder	1	cell: 9x10-12				11	9	6	1	490	HD fac.=0.7
<i>Chaetoceros similis</i>	P.T. Cleve 1896	A	oval cylinder	2	cell: 9x13-15				14	9	6	1	623	HD fac.=0.7
<i>Chaetoceros similis</i>	P.T. Cleve 1896	A	oval cylinder	3	cell: 9x15-17				16	9	6	1	712	HD fac.=0.7
<i>Chaetoceros similis</i>	P.T. Cleve 1896	A	oval cylinder	5	cell: 13-15x10-13				9.65	13.5	9	1	966	HD fac.=0.7
<i>Chaetoceros similis</i>	P.T. Cleve 1896	A	oval cylinder	6	cell: 15-17x15-20				17.5	16	11	1	2 462	HD fac.=0.7
<i>Chaetoceros similis</i>	P.T. Cleve 1896	A	oval cylinder	7	cell: 18-21x15-20				18	20	14	1	3 956	HD fac.=0.7
<i>Chaetoceros simplex</i>	Ostenfeld 1901	A	oval cylinder	1	cell: 8-9x8-9				8.5	8.5	7	1	410	HD fac.=0.85
<i>Chaetoceros simplex</i>	Ostenfeld 1901	A	oval cylinder	2	cell: 8-9x10-14				12	8.5	7	1	579	HD fac.=0.85
<i>Chaetoceros simplex</i>	Ostenfeld 1901	A	oval cylinder	3	cell: 8-9x15-16				15.5	8.5	7	1	747	HD fac.=0.85
<i>Chaetoceros simplex</i>	Ostenfeld 1901	A	oval cylinder	4	cell: 8-9x19-20				19.5	8.5	7	1	940	HD fac.=0.85
<i>Chaetoceros simplex</i>	Ostenfeld 1901	A	oval cylinder	5	cell: 10-12x10-11				10.5	11	9	1	848	HD fac.=0.85
<i>Chaetoceros simplex</i>	Ostenfeld 1901	A	oval cylinder	6	cell: 11-12x11-12				11.2	11.2	10	1	937	HD fac.=0.85
<i>Chaetoceros simplex</i>	Ostenfeld 1901	A	oval cylinder	7	cell: 11-13x14				14	12	10	1	1 345	HD fac.=0.85
<i>Chaetoceros simplex</i>	Ostenfeld 1901	A	oval cylinder	8	cell: 14-17x16-17				16.5	15.5	13	1	2 645	HD fac.=0.85
<i>Chaetoceros socialis</i> f. <i>socialis</i>	Proschkina-Lavrenko 1963	A	oval cylinder	1	cell: 5x5-6				5.5	5	3	1	54	HD fac.=0.5
<i>Chaetoceros socialis</i> f. <i>socialis</i>	Proschkina-Lavrenko 1963	A	oval cylinder	2	cell: 8x6-8				7	8	4	1	176	HD fac.=0.5

		Trophy	Geometric shape	Size class No	Cell size range, μm	Length, μm		Width μm	Height μm	Diameter, μm		Number of cells/ counting unit	Calculated volume, μm^3	Comment
						l ₁	l ₂	w	h	d ₁	d ₂			
<i>Chaetoceros socialis</i> f. <i>socialis</i>	Proschkina-Lavrenko 1963	A	oval cylinder	3	cell: 8x9-11				10	8	4	1	251	HD fac.=0.5
<i>Chaetoceros socialis</i> f. <i>socialis</i>	Proschkina-Lavrenko 1963	A	oval cylinder	4	cell: 10x8-10				8	10	5	1	314	HD fac.=0.5
<i>Chaetoceros socialis</i> f. <i>radians</i>	(Schütt) Proschkina-Lavrenko 1963	A	oval cylinder		cell: 5x5				5	5	3	1	49	HD fac.=0.5
<i>Chaetoceros subtilis</i> v. <i>subtilis</i>	Cleve 1896	A	oval cylinder	1	cell: 2.4x4.5				4.5	2.4	2	1	17	HD fac.=0.85
<i>Chaetoceros subtilis</i> v. <i>subtilis</i>	Cleve 1896	A	oval cylinder	2	cell: 3x8-17				12.5	3	3	1	75	HD fac.=0.85
<i>Chaetoceros subtilis</i> v. <i>subtilis</i>	Cleve 1896	A	oval cylinder	3	cell: 3x18-22				20	3	3	1	120	HD fac.=0.85
<i>Chaetoceros subtilis</i> v. <i>subtilis</i>	Cleve 1896	A	oval cylinder	4	cell: 4x8-17				12.5	4	3	1	133	HD fac.=0.85
<i>Chaetoceros subtilis</i> v. <i>subtilis</i>	Cleve 1896	A	oval cylinder	5	cell: 4x18-25				21.5	4	3	1	230	HD fac.=0.85
<i>Chaetoceros subtilis</i> v. <i>subtilis</i>	Cleve 1896	A	oval cylinder	6	cell: 5x5				5	5	4	1	83	HD fac.=0.85
<i>Chaetoceros subtilis</i> v. <i>subtilis</i>	Cleve 1896	A	oval cylinder	7	cell: 5x8-17				12.5	5	4	1	209	HD fac.=0.85
<i>Chaetoceros subtilis</i> v. <i>subtilis</i>	Cleve 1896	A	oval cylinder	8	cell: 5x18-22				20	5	4	1	334	HD fac.=0.85
<i>Chaetoceros subtilis</i> v. <i>subtilis</i>	Cleve 1896	A	oval cylinder	9	cell: 6x10-17				13.5	6	5	1	324	HD fac.=0.85
<i>Chaetoceros subtilis</i> v. <i>subtilis</i>	Cleve 1896	A	oval cylinder	10	cell: 6x17-20				18.5	6	5	1	444	HD fac.=0.85
<i>Chaetoceros subtilis</i> v. <i>subtilis</i>	Cleve 1896	A	oval cylinder	11	cell: 7-8x10				10	7.5	6	1	375	HD fac.=0.85
<i>Chaetoceros subtilis</i> v. <i>subtilis</i>	Cleve 1896	A	oval cylinder	12	cell: 8x12				12	8	7	1	512	HD fac.=0.85
<i>Chaetoceros tenuissimus</i>	Meunier 1913	A	oval cylinder	1	cell: 2.5x3				3	2.5	2	1	13	HD fac.=0.87
<i>Chaetoceros tenuissimus</i>	Meunier 1913	A	oval cylinder	2	cell: 3x3-5				4	3	3	1	25	HD fac.=0.87
<i>Chaetoceros tenuissimus</i>	Meunier 1913	A	oval cylinder	3	cell: 4x5				5	4	3	1	55	HD fac.=0.87
<i>Chaetoceros tenuissimus</i>	Meunier 1913	A	oval cylinder	4	cell: 5x5				5	5	4	1	85	HD fac.=0.87
<i>Chaetoceros teres</i>	P.T. Cleve 1896	A	oval cylinder	1	cell: 15-20x20-45				27.5	17.5	15	1	5 619	HD fac.=0.85

		Trophy	Geometric shape	Size class No	Cell size range, μm	Length, μm		Width μm	Height μm	Diameter, μm		Number of cells/ counting unit	Calculated volume, μm^3	Comment
						l ₁	l ₂	w	h	d ₁	d ₂			
<i>Chaetoceros teres</i>	P.T. Cleve 1896	A	oval cylinder	2	cell: 20x40-60				50	20	17	1	13 345	HD fac.=0.85
<i>Chaetoceros thronsdensei</i> v. <i>thronsdensei</i>	Zingone in Marino et al. 1991	A	oval cylinder	1	cell: 2x8-12				10	2	2	1	27	HD fac.=0.87
<i>Chaetoceros thronsdensei</i> v. <i>thronsdensei</i>	Zingone in Marino et al. 1991	A	oval cylinder	2	cell: 3x6-9				7.5	3	3	1	46	HD fac.=0.87
<i>Chaetoceros thronsdensei</i> v. <i>thronsdensei</i>	Zingone in Marino et al. 1991	A	oval cylinder	3	cell: 3x10-12				11	3	3	1	68	HD fac.=0.87
<i>Chaetoceros thronsdensei</i> v. <i>thronsdensei</i>	Zingone in Marino et al. 1991	A	oval cylinder	4	cell: 3x13-14				13.5	3	3	1	83	HD fac.=0.87
<i>Chaetoceros thronsdensei</i> v. <i>thronsdensei</i>	Zingone in Marino et al. 1991	A	oval cylinder	5	cell: 4x10-11				10.5	4	3	1	115	HD fac.=0.87
<i>Chaetoceros wighamii</i>	Brightwell	A	oval cylinder	1	cell: 5x5				5	5	4	1	83	HD fac.=0.85
<i>Chaetoceros wighamii</i>	Brightwell	A	oval cylinder	2	cell: 6x6				6	6	5	1	144	HD fac.=0.85
<i>Chaetoceros wighamii</i>	Brightwell	A	oval cylinder	3	cell: 7x7				7	7	6	1	229	HD fac.=0.85
<i>Chaetoceros wighamii</i>	Brightwell	A	oval cylinder	4	cell: 8x8				8	8	7	1	342	HD fac.=0.85
<i>Chaetoceros wighamii</i>	Brightwell	A	oval cylinder	5	cell: 9x9				9	9	8	1	486	HD fac.=0.85
<i>Chaetoceros wighamii</i>	Brightwell	A	oval cylinder	6	cell: 10x10				10	10	9	1	667	HD fac.=0.85
<i>Chaetoceros wighamii</i>	Brightwell	A	oval cylinder	7	cell: 11-12x11-12				11.5	11.5	9	1	955	HD fac.=0.8
<i>Chaetoceros wighamii</i>	Brightwell	A	oval cylinder	8	cell: 13-14x13-14				13.5	13.5	11	1	1 545	HD fac.=0.8
<i>Chaetoceros wighamii</i>	Brightwell	A	oval cylinder	9	cell: 15-16x15-16				15.5	15.5	12	1	2 339	HD fac.=0.8
<i>Chaetoceros wighamii</i>	Brightwell	A	oval cylinder	10	cell: 17-18x17-18				17.5	17.5	14	1	3 366	HD fac.=0.8
<i>Chaetoceros wighamii</i>	Brightwell	A	oval cylinder	11	cell: 19-20x19-20				19.5	19.5	16	1	4 657	HD fac.=0.8
<i>Chaetoceros wighamii</i>	Brightwell	A	oval cylinder	12	cell: 10-11x6-8				7	10.5	7	1	424	HD fac.=0.7
<i>Chaetoceros wighamii</i>	Brightwell	A	oval cylinder	13	cell: 12x5				5	12	8	1	396	HD fac.=0.7
<i>Chaetoceros wighamii</i>	Brightwell	A	oval cylinder	14	cell: 13x6-8				7	13	9	1	650	HD fac.=0.7

		Trophy	Geometric shape	Size class No	Cell size range, μm	Length, μm		Width μm	Height μm	Diameter, μm		Number of cells/ counting unit	Calculated volume, μm^3	Comment
						l ₁	l ₂	w	h	d ₁	d ₂			
<i>Chaetoceros wighamii</i>	Brightwell	A	oval cylinder	15	cell: 13x8-10				9	13	9	1	836	HD fac.=0.7
<i>Chaetoceros wighamii</i>	Brightwell	A	oval cylinder	16	cell: 15-17x8-10				8	16	10	1	965	HD fac.=0.6
<i>Chaetoceros wighamii</i>	Brightwell	A	oval cylinder	17	cell: 15-17x11-13				12	16	10	1	1 447	HD fac.=0.6
<i>Chaetoceros wighamii</i>	Brightwell	A	oval cylinder	18	cell: 18-20x11-13				12	19	11	1	2 040	HD fac.=0.6
<i>Chaetoceros wighamii</i>	Brightwell	A	oval cylinder	19	cell: 21-22x14-16				15	21.5	13	1	3 266	HD fac.=0.6
<i>Chaetoceros spp.</i>		A	oval cylinder	1	cell: 3-4x3-4				4	3	3	1	24	HD fac.=0.85
<i>Chaetoceros spp.</i>		A	oval cylinder	2	cell: 5x5				5	5	4	1	83	HD fac.=0.85
<i>Chaetoceros spp.</i>		A	oval cylinder	3	cell: 6x6				6	6	5	1	144	HD fac.=0.85
<i>Chaetoceros spp.</i>		A	oval cylinder	4	cell: 7x7				7	7	6	1	229	HD fac.=0.85
<i>Chaetoceros spp.</i>		A	oval cylinder	5	cell: 8x8				8	8	7	1	342	HD fac.=0.85
<i>Chaetoceros spp.</i>		A	oval cylinder	6	cell: 9x9				9	9	6	1	401	HD fac.=0.7
<i>Chaetoceros spp.</i>		A	oval cylinder	7	cell: 10x10				10	10	7	1	550	HD fac.=0.7
<i>Chaetoceros spp.</i>		A	oval cylinder	8	cell: 3-4x6				6	3.5	2	1	40	HD fac.=0.7
<i>Chaetoceros spp.</i>		A	oval cylinder	9	cell: 5-6x7				7	5.5	4	1	116	HD fac.=0.7
<i>Chaetoceros spp.</i>		A	oval cylinder	10	cell: 6-8x11-13				12	7	5	1	323	HD fac.=0.7
<i>Chaetoceros spp.</i>		A	oval cylinder	11	cell: 8x15-17				16	8	6	1	563	HD fac.=0.7
<i>Coscinodiscus commutatus</i>	Grunow 1884	A	cylinder	1	cell: 70-90				50	80		1	251 200	6
<i>Coscinodiscus commutatus</i>	Grunow 1884	A	cylinder	2	cell: 90-110				57	100		1	447 450	6
<i>Coscinodiscus commutatus</i>	Grunow 1884	A	cylinder	3	cell: 110-130				58	120		1	655 632	6
<i>Coscinodiscus commutatus</i>	Grunow 1884	A	cylinder	4	cell: 130-150				55	140		1	846 230	6

		Trophy	Geometric shape	Size class No	Cell size range, μm	Length, μm		Width μm	Height μm	Diameter, μm		Number of cells/ counting unit	Calculated volume, μm^3	Comment
						l ₁	l ₂	w	h	d ₁	d ₂			
<i>Coscinodiscus commutatus</i>	Grunow 1884	A	cylinder	5	cell: 150-170				50	160		1	1 004 800	6
<i>Coscinodiscus concinnus</i>	W. Smith 1856	A	cylinder	1	cell: 130-150				70	140		1	1 077 020	6; HD fac.=0.5
<i>Coscinodiscus concinnus</i>	W. Smith 1856	A	cylinder	2	cell: 150-170				80	160		1	1 607 680	6; HD fac.=0.5
<i>Coscinodiscus concinnus</i>	W. Smith 1856	A	cylinder	3	cell: 170-230				80	200		1	2 512 000	6; HD fac.=0.4
<i>Coscinodiscus concinnus</i>	W. Smith 1856	A	cylinder	4	cell: 230-300				79.5	265		1	4 382 567	6; HD fac.=0.3
<i>Coscinodiscus concinnus</i>	W. Smith 1856	A	cylinder	5	cell: 300-370				83.8	335		1	7 378 092	6; HD fac.=0.25
<i>Coscinodiscus granii</i>	Gough 1905	A	cylinder	1	cell: 50-70				42	60		1	118 692	6; HD fac.=0.7
<i>Coscinodiscus granii</i>	Gough 1905	A	cylinder	2	cell: 70-90				56	80		1	281 344	6; HD fac.=0.7
<i>Coscinodiscus granii</i>	Gough 1905	A	cylinder	3	cell: 90-110				70	100		1	549 500	6; HD fac.=0.7
<i>Coscinodiscus granii</i>	Gough 1905	A	cylinder	4	cell: 110-130				72	120		1	813 888	6; HD fac.=0.6
<i>Coscinodiscus granii</i>	Gough 1905	A	cylinder	5	cell: 130-150				70	140		1	1 077 020	6; HD fac.=0.5
<i>Coscinodiscus granii</i>	Gough 1905	A	cylinder	6	cell: 150-170				80	160		1	1 607 680	6; HD fac.=0.5
<i>Coscinodiscus granii</i>	Gough 1905	A	cylinder	7	cell: 170-230				80	200		1	2 512 000	6; HD fac.=0.4
<i>Coscinodiscus granii</i>	Gough 1905	A	cylinder	8	cell: 230-300				79.5	265		1	4 382 567	6; HD fac.=0.3
<i>Coscinodiscus granii</i>	Gough 1905	A	cylinder	9	cell: 300-370				83.8	335		1	7 378 092	6; HD fac.=0.25
<i>Coscinodiscus radiatus</i>	Ehrenberg 1841	A	cylinder	1	cell: 30-40				20	35		1	19 233	6
<i>Coscinodiscus radiatus</i>	Ehrenberg 1841	A	cylinder	2	cell: 40-50				30	45		1	47 689	6
<i>Coscinodiscus radiatus</i>	Ehrenberg 1841	A	cylinder	3	cell: 50-60				30	55		1	71 239	6
<i>Coscinodiscus radiatus</i>	Ehrenberg 1841	A	cylinder	4	cell: 60-70				35	65		1	116 082	6
<i>Coscinodiscus radiatus</i>	Ehrenberg 1841	A	cylinder	5	cell: 70-90				35	80		1	175 840	6
<i>Coscinodiscus radiatus</i>	Ehrenberg 1841	A	cylinder	6	cell: 90-110				30	100		1	235 500	6
<i>Coscinodiscus radiatus</i>	Ehrenberg 1841	A	cylinder	7	cell: 110-130				30	120		1	339 120	6
<i>Coscinodiscus radiatus</i>	Ehrenberg 1841	A	cylinder	8	cell: 130-150				30	140		1	461 580	6
<i>Coscinodiscus radiatus</i>	Ehrenberg 1841	A	cylinder	9	cell: 180				20	180		1	508 680	6
<i>Coscinodiscus wailesii</i>	Gran & Angst 1931	A	cylinder	1	cell: 200-220				140	210		1	4 846 590	6
<i>Coscinodiscus wailesii</i>	Gran & Angst 1931	A	cylinder	2	cell: 220-240				200	240		1	9 043 200	6
<i>Coscinodiscus wailesii</i>	Gran & Angst 1931	A	cylinder	3	cell: 240-260				160	250		1	7 850 000	6
<i>Coscinodiscus wailesii</i>	Gran & Angst 1931	A	cylinder	4	cell: 260-280				200	270		1	11 445 300	6
<i>Coscinodiscus wailesii</i>	Gran & Angst 1931	A	cylinder	5	cell: 280-300				200	290		1	13 203 700	6
<i>Coscinodiscus spp.</i>		A	cylinder	1	cell: 20-30				17.5	25		1	8 586	6; HD fac.=0.7
<i>Coscinodiscus spp.</i>		A	cylinder	2	cell: 30-40				24.5	35		1	23 560	6; HD fac.=0.7
<i>Coscinodiscus spp.</i>		A	cylinder	3	cell: 40-50				31.5	45		1	50 073	6; HD fac.=0.7
<i>Coscinodiscus spp.</i>		A	cylinder	4	cell: 50-60				33	55		1	78 363	6; HD fac.=0.6
<i>Coscinodiscus spp.</i>		A	cylinder	5	cell: 60-70				39	65		1	129 348	6; HD fac.=0.6
<i>Coscinodiscus spp.</i>		A	cylinder	6	cell: 70-90				40	80		1	200 960	6; HD fac.=0.5
<i>Coscinodiscus spp.</i>		A	cylinder	7	cell: 90-110				50	100		1	392 500	6; HD fac.=0.5
<i>Coscinodiscus spp.</i>		A	cylinder	8	cell: 110-130				60	120		1	678 240	6; HD fac.=0.5

	Trophy	Geometric shape	Size class No	Cell size range, μm	Length, μm		Width μm	Height μm	Diameter, μm		Number of cells/ counting unit	Calculated volume, μm^3	Comment
					l ₁	l ₂	w	h	d ₁	d ₂			
<i>Coscinodiscus</i> spp.		A cylinder	9	cell: 130-150				70	140		1	1 077 020	6; HD fac.=0.5
<i>Cyclostephanos dubius</i>	(Fricke in A. Schmidt) Round 1982	A cylinder	1	cell: 12-17				10	14		1	1 539	6
<i>Cyclostephanos dubius</i>	(Fricke in A. Schmidt) Round 1982	A cylinder	2	cell: 17-22				11.2	19		1	3 174	6
<i>Cyclotella atomus</i>	Hustedt 1937	A cylinder	1	cell: 4				2	4		1	25	6
<i>Cyclotella atomus</i>	Hustedt 1937	A cylinder	2	cell: 5				2.5	5		1	49	6
<i>Cyclotella atomus</i>	Hustedt 1937	A cylinder	3	cell: 6				3	6		1	85	6
<i>Cyclotella atomus</i>	Hustedt 1937	A cylinder	4	cell: 7				3.5	7		1	135	6
<i>Cyclotella atomus</i>	Hustedt 1937	A cylinder	5	cell: 8				4	8		1	201	6
<i>Cyclotella choctawhatcheeana</i>	Prasad in Prasad, Nienow & Livingston 1990	A cylinder	1	cell: 5				3	5		1	59	6
<i>Cyclotella choctawhatcheeana</i>	Prasad in Prasad, Nienow & Livingston 1990	A cylinder	2	cell: 6				4	6		1	113	6
<i>Cyclotella choctawhatcheeana</i>	Prasad in Prasad, Nienow & Livingston 1990	A cylinder	3	cell: 8				5	8		1	251	6
<i>Cyclotella choctawhatcheeana</i>	Prasad in Prasad, Nienow & Livingston 1990	A cylinder	4	cell: 10				6	10		1	471	6
<i>Cyclotella glomerata</i>	Bachmann 1911	A cylinder	1	cell: 4-6				3	5		1	59	6
<i>Cyclotella glomerata</i>	Bachmann 1911	A cylinder	2	cell: 6-10				5	8		1	251	6
<i>Cyclotella meneghiniana</i>	Kützing 1844	A cylinder	1	cell: 7-12				8.4	10		1	659	6
<i>Cyclotella meneghiniana</i>	Kützing 1844	A cylinder	2	cell: 12-18				15.4	15		1	2 720	6
<i>Cyclotella meneghiniana</i>	Kützing 1844	A cylinder	3	cell: 18-23				16.8	20		1	5 275	6
<i>Cyclotella meneghiniana</i>	Kützing 1844	A cylinder	4	cell: 23-28				22.4	25		1	10 990	6
<i>Cyclotella meneghiniana</i>	Kützing 1844	A cylinder	5	cell: 28-33				28	30		1	19 782	6
<i>Cyclotella meneghiniana</i>	Kützing 1844	A cylinder	6	cell: 33-38				22.4	35		1	21 540	6
<i>Cyclotella radiosa</i>	(Grunow) Lemmermann 1900	A cylinder	1	cell: 12-18				10	15		1	1 766	6
<i>Cyclotella radiosa</i>	(Grunow) Lemmermann 1900	A cylinder	2	cell: 18-23				11.2	20		1	3 517	6
<i>Cyclotella radiosa</i>	(Grunow) Lemmermann 1900	A cylinder	3	cell: 23-28				16.8	25		1	8 243	6
<i>Cyclotella radiosa</i>	(Grunow) Lemmermann 1900	A cylinder	4	cell: 28-33				20	30		1	14 130	6
<i>Cyclotella stelligera</i>	P.T. Cleve & Grunow in Van Heurck 1882	A cylinder	1	cell: 10-13				7.2	11		1	684	6
<i>Cyclotella stelligera</i>	P.T. Cleve & Grunow in Van Heurck 1882	A cylinder	2	cell: 13-17				6	15		1	1 060	6
<i>Cyclotella stelligera</i>	P.T. Cleve & Grunow in Van Heurck 1882	A cylinder	3	cell: 17-23				7.2	20		1	2 261	6
<i>Cyclotella</i> spp.		A cylinder	1	cell: 3-7				3.3	5		1	64	6; HD fac.=0.65
<i>Cyclotella</i> spp.		A cylinder	2	cell: 7-12				6.5	10		1	510	6; HD fac.=0.65
<i>Cyclotella</i> spp.		A cylinder	3	cell: 12-17				9.8	15		1	1 722	6; HD fac.=0.65

	Trophy	Geometric shape	Size class No	Cell size range, μm	Length, μm		Width μm	Height μm	Diameter, μm		Number of cells/ counting unit	Calculated volume, μm^3	Comment
					l ₁	l ₂	w	h	d ₁	d ₂			
<i>Cyclotella</i> spp.		A cylinder	4	cell: 17-23				10	20		1	3 140	6; HD fac.=0.5
<i>Dactyliosolen fragilissimus</i>	(Bergon) Hasle 1996	A cylinder	1	cell: 4-6x30-40				34	5		1	667	
<i>Dactyliosolen fragilissimus</i>	(Bergon) Hasle 1996	A cylinder	2	cell: 8-10x30-60				45	9		1	2 861	
<i>Dactyliosolen fragilissimus</i>	(Bergon) Hasle 1996	A cylinder	3	cell: 10-12x60-80				70	11		1	6 649	
<i>Dactyliosolen fragilissimus</i>	(Bergon) Hasle 1996	A cylinder	4	cell: 10-12x80-100				90	11		1	8 549	
<i>Dactyliosolen fragilissimus</i>	(Bergon) Hasle 1996	A cylinder	5	cell: 12-14x50-80				67	12.5		1	8 218	
<i>Dactyliosolen fragilissimus</i>	(Bergon) Hasle 1996	A cylinder	6	cell: 19-21x50-70				57	19.5		1	17 014	
<i>Dactyliosolen fragilissimus</i>	(Bergon) Hasle 1996	A cylinder	7	cell: 30-32x150-200				175	31		1	132 017	
<i>Detonula confervacea</i>	(P.T. Cleve) Gran 1900	A cylinder	1	cell: 5-6x13-15				14	5.5		1	332	
<i>Detonula confervacea</i>	(P.T. Cleve) Gran 1900	A cylinder	2	cell: 8-10x12-19				15	9		1	954	
<i>Detonula confervacea</i>	(P.T. Cleve) Gran 1900	A cylinder	3	cell: 15x20				20	15		1	3 533	
<i>Detonula pumila</i>	(Castracane) Schütt 1896	A cylinder	1	cell: 18x22				22	18		1	5 524	
<i>Ditylum brightwellii</i>	(T. West) Grunow in Van Heurck 1883	A prism on triangle base	1	cell: 15x100	15		15	100			1	11 250	
<i>Ditylum brightwellii</i>	(T. West) Grunow in Van Heurck 1883	A prism on triangle base	2	cell: 20-22x120-130m	21		21	125			1	27 563	
<i>Ditylum brightwellii</i>	(T. West) Grunow in Van Heurck 1883	A prism on triangle base	3	cell: 23-25x200	24		24	200			1	57 600	
<i>Ditylum brightwellii</i>	(T. West) Grunow in Van Heurck 1883	A prism on triangle base	4	cell: 30x200	30		30	200			1	90 000	
<i>Eucampia zodiacus</i>	Ehrenberg 1839	A oval cylinder	1	cell: 10x20				10	20	8	1	1 256	HD fac.=0.4
<i>Eucampia zodiacus</i>	Ehrenberg 1839	A oval cylinder	1	cell: 15x25				15	25	10	1	2 944	HD fac.=0.4
<i>Eucampia zodiacus</i>	Ehrenberg 1839	A oval cylinder	1	cell: 20x25				20	25	10	1	3 925	HD fac.=0.4
<i>Guinardia delicatula</i>	(P.T. Cleve) Hasle 1996	A cylinder	1	cell: 10x30				30	10		1	2 355	
<i>Guinardia delicatula</i>	(P.T. Cleve) Hasle 1996	A cylinder	2	cell: 10x50				50	10		1	3 925	
<i>Guinardia delicatula</i>	(P.T. Cleve) Hasle 1996	A cylinder	3	cell: 15x50				50	15		1	8 831	
<i>Guinardia flaccida</i>	(Castracane) H. Peragallo 1892	A cylinder	1	cell: 15x60-80				69	15		1	12 187	
<i>Guinardia flaccida</i>	(Castracane) H. Peragallo 1892	A cylinder	2	cell: 20x60-80				70	20		1	21 980	

	Trophy	Geometric shape	Size class No	Cell size range, μm	Length, μm		Width μm	Height μm	Diameter, μm		Number of cells/ counting unit	Calculated volume, μm^3	Comment	
					l ₁	l ₂	w	h	d ₁	d ₂				
<i>Guinardia flaccida</i>	(Castracane) H. Peragallo 1892	A	cylinder	3	cell: 25x80-100				90	25		1	44 156	
<i>Guinardia flaccida</i>	(Castracane) H. Peragallo 1892	A	cylinder	4	cell: 30x110-130				120	30		1	84 780	
<i>Guinardia flaccida</i>	(Castracane) H. Peragallo 1892	A	cylinder	5	cell: 35x70-80				75	35		1	72 122	
<i>Guinardia flaccida</i>	(Castracane) H. Peragallo 1892	A	cylinder	6	cell: 35x100-150				125	35		1	120 203	
<i>Guinardia flaccida</i>	(Castracane) H. Peragallo 1892	A	cylinder	7	cell: 35x200-300				250	35		1	240 406	
<i>Guinardia flaccida</i>	(Castracane) H. Peragallo 1892	A	cylinder	8	cell: 40x100-200				150	40		1	188 400	
<i>Guinardia flaccida</i>	(Castracane) H. Peragallo 1892	A	cylinder	9	cell: 50x100-150				125	50		1	245 313	
<i>Lauderia annulata</i>	P.T. Cleve 1873	A	cylinder		cell: 33-35x33-35				34	34		1	30 854	
<i>Leptocylindrus danicus</i>	P.T. Cleve 1889	A	cylinder	1	cell: 3x80				80	3		1	565	
<i>Leptocylindrus danicus</i>	P.T. Cleve 1889	A	cylinder	2	cell: 4x40-55				48	4		1	603	
<i>Leptocylindrus danicus</i>	P.T. Cleve 1889	A	cylinder	3	cell: 5x25-30				28	5		1	550	
<i>Leptocylindrus danicus</i>	P.T. Cleve 1889	A	cylinder	4	cell: 5x30-50				40	5		1	785	
<i>Leptocylindrus danicus</i>	P.T. Cleve 1889	A	cylinder	5	cell: 5x50-60				55	5		1	1 079	
<i>Leptocylindrus danicus</i>	P.T. Cleve 1889	A	cylinder	6	cell: 5x70-80				78	5		1	1 531	
<i>Leptocylindrus danicus</i>	P.T. Cleve 1889	A	cylinder	7	cell: 6x25-35				31	6		1	876	
<i>Leptocylindrus danicus</i>	P.T. Cleve 1889	A	cylinder	8	cell: 7-9x35-50				42.5	8		1	2 135	
<i>Leptocylindrus danicus</i>	P.T. Cleve 1889	A	cylinder	9	cell: 9-11x40-60				50	10		1	3 925	
<i>Leptocylindrus minimus</i>	Gran 1915	A	cylinder		cell: 3x20-25				22	3		1	155	
<i>Leptocylindrus spp.</i>		A	cylinder	1	cell: 3x100				100	3		1	707	
<i>Leptocylindrus spp.</i>		A	cylinder	2	cell: 10x100				100	10		1	7 850	
<i>Melosira arctica</i>	(Ehrenberg) Dickie ex Ralfs in Pritschard 1861	A	cylinder	1	cell: 8x13				13	8		1	653	
<i>Melosira arctica</i>	(Ehrenberg) Dickie ex Ralfs in Pritschard 1861	A	cylinder	2	cell: 8-10x15-20				17.5	9		1	1 113	
<i>Melosira arctica</i>	(Ehrenberg) Dickie ex Ralfs in Pritschard 1861	A	cylinder	3	cell: 11-13x20-25				22	12		1	2 487	
<i>Melosira arctica</i>	(Ehrenberg) Dickie ex Ralfs in Pritschard 1861	A	cylinder	4	cell: 14x15-20				17.5	14		1	2 693	
<i>Melosira arctica</i>	(Ehrenberg) Dickie ex Ralfs in Pritschard 1861	A	cylinder	5	cell: 14x20-30				25	14		1	3 847	
<i>Melosira arctica</i>	(Ehrenberg) Dickie ex Ralfs in Pritschard 1861	A	cylinder	6	cell: 15x17-25				20	15		1	3 533	

	Trophy	Geometric shape	Size class No	Cell size range, μm	Length, μm		Width μm	Height μm	Diameter, μm		Number of cells/ counting unit	Calculated volume, μm^3	Comment	
					l ₁	l ₂	w	h	d ₁	d ₂				
<i>Melosira arctica</i>	(Ehrenberg) Dickie ex Ralfs in Pritschard 1861	A	cylinder	7	cell: 17x17-25				20	17		1	4 537	
<i>Melosira arctica</i>	(Ehrenberg) Dickie ex Ralfs in Pritschard 1861	A	cylinder	8	cell: 19x20-30				26	19		1	7 368	
<i>Melosira moniliformis</i>	(O.F. Müller) C.A. Agardh 1824	A	cylinder		cell: 18-22x20				20	20		1	6 280	
<i>Melosira nummuloides</i>	C.A. Agardh 1824	A	cylinder	1	cell: 9-11x15-20				17.5	10		1	1 374	
<i>Melosira nummuloides</i>	C.A. Agardh 1824	A	cylinder	2	cell: 12-16x25-30				28	14		1	4 308	
<i>Melosira varians</i>	C.A. Agardh 1827	A	cylinder	1	cell: 10-12x25				25	11.2		1	2 462	
<i>Melosira varians</i>	C.A. Agardh 1827	A	cylinder	2	cell: 13-15x20-25				22.4	14		1	3 446	
<i>Melosira varians</i>	C.A. Agardh 1827	A	cylinder	3	cell: 15-17x25-30				28	16		1	5 627	
<i>Odontella aurita</i>	(Lyngbye) C.A. Agardh 1832	A	oval cylinder		cell: 40-50x30-40				44	35	18	1	21 760	
<i>Odontella mobiliensis</i>	(J.W. Bailey) Grunow 1884	A	oval cylinder		cell: 50-70x60-80				60	70	36	1	118 692	
<i>Odontella sinensis</i>	(Greville) Grunow 1884	A	oval cylinder		cell: 120-170x150-200				150	170	50	1	1 000 875	
<i>Porosira glacialis</i>	(Grunow) E. Jørgensen 1905	A	cylinder	1	cell: 30-35				19.8	33		1	16 926	6; HD fac.=0.6
<i>Porosira glacialis</i>	(Grunow) E. Jørgensen 1905	A	cylinder	2	cell: 35-40				22.2	37		1	23 858	6; HD fac.=0.6
<i>Porosira glacialis</i>	(Grunow) E. Jørgensen 1905	A	cylinder	3	cell: 40-45				25.8	43		1	37 448	6; HD fac.=0.6
<i>Porosira glacialis</i>	(Grunow) E. Jørgensen 1905	A	cylinder	4	cell: 45-50				28.2	47		1	48 901	6; HD fac.=0.6
<i>Porosira glacialis</i>	(Grunow) E. Jørgensen 1905	A	cylinder	5	cell: 50-55				31.8	53		1	70 121	6; HD fac.=0.6
<i>Porosira glacialis</i>	(Grunow) E. Jørgensen 1905	A	cylinder	6	cell: 55-60				34.2	57		1	87 226	6; HD fac.=0.6
<i>Porosira glacialis</i>	(Grunow) E. Jørgensen 1905	A	cylinder	7	cell: 60-65				37.8	63		1	117 772	6; HD fac.=0.6
<i>Porosira glacialis</i>	(Grunow) E. Jørgensen 1905	A	cylinder	8	cell: 65-70				40.2	67		1	141 659	6; HD fac.=0.6
<i>Porosira glacialis</i>	(Grunow) E. Jørgensen 1905	A	cylinder	9	cell: 70-75				43.8	73		1	183 227	6; HD fac.=0.6
<i>Porosira glacialis</i>	(Grunow) E. Jørgensen 1905	A	cylinder	10	cell: 75-80				46.2	77		1	215 027	6; HD fac.=0.6
<i>Porosira glacialis</i>	(Grunow) E. Jørgensen 1905	A	cylinder	11	cell: 80-85				49.8	83		1	269 312	6; HD fac.=0.6
<i>Proboscia alata</i>	(Brightwell) Sundström 1986	A	cylinder	1	cell: 4x300-400				350	4		1	4 396	
<i>Proboscia alata</i>	(Brightwell) Sundström 1986	A	cylinder	2	cell: 4x450-650				550	4		1	6 908	
<i>Proboscia alata</i>	(Brightwell) Sundström 1986	A	cylinder	3	cell: 5x340-470				400	5		1	7 850	
<i>Proboscia alata</i>	(Brightwell) Sundström 1986	A	cylinder	4	cell: 6x500-600				560	6		1	15 826	
<i>Proboscia alata</i>	(Brightwell) Sundström 1986	A	cylinder	5	cell: 7x250-400				325	7		1	12 501	
<i>Proboscia alata</i>	(Brightwell) Sundström 1986	A	cylinder	6	cell: 9x300-400				360	9		1	22 891	
<i>Proboscia alata</i>	(Brightwell) Sundström 1986	A	cylinder	7	cell: 10x400-500				450	10		1	35 325	
<i>Proboscia alata</i>	(Brightwell) Sundström 1986	A	cylinder	8	cell: 20x1300				1300	20		1	408 200	
<i>Rhizosolenia hebetata</i> f. <i>semispina</i>	(Hensen) Gran 1904	A	cylinder	1	cell: 4x300				300	4		1	3 768	
<i>Rhizosolenia hebetata</i> f. <i>semispina</i>	(Hensen) Gran 1904	A	cylinder	2	cell: 5x500				500	5		1	9 813	

		Trophy	Geometric shape	Size class No	Cell size range, μm	Length, μm		Width μm	Height μm	Diameter, μm		Number of cells/ counting unit	Calculated volume, μm^3	Comment
						l ₁	l ₂	w	h	d ₁	d ₂			
<i>Rhizosolenia hebetata</i> f. <i>semispina</i>	(Hensen) Gran 1904	A	cylinder	3	cell: 7x400				400	7		1	15 386	
<i>Rhizosolenia hebetata</i> f. <i>semispina</i>	(Hensen) Gran 1904	A	cylinder	4	cell: 10x400				400	10		1	31 400	
<i>Rhizosolenia hebetata</i> f. <i>semispina</i>	(Hensen) Gran 1904	A	cylinder	5	cell: 10x800				800	10		1	62 800	
<i>Rhizosolenia hebetata</i> f. <i>semispina</i>	(Hensen) Gran 1904	A	cylinder	6	cell: 15x400-500				400	15		1	70 650	
<i>Rhizosolenia hebetata</i> f. <i>semispina</i>	(Hensen) Gran 1904	A	cylinder	7	cell: 15x800				800	15		1	141 300	
<i>Rhizosolenia pungens</i>	Cleve-Euler 1937	A	cylinder	1	cell: 4x200-300				250	4		1	3 140	
<i>Rhizosolenia pungens</i>	Cleve-Euler 1937	A	cylinder	2	cell: 5x300-400				385	5		1	7 556	
<i>Rhizosolenia pungens</i>	Cleve-Euler 1937	A	cylinder	3	cell: 6x375-450				350	6		1	9 891	
<i>Rhizosolenia pungens</i>	Cleve-Euler 1937	A	cylinder	4	cell: 7x375-450				400	7		1	15 386	
<i>Rhizosolenia pungens</i>	Cleve-Euler 1937	A	cylinder	5	cell: 8x650-700				690	8		1	34 666	
<i>Rhizosolenia pungens</i>	Cleve-Euler 1937	A	cylinder	6	cell: 10x400				400	10		1	31 400	
<i>Rhizosolenia pungens</i>	Cleve-Euler 1937	A	cylinder	7	cell: 15x400-550				475	15		1	83 897	
<i>Rhizosolenia pungens</i>	Cleve-Euler 1937	A	cylinder	8	cell: 20x260				260	20		1	81 640	
<i>Rhizosolenia setigera</i>	Brightwell 1858	A	cylinder	1	cell: 4x300-450				375	4		1	4 710	
<i>Rhizosolenia setigera</i>	Brightwell 1858	A	cylinder	2	cell: 7x400				400	7		1	15 386	
<i>Rhizosolenia setigera</i>	Brightwell 1858	A	cylinder	3	cell: 10x400-450				425	10		1	33 363	
<i>Rhizosolenia setigera</i>	Brightwell 1858	A	cylinder	4	cell: 15x400				400	15		1	70 650	
<i>Rhizosolenia setigera</i>	Brightwell 1858	A	cylinder	5	cell: 20x200-300				220	20		1	69 080	
<i>Rhizosolenia setigera</i>	Brightwell 1858	A	cylinder	6	cell: 20x500-600				520	20		1	163 280	
<i>Rhizosolenia setigera</i>	Brightwell 1858	A	cylinder	7	cell: 25x500-650				575	25		1	282 109	
<i>Rhizosolenia setigera</i>	Brightwell 1858	A	cylinder	8	cell: 50x700				700	50		1	1 373 750	
<i>Rhizosolenia styliformis</i>	Brightwell 1858	A	cylinder		cell: 60x100				100	60		1	282 600	
<i>Skeletonema costatum</i>	(Greville) P.T. Cleve 1878	A	cylinder	1	cell: 2x3-5				4	2		1	13	
<i>Skeletonema costatum</i>	(Greville) P.T. Cleve 1878	A	cylinder	2	cell: 3x3-5				4	3		1	28	
<i>Skeletonema costatum</i>	(Greville) P.T. Cleve 1878	A	cylinder	3	cell: 3x6-8				7	3		1	49	
<i>Skeletonema costatum</i>	(Greville) P.T. Cleve 1878	A	cylinder	4	cell: 4x7-8				7.5	4		1	94	
<i>Skeletonema costatum</i>	(Greville) P.T. Cleve 1878	A	cylinder	5	cell: 5x7-10				8.5	5		1	167	
<i>Skeletonema costatum</i>	(Greville) P.T. Cleve 1878	A	cylinder	6	cell: 6x7-10				8	6		1	226	
<i>Skeletonema costatum</i>	(Greville) P.T. Cleve 1878	A	cylinder	7	cell: 7x7-10				8.5	7		1	327	
<i>Skeletonema costatum</i>	(Greville) P.T. Cleve 1878	A	cylinder	8	cell: 10x5				5	10		1	393	
<i>Skeletonema costatum</i>	(Greville) P.T. Cleve 1878	A	cylinder	9	cell: 2x14				14	2		1	44	
<i>Skeletonema costatum</i>	(Greville) P.T. Cleve 1878	A	cylinder	10	cell: 3x9-14				11	3		1	78	
<i>Skeletonema costatum</i>	(Greville) P.T. Cleve 1878	A	cylinder	11	cell: 3x15-25				19	3		1	134	

	Trophy	Geometric shape	Size class No	Cell size range, μm	Length, μm		Width μm	Height μm	Diameter, μm		Number of cells/ counting unit	Calculated volume, μm^3	Comment	
					l ₁	l ₂	w	h	d ₁	d ₂				
<i>Skeletonema costatum</i>	(Greville) P.T. Cleve 1878	A	cylinder	12	cell: 4x9-14				11	4		1	138	
<i>Skeletonema costatum</i>	(Greville) P.T. Cleve 1878	A	cylinder	13	cell: 4x15-25				21	4		1	264	
<i>Skeletonema costatum</i>	(Greville) P.T. Cleve 1878	A	cylinder	14	cell: 5x9-14				11	5		1	216	
<i>Skeletonema costatum</i>	(Greville) P.T. Cleve 1878	A	cylinder	15	cell: 5x15-25				19	5		1	373	
<i>Skeletonema costatum</i>	(Greville) P.T. Cleve 1878	A	cylinder	16	cell: 6x9-14				11	6		1	311	
<i>Skeletonema costatum</i>	(Greville) P.T. Cleve 1878	A	cylinder	17	cell: 6x15-25				19	6		1	537	
<i>Skeletonema costatum</i>	(Greville) P.T. Cleve 1878	A	cylinder	18	cell: 7x9-14				11	7		1	423	
<i>Skeletonema costatum</i>	(Greville) P.T. Cleve 1878	A	cylinder	19	cell: 7x15-25				19	7		1	731	
<i>Skeletonema costatum</i>	(Greville) P.T. Cleve 1878	A	cylinder	20	cell: 8x9-14				11	8		1	553	
<i>Skeletonema costatum</i>	(Greville) P.T. Cleve 1878	A	cylinder	21	cell: 8x15-25				19	8		1	955	
<i>Skeletonema costatum</i>	(Greville) P.T. Cleve 1878	A	cylinder	22	cell: 10x9-14				11	10		1	864	
<i>Skeletonema costatum</i>	(Greville) P.T. Cleve 1878	A	cylinder	23	cell: 10x15-25				21	10		1	1 649	
<i>Skeletonema subsalsum</i>	(Cleve-Euler) Bethge 1928	A	cylinder	1	cell: 3-4x7-10				9.8	3.5		1	94	
<i>Skeletonema subsalsum</i>	(Cleve-Euler) Bethge 1928	A	cylinder	2	cell: 3-4x11-15				13	3.5		1	125	
<i>Skeletonema subsalsum</i>	(Cleve-Euler) Bethge 1928	A	cylinder	3	cell: 3-4x16-20				19.6	3.5		1	188	
<i>Skeletonema subsalsum</i>	(Cleve-Euler) Bethge 1928	A	cylinder	4	cell: 4-5x4.5-7.5				6	4.5		1	95	
<i>Skeletonema subsalsum</i>	(Cleve-Euler) Bethge 1928	A	cylinder	5	cell: 5-6x8-13				10.5	5.5		1	249	
<i>Skeletonema subsalsum</i>	(Cleve-Euler) Bethge 1928	A	cylinder	6	cell: 5-6x13-20				16.5	5.5		1	392	
<i>Skeletonema subsalsum</i>	(Cleve-Euler) Bethge 1928	A	cylinder	7	cell: 6-7x18-22				19.6	6.5		1	650	
<i>Skeletonema subsalsum</i>	(Cleve-Euler) Bethge 1928	A	cylinder	8	cell: 8-9x11-15				13	8.5		1	737	
<i>Stephanodiscus binderanus</i>	(Kützing) W. Krieger 1927	A	cylinder	1	cell: 6-7x10-13				11.6	6.5		1	385	
<i>Stephanodiscus binderanus</i>	(Kützing) W. Krieger 1927	A	cylinder	2	cell: 8-9x13-15				14	8.5		1	794	
<i>Stephanodiscus binderanus</i>	(Kützing) W. Krieger 1927	A	cylinder	3	cell: 10-12x15-20				17	11		1	1 615	
<i>Stephanodiscus binderanus</i>	(Kützing) W. Krieger 1927	A	cylinder	4	cell: 13-15x20-30				25.2	14		1	3 877	
<i>Stephanodiscus hantzschii</i>	Grunow in P.T. Cleve & Grunow 1880	A	cylinder	1	cell: 8-9x7-9				8	8.5		1	454	
<i>Stephanodiscus hantzschii</i>	Grunow in P.T. Cleve & Grunow 1880	A	cylinder	2	cell: 10-12x8-10				9	11.2		1	886	
<i>Stephanodiscus hantzschii</i>	Grunow in P.T. Cleve & Grunow 1880	A	cylinder	3	cell: 13-15x9-11				10	14		1	1 539	
<i>Stephanodiscus hantzschii</i>	Grunow in P.T. Cleve & Grunow 1880	A	cylinder	4	cell: 15-16x11-13				12	15.5		1	2 263	
<i>Stephanodiscus hantzschii</i>	Grunow in P.T. Cleve & Grunow 1880	A	cylinder	5	cell: 20-25x13-15				14	22.5		1	5 564	

		Trophy	Geometric shape	Size class No	Cell size range, μm	Length, μm		Width μm	Height μm	Diameter, μm		Number of cells/ counting unit	Calculated volume, μm^3	Comment
						l ₁	l ₂	w	h	d ₁	d ₂			
<i>Stephanodiscus minutulus</i>	(Kützing) P.T. Cleve & Möller 1978	A	cylinder		cell: 7-9x6-8				7	8		1	352	
<i>Stephanodiscus neoastraea</i>	Håkansson & Hickel 1986	A	cylinder	1	cell: 20-25				13.5	22.5		1	5 365	6; HD fac.=0.6
<i>Stephanodiscus neoastraea</i>	Håkansson & Hickel 1986	A	cylinder	2	cell: 25-30				16.5	27.5		1	9 795	6; HD fac.=0.6
<i>Stephanodiscus neoastraea</i>	Håkansson & Hickel 1986	A	cylinder	3	cell: 30-35				19.5	32.5		1	16 169	6; HD fac.=0.6
<i>Stephanodiscus neoastraea</i>	Håkansson & Hickel 1986	A	cylinder	4	cell: 35-40				22.5	37.5		1	24 838	6; HD fac.=0.6
<i>Stephanodiscus neoastraea</i>	Håkansson & Hickel 1986	A	cylinder	5	cell: 35-45				25.2	42.5		1	35 731	6; HD fac.=0.6
<i>Stephanodiscus parvus</i>	(Grunow ex Cleve & Möller) Stoermer & Håkansson 1984	A	cylinder		cell: 7-9x6-8				7	8		1	352	
<i>Stephanodiscus rotula</i>	(Kützing) Hendey 1964	A	cylinder	1	cell: 20-25				13.5	22.5		1	5 365	6; HD fac.=0.6
<i>Stephanodiscus rotula</i>	(Kützing) Hendey 1964	A	cylinder	2	cell: 25-30				16.5	27.5		1	9 795	6; HD fac.=0.6
<i>Stephanodiscus rotula</i>	(Kützing) Hendey 1964	A	cylinder	3	cell: 30-35				19.5	32.5		1	16 169	6; HD fac.=0.6
<i>Stephanodiscus rotula</i>	(Kützing) Hendey 1964	A	cylinder	4	cell: 35-40				22.5	37.5		1	24 838	6; HD fac.=0.6
<i>Stephanodiscus rotula</i>	(Kützing) Hendey 1964	A	cylinder	5	cell: 35-45				25.5	42.5		1	36 157	6; HD fac.=0.6
<i>Stephanodiscus spp.</i>		A	cylinder	1	cell: <8				3	5		1	59	6; HD fac.=0.6
<i>Stephanodiscus spp.</i>		A	cylinder	2	cell: 8-13				6	10		1	471	6; HD fac.=0.6
<i>Stephanodiscus spp.</i>		A	cylinder	3	cell: 13-18				9	15		1	1 590	6; HD fac.=0.6
<i>Stephanodiscus spp.</i>		A	cylinder	4	cell: 18-23				12	20		1	3 768	6; HD fac.=0.6
<i>Stephanopyxis turris</i>	(Greville & Arnott in Gregory) Ralfs in Pritchard 1861	A	cylinder		cell: 28-32				40	30		1	28 260	6
<i>Thalassiosira angulata</i>	(Gregory) Hasle 1978	A	cylinder	1	cell: 20-25				10.8	22.5		1	4 292	6; HD fac.=0.48
<i>Thalassiosira angulata</i>	(Gregory) Hasle 1978	A	cylinder	2	cell: 25-30				13.2	27.5		1	7 836	6; HD fac.=0.48
<i>Thalassiosira angulata</i>	(Gregory) Hasle 1978	A	cylinder	3	cell: 30-35				15.6	32.5		1	12 935	6; HD fac.=0.48
<i>Thalassiosira angulata</i>	(Gregory) Hasle 1978	A	cylinder	4	cell: 35-40				18	37.5		1	19 870	6; HD fac.=0.48
<i>Thalassiosira angulata</i>	(Gregory) Hasle 1978	A	cylinder	5	cell: 40-45				20.4	42.5		1	28 925	6; HD fac.=0.48
<i>Thalassiosira angulata</i>	(Gregory) Hasle 1978	A	cylinder	6	cell: 45-50				22.8	47.5		1	40 382	6; HD fac.=0.48
<i>Thalassiosira angulata</i>	(Gregory) Hasle 1978	A	cylinder	7	cell: 50-55				25.2	52.5		1	54 524	6; HD fac.=0.48
<i>Thalassiosira angulata</i>	(Gregory) Hasle 1978	A	cylinder	8	cell: 55-60				27.6	57.5		1	71 633	6; HD fac.=0.48
<i>Thalassiosira anguste-lineata</i>	(A. Schmidt) G. Fryxell & Hasle 1977	A	cylinder	1	cell: 35-40				14.25	37.5		1	15 731	6; HD fac.=0.38
<i>Thalassiosira anguste-lineata</i>	(A. Schmidt) G. Fryxell & Hasle 1977	A	cylinder	2	cell: 40-45				16.15	42.5		1	22 899	6; HD fac.=0.38
<i>Thalassiosira anguste-lineata</i>	(A. Schmidt) G. Fryxell & Hasle 1977	A	cylinder	3	cell: 45-50				18.05	47.5		1	31 969	6; HD fac.=0.38

		Trophy	Geometric shape	Size class No	Cell size range, μm	Length, μm		Width μm	Height μm	Diameter, μm		Number of cells/ counting unit	Calculated volume, μm^3	Comment
						l ₁	l ₂	w	h	d ₁	d ₂			
<i>Thalassiosira anguste-lineata</i>	(A. Schmidt) G. Fryxell & Hasle 1977	A	cylinder	4	cell: 50-55				19.95	52.5		1	43 165	6; HD fac.=0.38
<i>Thalassiosira anguste-lineata</i>	(A. Schmidt) G. Fryxell & Hasle 1977	A	cylinder	5	cell: 55-60				21.85	57.5		1	56 710	6; HD fac.=0.38
<i>Thalassiosira anguste-lineata</i>	(A. Schmidt) G. Fryxell & Hasle 1977	A	cylinder	6	cell: 60-65				23.75	62.5		1	72 827	6; HD fac.=0.38
<i>Thalassiosira baltica</i>	(Grunow in P.T. Cleve & Grunow) Ostenfeld 1901	A	cylinder	1	cell: 17-22				10	20		1	3 140	6; HD fac.=0.5
<i>Thalassiosira baltica</i>	(Grunow in P.T. Cleve & Grunow) Ostenfeld 1901	A	cylinder	2	cell: 22-27				12.5	25		1	6 133	6; HD fac.=0.5
<i>Thalassiosira baltica</i>	(Grunow in P.T. Cleve & Grunow) Ostenfeld 1901	A	cylinder	3	cell: 27-32				15	30		1	10 598	6; HD fac.=0.5
<i>Thalassiosira baltica</i>	(Grunow in P.T. Cleve & Grunow) Ostenfeld 1901	A	cylinder	4	cell: 32-40				17.5	35		1	16 828	6; HD fac.=0.5
<i>Thalassiosira baltica</i>	(Grunow in P.T. Cleve & Grunow) Ostenfeld 1901	A	cylinder	5	cell: 40-50				22.5	45		1	35 767	6; HD fac.=0.5
<i>Thalassiosira baltica</i>	(Grunow in P.T. Cleve & Grunow) Ostenfeld 1901	A	cylinder	6	cell: 50-60				27.5	55		1	65 302	6; HD fac.=0.5
<i>Thalassiosira baltica</i>	(Grunow in P.T. Cleve & Grunow) Ostenfeld 1901	A	cylinder	7	cell: 60-70				19.5	65		1	64 674	6; HD fac.=0.3
<i>Thalassiosira baltica</i>	(Grunow in P.T. Cleve & Grunow) Ostenfeld 1901	A	cylinder	8	cell: 70-80				22.5	75		1	99 352	6; HD fac.=0.3
<i>Thalassiosira baltica</i>	(Grunow in P.T. Cleve & Grunow) Ostenfeld 1901	A	cylinder	9	cell: 80-90				25.5	85		1	144 626	6; HD fac.=0.3
<i>Thalassiosira baltica</i>	(Grunow in P.T. Cleve & Grunow) Ostenfeld 1901	A	cylinder	10	cell: 90-110				30	100		1	235 500	6; HD fac.=0.3
<i>Thalassiosira decipiens</i>	(Grunow) E. Jørgensen 1905 sensu Hasle 1979	A	cylinder	1	cell: 17-22				15	20		1	4 710	6
<i>Thalassiosira decipiens</i>	(Grunow) E. Jørgensen 1905 sensu Hasle 1979	A	cylinder	2	cell: 22-27				10	25		1	4 906	6
<i>Thalassiosira decipiens</i>	(Grunow) E. Jørgensen 1905 sensu Hasle 1979	A	cylinder	3	cell: 40-50				30	45		1	47 689	6
<i>Thalassiosira eccentrica</i>	(Ehrenberg) P.T. Cleve 1903	A	cylinder	1	cell: 30				24	30		1	16 956	6
<i>Thalassiosira eccentrica</i>	(Ehrenberg) P.T. Cleve 1903	A	cylinder	2	cell: 135				25	135		1	357 666	6
<i>Thalassiosira gravida</i>	P.T. Cleve 1896	A	cylinder	1	cell: 32-37				15	35		1	14 424	6
<i>Thalassiosira gravida</i>	P.T. Cleve 1896	A	cylinder	2	cell: 37-42				15	40		1	18 840	6
<i>Thalassiosira guillardii</i>	Hasle 1978	A	cylinder		cell: 10-15				8	12.5		1	981	6
<i>Thalassiosira hyalina</i>	(Grunow in Cleve & Grunow) Gran 1897	A	cylinder		cell: 30-35				19.5	32.5		1	16 169	6

		Trophy	Geometric shape	Size class No	Cell size range, μm	Length, μm		Width μm	Height μm	Diameter, μm		Number of cells/ counting unit	Calculated volume, μm^3	Comment
						l ₁	l ₂	w	h	d ₁	d ₂			
<i>Thalassiosira hyperborea v. pelagica</i>	(Cleve-Euler) Hasle 1989	A	cylinder		cell: 30-35				13	32.5		1	10 779	6
<i>Thalassiosira lacustris</i>	(Grunow in Cleve & Grunow 1880) Hasle in Hasle & G. Fryxell 1977	A	cylinder	1	cell: 25-30				11	27.5		1	6 530	6; HD fac.=0.4
<i>Thalassiosira lacustris</i>	(Grunow in Cleve & Grunow 1880) Hasle in Hasle & G. Fryxell 1977	A	cylinder	2	cell: 30-35				13	32.5		1	10 779	6; HD fac.=0.4
<i>Thalassiosira lacustris</i>	(Grunow in Cleve & Grunow 1880) Hasle in Hasle & G. Fryxell 1977	A	cylinder	3	cell: 35-40				22.5	37.5		1	24 838	6; HD fac.=0.6
<i>Thalassiosira lacustris</i>	(Grunow in Cleve & Grunow 1880) Hasle in Hasle & G. Fryxell 1977	A	cylinder	4	cell: 80-90				25	85		1	141 791	6
<i>Thalassiosira levanderi</i>	van Goor 1924	A	cylinder	1	cell: 7-9				4.8	8		1	241	6; HD fac.= 0.6
<i>Thalassiosira levanderi</i>	van Goor 1924	A	cylinder	2	cell: 9-11				6	10		1	471	6; HD fac.= 0.6
<i>Thalassiosira levanderi</i>	van Goor 1924	A	cylinder	3	cell: 11-13				7.2	12		1	814	6; HD fac.= 0.6
<i>Thalassiosira levanderi</i>	van Goor 1924	A	cylinder	4	cell: 13-15				8.4	14		1	1 292	6; HD fac.= 0.6
<i>Thalassiosira levanderi</i>	van Goor 1924	A	cylinder	5	cell: 15-17				9.6	16		1	1 929	6; HD fac.= 0.6
<i>Thalassiosira nordenskioldii</i>	P.T. Cleve 1873	A	cylinder	1	cell: 10-15				11	12.5		1	1 349	6
<i>Thalassiosira nordenskioldii</i>	P.T. Cleve 1873	A	cylinder	2	cell: 15-20				12	17.5		1	2 885	6
<i>Thalassiosira nordenskioldii</i>	P.T. Cleve 1873	A	cylinder	3	cell: 20-25				13	22.5		1	5 166	6
<i>Thalassiosira nordenskioldii</i>	P.T. Cleve 1873	A	cylinder	4	cell: 25-30				14	27.5		1	8 311	6
<i>Thalassiosira nordenskioldii</i>	P.T. Cleve 1873	A	cylinder	5	cell: 30-35				17	32.5		1	14 096	6
<i>Thalassiosira nordenskioldii</i>	P.T. Cleve 1873	A	cylinder	6	cell: 35-40				18	37.5		1	19 870	6
<i>Thalassiosira proschkinae</i>	Makarova in Makarova, Genkal & Kuzmin 1979	A	cylinder		cell: 5-6				2.7	5.4		1	62	6
<i>Thalassiosira pseudonana</i>	(Hustedt) Hasle & Heimdal 1970	A	cylinder	1	cell: 4-6				3.25	5		1	64	6; HD fac.=0.65
<i>Thalassiosira pseudonana</i>	(Hustedt) Hasle & Heimdal 1970	A	cylinder	2	cell: 6-8				4.55	7		1	175	6; HD fac.=0.65
<i>Thalassiosira punctigera</i>	(Castracane) Hasle 1983	A	cylinder	1	cell: 40-50				22.5	45		1	35 767	* 6; HD fac.=0.5
<i>Thalassiosira punctigera</i>	(Castracane) Hasle 1983	A	cylinder	2	cell: 50-60				27.5	55		1	65 302	* 6; HD fac.=0.5
<i>Thalassiosira punctigera</i>	(Castracane) Hasle 1983	A	cylinder	3	cell: 60-70				32.5	65		1	107 790	* 6; HD fac.=0.5

	Trophy	Geometric shape	Size class No	Cell size range, μm	Length, μm		Width μm	Height μm	Diameter, μm		Number of cells/ counting unit	Calculated volume, μm^3	Comment	
					l ₁	l ₂	w	h	d ₁	d ₂				
<i>Thalassiosira rotula</i>	Meunier 1910	A	cylinder		cell: 40				12	40		1	15 072	6
<i>Thalassiosira weissflogii</i>	(Grunow in Van Heurck) G. Fryxell & Hasle 1977	A	cylinder	1	cell: 12-15				10	13		1	1 327	6
<i>Thalassiosira weissflogii</i>	(Grunow in Van Heurck) G. Fryxell & Hasle 1977	A	cylinder	2	cell: 15-18				14	16		1	2 813	6
<i>Thalassiosira weissflogii</i>	(Grunow in Van Heurck) G. Fryxell & Hasle 1977	A	cylinder	2	cell: 18-22				15	20		1	4 710	6
<i>Thalassiosira spp.</i>		A	cylinder	1	cell: 3-7				3.3	5		1	64	6; HD fac.=0.65
<i>Thalassiosira spp.</i>		A	cylinder	2	cell: 7-12				6.5	10		1	510	6; HD fac.=0.65
<i>Thalassiosira spp.</i>		A	cylinder	3	cell: 12-17				9.8	15		1	1 722	6; HD fac.=0.65
<i>Thalassiosira spp.</i>		A	cylinder	4	cell: 17-22				10	20		1	3 140	6; HD fac.=0.5
<i>Thalassiosira spp.</i>		A	cylinder	5	cell: 22-27				12.5	25		1	6 133	6; HD fac.=0.5
<i>Thalassiosira spp.</i>		A	cylinder	6	cell: 27-32				15	30		1	10 598	6; HD fac.=0.5
<i>Thalassiosira spp.</i>		A	cylinder	7	cell: 32-40				17.5	35		1	16 828	6; HD fac.=0.5
<i>Thalassiosira spp.</i>		A	cylinder	8	cell: 40-50				22.5	45		1	35 767	6; HD fac.=0.5
<i>Thalassiosira spp.</i>		A	cylinder	9	cell: 50-60				27.5	55		1	65 302	6; HD fac.=0.5
<i>Thalassiosira spp.</i>		A	cylinder	10	cell: 60-70				19.5	65		1	64 674	6; HD fac.=0.3
<i>Thalassiosira spp.</i>		A	cylinder	11	cell: 70-90				24	80		1	120 576	6; HD fac.=0.3
<i>Thalassiosira spp.</i>		A	cylinder	12	cell: 90-110				30	100		1	235 500	6; HD fac.=0.3
<i>Centrales, unidentified</i>		A	cylinder	1	cell: 3-7				3.3	5		1	64	6; HD fac.=0.65
<i>Centrales, unidentified</i>		A	cylinder	2	cell: 7-12				6.5	10		1	510	6; HD fac.=0.65
<i>Centrales, unidentified</i>		A	cylinder	3	cell: 12-17				9.8	15		1	1 722	6; HD fac.=0.65
<i>Centrales, unidentified</i>		A	cylinder	4	cell: 17-22				10	20		1	3 140	6; HD fac.=0.5
<i>Centrales, unidentified</i>		A	cylinder	5	cell: 22-27				12.5	25		1	6 133	6; HD fac.=0.5
<i>Centrales, unidentified</i>		A	cylinder	6	cell: 27-32				15	30		1	10 598	6; HD fac.=0.5
<i>Centrales, unidentified</i>		A	cylinder	7	cell: 32-40				17.5	35		1	16 828	6; HD fac.=0.5
<i>Centrales, unidentified</i>		A	cylinder	8	cell: 40-50				22.5	45		1	35 767	6; HD fac.=0.5
<i>Centrales, unidentified</i>		A	cylinder	9	cell: 50-60				27.5	55		1	65 302	6; HD fac.=0.5
<i>Centrales, unidentified</i>		A	cylinder	10	cell: 60-70				19.5	65		1	64 674	6; HD fac.=0.3
<i>Centrales, unidentified</i>		A	cylinder	11	cell: 70-90				24	80		1	120 576	6; HD fac.=0.3
<i>Centrales, unidentified</i>		A	cylinder	12	cell: 90-110				30	100		1	235 500	6; HD fac.=0.3
Order BACILLARIALES (PENNALES)														
<i>Achnanthes taeniata</i>	Grunow in Cleve & Grunow 1880	A	parallelepiped	1	cell: 15-20x3	16		4	3			1	192	
<i>Achnanthes taeniata</i>	Grunow in Cleve & Grunow 1880	A	parallelepiped	2	cell: 15-20x4	17		5	4			1	340	

		Trophy	Geometric shape	Size class No	Cell size range, μm	Length, μm		Width μm	Height μm	Diameter, μm		Number of cells/ counting unit	Calculated volume, μm^3	Comment
						l ₁	l ₂	w	h	d ₁	d ₂			
<i>Achnanthes taeniata</i>	Grunow in Cleve & Grunow 1880	A	parallelepiped	3	cell: 25-30x4	27		5	4			1	540	
<i>Achnanthes taeniata</i>	Grunow in Cleve & Grunow 1880	A	parallelepiped	4	cell: 12-15x5	14		6	5			1	420	
<i>Achnanthes taeniata</i>	Grunow in Cleve & Grunow 1880	A	parallelepiped	5	cell: 15-20x5	17		6	5			1	510	
<i>Achnanthes taeniata</i>	Grunow in Cleve & Grunow 1880	A	parallelepiped	6	cell: 20-25x5	23		6	5			1	690	
<i>Achnanthes taeniata</i>	Grunow in Cleve & Grunow 1880	A	parallelepiped	7	cell: 15-20x6	17.5		7	6			1	735	
<i>Achnanthes taeniata</i>	Grunow in Cleve & Grunow 1880	A	parallelepiped	8	cell: 20-25x6	22		7	6			1	924	
<i>Achnanthes taeniata</i>	Grunow in Cleve & Grunow 1880	A	parallelepiped	9	cell: 25-30x7	27		8	7			1	1 512	
<i>Achnanthes taeniata</i>	Grunow in Cleve & Grunow 1880	A	parallelepiped	10	cell: 15-20x8	17		9	8			1	1 224	
<i>Achnanthes taeniata</i>	Grunow in Cleve & Grunow 1880	A	parallelepiped	11	cell: 25x10	25		11	10			1	2 750	
<i>Achnanthes spp.</i>		A	parallelepiped	1	cell: 10x2-3	10		5	3			1	150	HD fac.=0.6
<i>Achnanthes spp.</i>		A	parallelepiped	2	cell: 12-17x2.5-3.5	15		5	3			1	225	HD fac.=0.6
<i>Achnanthes spp.</i>		A	parallelepiped	3	cell: 17-22x3.5-4.5	20		6	4.2			1	504	HD fac.=0.7
<i>Achnanthes spp.</i>		A	parallelepiped	4	cell: 25-35x4.5-6.5	30		7	4.9			1	1 029	HD fac.=0.7
<i>Amphiprora paludosa v. paludosa</i>	W. Smith 1853	A	oval cylinder	1	cell: 28-36				12	32	14	1	4 220	8
<i>Amphiprora paludosa v. paludosa</i>	W. Smith 1853	A	oval cylinder	2	cell: 55-60				20	58	31	1	28 046	8
<i>Amphora coffeaeformis</i>	(C.A. Agardh) Kützing 1844	A	oval cylinder		cell: 25-35				10	30	12	1	2 826	8
<i>Amphora commutata</i>	Grunow in Van Heurck 1880	A	oval cylinder		cell: 45-50				19.6	47.6	20	1	14 355	8
<i>Amphora ovalis</i>	(Kützing) Kützing 1844	A	oval cylinder		cell: 55-65				10	60	40	1	18 840	8
<i>Amphora spp.</i>		A	oval cylinder	1	cell: 18-22				8.4	19.6	8	1	1 086	8
<i>Amphora spp.</i>		A	oval cylinder	2	cell: 25-30				10	28	20	1	4 396	8

	Trophy	Geometric shape	Size class No	Cell size range, μm	Length, μm		Width μm	Height μm	Diameter, μm		Number of cells/ counting unit	Calculated volume, μm^3	Comment	
					l ₁	l ₂	w	h	d ₁	d ₂				
<i>Amphora</i> spp.	A	oval cylinder	3	cell: 33-37				14	35	18	1	6 924	8	
<i>Amphora</i> spp.	A	oval cylinder	4	cell: 45-50				25.2	47.5	32	1	30 069	8	
<i>Asterionella formosa</i>	Hassall 1850	A	parallelepiped	1	cell: 3-4x40-60	50		3.5	3.5		1	613		
<i>Asterionella formosa</i>	Hassall 1850	A	parallelepiped	2	cell: 3-4x60-80	70		3.5	3.5		1	858		
<i>Asterionella formosa</i>	Hassall 1850	A	parallelepiped	3	cell: 3-4x80-100	90		3.5	3.5		1	1 103		
<i>Asterionellopsis glacialis</i>	(Castracane) Round <i>in</i> Round, Crawford & D.G. Mann 1990	A	cone + half sphere - 40%	1	cell: 8x70				70	8	1	744		
<i>Asterionellopsis glacialis</i>	(Castracane) Round <i>in</i> Round, Crawford & D.G. Mann 1990	A	cone + half sphere - 40%	1	cell: 10x90				90	10	1	1 492		
<i>Asterionellopsis glacialis</i>	(Castracane) Round <i>in</i> Round, Crawford & D.G. Mann 1990	A	cone + half sphere - 40%	1	cell: 12x100				100	12	1	2 396		
<i>Asterionellopsis kariana</i>	(Grunow <i>in</i> Cleve & Grunow) Round <i>in</i> Round, Crawford & D.G. Mann 1990	A	parallelepiped	1	cell: 4x20-30	25		4	4		1	400		
<i>Asterionellopsis kariana</i>	(Grunow <i>in</i> Cleve & Grunow) Round <i>in</i> Round, Crawford & D.G. Mann 1990	A	parallelepiped	2	cell: 4x30-40	35		4	4		1	560		
<i>Asterionellopsis kariana</i>	(Grunow <i>in</i> Cleve & Grunow) Round <i>in</i> Round, Crawford & D.G. Mann 1990	A	parallelepiped	3	cell: 4x40-50	45		4	4		1	720		
<i>Caloneis silicula</i>	(Ehrenberg) P.T. Cleve 1894	A	oval cylinder		cell: 40-60				10	48	16	1	6 029	8
<i>Caloneis subsalina</i>	(Donkin) Hendey 1951	A	oval cylinder	1	cell: 40-60				12	47.6	25	1	11 299	8
<i>Caloneis subsalina</i>	(Donkin) Hendey 1951	A	oval cylinder	2	cell: 60-80				14	70	28	1	21 540	8
<i>Campylodiscus clypeus</i>	Ehrenberg 1840	A	oval cylinder		cell: 150-200				60	180	160	1	1 356 480	8

		Trophy	Geometric shape	Size class No	Cell size range, μm	Length, μm		Width μm	Height μm	Diameter, μm		Number of cells/ counting unit	Calculated volume, μm^3	Comment
						l ₁	l ₂	w	h	d ₁	d ₂			
<i>Cocconeis pediculus</i>	Ehrenberg 1838	A	oval cylinder		cell: 30-35				8.4	33.6	25	1	5 583	8
<i>Cocconeis placentula</i> v. <i>placentula</i>	Ehrenberg 1838	A	oval cylinder	1	cell: 23-27				7	25	20	1	2 693	8
<i>Cocconeis placentula</i> v. <i>placentula</i>	Ehrenberg 1838	A	oval cylinder	2	cell: 27-33				7	30	22	1	3 693	8
<i>Cocconeis placentula</i> v. <i>placentula</i>	Ehrenberg 1838	A	oval cylinder	3	cell: 33-37				8	35	28	1	6 154	8
<i>Cocconeis placentula</i> v. <i>placentula</i>	Ehrenberg 1838	A	oval cylinder	4	cell: 38-43				8.4	41	31	1	8 327	8
<i>Cocconeis placentula</i> v. <i>placentula</i>	Ehrenberg 1838	A	oval cylinder	5	cell: 43-47				8.4	45	31	1	9 199	8
<i>Cocconeis scutellum</i> v. <i>scutellum</i>	Ehrenberg 1838	A	oval cylinder		cell: 20				2	20	20	1	628	8
<i>Cylindrotheca closterium</i>	(Ehrenberg) Reimann & J. Lewin 1958	A	rotational ellipsoid	1	cell: <3x20-25				22	2.8		1	90	9
<i>Cylindrotheca closterium</i>	(Ehrenberg) Reimann & J. Lewin 1958	A	rotational ellipsoid	2	cell: 3-4x25-28				26.5	3.6		1	180	9
<i>Cylindrotheca closterium</i>	(Ehrenberg) Reimann & J. Lewin 1958	A	rotational ellipsoid	3	cell: 4-5x30-35				33	4.5		1	350	9
<i>Cylindrotheca closterium</i>	(Ehrenberg) Reimann & J. Lewin 1958	A	rotational ellipsoid	4	cell: 5-6x22-28				25	5.5		1	396	9
<i>Cymatopleura elliptica</i>	(Brebisson ex Kützing) W. Smith 1851	A	oval cylinder	1	cell: 70-90				25	79	52	1	80 620	8
<i>Cymatopleura elliptica</i>	(Brebisson ex Kützing) W. Smith 1851	A	oval cylinder	2	cell: 90-110				28	98	64	1	137 859	8
<i>Cymatopleura elliptica</i>	(Brebisson ex Kützing) W. Smith 1851	A	oval cylinder	3	cell: 110-130				30	120	76	1	214 776	8
<i>Cymatopleura solea</i>	(Brébisson) W. Smith 1851	A	oval cylinder	1	cell: 80-110x18-20				14	90	19	1	18 793	8
<i>Cymatopleura solea</i>	(Brébisson) W. Smith 1851	A	oval cylinder	2	cell: 110-140x32-35				26.6	130	34	1	90 937	8
<i>Cymbella cistula</i>	(Ehrenberg) Kirchner 1878	A	half parallelepi ped		cell: 60-70	65		22	20			1	14 300	8

		Trophy	Geometric shape	Size class No	Cell size range, μm	Length, μm		Width μm	Height μm	Diameter, μm		Number of cells/ counting unit	Calculated volume, μm^3	Comment
						l ₁	l ₂	w	h	d ₁	d ₂			
<i>Cymbella lanceolata</i>	(Ehrenberg) Kirchner 1878	A	half parallelepiped		cell: 100-150	128		27	27			1	46 656	8
<i>Cymbella obtusiuscula</i>	Kützing 1844	A	half parallelepiped		cell: 20-30	25		11	11			1	1 513	8
<i>Cymbella spp.</i>		A	half parallelepiped	1	cell: 20x5	20		5	5			1	250	
<i>Cymbella spp.</i>		A	half parallelepiped	2	cell: 120x25	120		25	25			1	37 500	
<i>Diatoma constricta</i>	(Grunow in Van Heurck) Williams 1985	A	parallelepiped		cell: 55-60	57		10	10			1	5 700	8
<i>Diatoma tenuis</i>	C.A. Agardh 1812	A	parallelepiped	1	cell: 3x30-50	40		3	3			1	360	
<i>Diatoma tenuis</i>	C.A. Agardh 1812	A	parallelepiped	2	cell: 3x50-70	60		3	3			1	540	
<i>Diatoma tenuis</i>	C.A. Agardh 1812	A	parallelepiped	3	cell: 3x70-90	80		3	3			1	720	
<i>Diatoma tenuis</i>	C.A. Agardh 1812	A	parallelepiped	4	cell: 4x30-50	40		4	4			1	640	
<i>Diatoma tenuis</i>	C.A. Agardh 1812	A	parallelepiped	5	cell: 4x50-70	60		4	4			1	960	
<i>Diatoma tenuis</i>	C.A. Agardh 1812	A	parallelepiped	6	cell: 4x70-90	80		4	4			1	1 280	
<i>Diatoma vulgaris v. vulgaris</i>	Bory 1824	A	parallelepiped	1	cell: 25-35x10	30		10	5.7			1	1 710	
<i>Diatoma vulgaris v. vulgaris</i>	Bory 1824	A	parallelepiped	2	cell: 40-50x14	45		14	14			1	8 820	
<i>Diploneis didyma</i>	(Ehrenberg) P.T. Cleve 1894	A	oval cylinder		cell: 40-45x20				12.6	42	20	1	8 308	
<i>Diploneis elliptica</i>	(Kützing) P.T. Cleve 1891	A	oval cylinder		cell: 30-40x20				14	35	20	1	7 693	
<i>Diploneis interrupta</i>	(Kützing) P.T. Cleve 1894	A	oval cylinder		cell: 50x14				14	50	14	1	7 693	
<i>Eunotia spp.</i>		A	parallelepiped		cell: 400-450	425		5.6	5.6			1	13 328	8
<i>Fragilaria capucina v. capucina</i>	Desmazières 1825	A	parallelepiped	1	cell: 3x25-30	28		3	2.8			1	235	

	Trophy	Geometric shape	Size class No	Cell size range, μm	Length, μm		Width μm	Height μm	Diameter, μm		Number of cells/ counting unit	Calculated volume, μm^3	Comment	
					l ₁	l ₂	w	h	d ₁	d ₂				
<i>Fragilaria capucina</i> v. <i>capucina</i>	Desmazières 1825	A	parallelepiped	2	cell: 4x30-40	36		4	4			1	576	
<i>Fragilaria crotonensis</i>	Kitton 1869	A	half parallelepiped	1	cell: 3-4x30-50	40		3.5	3			1	210	
<i>Fragilaria crotonensis</i>	Kitton 1869	A	half parallelepiped	2	cell: 4-5x50-80	65		4.5	4			1	585	
<i>Fragilaria crotonensis</i>	Kitton 1869	A	half parallelepiped	3	cell: 5-6x100-120	115		5.5	5			1	1 581	
<i>Fragilaria heidenii</i>	Østrup 1910	A	half parallelepiped	1	cell: 7x20-30	25		7	5			1	438	
<i>Fragilaria heidenii</i>	Østrup 1910	A	half parallelepiped	2	cell: 8-9x30-40	35		8.5	5.6			1	833	
<i>Fragilaria heidenii</i>	Østrup 1910	A	half parallelepiped	3	cell: 8-9x40-60	56		8.5	5			1	1 190	
<i>Fragilaria istvanffy</i>	Pantocsek 1902	A	half parallelepiped		cell: 8-9x30-40	35		8.5	5.6			1	833	
<i>Fragilaria</i> spp.		A	half parallelepiped	1	cell: 2-3x15-30	22		2.5	2.5			1	69	
<i>Fragilaria</i> spp.		A	half parallelepiped	2	cell: 3-4x30-40	35		3.5	3.5			1	214	
<i>Fragilaria</i> spp.		A	half parallelepiped	3	cell: 5-6x40-60	50		5.5	5			1	688	
<i>Fragilaria</i> spp.		A	half parallelepiped	4	cell: 7-8x60-80	70		7.5	5			1	1 313	
<i>Fragilariforma virescens</i>	(Ralfs) Williams & Round 1988	A	half parallelepiped	1	cell: 4-5x12-14	13		4.5	4.5			1	132	

		Trophy	Geometric shape	Size class No	Cell size range, μm	Length, μm		Width μm	Height μm	Diameter, μm		Number of cells/ counting unit	Calculated volume, μm^3	Comment
						l ₁	l ₂	w	h	d ₁	d ₂			
<i>Fragilariforma virescens</i>	(Ralfs) Williams & Round 1988	A	half parallelepiped	2	cell: 5-7x15-17	16		6	6			1	288	
<i>Fragilariforma virescens</i>	(Ralfs) Williams & Round 1988	A	half parallelepiped	3	cell: 7-9x18-22	20		8	8			1	640	
<i>Fragilariopsis cylindrus</i>	(Grunow in Cleve & Möller) W. Krieger in Helmcke & Krieger 1954	A	half parallelepiped		cell: 3-4x15-20	17		3.5	3.5			1	104	
<i>Gomphonema olivaceum</i> v. <i>olivaceum</i>	(Hornemann) Brébisson 1838	A	half parallelepiped		cell: 20-30x8-9	25		8.4	6			1	630	
<i>Grammatophora marina</i>	(Lyngbye) Kützing 1844	A	oval cylinder	1	cell: 28x14				14	28	14	1	4 308	
<i>Grammatophora marina</i>	(Lyngbye) Kützing 1844	A	oval cylinder	2	cell: 36x16				16	36	16	1	7 235	
<i>Gyrosigma acuminatum</i>	(Kützing) Rabenhorst 1853	A	parallelepiped-30%	1	cell: 50-80x8-10	65		9	6			1	2 457	
<i>Gyrosigma acuminatum</i>	(Kützing) Rabenhorst 1853	A	parallelepiped-30%	2	cell: 80-120x10-12	100		11	8.4			1	6 468	
<i>Gyrosigma acuminatum</i>	(Kützing) Rabenhorst 1853	A	parallelepiped-30%	3	cell: 120-170x12-14	140		13	9.6			1	12 230	
<i>Gyrosigma acuminatum</i>	(Kützing) Rabenhorst 1853	A	parallelepiped-30%	4	cell: 170-200x14-16	185		15	10			1	19 425	
<i>Gyrosigma attenuatum</i>	(Kützing) Rabenhorst 1853	A	parallelepiped-30%	1	cell: 100-120x15-17	110		16	9.6			1	11 827	HD fac.=0.6
<i>Gyrosigma attenuatum</i>	(Kützing) Rabenhorst 1853	A	parallelepiped-30%	2	cell: 120-150x17-20	135		18.5	11.1			1	19 406	HD fac.=0.6
<i>Gyrosigma attenuatum</i>	(Kützing) Rabenhorst 1853	A	parallelepiped-30%	3	cell: 150-200x20-25	196		22.5	13.5			1	41 675	HD fac.=0.6
<i>Gyrosigma attenuatum</i>	(Kützing) Rabenhorst 1853	A	parallelepiped-30%	4	cell: 200-250x25-30	224		27.5	16.5			1	71 148	HD fac.=0.6

		Trophy	Geometric shape	Size class No	Cell size range, μm	Length, μm		Width μm	Height μm	Diameter, μm		Number of cells/ counting unit	Calculated volume, μm^3	Comment
						l ₁	l ₂	w	h	d ₁	d ₂			
<i>Gyrosigma attenuatum</i>	(Kützing) Rabenhorst 1853	A	parallelepi ped-30%	5	cell: 250-300x30-35	275		33	19.8			1	125 780	HD fac.=0.6
<i>Gyrosigma attenuatum</i>	(Kützing) Rabenhorst 1853	A	parallelepi ped-30%	6	cell: 250-300x35-40	282		38	22.8			1	171 027	HD fac.=0.6
<i>Gyrosigma balticum</i>	(Ehrenberg) Rabenhorst 1853	A	parallelepi ped-10%		cell: 250-300x25	294		25	32			1	211 680	
<i>Gyrosigma eximium</i>	(Thwaites) Boyer 1927	A	parallelepi ped-10%		cell: 50-100x10-15	70		12	12			1	9 072	
<i>Gyrosigma macrum</i>	(W. Smith) Griffith & Henfrey 1856	A	half parallelepi ped	1	cell: 100-150x14	112		14	14			1	10 976	
<i>Gyrosigma macrum</i>	(W. Smith) Griffith & Henfrey 1856	A	half parallelepi ped	2	cell: 220-250x12	236		12	12			1	16 992	
<i>Gyrosigma strigilis</i>	(W. Smith) P.T. Cleve 1894	A	parallelepi ped-30%		cell: 300-400x30-40	362		35	30			1	133 035	
<i>Licmophora gracilis v. gracilis</i>	(Ehrenberg) Grunow 1867	A	half parallelepi ped		cell: 80-100x30-35	90		32.5	18			1	26 325	
<i>Licmophora spp.</i>		A	half parallelepi ped		cell: 55-65	60		20	45			1	27 000	
<i>Mastogloia smithii v. smithii</i>	Thwaites in W. Smith 1856	A	oval cylinder		cell: 10-15x25-35				12	30.8	12	1	3 482	
<i>Meridion circulare v. circulare</i>	(Greville) C.A. Agardh 1831	A	half parallelepi ped	1	cell: 20-25x10	22		10	7			1	770	
<i>Meridion circulare v. circulare</i>	(Greville) C.A. Agardh 1831	A	half parallelepi ped	2	cell: 25-30x8	28		8.3	8.3			1	964	
<i>Navicula capitata v. capitata</i>	Ehrenberg 1838	A	half parallelepi ped	1	cell: 6x19-21	20		6	6			1	360	

	Trophy	Geometric shape	Size class No	Cell size range, μm	Length, μm		Width μm	Height μm	Diameter, μm		Number of cells/ counting unit	Calculated volume, μm^3	Comment
					l ₁	l ₂	w	h	d ₁	d ₂			
<i>Navicula capitata</i> v. <i>capitata</i>	Ehrenberg 1838	A half parallelepiped	2	cell: 7x19-25	22		7	7			1	539	
<i>Navicula capitata</i> v. <i>capitata</i>	Ehrenberg 1838	A half parallelepiped	3	cell: 8x19-25	22		8.4	8.4			1	776	
<i>Navicula capitata</i> v. <i>capitata</i>	Ehrenberg 1838	A half parallelepiped	4	cell: 11-12x21-23	22		11.2	11.2			1	1 380	
<i>Navicula capitata</i> v. <i>hungarica</i>	(Grunow) R. Ross 1947	A oval cylinder		cell: 7-9x20-25				8.4	22.4	8	1	1 241	
<i>Navicula cari</i>	Ehrenberg 1836	A parallelepiped-40%		cell: 10-12x35-40	38		11	11.2			1	2 809	
<i>Navicula cryptocephala</i>	Kützing 1844	A parallelepiped-40%		cell: 8-10x30-35	33.6		9	5			1	907	
<i>Navicula digitoradiata</i>	(Gregory) Ralfs in Pritchard 1861	A oval cylinder		cell: 10-15x40-50				10	45	12	1	4 239	
<i>Navicula gregaria</i>	Donkin 1861	A parallelepiped-40%		cell: 6-8x12-17	14		7	7			1	412	
<i>Navicula lesmonensis</i>	Hustedt 1957	A parallelepiped-30%		cell: 6-8x18-20	19		7	6.4			1	596	
<i>Navicula meniscus</i>	Schumann 1867	A parallelepiped-20%		cell: 14-16x30-40	33		15	15			1	5 940	
<i>Navicula palpebralis</i>	Brébisson ex W. Smith 1853	A parallelepiped-40%		cell: 20-25x50-70	60		22.5	20			1	16 200	
<i>Navicula peregrina</i> v. <i>peregrina</i>	(Ehrenberg) Kützing 1844	A parallelepiped-40%	1	cell: 14x55-80	58		14	12			1	5 846	
<i>Navicula peregrina</i> v. <i>peregrina</i>	(Ehrenberg) Kützing 1844	A parallelepiped-40%	2	cell: 20x80-120	103		20	15			1	18 540	
<i>Navicula peregrina</i> v. <i>peregrina</i>	(Ehrenberg) Kützing 1844	A parallelepiped-40%	3	cell: 23x130	130		23	18			1	32 292	

		Trophy	Geometric shape	Size class No	Cell size range, μm	Length, μm		Width μm	Height μm	Diameter, μm		Number of cells/ counting unit	Calculated volume, μm^3	Comment
						l ₁	l ₂	w	h	d ₁	d ₂			
<i>Navicula platystoma</i>	Ehrenberg 1838	A	parallelepiped-20%		cell: 15-18x28-46	42		17	14			1	7 997	
<i>Navicula reinhardtii</i>	(Grunow) Grunow in Cleve & Möller 1877	A	oval cylinder		cell: 15-18x40-50				14	47.6	16.8	1	8 788	
<i>Navicula rhynchocephala</i>	Kützing 1844	A	half parallelepiped		cell: 15-16x40-50	47.6		15.5	15.5			1	5 718	
<i>Navicula transitans v. transitans</i>	Cleve 1883	A	parallelepiped-40%		cell: 6x30-40	35		6	6			1	756	
<i>Navicula tripunctata</i>	(O.F. Müller) Bory 1822	A	parallelepiped-20%		cell: 10x30-50	40		10	10			1	3 200	
<i>Navicula vanhoeffenii</i>	Gran 1897	A	parallelepiped-20%		cell: 12x30-50	40		12	7.8			1	2 995	
<i>Navicula viridula v. viridula</i>	(Kützing) Ehrenberg 1838	A	parallelepiped-30%		cell: 13-15x60-70	63.8		14	7			1	4 377	
<i>Navicula spp.</i>		A	parallelepiped-40%	1	cell: 4-6x20-30	25		5	5			1	375	
<i>Navicula spp.</i>		A	parallelepiped-40%	2	cell: 7-8x30-40	35		7.5	7.5			1	1 181	
<i>Navicula spp.</i>		A	parallelepiped-40%	3	cell: 10x30-40	35		10	10			1	2 100	
<i>Navicula spp.</i>		A	parallelepiped-40%	4	cell: 15x40-60	60		15	12			1	6 480	
<i>Navicula spp.</i>		A	parallelepiped-40%	5	cell: 20x70-90	80		20	15			1	14 400	
<i>Nitzschia acicularis v. acicularis</i>	(Kützing) W. Smith 1853	A	rotational ellipsoid		cell: 3x35-45				40	3		1	188	9

	Trophy	Geometric shape	Size class No	Cell size range, μm	Length, μm		Width μm	Height μm	Diameter, μm		Number of cells/ counting unit	Calculated volume, μm^3	Comment	
					l ₁	l ₂	w	h	d ₁	d ₂				
<i>Nitzschia frigida</i>	Grunow in Cleve & Grunow 1880	A	rotational ellipsoid		cell: 4-5x30-50				41	4.5		1	434	
<i>Nitzschia longissima</i>	(Brébisson in Kützing) Ralfs in Pritchard 1861	A	2 cones	1	cell: 3x65-85				75	3		1	177	
<i>Nitzschia longissima</i>	(Brébisson in Kützing) Ralfs in Pritchard 1861	A	2 cones	2	cell: 3x85-155				125	3		1	294	
<i>Nitzschia longissima</i>	(Brébisson in Kützing) Ralfs in Pritchard 1861	A	2 cones	3	cell: 4-6x85-110				96	4.8		1	579	
<i>Nitzschia paleacea</i>	(Grunow) Grunow in Van Heurck 1881	A	rotational ellipsoid		cell: 3x30-40				35	3		1	165	
<i>Nitzschia sigmaidea</i>	(Nitzsch) W. Smith 1853	A	parallelepiped		cell: 15-20x150-200	180		18	9			1	29 160	
<i>Nitzschia vitrea</i>	Norman 1861	A	parallelepiped-10%		cell: 7x40-60	50		7	7			1	2 205	
<i>Nitzschia spp.</i>		A	half parallelepiped	1	cell: 3x10	10		3	3			1	45	
<i>Nitzschia spp.</i>		A	half parallelepiped	2	cell: 3x40	40		3	3			1	180	
<i>Nitzschia spp.</i>		A	half parallelepiped	3	cell: 3x70	70		3	3			1	315	
<i>Nitzschia spp.</i>		A	half parallelepiped	4	cell: 7x40	40		7	7			1	980	
<i>Nitzschia spp.</i>		A	half parallelepiped	5	cell: 7x50	50		7	7			1	1 225	
<i>Nitzschia spp.</i>		A	half parallelepiped	6	cell: 8x20	20		8	8			1	640	
<i>Nitzschia spp.</i>		A	half parallelepiped	7	cell: 8x40	40		8	8			1	1 280	

	Trophy	Geometric shape	Size class No	Cell size range, μm	Length, μm		Width μm	Height μm	Diameter, μm		Number of cells/ counting unit	Calculated volume, μm^3	Comment
					l ₁	l ₂	w	h	d ₁	d ₂			
<i>Nitzschia spp.</i>	A	half parallelepiped	8	cell: 8x50	50		8	8			1	1 600	
<i>Nitzschia spp.</i>	A	half parallelepiped	9	cell: 8x100	100		8	8			1	3 200	
<i>Nitzschia spp.</i>	A	half parallelepiped	10	cell: 13x40	40		13	13			1	3 380	
<i>Nitzschia spp.</i>	A	half parallelepiped	11	cell: 13x50	50		13	13			1	4 225	
<i>Nitzschia spp.</i>	A	half parallelepiped	12	cell: 13x100	100		13	13			1	8 450	
<i>Pseudo-nitzschia delicatissima</i>	(P.T. Cleve) Heiden in Heiden & Kolbe 1928	A	parallelepiped-10%	cell: 1x50-60	55		1	1			1	50	
<i>Pseudo-nitzschia delicatissima</i>	(P.T. Cleve) Heiden in Heiden & Kolbe 1928	A	parallelepiped-10%	cell: 2x40-50	45		1.9	1.9			1	146	
<i>Pseudo-nitzschia delicatissima</i>	(P.T. Cleve) Heiden in Heiden & Kolbe 1928	A	parallelepiped-10%	cell: 2-3x50-60	55		2.5	2.5			1	309	
<i>Pseudo-nitzschia pseudodelicatissima</i>	(Hasle) Hasle 1993	A	parallelepiped-10%	cell: 1-2x50-70	60		1.5	1.5			1	122	
<i>Pseudo-nitzschia pungens</i>	(Grunow ex P.T. Cleve) Hasle 1993	A	parallelepiped-20%	cell: 3x100-120	110		3	3			1	792	
<i>Pseudo-nitzschia pungens</i>	(Grunow ex P.T. Cleve) Hasle 1993	A	parallelepiped-20%	cell: 4x85-130	120		4	3			1	1 152	
<i>Pseudo-nitzschia pungens</i>	(Grunow ex P.T. Cleve) Hasle 1993	A	parallelepiped-20%	cell: 5-6x120-130	120		5.5	5			1	2 640	
<i>Pseudo-nitzschia pungens</i>	(Grunow ex P.T. Cleve) Hasle 1993	A	parallelepiped-20%	cell: 8x130-150	140		8	5			1	4 480	

		Trophy	Geometric shape	Size class No	Cell size range, μm	Length, μm		Width μm	Height μm	Diameter, μm		Number of cells/ counting unit	Calculated volume, μm^3	Comment
						l ₁	l ₂	w	h	d ₁	d ₂			
<i>Pseudo-nitzschia seriata</i> f. <i>seriata</i>	(P.T. Cleve) H. Peragallo in H. & M. Peragallo 1900	A	parallelepi ped-20%	1	cell: 5x90-110	100		5	5			1	2 000	
<i>Pseudo-nitzschia seriata</i> f. <i>seriata</i>	(P.T. Cleve) H. Peragallo in H. & M. Peragallo 1900	A	parallelepi ped-20%	2	cell: 6x100-110	105		6	6			1	3 024	
<i>Pseudo-nitzschia seriata</i> f. <i>seriata</i>	(P.T. Cleve) H. Peragallo in H. & M. Peragallo 1900	A	parallelepi ped-20%	3	cell: 8x80-100	90		8	8			1	4 608	
<i>Pseudo-nitzschia seriata</i> f. <i>seriata</i>	(P.T. Cleve) H. Peragallo in H. & M. Peragallo 1900	A	parallelepi ped-20%	4	cell: 10x110-120	115		10	10			1	9 200	
<i>Pseudo-nitzschia</i> spp.		A	parallelepi ped-20%	1	cell: 3x10	10		3	2			1	48	
<i>Pseudo-nitzschia</i> spp.		A	parallelepi ped-20%	2	cell: 3x40	40		3	2			1	192	
<i>Rhoicosphenia abbreviata</i>	(C.A. Agardh) Lange-Bertalot 1980	A	half parallelepi ped	1	cell: 23-27x5-6	24		5.5	5.5			1	363	
<i>Rhoicosphenia abbreviata</i>	(C.A. Agardh) Lange-Bertalot 1980	A	half parallelepi ped	2	cell: 23-27x10-12	25		11.2	6			1	840	
<i>Stausosira construens</i> v. <i>construens</i>	Ehrenberg 1843	A	half parallelepi ped		cell: 8-12x10-25	17		10	6			1	510	
<i>Stausosira construens</i> v. <i>binodis</i>	(Ehrenberg) Grunow 1862	A	half parallelepi ped		cell: 4-6x10-20	15		5	5			1	188	
<i>Stausosira construens</i> v. <i>venter</i>	(Ehrenberg) Hamilton 1992	A	oval cylinder		cell: 8-9x10-12				8.3	11.2	8.3	1	606	
<i>Surirella biseriata</i>	Brébisson in Brébisson & Godey 1836	A	parallelepi ped-20%	1	cell: 55-60x150-200	155		56	40			1	277 760	
<i>Surirella biseriata</i>	Brébisson in Brébisson & Godey 1836	A	parallelepi ped-20%	2	cell: 60-65x200-250	210		62.5	56			1	588 000	

		Trophy	Geometric shape	Size class No	Cell size range, μm	Length, μm		Width μm	Height μm	Diameter, μm		Number of cells/ counting unit	Calculated volume, μm^3	Comment
						l ₁	l ₂	w	h	d ₁	d ₂			
<i>Surirella capronii</i>	Brébisson in Kitton 1869	A	oval cylinder- 30%	1	cell: 60-65x130-150				55	140	62	1	262 331	
<i>Surirella capronii</i>	Brébisson in Kitton 1869	A	oval cylinder- 30%	2	cell: 70-75x150-170				67.2	160	72.8	1	430 119	
<i>Surirella capronii</i>	Brébisson in Kitton 1869	A	oval cylinder- 30%	3	cell: 80x170-190				72.8	184	80	1	588 853	
<i>Surirella crumena</i>	Brébisson ex Kützing 1849	A	oval cylinder	1	cell: 25-27x26-32				16.8	31	27	1	11 038	
<i>Surirella crumena</i>	Brébisson ex Kützing 1849	A	oval cylinder	2	cell: 48-50x49-52				28	51	49	1	54 928	
<i>Surirella minuta</i>	Brébisson in Kützing 1849	A	oval cylinder	1	cell: 10-13x15-20				11.2	16.8	11.2	1	1 654	
<i>Surirella minuta</i>	Brébisson in Kützing 1849	A	oval cylinder	2	cell: 13-15x20-30				14	26.6	14	1	4 093	
<i>Surirella robusta</i>	Ehrenberg 1841	A	oval cylinder		cell: 70-90x140-180				56	160	79	1	555 654	
<i>Surirella spp.</i>		A	oval cylinder	1	cell: 10x15				10	15	10	1	1 178	
<i>Surirella spp.</i>		A	oval cylinder	2	cell: 20x50				20	50	20	1	15 700	
<i>Surirella spp.</i>		A	oval cylinder	3	cell: 40x50				30	50	40	1	47 100	
<i>Surirella spp.</i>		A	oval cylinder	4	cell: 100x150				80	150	100	1	942 000	
<i>Synedra acus v. acus</i>	Kützing 1844	A	half parallelepiped	1	cell: 3-4x100-130	113		3.5	3.5			1	692	
<i>Synedra acus v. acus</i>	Kützing 1844	A	half parallelepiped	2	cell: 5x130-170	145		5	5			1	1 813	
<i>Synedra acus v. acus</i>	Kützing 1844	A	half parallelepiped	3	cell: 6x170-210	190		5.6	5.6			1	2 979	
<i>Synedra berlinensis</i>	Lemmermann 1900	A	half parallelepiped		cell: 2.5-3x30-40	36.4		2.8	2.8			1	143	

		Trophy	Geometric shape	Size class No	Cell size range, μm	Length, μm		Width μm	Height μm	Diameter, μm		Number of cells/ counting unit	Calculated volume, μm^3	Comment
						l ₁	l ₂	w	h	d ₁	d ₂			
<i>Synedra parasitica</i>	(W. Smith) Hustedt 1930	A	half parallelepiped		cell: 7x25-30	28		7	3.5			1	343	
<i>Synedra ulna v. ulna</i>	(Nitzsch) Ehrenberg 1832	A	half parallelepiped	1	cell: 5-10x80-130	110		7.5	6			1	2 475	
<i>Synedra ulna v. ulna</i>	(Nitzsch) Ehrenberg 1832	A	half parallelepiped	2	cell: 5-10x130-180	160		7.5	6			1	3 600	
<i>Synedra ulna v. ulna</i>	(Nitzsch) Ehrenberg 1832	A	half parallelepiped	3	cell: 5-10x180-230	210		7.5	6			1	4 725	
<i>Synedra ulna v. ulna</i>	(Nitzsch) Ehrenberg 1832	A	half parallelepiped	4	cell: 5-10x230-300	270		7.5	6			1	6 075	
<i>Tabellaria fenestrata</i>	(Lyngbye) Kützing 1844	A	parallelepiped	1	cell: 6x20-40	28		6	12			1	2 016	
<i>Tabellaria fenestrata</i>	(Lyngbye) Kützing 1844	A	parallelepiped	2	cell: 6x40-50	44.8		6	12			1	3 226	
<i>Tabellaria fenestrata</i>	(Lyngbye) Kützing 1844	A	parallelepiped	3	cell: 8x50-60	53.2		8.3	16			1	7 065	
<i>Tabularia fasciculata</i>	(C.A. Agardh) Williams & Round 1986	A	half parallelepiped	1	cell: 5-6x80-100	95.2		5.6	5.6			1	1 493	
<i>Tabularia fasciculata</i>	(C.A. Agardh) Williams & Round 1986	A	half parallelepiped	2	cell: 8-9x60-80	67.2		8.4	8.4			1	2 371	
<i>Tabularia fasciculata</i>	(C.A. Agardh) Williams & Round 1986	A	half parallelepiped	3	cell: 8-9x150-200	174		8.4	8.4			1	6 139	
<i>Tabularia fasciculata</i>	(C.A. Agardh) Williams & Round 1986	A	half parallelepiped	4	cell: 12x300-350	336		12	12			1	24 192	
<i>Tabularia tabulata</i>	(C.A. Agardh) Snoeijs 1992	A	half parallelepiped	1	cell: 8x100-150	129		8	8			1	4 128	
<i>Tabularia tabulata</i>	(C.A. Agardh) Snoeijs 1992	A	half parallelepiped	2	cell: 14x200-250	238		14	10			1	16 660	

		Trophy	Geometric shape	Size class No	Cell size range, μm	Length, μm		Width μm	Height μm	Diameter, μm		Number of cells/ counting unit	Calculated volume, μm^3	Comment
						l ₁	l ₂	w	h	d ₁	d ₂			
<i>Thalassionema nitzschioides</i>	(Grunow) Grunow ex Hustedt 1932	A	parallelepiped	1	cell: 2x50-55	53		2	2			1	212	
<i>Thalassionema nitzschioides</i>	(Grunow) Grunow ex Hustedt 1932	A	parallelepiped	2	cell: 2-3x55-70	60		2.5	2.5			1	375	
<i>Thalassionema nitzschioides</i>	(Grunow) Grunow ex Hustedt 1932	A	parallelepiped	3	cell: 3x40-50	45		3	3			1	405	
<i>Thalassionema nitzschioides</i>	(Grunow) Grunow ex Hustedt 1932	A	parallelepiped	4	cell: 4x30-50	40		4	4			1	640	
<i>Thalassionema nitzschioides</i>	(Grunow) Grunow ex Hustedt 1932	A	parallelepiped	5	cell: 4x50-80	65		4	4			1	1 040	
<i>Thalassionema nitzschioides</i>	(Grunow) Grunow ex Hustedt 1932	A	parallelepiped	6	cell: 5x40-50	45		5	5			1	1 125	
<i>Thalassionema nitzschioides</i>	(Grunow) Grunow ex Hustedt 1932	A	parallelepiped	7	cell: 6x40-60	50		6	5			1	1 500	
<i>Thalassionema nitzschioides</i>	(Grunow) Grunow ex Hustedt 1932	A	parallelepiped	8	cell: 8x40-60	50		8	6			1	2 400	
<i>Pennales</i> , unidentified		A	half parallelepiped	1	cell: 4-5x10-15	12.5		4.5	4			1	113	
<i>Pennales</i> , unidentified		A	half parallelepiped	2	cell: 4-6x15-25	20		5	4			1	200	
<i>Pennales</i> , unidentified		A	half parallelepiped	3	cell: 4-6x25-35	30		5	4			1	300	
<i>Pennales</i> , unidentified		A	half parallelepiped	4	cell: 4-6x35-50	42		5	4			1	420	
<i>Pennales</i> , unidentified		A	half parallelepiped	5	cell: 4-6x50-70	60		5	4			1	600	
<i>Pennales</i> , unidentified		A	half parallelepiped	6	cell: 4-6x70-100	85		5	4			1	850	
<i>Pennales</i> , unidentified		A	half parallelepiped	7	cell: 7-9x25-35	30		8	7			1	840	
<i>Pennales</i> , unidentified		A	half parallelepiped	8	cell: 7-9x35-50	42		8	7			1	1 176	

	Trophy	Geometric shape	Size class No	Cell size range, μm	Length, μm		Width μm	Height μm	Diameter, μm		Number of cells/ counting unit	Calculated volume, μm^3	Comment
					l ₁	l ₂	w	h	d ₁	d ₂			
<i>Pennales</i> , unidentified	A	half parallelepiped	9	cell: 7-9x50-70	60		8	7			1	1 680	
<i>Pennales</i> , unidentified	A	half parallelepiped	10	cell: 7-9x70-100	85		8	7			1	2 380	
<i>Pennales</i> , unidentified	A	half parallelepiped	11	cell: 9-12x25-35	30		10.5	8			1	1 260	
<i>Pennales</i> , unidentified	A	half parallelepiped	12	cell: 9-12x35-50	42		10.5	8			1	1 764	
<i>Pennales</i> , unidentified	A	half parallelepiped	13	cell: 9-12x50-70	60		10.5	8			1	2 520	
<i>Pennales</i> , unidentified	A	half parallelepiped	14	cell: 9-12x70-100	85		10.5	8			1	3 570	
<i>Pennales</i> , unidentified	A	half parallelepiped	15	cell: 12-20x40-60	50		16	12			1	4 800	
<i>Pennales</i> , unidentified	A	half parallelepiped	16	cell: 12-20x60-90	85		16	12			1	8 160	
<i>Pennales</i> , unidentified	A	half parallelepiped	17	cell: 12-20x90-120	105		16	12			1	10 080	
<i>Pennales</i> , unidentified	A	half parallelepiped	18	cell: 20-30x40-60	50		25	15			1	9 375	
<i>Pennales</i> , unidentified	A	half parallelepiped	19	cell: 20-30x60-90	85		25	15			1	15 938	
<i>Pennales</i> , unidentified	A	half parallelepiped	20	cell: 20-30x90-120	105		25	15			1	19 688	
Class Tribophyceae (Xanthophyceae, Heterokontae)													

	Trophy	Geometric shape	Size class No	Cell size range, μm	Length, μm		Width μm	Height μm	Diameter, μm		Number of cells/ counting unit	Calculated volume, μm^3	Comment
					l ₁	l ₂	w	h	d ₁	d ₂			
Order MISCHOCOCCALES (HETEROCOCCALES)													
<i>Goniochloris mutica</i>	(A. Braun) Fott 1960	A	half parallelepiped	cell: 10-12	11.4		11.4	3			1	195	
Class Raphidophyceae (Chloromonadophyceae)													
Order CHATTONELLALES													
<i>Chattonella cf. verruculosa</i>	Hara et Chihara	A	cone + half sphere	1 cell: 10-20				15	10		1	523	
<i>Chattonella cf. verruculosa</i>	Hara et Chihara	A	cone + half sphere	2 cell: 20-30				25	14		1	1 641	
<i>Chattonella cf. verruculosa</i>	Hara et Chihara	A	cone + half sphere	3 cell: 30-40				35	17		1	3 290	
<i>Heterosigma akashiwo</i>	(Hada) Hada 1987	A	sphere	1 cell: 15-25					20		1	4 187	
Division EUGLENOPHYTA													
Class Euglenophyceae													
Order EUGLENALES													
<i>Colacium vesiculosum</i>	Ehrenberg 1838	A	rotational ellipsoid	cell: 7x14				14	7		1	359	
<i>Euglena acus</i>	Ehrenberg 1830	A	cone	cell: 7-9x80-120				95	8		1	1 591	
<i>Euglena oxyuris</i>	Schmarda 1846	A	cone	cell: 20-22x120-160				140	21		1	16 155	
<i>Euglena viridis</i>	(O.F. Müller) Ehrenberg 1830	A	rotational ellipsoid	cell: 20-25x50-60				56	22.4		1	7 352	
<i>Euglena spp.</i>		A	cone	1 cell: 8x45-55				50	8		1	837	
<i>Euglena spp.</i>		A	cone	2 cell: 10x60-80				70	10		1	1 832	
<i>Euglena spp.</i>		A	cone	3 cell: 15x40-60				50	15		1	2 944	
<i>Euglena spp.</i>		A	cone	4 cell: 14-15x60-80				70	14.5		1	3 851	
<i>Euglena spp.</i>		A	cone	5 cell: 20-25x60-80				70	22		1	8 865	

		Trophy	Geometric shape	Size class No	Cell size range, μm	Length, μm		Width μm	Height μm	Diameter, μm		Number of cells/ counting unit	Calculated volume, μm^3	Comment
						l ₁	l ₂	w	h	d ₁	d ₂			
<i>Eutreptia lanowii</i>	Steuer 1904	A	rotational ellipsoid		cell: 11-12x15-20				16.8	11.4		1	1 143	
<i>Eutreptia viridis</i>	Perty 1852	A	rotational ellipsoid		cell: 20-25x50-60				56	22.4		1	14 705	
<i>Eutreptia spp.</i>		A	cone	1	cell: 5x20				20	5		1	131	
<i>Eutreptia spp.</i>		A	rotational ellipsoid	2	cell: 5-7x15-20				17.5	6		1	330	
<i>Eutreptia spp.</i>		A	rotational ellipsoid	3	cell: 5-7x20-25				22.5	6		1	424	
<i>Eutreptia spp.</i>		A	rotational ellipsoid	4	cell: 7-9x15-20				17.5	8		1	586	
<i>Eutreptia spp.</i>		A	rotational ellipsoid	5	cell: 7-9x20-30				25	8		1	837	
<i>Eutreptia spp.</i>		A	rotational ellipsoid	6	cell: 9-11x15-20				17.5	10		1	916	
<i>Eutreptia spp.</i>		A	rotational ellipsoid	7	cell: 9-11x20-40				30	10		1	1 570	
<i>Eutreptia spp.</i>		A	rotational ellipsoid	8	cell: 11-13x40-60				50	12		1	3 768	
<i>Eutreptia spp.</i>		A	rotational ellipsoid	9	cell: 13-15x40-60				50	14		1	5 129	
<i>Eutreptia spp.</i>		A	rotational ellipsoid	10	cell: 15-17x40-60				50	16		1	6 699	
<i>Eutreptia spp.</i>		A	rotational ellipsoid	11	cell: 17-22x60-80				70	19		1	13 225	
<i>Eutreptia spp.</i>		A	rotational ellipsoid	12	cell: 22-27x60-80				70	24.5		1	21 989	

	Trophy	Geometric shape	Size class No	Cell size range, μm	Length, μm		Width μm	Height μm	Diameter, μm		Number of cells/ counting unit	Calculated volume, μm^3	Comment
					l ₁	l ₂	w	h	d ₁	d ₂			
<i>Eutreptia</i> spp.	A	rotational ellipsoid	13	cell: 27-32x60-80				70	29.5		1	31 880	
<i>Eutreptiella</i> spp.	A	rotational ellipsoid	1	cell: 5-7x10-15				12.5	6		1	236	
<i>Eutreptiella</i> spp.	A	rotational ellipsoid	2	cell: 5-7x15-20				17.5	6		1	330	
<i>Eutreptiella</i> spp.	A	rotational ellipsoid	3	cell: 5-7x20-25				22.5	6		1	424	
<i>Eutreptiella</i> spp.	A	rotational ellipsoid	4	cell: 7-9x15-20				17.5	8		1	586	
<i>Eutreptiella</i> spp.	A	rotational ellipsoid	5	cell: 7-9x20-25				22.5	8		1	754	
<i>Eutreptiella</i> spp.	A	rotational ellipsoid	6	cell: 7-9x25-30				27.5	8		1	921	
<i>Eutreptiella</i> spp.	A	rotational ellipsoid	7	cell: 9-11x10-15				12.5	10		1	654	
<i>Eutreptiella</i> spp.	A	rotational ellipsoid	8	cell: 9-11x15-20				17.5	10		1	916	
<i>Eutreptiella</i> spp.	A	rotational ellipsoid	9	cell: 9-11x20-30				25	10		1	1 308	
<i>Eutreptiella</i> spp.	A	rotational ellipsoid	10	cell: 9-11x30-40				35	10		1	1 832	
<i>Eutreptiella</i> spp.	A	rotational ellipsoid	11	cell: 9-11x40-60				50	10		1	2 617	
<i>Eutreptiella</i> spp.	A	rotational ellipsoid	12	cell: 11-13x15-20				17.5	12		1	1 319	

	Trophy	Geometric shape	Size class No	Cell size range, μm	Length, μm		Width μm	Height μm	Diameter, μm		Number of cells/ counting unit	Calculated volume, μm^3	Comment
					l ₁	l ₂	w	h	d ₁	d ₂			
<i>Eutreptiella spp.</i>	A	rotational ellipsoid	13	cell: 11-13x20-30				25	12		1	1 884	
<i>Eutreptiella spp.</i>	A	rotational ellipsoid	14	cell: 11-13x30-40				35	12		1	2 638	
<i>Eutreptiella spp.</i>	A	rotational ellipsoid	15	cell: 13-17x40-60				50	15		1	5 888	
<i>Eutreptiella spp.</i>	A	rotational ellipsoid	16	cell: 17-23x50-70				60	19		1	11 335	
<i>Eutreptiella spp.</i>	A	rotational ellipsoid	17	cell: 23-27x60-70				65	25		1	21 260	
<i>Eutreptiella spp.</i>	A	rotational ellipsoid	18	cell: 27-33x70-80				75	30		1	35 325	
<i>Lepocinclis ovum</i>	(Ehrenberg) Lemmermann 1901	A cone	1	cell: 15-20x20-30				25.2	16.8		1	1 861	
<i>Lepocinclis ovum</i>	(Ehrenberg) Lemmermann 1901	A cone	2	cell: 22-27x45-50				47.6	25.2		1	7 910	
<i>Phacus longicauda</i>	(Ehrenberg) Dujardin 1841	A flattened ellipsoid		cell: 15-20x30-40	35				18	3	1	989	
<i>Phacus pleuronectes</i>	(O.F. Müller) Dujardin 1841	A flattened ellipsoid		cell: 30-40x35-45	40				35	5	1	3 663	
<i>Phacus pyrum</i>	(Ehrenberg) Stein 1878	A flattened ellipsoid		cell: 18-20x30-35	32				19.6	8.4	1	2 757	
<i>Phacus spp.</i>		A flattened ellipsoid	1	cell: 25-35x30-40	35				30	5	1	2 748	
<i>Phacus spp.</i>		A flattened ellipsoid	2	cell: 35-45x40-60	50				40	8	1	8 373	
<i>Trachelomonas hispida</i>	(Perty) Stein 1878 <i>emend.</i> Deflandre	A rotational ellipsoid		cell: 15-20x20-30				25	17		1	3 781	
<i>Trachelomonas volvocina</i>	Ehrenberg 1838	A sphere		cell: 8-12					10		1	523	
<i>Trachelomonas spp.</i>		A rotational ellipsoid	1	cell: 6-10x10-15				12.5	8.4		1	462	
<i>Trachelomonas spp.</i>		A sphere	2	cell: 10-20					15		1	1 766	

	Trophy	Geometric shape	Size class No	Cell size range, μm	Length, μm		Width μm	Height μm	Diameter, μm		Number of cells/ counting unit	Calculated volume, μm^3	Comment
					l ₁	l ₂	w	h	d ₁	d ₂			
<i>Euglenales</i> , unidentified	A	flattened ellipsoid	1	cell: 9x30	30				9	5	1	707	
<i>Euglenales</i> , unidentified	A	flattened ellipsoid	2	cell: 11x75	75				11	5	1	2 159	
<i>Euglenales</i> , unidentified	A	flattened ellipsoid	3	cell: 10x180	180				10	5	1	4 710	
<i>Euglenales</i> , unidentified	A	cone	4	cell: 5x50-70				60	5		1	393	
Division CHLOROPHYTA													
Class Prasinophyceae (Micromonadophyceae)													
Order MAMIELLALES													
<i>Mantoniella squamata</i>	(Manton & Parke) Desikachary 1972	A	rotational ellipsoid	cell: 3-5				4	3.5		1	26	
<i>Micromonas pusilla</i>	(Butcher) Manton & Parke 1960	A	rotational ellipsoid	cell: 1-3				2	1		1	1.0	
Order CHLORODENDRALES													
<i>Nephroselmis</i> spp.		A	rotational ellipsoid	cell: 3-5				2	4		1	17	
<i>Pachysphaera</i> spp.		A	sphere-20%	cell: 6-8					7		1	144	
<i>Pachysphaera</i> spp.		A	rotational ellipsoid	cell: 14-16x9-10				15	9.5		1	708	
<i>Pseudoscourfieldia marina</i>	(Thronsen) Manton 1975	A	flattened ellipsoid	cell: 3-4	3.4				2.6	1.3	1	6.0	
<i>Pseudoscourfieldia</i> spp.		A	flattened ellipsoid	cell: 3-4	3.4				2.6	1.3	1	6.0	
<i>Pseudoscourfieldia</i> spp.		A	flattened ellipsoid	cell: 4-6	5				4	2	1	21	
<i>Pterosperma</i> spp.		A	sphere	cell: 15					15		1	1 766	
<i>Pyramimonas virginica</i>	Pennick 1977	A	trapezoid	cell: 4x2	2	2	2	4			1	16	
<i>Pyramimonas virginica</i>	Pennick 1977	A	trapezoid	cell: 4x3	3	3	3	4			1	36	
<i>Pyramimonas</i> spp.		A	trapezoid	cell: 4x3	3	1	3	4			1	24	
<i>Pyramimonas</i> spp.		A	trapezoid	cell: 5-7x5	5	3	5	6			1	120	
<i>Pyramimonas</i> spp.		A	trapezoid	cell: 8-10x6	6	4	6	9			1	270	
<i>Pyramimonas</i> spp.		A	trapezoid	cell: 10-12x9	9	5.6	9	11			1	723	

	Trophy	Geometric shape	Size class No	Cell size range, μm	Length, μm		Width μm	Height μm	Diameter, μm		Number of cells/ counting unit	Calculated volume, μm^3	Comment	
					l ₁	l ₂	w	h	d ₁	d ₂				
<i>Tetraselmis cordiformis</i>	(H.J. Carter) F. Stein 1878	A	trapezoid	1	cell: 16-20	15	9	9	18			1	1 944	
Class Charophyceae														
Order KLEBSORMIDIALES														
<i>Elakatothrix gelatinosa</i>	Wille 1898	A	cone	1	cell: 5x16				16	5		1	105	
<i>Elakatothrix gelatinosa</i>	Wille 1898	A	cone	2	cell: 5x16				16	5		2	209	
<i>Elakatothrix gelatinosa</i>	Wille 1898	A	cone	3	cell: 5x16				16	5		4	419	
<i>Elakatothrix gelatinosa</i>	Wille 1898	A	cone	4	cell: 5x16				16	5		8	837	
<i>Elakatothrix gelatinosa</i>	Wille 1898	A	cone	5	cell: 5x16				16	5		16	1 675	
<i>Elakatothrix genevensis</i>	(Reverdin) Hindák	A	2 cones	1	cell: 3-4x15-20				18	3.5		1	58	
<i>Elakatothrix genevensis</i>	(Reverdin) Hindák	A	2 cones	2	cell: 3-4x15-20				18	3.5		2	115	
<i>Elakatothrix genevensis</i>	(Reverdin) Hindák	A	2 cones	3	cell: 4-6x25-35				30	5		1	196	
<i>Elakatothrix genevensis</i>	(Reverdin) Hindák	A	2 cones	4	cell: 4-6x25-35				30	5		2	393	
<i>Koliella longiseta</i> f. <i>longiseta</i>	Hindák	A	2 cones		cell: 2.5-3x100-150				129	2.8		1	265	
Order ZYGNEMATALES														
<i>Closterium acerosum</i>	(Schrank) Ehrenberg ex Ralfs 1848	A	2 cones	1	cell: 20-30x300-350				325	25.2		1	54 005	
<i>Closterium acerosum</i>	(Schrank) Ehrenberg ex Ralfs 1848	A	2 cones	2	cell: 30-35x500-600				550	32.5		1	152 012	
<i>Closterium aciculare</i>	T. West 1860	A	2 cones	1	cell: 5-6x350-400				380	5.6		1	3 118	
<i>Closterium aciculare</i>	T. West 1860	A	2 cones	2	cell: 6x500-550				532	6		1	5 011	
<i>Closterium aciculare</i>	T. West 1860	A	2 cones	3	cell: 6x650-700				677	6		1	6 377	
<i>Closterium acutum</i> v. <i>acutum</i>	Brébisson in Ralfs 1848	A	2 cones	1	cell: 4x100-150				126	4		1	528	
<i>Closterium acutum</i> v. <i>acutum</i>	Brébisson in Ralfs 1848	A	2 cones	2	cell: 5x100-150				129	5		1	844	
<i>Closterium acutum</i> v. <i>acutum</i>	Brébisson in Ralfs 1848	A	2 cones	3	cell: 6x100-150				132	6		1	1 243	
<i>Closterium acutum</i> v. <i>variabile</i>	(Lemmermann) W. Krieger 1935	A	2 cones	1	cell: 4x80-100				90	4		1	377	
<i>Closterium acutum</i> v. <i>variabile</i>	(Lemmermann) W. Krieger 1935	A	2 cones	2	cell: 5x120-180				150	5		1	981	
<i>Closterium gracile</i>	Brébisson ex Ralfs 1848	A	2 cones		cell: 5x150-200				182	5		1	1 191	
<i>Closterium lineatum</i>	Ehrenberg ex Ralfs 1848	A	2 cones		cell: 15-20x550-600				574	16.8		1	42 392	
<i>Closterium moniliferum</i>	(Bory) Ehrenberg ex Ralfs 1848	A	2 cones		cell: 40x250-350				300	40		1	125 600	
<i>Closterium parvulum</i>	Nägeli 1849	A	2 cones		cell: 10-12x90-110				100	11		1	3 166	

		Trophy	Geometric shape	Size class No	Cell size range, μm	Length, μm		Width μm	Height μm	Diameter, μm		Number of cells/ counting unit	Calculated volume, μm^3	Comment
						l ₁	l ₂	w	h	d ₁	d ₂			
<i>Closterium strigosum</i>	Brébisson 1856	A	2 cones	1	cell: 10-12x200-250				230	11.2		1	7 549	
<i>Closterium strigosum</i>	Brébisson 1856	A	2 cones	2	cell: 12-16x200-250				210	14		1	10 770	
<i>Closterium spp.</i>		A	2 cones	1	cell: 10-11x150-250				200	10		1	5 233	
<i>Closterium spp.</i>		A	2 cones	2	cell: 30x150-200				170	30		1	40 035	
<i>Cosmarium spp.</i>		A	flattened ellipsoid	1	cell: 20	20				15	7	1	1 099	
<i>Cosmarium spp.</i>		A	flattened ellipsoid	2	cell: 35	35				30	15	1	8 243	
<i>Cosmarium spp.</i>		A	flattened ellipsoid	3	cell: 70	70				50	15	1	27 475	
<i>Mougeotia spp.</i>		A	cylinder		cell: 9x75-95				85	9		1	5 405	
<i>Staurastrum spp.</i>		A	two truncated cones		cell: 20				10	14	11.2	1	2 503	
Class Chlorophyceae														
Order VOLVOCALES														
<i>Chlamydocapsa ampla</i>	(Kützing) Fott 1972	A	rotational ellipsoid	1	cell: 7x11				11	7		1	282	
<i>Chlamydocapsa ampla</i>	(Kützing) Fott 1972	A	rotational ellipsoid	2	cell: 7x11				11	7		4	1 128	
<i>Chlamydomonas spp.</i>		A	sphere	1	cell: 5-6					5.6		1	92	
<i>Chlamydomonas spp.</i>		A	sphere	2	cell: 6-10					8.4		1	310	
<i>Chlamydomonas spp.</i>		A	sphere	3	cell: 10-15					12.5		1	1 022	
<i>Chlamydomonas spp.</i>		A	rotational ellipsoid	4	cell: 3-5x5-8				6.5	4		1	54	
<i>Chlamydomonas spp.</i>		A	rotational ellipsoid	5	cell: 5-10x12				12	7.5		1	353	
<i>Chlamydomonas spp.</i>		A	rotational ellipsoid	6	cell: 12x15				15	12		1	1 130	
<i>Chlorogonium maximum</i>	Skuja 1939	A	cone	1	cell: 4x75-85				80	4		1	335	
<i>Chlorogonium maximum</i>	Skuja 1939	A	cone	2	cell: 5-6x75-85				80	5.6		1	656	
<i>Chlorogonium maximum</i>	Skuja 1939	A	cone	3	cell: 8-9x85-95				89.6	8.5		1	1 694	

		Trophy	Geometric shape	Size class No	Cell size range, μm	Length, μm		Width μm	Height μm	Diameter, μm		Number of cells/ counting unit	Calculated volume, μm^3	Comment
						l ₁	l ₂	w	h	d ₁	d ₂			
<i>Chlorogonium minimum</i>	Skuja 1939	A	cone	1	cell: 3-4x25-30				28	3.5		1	90	*
<i>Chlorogonium minimum</i>	Skuja 1939	A	cone	2	cell: 3x55-60				58	3		1	137	*
<i>Eudorina elegans</i>	Ehrenberg 1831	A	sphere	1	cell: 7-10					8.4		1	310	
<i>Eudorina elegans</i>	Ehrenberg 1831	A	sphere	2	cell: 10-15					12.6		1	1 047	
<i>Eudorina unicocca</i>	G.M. Smith 1931	A	sphere	1	cell: 8					8		1	268	
<i>Eudorina unicocca</i>	G.M. Smith 1931	A	sphere	2	cell: 9					9		1	382	
<i>Eudorina unicocca</i>	G.M. Smith 1931	A	sphere	3	cell: 10					10		1	523	
<i>Eudorina unicocca</i>	G.M. Smith 1931	A	sphere	4	cell: 11					11		1	697	
<i>Eudorina unicocca</i>	G.M. Smith 1931	A	sphere	5	cell: 12					12		1	904	
<i>Gonium pectorale</i>	O.F. Müller 1773	A	sphere	1	cell: 5-6					5.5		1	87	
<i>Gonium pectorale</i>	O.F. Müller 1773	A	sphere	2	cell: 5-6					5.5		4	348	
<i>Gonium pectorale</i>	O.F. Müller 1773	A	sphere	3	cell: 5-6					5.5		16	1 393	
<i>Gonium pectorale</i>	O.F. Müller 1773	A	sphere	4	cell: 9-10					9.5		1	449	
<i>Gonium pectorale</i>	O.F. Müller 1773	A	sphere	5	cell: 9-10					9.5		4	1 795	
<i>Gonium pectorale</i>	O.F. Müller 1773	A	sphere	6	cell: 9-10					9.5		16	7 179	
<i>Gonium sociale</i>	(Dujardin) Warming 1876	A	sphere	1	cell: 7-9					8		1	268	
<i>Gonium sociale</i>	(Dujardin) Warming 1876	A	sphere	2	cell: 7-9					8		4	1 072	
<i>Pandorina morum</i>	(O.F. Müller) Bory 1824	A	sphere	1	cell: 8					8		1	268	
<i>Pandorina morum</i>	(O.F. Müller) Bory 1824	A	sphere	2	cell: 8					8		8	2 144	
<i>Pandorina morum</i>	(O.F. Müller) Bory 1824	A	sphere	3	cell: 8					8		16	4 287	
<i>Pandorina morum</i>	(O.F. Müller) Bory 1824	A	sphere	4	cell: 9					9		1	382	
<i>Pandorina morum</i>	(O.F. Müller) Bory 1824	A	sphere	5	cell: 9					9		8	3 052	
<i>Pandorina morum</i>	(O.F. Müller) Bory 1824	A	sphere	6	cell: 9					9		16	6 104	
<i>Pandorina morum</i>	(O.F. Müller) Bory 1824	A	sphere	7	cell: 10					10		1	523	
<i>Pandorina morum</i>	(O.F. Müller) Bory 1824	A	sphere	8	cell: 10					10		8	4 187	
<i>Pandorina morum</i>	(O.F. Müller) Bory 1824	A	sphere	9	cell: 10					10		16	8 373	
<i>Pandorina morum</i>	(O.F. Müller) Bory 1824	A	sphere	10	cell: 11					11		1	697	
<i>Pandorina morum</i>	(O.F. Müller) Bory 1824	A	sphere	11	cell: 11					11		8	5 572	
<i>Pandorina morum</i>	(O.F. Müller) Bory 1824	A	sphere	12	cell: 11					11		16	11 145	
<i>Pandorina morum</i>	(O.F. Müller) Bory 1824	A	sphere	13	cell: 12					12		1	904	
<i>Pandorina morum</i>	(O.F. Müller) Bory 1824	A	sphere	14	cell: 12					12		8	7 235	
<i>Pandorina morum</i>	(O.F. Müller) Bory 1824	A	sphere	15	cell: 12					12		16	14 469	
<i>Pandorina morum</i>	(O.F. Müller) Bory 1824	A	sphere	16	cell: 13					13		1	1 150	
<i>Pandorina morum</i>	(O.F. Müller) Bory 1824	A	sphere	17	cell: 13					13		8	9 198	
<i>Pandorina morum</i>	(O.F. Müller) Bory 1824	A	sphere	18	cell: 13					13		16	18 396	
<i>Pandorina morum</i>	(O.F. Müller) Bory 1824	A	sphere	19	cell: 14					14		1	1 436	
<i>Pandorina morum</i>	(O.F. Müller) Bory 1824	A	sphere	20	cell: 14					14		8	11 488	
<i>Pandorina morum</i>	(O.F. Müller) Bory 1824	A	sphere	21	cell: 14					14		16	22 976	

		Trophy	Geometric shape	Size class No	Cell size range, μm	Length, μm		Width μm	Height μm	Diameter, μm		Number of cells/ counting unit	Calculated volume, μm^3	Comment
						l ₁	l ₂	w	h	d ₁	d ₂			
<i>Tetraspora lemmermannii</i>	Fott 1972	A	sphere		cell: 8-9					8.5		1	321	
Order CHLOROCOCCALES														
<i>Actinastrum hantzschii</i>	Lagerheim 1882	A	2 cones	1	cell: 2-3x10-15				12.5	2.5		1	20	
<i>Actinastrum hantzschii</i>	Lagerheim 1882	A	2 cones	2	cell: 2-3x15-20				17.5	2.5		1	29	
<i>Actinastrum hantzschii</i>	Lagerheim 1882	A	2 cones	3	cell: 2-3x20-25				22.5	2.5		1	37	
<i>Ankistrodesmus falcatus</i>	(Corda) Ralfs 1848	A	2 cones	1	cell: 2x35-45				40	2		1	42	
<i>Ankistrodesmus falcatus</i>	(Corda) Ralfs 1848	A	2 cones	2	cell: 3x25-35				28	3		1	66	
<i>Ankistrodesmus falcatus</i>	(Corda) Ralfs 1848	A	2 cones	3	cell: 4x30-35				32.5	4		1	136	
<i>Ankistrodesmus fusiformis</i>	Corda	A	2 cones		cell: 2x35-45				37.5	2		1	39	*
<i>Ankyra lanceolata</i>	(Korshikov) Fott 1957	A	2 cones		cell: 5x25-35				28	5		1	183	
<i>Choricystis chodatii</i>	(Jaag) Fott 1976	A	rotational ellipsoid	1	cell: 1x1-2				1.5	1		1	0.8	
<i>Choricystis chodatii</i>	(Jaag) Fott 1976	A	rotational ellipsoid	2	cell: 1x1-2				1.5	1		4	3.1	
<i>Choricystis chodatii</i>	(Jaag) Fott 1976	A	rotational ellipsoid	3	cell: 1x1-2				1.5	1		16	13	
<i>Choricystis coccoides</i>	(Rodhe & Skuja) Fott 1976	A	rotational ellipsoid	1	cell: 3x8				8	3		1	38	
<i>Choricystis coccoides</i>	(Rodhe & Skuja) Fott 1976	A	rotational ellipsoid	2	cell: 3x8				8	3		4	151	
<i>Choricystis coccoides</i>	(Rodhe & Skuja) Fott 1976	A	rotational ellipsoid	3	cell: 3x8				8	3		16	603	
<i>Closteriopsis longissima</i>	(Lemmermann) Lemmermann 1899	A	2 cones		cell: 5-6x80-100				90	5.5		1	712	
<i>Coelastrum astroideum</i>	De Notaris 1867	A	sphere	1	cell: 5					5		1	65	
<i>Coelastrum astroideum</i>	De Notaris 1867	A	sphere	2	cell: 6					6		1	113	
<i>Coelastrum astroideum</i>	De Notaris 1867	A	sphere	3	cell: 8					8		1	268	
<i>Coelastrum microporum</i>	Nägeli in A. Braun 1855	A	sphere		cell: 7-8					7.5		1	221	
<i>Coelastrum reticulatum</i>	(Dangeard) Senn 1899	A	sphere		cell: 7					7		1	180	
<i>Coelastrum sphaericum</i>	Nägeli 1849	A	sphere		cell: 12					12		1	904	
<i>Crucigenia quadrata</i>	Morren 1830	A	sphere	1	cell: 2-3					2.5		4	33	
<i>Crucigenia quadrata</i>	Morren 1830	A	sphere	2	cell: 4-5					4.5		4	191	

		Trophy	Geometric shape	Size class No	Cell size range, μm	Length, μm		Width μm	Height μm	Diameter, μm		Number of cells/ counting unit	Calculated volume, μm^3	Comment
						l ₁	l ₂	w	h	d ₁	d ₂			
<i>Crucigenia quadrata</i>	Morren 1830	A	sphere	3	cell: 5-6					5.5		4	348	
<i>Crucigenia quadrata</i>	Morren 1830	A	sphere	4	cell: 6-7					6.5		4	575	
<i>Crucigenia quadrata</i>	Morren 1830	A	sphere	5	cell: 8-9					8.5		4	1 286	
<i>Crucigenia tetrapedia</i>	(Kirchner) W. & G.S. West 1902	A	parallelepiped		cell: 5x5	5		5	2.5			4	250	
<i>Crucigeniella apiculata</i>	(Lemmermann) Komárek 1974	A	rotational ellipsoid		cell: 5-6x6-8				7	5.5		4	443	
<i>Crucigeniella rectangularis</i>	(Nägeli) Komárek 1974	A	rotational ellipsoid		cell: 4-5x5-7				6	4.5		4	254	
<i>Dactylosphaerium jurisii</i>	Hindák 1977	A	sphere		cell: 4-5					4.5		1	48	
<i>Desmodesmus abundans</i>	(Kirchner) Hegewald 2001	A	rotational ellipsoid	1	cell: 1.5x5-6				5.5	1.5		4	26	
<i>Desmodesmus abundans</i>	(Kirchner) Hegewald 2001	A	rotational ellipsoid	2	cell: 2x6-8				7	2		4	59	
<i>Desmodesmus abundans</i>	(Kirchner) Hegewald 2001	A	rotational ellipsoid	3	cell: 2.5x8-11				9.5	2.5		4	124	
<i>Desmodesmus armatus v. armatus</i>	(R. Chodat) Hegewald 2000	A	rotational ellipsoid	1	cell: 2.5-3x7-10				8.5	2.8		4	139	
<i>Desmodesmus armatus v. armatus</i>	(R. Chodat) Hegewald 2000	A	rotational ellipsoid	2	cell: 3-3.5x8-12				10	3.3		4	221	
<i>Desmodesmus armatus v. armatus</i>	(R. Chodat) Hegewald 2000	A	rotational ellipsoid	3	cell: 4-5x12-16				14	4.5		4	593	
<i>Desmodesmus armatus v. armatus</i>	(R. Chodat) Hegewald 2000	A	rotational ellipsoid	4	cell: 8-9x16-18				17	8.3		4	2 452	
<i>Desmodesmus armatus v. bicaudatus</i>	(Guglielmetti) Hegewald 2000	A	rotational ellipsoid		cell: 3x10-15				12.5	3		4	236	
<i>Desmodesmus armatus v. spinosus</i>	(Fritsch & Rich) Hegewald 2000	A	rotational ellipsoid		cell: 4-7x10-15				12.5	5.5		4	792	

		Trophy	Geometric shape	Size class No	Cell size range, μm	Length, μm		Width μm	Height μm	Diameter, μm		Number of cells/ counting unit	Calculated volume, μm^3	Comment
						l ₁	l ₂	w	h	d ₁	d ₂			
<i>Desmodesmus bicellularis</i>	(R. Chodat) An, Friedl & Hegewald 1999	A	rotational ellipsoid		cell: 2-3x4-6				5	2.5		2	33	
<i>Desmodesmus brasiliensis</i>	(Bohlin) Hegewald 2000	A	rotational ellipsoid		cell: 2.5-3x10-12				11	2.8		4	181	
<i>Desmodesmus communis</i>	(Hegewald) Hegewald 2000	A	rotational ellipsoid	1	cell: 3-4x10-12				11	3.5		4	282	
<i>Desmodesmus communis</i>	(Hegewald) Hegewald 2000	A	rotational ellipsoid	2	cell: 4-6x10-13				12	5		4	628	
<i>Desmodesmus communis</i>	(Hegewald) Hegewald 2000	A	rotational ellipsoid	3	cell: 4-6x13-17				15	5		4	785	
<i>Desmodesmus communis</i>	(Hegewald) Hegewald 2000	A	rotational ellipsoid	4	cell: 7x17-20				18.5	7		4	1 898	
<i>Desmodesmus costato-granulatus</i>	(Skuja) Hegewald 2000	A	rotational ellipsoid		cell: 2x6-8				7	2		4	59	
<i>Desmodesmus denticulatus</i> v. <i>denticulatus</i>	(Lagerheim 1882) An, Friedl & Hegewald 1999	A	rotational ellipsoid	1	cell: 3-4x10-15				12.5	3.5		4	321	
<i>Desmodesmus denticulatus</i> v. <i>denticulatus</i>	(Lagerheim 1882) An, Friedl & Hegewald 1999	A	rotational ellipsoid	2	cell: 4-5x10-15				12.5	4.5		4	530	
<i>Desmodesmus denticulatus</i> v. <i>denticulatus</i>	(Lagerheim 1882) An, Friedl & Hegewald 1999	A	rotational ellipsoid	3	cell: 5-6x12-14				13	5.5		4	823	
<i>Desmodesmus denticulatus</i> v. <i>denticulatus</i>	(Lagerheim 1882) An, Friedl & Hegewald 1999	A	rotational ellipsoid	4	cell: 6-8x13-15				14	7		4	1 436	
<i>Desmodesmus denticulatus</i> v. <i>denticulatus</i>	(Lagerheim 1882) An, Friedl & Hegewald 1999	A	rotational ellipsoid	5	cell: 8-10x12-15				13.5	9		4	2 289	
<i>Desmodesmus denticulatus</i> v. <i>linearis</i>	(Hansgirg) Hegewald 2000	A	rotational ellipsoid		cell: 5-6x10-12				11	5.5		4	697	

	Trophy	Geometric shape	Size class No	Cell size range, μm	Length, μm		Width μm	Height μm	Diameter, μm		Number of cells/ counting unit	Calculated volume, μm^3	Comment	
					l ₁	l ₂	w	h	d ₁	d ₂				
<i>Desmodesmus dispar</i>	(Brébisson) Hegewald 2000	A	rotational ellipsoid		cell: 5-7x12-14				13	6		4	980	
<i>Desmodesmus hystrix</i>	(Lagerheim) Hegewald 2000	A	rotational ellipsoid		cell: 2.5-3x10-12				11.2	2.8		4	184	
<i>Desmodesmus intermedius</i>	(R. Chodat) Hegewald 2000	A	rotational ellipsoid		cell: 1.5-2x5-8				6.5	1.8		4	44	
<i>Desmodesmus maximus</i>	(W. & G.S. West) Hegewald 2000	A	rotational ellipsoid	1	cell: 2-3x8-12				10	2.5		4	131	
<i>Desmodesmus maximus</i>	(W. & G.S. West) Hegewald 2000	A	rotational ellipsoid	2	cell: 4-5x8-12				10	4.5		4	424	
<i>Desmodesmus maximus</i>	(W. & G.S. West) Hegewald 2000	A	rotational ellipsoid	3	cell: 4-5x12-15				13.5	4.5		4	572	
<i>Desmodesmus maximus</i>	(W. & G.S. West) Hegewald 2000	A	rotational ellipsoid	4	cell: 6-7x15-18				16.5	6.5		4	1 459	
<i>Desmodesmus maximus</i>	(W. & G.S. West) Hegewald 2000	A	rotational ellipsoid	5	cell: 8-9x12-15				13.5	8.5		4	2 042	
<i>Desmodesmus maximus</i>	(W. & G.S. West) Hegewald 2000	A	rotational ellipsoid	6	cell: 8-9x18-22				20	8.5		4	3 025	
<i>Desmodesmus maximus</i>	(W. & G.S. West) Hegewald 2000	A	rotational ellipsoid	7	cell: 9-10x23-27				25	9.5		4	4 723	
<i>Desmodesmus maximus</i>	(W. & G.S. West) Hegewald 2000	A	rotational ellipsoid	8	cell: 10-12x28-30				29	10.5		4	6 693	
<i>Desmodesmus serratus</i>	Corda, An, Friedl & Hegewald 1999	A	rotational ellipsoid		cell: 4-5x12-15				13.5	4.5		4	572	
<i>Desmodesmus opoliensis</i> v. <i>opoliensis</i>	(P. Richter) Hegewald 2000	A	rotational ellipsoid	1	cell: 3-5x12-14				13	4		4	435	

	Trophy	Geometric shape	Size class No	Cell size range, μm	Length, μm		Width μm	Height μm	Diameter, μm		Number of cells/ counting unit	Calculated volume, μm^3	Comment	
					l ₁	l ₂	w	h	d ₁	d ₂				
<i>Desmodesmus opoliensis</i> v. <i>opoliensis</i>	(P. Richter) Hegewald 2000	A	rotational ellipsoid	2	cell: 6-7x15-20				17.5	6.5		4	1 548	
<i>Desmodesmus protuberans</i>	(Fritsch & Rich) Hegewald 2000	A	rotational ellipsoid		cell: 6-8x12-16				14	7		4	1 436	
<i>Desmodesmus spinosus</i>	(R. Chodat) Hegewald 2000	A	rotational ellipsoid		cell: 4-5x8-12				10.5	4.5		4	445	
<i>Dictyosphaerium ehrenbergianum</i>	Nägeli 1849	A	rotational ellipsoid	1	cell: 3-4x4-7				5.5	3.5		4	141	
<i>Dictyosphaerium ehrenbergianum</i>	Nägeli 1849	A	rotational ellipsoid	2	cell: 4-5x5-7				6	4.5		4	254	
<i>Dictyosphaerium elegans</i>	Bachmann 1913	A	rotational ellipsoid		cell: 3x5				5	3		4	94	
<i>Dictyosphaerium pulchellum</i>	H.C. Wood 1872	A	sphere	1	cell: 3-4					3.5		4	90	
<i>Dictyosphaerium pulchellum</i>	H.C. Wood 1872	A	sphere	2	cell: 4-5					4.5		4	191	
<i>Dictyosphaerium pulchellum</i>	H.C. Wood 1872	A	sphere	3	cell: 5-6					5.5		4	348	
<i>Dictyosphaerium pulchellum</i>	H.C. Wood 1872	A	sphere	4	cell: 6-7					6.5		4	575	
<i>Dictyosphaerium pulchellum</i>	H.C. Wood 1872	A	sphere	5	cell: 7-8					7.5		4	883	
<i>Dictyosphaerium subsolitarium</i>	Van Goor 1924	A	sphere		cell: 3					3		4	57	
<i>Franceia ovalis</i>	(Francé) Lemmermann 1898	A	rotational ellipsoid		cell: 8-9x12-16				14	8.5		1	529	
<i>Golenkinia radiata</i>	R. Chodat 1894	A	sphere		cell: 10-15					12.5		1	1 022	
<i>Granulocystopsis pseudocoronata</i>	(Korshikov) Hindák 1977	A	rotational ellipsoid		cell: 5-9x9-14				12.5	7		1	321	
<i>Kirchneriella contorta</i>	(Schmidle) Bohlin 1897	A	2 cones		cell: 2.5-3x10-12				11.2	2.8		1	23	
<i>Kirchneriella lunaris</i>	(Kirchner) Möbius 1894	A	2 cones		cell: 7x12-16				14	7		1	180	

		Trophy	Geometric shape	Size class No	Cell size range, μm	Length, μm		Width μm	Height μm	Diameter, μm		Number of cells/ counting unit	Calculated volume, μm^3	Comment
						l ₁	l ₂	w	h	d ₁	d ₂			
<i>Lagerheimia ciliata</i>	(Lagerheim) R. Chodat 1895	A	rotational ellipsoid		cell: 8-9x12-14				12.6	8.5		1	476	
<i>Lagerheimia citrifomis</i>	(Snow) Collins 1909	A	rotational ellipsoid		cell: 12-16x18-22				19.6	14		1	2 010	
<i>Lagerheimia genevensis</i>	(R. Chodat) R. Chodat 1895	A	rotational ellipsoid		cell: 3x5-6				5.5	3		1	26	
<i>Lagerheimia longiseta</i> v. <i>longiseta</i>	(Lemmermann) Wille 1909	A	rotational ellipsoid		cell: 8-9x10-12				11.2	8.5		1	423	
<i>Lagerheimia subsalsa</i>	Lemmermann 1898	A	rotational ellipsoid	1	cell: 3x6				6	3		1	28	
<i>Lagerheimia subsalsa</i>	Lemmermann 1898	A	rotational ellipsoid	2	cell: 4-5x7-9				8	4.5		1	85	
<i>Lagerheimia wratislaviensis</i>	Schröder 1897	A	rotational ellipsoid	1	cell: 3x4				4	3		1	19	
<i>Lagerheimia wratislaviensis</i>	Schröder 1897	A	rotational ellipsoid	2	cell: 3x5-6				5.5	3		1	26	
<i>Micractinium pusillum</i>	Fresenius 1858	A	sphere	1	cell: 3-4					3.5		1	22	
<i>Micractinium pusillum</i>	Fresenius 1858	A	sphere	2	cell: 5-6					5.5		1	87	
<i>Monoraphidium arcuatum</i>	(Korshikov) Hindák 1970	A	2 cones	1	cell: 1.5-2x15-20				17.5	1.8		1	14	
<i>Monoraphidium arcuatum</i>	(Korshikov) Hindák 1970	A	2 cones	2	cell: 1.5-2x25-30				27.5	1.8		1	22	
<i>Monoraphidium arcuatum</i>	(Korshikov) Hindák 1970	A	2 cones	3	cell: 2x35-45				40	2		1	42	
<i>Monoraphidium arcuatum</i>	(Korshikov) Hindák 1970	A	2 cones	4	cell: 4-4.5x50-60				55	4.3		1	266	
<i>Monoraphidium contortum</i>	(Thuret <i>in</i> Brébisson) Komárková-Legnerová 1969	A	2 cones	1	cell: 1.2-1.5x15-20				17.5	1.3		1	7.7	
<i>Monoraphidium contortum</i>	(Thuret <i>in</i> Brébisson) Komárková-Legnerová 1969	A	2 cones	2	cell: 1.5-2x20-30				25	1.8		1	20	
<i>Monoraphidium contortum</i>	(Thuret <i>in</i> Brébisson) Komárková-Legnerová 1969	A	2 cones	3	cell: 2-3x20-30				25	2.5		1	41	
<i>Monoraphidium contortum</i>	(Thuret <i>in</i> Brébisson) Komárková-Legnerová 1969	A	2 cones	4	cell: 3-4x20-30				25	3.5		1	80	
<i>Monoraphidium contortum</i>	(Thuret <i>in</i> Brébisson) Komárková-Legnerová 1969	A	2 cones	5	cell: 4-5x30-40				35	4.5		1	185	

		Trophy	Geometric shape	Size class No	Cell size range, μm	Length, μm		Width μm	Height μm	Diameter, μm		Number of cells/ counting unit	Calculated volume, μm^3	Comment
						l ₁	l ₂	w	h	d ₁	d ₂			
<i>Monoraphidium convolutum</i>	(Corda) Komárková-Legnerová 1969	A	2 cones	1	cell: 1.5-2x10-12				11	1.8		1	8.8	
<i>Monoraphidium convolutum</i>	(Corda) Komárková-Legnerová 1969	A	2 cones	2	cell: 3x7-8				7.5	3		1	18	
<i>Monoraphidium convolutum</i>	(Corda) Komárková-Legnerová 1969	A	2 cones	3	cell: 3-4x8-9				8.5	3.5		1	27	
<i>Monoraphidium convolutum</i>	(Corda) Komárková-Legnerová 1969	A	2 cones	4	cell: 4-5x9-12				10.5	4.5		1	56	
<i>Monoraphidium griffithii</i>	(Berkeley) Komárková-Legnerová 1969	A	2 cones	1	cell: 3-4x30-35				32.5	3.5		1	104	
<i>Monoraphidium griffithii</i>	(Berkeley) Komárková-Legnerová 1969	A	2 cones	2	cell: 3-4x60-80				70	3.5		1	224	
<i>Monoraphidium komarkovae</i>	Nygaard 1979	A	2 cones	1	cell: 1.5x30-50				40	1.5		1	24	
<i>Monoraphidium komarkovae</i>	Nygaard 1979	A	2 cones	2	cell: 1.5x50-80				65	1.5		1	38	
<i>Monoraphidium komarkovae</i>	Nygaard 1979	A	2 cones	3	cell: 2-3x30-50				40	2.5		1	65	
<i>Monoraphidium komarkovae</i>	Nygaard 1979	A	2 cones	4	cell: 2-3x50-80				70	2.5		1	114	
<i>Monoraphidium minutum</i>	(Nägeli) Komárková-Legnerová 1969	A	2 cones	1	cell: 1-2x5-7				6	1.5		1	3.5	
<i>Monoraphidium minutum</i>	(Nägeli) Komárková-Legnerová 1969	A	2 cones	2	cell: 2-3x7-10				8.5	2.5		1	14	
<i>Monoraphidium minutum</i>	(Nägeli) Komárková-Legnerová 1969	A	2 cones	3	cell: 3x10-20				15	2.8		1	31	
<i>Monoraphidium mirabile</i>	(W. & G.S. West) Pankow 1976	A	2 cones	1	cell: 2.5x85-95				90	2.5		1	147	
<i>Monoraphidium mirabile</i>	(W. & G.S. West) Pankow 1976	A	2 cones	2	cell: 3-3.5x55-65				60	3.2		1	161	
<i>Monoraphidium spp.</i>		A	2 cones	1	cell: 1-2x8-12				10	1.5		1	5.9	
<i>Monoraphidium spp.</i>		A	2 cones	2	cell: 1x50-60				55	1		1	14	
<i>Nephrochlamys subsolitaria</i>	(G.S. West) Korshikov 1953	A	rotational ellipsoid		cell: 2.5-3x5-7				6	2.8		1	25	
<i>Oocystis borgei</i>	Snow 1903	A	rotational ellipsoid	1	cell: 6-8x8-12				10	7		1	256	

		Trophy	Geometric shape	Size class No	Cell size range, μm	Length, μm		Width μm	Height μm	Diameter, μm		Number of cells/ counting unit	Calculated volume, μm^3	Comment
						l ₁	l ₂	w	h	d ₁	d ₂			
<i>Oocystis borgei</i>	Snow 1903	A	rotational ellipsoid	2	cell: 8-10x12-15				13.5	9		1	572	
<i>Oocystis borgei</i>	Snow 1903	A	rotational ellipsoid	3	cell: 10-12x15-17				16	11		1	1 013	
<i>Oocystis borgei</i>	Snow 1903	A	rotational ellipsoid	4	cell: 12-14x17-20				18.5	13		1	1 636	
<i>Oocystis lacustris</i>	R. Chodat 1897	A	rotational ellipsoid	1	cell: 6-8x10-12				11	7		1	282	
<i>Oocystis lacustris</i>	R. Chodat 1897	A	rotational ellipsoid	2	cell: 8-10x12-15				13.5	9		1	572	
<i>Oocystis lacustris</i>	R. Chodat 1897	A	rotational ellipsoid	3	cell: 8-10x20-30				25	9.6		1	1 206	
<i>Oocystis lacustris</i>	R. Chodat 1897	A	rotational ellipsoid	4	cell: 10-12x15-20				17.5	11		1	1 108	
<i>Oocystis lacustris</i>	R. Chodat 1897	A	rotational ellipsoid	5	cell: 12-14x25-35				32.5	13		1	2 874	
<i>Oocystis lacustris</i>	R. Chodat 1897	A	rotational ellipsoid	6	cell: 20-22x25-30				27.5	21		1	6 347	
<i>Oocystis parva</i>	W. & G.S. West 1898	A	rotational ellipsoid		cell: 5-7x8-12				10	6		1	188	
<i>Oocystis pelagica</i>	Lemmermann 1901	A	rotational ellipsoid		cell: 7-9x8-12				10	8		1	335	
<i>Oocystis rhomboidea</i>	Fott 1933	A	rotational ellipsoid		cell:3-4x8-10				9	3.5		1	58	
<i>Oocystis solitaria</i>	Wittrock in Wittrock & Nordstedt 1879	A	rotational ellipsoid	1	cell: 6-8x10-13				11.5	7		1	295	

		Trophy	Geometric shape	Size class No	Cell size range, μm	Length, μm		Width μm	Height μm	Diameter, μm		Number of cells/ counting unit	Calculated volume, μm^3	Comment
						l ₁	l ₂	w	h	d ₁	d ₂			
<i>Oocystis solitaria</i>	Wittrock in Wittrock & Nordstedt 1879	A	rotational ellipsoid	2	cell: 8-10x13-15				14	9		1	593	
<i>Oocystis solitaria</i>	Wittrock in Wittrock & Nordstedt 1879	A	rotational ellipsoid	3	cell: 10-12x15-20				17.5	11		1	1 108	
<i>Oocystis solitaria</i>	Wittrock in Wittrock & Nordstedt 1879	A	rotational ellipsoid	4	cell: 12-15x17-22				19.5	13.5		1	1 860	
<i>Oocystis solitaria</i>	Wittrock in Wittrock & Nordstedt 1879	A	rotational ellipsoid	5	cell: 15-20x22-25				23.5	17.5		1	3 766	
<i>Oocystis solitaria</i>	Wittrock in Wittrock & Nordstedt 1879	A	rotational ellipsoid	6	cell: 20-25x25-30				27.5	22.5		1	7 286	
<i>Oocystis submarina</i>	Lagerheim 1886	A	rotational ellipsoid	1	cell: 4-5x6-8				7	4.5		1	74	
<i>Oocystis submarina</i>	Lagerheim 1886	A	rotational ellipsoid	2	cell: 5-6x8-10				9	5.5		1	142	
<i>Oocystis submarina</i>	Lagerheim 1886	A	rotational ellipsoid	3	cell: 6-8x10-12				11	7		1	282	
<i>Oocystis spp.</i>		A	rotational ellipsoid	1	cell: 3-4x7				7	3.5		1	45	
<i>Oocystis spp.</i>		A	rotational ellipsoid	2	cell: 4-5x7-8				7.5	4.5		1	79	
<i>Oocystis spp.</i>		A	rotational ellipsoid	3	cell: 5-6x8-12				10	5.5		1	158	
<i>Oocystis spp.</i>		A	rotational ellipsoid	4	cell: 6-8x12-17				14.5	7		1	372	
<i>Pediastrum angulosum v. angulosum</i>	(Ehrenberg) Meneghini 1840	A	cylinder		coen.: 6-10x30-50				8	40		1	10 048	
<i>Pediastrum biradiatum</i>	Meyen 1829	A	cylinder	1	coen.: 10-12x30-50				11.2	40		1	14 067	

		Trophy	Geometric shape	Size class No	Cell size range, μm	Length, μm		Width μm	Height μm	Diameter, μm		Number of cells/ counting unit	Calculated volume, μm^3	Comment
						l ₁	l ₂	w	h	d ₁	d ₂			
<i>Pediastrum biradiatum</i>	Meyen 1829	A	cylinder	2	coen.: 14-18x50-80				16	65		1	53 066	
<i>Pediastrum boryanum</i> v. <i>boryanum</i>	(Turpin) Meneghini 1840	A	cylinder	1	coen.: <5x18-25				5	21.5		1	1 814	
<i>Pediastrum boryanum</i> v. <i>boryanum</i>	(Turpin) Meneghini 1840	A	cylinder	2	coen.: 5-7x25-35				6	30		1	4 239	
<i>Pediastrum boryanum</i> v. <i>boryanum</i>	(Turpin) Meneghini 1840	A	cylinder	3	coen.: 7-10x35-45				8.5	40		1	10 676	
<i>Pediastrum boryanum</i> v. <i>boryanum</i>	(Turpin) Meneghini 1840	A	cylinder	4	coen.: 10-15x45-65				12.5	55		1	29 683	
<i>Pediastrum boryanum</i> v. <i>boryanum</i>	(Turpin) Meneghini 1840	A	cylinder	5	coen.: 15-20x65-75				17.5	70		1	67 314	
<i>Pediastrum boryanum</i> v. <i>boryanum</i>	(Turpin) Meneghini 1840	A	cylinder	6	coen.: 20-25x75-100				22.5	87.5		1	135 229	
<i>Pediastrum boryanum</i> v. <i>longicorne</i>	Reinsch 1867	A	cylinder		coen.: 15-20x65-75				17.5	70		1	67 314	
<i>Pediastrum duplex</i> v. <i>duplex</i>	Meyen 1829	A	cylinder	1	coen.: <5x30-40				5	35		1	4 808	
<i>Pediastrum duplex</i> v. <i>duplex</i>	Meyen 1829	A	cylinder	2	coen.: 5-8x30-40				6.5	35		1	6 251	
<i>Pediastrum duplex</i> v. <i>duplex</i>	Meyen 1829	A	cylinder	3	coen.: 8-10x30-40				9	35		1	8 655	
<i>Pediastrum duplex</i> v. <i>duplex</i>	Meyen 1829	A	cylinder	4	coen.: 10-12x30-40				11	35		1	10 578	
<i>Pediastrum duplex</i> v. <i>duplex</i>	Meyen 1829	A	cylinder	5	coen.: 5-8x40-60				6.5	50		1	12 756	
<i>Pediastrum duplex</i> v. <i>duplex</i>	Meyen 1829	A	cylinder	6	coen.: 8-10x40-60				9	50		1	17 663	
<i>Pediastrum duplex</i> v. <i>duplex</i>	Meyen 1829	A	cylinder	7	coen.: 10-12x40-60				11	50		1	21 588	
<i>Pediastrum duplex</i> v. <i>duplex</i>	Meyen 1829	A	cylinder	8	coen.: 8-10x60-80				9	70		1	34 619	
<i>Pediastrum duplex</i> v. <i>duplex</i>	Meyen 1829	A	cylinder	9	coen.: 10-12x60-80				11	70		1	42 312	
<i>Pediastrum duplex</i> v. <i>duplex</i>	Meyen 1829	A	cylinder	10	coen.: 10-12x80-100				11	90		1	69 944	
<i>Pediastrum duplex</i> v. <i>duplex</i>	Meyen 1829	A	cylinder	11	coen.: 12-15x80-100				13.5	90		1	85 840	
<i>Pediastrum integrum</i>	Nägeli 1849	A	cylinder		coen.: 12-15x50-80				13.5	65		1	44 774	

		Trophy	Geometric shape	Size class No	Cell size range, μm	Length, μm		Width μm	Height μm	Diameter, μm		Number of cells/ counting unit	Calculated volume, μm^3	Comment
						l ₁	l ₂	w	h	d ₁	d ₂			
<i>Pediastrum kawraiskyi</i>	Schmidle 1897	A	cylinder		coen.: 15-20x60-80				17.5	70		1	67 314	
<i>Pediastrum simplex</i>	Meyen 1829	A	cylinder	1	coen.: 15-20x50-70				17.5	60		1	49 455	
<i>Pediastrum simplex</i>	Meyen 1829	A	cylinder	2	coen.: 25-30x70-90				27.5	80		1	138 160	
<i>Pediastrum tetras</i>	(Ehrenberg) Ralfs 1844	A	cylinder	1	coen.: 4-6x15-20				5	17.5		1	1 202	
<i>Pediastrum tetras</i>	(Ehrenberg) Ralfs 1844	A	cylinder	2	coen.: 4-6x20-35				5	27.5		1	2 968	
<i>Pediastrum tetras</i>	(Ehrenberg) Ralfs 1844	A	cylinder	3	coen.: 4-6x35-50				5	42.5		1	7 090	
<i>Pediastrum tetras</i>	(Ehrenberg) Ralfs 1844	A	cylinder	4	coen.: 6-10x15-20				8	17.5		1	1 923	
<i>Pediastrum tetras</i>	(Ehrenberg) Ralfs 1844	A	cylinder	5	coen.: 6-10x20-35				8	27.5		1	4 749	
<i>Pediastrum tetras</i>	(Ehrenberg) Ralfs 1844	A	cylinder	6	coen.: 10-12x20-35				11	27.5		1	6 530	
<i>Planctococcus sphaerocystiformis</i>	Korshikov 1953	A	sphere		cell: 6-8					7		1	180	
<i>Quadricoccus ellipticus</i>	Hortobágyi 1973	A	rotational ellipsoid	1	cell: 3x7				7	3		1	33	
<i>Quadricoccus ellipticus</i>	Hortobágyi 1973	A	rotational ellipsoid	2	cell: 4x8-9				8.3	4		1	69	
<i>Quadricoccus verrucosus</i>	Fott 1948	A	rotational ellipsoid		cell: 3x6				6	3		1	28	*
<i>Raphidocelis sigmoidea</i>	Hindak 1977	A	2 cones		cell: 2-4x8-12				10	3		1	24	*
<i>Scenedesmus acuminatus</i>	(Lagerheim) R. Chodat 1902	A	2 cones	1	cell: 2-4x10-15				12.5	3		4	118	
<i>Scenedesmus acuminatus</i>	(Lagerheim) R. Chodat 1902	A	2 cones	2	cell: 2-4x15-25				20	3		4	188	
<i>Scenedesmus acuminatus</i>	(Lagerheim) R. Chodat 1902	A	2 cones	3	cell: 4-5x10-15				12.5	5		4	265	
<i>Scenedesmus acuminatus</i>	(Lagerheim) R. Chodat 1902	A	2 cones	4	cell: 5-6x15-25				20	5.5		4	633	
<i>Scenedesmus acuminatus</i>	(Lagerheim) R. Chodat 1902	A	2 cones	5	cell: 6-7x15-25				20	6.5		4	884	
<i>Scenedesmus acutiformis</i>	Schröder 1897	A	2 cones		cell: 3-4x10-12				11	3.5		4	141	
<i>Scenedesmus apiculatus</i>	(W. & G.S. West) R. Chodat 1926 nom. illeg.	A	2 cones		cell: 6-8x15-25				20	7		4	1 026	
<i>Scenedesmus arcuatus v. arcuatus</i>	(Lemmermann) Lemmermann 1899	A	2 cones	1	cell: 5-7x8-13				10.5	6		4	396	
<i>Scenedesmus arcuatus v. arcuatus</i>	(Lemmermann) Lemmermann 1899	A	2 cones	2	cell: 5-7x13-18				15.5	6		4	584	

	Trophy	Geometric shape	Size class No	Cell size range, μm	Length, μm		Width μm	Height μm	Diameter, μm		Number of cells/ counting unit	Calculated volume, μm^3	Comment	
					l ₁	l ₂	w	h	d ₁	d ₂				
<i>Scenedesmus caudato-aculeolatus</i>	Chodat 1926	A	rotational ellipsoid	1	cell: 2-4x8-13				11.2	3		4	211	
<i>Scenedesmus ellipticus</i>	Corda 1835	A	rotational ellipsoid	1	cell: 2x4				4	2		4	33	
<i>Scenedesmus ellipticus</i>	Corda 1835	A	rotational ellipsoid	2	cell: 2-4x7-10				8.5	3		4	160	
<i>Scenedesmus ellipticus</i>	Corda 1835	A	rotational ellipsoid	3	cell: 4-6x10-15				12.5	5		4	654	
<i>Scenedesmus ellipticus</i>	Corda 1835	A	rotational ellipsoid	4	cell: 4-6x15-20				17.5	5		4	916	
<i>Scenedesmus ellipticus</i>	Corda 1835	A	rotational ellipsoid	5	cell: 6-8x15-20				17.5	7		4	1 795	
<i>Scenedesmus ellipticus</i>	Corda 1835	A	rotational ellipsoid	6	cell: 8-10x18-22				19	9		4	3 222	
<i>Scenedesmus obliquus</i>	(Turpin) Kützing 1833	A	2 cones	1	cell: 2-4x8-12				10	3		4	94	
<i>Scenedesmus obliquus</i>	(Turpin) Kützing 1833	A	2 cones	2	cell: 2-4x12-15				13.5	3		4	127	
<i>Scenedesmus obliquus</i>	(Turpin) Kützing 1833	A	2 cones	3	cell: 4-6x12-15				13	4.8		4	313	
<i>Scenedesmus obliquus</i>	(Turpin) Kützing 1833	A	2 cones	4	cell: 4-6x15-20				17.5	4.8		4	422	
<i>Scenedesmus obliquus</i>	(Turpin) Kützing 1833	A	2 cones	5	cell: 6-8x15-20				17.5	7		4	898	
<i>Scenedesmus obliquus</i>	(Turpin) Kützing 1833	A	2 cones	6	cell: 6-8x20-25				22.5	7		4	1 154	
<i>Scenedesmus obtusus</i>	Meyen 1829 <i>emend.</i> Hegewald <i>et al.</i> 1988	A	rotational ellipsoid	1	cell: 4-6x8-12				10	5		4	523	
<i>Scenedesmus obtusus</i>	Meyen 1829 <i>emend.</i> Hegewald <i>et al.</i> 1988	A	rotational ellipsoid	2	cell: 6-8x12-15				13.5	7		4	1 385	
<i>Scenedesmus obtusus</i>	Meyen 1829 <i>emend.</i> Hegewald <i>et al.</i> 1988	A	rotational ellipsoid	3	cell: 8-10x15-20				17.5	9		4	2 967	
<i>Scenedesmus parvus</i>	(G.M. Smith) Bourrelly <i>in</i> Bourrelly & Manguin 1952	A	rotational ellipsoid		cell: 2-3x6-8				7.2	2.5		4	94	

	Trophy	Geometric shape	Size class No	Cell size range, µm	Length, µm		Width µm	Height µm	Diameter, µm		Number of cells/ counting unit	Calculated volume, µm ³	Comment
					l ₁	l ₂	w	h	d ₁	d ₂			
<i>Scenedesmus spp.</i>	A	rotational ellipsoid	1	cell: 2-3x5-6				5.5	2.5		4	72	
<i>Scenedesmus spp.</i>	A	rotational ellipsoid	2	cell: 3-4x6-8				7	3.5		4	180	
<i>Scenedesmus spp.</i>	A	2 cones	3	cell: 4-5x8-12				10	4.5		4	212	
<i>Schroederia setigera</i>	(Schröder) Lemmermann 1898	A	2 cones	1	cell: 3-5x60-70			65	4		1	272	
<i>Schroederia setigera</i>	(Schröder) Lemmermann 1898	A	2 cones	2	cell: 5-7x70-90			80	6		1	754	
<i>Selenastrum bibrainum</i>	Reinsch 1867	A	2 cones		cell: 4-6x15-25			20	5		1	131	
<i>Selenastrum gracile</i>	Reinsch 1867	A	2 cones		cell: 1-3x15-20			16.8	2		1	18	
<i>Sphaerocystis planctonica</i>	(Korshikov) Bourrelly 1966	A	sphere		cell: 8-9				8.5		1	321	
<i>Sphaerocystis schroeteri</i>	R. Chodat 1897	A	sphere	1	cell: 5-6				5.5		1	87	
<i>Sphaerocystis schroeteri</i>	R. Chodat 1897	A	sphere	2	cell: 7-8				7.5		1	221	
<i>Sphaerocystis schroeteri</i>	R. Chodat 1897	A	sphere	3	cell: 9-10				9.5		1	449	
<i>Tetraëdron caudatum</i>	(Corda) Hansgirg 1888	A	parallelepiped-25%		cell: 12-16	14	14	5.6			1	823	
<i>Tetraëdron minimum</i>	(A. Braun) Hansgirg 1888	A	parallelepiped	1	cell: 8-10	9	9	8			1	648	
<i>Tetraëdron minimum</i>	(A. Braun) Hansgirg 1888	A	parallelepiped	2	cell: 10-15	12.5	12.5	10			1	1 563	
<i>Tetrastrum elegans</i>	Playfair 1917	A	sphere	1	cell: 2-4				2.8		4	46	
<i>Tetrastrum elegans</i>	Playfair 1917	A	sphere	2	cell: 4-6				5		4	262	
<i>Tetrastrum staurogeniaeforme</i>	(Schröder) Lemmermann 1900	A	sphere	1	cell: 3-4				3		4	57	
<i>Tetrastrum staurogeniaeforme</i>	(Schröder) Lemmermann 1900	A	sphere	2	cell: 4-6				5		4	262	
<i>Tetrastrum spp.</i>		A	sphere		cell: 4-5				4.5		4	191	
<i>Treubaria triappendiculata</i>	Bernard 1908	A	sphere	1	cell: 6-8				7		1	180	
<i>Treubaria triappendiculata</i>	Bernard 1908	A	sphere	2	cell: 8-10				9		1	382	
<i>Treubaria triappendiculata</i>	Bernard 1908	A	sphere	3	cell: 10-12				11		1	697	
<i>Treubaria triappendiculata</i>	Bernard 1908	A	sphere	4	cell: 12-14				13		1	1 150	
<i>Westella botryoides</i>	(W. West) De-Wildeman 1897	A	sphere	1	cell: 2-4				3		1	14	
<i>Westella botryoides</i>	(W. West) De-Wildeman 1897	A	sphere	2	cell: 4-6				5		1	65	
<i>Westella botryoides</i>	(W. West) De-Wildeman 1897	A	sphere	3	cell: 6-8				7		1	180	

		Trophy	Geometric shape	Size class No	Cell size range, μm	Length, μm		Width μm	Height μm	Diameter, μm		Number of cells/ counting unit	Calculated volume, μm^3	Comment
						l ₁	l ₂	w	h	d ₁	d ₂			
<i>Willea irregularis</i>	(Wille) Schmidle 1900	A	rotational ellipsoid	1	cell: 5-8x8-10				9	7		4	923	
<i>Willea irregularis</i>	(Wille) Schmidle 1900	A	rotational ellipsoid	2	cell: 8-10x10-12				11.4	9		4	1 933	
<i>Willea irregularis</i>	(Wille) Schmidle 1900	A	rotational ellipsoid	3	cell: 10-12x15-18				16.8	11.4		4	4 570	
Order MICROSPORALES														
<i>Planctonema lauterbornii</i>	Schmidle 1903	A	rotational ellipsoid	1	cell: 2-3x6-10				8	2.5		1	26	
<i>Planctonema lauterbornii</i>	Schmidle 1903	A	rotational ellipsoid	2	cell: 3-4x10-12				11	3.5		1	71	
<i>Planctonema lauterbornii</i>	Schmidle 1903	A	rotational ellipsoid	3	cell: 3-5x12-17				14.5	4		1	121	
<i>Planctonema lauterbornii</i>	Schmidle 1903	A	rotational ellipsoid	4	cell: 3-5x25-35				30	4		1	251	
<i>Planctonema lauterbornii</i>	Schmidle 1903	A	rotational ellipsoid	5	cell: 5-6x12-17				14.5	5.5		1	230	
<i>Planctonema lauterbornii</i>	Schmidle 1903	A	rotational ellipsoid	6	cell: 5-6x17-25				20	5.5		1	317	
Division ZOOMASTIGOPHORA														
Class Eбриidea														
Order EBRIIDA (ICBN: EBRIALES)														
<i>Ebria tripartita</i>	(Schumann) Lemmermann 1900	H	half sphere-30%	1	cell: 17-23					20		1	1 465	
<i>Ebria tripartita</i>	(Schumann) Lemmermann 1900	H	half sphere-30%	2	cell: 23-27					25		1	2 862	

		Trophy	Geometric shape	Size class No	Cell size range, μm	Length, μm		Width μm	Height μm	Diameter, μm		Number of cells/ counting unit	Calculated volume, μm^3	Comment
						l ₁	l ₂	w	h	d ₁	d ₂			
<i>Ebria tripartita</i>	(Schumann) Lemmermann 1900	H	half sphere- 30%	3	cell: 27-33					30		1	4 946	
<i>Ebria tripartita</i>	(Schumann) Lemmermann 1900	H	half sphere- 30%	4	cell: 33-37					35		1	7 853	
<i>Ebria tripartita</i>	(Schumann) Lemmermann 1900	H	half sphere- 30%	5	cell: 37-43					40		1	11 723	
Class Kinetoplastidea														
Order KINETOPLASTIDA														
<i>Cryptaulax marina</i>	Thronsen 1969	H	rotational ellipsoid		cell: 5-7x8-10				9	6		1	170	
<i>Cryptaulax spp.</i>		H	rotational ellipsoid	1	cell: 3-5x7-9				8	4		1	67	
<i>Cryptaulax spp.</i>		H	rotational ellipsoid	2	cell: 5-7x8-10				9	6		1	170	
<i>Cryptaulax spp.</i>		H	rotational ellipsoid	3	cell: 7-9x14-16				15	8		1	502	
<i>Cryptaulax spp.</i>		H	rotational ellipsoid	4	cell: 9-11x16-20				18	10		1	942	
Incertae sedis														
<i>Katablepharis ovalis</i>	Skuja 1948	H	rotational ellipsoid	1	cell: 5-6x7-9				8	5.5		1	127	
<i>Katablepharis ovalis</i>	Skuja 1948	H	rotational ellipsoid	2	cell: 6-8x8-12				10	7		1	256	
<i>Katablepharis remigera</i>	(Vørs) Clay & Kugrens 1999	H	rotational ellipsoid	1	cell: 5-6x7-9				8	5.5		1	127	
<i>Katablepharis remigera</i>	(Vørs) Clay & Kugrens 1999	H	rotational ellipsoid	2	cell: 6-8x8-12				10	7		1	256	

		Trophy	Geometric shape	Size class No	Cell size range, μm	Length, μm		Width μm	Height μm	Diameter, μm		Number of cells/ counting unit	Calculated volume, μm^3	Comment
						l ₁	l ₂	w	h	d ₁	d ₂			
<i>Katablepharis remigera</i>	(Vørs) Clay & Kugrens 1999	H	rotational ellipsoid	3	cell: 8-10x12-15				13.5	9		1	572	
<i>Katablepharis spp.</i>		H	rotational ellipsoid	1	cell: 5-6x7-9				8	5.5		1	127	
<i>Katablepharis spp.</i>		H	rotational ellipsoid	2	cell: 6-8x8-12				10	7		1	256	
<i>Leucocryptos marina</i>	(Braarud) Butcher 1967	H	cone + half sphere	1	cell: 4-5x7-10				8.5	4.5		1	57	
<i>Leucocryptos marina</i>	(Braarud) Butcher 1967	H	cone + half sphere	2	cell: 5-6x10-14				12	5.5		1	117	
<i>Leucocryptos spp.</i>		H	cone + half sphere		cell: 4x7				7	4		1	38	
<i>Telonema subtile</i>	Griessmann 1913	H	cone + half sphere	1	cell: 4x7				7	4		1	38	
<i>Telonema subtile</i>	Griessmann 1913	H	cone + half sphere	2	cell: 5-6x8				8	5.5		1	85	
<i>Telonema spp.</i>		H	cone + half sphere		cell: 6-7x12				12	6.5		1	169	
Division Ciliophora														
Class Litostomatea														
Order HAPTORIDA														
<i>Mesodinium rubrum</i>	(Lohmann) Hamburger & Buddenbrock 1911	A	2 spheres * 5/8	1	cell: 10-14					12.5		1	1 278	*
<i>Mesodinium rubrum</i>	(Lohmann) Hamburger & Buddenbrock 1911	A	2 spheres * 5/8	2	cell: 14-16					15		1	2 208	*
<i>Mesodinium rubrum</i>	(Lohmann) Hamburger & Buddenbrock 1911	A	2 spheres * 5/8	3	cell: 16-20					17.5		1	3 506	*

		Trophy	Geometric shape	Size class No	Cell size range, μm	Length, μm		Width μm	Height μm	Diameter, μm		Number of cells/ counting unit	Calculated volume, μm^3	Comment
						l ₁	l ₂	w	h	d ₁	d ₂			
<i>Mesodinium rubrum</i>	(Lohmann) Hamburger & Buddenbrock 1911	A	2 spheres * 5/8	4	cell: 20-27					22.5		1	7 451	*
<i>Mesodinium rubrum</i>	(Lohmann) Hamburger & Buddenbrock 1911	A	sphere	5	cell: 27-33					30		1	14 130	*
<i>Mesodinium rubrum</i>	(Lohmann) Hamburger & Buddenbrock 1911	A	sphere	6	cell: 33-37					35		1	22 438	*
<i>Mesodinium rubrum</i>	(Lohmann) Hamburger & Buddenbrock 1911	A	sphere	7	cell: 37-45					40		1	33 493	*
<i>Mesodinium rubrum</i>	(Lohmann) Hamburger & Buddenbrock 1911	A	sphere	8	cell: 45-55					50		1	65 417	*
<i>Mesodinium rubrum</i>	(Lohmann) Hamburger & Buddenbrock 1911	A	sphere	9	cell: 55-65					60		1	113 040	*
Others														
Flagellates, unidentified		A/H	rotational ellipsoid	1	cell: <2				2	1.5		1	2.4	10
Flagellates, unidentified		A/H	rotational ellipsoid	2	cell: 2-3				2.5	1.9		1	4.6	10
Flagellates, unidentified		A/H	rotational ellipsoid	3	cell: 3-5				4	3		1	19	10
Flagellates, unidentified		A/H	rotational ellipsoid	4	cell: 5-7				6	4.5		1	64	10
Flagellates, unidentified		A/H	rotational ellipsoid	5	cell: 7-10				8.5	6.4		1	181	10
Flagellates, unidentified		A/H	rotational ellipsoid	6	cell: 10-15				12.5	9.4		1	575	10
Flagellates, unidentified		A/H	rotational ellipsoid	7	cell: 15-20				17.5	13.1		1	1 578	10
Flagellates, unidentified		A/H	sphere	1	cell: <2					2		1	4.2	10
Flagellates, unidentified		A/H	sphere	2	cell: 2-3					2.5		1	8.2	10
Flagellates, unidentified		A/H	sphere	3	cell: 3-5					4		1	33	10
Flagellates, unidentified		A/H	sphere	4	cell: 5-7					6		1	113	10
Flagellates, unidentified		A/H	sphere	5	cell: 7-10					8.5		1	321	10

	Trophy	Geometric shape	Size class No	Cell size range, μm	Length, μm		Width μm	Height μm	Diameter, μm		Number of cells/ counting unit	Calculated volume, μm^3	Comment
					l ₁	l ₂	w	h	d ₁	d ₂			
Flagellates, unidentified	A/H	sphere	6	cell: 10-15					12.5		1	1 022	10
Flagellates, unidentified	A/H	sphere	7	cell: 15-20					17.5		1	2 805	10
Unicell spp.	A	sphere	1	cell: <2					2		1	4.2	11
Unicell spp.	A	sphere	2	cell: 2-3					2.5		1	8.2	11
Unicell spp.	A	sphere	3	cell: 3-5					4		1	33	11
Unicell spp.	A	sphere	4	cell: 5-7					6		1	113	11
Unicell spp.	A	sphere	5	cell: 7-10					8.5		1	321	11
Unicell spp.	A	sphere	6	cell: 10-15					12.5		1	1 022	11
Unicell spp.	A	sphere	7	cell: 15-20					17.5		1	2 805	11

Abbreviations:

A - Autotrophic

H - Heterotrophic

A/H - Autotrophic or Heterotrophic

M - Mixotrophic

coen. - coenobium

fil. - filament

HD factor - relation between hidden and visible dimensions

Comments:

* - species not included in the recent Checklist of Baltic Sea Phytoplankton Species (Hällfors 2004).

1 - species counted as 100 μm filament, comprised spherical cells

2 - most common species, earlier called *Aphanizomenon flos-aque* (see page 14 in the text)

3 - HD factor=0.25 need confirmation

4 - length of cell is measured as total length minus two processes of 5 μm length each

5 - fixed volumes

6 - size class based on cell diameter

7 - size classes based on cell length

8 - size classes based on cell apical axis

9 - volume calculated as rotational ellipsoid without narrow empty ends of cell

10 - unidentified cells with flagella, which may belong to different taxonomical groups

11 - unidentified cells without flagella, which may belong to different taxonomical groups



HELSINKI COMMISSION
Baltic Marine Environment Protection Commission

Katajanokanlaituri 6 B
FI-00160 Helsinki
Finland

ISSN 0357-2994