



A Research Article

**NEUROLOGICAL DISORDER AMONG PREMUTATION
CARRIERS OF FRAGILE X SYNDROME AT SEMIN, GUNUNG
KIDUL REGENCY**

**Submitted to Fulfil the Assignment and
Fit-Out Requisite in Passing Undergraduate Education Program
Faculty of Medicine**

**RIVALDI ARDIANSYAH
G2A006161**

**MEDICAL FACULTY
DIPONEGORO UNIVERSITY
SEMARANG**

2010

NEUROLOGICAL DISORDER AMONG PREMUTATION CARRIERS OF FRAGILE X SYNDROME AT SEMIN, GUNUNG KIDUL REGENCY

Rivaldi Ardiansyah¹, Tri Indah Winarni²
ABSTRACT

Background: Neurological disorder among male premutation carriers of Fragile X Syndrome (FXS) frequently occurs. In other hand, lacking of information results misdiagnosis of this disorder. Therefore this study is addressed to provide the data about neurological involvement of late-adult premutation carriers of FXS.

Objectives: This research is to know neurological involvement of late-adult premutation carriers of FXS.

Subjects and Methods: This was a descriptive study following cytogenetic, Polymerase Chain Reaction (PCR), and neurological examinations on premutation carriers of FXS. Cytogenetic and PCR results were secondary data from Central for biomedical research (CEBIOR) laboratory of Faculty of Medicine Diponegoro University during September 2009 – March 2010. Simple neurological examination techniques were done to observe neurological involment among male premutation carriers.

Results: There were four males carrying premutation allele over the age of 50. Cytogenetic analysis revealed two subjects expressed fragile site. The other two subjects expressed no fragile site. PCR analysis revealed expanded allele from all subjects. Subject III.6 showed intention tremor and gait ataxia, which are two mayor clinical criterions of FXTAS. Subject III.8 showed gait ataxia which is a mayor criterion of FXTAS. Subject III.9 showed intention tremor and gait ataxia, which are two mayor criterions of FXTAS. And Subject III.10 showed gait ataxia which is a mayor criterion of FXTAS.

Conclusion: Some cerebellar manifestations such as intention tremor, limb ataxia, gait ataxia, dysdiadochokinesia, and titubation have been identified in premutation carriers of FXS. Southern Blot is needed to reveal subjects's molecular status more accurate. Simple techniques to observe mayor and minor clinical criteria in this study had been proved can be used in the future. Radiological imaging is needed to address major and minor radiological criteria of FXTAS is still needed as one of an objectives measurement.

Keywords : Fragile X-associated Tremor Ataxia Syndrome, intention tremor, gait ataxia, cerebellar manifestations

INTRODUCTION

Mental retardation is a common problem in many countries. It is also big problem in our country. The effort to diagnose mental retardation precisely is difficult since mental retardation has many variations in clinical and etiological. The genetic causes account for 25-50% of such cases¹. Fragile X syndrome is one of the most prevalent causes of genetic mental retardation, with a frequency of 1 in 4,000 males and 1 in 6,000 females². The prevalence of Fragile X Syndrome is 2% in Central Java¹. The prevalence of premutation carriers alleles of fragile X syndrome in general population is relatively high. In Canadian population studies of over 10,000 individuals, the prevalence of premutation alleles of Fragile X Syndrome approximately 1 in 259 females and 1 in 813 males³. Prevalence estimates for premutation carriers females were found to be higher in Israel, with 1 in 152 females. A study of premutation carriers newborn males in Italy is 1 in 250 males³.

The fragile X syndrome (FXS) is a neurodevelopmental disorder caused by mutation of the FMR1 gene on the X chromosome. Normally, the FMR1 gene contains between 5-50 repeats of the CGG trinucleotide repeats. In fragile X syndrome patients, the FMR1 allele has over >200 up to 1,000 repeats. This expansion of the CGG repeats results in a methylation of FMR1 gene, results no protein encoded by the FMR1 gene^{1,2,3}. This methylation of the FMR1 locus in chromosome band Xq27.3 results the constriction of the X chromosome in cytogenetic test. Mutation of the FMR1 gene results the transcriptional silencing of the fragile X-mental retardation protein, FMRP. In normal individuals, FMRP regulates a population of mRNA². FMRP plays important roles in learning and memory, and also important in the development of axons, synapses and

neural circuits. The CGG trinucleotide repeat expansion takes place as a multistep process over many generations.

There are four classes of alleles of CGG trinucleotide repeats according to its length. The first class has length between 5-50 CGG repeats called wild type. Second class has length between 40-55 CGG trinucleotide repeats called premutation (gray zone). Third class has length between 50-200 CGG trinucleotide repeats called premutation. The fourth class has length between >200 up to 1,000 CGG trinucleotide repeats called full mutation².

Fragile X syndrome is a neurodevelopmental disorder that is not known to have any neurological problem in late adult. Lack of information about it make clinician does not realize that neurological condition such as intention tremor, gait ataxia, parkinsonism, and dementia have been identified among older males (45.5%) and females (15.5%) of premutation carriers of fragile X syndrome and it is not a part of aging disorder⁶. Recently, it is thought that this tremor/ataxia syndrome associated with fragile X. This clinical features has different mechanism with fragile X syndrome even involving the same gene (FMR1).

The clinical features of FXTAS are quite different from FXS. FXTAS involves males over 50 years of age. And they have fragile X-affected grandson. Those males do not have fragile-X syndrome such as cognitive decline, over 60% having a college education. Actually, there are two form clinical features among premutation carriers of Fragile X Syndrome. The first of these disorders is premature ovarian failure (POF), affect 16% to 24% of female carriers^{3,7,8}. The second form is Fragile X-associated Tremor/Ataxia Syndrome (FXTAS). A progressive intention tremor and gait ataxia with

radiological abnormality which had been identified among male carriers, mostly. FXTAS are detected in 16.5% of female premutation carriers and in 45.5% of male premutation carriers older than 50 years⁶.

Neurological disorder among male premutation carriers of Fragile X Syndrome (FXS) frequently occurs. In other hand, lack of information of this disorder results misdiagnosis of this disorder. Therefore this study is addressed to provide the data about neurological involvement of late-adult premutation carriers of FXS.

The aim of this research is provide about neurological features among male premutation carriers at Semin, GunungKidul Regency. The advantages of this research not only provide data for next research but also provide information for subjects of this research and family also. The research about this topic in Indonesia is still insufficient in quantity. So that, hopefully this research leads to another new research in other to provide more accurate data.

SUBJECT AND METHODS

Subjects

Subjects of this research are all male premutation carriers of Fragile X Syndrome over 50 years of ages from a big family who live in Semin, GunungKidul Regency. The reachable populations are all male premutation carriers of Fragile X Syndrome over 50 years of ages from a big family who live in Semin, GunungKidul Regency who are examined using cytogenetic test, Polymerase Chain Reaction test, and serial neurological examination for tremor and ataxia assessment. This research was using secondary data from Central for Biomedical Research (CEBIOR).

Methods

This research was descriptive-observational study. This research has been conducted in two places: Central for Biomedical Research (CEBIOR) and research field in Semin, GunungKidul Regency.

Subjects were found using pedigree analysis from affected patients. Then subjects were sampled. Heparinized and EDTA periferal blood was drawn for cytogenetic test and Polymerase Chain Reaction (PCR) test. Cytogenetic test was done using giemsa staining. Meanwhile DNA was extracted from leucocytes of EDTA blood using salting out method. Then DNA was examined using PCR test.

After subjects molecular status was revealed by cytogenetic and PCR test, subjects were performed neurological examination. These are tremor and ataxia assessment.

Tremor assessment:

1. Finger to Nose test. Subjects were asked to abduct their hand 90° then touch plastic marker in front of their nose. Tremor on movement and getting worse in the end of movement was assessed as intension tremor (figure 5).
2. Resting tremor test. Subjects were asked to lay their hands on thigh then tremor at rest was assessed.
3. Pick up coin test. Subjects were asked to pick up coin then tremor on the movement was assessed.
4. Pour water test. Subjects were asked to pour water into the glass then tremor on the movement and an amount of spilled water was assessed.

Scoring system for tremor assessment using The Fahn TRS (Figure 6).



Figure 5. Finger to Nose Test. Adopted from Notermans NC et al., 1994

FINGER-TO-NOSE TEST PROTOCOLS FOR TREMOR, Feys

Appendix 1: The Fahn TRS

General description	
0	No tremor
1	Slight, may be intermittent
2	Moderate amplitude, may be intermittent
3	Marked amplitude
4	Severe amplitude
Specific description for pouring-water task	
0	Pours normally
1	Pours more carefully than a person without tremor, but no water is spilled
2	Spills a small amount of water (up to 10% of total amount)
3	Spills a considerable amount of water (10%–50%)
4	Unable to pour water without spilling most of it

Figure 6. The Fahn TRS. Adopted from Feys PG et al., 2003

Ataxia assessment:

1. Finger to Nose Test. The same test with tremor test, the difference is ataxia was assessed from the distance between the tip of the nose and the final position of finger on plastic marker (Figure 5).
2. Upper and lower limb tapping test. On upper limb tapping test, subjects were asked to tap the 35 cm-apart-buttons for 15 seconds (Figure 7). On lower limb tapping test, subjects were asked to tap the 35 cm-apart-pedals for 15 seconds. The result was scored using figure 8.



Figure 7. Upper limb tapping test. Adopted from Notermans NC et al., 1994

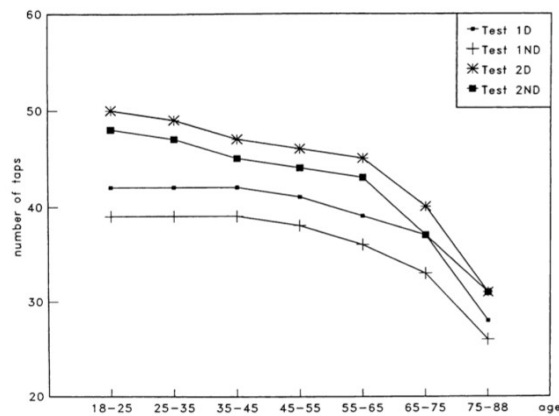

Figure 2 Relation between the 50-percentile value of the tapping tests' scores and age.

Figure 8. Scoring system of upper and lower tapping test. Adopted from Notermans NC et al., 1994

3. Romberg test. Subjects were asked to stand on heel-to-toe position in opened eyes and closed eyes. Then swaying of the body was assessed (Figure 9).
4. Tandem walk test. Subjects were asked to walk on tandem position. Then falling to one or both side was assessed (Figure 10).
5. Postural reflex test. Subjects on standing position were pulled then repropulsion was assessed.

Romberg's test

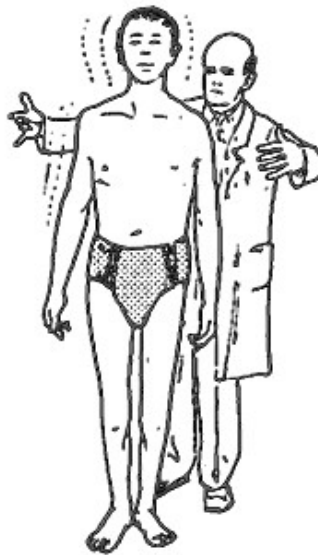

Figure 9. Romberg test. Adopted from Lindsay KW et al., 1997



Figure 10. Tandem walk test. Adopted from Lindsay KW et al., 1997

RESULTS

Four subjects of this research have range of age from 68 – 74 years old. These subjects are found from learning the pedigree construction from the patients of fragile X syndrome from Semin Yogyakarta. One big family with five generations has been identified. From physical and laboratory examination persons with pedigree number V:38, V:39, V:40 had been diagnosed as patients with fragile X syndrome. Since fragile X syndrome is X-linked disorder, the mother of persons with pedigree number V:38;

V:39; V:40, which is IV:35 was suspected as premutation (carrier). Since no selection process in maternal meiosis, thus subject IV:35 transmits fullmutation X chromosome to her offspring. Person with pedigree number IV:35 is a daughter of subject III:6 (male) so that subject III:6 was suspected as premutation too (figure 11). Subject III:6 was 74 years old when this research began, so that he was included in this research because he fulfilled the inclusion criteria of this research, which is premutation male over 50 years old.

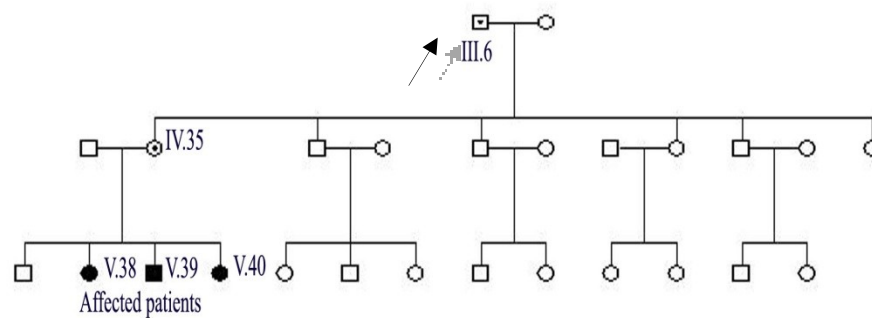

Figure 11. Pedigree of Subject III.

Another person who was diagnosed as patient with fragile x syndrome is person with pedigree number V:53 (female). She is a daughter of person with pedigree number IV:43 (female) so that person with pedigree number IV:43 was suspected as premutation or fullmutation with a lesser degree of symptoms since fragile X syndrome is X-linked disorders with reduce penetrance due to X-inactivation process in females. Person with pedigree number IV:43 is a daughter of Subject III:8 (male) thus subject III:8 might be premutation (Figure 12). In order to confirm the assumption, PCR test should be performed. Subject III:8 was 72 years old when this research began, so that he was included in this research because he fulfilled the inclusion criteria of this research, which is premutation male over 50 years old.

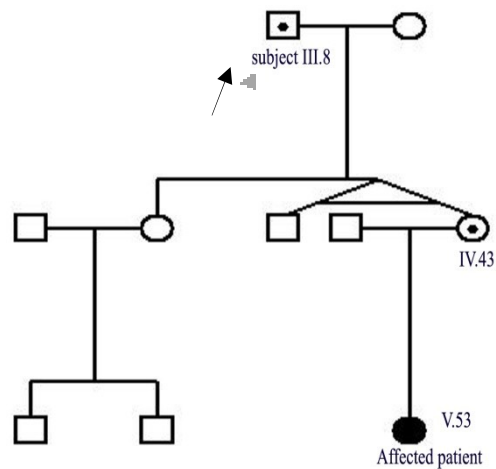

Figure 12. Pedigree of Subject III.8

Subject III:6 and Subject III:8 were suspected as premutation, they are sons of subject with pedigree number II:2. Subject II:2 has ten children . So that, Subject II.6 and III.8 have eight siblings. Three of them had passed away, no available data about three other persons because they refused to be subject in this research. As a result there are four available subjects fulfilled inclusion criteria. They are subjects with pedigree number III:6, III:8, III:9, III:10. All subjects are male (Figure in appendix IV). They was performed cytogenetic test, PCR test, and some serial neurological test.

In order to obtain premutation involvement related to their molecular status, cytogenetic test and Polymerase Chain Reaction (PCR) test was performed. Neurological examinations using simple techniques to address major clinical criteria of FXTAS which are intention tremor and gait ataxia were performed. Cytogenetic analysis revealed subject III.6 expressed no fragile site when cultured in MEM and TC 199 medium. Subject III.8 expressed fragile site at the end of long arm chromosome X when cells cultured in medium TC199 and MEM with average frequency 3%. Meanwhile Subject III.9 expressed fragile site at the end of long arm chromosome X when cells cultured in

medium TC199 and MEM with average frequency 9% (figure 13). Subject III.10 expressed no fragile site when cells cultured in MEM and TC 199 medium (table 5). On Polymerase Chain Reaction (PCR) examination, all four subjects showed expanded allele (figure 14 and table 5).

Table 5. Cytogenetic and PCR data of four subjects

Subject	Cytogenetic analysis	PCR
III.6	M (-) T (-)	Expanded allele
III.8	M (+) T (+) 3%	Expanded allele
III.9	M (+) T (+) 9%	Expanded allele
III.10	M (-) T (-)	Expanded allele

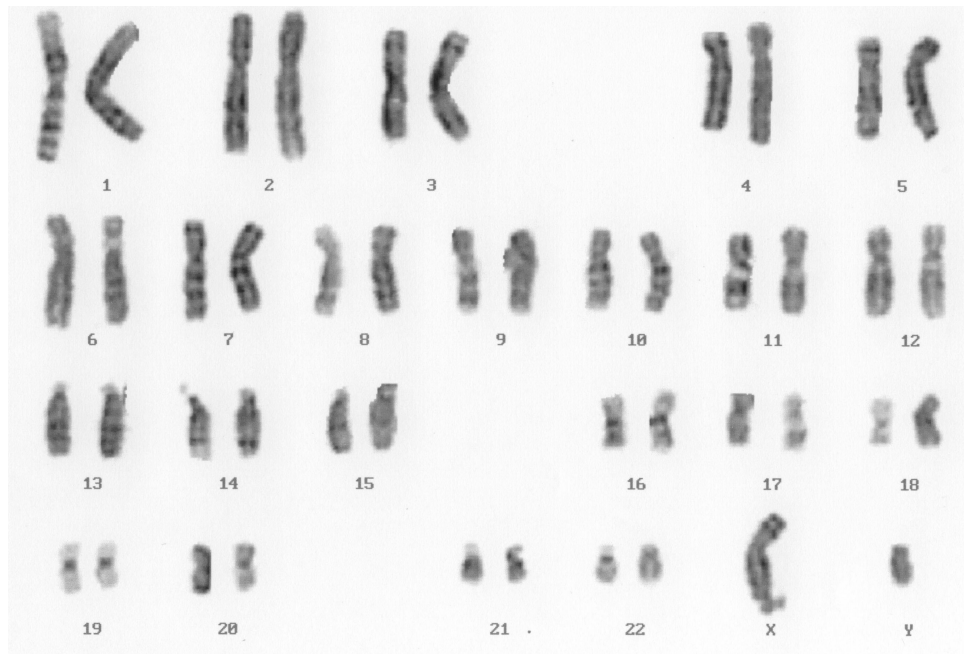

Figure 13. Positive fragile site in cytogenetic result. There is a constriction or non-staining gap at the terminal of X chromosom.

GEL 1

GEL 2

GEL 3

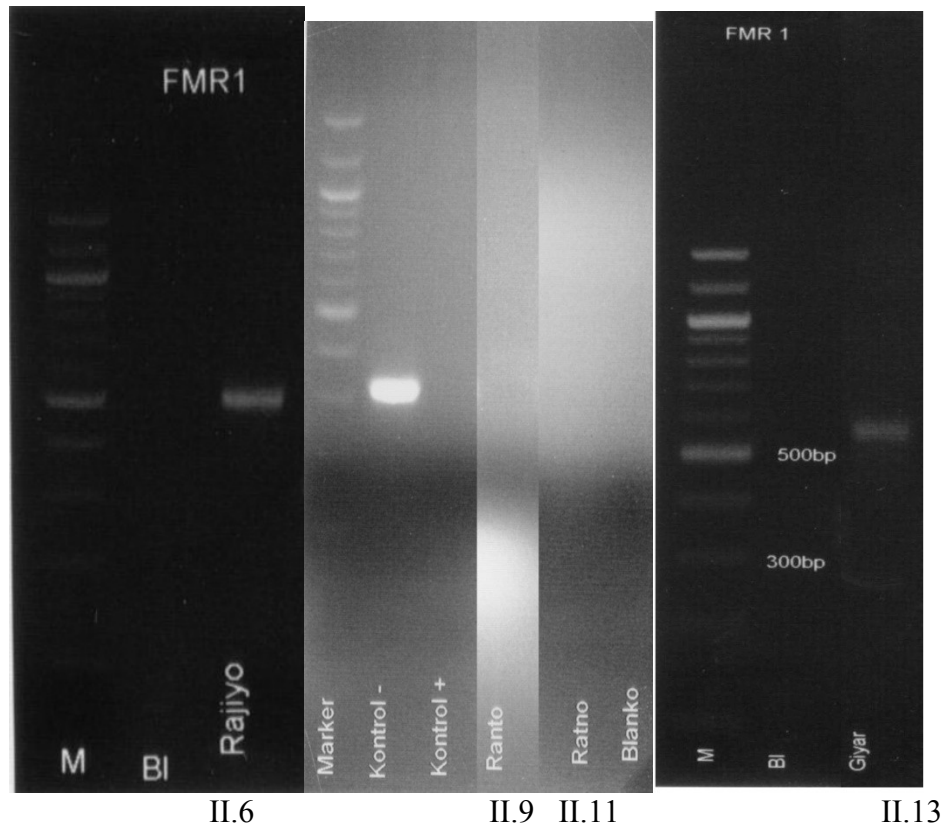

Figure 14. **PCR results of Subject II.6, II.9, II.11, and II.13.** PCR analysis of 4 premutation cases is shown in 3 gels i.e. gel 1 from II.6 (~500bp), gel 2 from II.9 (no product) and II.11 (no product) and gel 3 from II.13 (~500bp)

After all subject's molecular status were confirmed by PCR, all subjects performed any serial neurologic examinations for tremor and ataxia. These are quantitative tremor results for subject III.6. Subject III.6 performed finger to nose test, by abduct his shoulder to 90° and full extension at the elbow then hold the finger on the nose for 5 seconds. Then Subject III.6 put down his hands on his thigh in order to observe resting tremor. On those tests, subject III.6 showed no resting tremor and no intention tremor. On pick up coin test subject III.6 showed slight tremor and occurs in irregular interval. On pouring water test subject III.6 spilled small amount of water but less than 10% total amount water in glass. The scoring system for quantitative tremor test was

adopted from specific description in the Fahn TRS (Table 6). This scoring system was used for all subjects in this research.

Table 6. Specific description in the Fahn TRS

General description	
0	No tremor
1	Slight, may be intermittent
2	Moderate amplitude, may be intermittent
3	Marked amplitude
4	Severe amplitude
Specific description for pouring-water task	
0	Pours normally
1	Pours more carefully than a person without tremor, but no water is spilled
2	Spills a small amount of water (up to 10% of total amount)
3	Spills a considerable amount of water (10%-50%)
4	Unable to pour water without spilling most of it

These are quantitative ataxia results for subject III.6. Subjects performed tapping test by pushed device buttons that placed 35 cm apart for upper limbs then he pushed device pedals that placed 35 cm apart. Tapping test can observe dysdiadochokinesia (difficulty with rapid alternating movement) also. On tapping test subject III.6's result shows less than 50th percentile for upper and lower limb on dominant and non-dominant side according to 50th percentile value of tapping test for ataxia measurement that was adopted from Notermans N.C et all (measuring ataxia: quantification based on the standard neurological examination. Journal of neurology, Neurosurgery, and Psychiatry 1994; 57:22-26) (Figure 8). Subject III.6 showed no dysdiadochokinesia. Subject III.6 performed finger to nose test on plastic marker in order to observe limb ataxia. Subject III.6 showed no deviation on finger to nose test. Subject III.6 performed Romberg test in position heel to toe and tandem walk in order to observe swaying of the body and ability

to perform tandem walk. Subject III.6 failed on performed Romberg test in position heel to toe, could not walk in tandem position. Subject III.6 pulled on standing position. Subject III.6 showed repropulsion on postural reflex test (table 7).

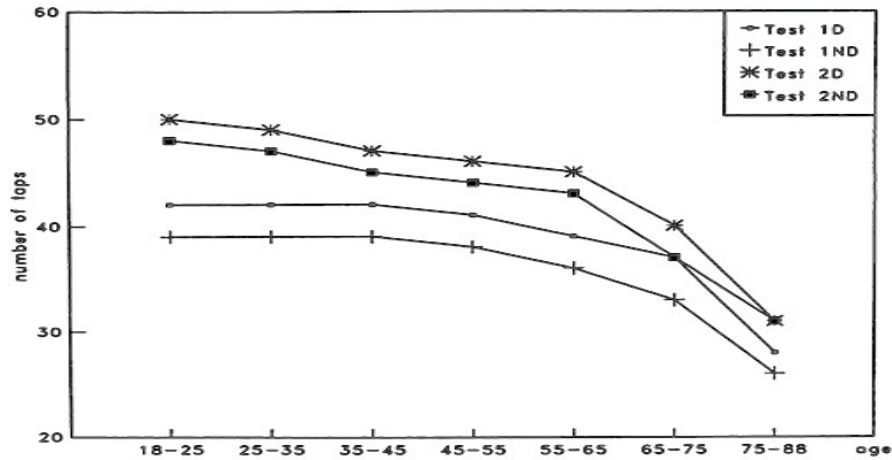

Figure 15. 50th percentile value of tapping test (adopted from Notermans N.C et all 1994)

Table 7. Neurological data of Subject III.6

Pedigree number and Age	Quantitative Ataxia	Quantitative Tremor	Pulling test/postural reflex:	Dysdiadochokinesia	Other finding	medical
III.6 (74 YO)	Upper limb tapping test: < 50 th percentile	Resting tremor: none	Repropulsion	none	Hypertension (190/130 mmHg)	
	Lower limb tapping test: < 50 th percentile	Finger to nose: none			Hearing Impairment	
	Finger to nose (open and closed eyes): 0 cm	Pick up coin: 1 (slight)			Using cane since 2 years ago	
	Romberg test (heel to toe): fail	Pouring water: 2 (Spills < 10%)				
	Tandem Walk: can not					

These are quantitative tremor results for subject III.8. Subject III.8 showed no resting tremor and intention tremor on finger to nose test, showed no tremor while subject

III.8 picked up the coin, and poured water normally without spills water. These are quantitative ataxia results for subject III.8. On tapping test subject III.8's result showed less than 50th percentile for upper and lower limb on dominant and non-dominant side according to 50th percentile value of tapping test for ataxia measurement (the same scoring system to measure other subjects). Subject III.8 showed no dysdiadochokinesia on tapping test. Subject III.8 showed no deviation on finger to nose test, tend to fail on Romberg test with position heel to toe. Subject III.8 could perform tandem walk normally. On postural reflex test, subject showed repropulsion but can recover without aid (table 8).

Table 8. Neurological data of Subject III.8

Pedigree number and Age	Quantitative Ataxia	Quantitative Tremor	Pulling test/postural reflex:	Dysdiadochokinesia	Other medical finding
III.8 (72 YO)	Upper limb tapping test: < 50 th percentile	Resting tremor: none	Repropulsion but recover unaided	None	Blood pressure : 120/80 mmHg
	Lower limb tapping test: < 50 th percentile	Finger to nose: none			Hearing Impairment
	Finger to nose (open and closed eyes): 0 cm	Pick up coin: 0			
	Romberg test (heel to toe): tend to fail Tandem Walk: normal	Pouring water: 0			

These are quantitative tremor results for subject III.9. Subject III.9 showed no resting tremor and intention tremor on finger to nose test. Subject III.9 showed no tremor while subject III.9 picked up the coin, and poured water more carefully than a person without tremor, but no water was spilled. These are quantitative ataxia results for subject III.9. On tapping test, subject III.9's result shows less than 50th percentile for upper and

lower limb on dominant and non-dominant side according to 50th percentile value of tapping test for ataxia measurement (the same scoring system to measure other subjects). Subject III.9 showed positive dysdiadochokinesia on tapping test. On finger to nose test, subject III.9 showed no deviation. On Romberg test with position heel to toe, subject III.9, subject tended to fail. Subject III.9 could perform tandem walk step by step but not performed it smoothly. On postural reflex, subject III.9 showed normal response (table 9).

Table 9. Neurological data of Subject III.9

Pedigree number and Age	Quantitative Ataxia	Quantitative Tremor	Pulling test/postural reflex:	Dysdiadochokinesia	Other medical finding
III.9 (70 YO)	Upper limb tapping test: < 50 th percentile	Resting tremor: none	Normal	Positive	Hypertension (150/100 mmHg)
	Lower limb tapping test: < 50 th percentile	Finger to nose: none			Hearing Impairment
	Finger to nose (open and closed eyes): 0 cm	Pick up coin: 0			
	Romberg test (heel to toe): tend to fail	Pouring water: 1 (pours more carefully)			
	Tandem Walk: step				

These are quantitative tremor results of subject III.10, the fourth subject of this research. Subject III.10 showed no resting tremor and intention tremor on finger to nose test, showed no tremor while subject picked up coin and poured water normally. Then these are quantitative ataxia results of subject III.10. On tapping test, subject III.10's result showed less than 50th percentile for upper and lower limb on dominant and non-dominant side according to 50th percentile value of tapping test for ataxia measurement

(the same scoring system to measure other subjects). On finger to nose test, subject III.10 showed no deviation. On Romberg test with position heel to toe, subject tended to fail. Subject could perform tandem walk normally. Subject III.10's postural reflex was normal and did not showed dysdiadochokinesia on tapping test (table 10)

Table 10. Neurological data of Subject III.10

Pedigree number and Age	Quantitative Ataxia	Quantitative Tremor	Pulling test/postural reflex:	Dysdiadochokinesia	Other medical finding
III.10 (68 YO)	Upper limb tapping test: < 50 th percentile	Resting tremor: none	Normal	none	Hypertension (190/130 mmHg)
	Lower limb tapping test: < 50 th percentile	Finger to nose: none			Hearing Impairment
	Finger to nose (open and closed eyes): 0 cm	Pick up coin: 0			Using cane since 2 years ago
	Romberg test (heel to toe): tend to fail	Pouring water: 0			
	Tandem Walk: normal				

Sampling in order to get data was performed twice to follow up the subjects. Time period between first and second observation was one month. Figure below shows number of tapping test of subjects on first and second sampling (figure 16).

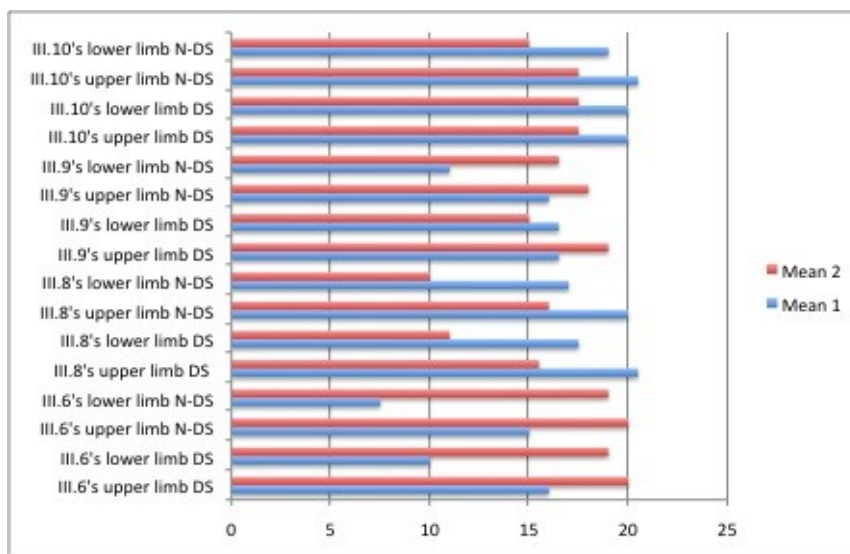

Figure 16. Mean of tapping test on first and second sampling.

DISCUSSION

Molecular status of all subjects has to be done by PCR test to address premutation carrier. Subsequently neurological examination was performed to all subjects. Subjects were performed some test including tremor and ataxia test. Subjects performed Resting tremor test, finger to nose test, pick up coin test, and pour water test. These tests were performed to evaluate any resting and intention tremor. Resting tremor is type of tremor when muscles are at rest. Tremor occurs when subject completely relaxed. Meanwhile, Intention tremor is type of on movement tremor that is getting worse in the end of movement. Intentional tremor itself is one of clinical manifestations of cerebellar disease meanwhile resting tremor is one of clinical manifestations of parkinsonism (figure 17). Therefore resting tremor completely negative in all subject since the basic

mechanism of FXTAS is cerebellar diseases. Subjects also were performed several kind of ataxia tests to test limb ataxia, gait ataxia, titubation and dysdiadochokinesia^{19,20}.

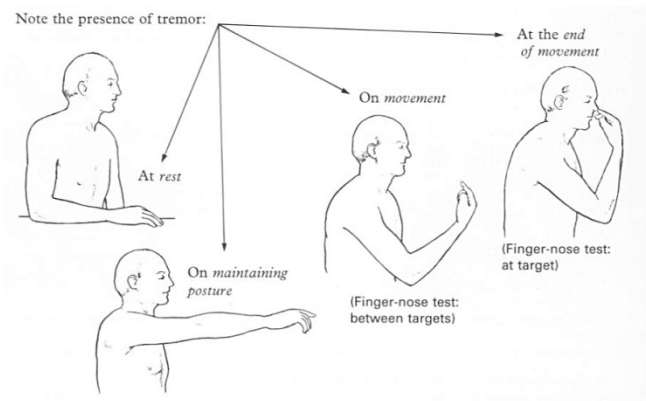

Figure 17. Resting and intentional tremor. Adopted from Lindsay KW et al., 1997

In order to prove any limb ataxia subjects was performed tapping test for upper limb and finger to nose test. To prove any gait ataxia subjects was performed tapping test for lower limb, Romberg test, and tandem walk. In cerebellar ataxia, Romberg test will be positive in closed eyes and opened eyes (figure 18) To prove any titubations subjects was performed postural reflex or pulling test. Then tapping test also was performed to prove any dysdiadochokinesia. Limb ataxia, gait ataxia, titubation and dysdidochokinesia are another manifestations of cerebellar disease¹⁹.

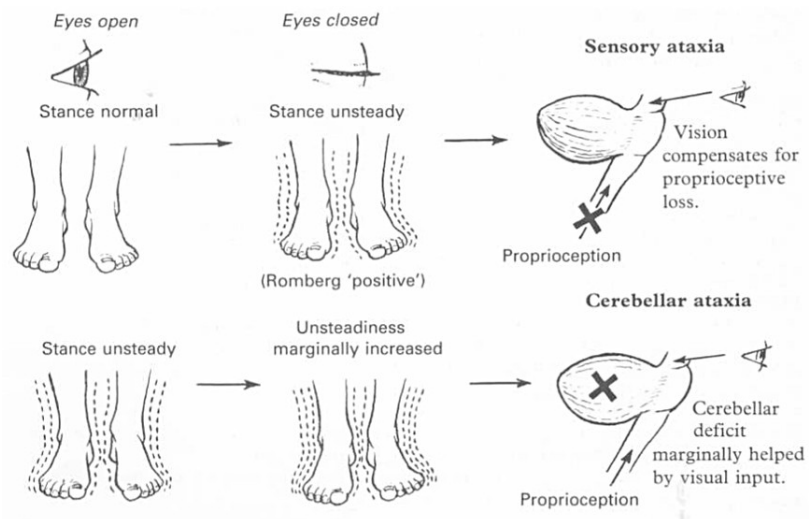

Figure 18. The difference between sensory and cerebellar ataxia on Romberg test. Cerebellar ataxia shows unsteadiness and clumsiness while opened and closed eyes. Adopted from Lindsay KW et al., 1997

Limb ataxia is disorder of smooth and accurate movement of the limb, velocity and force of the movement are not checked normally. Gait ataxia is type of gait that is wide base (separation of leg), unsteadiness, and irregular steps. Subjects with gait ataxia have no ability to perform tandem walk, subjects will fall to one or both side (figure 19).

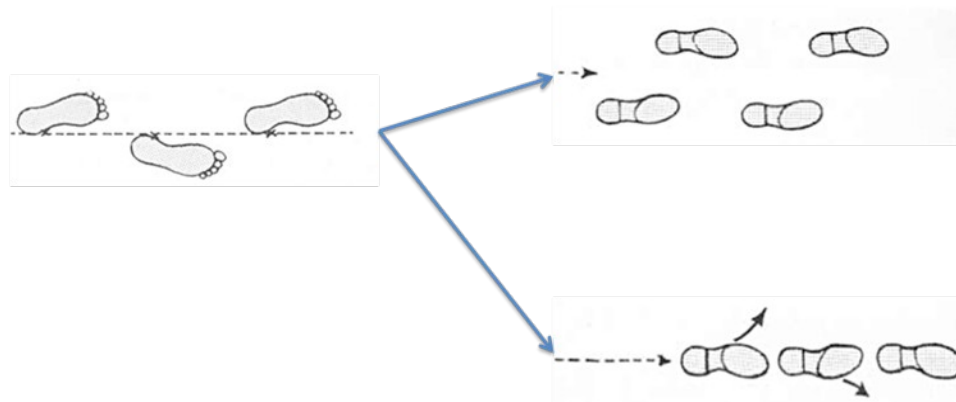

Figure 19. The difference between normal gait (left) and gait ataxia (right). Adopted from Lindsay KW et al., 1997

Titubation is clumsiness of the head and trunk. Subjects with this disorder show repropulsion on postural reflex test. Dysdiadochokinesia is disorder of ability in perform rapid alternating movement. The normal rhythm of the movement interrupted by irregularity of force and speed. Subjects with dysdiadochokinesia show irregular force and speed on tapping test²⁰.

In this research Subject III.6 showed positive tremor on pick up coin test and pouring water. Subject III.6 also showed positive gait ataxia on Romberg test and tandem walk test. Subject III.6 showed positive gait ataxia and intention tremor which are major clinical criteria of FXTAS. In order to confirm Subject III.6 as definite patient of FXTAS, MRI is needed. Subject III.8 showed no tremor but showed positive gait ataxia

on tapping test and Romberg test which is major clinical criterion of FXTAS. In order to confirm Subject III.8 as patient of FXTAS, other examinations are needed. Examinations included MRI, short-term memory, and executive function. Subject III.9 showed tremor on pouring water test and showed gait ataxia on tapping test and Romberg test. They are two major clinical criteria. In order to confirm Subject III.9 as definite, probable or possible patient of FXTAS, other examinations are needed. Subject III.10 showed gait ataxia on tapping and Romberg test which is major clinical criterion of FXTAS. To confirm FXTAS diagnosis many tests should be performed. This research has many limitations in order to confirm the diagnosis of FXTAS. Many examinations are needed to obtain other major and minor criteria such as MRI, Parkinsonism clinical manifestations, short-term memory, and executive functions.

ACKNOWLEDGMENT

Author would like to thank to dr. Tri Indah Winarni, Msi.Med, PAK for entire supervising this research, Prof. dr. Sultana MH Faradz, Ph.D as Director of Centre for Biomedical Research (CEBIOR) who give the opportunity to learn and practice cytogenetics and molecular laboratory technique with regards to *FMRI* gene and and as reviewer dr. A. ZulfaJuniarto, MSi.Med, Sp.And and also as reviewer dr. Farmaditya EP Mundhofir and all staff in CEBIOR of Faculty of Medicine Diponegoro University Semarang.

REFERENCES

1. Faradz SMH. Fragile X Mental retardation and Fragile X chromosome in The Indonesian population. [PhD] Sydney: University of New South Wales; 1988.
2. Oostra BA, Willemsen R. The X Chromosome and Fragile X Mental Retardation. *Cytogenet Genome Res.* 2002; 99: 257-264.
3. Hagerman PJ, Greco CM, Hagerman RJ. A Cerebellar Tremor/Ataxia Syndrome among Fragile X Premutation Carriers. *Cytogenet Genome Res.* 2003; 100: 206-212.
4. Hagerman PJ, Hagerman RJ. Fragile X-Associated Tremor/Ataxia Syndrome. *MRDD research reviews.* 2004; 10: 25-30.
5. AmiriKhaled, Hagerman PJ, Hagerman RJ. Fragile X-Associated Tremor/Ataxia Syndrome. *Arch Neurol.* 2008; 65: 1-7.
6. Revenga LR, Madrigal I, Pagonabarraga J, Xuncla M, Badenas C, Kulisevsky J, Gomez B, et al. Penetrance of FMR1 Premutation Associated Pathologies in Fragile X Syndrome Families. *EJHG.* 2009; 17: 1359-1362.
7. Hagerman PJ, Hagerman RJ, Leey MA. Fragile X-associated Tremor/Ataxia Syndrome: two faces of FMR1. *The Lancet Neurology.* 2008; 6(1): 45-55.
8. Lin YS, Yang ML. Familial Premature Ovarian Failure in Female Premutated Carriers of Fragile X Syndrome : A case Report and Literature Review. *Taiwanese J Obstet Gynecol.* 2006; 45(1): 60-62.
9. Hussein SM. Fragile X Mental Retardation and Fragile X Chromosomes in The Indonesian Population. [PhD thesis]. Sidney (NSW): University of New South Wales; 1998.
10. Ropers HH, Hamel BJ. X-Linked Mental Retardation Nature Publishing Group. *NPG.* 2005; 6: 46-49.
11. Raymond FL. X-linked Mental Retardation: A Clinical Guide. *JMG Online.* 2005; 10: 10-11.
12. Hagerman RJ. Lesson from Fragile X Regarding Neurobiology, Autism, and Neurogeneration. *JDBP.* 2006; 27: 63-70.
13. Willemsen R, Oostra BA, Bassel GJ, Dichtenberg J. The Fragile X Syndrome: From Molecular Genetics to Neurobiology. *MRDD research reviews.* 2004; 10:60-67.
14. Mazzocco MMM. Advances in Research on The Fragile X Syndrome. *MRDD research reviews.* 2000; 6: 96-106.
15. Singh K, Prasand S. Differential expression of FMR1 mRNA and FMRP in female mice brain during aging. *Mol bio Rep.* 2008; 35: 677-684.
16. Mothersead PK, Conrad K, Hagerman RJ, Greco CM, Hessel D, Tassone F. An Atypical Progressive Dementia in a Male Carrier of the Fragile X Premutation : An Example of Fragile X-Associated Tremor/Ataxia Syndrome. *Appl Neuropsychol.* 2005; 12(3): 169-178.

17. Hessler D, Tassone F, Cordeiro L, Koldewyn K, McCormick C, Green C, et al. Brief Report: Aggression and Stereotypic Behavior in Males with Fragile X Syndrome-Moderating Secondary Genes in a "Single Gene" Disorder. *J Autism Dev Disord.* 2008; 38: 184-189.
18. Loesch DZ, Huggins RM, Hagerman RJ. Phenotypic Variation and FMRP Levels in Fragile X. *MRDD research reviews.* 2004; 10: 31-41.
19. Ropper AH, Brown RH. Adams and Victor's Tremor, Myoclonus, Focal Dystonia, and Tics [monograph online]. USA: McGraw-Hill; 2005 [cited 2010 January 20]
20. Aminoff MJ, Greenberg D, Simon R. *Clinical Neurology* 6th edition. New York: The McGraw-Hill companies, inc; 2005
21. Davies KE, editor. *The fragile X Syndrome.* Oxford: OUP; 1989
22. Hagerman RJ, Hagerman PJ. *Fragile X Syndrome : Diagnosis, Treatment, and Research.* Third Edition. Baltimore and London: JHU; 2002