

History of *Picea abies* in West Central Sweden

Applications of Pollen Analysis to Reveal Past Local Presence of Trees

Henrik von Stedingk

*Faculty of Forest Sciences
Department of Forest Vegetation Ecology
Umeå*

**Doctoral thesis
Swedish University of Agricultural Sciences
Umeå 2006**

Acta Universitatis Agriculturae Sueciae

2006: 92

Cover: Mt Storsnasen (front) and Mt Tväråklumpen (back), Jämtland, Sweden. Under the *Picea* clone in the group of trees to the right a 5500 years old piece of subfossil *Picea* wood has been found.

ISSN 1652-6880
ISBN 91-576-7141-9
© 2006 Henrik von Stedingk, Umeå
Tryck: Arkitektkopia AB, Umeå 2006

Abstract

von Stedingk, H. 2006. *History of Picea abies in west central Sweden - applications of pollen analysis to reveal past local presence of trees.*

Doctoral dissertation.

ISSN 1652-6880, ISBN 91-576-7141-9

Early Holocene *Picea* megafossils found in west central Sweden have challenged the prevailing theory based on pollen analysis that *Picea* migrated to Scandinavia during the second half of the Holocene. Pollen analysis is the most used method for the study of past vegetation dynamics; however, in the study of the postglacial immigration of *Picea* or for studies at the forest-tundra ecotone where the local pollen production is low, it is crucial to be able to separate locally produced tree pollen from pollen coming from distant forests. This thesis aims to explore methods to facilitate the separation of local pollen from background pollen and thereby enable the inference of the local establishment of *Picea abies* at a site, to evaluate whether the *Picea* megafossils can be confirmed by pollen analysis, and to investigate the pollen-vegetation relationship at the forest-tundra ecotone.

Pollen analysis was carried out from mires situated near early to mid Holocene *Picea* megafossil sites in west central Sweden. The relationship between pollen from moss polsters and the surrounding vegetation was analysed with models for pollen dispersal and deposition. In a simulation study a landscape model for Holocene tree-line fluctuations based on palaeoecological data representing different time slices was evaluated by the comparison of numerous simulated pollen counts from different elevations with actual pollen diagrams.

The results show that it is possible to confirm the megafossils with pollen analyses, provided that the pollen sampling site is within tens of meters from the megafossil site. The timing of local *Picea* establishment and expansion differed between nearby sites. Parameters to facilitate the understanding of pollen-vegetation relationships at the forest-tundra ecotone were established: pollen productivity estimates (PPE), relevant source area of pollen (RSAP), and background and local pollen. The PPE at the forest-tundra ecotone differed from estimates in southern Sweden, showing varied responses to climate on pollen production for assorted taxa. It was concluded that the use of multiple adjacent sites for pollen analyses, calibration of modern pollen and current vegetation, and the simulation approach are applications that facilitate the interpretation of pollen analysis in terms of local presence of trees.

Keywords: Norway spruce, tree migration, Scandinavia, forest-tundra ecotone, moss polster, background pollen loading, long distance transport, pollen productivity estimates, simulation approach, ERV-model, megafossil, tree-line

Author's address: Henrik von Stedingk, Department of Forest Vegetation Ecology, Swedish University of Agricultural Sciences, SE-901 83 Umeå, Sweden.

Till Alfred & Fritjof

Contents

Introduction 7

- Hesselman's question 7
- Confusions regarding *Picea abies* migration to Scandinavia 7
- The problem with pollen studies at the forest-tundra ecotone 8
- Methods to assess Hesselman's question 8
- Objectives 9

Study area 10

Methods 11

- Pollen sites in relation to megafossil finds 11
- Calibration of pollen and vegetation at the forest-tundra ecotone 12
- A simulation approach 14

Results & discussion 16

- Pollen analyses in relation to early Holocene *Picea abies* megafossils 16
- Pollen productivity estimates 18
- Background and local pollen 20
- Simulation as a means to understand past vegetation dynamics 22
- Establishment of *Picea abies* in west central Sweden 23
- Considerations on methods for inference of local trees 25
- Hesselman's question revisited 26

Conclusions 27

References 28

Acknowledgements 32

Appendix

Papers I-IV

The present thesis is based on the following papers, which will be referred to by their Roman numerals:

I. Segerström U. & von Stedingk, H. 2003. Early Holocene *Picea abies* (L.) Karst., in west central Sweden as revealed by pollen analysis. *Holocene* 13, 897-906.

II. von Stedingk, H., Ek, L.-G., Hörnberg, G. & Segerström, U. Post-glacial establishment of *Picea abies* (L.) Karst. in the central Scandes. *Manuscript*.

III. von Stedingk, H., Fyfe, R.M. & Allard, A. Pollen productivity estimates for the reconstruction of past vegetation at the forest-tundra ecotone. *Submitted manuscript*.

IV. von Stedingk, H. & Fyfe R.M. The use of pollen analysis to reveal Holocene tree-line dynamics – a modelling approach. *Submitted manuscript*.

Paper I is reproduced by kind permission of SAGE Publications.

Introduction

Hesselman's question

At the 16th convention of Scandinavian naturalists in Oslo 1916 the Swedish scientist Lennart von Post presented pollen analyses as a method; that preserved pollen in peat profiles could reflect past vegetation changes (von Post 1918). Since then pollen analysis has been the most used method for the study of vegetation dynamics of the late Quaternary (Lowe & Walker 1997). At the discussion following the same lecture held in Stockholm a few months later, Henrik Hesselman, professor at the Swedish forest institute, raised a critical comment that has been a challenge to palynologists ever since: how could von Post possibly distinguish pollen contributed by a few trees in an unusual habitat from pollen produced by distant forests (Hesselman 1916)?

Confusions regarding *Picea abies* migration to Scandinavia

The immigration of *Picea abies* (L.) Karst. to Scandinavia is a classic problem in palaeoecology that brings Hesselman's question to a head. At the end of the 19th century it was already held clear that *Picea abies* arrived much later to Scandinavia than the other major tree taxa of the Scandinavian boreal forest following deglaciation, based on stratigraphical observations of macrofossils in peat (Gløersen 1884, Sernander 1892, Anderson 1896). They also suggested an east to west migration route for *Picea abies*. In his introductory lecture on pollen analysis von Post (1918) discussed the small frequencies of *Picea* pollen that precede the rise of the *Picea* pollen curve, and proposed that these small pollen frequencies represented scattered outposts of *Picea*. He further concluded that these outposts were important for the rapid establishment of *Picea* as a major forest constituent. Knut Fægri, one of the most influential palynologists of modern Quaternary palaeoecology (Birks 2002), clearly discarded the tail of *Picea* pollen as long distance transport only (Fægri 1950). After some years of passivity in the back wash of Professor Fægri's statement, the study of *Picea* migration advanced with the introduction of radiometric dating (Libby 1952). The new dating method made it possible to make comparisons of the timing of the expansion between regions. Thanks to the growing number of radiocarbon dated pollen analyses the expansion of *Picea abies* in Scandinavia could be mapped (*e.g.* Moe 1970, Tallantire 1977, Huntley & Birks 1983, Hafsten 1992).

The low frequencies preceding the increase in the *Picea* pollen curves, sometimes as almost continuous tails going back to the early Holocene, was of minor interest for these studies that focused on the forest establishment pattern of *Picea* (Moe 1970, Tallantire 1977). With the finds of late glacial and early Holocene *Picea* megafossils in the southern Swedish Scandes (Kullman 1995a, 1996, 2000) the theory of early *Picea* outposts regained interest. The megafossils were evidence of a *Picea* presence much longer back in time and much further west than earlier considered. A recent study by Giesecke and Bennett (2004) has addressed the large scale *Picea* migration to Fennoscandia based on interpolations between pollen analyses from numerous sites, and the discrepancy between the

pollen and megafossil record is evident. Kullman (2000) has declared the failure of pollen analysis to reflect the late glacial and early Holocene outposts of *Picea abies* inferred from finds of megafossils. A confirmation of these megafossils by pollen analysis can give better information on the population size of the *Picea* outposts, but also offer an opportunity to test and push the limit of the spatial resolution of pollen analysis *i.e.* can pollen analysis be used to reflect scattered small populations or even single trees? This thesis is the first study to examine the megafossil sites (Kullman 2000) with a palynological approach (Papers I and II).

The problem with pollen studies at the forest-tundra ecotone

Hesselman's question is also of importance for studies at the forest-tundra ecotone *i.e.* the transition zone between forest and tree-less alpine heath, with a generally low total pollen production and thus a high proportion of pollen coming from distant sources. Pollen coming from trees growing below the tree-line tend to overshadow the local vegetation changes, which makes studies of tree-line and forest-limit fluctuations difficult to interpret with traditional pollen analysis only (Birks & Birks 2000). Besides low pollen production due to harsh climate, the relative pollen production of the major taxa at the forest-tundra ecotone may differ from other regions. This assumption is based on the observation that many plants at the forest-tundra ecotone show variations in growth form (*e.g.* more prostrate) and reproduction strategies (a higher frequency of vegetative reproduction). Further, these environments mark the altitudinal and latitudinal extent of the range of many species. Therefore the pollen spectrum recorded at the forest-tundra ecotone cannot be interpreted by the same means as other environments such as boreal forest.

Methods to assess Hesselman's question

During the century that has passed since Hesselman raised his critical question on pollen representation to von Post, six important approaches have been developed to assess the question of local presence of trees vs. long distance pollen transport: 1) Site selection – basin type and size influence the pollen source area (Jacobson & Bradshaw 1981, Jacobson 1988, Sugita 1994); 2) Macrofossils – the correlation of pollen and macrofossils at one site can improve the interpretation of pollen analysis in terms of local presence of plants (Birks & Birks 2000, Birks 2003); 3) Pollen accumulation rate (PAR) – the measure of the absolute pollen contribution to a site (Hicks & Hyvärinen 1999, Hicks 2001, Seppä & Hicks 2006); 4) Modern pollen-vegetation relationship – calibration of current vegetation with pollen analyses from surface samples (Andersen 1970, Prentice *et al.* 1987, Gaillard *et al.* 1994, Broström *et al.* 2004); 5) Simulation – generation of simulated pollen counts in modelled landscape scenarios (*e.g.* Sugita *et al.* 1999, Giesecke 2005, Fyfe 2006, Caseldine & Fyfe 2006); 6) Quantitative reconstruction – a multi-step method aiming to quantify the local vegetation abundance by estimation of background pollen using different sized lakes (Sugita, in press a, b) and a quantification of the spatial scale for pollen source area (RSAP) (Sugita 1994).

In the current thesis these methods will be discussed in terms of their potential for elucidating early Holocene *Picea abies* establishment, and for addressing studies of vegetation history at the forest-tundra ecotone.

Objectives

The aims of the studies underlying this thesis were to:

- 1) Verify and examine the establishment of early to mid Holocene *Picea abies* inferred from megafossils in the southern Swedish Scandes with palynological methods (Papers I and II);
- 2) Examine the spatial distribution of *Picea abies* establishment in west central Sweden during the Holocene (Papers I and II);
- 3) Explore palynological methods and site selection for the separation of background pollen from locally produced pollen, and to infer local tree dynamics (Papers I, III, and IV);
- 4) Improve the understanding of the pollen-vegetation relationship at the forest-tundra ecotone (Papers III and IV).

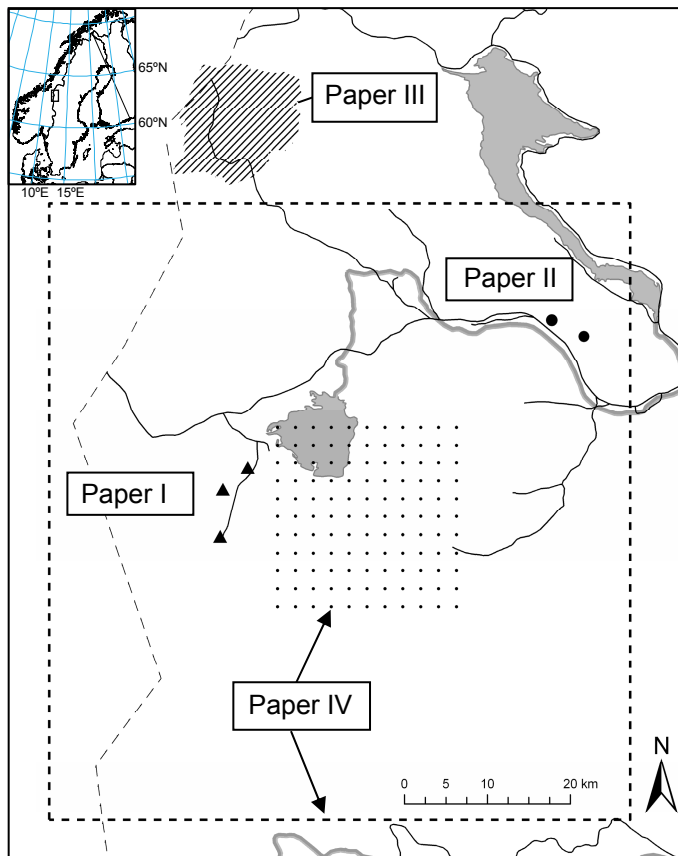

Figure 1. The study sites for Papers I-IV. Filled circles and triangles mark mires sampled for pollen analysis (Papers I and II). The hatched area show the area mapped for vegetation abundance (Paper III). The rectangle with broken line show the extent of the landscape model and the dots mark the sites for simulated pollen counts (Paper IV). Black lines represent roads, grey areas lakes and rivers, and the line to the left marks the border to Norway.

Study area

The study area is situated in the central Scandes, in west central Sweden (Figure 1). Amphibolite, gneiss and calcareous mica schist form the bedrock of Caledonian age which is mostly well covered by glacial till. The highest peaks are in the Sylarna massive, reaching more than 1700 m a.s.l, although most of the peaks in the area are around 1000 m a.s.l. The climate is semi-oceanic and humid with a stronger oceanic influence in the western part (Figure 2), where mires cover extensive areas, creating large open areas even below the forest-limit (Figure 3).

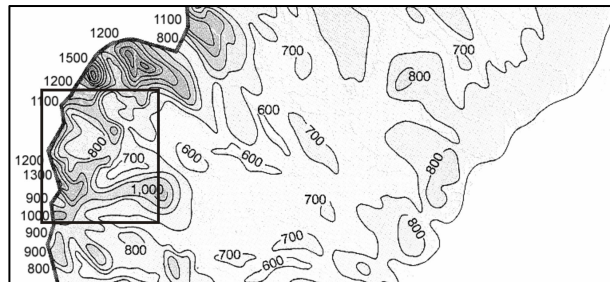

Figure 2. Annual precipitation (mm yr⁻¹) in central Sweden (Raab and Vedin, 1995; data from SMHI 1961-1990). The square marks the outline of Figure 1.

The forest-limit varies, but in general the subalpine mountain birch forest zone is found between 600 and 800 m a.s.l. where *Betula pubescens* ssp. *czerepanovii* (N. I. Orlova) Hämet-Ahti is the main forest tree. Scattered trees are also found above the forest-limit, at favourable sites on the alpine tundra. Below 600 m altitude there is coniferous forest with *Picea abies* and *Pinus sylvestris* L., with the first being the predominant taxon.



Figure 3. Mosaic of mire (sloping fens) and *Picea-Betula* forest in the north western part of the Skalstugan study area (Paper III). Photo Ulf Segerström.

Methods

Three different approaches were used to investigate the establishment of *Picea abies* in west central Sweden, and to address Hesselman's question on the interpretation of small pollen frequencies as local presence or pollen background: 1) pollen analyses adjacent to megafossil sites, 2) estimates of parameters for the understanding of the pollen-vegetation relationship at the forest-tundra ecotone, and 3) pollen simulations in modelled landscapes.

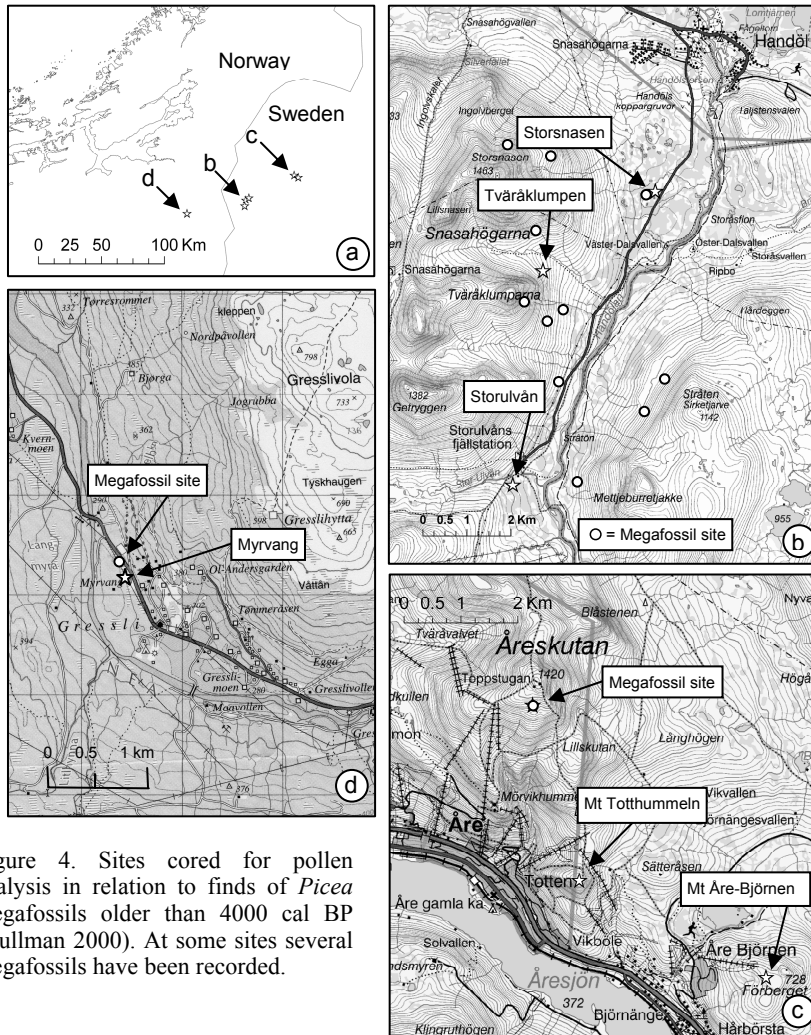

Figure 4. Sites cored for pollen analysis in relation to finds of *Picea* megafossils older than 4000 cal BP (Kullman 2000). At some sites several megafossils have been recorded.

Pollen sites in relation to megafossil finds

Pollen analysis was performed to examine the local *Picea* establishment and elucidate the imprint in pollen analysis of late glacial and early to mid Holocene *Picea* trees inferred from megafossils (Paper I and II). A total of six mires were chosen for pollen analysis (Figure 4). Three sites were sampled for pollen analysis

in the Handölan valley (Paper I). The sites were chosen in relation to finds of early Holocene *Picea* megafossils (Kullman 1995a, 2000, Figure 4b) as well as present day *Picea* distribution in the valley. Peat cores were obtained from: Storsnasen; situated 30 m from a present *Picea* clone under which subfossil wood had been found and dated to 5500 calibrated years before present (cal BP), Tväråklumpen; in an area where megafossils had been found, and Storulvån, situated outside the current *Picea* distribution. From Storsnasen a simple macrofossil analysis was made, primarily to look for *Picea* remnants, although wood remnants of other taxa were also recorded.

Spectacular finds of subfossil *Picea* wood remains on Mt Åreskutan dated to ca. 13000, 12000, and 9700 cal BP and subfossils from other tree taxa dated to the Late glacial (Kullman 2002) have challenged the current climatic and deglaciation models (Birks *et al.* 2005). Since there were no peat deposits to be found near the megafossil site, the adjacent Mt Totthummeln and Mt Åre-Björnen were chosen as sample sites (Figure 4c). The pollen analyses aimed to assess whether there were any time differences in *Picea* establishment on the three mountain peaks, and thereby determine whether the early establishment of *Picea* on Mt Åreskutan was a local or regional phenomenon in the area, and to assess the local vegetation history, focussing on tree dynamics (Paper II).

From an additional sample site, Myrvang, situated at 395 m a.s.l in the coniferous forest in Norway (Figure 4d), a peat core was retrieved 50 m from the site where a subfossil cone of *Picea abies* with an age of 6800 cal BP had been found (Kullman 2000).

Calibration of pollen and vegetation at the forest-tundra ecotone

The aim of Paper III was to provide important parameters for the understanding of the pollen vegetation relationship at the forest-tundra ecotone, parameters that are necessary for quantitative reconstruction and pollen simulation and can improve the interpretation of palaeoecological studies at the forest-tundra ecotone. These parameters were: 1) relevant source area of pollen (RSAP); the distance from the centre of a basin beyond which the correlation between pollen deposition and surrounding vegetation does not improve, 2) background pollen loading; pollen coming from beyond the RSAP, 3) pollen productivity estimates (PPE); a relative measure of pollen productivity. These three parameters were calculated by analysis of modern pollen samples and the vegetation surrounding the sample sites using extended R-value (ERV) models, *i.e.* explanatory models for the pollen-vegetation relationship.

The ERV models assume a linear relationship between pollen and plant abundance in absolute units. For a linear relationship the vegetation has to be distance weighted as plants growing closer to a sample point contribute a greater proportion of the total pollen loading than plants growing further away (Parsons & Prentice 1981, Prentice & Parsons 1983, Sugita 1994, Broström *et al.* 2004). Since pollen data normally are presented in proportions the ERV-models include a factor to correct for the Fagerlind effect (Fagerlind 1952, Prentice & Webb 1986). This effect occurs when a linear relationship becomes non-linear when absolutely

measured variables are converted to percentages and is evident for taxa reaching >30% (Broström 2002). The ERV model sets up the basic equation:

$$p_{i,k} = \alpha_i v_{ik} f_k + z_i \quad \text{[Equation 1]}$$

where $p_{i,k}$ = pollen percentage of taxon i at site k , α_i = pollen productivity of taxon i relative to the other taxa included in the sample, v_{ik} = vegetation abundance for taxon i at site k , f_k = a site specific factor which varies in different ERV models according to the abundance and parameter values of all taxa at site k and compensates for the Fagerlind effect (Fagerlind 1952), and z_i = the background component. There are three ERV models that differ in terms of pollen and vegetation input format and how the background pollen is defined (Sugita 1994, Jackson 1994, Broström *et al.* 2004) but the basic equation is standard. The slope of the pollen-vegetation relationship represents the pollen productivity of the taxon (PPE) and the y-intercept the background pollen component for that taxon (Parsons & Prentice 1981, Prentice & Parsons 1983, Sugita 1994, Broström *et al.* 2004).

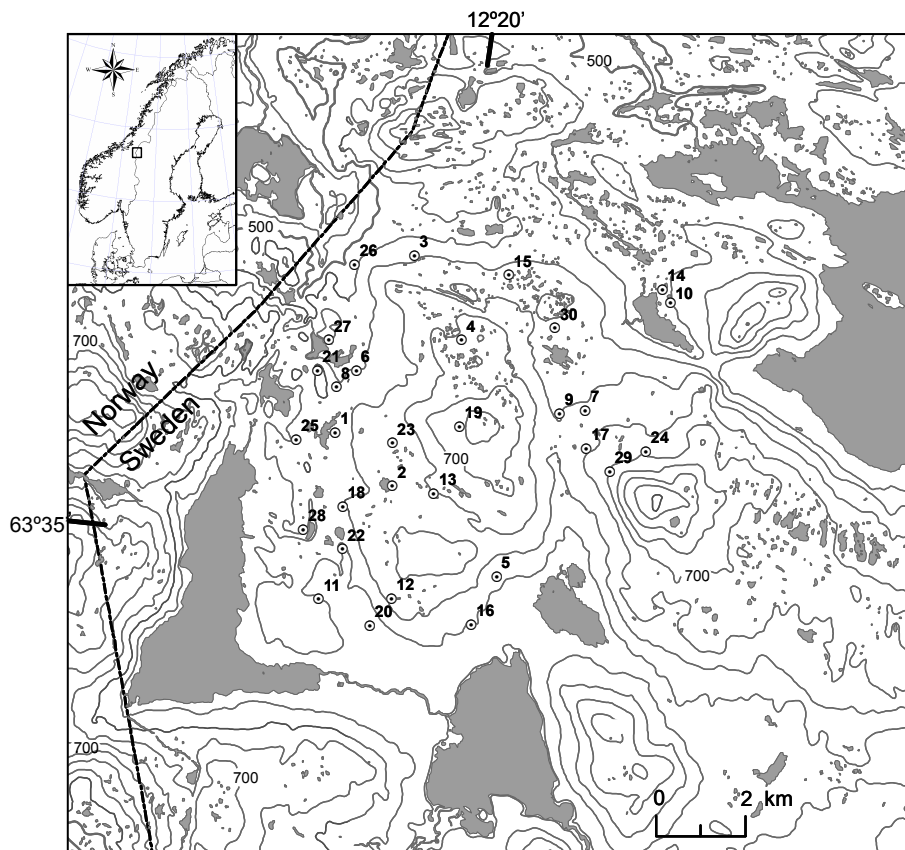

Figure 5. Map of study area and location of the 30 moss polsters. Each contour line represents 40 m altitude.

Sphagnum moss polsters were retrieved from 30 randomly sampled sites and analysed for pollen (Figure 5). Around each moss polster the vegetation abundance was mapped for the major taxa. A field survey was performed to obtain vegetation abundance data up to 100 m distance from each sample site by mapping vegetation communities and estimating vegetation cover (Figure 6). Vegetation abundance out to 2000 m was retrieved from interpretation of remotely sensed data (Colour Infra Red (CIR) aerial photos). The vegetation survey was performed by members of the pollen landscape calibration (POLLANDCAL) network (<http://www.geog.ucl.ac.uk/ecrc/pollandcal/index.htm>). The pollen counts and plant abundance data for 10 major taxa at the forest-tundra ecotone: *Pinus*, *Picea*, *Betula*, Cyperaceae, *Salix*, *Juniperus*, Poaceae, *Calluna*, *Empetrum*, and Ericaceae, were obtained from the 30 sites and formed the input for the ERV-models that were run using the software ERV-v6 (Sugita unpublished). The outcome from the computer runs of the ERV-models was used to estimate RSAP, PPE, background pollen and local pollen (*i.e.* pollen coming from within the RSAP). The results were compared with PPE from previous studies. For more details of the methods see Paper III.

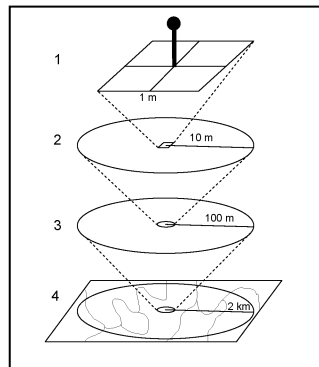

Figure 6. Vegetation mapping: 1) estimation of vegetation cover in four 0.5 X 0.5 m squares, 2) division in vegetation classes and estimation of crown cover of individual trees, 3) division of vegetation classes, estimation of single tree crown cover for solitary trees and total crown cover for groups of trees or forest stands, 4) division into polygons and estimation of proportion of land cover types: coniferous forest, deciduous forest, *Salix* shrubs, meadow, heath, wind heath (< 25 % vegetation cover), mire, water and non pollen producing areas such as settlements.

A simulation approach

The use of pollen analysis for detection of tree-line and forest-limit fluctuations was addressed with a simulation approach (Paper IV). The study area was centred in the Handölan valley, the same study area as in Paper I, an area with a unique palaeoecological record. A 'real' landscape, based on GIS analysis, was subdivided into a number of landscape mapping units which reflect the major vegetation zones in the landscape.

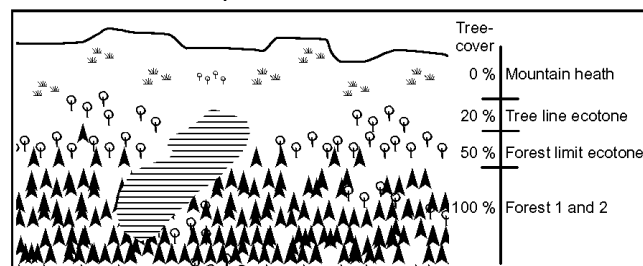
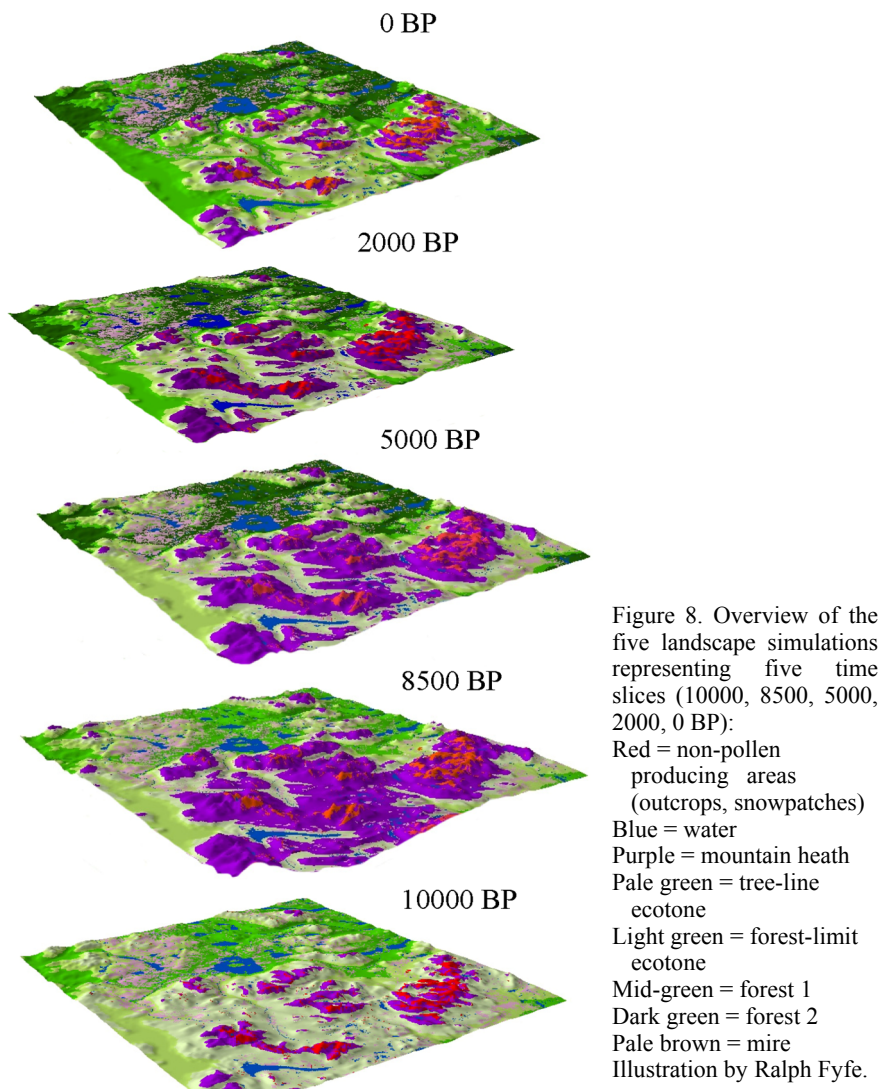

Figure 7. Schematic figure of the forest-tundra ecotone with landcover classes used for landscape modelling: mountain heath, tree-line ecotone, forest limit ecotone, two types of forest and mire (hatched).



Based on local and regional pollen analyses (Paper I, Lundqvist 1969, Holmgren 2000, Bergman et al. 2005) abundance of taxa was added on the basis of a general model (Figure 7). The limit of vegetation zones was varied for different time slices (Figure 8) according to local studies of Holocene tree-line fluctuations (e.g. Kullman 1995b, 1998a, 2004, Kullman and Kjällgren 2000, Bergman 2005).

The modelling approach applies recent advances within the POLLANDCAL-network (<http://www.geog.ucl.ac.uk/ecrc/pollandcal/index.htm>) in the application of the relationship between pollen and distance-weighted plant abundance (Prentice 1985, Sugita 1993, 1994). By generating numerous (121) simulated pollen counts systematically placed (Figure 1) at different elevations in the landscape model, a mean simulated pollen record was calculated for different altitudinal ranges, by use of the PPE from Paper III. The simulated pollen counts

were then compared with actual local pollen studies and thereby the basic assumptions for the modelled landscapes could be validated and offer new insights for discussing the tree-line and forest-limit fluctuations and changes in tree composition during the Holocene.



Figure 9. View of Mt Tväråklumpen (left) and Mt Storsnasen (right). The white circle marks the *Picea* clone described in Paper I. The sample site Storsnasen is situated just behind the stand including the *Picea* clone. The arrow points at site Tväråklumpen.

Results & discussion

Pollen analyses in relation to early Holocene *Picea abies* megafossils

The pollen record is only in accordance with the *Picea* megafossils following a traditional interpretation, at one of the six sites, Storsnasen (Paper I). Here the start of the continuous *Picea* curve coincides with the age of the wood remains of *Picea abies*, ca. 5500 cal BP (Kullman 1995a), found 30 m from the coring site (Figures 9 and 10, Paper I). Between 8500 and 5500 cal BP there is a regular low proportion of *Picea* pollen that coincide with seven *Picea* megafossils older than 5000 cal BP and registered at Mt Storsnasen (Kullman 2000, Figure 4b). The oldest is dated to 9000 cal BP.



Figure 10. The *Picea* clone 30 m from the pollen sample site Storsnasen (Paper I). Under this clone subfossil *Picea abies* was found and dated to 5500 cal BP (Kullman 1995a). Picture taken standing at the coring site.

At Tväråklumpen, 2 km further into the Handölan valley (Figure 9), the continuous curve starts at ca. 3000 cal BP, without any preceding stray finds of *Picea* pollen. At Mt Tväråklumpen five *Picea* megafossils older than 4000 cal BP have been found (Kullman 2000, Figure 4b). At Storulvån the *Picea* pollen curve starts at ca. 500 cal BP. Three pollen grains were registered before the *Picea* rise, at 9000, 7500 and, 2000 cal BP. From the other three sites only a few *Picea* pollen grains were recorded before the rise of the *Picea* curve, i.e. at Mt Åre-Björnen single *Picea* pollen grains were found at 9000 and 5000 cal BP (Paper II) and none neither at Mt Totthummeln (Paper II) nor at Myrvang (Figure 11).

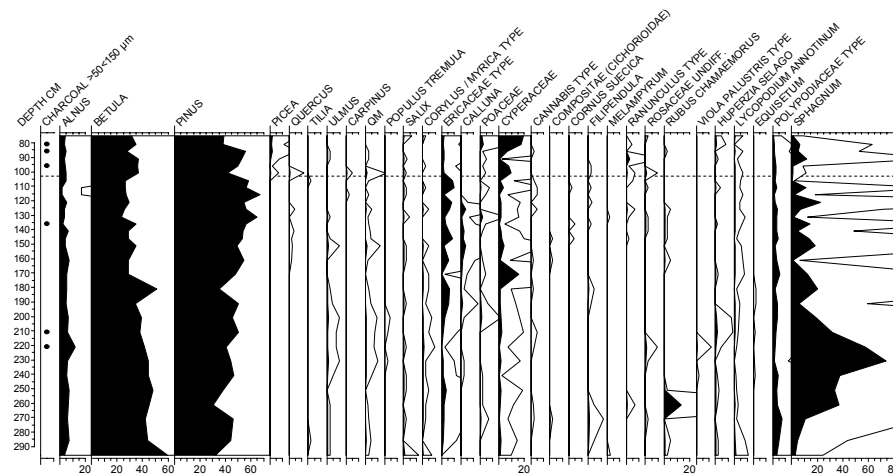

Figure 11. Percentage pollen diagram from Myrvang, Sør-Trøndelag, central Norway (63°34'N, 11°26'E, Figure 4). From the left: depth scale in cm, presence of charcoal particles, percentage of individual pollen taxa and spore types. Black fields show the percentage of each pollen type, and hollow fields demonstrate per mille values. Each sample represents 2 cm. The pollen percentage is based on 450-550 terrestrial pollen grains counted including Cyperaceae. A comparison of the *Ulmus* curve and the *Picea* curve in pollen analyses from the region give an approximate age of 2000 cal BP for the start of the *Picea* curve. Analyst: Anna Berg.

Only at Storsnasen could the mid Holocene *Picea* megafossils (Kullman 1995a) be confirmed by pollen analysis. The regular presence of *Picea* pollen from 8500 cal BP could be interpreted as local contribution. The single pollen grains preceding the continuous *Picea* pollen curve would normally have been regarded as long distance transport. With the *Picea* megafossils (Kullman 2000) found in the area an alternative interpretation is possible. The small pollen frequencies at periods where local trees have been inferred from megafossils imply that these trees represent a limited distribution of *Picea abies*, and possibly only scattered trees. To be able to record those early *Picea* outposts the pollen sample site has to be within tens of meters from the former *Picea* population. Further, in the boreal forest with a high total pollen production the pollen contribution from one or a few trees may be too small to be recorded with a pollen count of 400-500 pollen as at Myrvang, as no pollen were recorded 50 m from the inferred *Picea* trees. In the search for a single large grained pollen type it is possible to make a quick scan of the pollen slides. This has been done in studies of *Picea* pollen to get per mille values: von Post (1918) counted *Picea* in relation to *Pinus* pollen, Fægri used

(1950) arboreal pollen, and Giesecke (2005) used an added spike; Lycopodium spores. The method can be used to detect small scale differences that with a normal pollen count would require a sample site very close to the former plant site, such as small scale agricultural fields (Edwards *et al.* 2005) or the establishment of small *Picea* populations in a high pollen producing environment. At Myrvang, the pollen sum required in order to record *Picea* pollen from the tree inferred by the mid Holocene *Picea* cone in a high pollen producing environment such as the boreal forest, would have been interesting. However, the quick scan method may be fast in relation to counting all pollen, but is still time consuming and was therefore beyond the scope for the Myrvang study.

Pollen productivity estimates

A comparison with PPE from southern Sweden (Sugita *et al.* 1999, Broström *et al.* 2004) shows differences that confirm the assumption of Sugita (1994) that PPE may vary between regions (Paper III). PPE is a major parameter for simulation studies and quantitative reconstruction. In order to establish firm PPE for different types of regions it is important to understand the causes of the variation in PPE.

The major differences between PPE in west central Sweden and Southern Sweden are found for taxa with a different growth behaviour in the mountain region and with a dissimilar species or subspecies representation in the pollen taxa. Growth behaviour may have two implications for pollen dispersal and PPE: 1) a prostrate plant may have less flowers in relation to leaf cover than a tree-formed plant; 2) the pollen from the prostrate form are less dispersed since wind dispersal is more efficient higher up from the ground. The taxon *Juniperus* is one example, where the southern *J. communis* ssp. *communis* L. in southern Sweden is more of a tree, while the prostrate *J. communis* ssp. *nana* (Willd.) Syme that is found in northern Sweden rarely is more than 1 m high. For *Salix* the main pollen contributor in southern Sweden is the tree *Salix caprea*, while in the Scandes the main *Salix* species are shrubs or even dwarf shrubs. For both these taxa the PPE from west central Sweden is lower than from southern Sweden (Table 1).

Taxon	Pollen productivity estimates	
	west central Sweden	southern Sweden
<i>Alnus</i>	-	4.2
<i>Betula</i>	2.2	8.9
<i>Calluna</i>	0.30	4.7
Cyperaceae	0.89	1
<i>Empetrum</i>	0.11	-
Ericaceae	0.07	-
<i>Juniperus</i>	0.11	2.1
<i>Picea</i>	2.8	1.8
<i>Pinus</i>	21.6*	5.7
Poaceae	1	1
<i>Salix</i>	0.09	1.3

Table 1. Pollen productivity estimates from west central Sweden (Paper III) and southern Sweden (Broström *et al.* 2004, Sugita *et al.* 1999). * PPE is not reliable because of too low vegetation abundance gradient.

For *Betula* the same reasoning as for *Juniperus* is valid, with a different subspecies at the mountain range. Different taxa and indirect climate effects may be the most important reasons for differences in the PPE from the forest-tundra ecotone compared to southern Sweden. Also important is the pollen production of the reference taxon Poaceae, since PPE is a relative measure. In the humid oceanic climate in west central Sweden pollen production of Poaceae may be less affected by climate than other taxa, thereby causing a generally lower PPE for the taxa at the forest-tundra ecotone (Table 1).

It has been proposed that the pollen production of *Picea abies* growing on their climatic margin should suffer relatively more than *Betula* and *Pinus*, since *Picea* in these areas mainly rely on vegetative reproduction. Therefore the higher PPE for *Picea* than for *Betula* was unexpected (Table 1). Unfortunately the PPE for *Pinus* was not reliable since the vegetation gradient of *Pinus* was too small. The PPE for *Picea* may also vary, since there is a high variability in *Picea* pollen production in marginal areas compared to *Betula* and *Pinus* (Hicks & Hyvärinen 1999, Hicks 2001). The higher frequency of warm summers at the forest-tundra ecotone during the last decade suggests that there may be a temporal variability in pollen productivity over decadal time scales where the general pollen production is low and there is a strong variability in flowering depending on climate (Paper III). The flowering variability emphasizes the importance of including several years of pollen deposition in the moss polsters in studies of PPE and pollen-vegetation relationships in marginal areas. Therefore moss polsters of *Sphagnum*, as used in Paper III, are recommended in climatically unfavourable regions, since the dead part of the moss is preserved, and thereby several years of pollen representation is accumulated in each moss polster (*cf.* Räsänen *et al.* 2004).

A better understanding of what causes the variation in PPE would make it possible to choose the PPE suitable for the study region, without having to obtain local PPE for every area that you wish to include in a simulation study or for quantitative reconstruction. Comprehension of the parameters that influence PPE will also make it possible to vary PPE through time, and thereby take into account the long term vegetation dynamics with shifts in biomes from e.g. tundra to boreal forest, that may be apparent in a pollen diagram. PPE may be varied in two ways: 1) PPE obtained from tundra environment and boreal forest respectively can be used for the different periods at the same site using current PPE as modern analogues, 2) to vary PPE for different periods in a consistent way according to factors influencing PPE such as changes in climate. In a setting with different biomes within a limited distance, as is the case in mountainous areas, it is possible to use different PPE within the same period i.e. forest-tundra ecotone PPE for the local pollen and boreal forest PPE for the vegetation at a certain distance. A first step in this direction is the several PPE-studies that has been performed recently from different regions by researchers within the POLLANDCAL-network (Paper III, Broström *et al.* in prep), and more studies are planned or under preparation.

Background and local pollen

When interpreting a pollen diagram the pollen assemblage is traditionally divided into three different source categories: local pollen; pollen coming from plants growing in the vicinity of or on the site, regional pollen; pollen that reflects the regional plant composition, and long distance transport; pollen coming from hundreds of km away. These categories are commonly used in palynology, but the distinctions between the categories are rather vague. The definition of background pollen as pollen contribution from plants growing beyond the RSAP and local pollen as pollen coming from within the RSAP quantifies the spatial scale (Sugita 1994). Background pollen load is by this definition constant in a given region of *ca.* 5000 km². However, the proportion of background pollen varies between sites with site characteristics such as basin size and local pollen production. The background pollen load includes both regional pollen and long distance transport, without making any distinction between the two.

Estimation of the background pollen component is the key to quantitative reconstruction (Sugita in press a, b). The background of current pollen loading can be quantified by applying ERV-models to modern pollen and vegetation abundance (Parsons & Prentice 1981, Prentice & Parsons 1983, Prentice 1985, Sugita 1994, Calcote 1995, Paper III). This also allows for calculation of the local pollen, *i.e.* pollen coming from within RSAP, estimated to 500 m for moss polsters at the forest-tundra ecotone (Paper III). The results showed that background constituted *ca.* 60% of the total pollen, with mostly tree pollen (Table 2). More than half of the local pollen originated from graminoids. This low local pollen contribution of the trees growing at the forest-tundra ecotone (Pardoe 2001, Eide *et al.* 2006), confirms that changes in the tree-lines can be hard to study using pollen analysis only (Birks & Birks 2000).

The varying pattern of *Picea* pollen at the three sites in the Handölan valley was used to indicate that there was no background of *Picea* pollen in the valley until recently (Paper I). Thereby the *Picea* pollen frequencies were used to infer local trees, rather than long distance transport. This use of multiple sites requires that the pollen analyses are performed on stratigraphies taken from similar basins in the same region with comparable RSAP, and works only for a single pollen taxon that is present in the pollen spectrum from some sites and absent from others.

Taxon	Observed pollen		Background pollen		Local pollen	
	mean %	s.d.	mean %	s.d.	mean %	s.d.
<i>Betula</i>	26.6	14.0	20.4	2.1	6.2	14.5
<i>Pinus</i>	24.1	8.7	23.2	2.4	0.9	8.7
<i>Picea</i>	13.8	7.6	8.9	0.9	4.9	8.1
Poaceae	11.0	12.7	3.3	0.3	7.7	12.8
Cyperaceae	20.6	17.6	0.6	0.1	20.0	17.5
<i>Salix</i>	0.2	0.2	0.1	0.0	0.1	0.2
<i>Juniperus</i>	1.0	1.0	1.0	0.1	0.0	1.0
<i>Ericaceae</i>	0.7	0.6	0.4	0.0	0.3	0.6
<i>Calluna</i>	0.8	1.0	0.2	0.0	0.6	1.0
<i>Empetrum</i>	1.1	1.7	0.7	0.1	0.4	1.6

Table 2. Mean of the observed pollen proportions from all moss polster sites (Paper III): background pollen, and local pollen; observed pollen minus background pollen, and standard deviation.

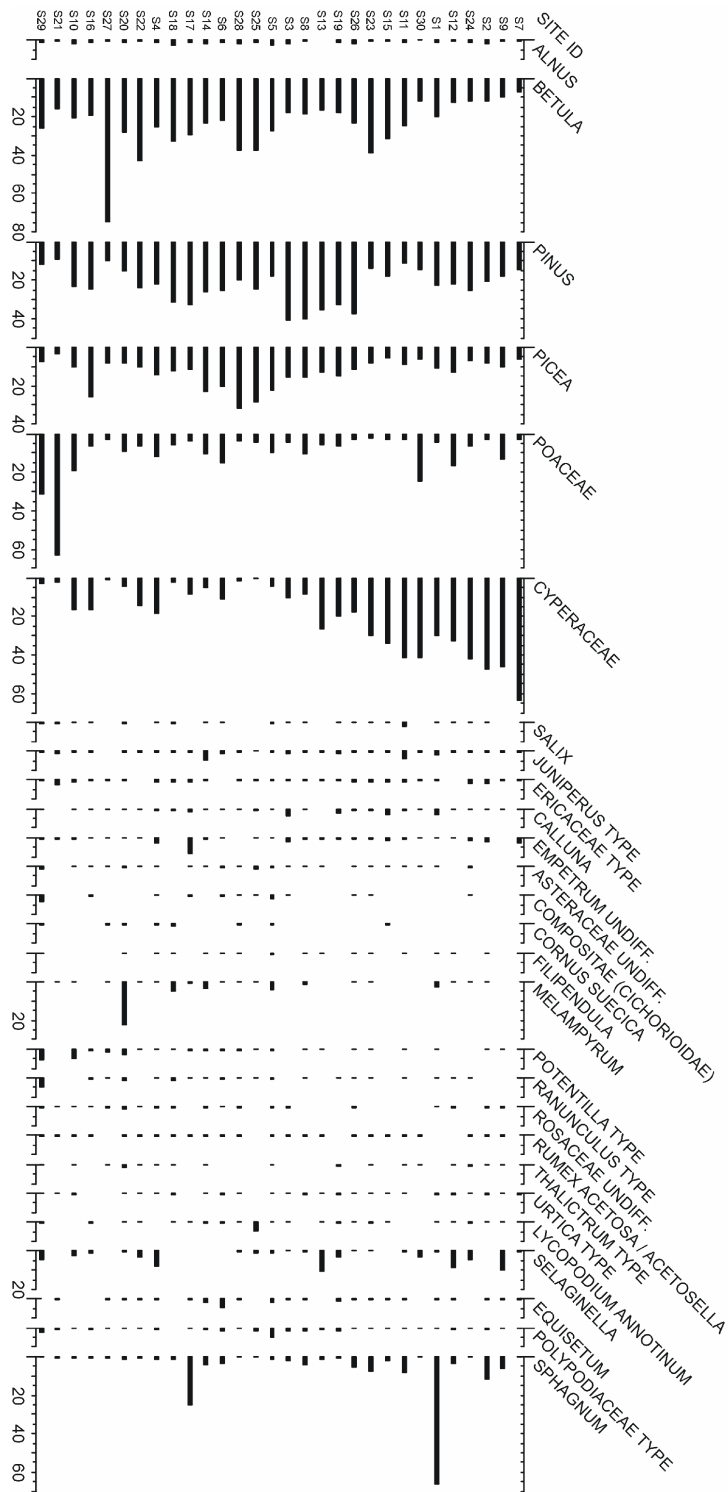

Figure 12. Percentage pollen diagram of selected taxa from Skalistugan, Jämtland, west central Sweden, based on pollen analysis in 30 moss polsters.

In the pollen analyses from moss polsters (Paper III) *Urtica*, *Alnus*, and *Pinus* were recorded at most sites, but were absent or had low occurrences in the vegetation (Figure 12). Thereby the regional background for these taxa is the mean pollen frequencies from all the sites (Table 3). *Urtica* was not found on any of the 30 sites (100 m radius) surveyed in the field, only a few trees of *Alnus* was found, and *Pinus* was present only in open forests in the northern part of the area. Estimates of the present regional background pollen can be used to support interpretations of fossil pollen diagrams from similar regions.

	Mean (%)	S.D.	Sites without pollen	Table 3. Mean pollen proportions of selected taxa, based on pollen analysis from 30 moss polsters at Skalstugan, standard deviation and number of sites without any pollen record of the selected taxa.
<i>Alnus</i>	1.1	0.7	1	
<i>Pinus</i>	22.4	8.8	0	
<i>Urtica</i>	0.3	0.3	5	

Background pollen frequencies should be used with great care, since they are proportional and therefore vary with site characteristics. Another reason for caution with modern estimations of background for interpretation of fossil pollen diagrams is that the regional vegetation may have changed (*cf.* Giesecke 2005). This can explain the difference in background pollen between Papers I and II on one hand that indicate no *Picea* background until recently and Paper III on the other, where the modern background is estimated to 8%. One reason for the discrepancy can be that the present predominance of *Picea* at and around Skalstugan (Paper III) is quite recent. At Storulvån (Paper I) the *Picea* pollen proportion is 4% in the surface sample. This site is situated outside the present day *Picea* distribution as the *Picea* forest-limit is *ca.* 5 km to the north, along the Handölan valley. In all other directions the site is surrounded by mountains, and with more than 20 km to the *Picea* distribution limit. This addresses the questions of the influence of topography and predominant wind direction on regional background pollen and pollen dispersal in general, that complicates the present models for pollen dispersal and deposition (*cf.* Paper IV).

Simulation as a means to understand past vegetation dynamics

Simulation studies represent a very simplified universe and thereby all simulations fail to strictly mimic reality. Despite that, modelling and simulation can give valuable results that help to understand the reality. With a GIS program a modelled landscape can be visualized, and the landscape model can be evaluated in relation to pollen analyses from the area. The simulation approach offers an opportunity to try out intuitively based hypotheses of vegetation structure or of methodological aspects of pollen analysis and thereby make diffuse thoughts of past plant distributions more explicit. Modelling will offer possible scenarios and identify those scenarios that are extremely unlikely (Caseldine & Fyfe 2006) and in the process alternative interpretations may develop.

The modelled landscape in Paper IV showed a good agreement from 8500 to 0 BP with the actual pollen analyses, implying that the landscape scenarios suggested from the model are based on a plausible model for tree-line variation and plant abundance, which was very encouraging. The good agreement was

based on similar trends in the diagrams rather than actual frequencies. For the 10000 BP time slice the agreement was poor between simulated and actual pollen counts. One reason for the discrepancy could be that the palaeoecological data for this time is insufficient as some of the pollen analyses do not reach that far back in time and the megafossils that were the bases for the reconstruction of tree-line fluctuations are few (Kullman 1995b, 2004, Kullman & Kjällgren 2000). The main reasons are however, probably that the altitudinal zonation had not yet developed (Hammarlund *et al.* 2004, Bergman 2005), and that we lack modern analogues to the period when *Hippophaë rhamnoides* L. grew together with *Betula* and *Pinus* directly after the deglaciation. The finds of early Holocene megafossils of thermophilous trees such as *Quercus robour* L., *Tilia cordata* Mill. and *Corylus avelana* L. in the area (Kullman 1998b, c) underline the difficulties to visualize the early Holocene landscape based on any current vegetation settings. However, the simulation approach includes, in theory, infinite possibilities to vary the vegetation composition. Thereby the simulation approach may be an instrument to overcome the classic problem with lack of modern analogues, and instead constitute a source for the development of alternative hypotheses.

An obvious advantage of the simulation approach is the possibility to run series of pollen counts by just pushing a button. Thereby trends can be visualized as in Paper IV where average pollen frequencies are used to represent different altitudes, and thereby overcome the signals from local variation. The simulation approach has been used to give insights to a wide spectrum of palynological problems, and thereby contributed to the understanding of vegetation dynamics. Besides Paper IV that deals with Holocene tree-line variation the potential of the simulation approach can be illustrated by previous simulation studies that has dealt with various dilemmas in vegetation history, such as the characteristics of elm decline/landnam landscapes in Ireland (Caseldine & Fyfe 2006), the expansion of mixed agriculture to the uplands in medieval south western England (Fyfe 2006), and whether the migrational pattern of *Picea* to Scandinavia was a moving front or expanding populations (Giesecke 2005). The simulation approach can also be extremely helpful in the experimental design of a pollen based project, as in paper IV that aimed to specify the optimal altitude for site selection for the study of Holocene tree-line and forest-limit variation. For studies using multiple sites the optimal location and number of sites can be explored. Simulations have also been used to explore different aspects related to models of pollen distribution and deposition such as the effect of landscape openness on pollen analysis (Sugita *et al.* 1999), influence of vegetation structure on pollen source area (Bunting *et al.* 2004, Nielsen & Sugita 2005), effects of basin size on RSAP (Sugita 1994), and sampling strategy for obtaining good PPE (Broström *et al.* 2005).

Establishment of *Picea abies* in west central Sweden

Picea became established in the area during the early Holocene (Kullman 2000) as scattered trees. At a few sites (Figure 13: site 14, 17, 22, and 27) there was an expansion of *Picea* during the mid Holocene although the general *Picea* expansion in the area was around 2000 BP (Figure 13). The local establishment in the Handölan valley (Paper I) shows a different pattern of *Picea* expansion, with *Picea* expanding into the valley at a rate of 1 km per millennium. *Picea* expanded

at 5500 BP in the northern part of the valley and reached the present *Picea* tree limit 6 km further south only recently (Paper I, Figure 3).

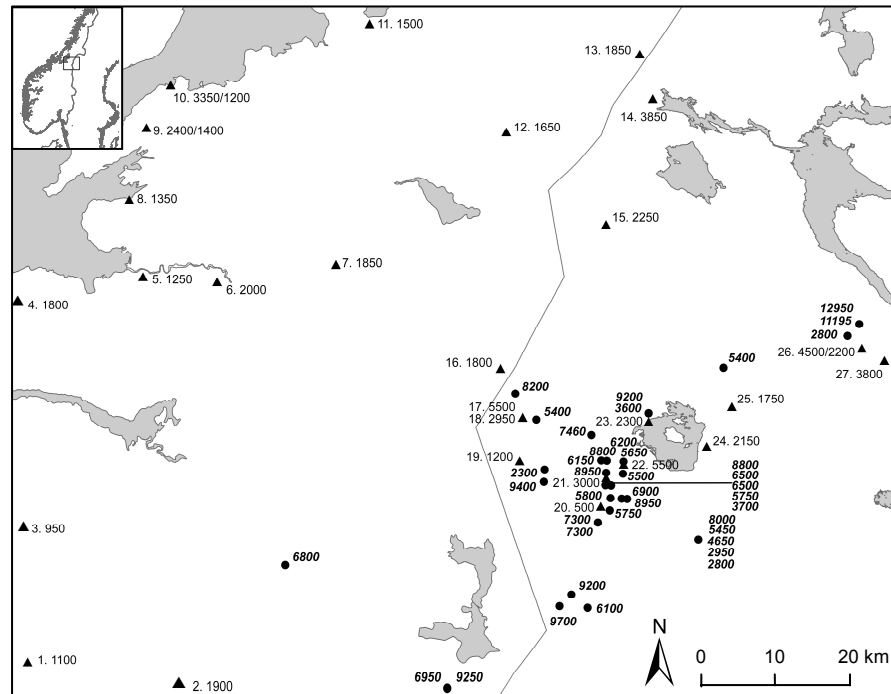

Figure 13. Map of palaeoecological sites related to *Picea* establishment and expansion in a part of central Scandinavia. Black circle marks mires analysed for pollen, followed by id and age (cal BP) of the rise of the *Picea* pollen curve (1-4; Trillerud 1983, 5-10 and 16-18; Sandvik 1986, 11-13; Selvik 1985, 14, 15, 19 and 23-25; Lundqvist 1969, 20-22; Paper I; 26-27; Paper II). At some pollen sites the first age represents the start of the continuous *Picea* pollen curve and the second represents the rise. Triangle marks sites for *Picea* megafossils followed by age (cal BP) in italics (Kullman 2000).

The lack of correlation in time between the early to mid Holocene *Picea* megafossils (Kullman 2000) and the rise of the *Picea* pollen curve from sites in the same area (Figure 13), imply that these proxies work on different spatial scales. Megafossils infer no more than the actual specimen or possibly solitary trees, although there can be few doubts that the tree actually grew there. The low frequencies of *Picea* pollen from the early Holocene suggest that there were only small numbers of *Picea* trees established (Paper I and II). The rise in the pollen curve is instead a reflection of local *Picea* population expansion. The local dates for the rise in the *Picea* curve vary, in accordance with the model of expanding populations (*cf.* Giesecke 2005), although the time difference between *Picea* expansion at adjacent sites may be much greater than earlier realized. The local variation in *Picea* expansion apparent in Figure 13 is normally lost in large scale migrational reconstructions (*e.g.* Moe 1970, Huntley & Birks 1983, Latalowa & van der Knaap, in press). The pattern of local *Picea* establishment and expansion based on the unique palaeoecological record of pollen analyses and

megafossils from the central Scandes offers a possibility for alternative interpretations of previous pollen diagrams. Pollen diagrams from two adjacent mires at Storvallen (Figure 13: site 17 and 18) gave very different ages for *Picea* expansion, 2950 and 5500 cal BP respectively (Sandvik 1986). The older radiocarbon date was discarded by Hafsten (1992) since it did not fit with the general model. Within a few km from the site a megafossil of *Picea* has been dated to 5400 cal BP (Kullman 2000). A long tail of continuous *Picea* pollen preceding the rise in the curves at site 9 and 10 were considered as long distance transport (Hafsten 1992).

Considerations on methods for inference of local trees

Birks & Birks (2000) recommend that pollen analysis should be combined with analysis of macrofossils at tree-less situations such as studies from the Late glacial or at the tree-line. The macrofossil analysis from Storsnasen (Paper I) was made with the aim to find *Picea* needles. No needles were found, but coniferous wood (most of it *Pinus*) and *Pinus* bark was found from 8000 to 2000 cal BP. These macrofossils enabled the inference of local forest cover on the site. The denser forest reconstructed from 8000 to 2000 cal BP imply a higher local tree pollen production, and thus the low percentages of *Picea* pollen were interpreted to be of local origin, rather than long distance transport.

Megafossils are normally interpreted as evidence of local growth, since large pieces of wood or cones are not expected to travel long distances. Megafossils, however take a lot of time and effort to localize. The megafossil record is therefore discontinuous and the finds may be more related to preservation conditions than true differences in former population sizes. The megafossils themselves can also be dated, and thereby disturbances in the stratigraphy that can be crucial in the study of pollen, is of less concern. Although, as every specimen needs to be radiocarbon dated to have the full value for interpretation of former vegetation conditions it can be rather expensive. The finds of late glacial megafossils at Mt Åreskutan (Kullman 2002) have been questioned since they challenge the present models of climate change and deglaciation (Giesecke 2004, Birks *et al.* 2005, Birks *et al.* 2006). The arguments brought forward have been the rareness of late glacial megafossils and the dating being most critical. The suggestion that nunatacks occurred in Norway from 16 000 cal BP (Paus *et al.* 2006) supports Kullman's argument that the earlier models need to be revised.

The pollen accumulation rates (PAR) can indicate whether a tree taxon really was growing close to a site or whether a regional source or long distance transport is more liable. The absolute measure of pollen is an attractive approach that offers many possibilities. Based on modern pollen rain in pollen traps Hicks (2001) has suggested limits of influx to infer tree-line and forest-limits in northern Finland. A limitation of PAR is that it requires a very good chronology that may not be achieved even with several radiocarbon datings (Telford *et al.* 2004). This was the main reason for not including PAR in Paper I and II. At the only site with an age chronology good enough for estimation of PAR, Storsnasen, the analysis of macrofossils was used to infer local trees making estimation of PAR unnecessary

(Paper I). However, the estimation of PAR would have been interesting for comparison to other studies (Hicks 2006).

The interpretation of different proxies is often complex and differences between sites may be caused by different basin characteristics rather than reflections of actual vegetation, and thereby the interpretation of PAR and macrofossils may actually conflict (*cf.* Eide *et al.* 2006). Also, since local pollen production may vary PAR thresholds from pollen traps indicating presence of trees or forest (Hicks 2001) can not be transferred unambiguously to another region (Karlsson *et al.* in press.).

Hesselman's question revisited

When Hesselman raised his critical question to von Post he questioned the reliability of interpreting pollen analysis in terms of local vegetation changes. He was confident that the long distance transport would totally overshadow the local pollen contribution in any situation (Hesselman 1916, 1919). Hesselman's criticism was a bit exaggerated since the long distance transport in most environments is negligible, due to the large local pollen production. However, the regional pollen contribution may have a large influence, depending on basin size (Sugita 1994) and Hesselman's comments may still be relevant for tundra conditions (Birks & Birks 2000) and studies from the late glacial (Birks 2003, Brubaker *et al.* 2005) where the local pollen production is low and the relative contribution of pollen coming distant sources is high.

There is no panacea in palaeoecology for inference of local presence of trees at any site, but a spectrum of methods and applications may contribute valuably to the understanding of the past. Different proxies have different advantages and the choice of methods may vary. Most fundamental is to design the project and chose the methods best aimed to answer the research question addressed. This has not always been the case in palaeoecological studies that sometimes have had a tendency to be more descriptive than aiming at hypothesis testing (Caseldine & Fyfe 2006). The multiple site approach is essential in studies of the immigration of a single taxon such as *Picea* (Paper I). Paper IV showed that there may be an optimal altitudinal range for pollen analysis to detect Holocene tree-line dynamics, at least in a modelled landscape. In reality things are more complex and the use of multiple sites at different elevation may be the design that has the best probability of detecting Holocene tree-line changes (*cf.* Eide *et al.* 2006). But while tree-line changes are directional, the distribution of single trees or small populations of *e.g.* *Picea* is more random. The multiple site approach requires something to relate to such as altitude for tree-lines or megafossils as in the case of *Picea* migration (Paper I); otherwise many more than three sites are required. For studies at the forest-tundra ecotone the use of PAR and macrofossils can be good supplements to traditional percentage pollen analysis (Eide *et al.* 2006, Seppä & Hicks 2006).

The theoretical models of pollen dispersal and pollen deposition have helped in understanding the influence of background pollen, as they facilitate simulations (Paper IV) and to quantify parameters for modern pollen vegetation relationships, *i.e.* RSAP, background pollen, and PPE (Paper III). In all they enable more reliable reconstructions of past landscapes from fossil pollen.

The problem of background pollen may be resolved with the quantitative reconstruction approach as the last theoretical pieces of the puzzle are fit together with the two step model called the Landscape Reconstruction Algorithm (LRA): 1) Regional Estimates of Vegetation Abundance from Large Sites (REVEALS) that estimates the regional vegetation composition (Sugita in press a) and 2) the LOVE (Local Vegetation Estimates) model that translates the regional vegetation composition to background pollen that is used for reconstruction of local vegetation (Sugita in press b). With the theoretical framework ready the application and validation of the method can get started. The study area in Paper III, with numerous lakes of any size, and with local PPE would be a suitable area for the quantitative reconstruction approach.

Conclusions

- The early to mid Holocene *Picea* megafossils could be verified by pollen analysis. However, the pollen sample site has to be located within tens of meters from the megafossil site, in order to record pollen from the former *Picea* trees.
- Early Holocene *Picea* pollen grains recorded in pollen diagrams in west central Sweden can in most situations be considered as of local origin. *Picea* was not included in the pollen background until the late Holocene.
- The local *Picea* establishment and expansion may differ in time and rate between adjacent sites. Low proportions of *Picea* pollen that predate the regional *Picea* expansion can therefore not unambiguously be regarded as due to long distance transport.
- During early Holocene *Picea* established in west central Sweden as scattered solitary trees. During mid Holocene there was a local *Picea* expansion at some sites, preceding the regional *Picea* expansion at ca. 2000 cal BP.
- Pollen analysis from multiple sites, calibration of pollen and current vegetation, and the combination of pollen and macrofossils or megafossils from adjacent sites were all successful methods for elucidating local *Picea* migration, to quantify the present pollen background, and to enhance the understanding of past spatial tree distribution.
- Pollen productivity estimates (PPE) at the forest-tundra ecotone differs from PPE in southern Sweden. The differences may be explained by climatic conditions that influence pollen production, species included in the taxon, and growth behaviour. It is important to understand why the PPE varies in order to establish firm estimates for different regions.
- The simulation approach can give valuable insights to both long term vegetation dynamics and methodological issues in palynology. Specific areas where the simulation approach has a high potential are at: evaluating hypothesis of past vegetation dynamics, providing the foundation for creating new hypotheses; *i.e.* concerning vegetation communities that lack modern analogues, exploring the past spatial plant distribution and create landscape scenarios, and examining the optimal experimental design for pollen based projects; *i.e.* optimal site placement and number of sites.

References

- Andersen, S.T. 1970. The relative pollen productivity and representation of north European trees, and correction for tree pollen spectra. *Danmarks Geologiske Undersøgelser II* 96, 1-99.
- Andersson, G. 1896. *Svenska växtvärldens historia*. Norstedt. Stockholm. 136 pp.
- Bergman, J. 2005. *Tree-limit ecotonal response to Holocene climate change in the Scandes Mountains of west-central Sweden*. Doctoral thesis. Lundqua thesis 53. Lund university. 35 pp.
- Bergman, J., Hammarlund, D., Hannon, G., Barnekow, L. & Wohlfarth, B. 2005. Deglacial vegetation succession and Holocene tree-limit dynamics in the Scandes Mountains, west-central Sweden: stratigraphic data compared to megafossil evidence. *Review of Palaeobotany and Palynology* 134, 129-151.
- Birks, H.H. 2003. The importance of plant macrofossils in the reconstruction of Lateglacial vegetation and climate: examples from Scotland, western Norway, and Minnesota, USA. *Quaternary Science Reviews* 22, 453-473.
- Birks, H.H. & Birks, H.J.B. 2000. Future uses of pollen analysis must include plant macrofossils. *Journal of Biogeography* 27, 31-35.
- Birks, H.H., Larsen, E. & Birks, H.J.B. 2005. Did tree-*Betula*, *Pinus* and *Picea* survive the last glaciation along the west coast of Norway? A review of the evidence, in light of Kullman (2002). *Journal of Biogeography* 32, 1461-1471.
- Birks, H.H., Larsen, E. & Birks, H.J.B. 2006. On the presence of late-glacial trees in western Norway and the Scandes: a further comment. *Journal of Biogeography* 33, 376-377.
- Birks, H.J.B. 2002. Knut Faegri (1909-2001) - Obituary. *Review of Palaeobotany and Palynology* 121, 157-161.
- Broström, A. 2002. *Estimating source area of pollen and pollen productivity in the cultural landscapes of southern Sweden: developing a palynological tool for quantifying past plant cover*. Doctoral thesis. Lundqua thesis 46. Lund university. 42 pp.
- Broström, A., Sugita, S. & Gaillard, M.J. 2004. Pollen productivity estimates for the reconstruction of past vegetation cover in the cultural landscape of southern Sweden. *Holocene* 14, 368-381.
- Broström, A., Sugita, S., Gaillard, M.J. & Pilesjö, P. 2005. Estimating the spatial scale of pollen dispersal in the cultural landscape of southern Sweden. *Holocene* 15, 252-262.
- Brubaker, L.B., Anderson, P.M., Edwards, M.E. & Lozhkin, A.V. 2005. Beringia as a glacial refugium for boreal trees and shrubs: new perspectives from mapped pollen data. *Journal of Biogeography* 32, 833-848.
- Bunting, M.J., Gaillard, M.J., Sugita, S., Middleton, R. & Broström, A. 2004. Vegetation structure and pollen source area. *Holocene* 14, 651-660.
- Calcote, R. 1995. Pollen source area and pollen productivity - Evidence from forest hollows. *Journal of Ecology* 83, 591-602.
- Caseldine, C. & Fyfe, R. 2006. A modelling approach to locating and characterising elm decline/landnam landscapes. *Quaternary Science Reviews* 25, 632-644.
- Edwards, K.J., Whittington, G., Robinson, M. & Richter, D. 2005. Palaeoenvironments, the archaeological record and cereal pollen detection at Clickimin, Shetland, Scotland. *Journal of Archaeological Science* 32, 1741-1756.
- Eide, W., Birks, H.H., Bigelow, N.H., Peglar, S.M. & Birks, H. 2006. Holocene forest development along the Setesdal valley, southern Norway, reconstructed from macrofossil and pollen evidence. *Vegetation History and Archaeobotany* 15, 65-85.
- Fagerlind, F. 1952. The real significance of pollen diagrams. *Botaniska Notiser* 105, 185-224.
- Fyfe, R. 2006. GIS and the application of a model of pollen deposition and dispersal: a new approach to testing, landscape hypotheses using the POLLANDCAL models. *Journal of Archaeological Science* 33, 483-493.

- Fægri, K. 1950. Studies on the Pleistocene of Western Norway. IV. On the immigration of *Picea abies* (L.) Karst. *Universitetet i Bergen Årbok 1949:1*.
- Gaillard, M.-J., Birks, H.J.B., Emanuelsson, U., Karlsson, S., Lagerås, P. & Olausson, D. 1994. Application of modern pollen/land-use relationships to the interpretation of pollen diagrams - reconstructions of land-use history in south Sweden, 3000-0 BP. *Review of Palaeobotany and Palynology 82*, 47-73.
- Giesecke, T. 2004. *The Holocene spread of Spruce to Scandinavia*. Doctoral thesis. Uppsala University. 46 pp.
- Giesecke, T. 2005. Moving front or population expansion: How did *Picea abies* (L.) Karst. become frequent in central Sweden? *Quaternary Science Reviews 24*, 2495-2509.
- Giesecke, T. & Bennett, K.D. 2004. The Holocene spread of *Picea abies* (L.) Karst. in Fennoscandia and adjacent areas. *Journal of Biogeography 31*, 1523-1548.
- Gloersen, A.T. 1884. *Vestlands-Granen og dens Invandrings-Veie*. Forstforeningens Aarboeg for 1884, Kristiania. 95 pp.
- Hafsten, U. 1992. The immigration and spread of Norway spruce (*Picea abies* (L.) Karst.) in Norway. *Norsk Geografisk Tidsskrift 46*, 121-158.
- Hammarlund, D., Velle, G., Wolfe, B.B., Edwards, T.W.D., Barnekow, L., Bergman, J., Holmgren, S., Lamme, S., Snowball, I., Wohlfarth, B. & Possnert, G. 2004. Palaeolimnological and sedimentary responses to Holocene forest retreat in the Scandes Mountains, west-central Sweden. *Holocene 14*, 862-876.
- Hesselman, H. 1916. Yttrande med anledning av L. von Post's föredrag om skogsträdpollen i sydsvenska torfmosselagerföljder. *Geologiska Föreningens i Stockholm Förhandlingar 38*, 390-392.
- Hesselman, H. 1919. Iakttagelser öfver skogsträdpollens spridningsförmåga. 16. *Meddelanden från Statens Skogsförsöksanstalt 16*, 27-53.
- Hicks, S. 2006. When no pollen does not mean no trees. *Vegetation History and Archaeobotany 15*, 253-261.
- Hicks, S. 2001. The use of annual arboreal pollen deposition values for delimiting tree-lines in the landscape and exploring models of pollen dispersal. *Review of Palaeobotany and Palynology 117*, 1-29.
- Hicks, S. & Hyvärinen, H. 1999. Pollen influx values measured in different sedimentary environments and their palaeoecological implications. *Grana 38*, 228-242.
- Holmgren, S. 2000. *Holocene vegetation history and climate changes in the Sylarna area, southern Swedish Scandes: based on pollen analysis*. Master thesis. Göteborg University. 15 pp.
- Huntley, B. & Birks, H.J.B. 1983. *An atlas of past and present pollen maps for Europe: 0-13000 years ago*. Cambridge University Press. Cambridge. 667 pp.
- Jackson 1994. Pollen and spores in Quaternary lake sediments as sensors of vegetation composition: theoretical models and empirical evidence. In *Sedimentation of Organic Particles*. Edited by A. Traverse. Cambridge University Press. Cambridge. 253-286.
- Jacobson, G.L.J. 1988. Ancient permanent plots: sampling in paleovegetational studies. In *Vegetation History*. Edited by B. Huntley & T. Webb III. Kluwer Academic. Dordrecht. 80-96.
- Jacobson, G.L.J. & Bradshaw, R.H.W. 1981. The selection of sites for palaeovegetational studies. *Quaternary Research 16*, 80-96.
- Karlsson, H., Hörnberg, G., Hannon, G. and Nordström E.-M. In press: Long-term vegetation changes in the northern Scandinavian forest limit: a human impact – climate synergy? *The Holocene 17 (1)*.
- Kullman, L. 1995a. New and firm evidence for midholocene appearance of *Picea-Abies* in the Scandes Mountains, Sweden. *Journal of Ecology 83*, 439-447.
- Kullman, L. 1995b. Holocene tree-limit and climate history from the Scandes- Mountains, Sweden. *Ecology 76*, 2490-2502.
- Kullman, L. 1996. Norway spruce present in the Scandes Mountains, Sweden at 8000 BP: New light on Holocene tree spread. *Global Ecology and Biogeography Letters 5*, 94-101.
- Kullman, L. 1998a. Tree-limits and montane forests in the Swedish Scandes: sensitive biomonitors of climate change and variability. *Ambio 27*, 312-321.

- Kullman, L. 1998b. Non-analogous tree flora in the Scandes Mountains, Sweden, during the early Holocene - macrofossil evidence of rapid geographic spread and response to palaeoclimate. *Boreas* 27, 153-161.
- Kullman, L. 1998c. The occurrence of thermophilous trees in the Scandes Mountains during the early Holocene: evidence for a diverse tree flora from macroscopic remains. *Journal of Ecology* 86, 421-428.
- Kullman, L. 2000. The geocological history of *Picea abies* in northern Sweden and adjacent parts of Norway. A contrarian hypothesis of postglacial tree immigration patterns. *Geoöko XXI*, 141-172.
- Kullman, L. 2002. Boreal tree taxa in the central Scandes during the Late-Glacial: implications for Late-Quaternary forest history. *Journal of Biogeography* 29, 1117-1124.
- Kullman, L. 2004. Early Holocene appearance of Mountain Birch (*Betula pubescens* ssp *tortuosa*) at unprecedented high elevations in the Swedish Scandes: Megafossil evidence exposed by recent snow and ice recession. *Arctic Antarctic and Alpine Research* 36, 172-180.
- Kullman, L. & Kjällgren, L. 2000. A coherent postglacial tree-limit chronology (*Pinus sylvestris* L.) for the Swedish scandes: Aspects of paleoclimate and "recent warming" based on megafossil evidence. *Arctic Antarctic and Alpine Research* 32, 419-428.
- Latałowa, M. & van der Knaap W.O. in press. Late Quaternary expansion of Norway spruce *Picea abies* (L.) Karst. in Europe according to pollen data. *Quaternary Science Reviews*.
- Libby, W.F. 1952. *Radiocarbon Dating*. University of Chicago Press. 175 pp.
- Lowe, J.J. & Walker, M.J.C. 1997. *Reconstructing Quaternary environments*. 2nd edition. Longman. Harlow. 446 pp.
- Lundqvist, J. 1969. *Beskrivning till jordartskarta över Jämtlands län*. Sveriges Geologiska Undersökning Serie Ca 45. 418 pp.
- Moe, D. 1970. The post-glacial immigration of *Picea abies* into Fennoscandia. *Botaniska Notiser* 123, 61-66.
- Nielsen, A.B. & Sugita, S. 2005. Estimating relevant source area of pollen for small Danish lakes around AD 1800. *Holocene* 15, 1006-1020.
- Pardoe, H.S. 2003. The representation of taxa in surface pollen spectra on alpine and sub-alpine glacier forelands in southern Norway. *Review of Palaeobotany and Palynology* 117, 63-78.
- Parsons, R.W. & Prentice, I.C. 1981. Statistical approaches to R-values and pollen-vegetation relationship. *Review of Palaeobotany and Palynology* 32, 127-152.
- Paus, A., Velle, G., Larsen, J., Nesje, A. & Lie. Ø. 2006. Lateglacial nunataks in central Scandinavia: Biostratigraphical evidence for ice thickness from Lake Flåfåtjønn, Tynset, Norway. *Quaternary Science Reviews* 25, 1228-1246.
- von Post, L. 1918. Skogsträdpollen i sydsvenska torvmosselagerföljder. *Det 16 Skandinaviske naturforskermøte 1916*, 432-468. (Forest tree pollen in south Swedish peat bog deposits, translation by Davis M.B. & Fægri, K. (1967) *Pollen et spores* 9, 375-401.)
- Prentice, I.C. 1985. Pollen representation, source area, and basin size: toward a unified theory of pollen analysis. *Quaternary Research* 23, 76-86.
- Prentice, I.C., Berglund, B.E. & Olsson, T. 1987. Quantitative forest-composition sensing characteristics of pollen samples from Swedish lakes. *Boreas* 16, 43-54.
- Prentice, I.C. & Parsons, R.W. 1983. Maximum likelihood linear calibration of pollen spectra in terms of forest composition. *Biometrics* 39, 1051-1057.
- Prentice, I.C. & Webb, T. III. 1986. Pollen percentages tree abundances and the Fagerlind effect. *Journal of Quaternary Science* 1, 35-43.
- Raab, B. & Vedin, H. 1995. Climate lakes and rivers. Sveriges Nationalatlas. Bra Böcker Höganäs, 176 pp.
- Räsänen, S., Hicks, S. & Odgaard, B.V. 2004. Pollen deposition in mosses and in a modified 'Tauber trap' from Hailuoto, Finland: what exactly do the mosses record? *Review of Palaeobotany and Palynology* 129, 103-116.
- Sandvik, P.U. 1986. *Paleoökologisk undersökning i Nord-Trøndelag: med hovudvekt på innvandringa og etableringa av granskogen*. Master thesis. Universtietet i Trondheim. 91 pp.

- Selvik, S.F. 1985. *Paleoøkologiske undersøkelser i Nord-Trøndelag: med hovedvekt på granskogens innvandring og etablering*. Master thesis. Universtietet i Trondheim. 140 pp.
- Seppä H. & S. Hicks. 2006. Integration of modern and past pollen accumulation rate (PAR) records across the arctic tree-line: a method for more precise vegetation reconstructions. *Quaternary Science Reviews* 25, 1501-1516.
- Sernander, R. 1892. *Die Einwanderung der Fichte in Skandinavien*. Englers Botanisches Jahrbuch 15. Leipzig. 94 pp.
- Sugita, S. 1993. A model of pollen source area for an entire lake surface. *Quaternary Research* 39, 239-244.
- Sugita, S. 1994. Pollen representation of vegetation in quaternary sediments - theory and method in patchy vegetation. *Journal of Ecology* 82, 881-897.
- Sugita, S., Gaillard, M.J. & Broström, A. 1999. Landscape openness and pollen records: a simulation approach. *Holocene* 9, 409-421.
- Sugita, S. in press a. Theory of quantitative reconstruction of vegetation. I. Pollen from large sites REVEALS regional vegetation composition. *The Holocene*.
- Sugita, S. in press b. Theory of quantitative reconstruction of vegetation. II. All you need is LOVE. *The Holocene*.
- Telford, R.J., Heegaard, E. & Birks, H.J.B. 2004. All age-depth models are wrong; but how badly? *Quaternary Science Reviews* 23, 1-5.
- Tallantire, P.A. 1977. A further contribution to the problem of the spread of spruce (*Picea abies* (L.) Karst.) in Fennoscandia. *Journal of Biogeography* 4, 219-227.
- Trillerud, P.O. 1983. *Paleo-økologiske undersøkelser i Sør-Trøndelag. Granskogens innvandring og etablering*. Master thesis. Universtietet i Trondheim. 104 pp.

Acknowledgements

There are many people that have been involved in my doctoral work during the years. Contributions from two people have been vital for me to finally complete my thesis. First, I wish to thank my supervisor Ulf Segerström that has been there to support me during these years both in success and times of despair, and who has with an untiring energy read and commented on my texts, time after time. You have been the best supervisor I could have had. Secondly, I wish to thank my British colleague Ralph Fyfe for being so efficient, for being quick in both mind and response, and for your ability to help me focus on the key parts. It has been a pleasure to collaborate with you, both professionally and private. The thesis has also been improved by comments from: Greger Hörnberg, Erik Hellberg, and Hanna Karlsson, and the evaluation committee: Bent Odgaard, Matts Lindbladh, Tom Korsman.

All of you POLLANDCAL friends and colleagues, thank you for inspiring discussions in lecture halls and pubs all over Europe. Our meetings have been an inspiration for me and my research. Thank you Shinya for sharing your ideas and Marie-José for your great ability to coordinate the network, and for creating such a nice atmosphere.

I want to thank Team PPE (Anna Allard, Anna Berg, Anna Broström, Anne Birgitte, Hanna, Heather, Mari, Martin, Martina, Ralph and Ulf) for a wonderful week in the Swedish fells. This was scientific work at its best: interesting discussions, efficient work, wonderful landscape, good food and great friends. My spruce brother Thomas, thank you for all inspiring chats about spruce migration, and for valuable comments on the thesis.

Tack till alla kollegor på institutionen för skoglig vegetationsekologi som jag dagligen träffat genom åren här på SLU. Några personer förtjänar ett speciellt omnämnande: Greger, min biträdande handledare, tack för intressanta diskussioner och engagemang; Tina, vår sekreterare som gör livet som forskare lite enklare; Hanna, min pollenkumpan, för diskussioner på lab om stort och smått; Johnny, min vapenbroder i undervisningen; Erik, för undervisningssamarbete och för allt annat kul vi har gjort tillsammans; Linda, för samtal om livet som doktorand och människa. Listan skulle kunna göras mycket längre. Tack alla medarbetare på institutionen, ny som gammal, för många trevliga stunder och bra samarbete.

Tack till mamma och pappa för att ni har förmedlat kärleken till skog och natur i allmänhet och fjällen i synnerhet som, som till syvende och sist ligger till grund för detta arbete.

Och så mina livskamrater Monica, Alfred och Fritjof. För att ni hela tiden finns där och fyller livet med viktigare saker än arbete. Och för att ni är underbara personer som hela tiden ger mig nya kunskaper om livet och mig själv. Tack för att ni finns.