



universität  
wien

# DISSERTATION

Titel der Dissertation

Thermoregulation of African (*Loxodonta africana*) and  
Asian (*Elephas maximus*) Elephants:  
Heterothermy as an Adaptation of Living in Hot Climates

angestrebter akademischer Grad

Doktorin der Naturwissenschaften (Dr. rer. nat.)

Verfasserin: Nicole Weissenböck  
Matrikel-Nummer: 9645059  
Dissertationsgebiet: A 091 439 Zoologie  
(lt. Studienblatt):  
Betreuer: Univ.-Prof. Dr. Walter Arnold

Wien, im Juni 2010

## DEKLARATION

Ich erkläre an Eides statt, dass ich die vorliegende Arbeit selbstständig verfasst habe, andere als die angegebenen Quellen nicht benützt und die den benutzten Quellen wörtlich oder inhaltlich entnommen Stellen als solche kenntlich gemacht habe. Diese Arbeit wurde bisher in gleicher oder ähnlicher Form keiner anderen Prüfungskommission vorgelegt.

Wien, .....

.....

(Nicole Weissenböck)

Das angewandte methodische Verfahren der vorliegenden Arbeit wurde von der Ethikkommission der Veterinärmedizinischen Universität Wien und der Ethikkommission der Mahidol Universität Thailand genehmigt.

# CONTENTS

<b>TITLE PAGE</b> .....	1
<b>DECLARATION</b> .....	2
<b>CHAPTER I – General Introduction</b> .....	4
1.1. Elephants: Taxonomic Notes, Status and Habitat.....	5
1.2. The implications of large body size for heat exchange.....	5
1.3. The concept of heterothermy.....	8
1.4. Dissertation aims and arrangement of chapters.....	9
<b>CHAPTER II – Materials and methods</b> .....	11
Copy of the paper entitled “Reusable biotelemetric capsules: a convenient and reliable method for measuring core body temperature in large mammals during gut passage” published in the <i>Journal of Thermal Biology</i>	
<b>CHAPTER III – Heterothermy in Asian elephants</b> .....	19
Copy of the paper entitled “Heterothermy in Asian elephants: an adaptation to hot and humid climates” submitted to the <i>Journal of Experimental Biology</i>	
<b>CHAPTER IV – Thermal windows on the body surface of African elephants</b> .....	33
Copy of the paper entitled “Thermal windows on the body surface of African elephants ( <i>Loxodonta africana</i> ) studied by infrared thermography” published in the <i>Journal of Thermal Biology</i>	
<b>CHAPTER V – Estrous synchrony in a group of African elephants</b> .....	41
Copy of the paper entitled “Estrous synchrony in a group of African elephants ( <i>Loxodonta africana</i> ) under human care” published in <i>Animal Reproduction Science</i>	
<b>CHAPTER VI – General discussion</b> .....	48
<b>ACKNOWLEDGMENT</b> .....	52
<b>REFERENCES</b> .....	53
<b>ZUSAMMENFASSUNG</b> .....	60
<b>ABSTRACT</b> .....	62
<b>CURRICULUM VITAE</b> .....	63
<b>ADDENDUM – media response</b> .....	67

## - CHAPTER I -

*Elephants have long been an endless source of fascination, ever since Stone Age man first depicted mammoths in his cave wall graffiti. More than a century ago physiologists started asking whether elephants, owing to their huge body size, show any striking differences in metabolism from other animals, particularly with respect to heat insulation and heat regulation (Spinage, 1994). What are the specific modifications implied by a body mass of, on average, three tons? How closely do the existing species approach the limits of size fixed by mechanical laws and by physiological properties of animal tissues? Until now these are still pending questions.*



## 1.1. Elephants: Taxonomic Notes, Status and Habitat

Only two extant species of the family Elephantidae exist: the Asian *Elephas maximus* (Linnaeus, 1758) and the African elephant *Loxodonta africana* (Blumenbach, 1797). Preliminary genetic evidence suggests that there may be at least two species of African elephants, namely the Savanna Elephant and the Forest Elephant (Roca et al., 2001). However, the African Elephant Specialist Group believes that more extensive research is required to support the proposed re-classification. While the African elephant is qualified as threatened in the near future, it is the Asian Elephant that is one of the most endangered species of large mammals in the world today (IUCN, Red List of threatened species, 2009).

Asian elephants occur in isolated populations in thirteen Asian countries (Sukumar, 2003), where they inhabit a wide range of rainfall conditions, from less than 400 mm per year in the centre of the Indian peninsula to over 8,000 mm in the Western Ghats. However, the preferred habitat of all elephants is moist and dry deciduous woodland, although they also inhabit dry thorn forest, swamps and open grasslands (Spinage, 1994). Asian elephants can even be found in the relatively cold climate of the sub-Himalayan region and there are authentic records of elephants travelling up to the snowline on the mountains (Choudhury, 1999). African elephants are present in about a third of Africa (Blanc et al., 2007). They occupy habitats ranging from the equatorial rainforest of the Congo Basin and West Africa coastal region, through savannah woodlands to semi-desert conditions in Namibia and Mali. Air temperature can in their typical habitat reach up to 50°C during the day, but can also drop below freezing during the night in West Africa (Spinage, 1994).

## 1.2. The implication of large body size for heat exchange

When Hannibal made his epic journey from Carthage to Italy in the third century B.C., his elephants had to overcome snow and intense cold while crossing the Pyrenees and Alps (Hiley, 1975). Although elephants are generally associated with tropical, hot climates, they are also often found in cold environments, i.e. in the mountains (see 1.1.), despite the fact that they do not possess a thick fur like their extinct relative, the woolly mammoth. How do elephants meet the thermoregulatory challenges of these different environments?

Elephants, like all mammals and birds, are endotherms. These animals regulate body temperature typically within narrow limits (in eutherian mammals at  $38 \pm 2^\circ\text{C}$ , Schmidt-Nielsen, 1997) by internally generated metabolic heat. The rest of the animal kingdom are ectotherms, i.e. body temperature is principally dependent on external heat sources (Willmer et al., 2005). In a strict sense, regulation of body temperature in mammals and birds refers to the regulation of core temperature, in other words, the temperature of the inner body, where vital organs, such as the brain, liver and heart, are located (Watson and Fawcett, 2003). Depending on the method of measurement, body temperature in elephants of both species is

between 35.0 and 37.5°C (Benedict, 1936; Buss and Waller, 1965; Elder and Rogers, 1975; Toscano et al., 2001; Kinahan et al., 2007a; Hidden, 2009). Continuous measurements have shown that African elephants have a high rhythmicity in their body temperature's daily rhythms, with minimum body temperature values in the early morning hours (Hidden, 2009: between 7:00 and 9:30) and maximum values in the late afternoon (Hidden, 2009: 18:00) or late in the evening (Kinahan et al., 2007a: 22:00).

The thermoregulatory implications of body size are considerable for large animals like elephants. Because of their small surface to volume ratio, elephants cannot lose heat quickly. This relation can be problematic if exposed to heat, but advantageous in the cold. Extant elephants typically dwell in hot climates thus facing the problem of getting rid of excess heat.

In hot habitats, where the largest extant terrestrial species, e.g., elephants, rhinoceroses, hippopotami and giraffes, are currently found, animals may be confronted with their physiological limits of thermoregulation, as the temperature gradient between the animal and its environment diminishes and radiation, convection, and conduction become less effective in keeping an animal cool (Taylor and Lyman, 1967). Thus, an animal can only dissipate heat by evaporating water (Taylor, 1969; Gernot, 1992) (Information about the four modes of heat transfer can be found from table 1).

**Table 1:** Factors that influence the four modes of heat transfer between an animal and its environment.

<b>Mode of transfer</b>	<b>Animal characteristics</b>	<b>Environmental characteristics</b>
Radiant	Mean radiant temperature of surface; effective radiating area; reflecting area; reflectivity and emissivity.	Mean radiant temperature; solar radiation and reflectivity of surroundings.
Convective	Surface temperature; effective convective area; radius of curvature and surface type. Influencing structures like fur or feathers.	Air temperature; wind speed and direction.
Conductive	Surface temperature; effective contact area.	Temperature, thermal conductivity and thermal capacity of the contact material.
Evaporative	Surface temperature; percentage wetted area; site of evaporation relative to skin surface.	Humidity; wind speed and direction.

Adapted from Ingram and Mount (1975).

Evaporation occurs when specialized sweat glands excrete water, or by panting. The relative importance of these two avenues, however, varies with the prevailing climatic conditions, i.e.

the vapour gradient between the evaporating surface and the ambient, the level of moisture in the air and air velocity (Gebremedhin and Wu, 2002), and is considerably different between species (Gernot, 1992). The net effectiveness of panting apparently declines as body size increases, so panting may be relatively ineffective in large animals (Bligh, 1973; Parker and Robbins, 1985).

The occurrence of sweat glands is highly variable. In some species they are widely distributed, in others they are topographically restricted, and still others are reported to have no sweat glands (McNab, 2002). Elephants are one of those species that lack sweat glands (Hiley, 1975; Wright and Luck, 1984; Mariappa, 1986). Interestingly, elephants do not pant either (Hiley, 1975; Robertshaw, 2006). They accomplish evaporative heat loss mainly by diffusion of water through their skin, as well as by respiration (Benedict, 1936). In the latter case the elephant's trunk may play an important role. With a length of up to 2 meters (Skinner and Chimimba, 2005), the trunk of the elephant is well suited for evaporative heat loss by condensation of water on the inside of the trunk.

To summarize, the unfavourable surface-to-volume ratio of elephants severely constrains heat loss at high ambient temperatures and evaporative heat loss is also limited (Wright and Luck, 1984). Moreover, this evaporative cooling is even less effective in the natural habitat of Asian elephants, with its typically high moisture content of air. Finally, the nearly hairless condition of elephants leaves the animals unprotected against radiation and causes problems with dehydration of the integument (Lillywhite and Stein, 1987).

On the other hand the lack of a fur promotes heat loss, because it allows quick transfer of excess heat from the body. In fact, the decrease in thickness of the fur, as body size increases, can be observed in many mammals from hot habitats (Louw and Seely, 1982); with a complete lack of a fur in rhinoceroses, hippopotami and also in elephants. As a consequence, thermal conductance in Asian and African elephants is about 3 to 4.8 times higher than predicted from allometric relationships (Williams, 1990). Thermal conductance is the reciprocal of insulation (Scholander 1950 a, b, c) and increases when the fur is shorter and less dense.

Other adaptations facilitating heat loss pertain to the special anatomy of the dermis and epidermis of elephant skin, which allows for significant water loss by evaporative cooling. The sculptured skin surface adsorbs water and facilitates the movement of water over the surface (Lillywhite and Stein, 1987). Elephants are often observed to lie and roll over in muddy pools (Owen-Smith, 1988). Furthermore, African elephants choose their habitat based on thermal characteristics and thermoregulatory requirements (Kinahan et al., 2007b). The maintenance of thermal balance may be partly responsible for the phasing of daily activity into foraging spells, separated by periods of rest or inactivity. Elephants of both species devote about three-quarters of their time foraging, and spend relatively less time inactive (Owen-Smith, 1988). They are known to have diurnal activity patterns with peak feeding times in the early

hours of daylight and the afternoon (Wyatt and Eltringham, 1974; Guy, 1976; Katugaha et al., 1999).

However, the undoubtedly most impressive thermoregulatory organs facilitating heat loss are the elephant's large ears, especially those of African elephants. The pinna's heat dissipation function is obvious, when comparing its size to the size of a woolly mammoth's ear. The length of the pinna (from the upper margin of the ear to the ear lobe) of an African elephant is about 183 cm (Sikes, 1971), whereas the ear of a mammoth mummy, found on a small tributary of the Khatanga river, measured only 33 cm (Vereshchagin and Baryshnikov, 1982). The small size of woolly mammoth ears was an evolved feature to prevent heat loss in temperate latitudes (Haynes, 1991). In the African elephant the combined surface area of both sides of the ears amounts to about one fifth of the animal's total body surface (Spinage, 1994).

In conjunction with their great importance in thermoregulation, the ears are frequently termed "thermal windows" (Wright, 1984; Williams, 1990). Thermal windows are body areas responsible for heat exchange by regulating skin temperature. Animals can actively influence heat loss by canalizing and controlling blood flow into thermal windows (Šumbera et al., 2007).

Depending on the surrounding climatic conditions, the amount of heat lost via the pinna is variable. Phillips and Heath (1992) calculated that at an air temperature of 20°C and wind speed of 5 m\*s<sup>-1</sup> a 2000 kg African elephant can lose 1,500 W or 91.3% of metabolic heat production from both sides of its two ears.

Altogether, the mechanisms available to elephants for dissipating heat seem to be effective. However, it is unknown whether they are sufficiently effective for withstanding the enormous amount of heat load experienced in most parts of their natural range.

### **1.3. The concept of heterothermy**

The great compensation provided by large size is that of high thermal inertia, opening up the opportunity of substantial heat storage and the strategy of adaptive heterothermy. Here the body temperature is allowed to fluctuate rather widely on a daily basis, with heat storage during the day and a peak in body temperature before sunset. During the subsequent night, body temperature is allowed to fall allowing the animals to enter the day with a thermal reserve (Louw and Seely, 1982; Willmer et al., 2005). Therefore, animals are able to reduce the energetic cost of thermoregulation under a severe heat load without elevating mean daily body temperature (Louw and Seely, 1982). This so-called "adaptive heterothermy" is an important mechanism in desert mammals.

Because a decreasing body size to surface ratio renders dissipation of excess heat more difficult, one can expect "heterothermy" to be an important physiological mechanism for larger mammals.



The concept of heterothermy was first demonstrated by Schmidt-Nielsen and colleagues (1956). They found daily variations in body temperature of the camel to be much higher under water restriction. Camels apparently have the ability to reduce evaporative water loss by accumulating heat in the body and temporarily tolerating a body temperature of up to 41°C. The stored excessive heat is dissipated again during the cold night. As a consequence, the daily fluctuation of core body temperature increases in the camel from about 2°C to 6°C under water restriction (Schmidt-Nielsen et al., 1956). Subsequent studies found similar heterothermy in other large desert animals, e.g. in Cape eland *Taurotragus oryx* (Taylor, 1969); and Arabian oryx *Oryx leucoryx* (Taylor, 1969; Taylor, 1970). However, the concept of heterothermy remained a matter of debate and was viewed as an artefact of captive conditions (Mitchell et al., 2002). Only recently the theory was corroborated by Ostrowski and colleagues, with data from free-living Arabian oryx (Ostrowski et al., 2003) and Arabian sand gazelles *Gazella subgutturosa marica* (Ostrowski and Williams, 2006).

#### **1.4. Dissertation aims and arrangement of chapters**

Based on the implication of large body size and their distribution in hot habitats, adaptive heterothermy has been suggested several times as a frequently used thermoregulatory strategy of elephants to reduce water and energy loss (Elder and Rogers, 1975; Hiley, 1975; Langman pers. comm. in: Phillips and Heath, 1992). However, it was not known whether adaptive heterothermy as a reaction to thermoregulatory challenges exists in non-desert mammals that are exposed neither to high levels of solar radiation nor to ambient temperatures that regularly exceed core body temperature. I therefore studied thermoregulation of Asian elephants living in Thailand under climatic conditions typical for their natural habitat and investigated the following questions:

- A) Do equivalent adaptations to heterothermy, known to be used in some arid mammals, exist in non-desert animals when large body size constrains heat dissipation?
- B) How do possible adaptations appear?
- C) What solutions are found to maintain thermal balance?
- D) What impact does ambient temperature have on body temperature in large tropical mammals?
- E) Do thermophysiological limits, primarily predicted by body size, exist?

Due to the lack of a suitable method to obtain body temperature in elephants over longer periods of time, I firstly had to develop a new sampling method. I did this in close collaboration with the Department of Biomedical Engineering and Biotelemetry of the Research Institute of Wildlife Ecology Vienna. Reliability and suitability of the method was corroborated with studies of zoo elephants at *Tiergarten Schönbrunn Wien* and *Tierpark Hellabrunn München*.

The development, usage and effectiveness of the applied method are discussed in Chapter II. Chapter II further reviews the influence of sexual hormones on longitudinal changes in core body temperature in African elephants.

The examinations necessary to answer the main questions of my thesis and which represent the core of my thesis are described in Chapter III.

Another aspect of elephant thermoregulation is the sensitive control of skin temperature and the importance of the pinna's heat loss function. In Chapter IV I discuss the occurrence of thermal windows, highly vascularised skin areas, on the body surface of African elephants, including ears, and their possible relevance in thermoregulation.

To clearly understand the influence of progesterone on longitudinal changes in core body temperature, basic information on hormone cycles of elephants can be inferred from Chapter V, which describes the phenomenon of estrous synchrony in African elephants.

At the end of the thesis the main results are reviewed in Chapter VI, the general discussion.

## - CHAPTER II -

### **Materials & methods**

*Copy of the paper entitled "Reusable biotelemetric capsules: a convenient and reliable method for measuring core body temperature in large mammals during gut passage" published in the Journal of Thermal Biology*





## Reusable biotelemetric capsules: A convenient and reliable method for measuring core body temperature in large mammals during gut passage

Nicole M. Weissenböck<sup>a,\*</sup>, Franz Schober<sup>a</sup>, Gerhard Fluch<sup>a</sup>, Christoph Weiss<sup>b</sup>, Thomas Paumann<sup>a</sup>, Christian Schwarz<sup>a</sup>, Walter Arnold<sup>a</sup>

<sup>a</sup> Research Institute of Wildlife Ecology, University of Veterinary Medicine Vienna, Savoyenstraße 1, 1160 Vienna, Austria

<sup>b</sup> Department of Systematic Anatomy, Medical University of Vienna, 1090 Vienna, Austria

### ARTICLE INFO

#### Article history:

Received 18 November 2009

Accepted 29 January 2010

#### Keywords:

Core body temperature  
Temperature data loggers  
Ingestible telemeters  
Telemetry  
Megaherbivores  
Elephants

### ABSTRACT

It is still not fully understood how megaherbivores regulate their body temperature ( $T_b$ ), particularly with respect to their unfavourable surface to volume ratio. The paucity of information is probably owing to the difficulty obtaining physiological parameters from such animals. We developed a precise and reliable non-invasive method for determining the  $T_b$  of large-bodied mammals. We used this method on African and Asian elephants. Small capsules (30 g) containing a temperature-sensitive transmitter and a memory for onboard data storage were hand-fed 71 times to elephants ( $N=21$ ) and  $T_b$  was measured during gut passage. In 64 cases, sensors were successfully retrieved. The operation and reliability of our data loggers was sufficient and compared favourably with any other published method.

© 2010 Elsevier Ltd. All rights reserved.

### 1. Introduction

The thermal relationships and control of body temperature ( $T_b$ ) are of particular importance for mammals and birds (McNab, 2002).  $T_b$  has become a generally accepted clinical index of physiological well-being. The development of fully implantable temperature sensors allows highly reliable and continuous measurement of  $T_b$  over long periods of time. Combined with radio telemetry this technique provides a powerful tool for investigating the physiology of animals (Cooke et al., 2004). However, surgical procedures on large-bodied mammals such as elephants are difficult and bear a potential risk for the animal's health. Researchers have shown that gastrointestinal temperatures recorded by ingested temperature sensors are reliable indicators of  $T_b$  (Prendiville et al., 2002; Green et al., 2005) and thereby revealed a potential alternative to implanted temperature loggers. Ingestible telemeters measure  $T_b$  during gastrointestinal passage and transmit the data to an external receiver. Such devices have been employed in a number of mammals including African elephants *Loxodonta africana* (McConnell, 1998), domestic pigs *Sus scrofa domestica* (Brown-Brandl et al., 2003) and horses *Equus ferus caballus* (Green et al., 2005). Unfortunately, the use of ingestible sensors is accompanied by a number of obstacles, mainly material defects, high costs, insufficient energy supply and

the interference of telemetric signals by other radio signals (Green et al., 2005). In contrast to telemeters, ingestible miniaturised data loggers are self-contained, such loggers are equipped with onboard data storage. Ingestible data loggers have previously been fed to tigers *Panthera tigris* (Neville and Friend, 2003), hippopotami *Hippopotamus amphibius* (Piccione et al., 2005), Asian elephants *Elephas maximus* (Toscano et al., 2001) and African elephants (Kinahan et al., 2007; Hidden, 2009). Since loggers store the data, no external equipment is required; however, this can also be a disadvantage because data can only be obtained once the logger has been retrieved. The application of miniaturised data loggers usually results in a disproportional high effort of time and labour to administer and resume the devices. Furthermore, data loggers have not yet been designed to be ingested. Damage of devices during swallowing and gut passage are pre-programmed, as shown in all studies using commercial i-Buttons (Maxim, Sunnyvale, California, USA) (Toscano et al., 2001; Neville and Friend, 2003; Kinahan et al., 2007; Hidden, 2009). Owing to these difficulties, little information is available on the course of the  $T_b$  of the extant families of megaherbivores including Elephantidae, Rhinocerotidae, Hippopotamidae and Giraffidae. Therefore, we aimed to develop a precise and reliable non-invasive method for determining  $T_b$ , which allowed data retrieval and at the same time reduced associated labour and time. We tried our method on African and Asian elephants, as stated in detail below. Furthermore, we discuss the potential applications of our method on other megaherbivores.

\* Corresponding author. Fax: +43 1 4890915 333.

E-mail address: [nicole.weissenboeck@fwi.at](mailto:nicole.weissenboeck@fwi.at) (N.M. Weissenböck).

## 2. Materials and methods

### 2.1. Study animals and husbandry conditions

Measurements were carried out on European and Thai Zoo elephants. Altogether we measured three different zoo groups. Between February 2007 and March 2009, the  $T_b$  of two African elephants at Vienna Zoo, Austria, six Asian elephants at Munich Zoo, Germany and 13 Asian elephants at the Samphran Elephant Ground and Zoo, Thailand were measured. The elephants were between five and 60 years of age. The animals were usually housed together day and night. During summer (June–September) the elephants at the European zoos had free access to both indoor and outdoor facilities, even at night. During the remaining seasons the European elephants were allowed to stay outdoors during the daytime only. Depending on the weather the time spent outdoors in winter varied between 4 and 8 h per day. The Asian elephants at the Samphran Elephant Ground and Zoo were kept outdoors all day. The animals were fed hay, branches and, depending on the season and location, different fruits and vegetables.

### 2.2. Design of the capsules

$T_b$  was obtained using a biotelemetry system developed at the Research Institute of Wildlife Ecology, which measured  $T_b$  through the intestinal passage. The system consisted of a temperature measurement unit, a data logger and a VHF radio transmitter. All components of the system were controlled by a microcontroller (Fig. 1). A microcontroller (Microchip Technology, Chandler, Arizona, USA) triggered a temperature measurement circuit every 60 s (Fig. 2). Temperatures were transformed by the microcontroller into a pulse interval varying from 1 to 2 s, corresponding to a temperature range 31–41 °C. A radio frequency signal (VHF) with a temperature-corresponding pulse interval and pulse duration of 10 ms was transmitted repeatedly over 60 s until the next temperature measurement.

Every 300 s the actual measured temperature was stored in a non-volatile memory with a storage capacity of 64 kB or 32,000 temperature readings. To reduce power consumption the temperature measurement circuit was switched on only during the real measurement process for about 20 ms. The transmission of very short radio frequency pulses in relation to the pulse intervals ensured a maximum of battery lifetime (average three months).

Energy was supplied by a Li/MnO<sub>2</sub> battery (CR 1632, capacity 125 mAh). All components were placed into a cylindrical stainless steel capsule, which was open on both face surfaces and moulded

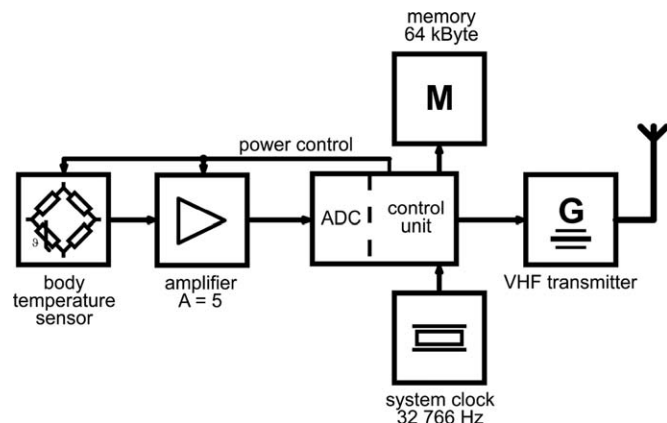

Fig. 1. Block diagram of the temperature transmitter/logger.

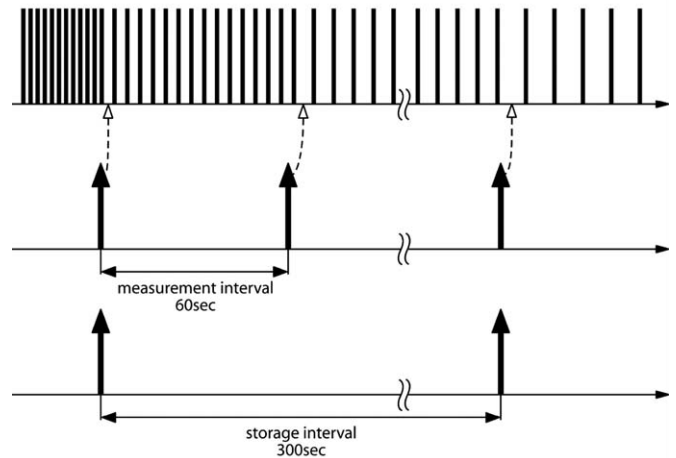

Fig. 2. Timing diagram of the temperature transmitter/logger.

into epoxy resin. The radio antenna was placed at one opening, allowing radio transmission out of the capsule. On the other face of the surface a three-pole connector for data readout from the logger was embedded into the epoxy. Three holes were drilled through the epoxy to the contacts of the connector and filled with an elastic silicone resin to enable penetration with the contacts of a three-pin plug of a readout interface module.

The capsules had a length of 30 mm (20 mm stainless steel and 10 mm epoxy resin to cover the antenna), a diameter of 22 mm and a weight of approximately 30 g.

All capsules were calibrated against a certified precision thermometer (Testo 950, Testo AG, Lenzkirch, Germany) in a temperature-controlled water bath between 31 and 41 °C at 2 °C intervals. A third-order polynomial function was fitted to these data for obtaining a calibration function. The resolution of temperature measurements with the capsules was 0.01 °C, with an accuracy of 0.1 °C.

### 2.3. Feeding, recovery of capsules and data readout

Our first attempt at feeding capsules by putting them into an apple or banana failed because the elephants typically chewed these food items and destroyed the capsules despite the protection provided by the stainless steel shell. Throwing the capsules as far as possible into the widely opened mouth together with small treats (pellets, small pieces of carrots, dates), i.e. not eliciting chewing, turned out as the most effective method to ensure that an elephant swallowed an intact capsule.

The situation was different in Thailand. The Samphran elephant group was used to receiving treats placed on their trunks and the animals did not open their mouths sufficiently wide. We again prepared bananas with capsules. The fruit was placed by hand onto the back of the tongue followed by plenty of bananas stuffed into the mouth. This elicited a swallowing reflex before the animal began to chew.

After defaecation, we searched for the capsules with a portable receiver and a H-type antenna. For data readout we used an intelligent interface module, that was also designed at the Research Institute of Wildlife Ecology. The interface module contained a microcontroller connected to the memory inside the capsule via the three-pole connector described above. The interface module provided consecutive readouts of the measured temperature data and delivered the data to a portable computer via a standard serial interface (RS232 or USB).

## 2.4. Telemetric recordings

In the African elephants, the capsules remained in the animals' gut for an unexpected long period of time (see Section 3). Therefore, in these animals we measured the temperature telemetrically, in addition to the onboard storage, which we continued at Munich Zoo.

We used omnidirectional antennas mounted permanently in both the outdoor and indoor enclosure connected via coaxial cable to a telemetry receiver to pick up the signals from the capsules in the animals' gut and measure the length of pulse intervals. Data were stored in an onsite PC, which also automatically adjusted the gain and fine tuning of the telemetry receiver using self-developed software.

Telemetrically obtained data needed filtering. Therefore, we used a running median filter (R Development Core Team, 2009, package gtools, object=running, function=median, width=30) to purge data from noise.

## 2.5. Statistics

Statistical tests were performed using the statistical package R (R Development Core Team, 2009). A linear mixed effect model (LME) (library nlme; Pinheiro et al., 2009) was used to test for the influence of method used to determine the elephants'  $T_b$  (onboard storage vs. telemetry), elephant's age, body weight, sex and zoo group on mean daily measurements. We entered "individual" as the random effect. The significance of the fixed factor in the LME was assessed using an  $F$  test. To determine the longitudinal variation in daily mean  $T_b$  rhythm we used a cosinor analysis. A cosine ( $\omega$ ) and sine ( $\omega$ ) term was entered into a nonlinear model, with  $\omega$  representing the consecutive days (time format) in radians. Sums of squares and the degrees of freedom of these terms were added to obtain a single  $F$ - and  $P$ -value for the periodic function. Coefficients of the cosine and sine term were then used to algebraically compute the period of the periodic function (library stats, R Development Core Team, 2009).

Data are reported as means  $\pm$  SEM, except where otherwise indicated.

## 2.6. Ethical approval

This study was approved by the Ethics Committee of the University of Veterinary Medicine of Vienna, Austria and by the Faculty of Veterinary Science—Animal Care and Use Committee of the Mahidol University, Thailand.

## 3. Results

### 3.1. Ingestion and transit times of capsules

Significant differences in gut transit periods of the telemetry sensors were found between the two species. In Asian elephants, telemetry sensors passed through the gut within 20 h to 10 days. The mean period that the capsules remained in the elephants' stomach was  $3.8 \pm 1.4$  h (ranging 1.3–6 h).

By contrast, telemetry sensors fed to the African elephants stayed in the gut for a long period of time. The capsule of one African elephant was never retrieved. For the other elephant, the capsule was recovered by chance in perfect condition in the dung after one-and-a-half years. Owing to adapted programming, it was possible to continuously gain data from this elephant over a period of five months until the energy supply of the sensor expired.

None of the elephants experienced side effects or showed any kind of distress or discomfort after ingesting the capsules (even after one-and-a-half years in the case of the African elephant above).

### 3.2. Retrieval and general operation of capsules

The operation of the capsules was excellent. The capsules withstood the deglutition and gastrointestinal passage without damage. The integrated transmitter unit enabled precise detection of the telemetry sensor's location. Depending on the location of the capsules the range of the signal was up to 60 m when the sensors had been excreted and 4–50 m when sensors stayed in the gastrointestinal tract. Detection of the excreted telemetry sensors was accurate and easy. By this method, telemetry sensors were even retrieved when hidden in the middle of large dung piles, in vegetation or at the bottom of elephant pools. Altogether, capsules were fed 71 times to 21 elephants and sensors were successfully retrieved in 64 cases (Table 1).

The recorded signal of the data loggers was of high quality and no failures in data storage occurred. The data, recorded via telemetric methods, were of sufficient quality, although the signal strength varied with the position of the elephant to the antennas and the signal quality was inconsistent throughout recordings.

After data filtering and fitting of a running median curve (Fig. 3), the differences between the mean daily  $T_b$  recorded by telemetric methods and the  $T_b$  logged onboard were negligible (LME:  $F_{1,213}=0.0$ ,  $P=0.99$ ) (Fig. 4).

### 3.3. Core body temperature of elephants

Mean  $T_b$  of all elephants measured  $36.3^\circ\text{C}$  ( $\pm 0.07$ ),  $N=21$ ,  $n=43,972$  (where  $N$  was the number of animals tested and  $n$  the number of data points). We found that mean daily  $T_b$  was influenced by the animal's body weight only (LME:  $F_{1,15}=16.76$ ,  $P=0.0013$ ). Other determined factors had no effect on  $T_b$  ( $P \geq 0.13$ ). The overall mean daily range of the  $T_b$  was  $0.83^\circ\text{C}$  ( $\pm 0.02$ ). A clear daily rhythmicity in  $T_b$  was present (Fig. 5). Long-time recordings of one African elephant revealed rhythmical variations in daily mean  $T_b$ . By fitting a cosine curve to the course of daily mean  $T_b$  a period of 102 days was determined ( $\sin(\omega)$ :  $F_{1,123}=133.28$ ,  $P < 0.0001$ ;  $\cos(\omega)$ :  $F_{1,123}=347.65$ ,  $P < 0.0001$ ). This period coincides with the peak to peak intervals in the progesterone release in the ovarian cycle of the elephant (Fig. 6).

## 4. Discussion

Metabolic heat production scales with body mass (McNab, 1983) and with respect to heat dissipation megaherbivores have the most unfavourable surface to volume ratio among all living terrestrial animals. Because of their large body size these animals experience a unique thermoregulatory challenge. However, it is still not fully understood how these large-bodied mammals regulate their  $T_b$ . This lack of information might be owing to on the difficulty obtaining physiological parameters from such animals. All studies so far dealing with  $T_b$  rhythms in megaherbivores (McConnell, 1998; Toscano et al., 2001; Kinahan et al., 2007; Hidden, 2009) have encountered difficulties in their methods. We presented here a reliable, non-invasive method for determining  $T_b$ , which is practicable in zoo and semi-wild large-bodied animals.

The functionality of our biotelemetric capsules compare favourably in reliability and functionality with any other published methods (Table 1). The capsules withstood the

**Table 1**  
Review of studies obtaining core body temperature in megaherbivores via ingestible temperature data loggers. Summary of the number of thermometric loggers fed to the animals and swallowed by and retrieved from the animals. The transit times of the retrieved data loggers are given as a range between minimal and maximal transit times, means ( $\pm$  SD) or medians ( $\pm$  SD).

References	Species	Number of study animals	Type of thermometric logger	Number of thermometric loggers				Transit time (h)
				Fed to animals	Successfully swallowed	Retrieved in functional condition	Retrieved in functional condition in total	
McConnell, 1998	LA	2	Minimitter	n.s.	n.s.	n.s.	n.s.	72–1104
Toscano et al., 2001	EM	Max 52	i-Button	119	n.s.	32–44	27–37%	24–2928
Piccione et al., 2005	HA	1	i-Button	n.s.	n.s.	1	n.s.	72
Kinahan et al., 2007	LA	4	i-Button	40	n.s.	6	15%	65.2 $\pm$ 36.5
Hidden, 2009	LA	4	i-Button					
			Logger Type A	2	2	0	42%	
			Logger Type B	12	7	3		500 $\pm$ 240 <sup>*</sup>
			Logger Type C	12	11	9		40 $\pm$ 36 <sup>*</sup>
Recent study	LA	2	Self-constructed	2	2	1	90%	12,144
	EM <sup>a</sup>	6		29	29	26		115 $\pm$ 78.7
	EM <sup>b</sup>	12		40	38	37		78 $\pm$ 46.3

EM...Asian elephants (*Elephas maximus*).LA...African elephants (*Loxodonta africana*).HA...Hippopotamus (*Hippopotamus amphibius*).n.s...not specified.

<sup>a</sup> Asian elephants at Munich Zoo (Europe).

<sup>b</sup> Asian elephants at the Samphran Elephant Ground and Zoo (Thailand).

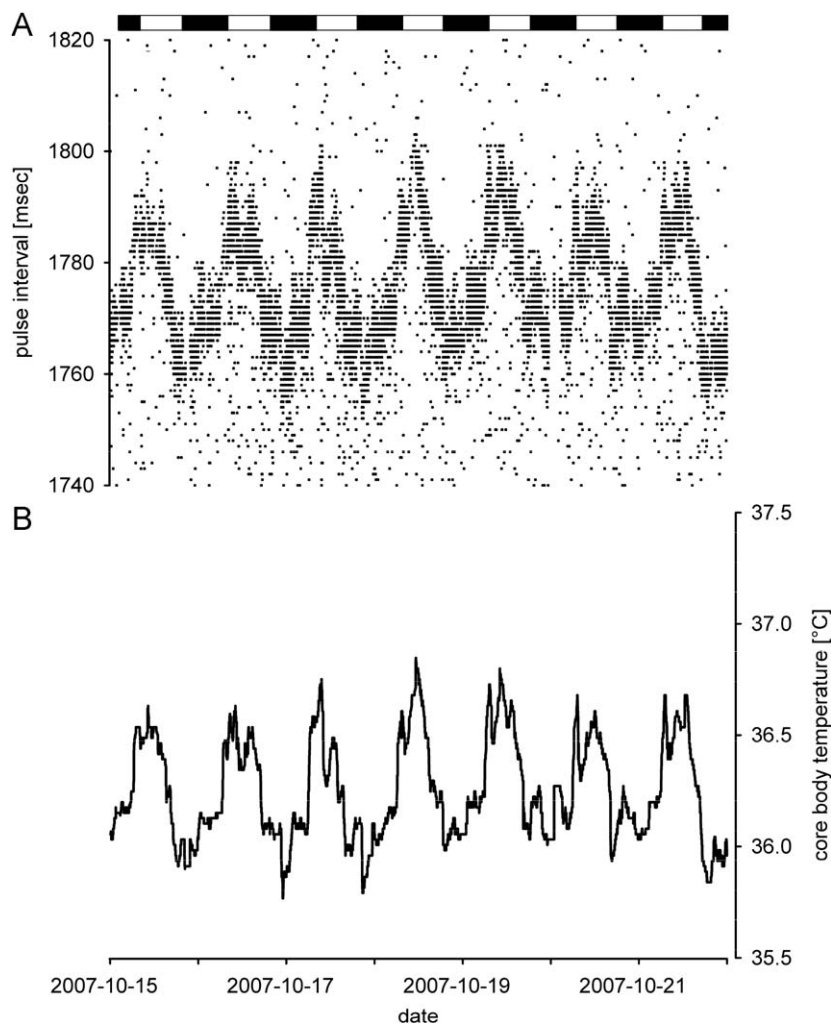

**Fig. 3.** Core body temperature of an adult African elephant over one week. The ingested biotelemetric capsule measured core body temperature during intestine passage and permanently transmitted the measured data as pulse interval-modulated temperature signals to an external stationary receiver. The signal was renewed once a minute. (A) The graph shows the unfiltered signal received via telemetric methods. (B) A running median curve representing the most probable course of core body temperature within the point cloud plotted above. The white and black bars at the top indicate the daily light–dark cycle. (11L:13D). Date is in UTC time format.

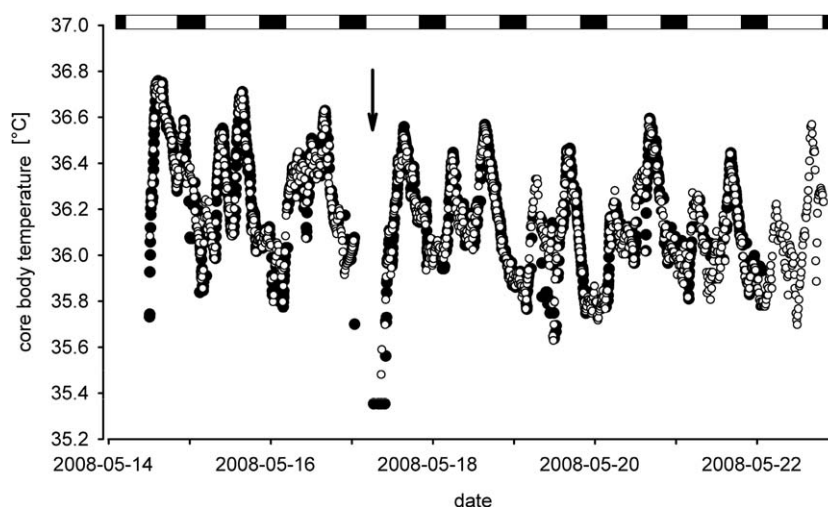

**Fig. 4.** Core body temperature of an adult Asian elephant bull at Munich Zoo over one week. Comparison of the external recorded pulse-spaced (filled symbols) and internal logged (open symbols) signals. The white and black bars at the top indicate the daily light–dark cycle. (15L:9D). The arrow indicates the time of re-feeding the telemetry sensor to the elephant. Date is in UTC time format.

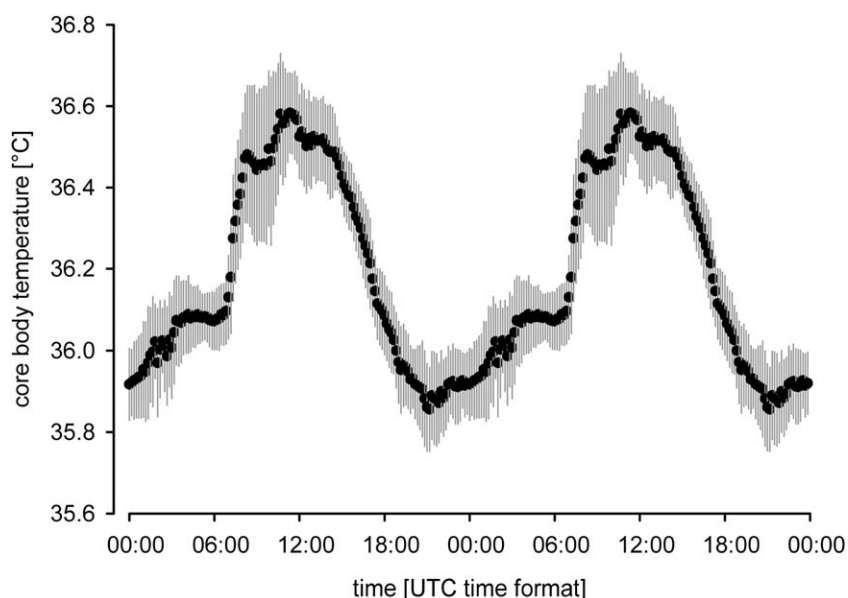

**Fig. 5.** Double plotted 24-h profile of core body temperature. Plotted circles are means of 14 days. SD reflecting variation between single days in one African elephant.

deglutition and gastrointestinal passage without damage, which seemed to be a constant problem in other studies (McConnell, 1998; Toscano et al., 2001; Kinahan et al., 2007; Hidden, 2009). Moreover, the integrated transmitter unit enabled the precise detection of the telemetry sensors. Most of the studies which did not equip their data loggers with a transmitter used other methods to mark the devices. Kinahan et al. (2007) as well as Hidden (2009) attached a strand of trailing material to improve the chance of retrieval from the dung. Nevertheless, every bolus had to be checked, which requires enormous expenditure of human labour and time. In a preliminary study, we used a metal detector (Fisher 1212-X, Fisher Research Laboratory, Los Banos, California, USA) to detect the steel capsules in the dung. This method was inadequate under zoo conditions because we were unable to distinguish whether the detector's signal was generated by the capsules or by other metal sources such as steel reinforcements. Tests also revealed that the penetration depth

of the detector was insufficient to scan dung piles en bloc. Furthermore, this method provided no exact information about the duration of the intestine passage. Next, we tried to mark the dung by simultaneous feeding of maize or food colouring (Kelly green, Wilton Inc., Woodridge, Illinois, USA) with the capsules. Even feeding large doses of food colouring (20 g) did not result in a dyeing of the dung. Generally, marking the dung by any means turned out to be impractical because the transition time of the capsules is not equal to that of normal food. Only equipping the capsules with a transmitter unit, as described above, strongly facilitated their retrieval.

A further well-proved detail was wrapping the single components into a stainless steel capsule. In just two cases an elephant bit the stainless steel capsule protecting the sensor from full damage.

When handled without sedation, the animal has to be accustomed to humans. Inserting the telemeters might require



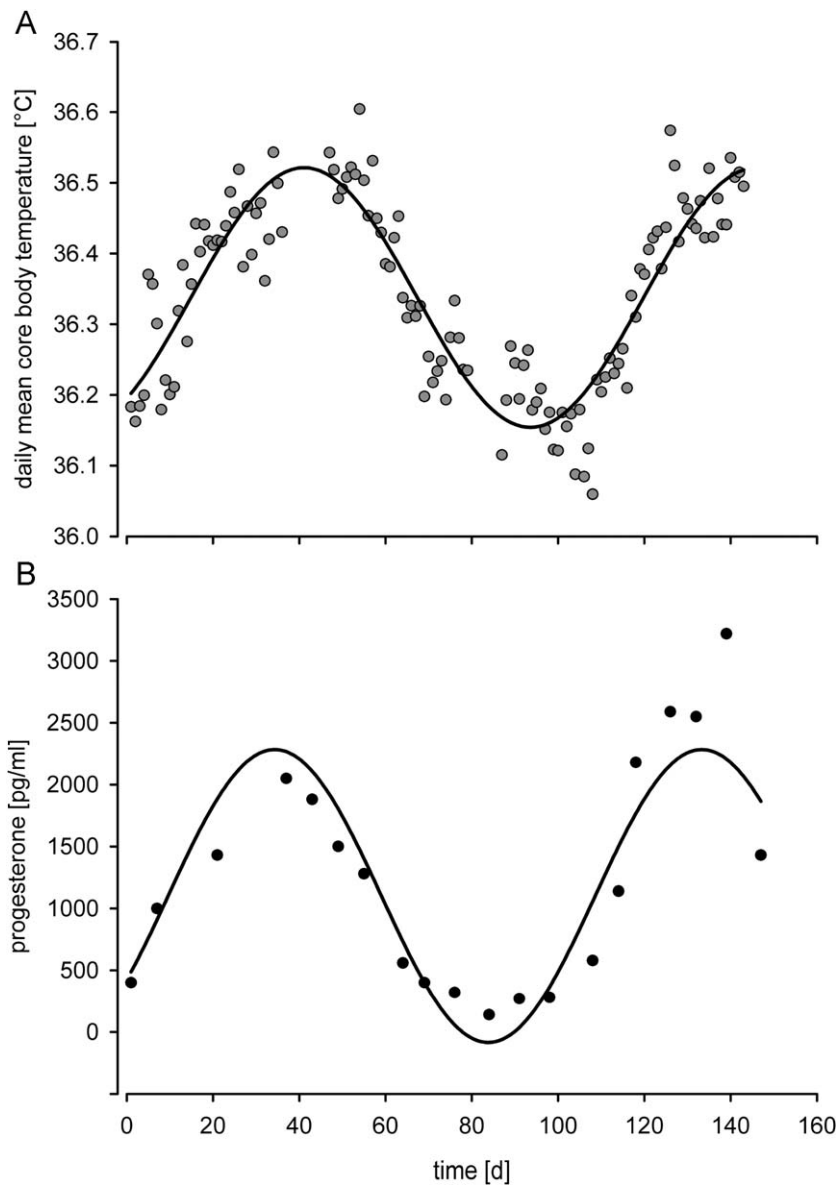

**Fig. 6.** (A) Daily mean body core temperature of an African elephant. Grey symbols and cosine wave: rhythmical variations in mean daily body temperature. Cycle duration: 102 days. (B) Progesterone profile of the same elephant. Black symbols and cosine wave: rhythmical variations in blood progesterone concentration (two subsequent progesterone peaks). Cycle duration: 99 days.

special training. We administered the capsules together with treats. Others made the animals swallow the capsules by washing down the telemeter with a constant stream of water from a hosepipe (Hidden, 2009). In ruminates, a balling gun is used for the administration of bolus according to routine procedures (Rebhuhn, 1995). The bolus operates as a carrier of different purpose devices (magnets, biotelemetric monitoring, etc.). The applicator is introduced as far as the end of the tongue (torus linguae) and the bolus is deposited in the oropharyngeal cavity (oropharynx). However, which procedure is suited best depends on the animal in question.

The signals were of good quality. Only the signals recorded via telemetry were sometimes overlaid by interfering signals, for example from electric fences. Furthermore, the signal quality varied between the two locations (Vienna and Munich Zoo) for unknown reasons. External data recording, however, is indispensable in case telemetry sensors are not defaecated for a long time, as was observed in the African elephants. Significant

differences in gut transit periods were measured between the two species. Initially, it was supposed that the capsules would pass the gut within a few days (McConnell, 1998; Toscano et al., 2001; Kinahan et al., 2007; Hidden, 2009). In both observed African elephants, the telemetry sensors stayed in the intestine for a long period. In Asian elephants, the capsules passed the digestive tract within 1 to 10 days. It is debatable whether the observed differences in intestine transit periods are species-dependent or not. Other studies on African elephants have shown that telemetry sensors can stay for a longer period in the intestine, but this is more the exception than the rule (McConnell, 1998: 46 days; Hidden, 2009: 120 days). There seemed to be a correlation between the size and weight of the telemetry sensors and intestine passage time. The increased volume and weight of the data loggers increased their transit times from about two to 21 days when doubling the weight from 7 to 13 g, as measured by Hidden (2009). Furthermore, the author indicated that feeding a 30 g data logger resulted in a stay of at least four months in the

gastrointestinal tract. The telemetry sensors used in this study also measured about 30 g and remained in the gut of one African elephant for at least three months, at which point the signal from the transmitter was lost, and in the other for one-and-a-half years before being discovered by chance. Based on these findings we suppose that only small and light data loggers ( $\leq 7$  g) can pass the gastrointestinal tract of African elephants within days. Elephants and rhinoceroses are both hindgut fermenters (Owen-Smith, 1988). For this reason, the gut passage of telemeters and the quality of temperature signals in elephants is most likely to hold true for rhinoceroses as well. Hippopotami have forestomach fermentation, but without the clearly divided compartments and remastication typical of ruminants (Owen-Smith, 1988). Accordingly, it is conceivable that our method of measuring  $T_b$  will also work in hippopotami. Furthermore, it has been demonstrated in at least one hippopotamus that small temperature data loggers (i-Buttons®) can pass through the intestines (Piccione et al., 2005). Giraffes, however, are ruminates and chew the cud. In ruminates, i.e. cattle, it is known that foreign bodies remain in the animal's stomach (Rebhuhn, 1995).  $T_b$  measurements in cattle are done by rumen telemeters, which are inserted to the bovine's stomach (Prendiville et al., 2002).

Moreover, long-time recordings of  $T_b$  might provide information about further physiological aspects, e.g. oestrous cycle. The cosinusoidal variation in daily mean  $T_b$ , we recorded, can be explained best by the known effect of sexual hormones on the cycle of body core temperature. The postovulatory elevation in  $T_b$  might be due to the thermogenic action of progesterone, as shown already in elephants (Kusuda et al., 2007). However, the inaccuracy of common methods of measuring  $T_b$  in elephants, particularly rectal measurements, allows the distinction between ovarian cyclicity and acyclicity only. The application of more accurate methods for determining  $T_b$  might allow a more precise estimate of ovarian cycle length, as shown here. The period of cosinusoidal variation in daily mean  $T_b$  conforms best to the peak to peak interval in progesterone release of the ovarian cycle of the observed elephant, which was determined in a previous study (Weissenböck et al., 2009).

Summarising, the measurement of  $T_b$  by ingestible data loggers is practical in zoo and semi-wild elephants and likely to be possible in hippopotami and rhinoceroses.

In wild megaherbivores, however, the situation is different. Wild animals cannot be handled without sedation. Furthermore, they might need to be treated repeatedly because of the short transit times of data loggers, as we showed in Asian elephants. Besides, the retrieval of data loggers, even when equipped with a transmitter, is less likely in the wild.

## Acknowledgements

We thank Vienna Zoo, Tiergarten Schönbrunn and Munich Zoo, Hellabrunn, for their support during data collection and financial aid. Special thanks go to Professor Parntep Ratanakorn from the Mahidol University for supervising in Thailand. We also thank the management and mahouts from the Samphran Elephant Ground and Zoo for their practical help. N.W. was funded by the Austrian Academy of Science.

## References

- Brown-Brandl, T.M., Yanagi Jr., T., Xin, H., Gates, R.S., Bucklin, R.A., Ross, G.S., 2003. A new telemetry system for measuring core body temperature in livestock and poultry. *Appl. Eng. Agric.* 19 (5), 583–589.
- Cooke, S., Hinch, S., Wikelski, M., Andrews, R., Kuchel, L., Wolcott, T., Butler, P., 2004. Biotelemetry: a mechanistic approach to ecology. *Trends Ecol. Evol.* 19, 334–343.
- Green, A.R., Gates, R.S., Lawrence, L.M., 2005. Measurement of horse core body temperature. *J. Therm. Biol.* 30, 370–377.
- Hidden, P.A. 2009. Thermoregulation in African elephants (*Loxodonta africana*) M.Sc. thesis, University of Witwatersrand, Johannesburg.
- Kinahan, A.A., Inge-møller, R., Bateman, P.W., Kotze, A., Scantlebury, M., 2007. Body temperature daily rhythm adaptations in African savannah elephants (*Loxodonta africana*). *Physiol. Behav.* 92, 560–565.
- Kusuda, S., Wakimoto, T., Sato, T., Nishimura, K., et al., 2007. Relationship between body temperature and ovarian cycle in Asian and African elephant. *J. Reprod. Dev.* 53, 1099–1105.
- McConnell, M.B., 1998. Minimeter research and transrectal ultrasonography at the Toledo Zoo. *J. Elephant Manage. Assoc.* 9, 111–118.
- McNab, B.K., 1983. Energetics, body size and the limits to endothermy. *J. Zool.* 199, 1–29.
- McNab, B.K. 2002. *The Physiological Ecology of Vertebrates: A View from energetics.* Comstock, Ithaca, New York.
- Neville, C., Friend, T., 2003. The behaviour of circus tigers during transport. *Appl. Anim. Behav. Sci.* 82, 329–337.
- Owen-Smith, R.N., 1988. *Megaherbivores, The Influence of Very Large Body Size on Ecology.* Cambridge University Press, Cambridge, New York, Victoria.
- Piccione, G., Caola, G., Mortola, J.P., 2005. Scaling the daily oscillations of breathing frequency and skin temperature in mammals. *Comp. Biochem. Physiol. A* 140, 477–486.
- Pinheiro, J., Bates, D., DebRoy S., Sarkar, D. 2009. LME: linear and nonlinear mixed effects models. R package version 3.1–92. URL "<http://www.R-project.org>".
- Prendiville, D.J., Lowe, J., Earley, B., Spahr, C., Kettlewell, P. 2002. Radiotelemetry systems for measuring body temperature. Beef Production Series 57, Grange Research Centre Dunsany Co. Meath.
- R Development Core Team 2009. R: a language and environment for statistical computing. R Foundation for Statistical Computing, Vienna, Austria. URL "<http://www.R-project.org>".
- Rebhuhn, W.C., 1995. *Diseases of Dairy Cattle.* Williams & Wilkins, Baltimore.
- Toscano, M.J., Friend, T.H., Nevill, C.H., 2001. Environmental conditions and body temperature of circus elephants transported during relatively high and low temperature conditions. *J. Elephant Manage. Assoc.* 12, 116–149.
- Weissenböck, N.M., Schwammer, H.M., Ruf, T., 2009. Estrous synchrony in a group of African elephants (*Loxodonta africana*) under human care. *Anim. Reprod. Sci.* 113, 322–327.

## - CHAPTER III -

### **Heterothermy in Asian elephants**

*Copy of the paper entitled "Heterothermy in Asian elephants: an adaptation to hot and humid climates" submitted to the Journal of Experimental Biology*



# Heterothermy in Asian elephants: an adaptation to hot and humid climates

Nicole M. Weissenböck\*, Thomas Ruf and Walter Arnold

Research Institute of Wildlife Ecology of the University of Veterinary Medicine, 1210 Vienna, Austria

\*Author for correspondence (nicole.weissenboeck@fiwi.at)

Running headline: Heterothermy in Asian elephants

## SUMMARY

Some desert mammals, such as camels, tolerate elevated core body temperature during the day and dissipate the excess heat during the cooler night hours. This so-called “adaptive heterothermy” reduces both water and energy requirements for evaporative cooling. We investigated whether this response also exists in non-desert animals when large body size alone constrains heat dissipation.

We measured intestinal core body temperature of eleven adult Asian elephants with ingestible devices at five minute intervals during 37 gut passages.

We found that Asian elephants exposed to the humid and hot climate of their natural habitat, indeed show pronounced heterothermia, even when supplied with plenty of water and food. Core body temperature reached its daily peak before sunset and fluctuated with a daily range 2.6 times larger than expected from allometric relations and considerably higher than reported for elephants studied in South Africa.

We estimate that elephants can store up to 26.5 MJ heat per day in their huge bodies, equivalent to about 10% of their daily energy expenditure. This heat load was dissipated during the night through an elevated thermal conductance. Heat dissipation increased during the first part of the night with a greater increase on days with higher maximum ambient temperature.

We conclude that heterothermy is an adaptive and regular response of Asian elephants to high ambient temperature. Body size constraints may well explain why habitats other than arid zones push mammals to their physiological limits.

**Key-words:** allometric relationship, core body temperature, *Elephas maximus*, heterothermia, high air humidity, high ambient temperature, large body size, physiological limits

## INTRODUCTION

Many physiological processes are strongly influenced by body size (Aschoff, 1982). For instance, daily fluctuations in core body temperature ( $T_b$ ) of mammals decrease with increasing body mass ( $M$ ). This relation reflects both the higher heat capacity of large bodies and the more efficient heat exchange control of large animals (Phillips and Heath, 1995). Large body size is energetically advantageous at low ambient temperatures ( $T_a$ ) but problematic in hot climates (Schmidt-Nielsen, 1984) where, paradoxically, the largest extant terrestrial species, e.g., elephants, rhinoceroses, hippopotami and giraffes, are currently found. At high  $T_a$ , an unfavourable surface-to-volume ratio severely constrains heat loss (Taylor, 1969). Large mammals living in hot habitats have therefore developed unique adaptations to improve heat transfer to the environment, despite the small gradient between surface body temperature and  $T_a$ . The fur of mammals from hot habitats decreases in thickness as body size increases (Louw and Seely, 1982), with a complete lack of fur in rhinoceroses, hippopotami and elephants. Long necks, long legs and behavioural responses, such as fanning large ears, further facilitate heat loss (Mitchell and Skinner, 1993; Willmer et al., 2005).

The great compensation offered by large size is that of high thermal inertia, opening up the opportunity of substantial heat storage and the strategy of adaptive heterothermy. Here the body temperature is allowed to fluctuate rather widely on a daily basis, with heat storage during the day and a peak in body temperature before sunset. During the subsequent night, body temperature is allowed to fall enabling the animals to begin the day with a thermal reserve (Louw and Seely, 1982; Willmer et al., 2005). This type of “adaptive heterothermy” was first described in the camel (*Camelus dromedaries*) by Schmidt-Nielsen et al. (1956). Camels apparently are able to reduce evaporative water loss through the accumulation of heat in the body by temporarily tolerating a body temperature of up to 41°C. Further studies have also found this mechanism, particularly in large (Cape elands *Taurotragus oryx*: Taylor 1969; Taylor and Lyman, 1967; Arabian oryx *Oryx leucoryx*: Taylor, 1969) and medium-sized desert animals (Thompson’s gazelle *Gazella thomsonii*: Taylor, 1970). Its adaptive function remained a matter of debate for a long time (Mitchell et al., 2002), but was eventually confirmed by two recent studies on free-living desert animals (Arabian oryx: Ostrowski et al., 2003; Arabian sand gazelle *Gazella subgutturosa marica*: Ostrowski and Williams, 2006). However, it is not known whether adaptive heterothermy as a reaction to thermoregulatory challenges also exists in non-desert mammals that are neither exposed to high rates of solar radiation nor to  $T_a$ ’s that regularly exceed  $T_b$ .

Heat exchange between body and environment is, however, affected not only by  $T_a$  and solar radiation but also by relative air humidity (RH) (National Research Council, 1971). A high moisture content of the air impairs evaporative heat loss, which makes this avenue of cooling less effective. Hot and humid climates therefore represent a thermoregulatory challenge that is particularly severe for large mammals.

Elephants are the largest extant terrestrial mammals and Asian elephants occur in habitats characterised by both high  $T_a$  and high RH (Spinage, 1994). We therefore predicted exceptionally high amplitudes of daily  $T_b$  fluctuations in this species, because tolerating a higher  $T_b$  and dissipating this excess heat during the more favourable thermal environment of the night decreases the energetic cost of thermoregulation and the need for evaporative cooling. We investigated this question in adult Asian elephants living in their natural habitat in Thailand.

## **MATERIALS AND METHODS**

### **Study place and elephants**

Between February and March 2009 we studied 7 female and 4 male adult Asian elephants (*Elephas maximus*, Linnaeus 1758) (aged between 14 and 60 years) at the Samphran Elephant Ground and Zoo in Thailand (100°13'N, 13°43'E). Every elephant had his own mahout, who cared for the animal. The animals were exposed to the hot and humid climate of their natural habitat. Most parts of the elephant park were shaded by trees and awnings with animals exposed to direct sunlight for only two to three hours a day, mostly between 13:00 and 16:00. The elephants had a daily routine that included an elephant show (13:30, 15:30 and on Friday and Saturday additionally at approximately 12:00) and trekking (from 10:00 to 15:30). The elephants were kept outdoors day and night. They were chained during the night and housed in a shelter (from 16:00 to 9:00). The main diet was hay complemented with pineapple leaves. Water was provided to the elephants only during daytime. We estimated the body weight of each study animals from their age (Kurt, 2005).

### **Measurements of core body temperature and experimental procedure**

$T_b$  was measured with a telemetry system developed at the Research Institute of Wildlife Ecology. The system consisted of a temperature measurement unit, a non-volatile memory with a storage capacity of 32,000 temperature readings, a VHF radio transmitter, and operated under control of an integrated microcontroller. The components were embedded in epoxy resin in a cylindrical stainless steel capsule to protect the electronic parts from shock and moisture. The capsules were fed to the elephants. They transmitted a temperature measurement every 60 sec and stored one every 300 sec. For full description of the construction and functionality of the temperature devices see Weissenböck et al. (2010). Capsules for  $T_b$  measurements were fed to the elephants inside bananas. The prepared fruit was placed by hand onto the back of the tongue, immediately followed by plenty of bananas stuffed into the mouth. This elicited a swallowing reflex before the animal began to chew. Intestinal  $T_b$  was measured during 37 gut passages with a mean duration of 78 hours (s.d. 46.3). Excretion of the capsules was evident from a rapid drop in temperature. Capsules were recovered from dung with the help of a portable receiver and a hand-held H-bar antenna. After downloading

of data, capsules were re-used in further experiments. Altogether, we obtained 19,270 recordings of  $T_b$  during intestinal passage of the devices.  $T_a$  was measured throughout the study in close proximity to the elephants (<100 m) with a temperature data logger (Gemini Data Loggers Ltd, Chichester, West Sussex, UK).

### Determining the amount of heat stored

The amount of heat stored during the day (HS) can then be calculated as

$$HS = c * (T_b \text{ max} - T_b \text{ min}) * M \text{ (kg)} \text{ (McNab, 2002)} \quad \text{equation 1}$$

where  $c$  is the specific heat capacity of tissue, i.e.  $3.48 \text{ J } ^\circ\text{C}^{-1} \text{ g}^{-1}$  for mammalian tissues (IUPS Thermal Commission, 2003).

### Determining thermal conductance

Thermal conductance ( $C$ ) of elephants during the nocturnal cooling phase was estimated from changes in body temperature ( $T_b$ ) and ambient temperature ( $T_a$ ) assuming that heat production ( $HP$ ) stayed constant (in animals at rest) and corresponded to BMR ( $0.6496 \text{ W kg}^{-1}$ ) (Benedict, 1936).

$T_b$  as a function of time ( $t$ ) during cooling in an animal with constant  $HP$  and thermal conductance  $C$  can be predicted from

$$T_b = (T_a + HP * C^{-1}) + (T_{b0} - (T_a + HP * C^{-1})) * e^{-kt} \quad \text{equation 2}$$

with  $T_{b0}$  representing the initial  $T_b$ , and  $k$  the ratio  $k = C * c^{-1}$ .

For a formal derivation of equation 2, based on Newton's law of cooling, see Ruf (1992). The term  $(T_a + HP * C^{-1})$  corresponds to the minimal  $T_b$  reached in the time interval  $t$ , while the remainder of the equation determines the shape of the cooling curve.

For the current purpose, eq. 2 was used to determine  $C$  from measured values of  $T_b$  and  $T_a$ , assuming that  $HP$  stayed constant (at BMR). Although there is no algebraic solution of eq. 2 for  $C$ , thermal conductance can be determined numerically to any desired degree of accuracy by fitting eq. 1 to observed values of  $T_b$ , given a constant  $HP$  and measured values of  $T_a$ . This was carried out by using function `nlminb` in the statistical package R (R Development Core Team, 2009) to find those values of  $C$  that minimized the difference between observed and predicted  $T_b$  over each 5 min measurement interval. Hence, for each interval  $t$  to  $t+1$ , we used  $T_{b0}=T_b(t)$ , mean  $T_a$  in the interval  $t$  to  $t+1$ , and  $HP=0.6496 \text{ W kg}^{-1}$  to minimize the predicted-observed  $T_b$  differences (tolerance  $\leq 1e-10 \text{ } ^\circ\text{C}$ ), and report corresponding values of  $C$ .

## Statistical analysis

Statistical tests were performed using the statistical package R (R Development Core Team, 2009). We computed autocorrelation functions to identify the time lag necessary to render subsequent measurements of  $T_b$  and  $C$  independent. The initial strong autocorrelation between subsequent  $T_b$  and  $C$  measurements disappeared ( $P>0.05$ ) after a time interval of four and three hours, respectively. We therefore considered means calculated over intervals of four hours for  $T_b$  and three hours for  $C$  as statistically independent. We verified normality and homoscedasticity of model residuals with Shapiro-Wilk normality and Levene's tests, respectively. We analysed data with linear mixed effect models (library nlme, Pinheiro et al., 2009), with different intercepts for individual as a random effect in order to correct for repeated measurements. Reported effects of  $T_a$  on  $T_b$  are partial effects obtained from multiple regression models containing age, sex, and estimated body weight as additional predictors. However, none of these additional predictors had a significant effect on  $T_b$  (all  $P\geq 0.1$ ).

We furthermore determined the phase relations of the  $T_b$  and  $T_a$  rhythms by fitting segmented linear regression models (Muggeo, 2008) to the data. We analysed for the maxima and minima separately. The boundaries between the segments, the breakpoints, corresponded to the maxima and minima of  $T_b$  and  $T_a$ .

## Ethical approval

This study was approved by the FVS-MU Committee on Ethics of Laboratory Animals Use of the Mahidol University, Thailand.

## RESULTS

### Core body temperature rhythm

The overall mean  $T_b$  was  $36.2^\circ\text{C}$  (s.e.m. 0.12). We found no sex or age related differences. A distinct daily rhythm of  $T_b$  was evident, which, remarkably ran parallel to the daily course of  $T_a$  (Fig. 1A, B). We found an overall correlation between daily mean  $T_b$  and daily maximum  $T_a$  ( $F_{1,44}=5.321$ ,  $P=0.026$ ). However, multiple regression analyses showed that changes in  $T_b$  were largely determined by the time of day during both the rising phase ( $F_{2,157}=16.767$ ,  $P<0.001$ ) and the declining phase ( $F_{2,174}=63.608$ ,  $P<0.001$ ). Variation in  $T_a$  had an additional independent effect on the rates of changes in  $T_b$ , but this effect was much more pronounced during the rising phase of  $T_b$  ( $F_{1,157}=8.519$ ,  $P=0.004$ ) than during its nocturnal decline ( $F_{1,174}=3.374$ ,  $P=0.068$ ).  $T_b$  was lowest at 06:10, about 1.5 hours earlier than  $T_a$ .  $T_b$  peaked at 17:32, about an hour after the mean daily  $T_a$  maximum at 16:33 (Fig. 1B).

The mean range of daily  $T_b$  fluctuations was  $1.3^\circ\text{C}$  (s.e.m. 0.04). We found an increase in the daily range of  $T_b$  with rising daily maximum  $T_a$  ( $F_{1,44}=5.113$ ,  $P=0.028$ ). Furthermore daily



mean  $T_b$  and daily maximum  $T_b$  increased with increasing daily mean  $T_a$ , but daily minimum  $T_b$  was unaffected by  $T_a$  (Fig. 2).

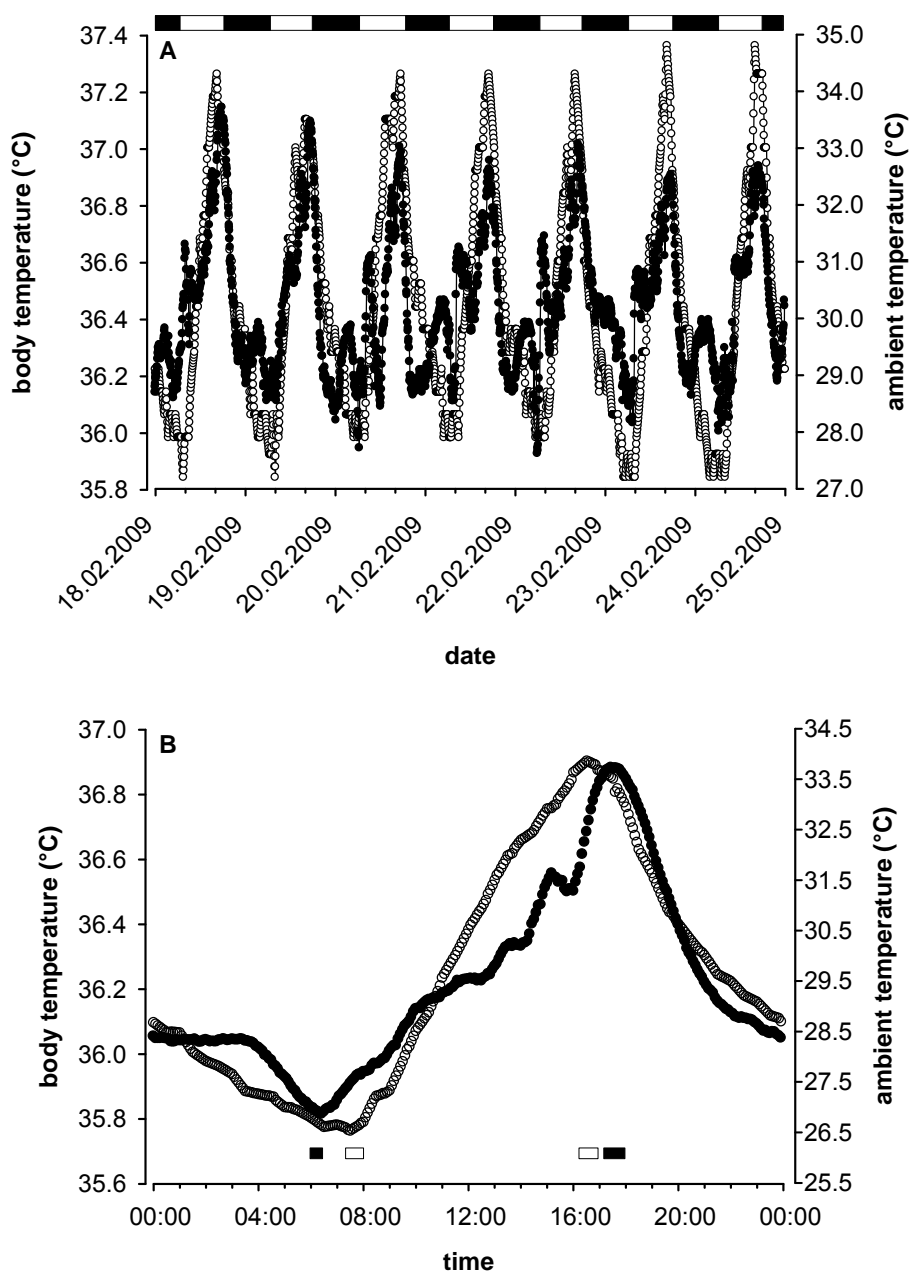

**Figure 1 - Daily fluctuations of core body temperature and ambient temperature.**

**A** Representative pattern of core body temperature (black circles) in an adult female over seven days and corresponding ambient temperature (white circles). The white and black bars at the top indicate the daily light– dark cycle.

**B** 24-h profile of average core body temperature (black circles) and ambient temperature (white circles). S.e.m. reflecting variation between individuals are not visible because they are smaller than symbol size. Horizontal bars indicate 99% confidence limits of the breakpoints of the rise and fall of ambient temperature (white bars) respectively core body temperature (black bars), determined by segmented regression (see text for details).

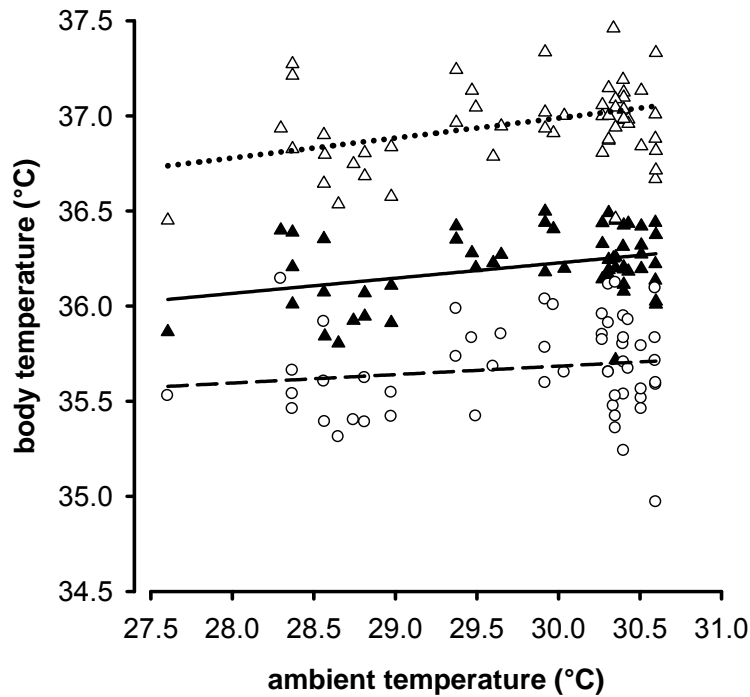

**Figure 2 - Relation between the daily core body temperature and daily mean ambient temperature.** Intestinal temperatures as a function of daily mean  $T_a$ . White triangles and dotted line: daily maximum of core body temperature and regression line ( $F_{1,53}=7.604$ ,  $P=0.008$ ). Black triangles and solid line: daily mean of core body temperature and regression line ( $F_{1,53}=7.401$ ,  $P=0.009$ ). White circles and dashed line: daily minimum of core body temperature and regression line ( $F_{1,53}=1.168$ ,  $P=0.285$ ).

### Heat storage

The metabolic rate of an adult Asian elephant in standing position and with ongoing digestion is reported as  $0.858 \text{ W kg}^{-1}$  at a  $T_a$  of  $20^\circ\text{C}$  (Benedict, 1936). More recent measurements of elephant metabolic rates revealed similar values (Langman et al., 1995). Based on these measurements, the minimum daily energy expenditure (DEE) of our elephants at rest should have been between 221.6 and 354.6 MJ per day, according to our estimates of body mass.

Assuming the daily  $T_b$  fluctuations and the elephants' body mass, the amount of heat stored during the day was between 8.8 and 26.5 MJ. This is equivalent to 3.7 to 10.0% of the DEE.

### Thermal conductance

The elephants did not show a decrease of minimal  $T_b$  during the night as mean daily  $T_a$  increased (Fig. 2). To verify whether this was due to the huge mass and unfavourable surface to volume ratio of their bodies preventing a faster passive decline of  $T_b$  during the available time window of cool night hours, we estimated thermal conductance (C) and the variation in C with changing  $T_b$  (see methods). Mean C was  $0.11 \text{ W kg}^{-1} \text{ }^\circ\text{C}^{-1}$ . C was highest immediately

after peak  $T_b$  ( $0.23 \text{ W kg}^{-1} \text{ }^\circ\text{C}^{-1}$ ), and subsequently declined asymptotically during the cooling phase to minimal values (Fig. 3A). Minimum  $C$  ( $0.07 \text{ W kg}^{-1} \text{ }^\circ\text{C}^{-1}$ ) was reached at the typical daily minimum  $T_b$  of  $35.5^\circ\text{C}$ .  $C$  increased with daily maximum  $T_a$  ( $F_{1,49}=98.341$ ,  $P<0.001$ ) (Fig. 3B).

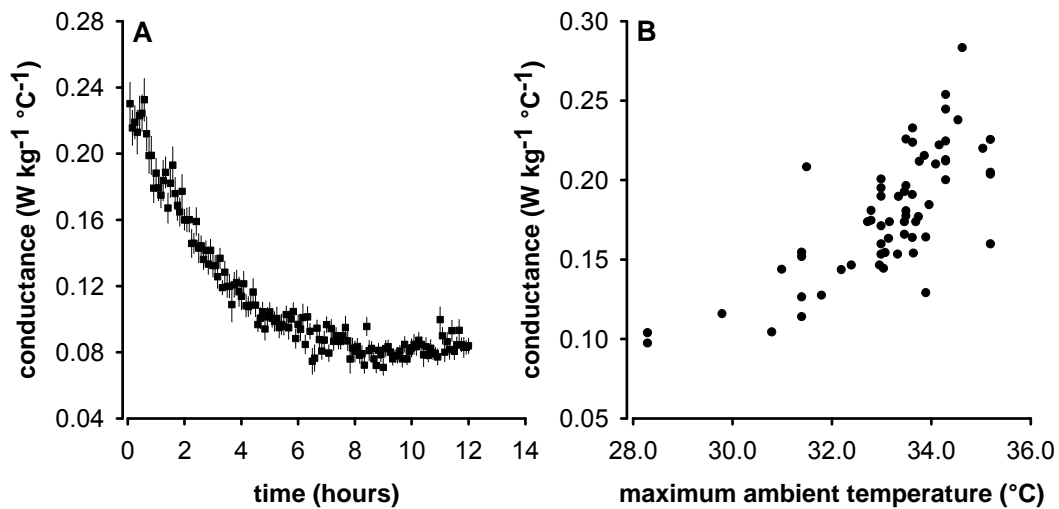

**Figure 3 – Thermal conductance. A** Time course of thermal conductance ( $C$ ) during the decline of core body temperature from its daily maximum to its daily minimum. Plotted values are means of all measurements. s.e.m reflecting variations between individuals and single days.

**B** Average  $C$  during the first three hours of the daily core body temperature decline as a function of maximum daily ambient temperature ( $F_{1,50}=62.585$ ,  $P<0.001$ ).

## DISCUSSION

Our study provides the first continuous, accurate measurements of core body temperature in Asian elephants in their natural habitat. Our results clearly show that adaptive heterothermy is a strategy not necessarily restricted to desert mammals, but also applied by large herbivores when body size constraints heat loss.

Free- ranging arid-zone antelopes used heterothermy when exposed to  $T_{as}>40^\circ\text{C}$  and when water was restricted (Ostrowski et al., 2003; Ostrowski and Williams, 2006), but not when climate conditions were moderate ( $T_{as}<35^\circ\text{C}$ ) (Mitchell et al., 1997; Fuller et al., 1999; Fuller et al., 2005). However, the studied Asian elephants employed heterothermia at more mild  $T_{as}$  (mean daily  $T_a$  of  $29.6^\circ\text{C}$  and mean daily maximum  $T_a$  of  $34.1^\circ\text{C}$ ) and even when supplied with plenty of food and water.

Mean  $T_b$  of our elephants was  $36.2^\circ\text{C}$ , which is within the range of core body temperatures of  $36\text{-}39^\circ\text{C}$  in placental mammals (Cossins and Bowler, 1987) and identical to the gastrointestinal  $T_b$  reported for African elephants in South Africa (Kinahan et al., 2007).

The daily rhythm of  $T_b$  and  $T_a$  were correlated. However, we found that changes in  $T_b$  were largely determined by the time of day. This suggests an endogenous daily rhythm of  $T_b$ .  $T_a$

had an additional independent effect on the rates of changes in  $T_b$ , with this effect much more pronounced during the hottest daytime hours than during nocturnal cooling.

The circadian rhythm of  $T_b$  was robust with lowest  $T_b$  values measured at 06:10, shortly before sunrise and peak values at 17:32, about an hour after  $T_a$  peaked and an hour before sunset. This is concurrent with the acrophase found in other large ungulates, which occurs at or near the end of the thermal heat load (approximately 17:00–19:00) (Dawson, 1955; Maloney et al., 2002; Mitchell et al., 2002; Blanc et al., 2003). Interestingly, Kinahan et al. (2007) suggested that African elephants have a peak  $T_b$  late in the evening (around 22:00).

Differences between the Asian elephants we studied and the African elephants observed by Kinahan et al. (2007) were also seen in the mean range of daily  $T_b$  fluctuations. We found a daily variation in  $T_b$  of 1.3°C, which is considerably higher than reported for African elephants (daily  $T_b$  fluctuations: 0.8°C) and 2.6 times larger than expected from allometric scaling (Mortola and Lanthier, 2004). Further, we found an increase in the daily range of  $T_b$  with rising daily maximum  $T_a$ . This increase was a result of increasing maximum  $T_b$ , as daily minimum  $T_b$  was unaffected by  $T_a$ .

It is thought that adaptive heterothermy is characterised by daily fluctuations in  $T_b$  that are large enough to account for appreciable heat storage (Mitchell et al., 2002). We therefore calculated heat storage in our study animals and found that elephants apparently saved energy by using a similar physiological response to that reported in desert mammals. From the  $T_b$  data and the specific heat capacity of mammalian tissue (IUPS Thermal Commission, 2003), we estimated that the amount of heat stored during the day was between 8.8 and 26.5 MJ. This is equivalent to 3.7 to 10.0% of the daily energy expenditure (DEE) reported for Asian elephants (Benedict, 1936). These values correspond to those found in Arabian oryx. Based on the DEE (Williams et al., 2001) and the known amount of heat storage for oryx (Ostrowski et al., 2003), these animals stored about 6% body heat during hot summer days.

Although our results indicate that Asian elephants can be regarded as heterotherms with respect to the amount of heat stored during hot days (Mitchell et al., 2002), there are three important differences to other species previously recognized as heterotherms. Firstly, and as mentioned above, adaptive heterothermy was ascertained only in arid mammals exposed to  $T_a$ s regularly exceeding  $T_b$ . In contrast, Asian elephants live in habitats where  $T_a$  approaches, but rarely exceeds,  $T_b$ . Secondly, in heterotherms from arid habitats  $T_b$  not only exceeds the allometrically predicted daily maximum, but also falls below the predicted minimum during the night. In other words, these species enter the hot day with a thermal reserve (Louw and Seely, 1982; Willmer et al., 2005). Our elephants did not show a decrease of minimal  $T_b$  during the night as mean daily  $T_a$  increased. This could be due to the huge mass and unfavourable surface to volume ratio of their bodies preventing a faster passive decline of  $T_b$  during the available time window of cool night hours. To test this hypothesis, we estimated thermal conductance (C) (Bradley and Deavers, 1980; Aschoff, 1982) of our study animals and the

variation in  $C$  with changing  $T_b$ .  $C$  was highest immediately after peak  $T_b$ , and subsequently declined asymptotically during the cooling phase to minimal values. Minimum  $C$  was reached at the typical daily minimum  $T_b$  of 35.5°C.  $C$  increased with daily maximum  $T_a$ . If  $C$  had remained at its initial (early night) value of  $0.23 \text{ W kg}^{-1} \text{ }^\circ\text{C}^{-1}$ , the elephants  $T_b$  would have fallen well ( $\sim 5^\circ\text{C}$ ) below 35.5°C. Thus, our study animals apparently actively prevented  $T_b$  from falling below 35.5°C. We can only speculate why this was the case. Passive re-warming during the early morning may be too slow to reach a  $T_b$  optimal for activity, foraging, or digestion (Morrison, 1960). In addition, the huge body mass of elephants may well provide sufficient capacity for heat storage during the day without entering hypothermia at night. Alternatively, the nightly decline may have been facilitated by energetically costly evaporative heat loss. Evaporative heat loss occurs in elephants only by diffusion of water through the skin and respiration (Benedict, 1936). Both pathways account for not more than 7% of total heat loss, as estimated for average-sized African elephants (Hiley, 1975). For Asian elephants, evaporative heat loss is presumably even more restricted due to the typically high humidity of their natural surroundings (Spinage, 1994). Depending on the region and season, RH can reach above 90% and, even during winter when precipitation in southern Asia is low, the RH is higher than 60% (Oliver, 2005). In contrast, typical habitats of African elephants are much less humid (Spinage, 1994), with mean annual RH of between 30 and 60% (Le Hou  rou, 2009), which possibly renders evaporative heat loss a better option than heterothermy. Supporting this interpretation is the much lower range of daily  $T_b$  fluctuation reported for African elephants (Kinahan et al., 2007). The lack of reasonable water restriction is the third crucial difference between Asian elephants and arid-zone heterotherms. Mammals in arid environments show increasing heterothermia as dehydration progresses (Taylor, 1969; Ostrowski et al., 2003; Ostrowski and Willimas, 2006). This factor is most likely irrelevant for Asian elephants, and certainly for the animals studied, because they were supplied with plenty of water.

In conclusion, Asian elephants regularly use heterothermy as an effective physiological mechanism to cope with the high heat load that is typical for their warm and humid natural habitat. These conditions apparently represent a severe thermoregulatory challenge for such a large mammal. Thus, thermoregulatory constraints may have set the upper limit in body size evolution of mammals and may well explain why elephants are the largest extant terrestrial animals. However, as global warming renders Asia hotter (Hulme et al., 1994; Hulme and Viner, 1998; IPCC, 2007), this may pose another peril to an already threatened species.

## **ACKNOWLEDGEMENTS**

N.M.W. was sponsored by a DOC-fFORTE scholarship from the Austrian Academy of Science. Further financial aid was provided by the Tiergarten Sch  nbrunn, Vienna and the Tierpark Hellabrunn, Munich. We thank P. Ratanakorn from the Mahidol University Thailand and

the management from the Samphran Elephant Ground and Zoo for providing access to the elephants. We thank C. Weiss and the mahouts from the Samphran Elephant Ground and Zoo for their assistance with data collection. Thank you also to G. Fluch for the production of the temperature data loggers and for technical support.

## REFERENCES

- Aschoff, J.** (1982). The circadian rhythm of body temperature as a function of body size. In *A Companion to Animal Physiology* (eds C.R. Taylor, K. Johansen and L. Bolis), pp. 173-188. Cambridge, London, New York, New Rochelle, Melbourne, Sydney: Cambridge University Press.
- Benedict, F.** (1936). *The Physiology of the Elephant*. Washington: Nutrition Laboratory, Carnegie Institution of Washington,.
- Blanc, J.J., Thouless, C.R., Hart, J.A., Dublin H.T., Douglas-Hamilton I., Craig C.G. and Barnes, R.F.W.** (2003). *African elephant status report 2002*. Gland: international union for the conservation of nature.
- Bradley, S.R. and Deavers, D.R.** (1980). A re-examination of the relationship between thermal conductance and body weight in mammals. *Comp. Biochem. Physiol. A* **65**, 465-476.
- Cossins, A.R. and Bowler, K.** (1987). *Temperature Biology of Animals*. London: Chapman and Hall.
- Dawson, W.R.** (1955). The relation of oxygen consumption to temperature in desert rodents. *J. Mammal.* **36**, 543-552.
- Fuller, A., Moss, D.G., Skinner, J.D., Jessen, P.T., Mitchell, G. and Mitchell, D.** (1999). Brain, abdominal and arterial blood temperatures of free-ranging eland in their natural habitat. *Eur. J. Physiol.* **438**, 671-680.
- Fuller, A., Kamerman, P.R., Maloney, S.K., Matthee, A., Mitchell, G. and Mitchell, D.** (2005). A year in the thermal life of a free-ranging herd of springbok *Antidorcas marsupialis*. *J. Exp. Biol.* **208**, 2855-2864.
- Hiley, P.** (1975). How the elephant keeps its cool. *Nat. Hist.* **84**, 34-40.
- Hulme, M. and Viner, D.** (1998). A climate change scenario for the Tropics. *Clim. Change* **39**, 145-176.
- Hulme, M., Zhao, Z. and Jiang, T.** (1994). Recent and future climate change in East Asia. *Int. J. Climatol.* **14**, 637-658.
- IPCC** (2007). *Climate Change 2007: The Physical Science Basis*. Contribution of Working Group I to the Fourth Assessment Report of the Intergovernmental Panel on Climate Change (eds S. Solomon, D. Qin, M. Manning, Z. Chen, M. Marquis, K.B. Averyt, M. Tignor, and H.M. Miller). Cambridge, New York: Cambridge University Press.
- IUPS Thermal Commission.** (2003). Glossary of terms for thermal physiology. *J. Therm. Biol.* **28**, 75-106.
- Kinahan, A.A., Inge-moller, R., Bateman, P.W., Kotze, A. and Scantlebury, M.** (2007). Body temperature daily rhythm adaptations in African savanna elephants (*Loxodonta africana*). *Physiol. Behav.* **92**, 560-565.
- Kurt, F.** (2005). *Size, weight and age criteria in Asian elephants*. First European Elephant Management School November 2005. <http://www.colyerinstitute.org/pdf/feems3.pdf>.
- Langman, V.A., Roberts, T.J., Black, J., Maloiy, G.M.O., Heglund, N.C., Weber, J.-M., Kram, R., Taylor, C.R.** (1995). Moving cheaply: energetics of walking in the African elephant. *J. Exp. Biol.* **198**, 629-632.

- Le Houérou, H.N.** (2009). *Bioclimatology and Biogeography of Africa*. Berlin, Heidelberg: Springer.
- Louw, G.N. and Seely, M.K.** (1982). *Ecology of Desert Organisms*. London, New York: Longman.
- Maloney, S.K., Fuller, A., Mitchell, G. and Mitchell, D.** (2002). Brain and arterial blood temperatures of free-ranging oryx (*Oryx gazella*). *Eur. J. Physiol.* **443**, 437-445.
- McNab, B.K.** (2002). *The Physiological Ecology of Vertebrates: a View from Energetics*. New York: Comstock, Ithaca.
- Mitchell, D. Maloney, S.K., Jessen, C., Laburn, H.P., Kamerman, P.R., Mitchell, G. and Fuller, A.** (2002). Adaptive heterothermy and selective brain cooling in arid-zone mammals. *Comp. Biochem. Physiol. B* **131**, 571-585.
- Mitchell, D., Maloney, S. K., Laburn, H. P., Knight, M. H. and Jessen, C.** (1997). Activity, blood temperature and brain temperature of free-ranging springbok. *J. Comp. Physiol. B* **167**, 335-343.
- Mitchell, G. and Skinner, J.D.** (1993). How the giraffe adapt to their extraordinary shape. *Trans. Roy. Soc. South Afr.* **48**, 207-218.
- Morrison, P.** (1960). Some interrelations between weight and hibernation function. *Bull. Mus. Comp. Zool.* **124**, 75-91.
- Mortola, J.P. and Lanthier, C.** (2004). Scaling the amplitudes of the circadian pattern of resting oxygen consumption, body temperature and heart rate in mammals. *Comp. Biochem. Physiol. A* **139**, 83-95.
- Muggeo, V.M.R.** (2008). *Segmented: Segmented relationships in regression models*. R package version 0.2-4. <http://www.R-project.org>.
- National research council** (1971). *A Guide to Environmental Research on Animals*. Washington D.C.: National Academy of Sciences.
- Oliver, J.E.** (2005). *Encyclopedia of World Climatology*. Dordrecht, Berlin, Heidelberg, New York: Springer.
- Ostrowski, S., Williams, J.B. and Ismael, K.** (2003). Heterothermy and the water economy of free-living Arabian oryx (*Oryx leucoryx*). *J. Exp. Biol.* **206**, 1471-1478.
- Ostrowski, S. and Williams, J.B.** (2006). Heterothermy of free-living Arabian sand gazelles (*Gazella subgutturosa marica*) in desert environment. *J. Exp. Biol.* **209**, 1421-1429.
- Phillips, P. K. and Heath, J. E.** (1995). Dependency of surface temperature regulation on the body size in terrestrial mammals. *J. Therm. Biol.* **20**, 281-289.
- Pinheiro J., Bates, D., DebRoy S. and Sarkar, D.** (2009). *Lme: Linear and nonlinear mixed effects models*. R package version 3.1-92. <http://www.R-project.org>.
- R Development Core Team** (2009). *R: A language and environment for statistical computing*. R Foundation for Statistical Computing, Vienna, Austria. <http://www.R-project.org>.
- Ruf, T.** (1992). *Torpor beim Dsungarischen Zwerghamster (Phodopus sungorus) und der Hirschmaus (Peromyscus maniculatus): Saisonalität, Tagesperiodik und Energetik*. PhD thesis Philipps University, Marburg.
- Schmidt-Nielsen, K.** (1984). *Scaling: Why is Animal Size so Important?* Cambridge: Cambridge University Press.
- Schmidt- Nielsen, K., Schmidt- Nielsen, B., Jarnum, S.A. and Houpt, T.R.** (1956). Body temperature of the camel and its relation to water economy. *Am. J. Physiol.* **188**, 103-112.
- Spinage, C.A.** (1994). *Elephants*. London: T & AD Poyser Ltd.
- Taylor, C.R.** (1969). The Eland and the Oryx. *Sci. Am.* **220**, 88-97.

- Taylor, C.R.** (1970) Strategies of temperature regulation: effect on evaporation in East African ungulates. *Am. J. Physiol.* **219**, 1131-1135.
- Taylor, C.R. and Lyman, C.P.** (1967). A comparative study of the environmental physiology of an East African antelope, the eland, and the Hereford steer. *Physiol. Zool.* **40**, 280-295.
- Weissenböck, N.M., Schober, F., Fluch, G., Weiss, C., Paumann, T., Schwarz, C. and Arnold, W.** (2010). Reusable biotelemetric capsules: A convenient and reliable method for measuring core body temperature in large mammals during gut passage. *J. Therm. Biol.* **35**, 147-153.
- Williams, J. B., Ostrowski, S., Bedin, E. and Ismail, K.** (2001). Seasonal variation in energy expenditure, water flux and food consumptions of Arabian oryx *Oryx leucoryx*. *J. Exp. Biol.* **204**, 2301-2311.
- Willmer, P., Stone, G. and Johnson, I.** (2005). *Environmental Physiology of Animals*. 2nd ed. Magden: Blackwell Science.



## - CHAPTER IV -

### **Thermal windows on the body surface of African elephants**

*Copy of the paper entitled "Thermal windows on the body surface of African elephants (Loxodonta africana) studied by infrared thermography" published in the Journal of Thermal Biology*





ELSEVIER

Contents lists available at ScienceDirect

## Journal of Thermal Biology

journal homepage: [www.elsevier.com/locate/jtherbio](http://www.elsevier.com/locate/jtherbio)

## Thermal windows on the body surface of African elephants (*Loxodonta africana*) studied by infrared thermography

Nicole M. Weissenböck<sup>a,\*</sup>, Christoph M. Weiss<sup>b</sup>, Harald M. Schwammer<sup>c</sup>, Helmut Kratochvil<sup>d</sup>

<sup>a</sup> Research Institute of Wildlife Ecology, University of Veterinary Medicine Vienna, Savoyenstraße 1, 1160 Vienna, Austria

<sup>b</sup> Department of Systematic Anatomy, Medical University of Vienna, 1090 Vienna, Austria

<sup>c</sup> Vienna Zoo, 1130 Vienna, Austria

<sup>d</sup> Department of Evolutionary Biology, University of Vienna, 1010 Vienna, Austria

### ARTICLE INFO

#### Article history:

Received 6 October 2009

Accepted 23 March 2010

#### Keywords:

Thermal windows

Skin temperature

Infrared thermography

Elephants

*Loxodonta africana*

### ABSTRACT

In this study, we examined infrared thermograms in the course of time of six African zoo elephants and observed two phenomena. First, we noticed independent thermal windows, highly vascularised skin areas, on the whole elephants' body and second we observed distinct and sharply delimited hot sections on the elephants' pinnae. The frequency of thermal windows increased with increasing ambient temperature and body weight. We assume that the restriction of an enhanced cutaneous blood flow to thermal windows might enable the animal to react more flexibly to its needs with regard to heat loss. With this understanding, the use of thermal windows in heat loss might be seen as a fine-tuning mechanism under thermoneutral conditions.

© 2010 Elsevier Ltd. All rights reserved.

### 1. Introduction

In terms of heat regulation the largest terrestrial animal – the elephant – is a case in point. Owing to its enormous body mass, the small surface-to-volume ratio and the lack of sweat glands (Spearman, 1970; Hiley, 1975; Wright, 1984; Mariappa, 1986), elephants are confronted with unusual problems concerning heat dissipation and drying of the integument (Lillywhite and Stein, 1987). Control of skin temperature ( $T_s$ ) is an extremely important mechanism in elephants' temperature regulation (Phillips and Heath, 1995) and the most important thermoregulatory organs to use this pathway are the elephants' ears. The ears of the African elephant (*Loxodonta africana*) have a large surface-to-volume ratio as well as an extensive and prominent vascular supply, which predestines these organs for optimal heat dissipation (Wright, 1984). In conjunction with their great importance in thermoregulation, the ears are frequently termed “thermal windows” (Wright, 1984; Williams, 1990). Thermal windows are body areas responsible for heat exchange. This is achieved by modifying and controlling blood flow (via vasoconstriction and vasodilatation) into these areas (Šumbera et al., 2007). The term is also applied to appendages (Williams, 1990; Klir and Heath, 1992) or poorly haired surface regions like the shoulder, the area between the shanks, the eyes, nose, and mouth (Phillips, 1992; Hilsberg, 2000). Thermal windows are not only mentioned in

relation to body appendages and do not necessarily include entire organs. For example the trunk of pinnipeds can show thermal windows, which protects these animals for hyperthermia while on land, during exercise or in warmer waters (Krumbiegel, 1933; Øritsland, 1968). Mauck et al. (2003) underlined this from their observation of small and heavily vascularised hot spots on the bodies of harbor seals, harp seals, and gray seals. These independent thermal windows were suggested to facilitate heat dissipation via localized evaporation of water contained in the seal's pelage.

Infrared thermography has already been successfully used to measure  $T_s$  in several mammalian species (gerbils: Klir et al., 1988; foxes: Klir and Heath, 1992; bats: Webb et al., 1993; ratites: Phillips and Sanborn, 1994; guanacos: DeLamo et al., 1998; barn owls: McCafferty et al., 1998; seals: Mauck et al., 2003; eland and dairy cattle: Kotrba et al., 2007; mole rats: Šumbera et al., 2007), including elephants (Cena and Clark, 1973; Williams, 1990; Phillips and Heath, 1992; Hilsberg, 2000), and to visualise thermal windows on animal surfaces (seals: Mauck et al., 2003; toucans: Tattersall et al., 2009).

In preliminary examinations on African elephants (Weissenböck, 2006), we observed independent thermal windows on the whole elephant body, similar to those reported in seals (Mauck et al., 2003). We started a detailed study on elephants' thermal windows, which is described here. We used infrared thermography to visualise  $T_s$  of African elephants at different ambient temperatures ( $T_a$ ). We limited our observations to rather low  $T_a$ s ranging between  $-6.7$  and  $20.3$  °C. At higher  $T_a$ s we would have expected full vasodilatation and probably more homogenous  $T_s$

\* Corresponding author. Fax: +43 1 4890915 333.

E-mail address: nicole.weissenboeck@fwi.at (N.M. Weissenböck).

over the elephant's body, which would not have allowed observing the appearance and disappearance of thermal windows.

We analysed for the presence, chronological development, temperature, and shape of thermal windows on the ears and torso. Furthermore we stated the question, which factors might influence the presence of thermal windows. Therefore, we used statistical tests to verify the influence of  $T_a$ , elephants' age, and body weight.

## 2. Material and methods

### 2.1. Animal welfare conditions

The observations via infrared thermography focused on the elephant group at the Vienna Zoo, Austria.  $T_s$  of four adult female elephants (mean weight  $3215 \pm 315$  kg) and two juvenile elephants (one male, one female;  $977 \pm 496$  kg) were observed. The keepers had direct contact with the group for approximately 1.5 h per day. The elephants spent the night unchained in the indoor enclosure ( $2100 \text{ m}^2$ ) within the family and were released to their outdoor enclosure ( $4700 \text{ m}^2$ ) for approximately 4 h during the day. The elephants were fed with hay, branches, carrots and apples.

### 2.2. Data collection and observation procedure

$T_s$  was measured from 12:00 am to 16:30 pm for 11 days between December 2004 and February 2005. The elephants were observed in the following defined situations: (1) indoors, (2) outdoors, and (3) return to indoors.

Infrared images (thermograms) of the body surface were obtained by using a thermographic camera ThermoCAM P60 (FLIR Systems, Portland, OR, USA), with a  $24^\circ$  lens, automatic calibration and a  $7.5\text{--}13 \mu\text{m}$  spectral range.

To obtain correct values of  $T_s$  by compensating for the effects of different radiation sources the following parameters were supplied for the camera: emissivity of the subject (0.98 as recommended by the manufacturer), reflected temperature, distance between the subject and the camera, and air humidity (RH). In order to allow acclimatization, the thermograms were recorded after 15 min stay in the respective environment.  $T_a$  and RH were recorded by a temperature data logger (Gemini Data Loggers Ltd., Chichester, West Sussex, UK) every 20 min. All data loggers, protected by a perforated plastic housing, were placed away from direct sources of heat, sunlight and water, and mounted at a height of approximately 2 m from the ground in the indoor and outdoor enclosure. Special data logging software (Tinytag Explorer, Geminidataloggers Ltd., Chichester, West Sussex, UK) was applied for programming of the loggers and for data analysis.

The infrared pictures were taken at intervals of approximately 20 min in all animals.

The elephants were observed with the thermo-camera at a distance between 5 and 10 m in the indoor enclosure and at 10–30 m in the outdoor facility.

Animals were monitored from lateral sides. They were viewed perpendicularly, to avoid possible errors due to angle distortion. The recordings in the outdoor facility were done without direct exposure of the elephants to the sun, because the enclosure was shadowy during the observations.  $T_s$  was recorded while the animals were not subject to any restraint, separation or handling.

### 2.3. Analysis of thermograms

The analyses of the infrared images were done with the software ThermoCam<sup>TM</sup>Researcher (FLIR-Systems, Inc. Portland, OR, USA, 2002). In total, 325 thermograms were analysed.

#### 2.3.1. General aspects

$T_s$  of several defined body areas, namely head, proboscis, ear, torso, fore limb, and hind limb was measured. The defined body areas were circumscribed with polygons by hand. The software gave back the minimum, maximum, and mean  $T_s$  within the chosen parts of the images.  $T_s$  of tail and tusk were not included here.

#### 2.3.2. Definition and analysis of thermal windows

A thermal window, including both entire organs (ears) and small independent hot spots, on the animals' surface, was defined as a restricted area (minimum size: just visible as dot shaped hot spot in a thermogram) which differed by more than  $5.0^\circ\text{C}$  from its adjacent regions. Because of their specific appearance, we examined thermal windows of the elephant's ears and body separately. The surface area "ear" referred to the anterior pinna, and the surface area "body" included the elephant's torso and limbs. It was not possible to separate the torso and the limbs in the analysis because thermal windows are often widely spread and hence cannot be assigned solely to one of the respective body regions. The head and proboscis were excluded from thermographic analyses regarding thermal windows because small independent hot spots could not be clearly differentiated in these areas.

Identified thermal windows were circumscribed with polygons. Individual thermal windows were numbered (from cranial to caudal and ventral to dorsal and in order of their appearance) and their temperature changes were recorded in the course of time. To document the recurrence of thermal windows, we further partitioned each body part into three sections (ventral, middle, and dorsal section). We characterised previously neighboured thermal windows as fused, when there were no transit zones among them and they did not differ more than  $1.0^\circ\text{C}$  in mean  $T_s$ .

#### 2.4. Sizing of thermal windows on the pinnae

To determine the relative size of a thermal window and to observe its chronological development we used the software package ImageJ 1.36b (National Institutes of Health 2006, Bethesda, Maryland, USA). We framed the elephant's ear and thermal windows in it with polygons. The sizes of these polygons were returned by the software in pixel-values. Since contortions of the depicted thermal windows at the torso and the limbs were much higher, no sizing was carried out for these regions.

#### 2.5. Statistics

Values are given as means  $\pm$  SD, except when otherwise stated. Data were analysed with the statistical package R (R Development Core Team, 2009). To test for the influence of  $T_a$ , age, and body weight on  $T_s$ , we used linear mixed effect models (lme, library nlme; Pinheiro et al., 2009), with different intercepts for individual as a random effect in order to correct for repeated measurements. The significance of every fixed factor in the lme was assessed using an *F*-test. The "predictors" body weight and age had no significant effect on  $T_s$  (all  $P \geq 0.1$ ).

Furthermore, the effects of  $T_a$ , age and body weight of the elephants in the presence of thermal windows on the ear and the

body were investigated. In a second model, we examined if preceding cold exposure during outdoor stay had any effect on the presence of thermal windows after returning to the indoor enclosure. Therefore, we calculated the effects of mean  $T_a$  and the duration of elephants' stay in the outdoor enclosure. For both models we used a repeated measurements analysis, using a generalized linear mixed model (lmer) via Laplace method (library lme4; Bates and Maechler, 2009, random term="individual", family="binomial"). Our response variable was binary: 1 for the presence of thermal windows and 0 for the absence of thermal windows. The significance of every fixed factor in the lmer was assessed using the Wald's Z test (Bolker et al., 2008; Bates, personal communication in Crawley, 2007).

### 3. Results

#### 3.1. Skin temperature of different body areas

$T_s$  was higher on observation days with higher  $T_a$  (outdoors:  $F_{1,1921}=413.36$ ,  $P<0.001$ ; after returning indoors:  $F_{1,1694}=58.04$ ;  $P<0.001$ ) (Fig. 1).  $T_s$  decreased with minutes of observation outdoors ( $F_{1,1921}=534.78$ ;  $P<0.001$ ) and increased with minutes of observation after returning indoors ( $F_{1,1694}=1349.96$ ;  $P<0.001$ ).  $T_s$  differed between body parts (outdoors:  $F_{5,1921}=343.37$ ;  $P<0.001$ ; after returning indoors:  $F_{5,1694}=989.27$ ;  $P<0.001$ ), where the  $T_s$  of trunk was highest and  $T_s$  of ear was lowest (Fig. 2).

#### 3.2. Thermal windows

Thermal windows on the elephant's surface (ears and body) were observed in 43.9% of all observations and 51.6% of all detected thermal windows occurred indoors, 8.9% outdoors and

39.5% after returning indoors. A simultaneous presence of thermal windows on the ears and the body was observed only in 17.5% of all cases.

#### 3.2.1. Characteristics of thermal windows on the ears

Thermal windows on the ears occurred in 36.3% of all observations and were present in all animals. Indoors, 51.2% of all thermal windows of the ears were recorded; only 8.8% developed outdoors and 39.2% after returning indoors.

The thermal windows of the ears showed a time-dependent change in shape, size, and  $T_s$ . The first indication of the formation

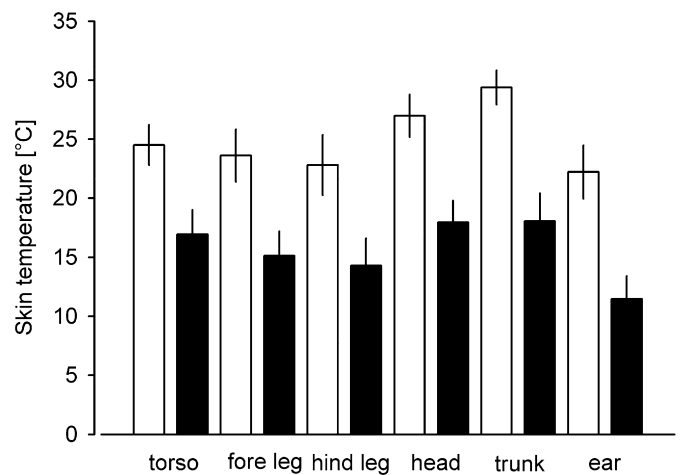

**Fig. 2.** Skin temperature ( $T_s$ ) (mean  $\pm$  SD) of the defined body parts, obtained from six African elephants. White bars indicate  $T_s$  taken at the indoor enclosure (ambient temperature ranged between 15.0 and 20.3 °C). Black bars indicate  $T_s$  taken at the outdoor enclosure (ambient temperature ranged between -4.1 and 7.5 °C). Measurements were obtained after a stay of at least 35 min and at the longest 90 min under the respective ambient temperature.

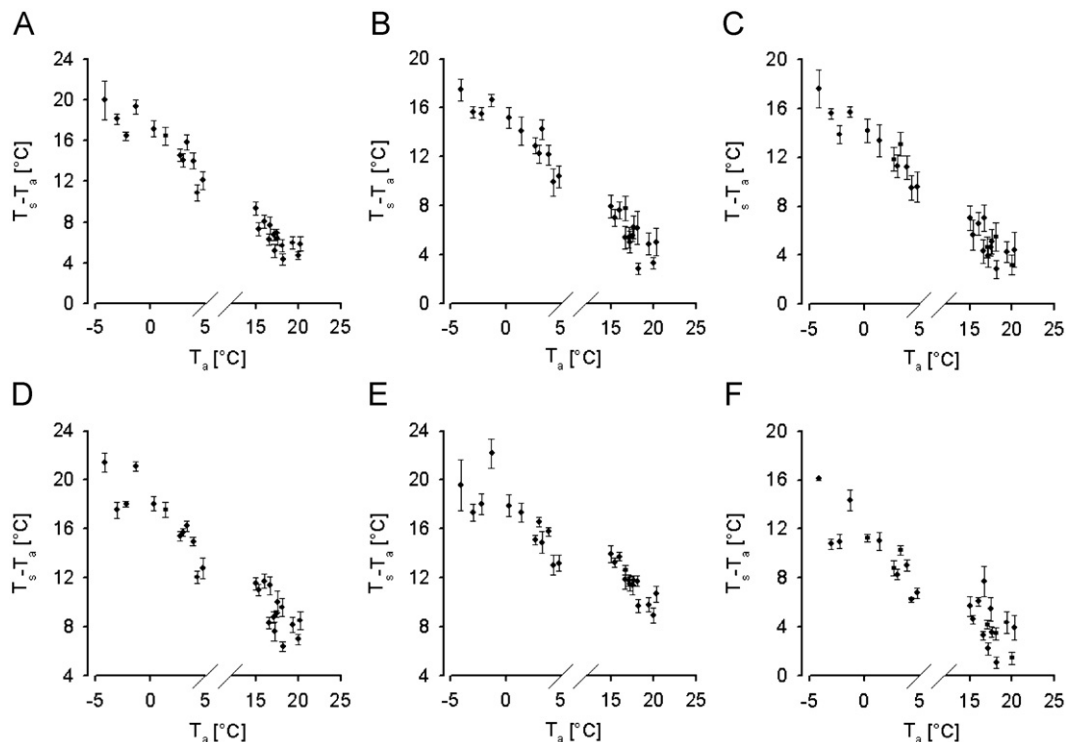
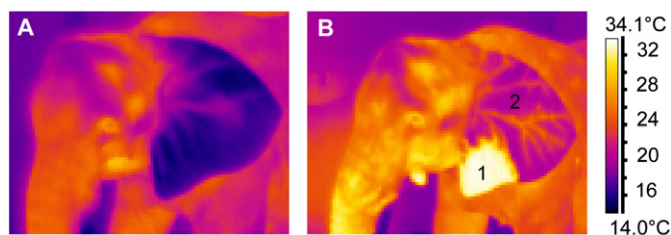

**Fig. 1.** Skin temperature ( $T_s$ ) (mean  $\pm$  SEM) obtained from six African elephants exposed to a range of ambient temperature ( $T_a$ ) (-4.1 to 20.3 °C), expressed as differential values ( $T_s - T_a$ ). Measurements were taken after a stay of at least 35 min and at the longest 90 min under the respective mean  $T_a$ . (A) Torso. (B) Fore leg. (C) Hind leg. (D) Head. (E) Trunk. (F) Pinna.

of a thermal window was the presence of the course of the vessels in the thermogram. Subsequently, an increase in  $T_s$  of distinct areas could be observed, whereby an initially dot-shaped hot spot expanded and soon covered a clearly limited sector of the pinna (Figs. 3 and 4). Such hot spots were only observed at the peripheral areas of the ears. As a result, thermal windows tended to expand from distal to proximal. Thermal windows were observed in all sections of the pinna (at the ear lobe as well as in distal parts) and could reach as far as the external auditory canal. Recurrence of thermal windows in the same sections of the

ear in different recording session was noticed. The opening of a hot spot did not imply presence of thermal windows on both pinnae of an elephant. In fact, both pinnae could show totally different temperature patterns at the same time, with thermal windows only present at one ear (Fig. 5).

In 57.9% of cases only one thermal window was observed per ear at one time; in 35.7% of the cases two (Fig. 5) and in 5.6% of cases three thermal windows were observed at the same time. Only once four thermal windows were present on an ear surface. On the pinnae, thermal windows possessed a remarkable local



**Fig. 3.** Successive thermograms of the left ear of the African elephant Drumbo, observed indoors at a mean ambient temperature ( $T_a$ ) of 19.5 °C. (A) 17 min after returning from the outdoor facility (outdoors:  $T_a=9.1$  °C). At this time point, an almost homogeneous temperature pattern of the elephant's ear is present. The course of the vessels is not visible (mean skin temperature:  $T_s=17.1$  °C). (B) 68 min after returning indoors. A thermal window has formed at the lobe of the ear and divides the surface into two areas of significantly different temperature distributions. The course of the vessels can now be recognized (area 1:  $T_s=33.0$  °C; area 2:  $T_s=22.2$  °C).

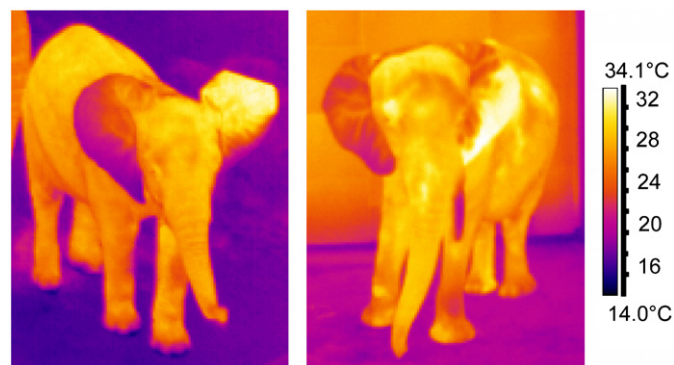

**Fig. 5.** Differences in the temperature pattern between both ear surfaces. Thermal windows at the pinnae appear sometimes disconcerting, as shown in these two thermographs recorded indoors (left: elephant cow Drumbo; right: elephant calf Mongu).

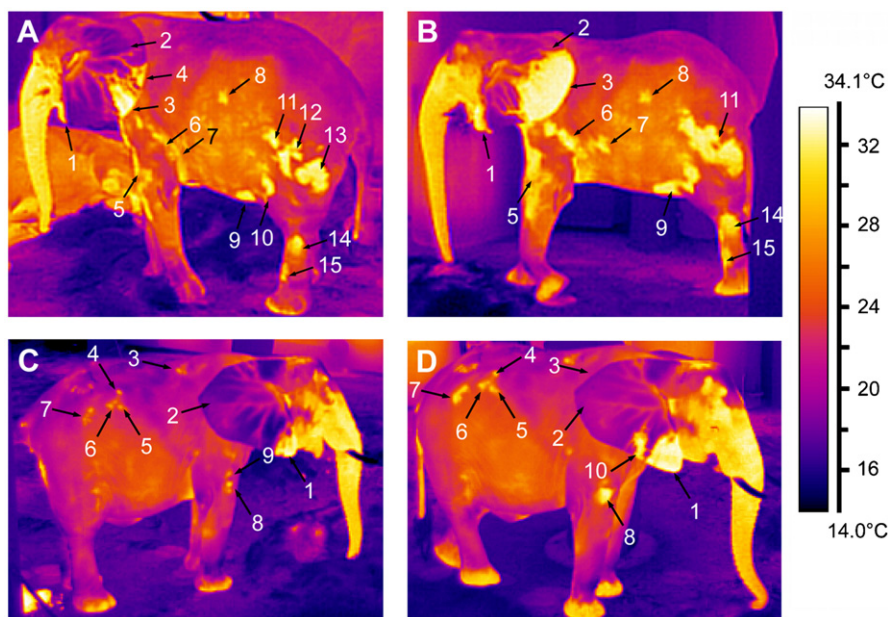

**Fig. 4.** Two pairs of successive thermograms of the body surface of two African elephants observed indoors. Numbers in (A) and (B) respectively (C) and (D) represent the same thermal windows. (A) Thermogram of the left body surface of the African elephant Sabi, observed indoors at a mean ambient temperature ( $T_a$ ) of 16.7 °C. IR-picture was taken 49 min after returning indoors (outdoors: mean  $T_a = -1.3$  °C). At the elephant's pinna, three thermal windows can be identified (area 1: mean skin temperature ( $T_s$ )=28.9 °C; area 2:  $T_s=20.4$  °C; area 3:  $T_s=31.7$  °C; area 4:  $T_s=28.9$  °C). Beside the pinna, multiple thermal windows appear on the torso and the limbs of the elephant (area 5:  $T_s=29.4$  °C; area 6:  $T_s=29.2$  °C; area 7:  $T_s=28.1$  °C; area 8:  $T_s=29.5$  °C; area 9:  $T_s=30.6$  °C; area 10:  $T_s=31.0$  °C; area 11:  $T_s=30.9$  °C; area 12:  $T_s=31.4$  °C; area 13:  $T_s=31.5$  °C; area 14:  $T_s=29.5$  °C; area 15:  $T_s=27.7$  °C). (B) 78 min after returning indoors. At this time point two thermal windows of the ear (area 3 and area 4) have fused and gained size. Several thermal windows on the torso have merged with each other. Temperature has increased in all thermal windows. (area 1:  $T_s=29.5$  °C; area 2:  $T_s=22.2$  °C; area 3:  $T_s=32.3$  °C, area 5:  $T_s=30.5$  °C; area 6:  $T_s=30.9$  °C; area 7:  $T_s=29.9.1$  °C; area 8:  $T_s=29.6$  °C; area 9:  $T_s=30.8$  °C; area 11:  $T_s=31.4$  °C; area 14:  $T_s=30.0$  °C; area 15:  $T_s=38.8$  °C). (C) Thermogram of the right body surface of the African elephant Tonga, observed at the indoor enclosure at  $T_a=16.7$  °C. 46 min after returning indoors (outdoor  $T_a = -1.3$  °C). One small thermal window at the lobe of the ear can be seen (area 1:  $T_s=30.7$  °C; area 2:  $T_s=19.2$  °C). Numerous thermal windows developed on the torso and right fore limb (area 3:  $T_s=25$  °C; area 4:  $T_s=25.1$  °C; area 5:  $T_s=24.6$  °C; area 6:  $T_s=25.6$  °C; area 7:  $T_s=25.7$  °C; area 8:  $T_s=26.0$  °C; area 9:  $T_s=27.2$  °C). (D) 78 min after returning indoors. At this time point, the original thermal window at the ear increased in size and a second thermal windows has developed (area 1:  $T_s=31.8$  °C; area 2:  $T_s=21.1$  °C; area 10:  $T_s=29.5$  °C). Thermal windows on the torso and the limbs have enlarged (note that area 9 merged with area 8) and appear warmer than in image A (area 4:  $T_s=26.7$  °C; area 5:  $T_s=27.4$  °C; area 6:  $T_s=27.6$  °C; area 7:  $T_s=28.4$  °C; area 8:  $T_s=29.7$  °C).

restriction whereby their margins were clearly formed by the course of a blood vessel. Fusion of neighbouring thermal windows was rarely observed at the pinnae.

The mean rate of increase in size of thermal window measured  $0.5 \pm 0.46\%$  of the total ear surface per minute. After thermal windows reached their maximum size, either they faded as a whole or gradually reduced in size (Fig. 4). The rate of decrease averaged  $0.22 \pm 0.2\%$  per minute. Thermal windows exceeding 50% of the total size of the anterior ear surface were observed in only 14.6% of all cases. Thermal windows took up between 3.7% and 41.9% of the total anterior surface of the pinna.

The mean  $T_s$  of thermal windows measured  $30.7 \pm 2.4$  °C. The mean difference in  $T_s$  between thermal windows and their adjacent regions measured  $9.5 \pm 2.4$  °C. The greatest documented difference was 14.6 °C. The mean  $T_s$  of the ear, with no thermal windows visible, measured  $20.1 \pm 1.1$  °C.

### 3.2.2. Characteristics of thermal windows on the body

Thermal windows on the body occurred in 25.1% of all observations. They were present in all observed elephants. A total of 58.1% of all recorded thermal windows on the body were observed indoors, 2.3% outdoors and 39.5% after returning indoors.

Thermal windows on the body surface of African elephants were separated from the surrounding areas by small, regular thermal transition zones whose temperatures declined towards the borders of the windows (Fig. 6). This was in contrast with the ears, where thermal windows showed distinct margins and no thermal transition zones.

Initially, thermal windows became visible in the thermograms as small, almost circular, areas (Fig. 4A and C). Before reaching their maximum size, thermal windows grew and often changed their shape, with the centres typically remaining stationary (Fig. 4B and D). In contrast with the ears, growing thermal windows often fused with neighbouring thermal windows. The originally circular shape therefore changed into a more irregular pattern.

Usually, fewer than five thermal windows were visible on one body side.

The initial location and growth pattern of thermal windows were compared between each recording session for each individual as well as between different individuals. Thermal windows never reappeared in the exact same pattern, location or size from one session to the next, but sometimes nearby. The preferred area of the thermal windows on the body was the

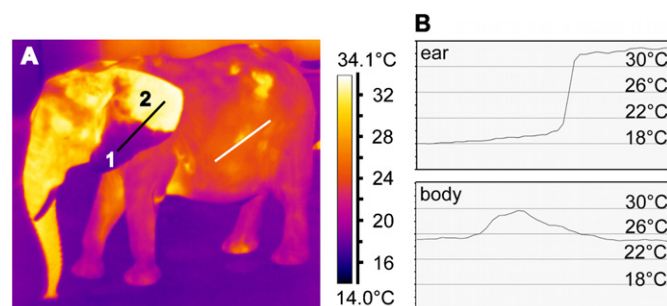

**Fig. 6.** Surface temperature profile of the African elephant Tonga observed indoors at a mean ambient temperature of 18.1 °C. (A) The thermogram shows a large homogeneous thermal window, which spans almost half of the elephant's pinna, is sharply separated from the cooler area of the ear (area 1: mean skin temperature ( $T_s$ )=20.6 °C; area 2:  $T_s$ =32.9 °C). (B) Temperature profiles of the ear and the body, indicated in (A) by lines. On the ear, the thermal window is delimited by an abrupt skip of temperature (top). In contrast, thermal windows of other body regions are surrounded by thermal transition zones whose temperatures decline towards their borders (bottom).

venter and the flanks, but they were also seen at the upper limbs and on the back.

### 3.2.3. Factors influencing the presence of thermal windows

The effect of  $T_a$  (ranged between 15.0 and 20.3 °C indoors and –6.7 to 9.1 °C outdoors) on the occurrence of thermal windows was found to be significant ( $z=7.42$ ,  $df=342$ ,  $P<0.001$ ). The presence of thermal windows was increasing with increasing  $T_a$ . Body weight had an effect on the presence of thermal windows as well ( $z=3.11$ ,  $df=342$ ,  $P=0.0018$ ). Elephants with higher body weight showed more often thermal windows on their body surfaces as elephants with lower body weight (juveniles). No effect of elephants' age on the presence of thermal windows was found ( $P>0.05$ ).

The occurrence of thermal windows after elephants returned to the indoor enclosure significantly depended on the mean  $T_a$  measured during their stay outdoors ( $z=2.91$ ,  $df=114$ ,  $P=0.0031$ ) and on the duration of cold exposure in the outdoor enclosure ( $z=-2.23$ ,  $df=114$ ,  $P=0.025$ ). The higher mean  $T_a$  and the shorter the stay in a cool environment, the more often thermal windows could be observed after the elephants returned to the indoor enclosure.

## 4. Discussion

Large body size is accompanied with an unfavourable surface-to-volume ratio, which constrains heat loss (Taylor, 1969). Large mammals living in hot habitats have therefore developed unique adaptations to improve heat transfer to the environment. Owing to an extensive vascular network of subcutaneous vessels, lying on the medial side of the ear cartilage (Sikes, 1971), combined with their high surface to volume ratio, the elephants' ears are such adaptations, which help in heat dissipation (Buss and Estes, 1971; McKay, 1973; Wright, 1984). Depending on  $T_a$ , heat can be dissipated through dilation of the ear vessels or conserved by constriction. Under rather hot climate conditions ( $T_a=32.1$  °C)  $T_s$  of the pinnae of African elephants is increased and ranges between 33.8 and 35.3 °C (Phillips and Heath, 1992), which suggests the complete recruitment of superficial vessels and underlines the role of the ears as a thermal window. At  $T_a$ s below 15 °C the ears were shown to be the coldest body part (Cena and Clark, 1973; Williams, 1990), which is confirmed by the present study as well. At  $T_a$  of  $18.9 \pm 1.5$  °C we measured a  $T_s$  of the pinnae of six African elephants of  $22.2 \pm 2.3$  °C. As a consequence of cold exposure (outdoors:  $T_a \leq 9.0$  °C), we observed a reduction in  $T_s$  of all body parts, particularly of the ears, leading to cutaneous vasoconstriction (Stocks et al., 2004). At low  $T_a$  outdoors we did not notice hot spots on the body surface; thus, thermal windows were "closed" to conserve metabolic heat. In fact, independent thermal windows were seen almost exclusively at  $T_a$  between 15.6 and 20.0 °C. We found that not merely the ear surface as a whole acts as a thermal window but rather single sections of the elephant's ear are also able to fulfil the same purpose. The local restriction of thermal windows partitioned the ear surface into sharply circumscribed areas of various temperatures, whereby the greatest documented temperature difference measured as much as 14.6 °C. In contrast with other body surfaces, a tendency of recurrence from session to session was found for specific regions on the ear surface. The characteristic appearance of thermal windows at the pinnae might indicate that the opening of thermal windows is induced by an increased arterial blood flow into specific segments of the ear. Thermal windows on the ears possessed a clear local restriction whereby their margins were formed by the course of a blood vessel. Comparing our thermograms with anatomic preparations (Feichtinger,

unpublished data) of African elephant's ears, we presume that the margins of the thermal windows of the pinnae are formed by veins.

It appears likely that elephants use a similar mechanism of separated sympathetic innervation of the ears as shown in rabbits (Roberts and Zygmunt, 1984). This implies that temperature of the ears can be controlled independently, and would explain our observation that both pinnae could show totally different temperature patterns at the same time, with thermal windows only present at one ear.

Apart from the elephant's ears, thermal windows were observed on the remaining body surface as well. In contrast with the pinnae, no clear pattern in their occurrence could be determined. They varied widely in number, position, size, and shape. Accordingly, thermal windows of the African elephant do not seem to be restricted to any specific anatomical area of the torso or limbs. The finding that thermal windows are not reduced to the ear surfaces is rather surprising. Unlike other hairless animals, the elephant was thought to increase blood flow to the skin almost exclusively on the ears, because only the ears have a significant network of blood vessels close enough to the surface (Spinage, 1994). The findings of thermal windows on the whole body surface indicate that the elephants' skin has more regional concentrations of vascular networks that have previously been appreciated. Furthermore, we found that the body weight is an influencing factor for the appearance of thermal windows. This might be explained best by the smaller surface to volume ratio in elephants of higher weight associated with the increase of the ability to control  $T_s$  with body size (Phillips and Heath, 1995).

We suggest that the thermoregulatory advantage of restricting thermal windows to relatively small areas might be seen in the context of maintaining thermal balance in thermoneutral conditions and the control of blood flow. It is well known that the vasomotor tone of skin in specialized heat exchangers (e.g., elephant ear, rabbit ear, rat tail) depends on the  $T_a$ . If skin vessels are constantly constricted, an animal is likely to be exposed to a low (subneutral)  $T_a$  (Romanovsky et al., 2002). This pertained to the elephants in our study when subjected to outdoor conditions ( $T_a \leq 9.0^\circ\text{C}$ ) and is in contrast to supraneutral conditions, where the vessels are constantly dilated as a consequence of high  $T_a$  (Romanovsky et al., 2002). Here we would expect thermal windows to be "fully opened", hence a more homogeneous  $T_s$  over the elephant's body surface and no local restricted hot spots. According to the definition of the thermal neutral zone (TZN) of an animal (IUPS, 2003) and based on our results we assume that our observations were conducted within the TZN of elephants (indoor conditions) and under subneutral conditions (outdoors). On the basis of several considerations it appears to be reasonable to restrict heat dissipation to relatively small but exceedingly warm skin areas. Such small regions might enable the animal to react more flexibly to its needs with regard to heat dissipation. Therefore, we assume that this local restriction of areas of high  $T_s$  might be seen as a fine-tuning mechanism in heat loss rather than a strategy of losing large amount of heat.

In addition to radiative pathways of heat dissipation, the relevance of evaporative heat loss via thermal windows has to be considered as well. Wild elephants bathe daily if they have access to water or, if not, their often coat their backs with mud (McKay, 1973; Poché, 1980; Nowak, 1999). The integument of elephants is highly sculptured with wrinkles and crevices, which promote water retention by the skin (Lillywhite and Stein, 1987). The elevation of  $T_s$  facilitates evaporation of water adsorbed on the highly sculptured elephant skin due to increased saturation vapour pressure.

Apart from heat radiation and evaporative cooling, convective heat loss is of particular importance in elephants. In association

with this, the rate of ear flapping in elephants increases as  $T_a$  rises (Buss and Estes, 1971; Spinage, 1994) and as a consequence forced convection is increasing. However, we did not observe ear flapping during our study, indicating that  $T_a$  was not high enough to cause ear flapping, which usually increases at  $T_a > 21^\circ\text{C}$  (Rowe, 1999). Hence, the lack of ear flapping is further indices that observed elephants did not exceed their upper critical temperature.

## 5. Conclusion

We used infrared thermography to study the presence and development of thermal windows on the body surface of six captive African elephants under different ambient temperatures. Small, independent thermal windows were abundant on the elephant ears as well as on the remaining body surface and seem to be an effective thermoregulatory mechanism. Owing to the circumstance that thermal windows were observed only under moderate temperate conditions, the contribution of heat dissipation via those hot spots may not be negligible but might rather be seen as a fine-tuning mechanism under thermal neutral conditions. Our observations clearly indicate that thermoregulatory processes via thermal windows of African elephants seem to be more developed and come into operation more often than generally assumed. Nevertheless, more research is needed to clearly understand their function and control.

## Acknowledgments

The authors thank Vienna Zoo for supplying the Infrared camera and for help with data collection at their elephant house. We thank Klaus Feichtinger from the Institute of Pathobiology of the University of Veterinary Medicine, Vienna, for providing information about the anatomy of the elephant's pinna.

## References

- Bates, D., Maechler, M., 2009. lme4: linear mixed-effects models using Eigen and Eigen. Version: 0.999375–31. <<http://cran.at.r-project.org>>.
- Bolker, B.M., Brooks, M.E., Clark, C.J., Geange, S.W., Poulsen, J.R., Stevens, M.H.H., White, J.S.S., 2008. Generalized linear mixed models: a practical guide for ecology and evolution. *Trends Ecol. Evol.* 24 (2), 127–135.
- Buss, I.O., Estes, J.A., 1971. The functional significance of movements and positions of the pinnae of the African elephant (*Loxodonta africana*). *J. Mammal.* 52, 21–27.
- Cena, K., Clark, J.A., 1973. Thermographic measurements of the surface temperature of animals. *J. Mammal.* 54, 1003–1007.
- Crawley, M.J., 2007. *The R Book*. John Wiley & Sons Ltd, The Atrium, Southern Gate, Chichester, West Sussex.
- DeLamo, D.A., Sanborn, A.F., Carrasco, C.A., Scott, D.J., 1998. Daily activity and behavioral thermoregulation of the guanaco (*Lama guanicoe*) in winter. *Can. J. Zool.* 76, 1388–1393.
- Hiley, P., 1975. How the elephant keeps its cool. *Nat. Hist.* 84, 34–40.
- Hilsberg, S., 2000. Aspekte zur klinischen Anwendung der Infrarot-Thermographie in der Zoo- und Wildtiermedizin. Ph.D. Dissertation, University of Leipzig, Faculty of Veterinary Medicine.
- IUPS Thermal Commission, 2003. Glossary of terms for thermal physiology. *J. Therm. Biol.* 28, 75–106.
- Klir, J.J., Heath, J.E., 1992. An infrared thermographic study of surface temperature in relation to external thermal stress in three species of foxes: the Red fox (*Vulpes vulpes*), Arctic fox (*Alopex lagopus*), and Kit fox (*Vulpes macrotis*). *Physiol. Zool.* 65 (5), 1011–1021.
- Klir, J.J., Heath, J.E., Bennani, N., 1988. An infrared thermographic study of surface temperature in relation to external thermal stress in the Mongolian gerbil, *Meriones unguiculatus*. *Comp. Biochem. Physiol.* 96 (1), 141–146.
- Kotrba, R., Knizkova, I., Kunc, P., Bartos, L., 2007. Comparison between the coat temperature of the eland and dairy cattle by infrared thermography. *J. Therm. Biol.* 32, 355–359.
- Krumbiegel, I., 1933. Untersuchungen über Körpergestalt und Wärmehaushalt der Säugetiere, besonders der aquatilen Formen. *Biol. Cbl.* 53, 123–148.
- Lillywhite, H.B., Stein, B.R., 1987. Surface sculpturing and water retention of elephant skin. *J. Zool.* London 211, 727–734.

- Mariappa, D., 1986. Anatomy and Histology of the Indian Elephant. Indira Publishing House, Oak Park.
- Mauck, B., Bilgmann, K., Jones, D.D., Eysel, U., Dehnhardt, G., 2003. Thermal windows on the trunk of hauled-out seals: hot spots for thermoregulatory evaporation? *J. Exp. Biol.* 206 1727–1738.
- McCafferty, D.J., Moncrieff, J.B., Taylor, J.R., Boddie, G.F., 1998. The use of IR thermography to measure the radiative temperature and heat loss of a barn owl (*Tyto alba*). *J. Therm. Biol.* 23 (5), 311–318.
- McKay, G.M., 1973. Behavior and ecology of the Asiatic elephant in South-Eastern Ceylon. *Smithson. Contrib. Zool.* 125, 1–113.
- Nowak, R.M., 1999. Walker's Mammals of the World, Vol. 2. The Johns Hopkins University Press, Baltimore.
- Øritsland, N.A., 1968. Variation in the body surface temperature of the harp seals. *Acta Physiol. Scand.* 73, 35A–36A.
- Phillips, P.K., 1992. Regulation of surface temperature in mammals. Ph.D. Thesis, University of Chicago: Urbana-Champaign.
- Phillips, P.K., Heath, J.E., 1992. Heat exchange by the pinna of the African elephant (*Loxodonta africana*). *Comp. Biochem. Physiol. A* 101 (4), 693–699.
- Phillips, P.K., Heath, J.E., 1995. Dependency of surface temperature regulation on the body size in terrestrial mammals. *J. Therm. Biol.* 20 (3), 281–289.
- Phillips, P.K., Sanborn, A.F., 1994. An infrared thermographic study of surface temperature in three raptives: ostrich, emu, and double-wattled cassowary. *J. Therm. Biol.* 19 (6), 423–430.
- Pinheiro, J., Bates, D., DebRoy, S., Sarkar, D., 2009. lme: linear and nonlinear mixed effects models. R Package Version 3, 1–92. <<http://www.R-project.org>>.
- Poché, R.M., 1980. Elephant management in Africa. *Wildl. Soc. Bull.* 8, 199–207.
- R Development Core Team, 2009. R: A Language and Environment for Statistical Computing. R Foundation for Statistical Computing, Vienna, Austria.
- Roberts, M.F., Zygmunt, A.C., 1984. Reflex and local thermal control of rabbit ear blood flow. *Am. J. Physiol.* 246, R979–R984.
- Romanovsky, A.A., Ivanov, A.I., Shimansky, Y.P., 2002. Ambient temperature for experiments in rats: a new method for determining the zone of thermal neutrality. *J. Appl. Physiol.* 92, 2667–2679.
- Rowe, M.F., 1999. Physiological responses of African elephants to a cold environment: how does the elephant keep its heat? MSc Thesis, Louisiana State University.
- Sikes, S.K., 1971. The Natural History of the African Elephant. Elsevier, New York.
- Spearman, R.I.C., 1970. The epidermis and its keratinisation in the African elephant (*Loxodonta africana*). *Zool. Afr.* 5, 327–338.
- Spinage, C.A., 1994. Elephants. T & AD Poyser Ltd., London.
- Stocks, J.M., Taylor, N.A.S., Tipton, M.J., Greenleaf, J.E., 2004. Human physiological responses to cold exposure. *Aviat. Space Environ. Med.* 75, 444–457.
- Šumbera, R., Zelová, J., Kunc, P., Knižková, I., Burda, H., 2007. Patterns of surface temperatures in two mole-rats (Bathyergidae) with different social systems as revealed by IR-thermography. *Physiol. Behav.* 92, 526–532.
- Tattersall, G.J., Andrade, D.V., Abe, A.G., 2009. Heat exchange from the toucanbill reveals a controllable vascular thermal radiator. *Science* 325, 468–470.
- Taylor, C.R., 1969. The Eland and the Oryx. *Sci. Am.* 220, 88–97.
- Webb, P.I., Speakman, J.R., Racey, P.A., 1993. The implication of small reductions in body temperature for radiant and convective heat loss in resting endothermic brown long-eared bats (*Plecotus auritus*). *J. Therm. Biol.* 18, 131–135.
- Weissenböck, N.M., 2006. Die Thermoregulation Afrikanischer Elefanten (*Loxodonta africana*) in Tiergartenhaltung. MSc Thesis, University of Vienna, Faculty of Life Sciences.
- Williams, T.M., 1990. Heat transfer in elephants: thermal partitioning based on skin temperature profiles. *J. Zool. London* 222, 235–245.
- Wright, P.G., 1984. Why do elephants flap their ears? *S. Afr. J. Zool.* 19 266–269.



## - CHAPTER V -

### **Estrous synchrony in a group of African elephants**

*Copy of the paper entitled "Estrous synchrony in a group of African elephants (Loxodonta africana) under human care" published in Animal Reproduction Science*



*This chapter aims to provide a clearer understanding of the relationship between core body temperature and the sexual cycle of elephants, discussed in chapter II. In this additional chapter I give basic information about the menstrual cycle of elephants and discuss an interesting case of estrous synchrony in African zoo elephants.*



Contents lists available at ScienceDirect

## Animal Reproduction Science

journal homepage: [www.elsevier.com/locate/anireprosci](http://www.elsevier.com/locate/anireprosci)

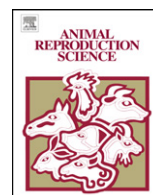

Short communication

### Estrous synchrony in a group of African elephants (*Loxodonta africana*) under human care

Nicole M. Weissenböck<sup>a,\*</sup>, Harald M. Schwammer<sup>b</sup>, Thomas Ruf<sup>a</sup>

<sup>a</sup> Research Institute of Wildlife Ecology, University of Veterinary Medicine Vienna, Savoyenstraße 1, 1160 Vienna, Austria

<sup>b</sup> Tiergarten Schönbrunn, Vienna Zoo, 1130 Vienna, Austria

#### ARTICLE INFO

##### Article history:

Received 19 February 2008

Received in revised form 12 June 2008

Accepted 1 July 2008

Available online 8 July 2008

##### Keywords:

African elephant

Progesterone

Estrous synchronization

#### ABSTRACT

Synchrony of estrous, and consequently of conception and birth of young, may be of adaptive significance for certain mammals. Among the species in which estrous synchrony has been suspected several times are elephants, but clear evidence is still missing. We determined estrous cycles of African elephants (*Loxodonta africana*) ( $n=4$ ) at the Vienna Zoo, Austria, between June 2003 and January 2006 by measuring serum progesterone levels from weekly blood samples. Except for the dominant female when she was intensively lactating, all animals showed clear cycles or progesterone release with a mean period of  $105.3 \pm 15.37$  days. For most of the study period, estrous cycles were asynchronous between females. However, after re-occurrence of the progesterone cycle in the dominant female following the first period of lactation, all four females showed high synchrony of progesterone release over the two subsequent cycles. Large changes in individual period lengths indicated that synchronization was due to the adjustment of cycle length in subdominants to that of the dominant female. We used a bootstrap procedure, based on resampling measured times of progesterone peaks, to determine if this apparent synchrony could have been caused by chance alone. This statistical analysis indicated that between-individual variances of the timing of progesterone peaks were much smaller than to be expected by chance ( $P=0.009$ ). This finding represents the first evidence for estrous synchrony between elephants. We discuss various hypotheses to explain the biological function of cycle synchrony in elephants.

© 2008 Elsevier B.V. All rights reserved.

\* Corresponding author. Tel.: +43 6 9919674 818; fax: +43 4890915 733.

E-mail address: [Nicole.Weissenboeck@fwi.at](mailto:Nicole.Weissenboeck@fwi.at) (N.M. Weissenböck).

## 1. Introduction

Estrous or ovarian synchrony has been reported in several mammalian species: e.g. humans (Weller et al., 1999) and chimpanzees (Wallis, 1985). In all reported cases, synchrony is thought to involve a process of synchronization or entrainment. Estrous synchrony can be defined as the tendency of individuals to undergo the fertile period of the sexual cycle at the same time as other members of the population (Matsumoto-Oda et al., 2007).

Critical reviews of the estrous synchrony studies in recent years have argued that synchrony may be a methodical and statistical artifact (Schank, 2001). However, McClintock (2000) conceded that ovarian cycle synchrony might be highly context dependent and the conditions under which it occurs are largely unknown.

Estrous synchrony has been suspected several times in elephants (e.g. Dublin, 1983; Poole, 1989; Rasmussen and Schulte, 1998; Slade et al., 2003) but evidence is still missing. Several facts concerning their reproduction and social system might indicate that elephants can benefit from cycling synchronously. Elephants have a long estrous cycle of 14–16 weeks (Brown, 2000, present study), but a relatively short receptive period of 2–10 days (Moss, 1983). Females signalize their receptive period through chemical, auditory and behavioral paths to attract males (Moss, 1983; Rasmussen et al., 1996). Because of the brief receptive period of females and their preference of large musth males (Rasmussen and Schulte, 1998), a single present dominant bull may inseminate several females in the same herd, if they are in estrous synchrony. Thus, cycling synchronously could be advantageous because it increases the probability of a common father, and hence close relatedness, of females in a group. This could result in enhanced cooperation and reciprocity (Axelrod and Hamilton, 1981). Another, but not mutually exclusive benefit of estrous synchrony could be that chemical signals from synchronized females may work cooperatively to attract more males from which to select a mate (Poole, 1989).

Based on unpublished observations Rasmussen and Schulte (1998) assumed that captive female elephants at the same facilities can show some degree of synchrony. Also, Bechert et al. (1999) found some indication for estrous synchrony between two pairs of captive African elephants. However, the authors concluded that apparent synchrony in estrous cycling was due to deficient data.

This study examines estrous synchrony in a group of African elephants at Vienna Zoo which has a long tradition in keeping elephants. In 1996 a centre of *ex situ* and *in situ* research on elephants was developed. The research program includes hormone monitoring, which is now a routine part of the elephant's husbandry. We demonstrate that estrous synchronization between the group members was initiated by the dominant female. Some possible biological functions for elephants cycling synchronously are discussed.

## 2. Materials and methods

### 2.1. Elephants and husbandry conditions

The estrous cycles of four adult female African elephants, Tonga (born 1986), Sabi (born 1985), Drumbo (born 1975) and Jumbo (born 1959) were determined via serum progesterone analyses. The females were kept together at Vienna Zoo, Austria, in a free contact system. Pambo, an adult bull (born 1992), was kept separately from the females. The group had the opportunity to direct physical contact with the bull in the outdoor enclosure through the bars. On 25 May 2003 Tonga gave birth to a female calf. In February 2005 the oldest, subordinate elephant Jumbo died because of cardiac insufficiency. Based on continuous behavioral observations since March 2003, a linear dominance hierarchy with Tonga as leader was established for the Vienna Zoo group (Gunhold et al., 2006).

### 2.2. Blood collection and hormone analyses

Serum progesterone levels were determined from June 2003 to January 2006. Blood samples were collected weekly in heparinized tubes from ear or leg veins of unanaesthetized elephants. The estrous cycle of each female was determined by measuring serum progesterone (pg/ml) via a competitive immunoassay (CIA) by chemiluminescence, using a Chiron ACS:180 (Bayer Industries, NY; formerly

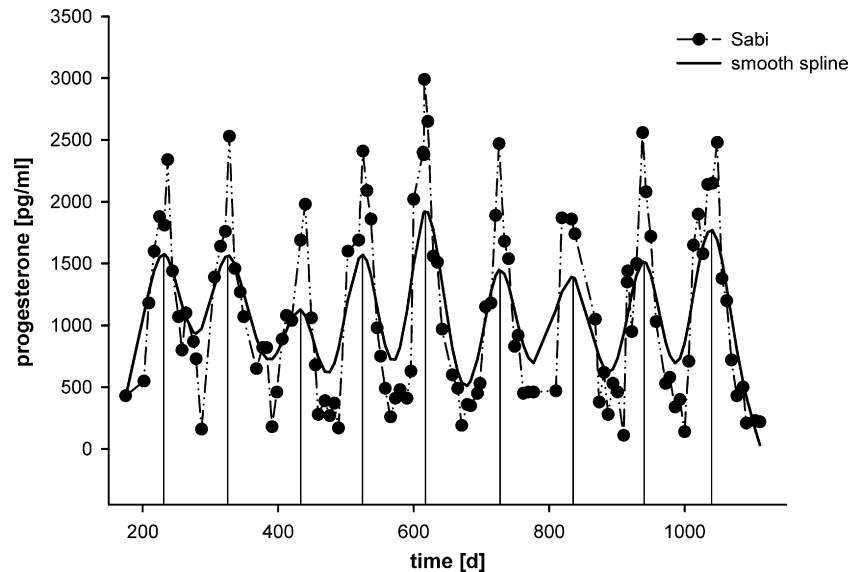

**Fig. 1.** Progesterone profile of the adult African elephant Sabi with fitted smooth splines for the determination of peaks in progesterone release. The x-axis shows consecutive days with 1 January 2003 set to day 1.

Chiron Diagnostics Corp.). This assay shows high specificity for progesterone. Cross-reactivities were observed with corticosterone (95%), pregnenolone (46%), 17  $\alpha$ -hydroxyprogesterone (31%) and 11-deoxycorticosterone (8%). The assay measures progesterone concentrations up to 60 ng/ml, with a minimum detectable concentration of 0.11 ng/ml.

### 2.3. Statistical analyses

Data were analyzed using the statistical package R (R Development Core Team, 2006).

To determine the peak-to-peak variation, and the degree of synchrony between animals, we fitted smooth splines to progesterone cycles (Fig. 1) measured in the interval prior to, during, and after the apparent synchronization of cycles (June 2003–January 2006). The timing of peaks in progesterone release was estimated from the maxima of these spline curves (Fig. 1), and cycle periods were calculated from the time difference between subsequent peaks. We deliberately fitted relatively smooth splines without secondary peaks and troughs, in order to unambiguously determine the time of maximum progesterone production per cycle. As a measure of synchrony between the females, we determined the variance of the times of peaks during all (8) 100-day intervals in this investigation period (Fig. 2). To see if the apparent synchrony of cycling at, and following the re-occurrence of progesterone cycle in the dominant female (Tonga) could have been caused by chance alone, we used a bootstrap procedure (Efron and Tibshirani, 1993). This procedure was based on constructing random pseudo-cycles of progesterone release for four “animals” starting at random times for each individual in the interval 1–100 days and using peak-to-peak periods that were randomly sampled (with replacement) from all empirically determined periods. During each of 10,000 runs of this procedure, we calculated the variance between peak times within 100 day intervals as an estimate of the purely coincidental degree of synchrony between individuals.

## 3. Results

The overall mean period of cycles in progesterone release – if present – was  $105.3 \pm 15.37$  days in the investigation period (June 2003–January 2006), with considerable variation both between and within the four females (means  $\pm$  S.D.:  $99.5 \pm 8.95$  days;  $112.5 \pm 25.89$  days;  $101.1 \pm 7.16$  days;  $114.2 \pm 19.45$

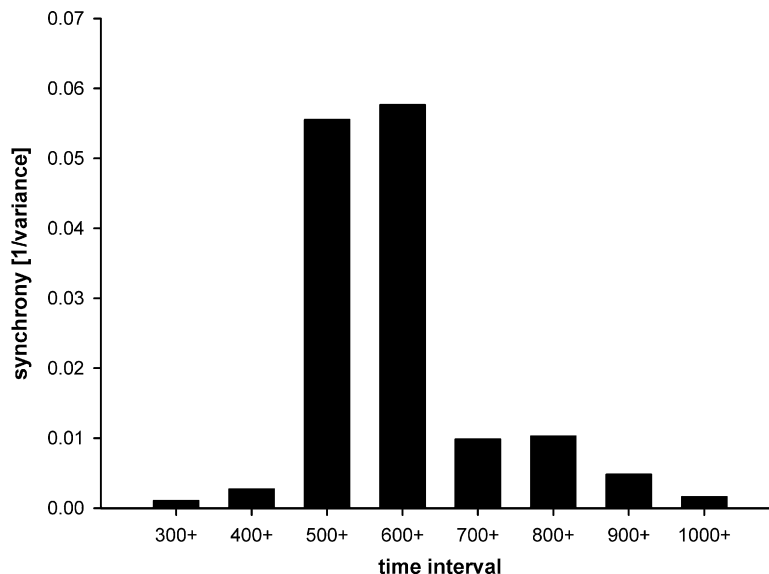

**Fig. 2.** Synchrony of the times of peaks in progesterone (1/between animal variance) among four adult African elephants in intervals of 100 days (between day 300 and day 1100 of the investigation period).

days). In the dominant female, the rhythm of progesterone re-appeared after confinement with an extremely long initial peak-to-peak period of 148 days (Fig. 3). Subsequently, all four animals showed highly synchronized peaks in progesterone release between days 518 and 524, as well as in the next interval, between days 607 and 615. Our bootstrap analysis indicated that this degree of synchronization was not coincidental. The average variances of random deviations between peak times was 833.4 (95% confidence interval: 46.5–2017.3). Thus, our observations of variances as low as 18.0 (days 518–524) and 17.3 (days 607–615) were much smaller than to be expected by chance ( $P=0.009$ ). This indicates active synchronization in the progesterone rhythms following the two cycles after the restoring of a rhythm in the dominant female. Thereafter, rhythms again desynchronized.

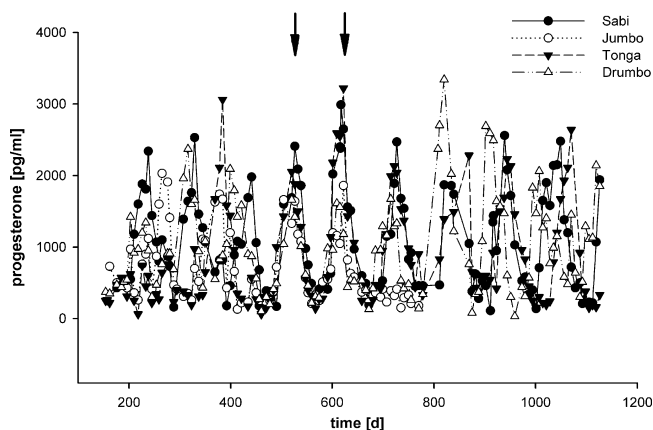

**Fig. 3.** Progesterone profiles of four adult African elephants between day 100 and day 1100. The x-axis shows consecutive days with 1 January 2003 set to day 1.

#### 4. Discussion

This paper provides the first evidence, based on hormonal data, for estrous synchrony in African elephants kept under human care. Our statistical analysis indicated that synchrony in progesterone cycles between four elephants was initiated by the re-occurring rhythm in the dominant female. The fact that estrous synchrony in elephants was not detected previously may be explained by the unavailability of long-term longitudinal studies of female cycles in a group. Elephants show a very long estrous cycle, and our finding of estrous synchrony was based on data collected continuously over more than 2 years.

The synchronization of estrous between the four African elephants at Vienna Zoo took place after a period characterized by pregnancy and lactation of the dominant female. Subsequently to Tonga's first estrous cycle after her delivery, the three other females showed strong adjustments of the length of their progesterone cycles resulting in strong synchrony for the next two cycles. This estrous synchrony was clearly triggered by the re-occurrence of a cycle in the dominant group member. Chemical signals, pheromones, might be the proximate cues responsible for this synchronization. Pheromones are known to play an important role in inter- and intrasexual communication associated with reproduction, and it has been suggested that one kind of pheromone, which chemical structure is presently unknown, is also involved in estrous synchronization (Rasmussen and Schulte, 1998).

Any possible ultimate function, i.e., selective advantage of estrous synchrony, evidently depends on the social system of the species in question. Asian and African elephants exhibit polygynous mating systems with female choice of mates and male–male competition for access to females (Poole, 1989). Adult males and females live in very different social systems. The sexes are highly independent except during periods of mating (Buss and Smith, 1966). Chemical signals from synchronized females work cooperatively to attract more males from which to select a mate (Poole, 1989).

Asian and African elephants exhibit a complex matriarchal social structure in the wild. Female groups are composed of related adults and their offspring, dominated by the matriarch, usually the eldest female (Sukumar, 1994). Communal care of offspring seems a central component of elephant groups (Schulte, 2000) and will be clearly intensified by simultaneous reproduction. This may advance reciprocity in caring for the offspring and ultimately lead to enhanced survivorship of young (Rasmussen and Schulte, 1998). A potentially important force behind allomothering is the opportunity for females to enhance their inclusive fitness through helping close relatives (Hamilton, 1964).

It is known that synchrony of births within free-living populations is common, although elephants breed throughout the year (Santapillai et al., 1984). The costs and benefits of breeding synchrony may, however, depend on environmental conditions. Successful reproduction in elephants requires adequate food, water, and shade during pregnancy and lactation (Douglas-Hamilton and Douglas-Hamilton, 1975). Dublin (1983) observed that a dominant African elephant cow gave birth earlier in the year than subdominant females, which could be the result of her greater access to resources. On the other hand, a recent study has shown that extreme climate events, resulting in both restricted or abundant resources, can lead to synchronized reproduction in the population (Wittemyer et al., 2007). This points to the need for further studies to understand the interaction between environmental resources and synchronized breeding in elephants.

In summary, our results indicate that estrous synchrony can occur in African elephants, and that synchronization involves the adjustment of cycle length in subdominant to that of the dominant female. The underlying biological function of synchronous cycling in elephants may involve both allomothering of young and improved mate choice due to enhanced chemical signaling, aimed at attracting more males.

#### Acknowledgements

The project was funded by the Vienna Zoo. We thank the elephant keepers and veterinary staff for their distinguished work with the animals. Special thanks go to the medical-diagnostic laboratory of Dr. Heinz Koppel for practical application of CIA and to Bayer Healthcare/Diagnostics, Vienna, Austria, for providing information about CIA. NW was supported by a DOC-ffORTE scholarship from the Austrian Academy of Science.

## References

- Axelrod, R., Hamilton, W.D., 1981. The evolution of cooperation. *Science* 211, 1390–1396.
- Bechert, U.S., Swanson, L., Wasser, S.K., Hess, D.L., Stormshak, F., 1999. Serum prolactin concentrations in captive female African elephant (*Loxodonta africana*): potential effects of season and steroid hormone interactions. *Gen. Comp. Endocrinol.* 114, 269–278.
- Brown, J.L., 2000. Reproductive endocrine monitoring of elephants: an essential tool for assisting captive management. *Zoo Biol.* 19, 347–367.
- Buss, I.O., Smith, N.S., 1966. Observations on reproduction and breeding behaviour of the African elephant. *J. Wildl. Manage.* 30, 375–388.
- Douglas-Hamilton, I., Douglas-Hamilton, O., 1975. *Among the Elephants*. Viking Press, New York.
- Dublin, H.T., 1983. Cooperation and reproductive competition among female African elephants. In: Wasser, S.K. (Ed.), *Social Behaviour of Female Vertebrates*. Academic Press, New York, pp. 291–313.
- Efron, B., Tibshirani, R., 1993. *An Introduction to the Bootstrap*. Chapman & Hall.
- Gunhold, T., Weissenböck, N.M., Schwammer, H.M., 2006. Die Dominanzhierarchie in der Herde Afrikanischer Elefanten (*Loxodonta africana*) im Tiergarten Schönbrunn. The dominance hierarchy of the herd of African elephants at the Schoenbrunn Zoo. *Zool. Garten* 76, 169–177.
- Hamilton, W.D., 1964. The genetical evolution of social behaviour I and II. *J. Theor. Biol.* 7, 1–16, and 17–52.
- Matsumoto-Oda, A., Hamai, M., Hayaki, H., Hosaka, K., Hunt, K.D., Kasuya, E., Kawanaka, K., Mitani, J.C., Takasaki, H., Takahata, Y., 2007. Estrus cycle asynchrony in wild female chimpanzees *Pan troglodytes schweinfurthii*. *Behav. Ecol. Sociobiol.* 61, 661–668.
- McClintock, M.K., 2000. Human pheromones: primers, releasers, or modulators? In: Wallen, K., Schneider, J.E. (Eds.), *Reproduction in Context*. The MIT Press, Cambridge, pp. 355–420.
- Moss, C.J., 1983. Oestrous behaviour and female choice in the African elephant. *Behaviour* 86, 167–196.
- Poole, J.H., 1989. Mate guarding, reproductive success and female choice in African elephants. *Anim. Behav.* 37, 842–849.
- R Development Core Team, 2006. *R: A Language and Environment for Statistical Computing*. R Foundation for Statistical Computing, Vienna, Austria, ISBN 3-900051-07-0, <http://www.R-project.org>.
- Rasmussen, L.E.L., Lee, T.D., Roelofs, W.L., Zhang, A., Daves Jr., G.D., 1996. Insect pheromone in elephants. *Nature* 379, 684.
- Rasmussen, L.E.L., Schulte, B.A., 1998. Chemical signals in the reproduction of Asian (*Elephas maximus*) and African (*Loxodonta africana*) elephants. *Anim. Reprod. Sci.* 53, 19–34.
- Santapillai, C., Chambers, M.R., Ishwaren, N., 1984. Aspects of the ecology of the Asian elephant *Elephas maximus* L. in the Ruhuna National Park, Sri Lanka. *Biol. Conserv.* 29, 47–61.
- Schank, J.C., 2001. Menstrual-cycle variability and measurement: further cause for doubt. *Psychoneuroendocrinology* 25, 837–847.
- Schulte, B.A., 2000. Social structure and helping behaviour in captive elephants. *Zoo Biol.* 19, 447–459.
- Slade, B.E., Schulte, B.A., Rasmussen, L.E.L., 2003. Oestrous state dynamics in chemical communication by captive female Asian elephants. *Anim. Behav.* 65, 813–819.
- Sukumar, R., 1994. *Elephants days and nights: ten years with the Indian elephant*. Oxford University Press, Delhi/Bombay/Calcutta/Madras.
- Wallis, J., 1985. Synchrony of swelling in captive group-living chimpanzees (*Pan troglodytes*). *Int. J. Primatol.* 6, 335–350.
- Weller, L., Weller, A., Roizman, S., 1999. Human menstrual synchrony in families and among close friends: examining the importance of mutual exposure. *J. Comp. Psychol.* 113, 261–268.
- Wittemyer, G., Rasmussen, H.B., Douglas-Hamilton, I., 2007. Breeding phenology in relation to NDVI variability in free-ranging African elephant. *Ecography* 30, 42–50.

## **- CHAPTER VI -**

### **General discussion**





Mammals and birds maintain a high body temperature that is independent of ambient temperature and typically regulated within a narrow range (Scholander et al., 1950; Irving and Krog, 1954). This is achieved by changes in endogenous heat production, evaporative cooling and thermal conductance in response to environmental conditions (Cossins and Bowler, 1987; McNab, 2002).

The term used for much of the last century describing the thermal strategy of mammals and birds was "homeothermy" (Willmer et al., 2005), implying regulation to a certain set point. It refers to the body temperature as a nonadaptive constant (Scholander et al., 1950). However, in recent decades researches have argued that natural selection has shaped the mean and variance of body temperature in endotherms (Hamilton, 1973; Heinrich, 1977). In fact, mammals and birds experience regional and temporal variations in body temperature and the physiological processes that maintain it vary extensively along environmental clines (Angilletta et al., in press). Every organism must undergo some regional heterothermy as a consequence of heat flux between the body core and external environment (Lovegrove et al., 1991). Furthermore, temporal heterothermy has been widely documented as daily or seasonal fluctuations in body temperature (Geiser, 1998), referred to as hypothermia, torpor, or hibernation (Geiser and Ruf, 1995).

In hot environments, the cost of getting rid of excess heat influences the energetic cost of thermoregulation more than the cost of heat production. This condition favours a decrease in the accuracy of thermoregulation. For example, Arabian oryx and Arabian sand gazelles allow their body temperature to fluctuate about twice as much when ambient temperature exceeds body temperature during summer days. These animals use adaptive heterothermy to minimize water consumption and energetic costs of thermoregulation (Ostrowski et al., 2003; Ostrowski and Williams, 2006). Until now it was assumed that adaptive heterothermy, as shown by desert ungulates, depends on an individual's state of hydration (Schmidt-Nielsen et al., 1956; Taylor, 1969; Ostrowski et al., 2003; Ostrowski and Williams, 2006). In other words, dehydrated animals tolerate higher maximal body temperatures during the day to reduce water requirements, but also lower body temperatures during the night in order to enter the day with a thermal reserve. The thermoregulatory strategy of elephants, however, neither fits into the classical, inflexible concept of homeothermy, nor does it correspond completely with the adaptive strategy of heterothermic desert ungulates.

Their huge body size, standing up to 4 m at the shoulder, and their enormous body weight of 3.5 to 7 tones (CITES, 2008) represent a metabolic and thermoregulatory challenge. For example a 4,000 kg elephant has a basal metabolic rate (BMR)\* of 2600 W. This is more than 30 times higher than in a 70 kg man (Fahlke et al., 2008).

\* BMR for a 4,000 kg elephant was calculated based on the BMR of Benedict's elephant Jab. Surface area was valued as 24 m<sup>2</sup> also according to Benedict (1936).

Unsurprisingly an elephant produces much more heat than a man, because metabolic heat production scales with body mass (McNab, 1983). Nevertheless, it is astonishing how elephants can deal with this large amount of heat given the extremely low surface area available for heat exchange with the environment in comparison to body mass. In particular, an elephant has to lose about 2.5 times as much heat per m<sup>2</sup> surface area as man\*. However, the elephant's body size can be of considerable advantage when exposed to the cold. Interestingly, early Pleistocene ancestors of modern elephants, the steppe mammoths (*Mammuthus trogontherii*), were of giant size and lived under cold and variable climate conditions. The steppe mammoth was the largest of all the mammoth species, standing 4.3 meters at the shoulder and weighing about 10 tons (Fuller, 2004). Consequently, the area available for heat loss would have been relatively low. In comparison, the woolly mammoth was no larger than a modern elephant. This prehistoric animal relied on insulation (fur and subcutaneous fat deposits) to prevent hypothermia under severe climates characteristic of its subarctic distribution (Kurtén, 2007).

However, what is the situation when climatic conditions challenge an elephant's thermoregulatory capabilities to the maximum limit in hot environments? In order to answer this question, I studied eleven adult Asian elephants in Thailand under climatic conditions typical of their natural habitat. Intestinal body temperature was measured with ingestible devices in five minute intervals during gut passages. Although the animals were exposed to a hot and humid climate, ambient temperatures never exceeded body temperature.

First of all, observed elephants showed a mean range of daily body temperature fluctuations of 1.3°C. This is remarkably higher than reported for African elephants (Kinahan et al., 2007a) and 2.6 times larger than expected from allometric scaling (Mortola and Lanthier, 2004). Further, the animals studied showed wider fluctuations in body temperature when daily maximum ambient temperatures were higher. This increase was caused by increasing peak body temperature, whereas the daily minimum body temperature was unaffected by ambient conditions. The overall correlation between body and ambient temperature was high but more pronounced during the day when body temperature was rising. During the day body temperature passively followed ambient temperature. However, after peak body temperature was reached shortly before sunset, elephants cooled down, to a certain degree actively as indicated by increased conductance, and the correlation between body and ambient temperature was low. To summarize, ambient temperature had a significant influence on the daily variations in body temperature indicating thermoregulatory flexibility in order to cope with constraints due to large body size. The animals exhibited adaptive heterothermy similar to desert ungulates, although ambient temperature never exceeded core body temperature and food and water was plentiful. However, in contrast to arid heterotherms (Ostrowski et al., 2003; Ostrowski and Williams, 2006), the study animals did not tolerate lower minimum body temperatures in order to enter the day with a thermal reserve. Based on calculations of ther-

mal conductance, I show that the study animals apparently actively prevented body temperature from falling below 35.5°C, which is considerably higher than in the heterothermic camel (34.2°C, Schmidt-Nielsen et al., 1956), eland (33.9°C, Taylor, 1969), and Arabian oryx (34.5°C, Ostrowski et al., 2003). This difference may again be explained by differences in body size. Apparently, the huge body mass of elephants provides sufficient capacity for heat storage during the day albeit avoiding hypothermia during night.

In conclusion, the results demonstrate that Asian elephants regularly apply heterothermy as an effective physiological mechanism to cope with the enormous heat load that is typical for their natural habitat and the thermoregulatory constraints due to large body size. Similar strategies may also exist in other large herbivores, like giraffes, rhinos and hippopotami. Therefore, thermoregulatory constraints may have set the upper limit in body size evolution and may well explain why elephants are the largest extant terrestrial creatures. This study furthermore contributes to the understanding of how elephants respond physiologically to their environment and may be crucial to conservation issues, as the Asian elephant is an endangered species with a decreasing population trend (IUCN, Red List of threatened species, 2009). The results highlight the importance of low nighttime ambient temperatures to balance daytime heat storage. As global warming renders Asia hotter (Hulme et al., 1994; Hulme and Viner 1998; IPCC 2007), this may pose another risk to an already threatened species.

## ACKNOWLEDGEMENTS

I would like to thank my companion Dr. Christoph Weiss for his intensive support. He spent three weeks of his holiday to assist me while data recording. He also helped me to burrow through mountains of elephant dung at the Munich Zoo Hellabrunn. Thank you for your support and understanding.

I thank my mother Christine Weissenböck for supporting me for all my life and for being my best friend.

I thank Univ. Prof. Dr. Walter Arnold for supervising me during my PhD. He agreed to mentor me despite my “exotic work” or just because of it?

I give a special thank to the mahouts from the Samphran Elephant Ground and Zoo in Thailand for their friendly help while data collection and Prof. Dr. Pantrep Ratanakorn from the Mahidol University, who permitted me to study their elephants.

I thank Vienna Zoo Tiergarten Schönbrunn for financially supporting the project and allowing me to study their elephants. I personally thank Dr. Harald Schwammer, vice director of the Vienna Zoo, and his assistant Sabine Frühwirth for supporting my work through all those years.

I thank Munich Zoo Hellabrunn for the permission to measure body temperature in their elephants and for accommodation; I also thank the elephant keepers for their assistance.

I thank Univ. Prof. Dr. Thomas Ruf from the Research Institute of Wildlife Ecology for the scientific and statistical advice.

Special thank goes to the “FIWI engineers” Dr. Franz Schober, Dipl. Ing. Gerhard Fluch, Ing. Thomas Paumann and Christian Schwarz for their important technical support.

I would like to thank my friends Mag. Karin Sardadvar and Dr. Teresa Valencak for their helpful suggestions on my PhD.

Further I want to thank Rebecca Drury for the absolutely essential grammar and spelling check.

Last but not least I thank the Austria Academy of Science for financial support during two years of my PhD.

## REFERENCES

- Angilletta, M.J. Jr., Cooper, B.S., Schuler, M.S., Boyles, J.G. The evolution of thermal physiology in endotherms. *Front. Biosci.* **15**, in press.
- Aschoff, J. 1982. The circadian rhythm of body temperature as a function of body size; in a Companion to Animal Physiology, C. R. Taylor, K. Johansen, L. Bolis, Eds. Cambridge University Press, Cambridge, London, New York, New Rochelle, Melbourne, Sydney, chap. 13.
- Axelrod, R., Hamilton, W.D. 1981. The evolution of cooperation. *Science* **211**, 1390–1396.
- Bates, D., Maechler, M., 2009. lme4: Linear mixed-effects models using Eigen and Eigenfaces. Version: 0.999375-31. <http://cran.at.r-project.org>
- Bechert, U.S., Swanson, L., Wasser, S.K., Hess, D.L., Stormshak, F. 1999. Serum prolactin concentrations in captive female African elephant (*Loxodonta africana*): potential effects of season and steroid hormone interactions. *Gen. Comp. Endocrinol.* **114**, 269–278.
- Benedict, F.G. 1936. The physiology of the elephant. Carnegie Institution, Washington.
- Blanc, J.J., Barnes, R.F.W., Craig, G.C., Dublin, H.T., Thouless, C.R., Douglas-Hamilton, I. 2007. African elephant status report 2007: an update from the African elephant database. IUCN, Gland, Switzerland.
- Bligh, J. 1973. Temperature regulation in mammals and other vertebrates. North-Holland Publishing Company, Amsterdam, London. American Elsevier, New York.
- Bolker, B.M., Brooks, M.E., Clark, C.J., Geange, S.W., Poulsen, J.R., Stevens, M.H.H., With, J.S.S. 2008. Generalized linear mixed models: a practical guide for ecology and evolution. *Trends Ecol. Evol.* **24**, 127-135.
- Bradley, S.R., Deavers, D. R. 1980. A re-examination of the relationship between thermal conductance and body weight in mammals. *Comp. Biochem. Physiol. (A)* **65**, 465-476.
- Brown, J.L. 2000. Reproductive endocrine monitoring of elephants: an essential tool for assisting captive management. *Zoo Biol.* **19**, 347–367.
- Brown-Brandl, T.M., Yanagi, Jr., T., Xin, H., Gates, R.S., Bucklin, R.A., Ross, G.S. 2003. A new telemetry system for measuring core body temperature in livestock and poultry. *Appl. Eng. Agric.* **19**, 583–589.
- Buss, I. O., Estes, J. A. 1971. The functional significance of movements and positions of the pinnae of the African elephant (*Loxodonta africana*). *J. Mammal.* **52**, 21-27.
- Buss, I.O., Smith, N.S. 1966. Observations on reproduction and breeding behaviour of the African elephant. *J. Wildl. Manage.* **30**, 375–388.
- Buss, I.O., Wallner, A. 1965. Body temperature of the African elephant. *J. Mammal.* **46**, 104-107.
- Cena, K., Clark, J. A. 1973. Thermographic measurements of the surface temperature of animals. *J. Mamm.* **54**, 1003-1007.
- Choudhury, A.U. 1999. Status and conservation of the Asian elephant *Elephas maximus* in northeastern India. *Mammal. Review* **29**, 141-173.
- CITES Convention on international trade in endangered species of wild flora and fauna, 2008. Appendix II *Loxodonta africana*. [http://www.cites.org/eng/resources/ID/fauna/Volume1/A-115.001.002.001%20Loxodonta%20africana\\_E.pdf](http://www.cites.org/eng/resources/ID/fauna/Volume1/A-115.001.002.001%20Loxodonta%20africana_E.pdf)
- Cooke, S., Hinch, S., Wikelski, M., Andrews, R., Kuchel, L., Wolcott, T., Butler, P. 2004. Bio-telemetry: a mechanistic approach to ecology. *Trends Ecol. Evol.* **19**, 334–343.
- Cossins, A.R., Bowler, K. 1987. Temperature biology of animals. Chapman & Hall, London.
- Crawley, M.J. 2007. The R book. John Wiley & Sons Ltd, The Atrium, Southern Gate, Chichester, West Sussex.

- Dawson, W.R. 1955. The relation of oxygen consumption to temperature in desert rodents. *J. Mammal.* **36**, 543–552.
- DeLamo, D.A., Sanborn, A.F., Carrasco, C.A., Scott, D.J. 1998. Daily activity and behavioral thermoregulation of the guanaco (*Lama guanicoe*) in winter. *Can. J. Zool.* **76**, 1388-1393.
- Douglas-Hamilton, I., Douglas-Hamilton, O. 1975. *Among the Elephants*. Viking Press, New York.
- Dublin, H.T. 1983. Cooperation and reproductive competition among female African elephants. In: *Social Behaviour of Female Vertebrates*, S.K. Wasser Ed. Academic Press, New York, pp. 291–313.
- Efron, B., Tibshirani, R. 1993. *An Introduction to the Bootstrap*. Chapman & Hall.
- Elder, W., Rodgers, D. 1975. Body temperature in African elephant as related to ambient temperature. *Mammalia* **39**, 395-399.
- Fahlke, C., Linke, W., Raßler, B., Wiesner, R. 2008. *Taschenatlas Physiologie*. Elsevier GmbH, München.
- Fuller, E. 2004. *Mammoths: giants of Ice Age*. Bunker Hill Publishing Inc., Charlestown.
- Fuller, A., Kamerman, P., Maloney, S., Matthee, A., Mitchell, G., Mitchell, D. 2005. A year in the thermal life of a free-ranging herd of springbok (*Antidorcas marsupials*). *J. Exp. Biol.* **208**, 2855-2864.
- Fuller, A., Moss, D.G., Skinner, J.D., Jessen, P.T., Mitchell, G., Mitchell, D. 1999. Brain, abdominal and arterial blood temperatures of free-ranging eland in their natural habitat. *Eur. J. Physiol.* **438**, 671-680.
- Gebremedhin, K.G., Wu, B. 2002. Simulation of sensible and latent heat losses from wet-skin surface and fur layer. *J. Therm. Biol.* **27**, 291-297.
- Geiser, F. 1998. Evolution of daily torpor and hibernation in birds and mammals: importance of body size. *Clin. Exp. Pharmacol. P.* **25**, 736-739.
- Geiser, F., Ruf, T. 1995. Hibernation versus daily torpor in mammals and birds: physiological variables and classification of torpor patterns. *Physiol. Zool.* **68**, 935-966.
- Green, A.R., Gates R.S., Lawrence L.M. 2005. Measurement of horse core body temperature. *J. Therm. Biol.* **30**, 370-377.
- Grenot, C.J. 1992. Ecophysiological characteristics of large herbivorous mammals in arid Africa and the Middle East. *J. Arid Environ.* **23**, 125-155.
- Gunhold, T., Weissenböck, N.M., Schwammer, H.M. 2006. Die Dominanzhierarchie in der Herde Afrikanischer Elefanten (*Loxodonta africana*) im Tiergarten Schönbrunn. The dominance hierarchy of the herd of African elephants at the Schoenbrunn Zoo. *Zool. Garten* **76**, 169-177.
- Guy, P.R. 1976. Diurnal activity patterns of elephant in the Sengwa Area, Rhodesia. *E. Afr. Wildl. J.* **14**, 285-295.
- Hamilton, W.D. 1964. The genetical evolution of social behaviour I and II. *J. Theor. Biol.* **7**, 1-16, and 17-52.
- Haynes, G. 1991. *Mammoths, mastodonts and elephants: biology, behaviour, and the fossil record*. Cambridge University Press, Cambridge, New York, Melbourne.
- Hidden, P.A. 2009. *Thermoregulation in African elephants (Loxodonta africana)* MSc thesis, University of Witwatersrand, Johannesburg.
- Hiley, P. 1975. How the elephant keeps its cool. *Nat. Hist.* **84**, 34-40.
- Hilsberg, S. 2000. *Aspekte zur klinischen Anwendung der Infrarot-Thermographie in der Zoo- und Wildtiermedizin*. PhD dissertation. University of Leipzig, Faculty of Veterinary Medicine.
- Hulme, M., Viner, D. 1998. A climate change scenario for the Tropics. *Clim. Change* **39**, 145-176.

- Hulme, M. Zhao, Z. Jiang, T. 1994. Recent and future climate change in East Asia. *Int. J. Climatol.* **14**, 637-658.
- Ingram, D.L., Mount, L.E. 1975. *Man and animals in hot environments*. Springer-Verlag, Berlin.
- IPCC 2007. *Climate Change 2007: The Physical Science Basis*. Contribution of Working Group I to the Fourth Assessment Report of the Intergovernmental Panel on Climate Change (eds. S. Solomon, D. Qin, M. Manning, Z. Chen, M. Marquis, K.B. Averyt, M. Tignor, and H.M. Miller) Cambridge University Press, Cambridge, New York.
- Irving L., Krog, J. 1954. Body temperatures of arctic and subarctic birds and mammals. *J. Appl. Physiol.* **6**, 667-680.
- IUCN. 2009. *Red List of threatened species*. IUCN, Gland, Switzerland.
- IUPS Thermal Commission. 2003. Glossary of terms for thermal physiology. *J. Therm. Biol.* **28**, 75-106.
- Katugaha, H.I.E., de Silva, M., Santiapillai, C. 1999. A long-term study on the dynamics of the elephant (*Elephas maximus*) population in Ruhuna National Park, Sri Lanka. *Biol. Conserv.* **89**, 51-59.
- Kinahan, A.A., Inge-moller, R., Bateman, P.W., Kotze, A., Scantlebury, M. 2007a. Body temperature daily rhythm adaptations in African savanna elephants (*Loxodonta africana*). *Physiol. Behav.* **92**, 560-565.
- Kinahan, A.A.; Pimm, S.L.; van Aarde, R.J. 2007b. Ambient temperature as a determinant of landscape use in the African elephant *Loxodonta africana*. *J. Therm. Biol.* **32**, 47–58.
- Klir, J. J., Heath, J. E. 1992. An infrared thermographic study of surface temperature in relation to external thermal stress in three species of foxes: the Red fox (*Vulpes vulpes*), Arctic fox (*Alopex lagopus*), and Kit fox (*Vulpes macrotis*). *Physiol. Zool.* **65**, 1011-1021.
- Klir, J.J., Heath, J.E., Bennani, N. 1988. An infrared thermographic study of surface temperature in relation to external thermal stress in the Mongolian gerbil, *Meriones unguiculatus*. *Comp. Biochem. Physiol.* **96**, 141-146.
- Kotrba, R., Knizkova, I., Kunc, P., Bartos, L. 2007. Comparison between the coat temperature of the eland and dairy cattle by infrared thermography. *J. Therm. Biol.* **32**, 355-359.
- Krumbiegel, I. 1933. Untersuchungen über Körpergestalt und Wärmehaushalt der Säugetiere, besonders der aquatilen Formen. *Biol. Cbl.* **53**, 123-148.
- Kurt, F. 2005. Size, weight and age criteria in Asian elephants. First European Elephant Management School November 2005. <http://www.colyerinstitute.org/pdf/feems3.pdf>
- Kurtén, B. 2007. *Pleistocene mammals of Europe*. Aldine Transaction Publishing, New Brunswick, London.
- Kusuda, S., Wakimoto, T., Sato, T., Nishimura, K., Kawakami, S., Okuda, K., Saito, E., Shimada, T., Sakamoto, H., Yanagimoto, H., Wada, S., Nishio, K., Fuji, H., Suzuki, T., Hashikawa, H., Kusokoki, H., Doi, O. 2007. Relationship between body temperature and ovarian cycle in Asian and African elephant. *J. Reprod. Develp.* **53**, 1099-1105.
- Langman, V. A., Roberts, T.J., Black, J., Maloiy, G.M.O., Heglund, N.C., Weber, J.-M., Kram, R., Taylor, C.R. 1995. Moving cheaply: energetics of walking in the African elephant. *J. Exp. Biol.* **198**, 629-632.
- Le Houérou, H. N. 2009. *Bioclimatology and biogeography of Africa*. Springer, Berlin, Heidelberg.
- Lillywhite, H. B., Stein, B. R. 1987. Surface sculpturing and water retention of elephant skin. *J. Zool., Lond.* **211**, 727-734.
- Louw, G.N., Seely, M.K. 1982. *Ecology of desert organisms*. Longman, London and New York.
- Lovegrove, B. G., Heldmaier, G., Ruf, T. 1991. Perspectives of endothermy revisited: the endothermic temperature range. *J. Therm. Biol.* **16**, 185-197.

- Maloney, S.K., Fuller, A., Mitchell, G., Mitchell, D. 2002. Brain and arterial blood temperatures of free-ranging oryx (*Oryx gazella*). *Eur. J. Physiol.* **443**, 437-445.
- Mariappa, D. 1986. Anatomy and histology of the Indian elephant. Indira Publishing House, Oak Park.
- Matsumoto-Oda, A., Hamai, M., Hayaki, H., Hosaka, K., Hunt, K.D., Kasuya, E., Kawanaka, K., Mitani, J.C., Takasaki, H., Takahata, Y. 2007. Estrus cycle asynchrony in wild female chimpanzees (*Pan troglodytes schweinfurthii*). *Behav. Ecol. Sociobiol.* **61**, 661-668.
- Mauck, B., Bilgmann, K., Jones, D. D., Eysel, U., Dehnhardt, G. 2003. Thermal windows on the trunk of hauled-out seals: hot spots for thermoregulatory evaporation? *J. Exp. Biol.* **206**, 1727-1738.
- McCafferty, D.J., Moncrieff, J.B., Taylor, J.R., Boddie, G.F. 1998. The use of IR thermography to measure the radiative temperature and heat loss of a barn owl (*Tyto alba*). *J. Therm. Biol.* **23**, 311-318.
- McClintock, M.K. 2000. Human pheromones: primers, releasers, or modulators? In: Wallen, K., Schneider, J.E. (Eds.), *Reproduction in Context*. The MIT Press, Cambridge, pp. 355-420.
- McConnell, M.B. 1998. Mini-Mitter research and transrectal ultrasonography at the Toledo Zoo. *J. Elephant Manag. Assoc.* **9**, 111-118.
- McKay, G.M. 1973. Behavior and Ecology of the Asiatic elephant in South-eastern Ceylon. *Smithson. Contr. Zool.* **125**, 1-113.
- McNab, B.K. 1983. Energetics, body size and the limits to endothermy. *J. Zool.* **199**, 1-29.
- McNab, B.K. 2002. *The Physiological Ecology of Vertebrates: A View from Energetics*. Comstock, Ithaca, New York.
- Mitchell, D., Maloney, S. K., Laburn, H. P., Knight, M. H., Jessen, C. 1997. Activity, blood temperature and brain temperature of free-ranging springbok. *J. Comp. Physiol. (B)* **167**, 335-343.
- Mitchell, D., Maloney, S.K., Jessen, C., Laburn, H.P., Kamerman, P.R., Mitchell, G., Fuller, A. 2002. Adaptive heterothermy and selective brain cooling in arid-zone mammals. *Comp. Biochem. Physiol. (B)* **131**, 571-585.
- Mitchell, G., Skinner, J. D. 1993. How the giraffe adapt to their extraordinary shape. *Trans. Roy. Soc. S. Afr.* **48**, 207-218.
- Morrison, P. 1960. Some interrelations between weight and hibernation function. *Bull. Mus. Comp. Zool.* **124**, 75-91.
- Mortola, J. P., Lanthier, C. 2004. Scaling the amplitudes of the circadian pattern of resting oxygen consumption, body temperature and heart rate in mammals. *Comp. Biochem. Physiol. (A)* **139**, 83-95.
- Moss, C.J. 1983. Oestrous behaviour and female choice in the African elephant. *Behaviour* **86**, 167-196.
- Muggeo, V. M. R. 2008. segmented: Segmented relationships in regression models. R package version 0.2-4. <http://www.R-project.org>.
- National research council. 1971. *A guide to environmental research on animals*. National Academy of Sciences, Washington D.C.
- Neville, C., Friend, T. 2003. The behaviour of circus tigers during transport. *Appl. Anim. Behav. Sci.* **82**, 329-337.
- Nowak, R.M. 1999. *Walker's mammals of the world, Volume 2*. The Johns Hopkins University Press, Baltimore.
- Oliver, J. E. 2005. *Encyclopedia of world climatology*. Springer, Dordrecht, Berlin, Heidelberg, New York.
- Øritsland, N. A. 1968. Variation in the body surface temperature of the harp seals. *Acta Physiol. Scand.* **73**, 35A-36A.



- Ostrowski, S., Williams, J.B., Ismael, K. 2003. Heterothermy and the water economy of free-living Arabian oryx (*Oryx leucoryx*). *J. Exp. Biol.* **206**, 1471-1478.
- Ostrowski, S., Williams, J.B. 2006. Heterothermy of free-living Arabian sand gazelles (*Gazella subgutturosa marica*) in desert environment. *J. Exp. Biol.* **209**, 1421-1429.
- Owen-Smith, R.N. 1988. Megaherbivores. The influence of very large body size on ecology. Cambridge University Press, Cambridge, New York, Victoria.
- Parker, K., Robbins, C. 1985. Thermoregulation in ungulates. In: Bioenergetics of wild herbivores. Eds. Hudson, R., White, R. CRC Press, Inc., Boca Raton, Florida, pp. 161-182.
- Phillips, P. K. 1992. Regulation of surface temperature in mammals. Ph.D. thesis. University of Chicago: Urbana-Champaign.
- Phillips, P. K., Heath, J. E. 1992. Heat exchange by the pinna of the African elephant (*Loxodonta africana*). *Comp. Biochem. Physiol. (A)* **101**, 693-699.
- Phillips, P. K., Heath, J. E. 1995. Dependency of surface temperature regulation on the body size in terrestrial mammals. *J. Therm. Biol.* **20**, 281-289.
- Phillips, P.K., Sanborn, A.F. 1994. An infrared thermographic study of surface temperature in three ratites: ostrich, emu, and double-wattled cassowary. *J. Therm. Biol.* **19**, 423-430.
- Piccione, G., Caola, G., Mortola, J.P. 2005. Scaling the daily oscillations of breathing frequency and skin temperature in mammals. *Comp. Biochem. Physiol. (A)* **140**, 477-486.
- Pinheiro, J., Bates, D. DebRoy S., Sarkar, D. 2009. lme: Linear and nonlinear mixed effects models. R package version 3.1-92. <http://www.R-project.org>.
- Poché, R.M. 1980. Elephant management in Africa. *Wildlife Soc. Bull.* **8**, 199-207.
- Poole, J.H. 1989. Mate guarding, reproductive success and female choice in African elephants. *Anim. Behav.* **37**, 842-849.
- Prendiville, D.J., Lowe, J., Earley, B., Spahr, C., Kettlewell, P. 2002. Radiotelemetry systems for measuring body temperature. Beef Production Series 57, Grange Research Centre Dunsany Co. Meath.
- R Development Core Team, 2006. R: A Language and Environment for Statistical Computing. R Foundation for Statistical Computing, Vienna, Austria, ISBN 3-900051-07-0, <http://www.R-project.org>.
- R Development Core Team. 2009. R: A language and environment for statistical computing. R Foundation for Statistical Computing, Vienna, Austria. <http://www.R-project.org>.
- Rasmussen, L.E.L., Lee, T.D., Roelofs, W.L., Zhang, A., Daves Jr., G.D. 1996. Insect pheromone in elephants. *Nature* **379**, 684.
- Rasmussen, L.E.L., Schulte, B.A. 1998. Chemical signals in the reproduction of Asian (*Elephas maximus*) and African (*Loxodonta africana*) elephants. *Anim. Reprod. Sci.* **53**, 19-34.
- Rebhuhn, W.C. 1995. Diseases of Dairy Cattle. Williams & Wilkins, Baltimore.
- Roberts, M. F., Zygmunt, A. C. 1984. Reflex and local thermal control of rabbit ear blood flow. *Am. J. Physiol.* **246**, R979-R984.
- Robertshaw, D. 2006. Mechanisms of the control of respiratory evaporative heat loss in panting animals. *J. Appl. Physiol.* **101**, 664-668.
- Roca A.L., Georgiadis, N., Pecon-Slattery, J., O'Brien, S.I. 2001. Genetic Evidence of Two Species of Elephant in Africa. *Science* **293**, 1473-1477.

- Romanovsky, A.A., Ivanov, A.I., Shimansky, Y.P. 2002. Ambient temperature for experiments in rats: a new method for determining the zone of thermal neutrality. *J. Appl. Physiol.* **92**, 2667-2679.
- Rowe, M.F. 1999. Physiological responses of African elephants to a cold environment: How does the elephant keep its heat? McS thesis, Louisiana State University.
- Ruf, T. 1992. Torpor beim Dsungarischen Zwerghamster (*Phodopus sungorus*) und der Hirschmaus (*Peromyscus maniculatus*): Saisonalität, Tagesperiodik und Energetik. Philipps University, Marburg, pp 1-190.
- Santapillai, C., Chambers, M.R., Ishwaren, N. 1984. Aspects of the ecology of the Asian elephant (*Elephas maximus*) L. in the Ruhuna National Park, Sri Lanka. *Biol. Conserv.* **29**, 47-61.
- Schank, J.C. 2001. Menstrual-cycle variability and measurement: further cause for doubt. *Psychoneuroendocrinology* **25**, 837-847.
- Scholander, P.F., Walters, V., Hock, R., Irving, L. 1950a. Body insulation of some arctic and tropical mammals and birds. *Biol Bull.* **99**, 225-236.
- Scholander, P.F., Hock, R., Walters, V., Johnson, F., Irving, L. 1950b. Heat regulation in some arctic and tropical mammals and birds. *Biol Bull.* **99**, 237-258.
- Scholander, P.F., Hock, R., Walters, V., Irving, L. 1950c. Adaptations to cold in arctic and tropical mammals and birds in relation to body temperature, insulation, and basal metabolic rate. *Biol Bull.* **99**, 259-271.
- Schmidt-Nielsen, K. 1984. *Scaling: why is animal size so important?* Cambridge University Press, Cambridge.
- Schmidt-Nielsen, K. 1997. *Animal physiology: Adaptation and environment.* Fifth edition. Cambridge University Press, Cambridge, New York, Melbourne, Madrid, Cape Town.
- Schmidt-Nielsen, K., Schmidt-Nielsen, B., Jarnum, S.A., Houpt, T.R. 1956. Body temperature of the camel and its relation to water economy. *Am. J. Physiol.* **188**, 103-112.
- Schulte, B.A. 2000. Social structure and helping behaviour in captive elephants. *Zoo Biol.* **19**, 447-459.
- Sikes, S.K. 1971. *The natural history of the African elephant.* Elsevier, New York.
- Skinner, J., Chimimba, C. 2005. *The mammals of the Southern African Subregion.* Third Edition. Cambridge University Press, Cape Town.
- Slade, B.E., Schulte, B.A., Rasmussen, L.E.L. 2003. Oestrous state dynamics in chemical communication by captive female Asian elephants. *Anim. Behav.* **65**, 813-819.
- Spearman, R.I.C. 1970. The epidermis and its keratinisation in the African elephant (*Loxodonta africana*). *Zool. Africana* **5**, 327-338.
- Spinage, C.A. 1994. *Elephants.* T & AD Poyser Ltd, London.
- Stocks, J.M., Taylor, N.A.S., Tipton, M.J., Greenleaf, J.E. 2004. Human physiological responses to cold exposure. *Aviat. Space Environ. Med.* **75**, 444-457.
- Sukumar, R. 1994. *Elephants days and nights: ten years with the Indian elephant.* Oxford University Press, Delhi, Bombay, Calcutta, Madras.
- Sukumar, R. 2003. *The Living Elephants: Evolutionary Ecology, Behaviour and Conservation.* Oxford University Press, Oxford.
- Šumbera, R., Zelová, J., Kunc, P., Knižková, I., Burda, H. 2007. Patterns of surface temperatures in two mole-rats (Bathyergidae) with different social systems as revealed by IR-thermography. *Physiol. Behav.* **92**, 526-532.
- Tattersall, G.J., Andrade, D.V., Abe, A.G. 2009. Heat exchange from the toucan bill reveals a controllable vascular thermal radiator. *Science* **325**, 468-470.
- Taylor, C.R. 1969. The Eland and the Oryx. *Sci. Am.* **220**, 88-97.

- Taylor, C.R. 1970. Strategies of temperature regulation: effect on evaporation in East African ungulates. *Am. J. Physiol.* **219**, 1131-1135.
- Taylor, C.R., Lyman, C.P. 1967. A comparative study of the environmental physiology of an East African antelope, the eland, and the Hereford steer. *Physiol. Zool.* **40**, 280-295.
- Toscano, M.J., Friend, T.H., Nevill, C.H. 2001. Environmental conditions and body temperature of circus elephants transported during relatively high and low temperature conditions. *J. Elephant Manag. Assoc.* **12**, 116-149.
- Vereshchagin, N.K., Baryshnikov, G.F. 1982. Paleoeology of the mammoth fauna in the Eurasian Arctic. In *Paleoeology of Beringia*, e.d. D.M. Hopkins, J.V. Matthews, Jr., C.E. Schweger, S.B. Young. pp 267-289. Academic Press, New York.
- Wallis, J., 1985. Synchrony of swelling in captive group-living chimpanzees (*Pan troglodytes*). *Int. J. Primatol.* **6**, 335-350.
- Watson, R., Fawcett, T.N. 2003. *Pathophysiology, Homeostasis and Nursing*. Routledge Chapman and Hall, London, New York.
- Webb, P.I., Speakman, J.R., Racey, P.A. 1992. The implication of small reductions in body temperature for radiant and convective heat loss in resting endothermic brown long-eared bats (*Plecotus auritus*). *J. Therm. Biol.* **18**, 131-135.
- Weissenböck, N. M., 2006. Die Thermoregulation Afrikanischer Elefanten (*Loxodonta africana*) in Tiergartenhaltung. MSc thesis. University of Vienna, Faculty of Life Sciences.
- Weissenböck, N.M., Schwammer, H. M., Ruf, T. 2009. Estrous synchrony in a group of African elephants (*Loxodonta africana*) under human care. *Anim. Reprod. Sci.* **113**, 322-327.
- Weissenböck, N.M., Schober, F., Fluch, G., Weiss, C., Paumann, T., Schwarz, C., Arnold, W. 2010. Reusable biotelemetric capsules: A convenient and reliable method for measuring core body temperature in large mammals during gut passage. *J. Therm. Biol.* **35**, 147-153.
- Weller, L., Weller, A., Roizman, S. 1999. Human menstrual synchrony in families and among close friends: examining the importance of mutual exposure. *J. Comp. Psychol.* **113**, 261-268.
- Williams, T.M. 1990. Heat transfer in elephants: thermal partitioning based on skin temperature profiles. *J. Zool., Lond.* **222**, 235-245.
- Williams, J. B. Ostrowski, S. Bedin, E. Ismail, K. 2001. Seasonal variation in energy expenditure, water flux and food consumptions of Arabian oryx (*Oryx leucoryx*). *J. Exp. Biol.* **204**, 2301-2311.
- Willmer, P., Stone, G., Johnson, I. 2005. *Environmental Physiology of Animals*. Second Edition. Blackwell Science, Magden, USA.
- Wittemyer, G., Rasmussen, H.B., Douglas-Hamilton, I. 2007. Breeding phenology in relation to NDVI variability in free-ranging African elephant. *Ecography* **30**, 42-50.
- Wright, P.G. 1984. Why do elephants flap their ears? *S. Afr. J. Zool.* **19**, 266-269.
- Wright, P.G., Luck, C.P. 1984. Do elephants need to sweat? *S. Afr. J. Zool.* **19**, 270-274.
- Wyatt, J.R., Eltringham, S.K. 1974. The daily activity of the elephant in the Rwenzori National Park, Uganda. *E. Afr. Wildl. J.* **12**, 273-289.

## ZUSAMMENFASSUNG

Elefanten haben als größte landlebende Säugetiere die kleinste Körperoberfläche im Verhältnis zum Volumen. Dadurch ist der Wärmeaustausch mit der Umgebung so eingeschränkt wie bei keinem anderen Säugetier. In der Kälte kann dies vorteilhaft sein, bei Hitzeexposition jedoch enorme Probleme bereiten. Dies ist wahrscheinlich der Grund, warum Elefanten das Fell verloren und ihre Körperwärme maßgeblich über Veränderungen der Hautdurchblutung regulieren. Während einer Studie zum temperaturregulierenden Verhalten von Afrikanischen Zooelefanten mittels Infrarot-Thermographie konnte ich eine Abnahme der Hauttemperatur, vor allem an den sensiblen Ohren, als Reaktion auf Kälteexposition beobachten. Die effektive Vasokonstriktion der Hautgefäße scheint es dem Elefanten zu ermöglichen in kühlen Klimaten zu leben, so zum Beispiel in der Subhimalajaregion, wo Asiatische Elefanten bis zur Schneegrenze vordringen, oder in Westafrika, wo nachts Temperaturen unter dem Gefrierpunkt herrschen können. Unter gemäßigten klimatischen Bedingungen konnte an den untersuchten Zooelefanten zahlreich auftretende, unabhängige thermische Fenster an ihrer gesamten Körperoberfläche beobachtet werden. Die Häufigkeit dieser stark vaskularisierten Regionen nahm mit zunehmender Lufttemperatur und Körpergewicht der Tiere zu. Die fein abgestimmte und lokal beschränkbare Veränderung der Hautdurchblutung scheint es dem Tier zu ermöglichen über einen weiten Bereich von Umgebungstemperaturen seine Körperwärme ohne zusätzlichen Energieverbrauch zu regulieren. Ob dies ausreicht auch mit heißen Klimaten zurecht zu kommen, war die zentrale Fragestellung dieser Arbeit.

Einige Wüstensäugetiere, so etwa die Kamele, sind in der Lage eine erhöhte Körperkern-temperatur während des Tages zu tolerieren, um dann die überschüssige Wärme während der kühleren Nachtstunden abzugeben. Diese so genannte „adaptive Heterothermie“ reduziert beides, den Wasser- und den Energiebedarf für die evaporative Kühlung. In der vorliegenden Arbeit wurde untersucht, ob diese Anpassung auch bei Elefanten existiert, deren Wärmeabgabe vorrangig durch die enorme Körpergröße eingeschränkt wird.

Aufgrund der Schwierigkeiten physiologische Parameter bei Elefanten kontinuierlich über längere Zeiträume zu erfassen, habe ich zuerst an der Entwicklung einer präzisen und zuverlässigen Methode zur Messung der Körpertemperatur bei Großsäugetieren gearbeitet. Das entwickelte telemetrische Verfahren konnte erfolgreich an Afrikanischen (*Loxodonta africana*) und Asiatischen (*Elephas maximus*) Zooelefanten angewandt werden.

Zur Beantwortung der Kernhypothese dieser Dissertation, habe ich schlussendlich die Körpertemperatur von elf adulten Asiatischen Elefanten in ihrem natürlichen Lebensraum in Thailand über längere Zeiträume erfasst. Dabei zeigte sich, dass Asiatische Elefanten, die einem feuchten und warmen Klima ausgesetzt sind, tatsächlich eine ausgeprägte Heterothermie zeigen, selbst wenn sie mit ausreichend Wasser und Futter versorgt werden. Die gemessene Körpertemperatur erreichte ihr tägliches Maximum kurz vor Sonnenuntergang und zeigte eine tägliche Schwankung, die etwa 2.6 mal so groß war als vom generellen allo-

metrischen Zusammenhang zwischen Körpergröße und der täglichen Variationsbreite bei Säugetieren zu erwarten war. Ich berechnete, dass Elefanten 26.5 MJ Wärme in ihren massigen Körpern speichern können, was in etwa 10% ihres täglichen Energieverbrauches entspricht. Diese überschüssige Wärme wurde nachts durch eine Erhöhung der thermischen Konduktanz wieder abgegeben. Die Wärmeabgabe nahm während der ersten Nachtstunden umso mehr zu, je höher die maximale Lufttemperatur war. Zusammenfassend lässt sich sagen, dass Heterothermie in Elefanten eine adaptive und reguläre Reaktion auf hohe Lufttemperatur ist. Heterothermie ist also keine spezielle Wüstenanpassung, sondern scheint eine grundsätzliche thermophysiologische Reaktion bei Säugetieren zu sein, die an ihre physiologischen Leistungsgrenzen stoßen.

## ABSTRACT

Being the largest terrestrial animal on earth today, elephants have the smallest surface to volume ratio. Therefore, heat exchange with the environment is greatly restricted, as in no other terrestrial mammal. This may be of considerable advantage in the cold, but disadvantageous during exposure to heat. While studying the thermoregulatory behaviour of African zoo elephants via infrared thermography I observed, as a consequence of cold exposure, a reduction in skin temperature, particularly of the ears. The effective cutaneous vasoconstriction may enable the elephant to cope with low temperatures, e.g. in the sub-Himalayan region, where Asian elephants travel up to the snow-line, or during the night in West Africa where temperatures can drop below freezing. Under moderate temperate conditions, however, the studied zoo elephants abundantly showed small, independent thermal windows over their whole body surface. The frequency of these highly vascularised skin areas increased with increasing ambient temperature and body weight. The fine-tuned and locally restricted cutaneous blood flow may enable an animal to regulate its body heat without additional expenditure of energy over a wide area of ambient temperatures. Whether this is sufficient to cope with hot climate conditions was the central question of this thesis.

Some desert mammals, such as camels, tolerate elevated core body temperature during the day and dissipate the excess heat during the cooler night hours. This so-called “adaptive heterothermy” reduces both water and energy requirements for evaporative cooling. In this thesis I investigated whether this response also exists in elephants when primarily large body size constrains heat dissipation.

Owing to the difficulty obtaining physiological parameters continuously from large megaherbivores like elephants, I first had to develop a precise and reliable non-invasive method for determining the body temperature of large-bodied mammals. The telemetric procedure was employed successfully on African (*Loxodonta africana*) and Asian (*Elephas maximus*) zoo elephants.

Finally, to answer the core hypothesis I measured body temperature over longer periods in eleven adult Asian elephants living in their natural habitat in Thailand. It became clear that Asian elephants exposed to the humid and hot climate, indeed showed pronounced heterothermia, even when supplied with plenty of water and food. Body temperature reached its daily peak before sunset and fluctuated with a daily range 2.6 times larger than expected from allometric relations between body size and daily range of body temperature in mammals. I estimate that elephants can store up to 26.5 MJ heat per day in their huge bodies, equivalent to about 10% of their daily energy expenditure. This heat load was dissipated during the night through an elevated thermal conductance. Heat dissipation increased during the first part of the night with a greater increase on days with higher maximum ambient temperature. Heterothermy, therefore, is not a special desert adaptation, but rather seems to be a basic thermophysiological reaction of mammals pushed to their physiological limits.

# CURRICULUM VITAE

## NICOLE M. WEISSENBÖCK

Master of Science (Zoology)

PhD student  
Research Institute of Wildlife Ecology  
University of Veterinary Medicine Vienna  
Savoyenstraße 1, A-1160 Vienna  
Tel: 0043 69919674818  
Email: nicole.weissenboeck@fiwi.at



### PERSONAL DATA

**Date of birth** 18 09 1978  
**Place of birth** Vienna, Austria  
**Nationality** Austrian

### EDUCATION

**2006 - present** **Doctoral Study in natural science**, dissertation subject: Zoology at the University of Vienna  
**2006** **Graduation:** Mag. rer. nat. at the University of Vienna  
**2000 - 2006** **Diploma Study in Biology**, subject Zoology at the University of Vienna. Main subjects studied: animal behaviour, animal physiology  
**1996 - 2000** **Diploma Study in Veterinary Medicine** at the University of Veterinary Medicine, Vienna

### EMPLOYMENT & WORK EXPERIENCE

**2010** Assistant at the practice of Dr. Niloufar Goharkhay, general practitioner  
**2009 - 2010** Minor Employment at the Research Institute of Wildlife Ecology, University of Veterinary Medicine Vienna  
**2007 - 2009** Employment at the Institute of Wildlife Ecology, University of Veterinary Medicine Vienna in the course of a DOC-fFORTE scholarship of the Austrian Academy of Science  
**2006** Research Assistant at the Vienna Zoo  
ASERC Elephant-Thermography-Research Project in Sri Lanka  
**2005 - 2006** Research Project regarding the estrous cycle of African elephants at the Vienna Zoo  
**2005** Research Assistant at the Vienna Zoo  
Animal Welfare Project: Feasibility Study: "Heat stain of Vienna cab horses"  
**2003 - 2005** Assistant at the practice of Prim. Univ. Prof. Dr. Eva Maria Maida, specialist of neurology and psychiatry

### AWARDS

**2006** DOC-fFORTE scholarship of the Austrian Academy of Science  
Award of the Dr. Maria Schaumayer trust

## RESEARCH STAY abroad

<b>2009</b>	Samphran Elephant Ground and Zoo, Thailand
<b>2008</b>	Mahidol University; Samphran Elephant Ground and Zoo, Thailand Munich Zoo Hellabrunn, Germany
<b>2006</b>	Pinnawala Elephant Orphanage, Sri Lanka
<b>2005</b>	Berlin's Tiergarten, Germany Berlin Zoological Garden, Germany IZW Leibniz Institute for Zoo and Wildlife Research, Berlin, Germany Munich Zoo Hellabrunn, Germany

## SKILLS

### Research techniques

- Physiology: measurement of body and skin temperature in mammals; calculation of physiological parameters; thermoregulation; generative physiology;
- Animal behaviour: observing, analysing and interpreting behaviour in mammals;
- Statistics: able to analyse large datasets, analyses of variance, linear mixed effect models, cosinor analysis, bootstrap procedure;
- Animal keeping: familiar with maintenance and need of zoo animals

### Supervision and teaching

- I supervised undergraduate students during my PhD. Analysed and discussed their work and explained scientific work and techniques as well as literature search to them.

### Communication

- Excellent written ability developed through writing papers, my theses, posters for presentations, homepage designing.
- Good oral presentation skills: see appendix – I have presented my work orally 15 times at scientific conferences, universities, zoos and within my department. I have also made poster presentations.
- As a recipient of a DOC-fFORTE scholarship of the Austrian Academy of Science I am experienced in administrating external funds.
- During my research stays abroad I gained experience in communicating with foreign universities and institutions.
- I gave radio and television interviews about my work and was consulted several times as an expert from print and TV media.
- As an employee at the Vienna Zoo I was involved in promoting science to the local public.

### Language skills

German: native tongue; English: very well in speech and writing; Latin: basic knowledge

### PC knowledge

Adobe Illustrator, Internet, Infranview, Image J, Microsoft Office, R - Statistical Computing, Sigma Plot, SPSS, ThermaCam Researcher



## PUBLICATIONS

### Peer-reviewed

- Weissenböck, N.M.**, Schwammer, H.M., Ruf, T. (2009): Estrous synchrony in a group of African elephants (*Loxodonta africana*) under human care. *Animal Reproduction Science* 113, 322-327.
- Weissenböck, N.M.**, Schober, F., Fluch, G., Weiss, C., Paumann, T., Schwarz, C., Arnold, W. (2010): Reusable biotelemetric capsules: a convenient and reliable method for measuring core body temperature in large mammals during gut passage. *Journal of Thermal Biology* 35, 147-153.
- Weissenböck, N.M.**, Weiss, C.M., Schwammer, H.M. Kratochvil, H.: Thermal windows on the body surface of African elephants (*Loxodonta africana*) studied by infrared thermography. *Journal of Thermal Biology* 35, 182-188.
- Weissenböck, N.M.**, Ruf, T., Arnold, W.: Heterothermy of Asian elephants as an adaptation of living in hot and humid climates. Submitted to the *Journal of Experimental Biology*.

### Popular scientific, Proceedings

- Graf, P., **Weissenböck, N.M.**, Schwammer, H.M. (2007): Hand-rearing of elephant calves: a comparison between common milk replacer regarding their physiological efficiency. *Proceedings of the International Elephant Conservation and Research Symposium 2006*, Gilleleje, Denmark.
- Gunhold, T., **Weissenböck, N.M.**, Schwammer, H.M. (2006): The dominance hierarchy of African elephants (*Loxodonta africana*) at Vienna Zoo. Die Dominanzhierarchie in der Herde Afrikanischer Elefanten (*Loxodonta africana*) im Tiergarten Schönbrunn. (in German with English abstract). *Der Zoologische Garten* 76(3): 169-177.
- Weissenböck, N.M.** (2006): Veterinary, welfare monitoring and behavior study: Thermography as modern tool in elephant research. *Proceedings of the 26<sup>th</sup> EMA Conference 2005*, Portland, Oregon, USA.
- Weissenböck, N.M.** (2006): Thermoregulation of Elephants – new findings on the basis of the most modern research method: IR-Thermography. *Journal of European Elephant Keeper and Manager Association - English edition* 21, 8-12.
- Weissenböck, N.M.** (2006): Neue Erkenntnisse in der Elefantenforschung dank modernster Infrarot-Thermographie. *Schönbrunner Tiergartenjournal* 15(2), 14-15.
- Weissenböck, N.M.** (2006): The Use of Infrared-Thermography for the Thermoregulation Study in Zoo- and Semi wild Elephants: Advantages and Limits of IR-Imaging discussed on the basis of new results. *Journal of the Elephant Manager Association* 17(2), 45-49.
- Weissenböck, N.M.** (2007): How do elephants deal with various climate conditions? Previous results, recent data and new hypotheses. *Proceedings of the International Elephant Conservation and Research Symposium 2006*, Gilleleje, Denmark.
- Weissenböck, N.M.**, Schwammer, H.M., Voracek, T. (2007): Thermographische Diagnostik bei Afrikanischen (*Loxodonta africana*) und Asiatischen (*Elephas maximus*) Elefanten. *Der Zoologische Garten* 76(5-6), 331-344.
- Weissenböck, N.M.** (2007): This year's „International Elephant Conservation and Research“ Symposium in Denmark. *Journal of European Elephant Keeper and Manager Association - English edition* 22, 4-7.
- Weissenböck, N.M.**, Schwammer, H.M., Ruf, T.: Synchrony of estrous cycles among African elephants. *Proceedings of the International Elephant Conservation and Research Symposium 2008*, Pattaya, Thailand. In press.

## Theses

**Weissenböck, N.M.** (2006): Thermoregulation of African elephants (*Loxodonta Africana*) under human care. *Die Thermoregulation Afrikanischer Elefanten (Loxodonta africana) in Tiergartenhaltung*. MSc Thesis (in German with English abstract). University of Vienna.

**Weissenböck, N.M.** (2010): Thermoregulation of African (*Loxodonta africana*) and Asian (*Elephas maximus*) elephants: Heterothermy as an adaptation of living in hot climates. PhD Thesis (in English with German abstract). University of Vienna.

## CONFERENCES ATTENDED

- 2009** 7<sup>th</sup> International Conference on Behaviour, Physiology and Genetics of Wildlife, Berlin.  
47<sup>th</sup> scientific Annual Meeting of the GV-SOLAS, University of Veterinary Medicine Vienna.
- 2008** International Elephant Conservation and Research Symposium, Pattaya, Thailand.  
82<sup>nd</sup> Annual Conference of the German Society of Mammalogy, Vienna, Austria.
- 2007** Symposium "From ecology to conservation: merging basic and applied science", Veterinary University of Vienna.  
Workshop „Applied scientific research in zoological gardens“, Johann Wolfgang Goethe-University, Frankfurt am Main.  
8<sup>th</sup> International Conference on Environmental Enrichment, Vienna.  
Workshop in conservation, Vienna Zoo.
- 2006** International Elephant Conservation and Research Symposium, Gilleleje, Denmark.  
Workshop „Edotheliotropic Elephant Herpes Virus“, Gilleleje, Denmark.  
1<sup>st</sup> Symposium of the Department of Evolutionary Biology, Vienna Zoo.  
EAZA Elephant Workshop, Zoo Dvůr Králové/Zoo Prag.
- 2005** 26<sup>th</sup> Elephant Manager Association (EMA) Conference, Portland, Oregon, USA.

## INVITED SEMINARS

- 2009** "Thermoregulation in Asian elephants: Heterothermy as an adaptation of living in hot climates", University of Vienna.
- 2008** "Die Thermoregulation des Elefanten", Charité Universitätsmedizin Berlin, Germany.  
„Elefantenforschung für den Artenschutz - Aktuelle Projekte des Tiergarten Schönbrunn“, Tiergarten Schönbrunn, Wien.  
„Kalte Füße wünschenswert! Faszinierendes zum Thema Temperaturregulation der Tiere“, Tiergarten Schönbrunn, Wien.
- 2006** „IR-Thermography as modern toll in elephant research“, Dehiwela Zoo, Colombo, Sri Lanka.

[Zurück zur Übersicht](#)

### Vom Sudeck bis zum Elefantenohr Thermographie zeigt innere Wärmequellen

**WIEN – Die Körperoberfläche widerspiegelt in ihrer Temperaturverteilung den körperinneren Stoffwechsel und Wärmeumsatz. Mit der Infrarot-Thermographie kann diese Temperaturverteilung dargestellt werden und ermöglicht Rückschlüsse auf bestimmte Stoffwechselvorgänge. Entzündete Gelenke oder sympathikusabhängige Veränderungen der Gefäße werden auf einen Blick sichtbar. Eine elegante diagnostische Methode für Mensch – und Tier ...!**

Zur Erhaltung einer einigermaßen konstanten Körpertemperatur muss die im Körperinneren erzeugte Wärme nach außen abgeleitet werden. Die Körperoberfläche weist daher eine Temperaturverteilung auf, die den körperinneren Stoffwechsel und damit den Wärmeumsatz widerspiegelt.

Dabei haben oberflächennahe Stoffwechselherde einen größeren Einfluss auf die Temperaturverteilung als jene, die im Körperinneren lokalisiert sind. Fazit: Die lokale Temperatur der Körperoberfläche ergibt sich aus der Überlagerung des Wärmeflusses aus unterschiedlich tiefen Körperregionen.

Die Infrarot-Thermographie misst nun die Infrarot-Wärmeabstrahlung der Körperoberfläche, deren Wellenlänge im Infrarot-Bereich liegt, und wandelt sie in farbige Thermogrammbilder um. Die Infrarotkamera misst berührungslos. Woraus sich schon der größte Vorteil dieser Diagnostik ergibt: Sie ist extrem patientenfreundlich und einfach durchzuführen.

Ihr größter Nachteil: „Die Anschaffung des Equipments ist teuer und daher nur für spezialisierte Zentren interessant“, so OA Dr. Othmar Schuhfried, [Klinik für Physikalische Medizin und Rehabilitation, AKH Wien](#). Und, so muss man ergänzend hinzufügen, sie hat als diagnostisches Instrument nur ein schmales Indikationsspektrum, nämlich Entzündungsreaktionen des Bewegungsapparates und Durchblutungsstörungen bzw. funktionelle Veränderungen der Blutzirkulation.

Zur exakten Messung als Voraussetzung der diagnostischen Treffsicherheit müssen strenge Standardbestimmungen eingehalten werden, die von einer konstanten Raumtemperatur in einem speziellen Raum über die Vorbereitung des Patienten bis zum Aufnahmeprogramm selbst reichen. Zur Auswertung der Bilder werden Marker in die „regions of interest“ gesetzt (s. Bilder).

#### Sudeck und Raynaud

Als diagnostische Methode hat die Infrarot-Thermographie zwei wissenschaftlich gesicherte Hauptindikationen, nämlich Morbus Sudeck (auch CRPS: Komplexes regionales Schmerzsyndrom) und das Raynaud-Phänomen. „Zwar wird die Diagnose des CRPS meist auf Grund der klinischen Symptomatik gestellt, aber trotzdem sind Zusatzuntersuchungen zur genauen Abklärung notwendig.

Die Infrarot-Thermographie kann hier schon im frühen Stadium die beim Sudeck-Syndrom immer vorhandenen vasomotorischen Störungen zeigen. Sie ist einzigartig in der Dokumentation der thermalen Dysfunktion“, so Dr. Schuhfried.

Typisch ist beim CRPS eine diffuse Temperaturseitendifferenz. Es besteht auf der betroffenen Seite keine lokal begrenzte, sondern eine diffuse Hyperthermie oder seltener Hypothermie des Extremitätenabschnittes im Vergleich zur gesunden Seite.

Bei der thermographischen Diagnose des Raynaud-Phänomens wird zunächst die Ausgangstemperatur von Fingern und Händen gemessen. Anschließend wird nach einem Kaltwassertest die Wiedererwärmung innerhalb von 20 Minuten erfasst. Die Infrarotkamera zeigt, wie sich die Erwärmung ausbreitet: Es entsteht das beim Raynaud-Phänomen typische Wärmemuster der thermischen „Fingeramputation“.

Andere Indikationen für die Thermographie sind umstritten, weil sie als diagnostische Methode zu unspezifisch ist. Aber sie eignet sich gut als Zusatzuntersuchung und zur Verlaufskontrolle, bspw. bei der Therapie rheumatischer Erkrankungen oder von Durchblutungsstörungen.

#### Schönbrunns Elefanten im IR-Visier

War die Rede davon, dass die Infrarot-Thermographie in höchstem Maß patientenfreundlich ist, so sind bei dieser Feststellung durchaus auch tierische Patienten mit eingeschlossen. Bereits in den 60er wurde dieses Diagnoseinstrument in der Veterinärmedizin mit Erfolg eingesetzt: bei Rennpferden, um Verletzungen des Bewegungsapparates sichtbar zu machen, und bei Zootieren.

Besonders Elefanten sind ideale Thermographie„objekte“ und waren

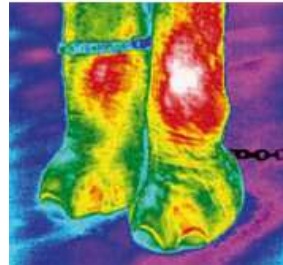

**Thermographie im Tiergarten Schönbrunn: Ein vermutlich entzündetes Tarsalgelenk bei Elefant Sabi ..**

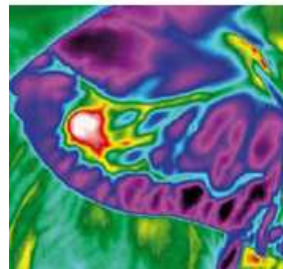

**... und eine Verletzung am Ohr nach einem Kampf bei Jumbo (rot).**

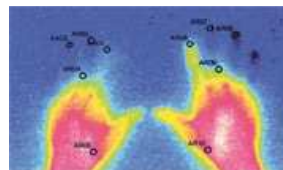

**Der Kaltwassertest zeigt beim Raynaud-Phänomen die langsame Wiedererwärmung der Hände. Hier ein Bild zwanzig Minuten nach dem Test. Blau ist kalt, rot ist warm.**

im Tiergarten Schönbrunn Probanden einer entsprechenden Studie. Denn, für die Infrarot-Thermographie gilt grundsätzlich: je weniger Haare bzw. Fell, desto besser.

Zoologin Mag. Nicole Weissenböck: „Bei Elefanten kann man praktisch die Hauttemperatur direkt messen. Die Studie hat gezeigt, dass sich die Infrarot-Diagnostik vor allem zur Darstellung von Entzündungen auf Grund von Abszessen und Verletzungen eignet. Entzündete Areale waren grundsätzlich mit vier bis sechs Grad höheren Temperaturen im Thermogramm erkennbar. Auch zur Dokumentation von Heilungsprozessen ist die IR-Methode nützlich.“ Übrigens, wann waren Sie zum letzten Mal im Tiergarten? *SCH*



**Diese Patientin leidet nach einer Radiusfraktur rechts an einem Morbus Sudeck (CRPS). Die rechte Hand zeigt gegenüber linken Hand eine diffuse Hyperthermie.**

[Klinik für Physikalische Medizin und Rehabilitation, AKH Wien](#)

© MMA, Medical Tribune • 39. Jahrgang • Nr. 10



AHA

## Warum haben Elefanten riesige Ohren?

**Große Ohren erleichtern das Hören. Dem Afrikanischen Elefanten reichen die Ohren bis über den Hals. Das unterscheidet ihn von dem etwas kleineren Asiatischen Elefanten. Bei Ohrklappen von zwei Quadratmetern fragt man sich, was so ein Jumbo alles hört.**

Bekannt ist, dass die Dickhäuter Ferngespräche führen. Elefantenkühe und -bullen verständigen sich über Essen, Sex und Gefahren, teils nutzen sie dafür den für menschliche Ohren unhörbaren Infraschall mit extrem tiefen Tönen. Solche Langwellen eignen sich für ungestörte Ferngespräche. Doch auch Giraffen kommunizieren über Infraschall - und die haben keine derart riesigen Ohren.

"Elefantenohren sind sehr stark durchblutet", sagt Nicole Weissenböck, Zoologin am Forschungsinstitut für Wildtierkunde und Ökologie der Veterinärmedizinischen Universität Wien. Zu jedem Lauscher können die Tiere pro Minute bis zu zehn Liter Blut pumpen. "An der Ohrrückseite liegt ein dichtes Geflecht aus Arterien und Venen, die sich je nach Temperatur erweitern oder zusammenziehen." Diese Art der Thermoregulation ist weit verbreitet. Bei einem Winterspaziergang etwa werden zuerst unsere Ohren, Hände und Füße kalt. Der Körper schützt die inneren Organe davor, auszukühlen, indem er verhindert, dass zu viel Blut an die Peripherie gelangt.

Beim Elefanten, der in heißen Regionen lebt, stellt sich das Problem eher andersherum: Da er nicht schwitzt und abgesehen von gelegentlichen Bädern wenig Chancen hat, angestaute Wärme loszuwerden, pumpt er Blut an die schattige Innenseite der Ohren. Damit die Wärme des Blutes schnell von dort abtransportiert wird, wedelt er kräftig mit den Ohren und fächelt die Luft immer wieder von der heißen Körperoberfläche weg.

"Große Ohren sind für ein Leben in Hitze gemacht", sagt Weissenböck. Auffällig, dass ein Wüstenfuchs riesige Ohren hat, der Rotfuchs mittelgroße und der Polarfuchs kleine. Braunbären besitzen viel größere Ohren als Eisbären. Die Ohren des Afrikanischen Savannenelefanten sind etwa um zwei Drittel größer als die des Asiatischen Elefanten, der vorwiegend in etwas kühleren Waldgebieten lebt. Noch viel kleiner waren die Ohren des sibirischen Wollhaarmammuts.

---

## Elephants use 'hot spots' to stay cool

Elephants can fine tune their body temperature using "hot spots" scattered around their bodies, according to research which questions the widely held belief that the animals use their giant ears to stay cool.

---

By [Richard Gray](http://www.telegraph.co.uk/journalists/richard-gray/) (http://www.telegraph.co.uk/journalists/richard-gray/), Science Correspondent  
Published: 9:30AM BST 02 May 2010

---

With their thick hides and lack of sweat glands, it has long been thought that elephants



Photo: EPA

(<http://www.telegraph.co.uk/earth/wildlife/7625162/Elephants-have-special-alarm-call-to-warn-of-bees.html>) rely upon their distinctive large ears and bathing in rivers to stay cool in hot climates.

New research, however, has revealed that the world's largest land animals have a secret trick to control their own body temperatures.

---

## Related Articles

**Elephants use special 'bee alarm'** (</earth/wildlife/7625162/Elephants-have-special-alarm-call-to-warn-of-bees.html>)

**Elephants legs 'the same as 4x4'** (</earth/wildlife/7537045/Elephants-legs-work-the-same-as-a-4x4-vehicle.html>)

**First male twin elephants** (</earth/wildlife/7497066/Worlds-first-set-of-male-twin-elephants-born-in-Thailand.html>)

**Man and elephant battle for survival** (</earth/wildlife/7541596/Tuskers-in-trouble-man-and-elephant-battle-for-survival.html>)

**'Miracle' as baby elephant comes back from the dead** (</news/newstoppers/howaboutthat/7409848/Miracle-as-baby-elephant-comes-back-from-the-dead.html>)

**Thai zoo hopes cold spell will put pandas in heat** (</news/worldnews/asia/thailand/4296028/Thai-zoo-hopes-cold-spell-will-put-pandas-in-heat.html>)

---

Using thermal cameras, biologists have discovered that the creatures' bodies are covered in "hot spots" that can help them lose heat.

By directing their blood supply near to the surface of small patches of skin scattered around their bodies, elephants can lose heat rapidly, allowing them to fine-tune their internal temperature.

Scientists have long been puzzled by temperature regulation in elephants. Typically, animals with large bodies tend to retain more heat because, relative to their bulk, they have a small surface area for heat to escape from.

Elephants, with their heavy weight, would appear to be at a disadvantage in the fierce heat of their African and Asian habitats, especially because they lack sweat glands - used for cooling by other mammals - and have tough hides to protect them from spiny bushes and trees.

It was assumed by biologists that the creatures, which weigh up to 13 tons (12 tonnes) when fully-grown, had evolved large ears to help them stay cool. The skin in the ears is thinner, so blood pumped into them cools down more readily.

But findings by researchers at two universities in Vienna have revealed that elephants also able to cool down by increasing the blood flow to skin patches in other parts of their bodies.

Nicole Weissenböck, an ecologist at the city's University of Veterinary Medicine, who led the research, said: "Elephants are the largest terrestrial mammals on earth today.

"They are called pachyderms [from the Greek for "thick skin"] because of their supposed thick and insensitive skin.

"Our study clearly shows that this is only a myth – in fact the elephant's skin must have more regional concentrations of vascular networks that has previously been appreciated.

"It is a fine-tuning mechanism in heat regulation."

The researchers took thermal images of six African elephants at Vienna Zoo as they moved between outdoor and indoor environments to see how the temperature on their skin surface would change.

Bright yellow and white colours indicated the parts of their bodies from which the animals were losing the most heat.

The researchers found up to 15 "hot spots" scattered all over an elephant's body surface, in addition to large patches on the ears.

The study, which is published in the *Journal of Thermal Biology*, shows how these patches expand as the air temperature increases and more blood flows nearer to the skin surface.

Subsequent experiments showed that elephants in the wild use the same "thermal windows" to control their body temperature.

Elephants have two additional ways to stay cool: ear-flapping, which creates a breeze, and bathing, which cools the creatures when the water evaporates from their skin.

Together with these tricks, the skin hot spots allow the animals to keep their body temperature constant at about 36DgrC – one degree less than humans.

Professor Fritz Vollrath, an expert on elephant behaviour at Oxford University and a trustee of the Save the Elephants charity, said it was possible the hot spots provided localised cooling for specific organs.

He said: "This is an interesting study as it shows that elephants can and do flood blood through their ears independently and can open and close specific areas of their skin for blood cooling."

---

© Copyright of Telegraph Media Group Limited 2010



19. Mai 2010, 17:24

---



### Österreich

Lange wurde angenommen, dass Elefanten einzig mit ihren großen Ohren und Bädern im Wasser Abkühlung finden. Eine Forschungsgruppe um Nicole Weissenböck von der Veterinärmedizinischen Universität Wien hat jedoch die Afrikanischen Elefanten im Tiergarten Schönbrunn und anschließend wildlebende Elefanten mit Hilfe von Wärmekameras untersucht und dabei herausgefunden, dass sie ihre Körpertemperatur über sogenannte "Hot Spots" (gefäßreiche Hautgebiete) regulieren können. Zusätzlich zu den Ohren, wo die Haut dünner ist und das dort hineingepumpte Blut somit leichter abkühlt, fanden die ForscherInnen bis zu 15 "Hot Spots" über die Oberfläche eines Elefanten verteilt. Die im "Journal of Thermal Biology" publizierte Studie hat gezeigt, dass sich diese Stellen bei steigender Lufttemperatur vergrößern und damit mehr Blut näher an der Hautoberfläche fließt.

[Link zum Journal of Thermal Biology](#)

[Link zum Telegraph](#)