

Real-time Sweat Analysis: Concept and Development of an Autonomous Wearable Micro-fluidic Platform

Vincenzo F. Curto



OUTLINE

- Sweat, why is it Important?
- Introduction: Wearable Sensors
- Fabrication and Characterisation of the Devices
- Results
- Conclusions

INTRODUCTION



SWEAT, WHY IS IT IMPORTANT?

Sweat is naturally generated during exercise.

Monitoring its contents provides very rich information about the physiological condition of the individual.

Rehydration and re-mineralisation



Improve performance and general health

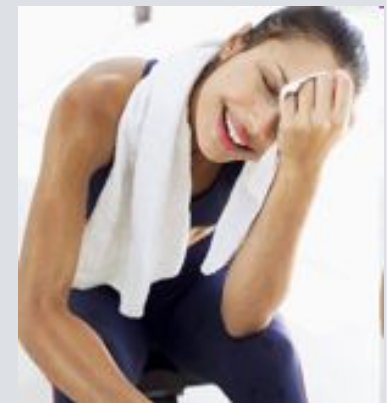

Sweat analysis: identify pathological disorders

- ✧ Cystic fibrosis*
- ✧ Information on dehydration
- ✧ Changes in the concentration of biomolecules and ions
- ✧ Hyponatremia (low sodium concentration)

*Common hereditary disease which affects the entire body, causing progressive disability and often early death.

PHYSIOLOGICAL & CHEMICAL SENSORS

LIFESHIRT®



- ✓ Breath rate,
- ✓ Heart rate,
- ✓ Posture
- ✓ Skin temperature
- ✓ ...



Medtronic Diabetes' Guardian®



NIKE-APPLE IPOD Sports Kit®

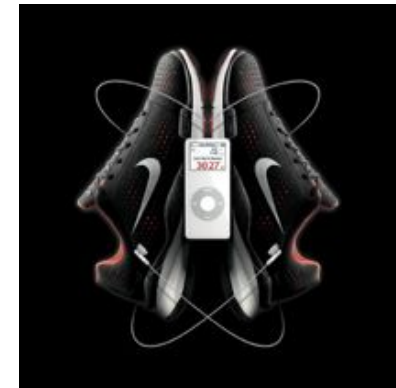

Lactate Scout®

SWEAT ANALYSIS

Macroduct sweat collection system



PharmChek Sweat Patch

Whole body sweat collection techniques

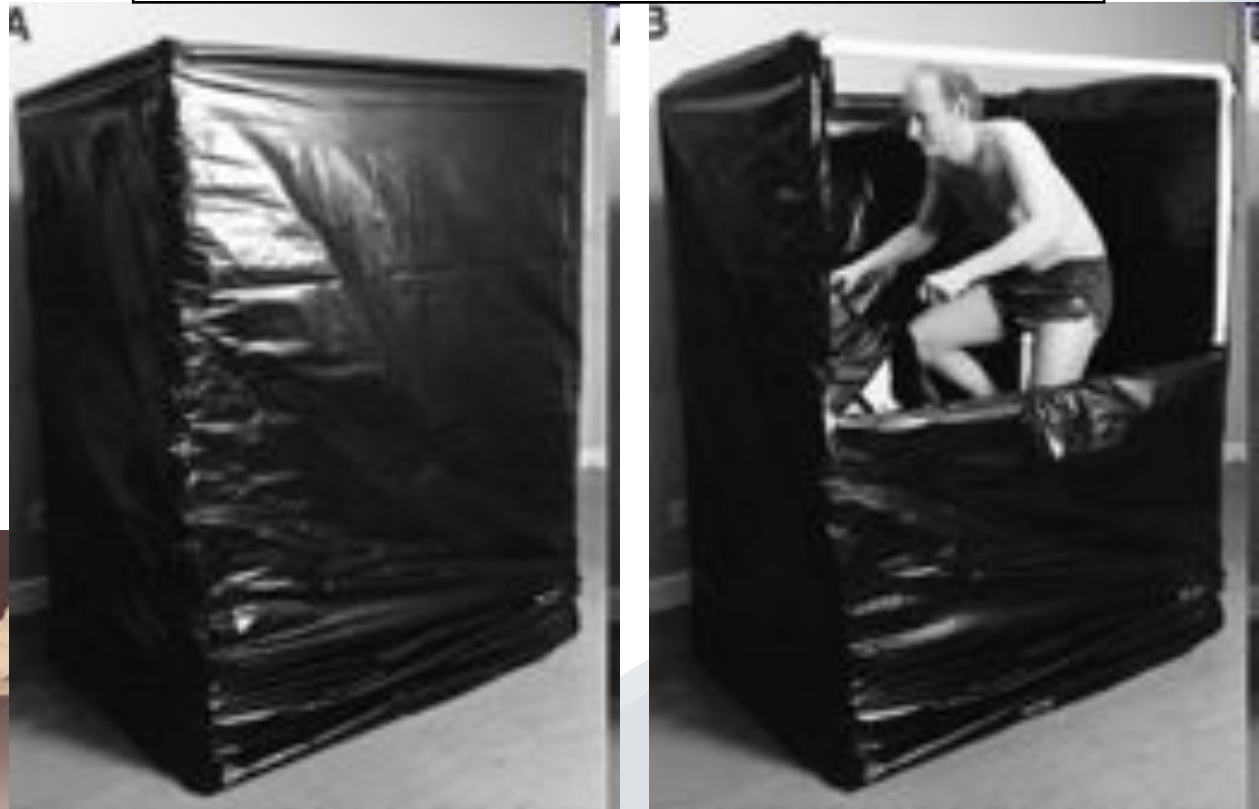

S. M. Shirreffs and R. J. Maughan, J Appl Physiol 82: 336-341, 1997

REAL-TIME SWEAT ANALYSIS

WHAT DO WE NEED????

DEVICE:

WEARABLE

ROBUST

FLEXIBLE / ADAPTABLE

REUSABLE / DISPOSABLE (CHEAP)

IMMEDIATE FEEDBACK

DETECTION:

NOT INVASIVE

WIRELESS

FREEDOM FROM ELECTRONIC NOISE

MINIATURIZATION

FLEXIBILITY IN INTERROGATION APPROACHES
(human eyes, LED-sensors, cameras, spectrometers, ...)

MICRO-DEVICES!!

OPTICAL SENSORS!!

BIOTEX – Biosensing Textile for Health Management

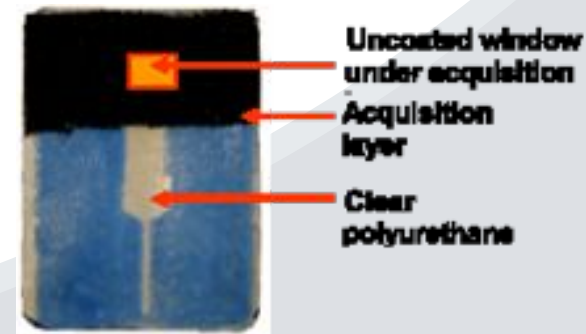
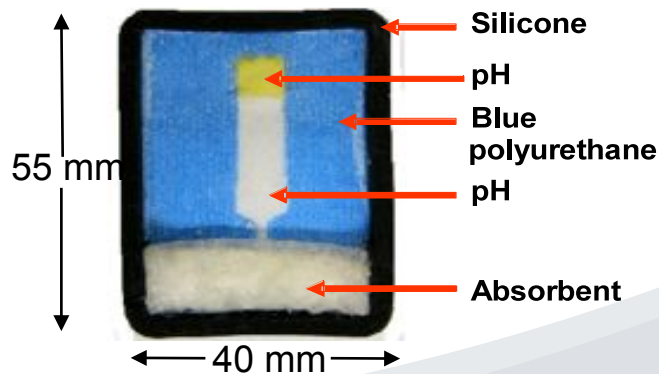
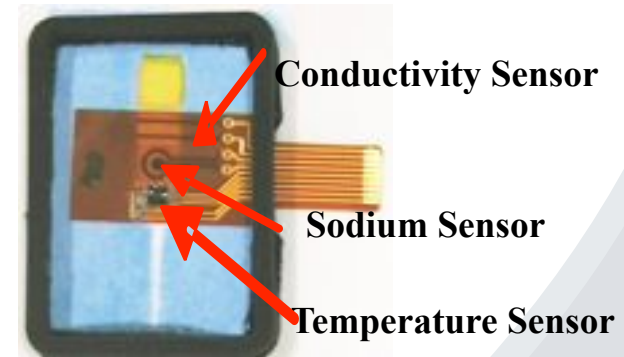
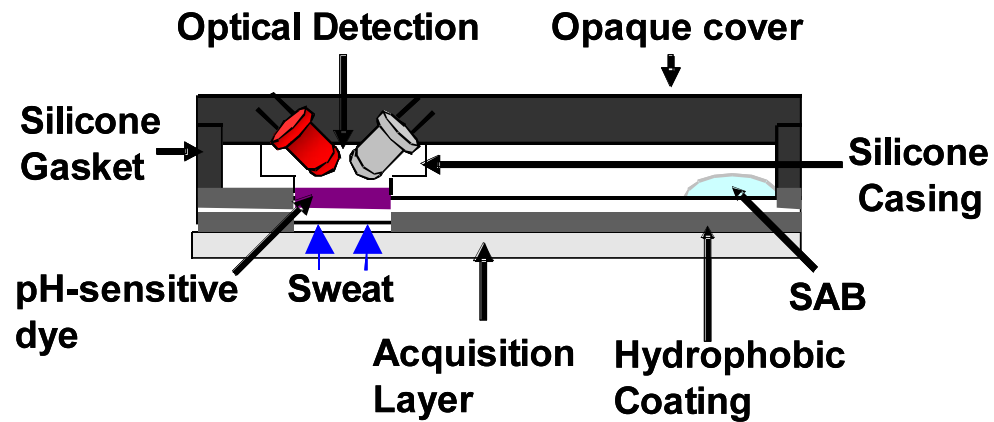

www.biotex-eu.com

S. Coyle, IEEE Transactions on Information Technology In Biomedicine, VOL. 14, No. 2, MARCH 2010

DEVELOPMENT OF THE CONCEPT

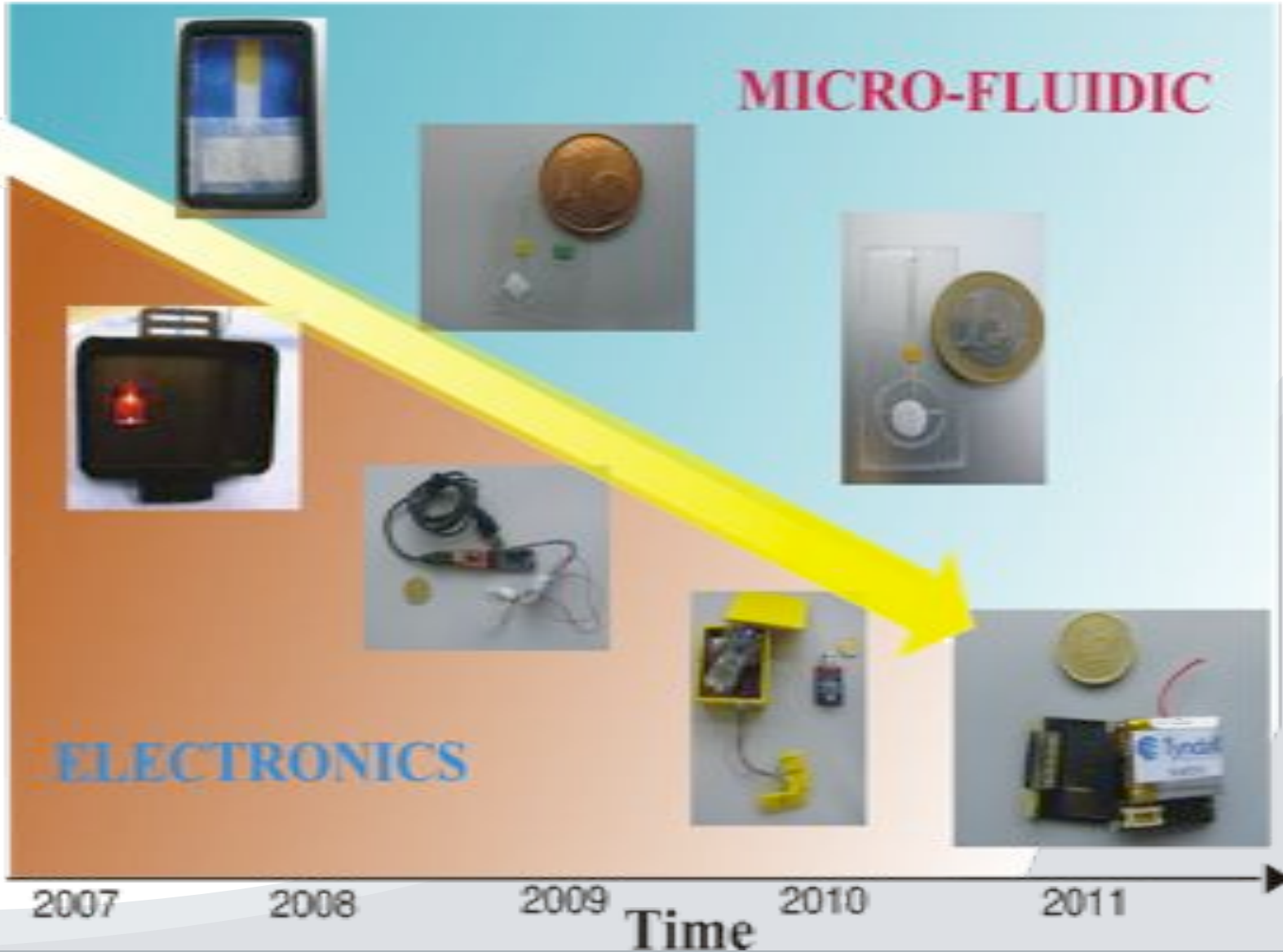

OPTICAL DETECTION

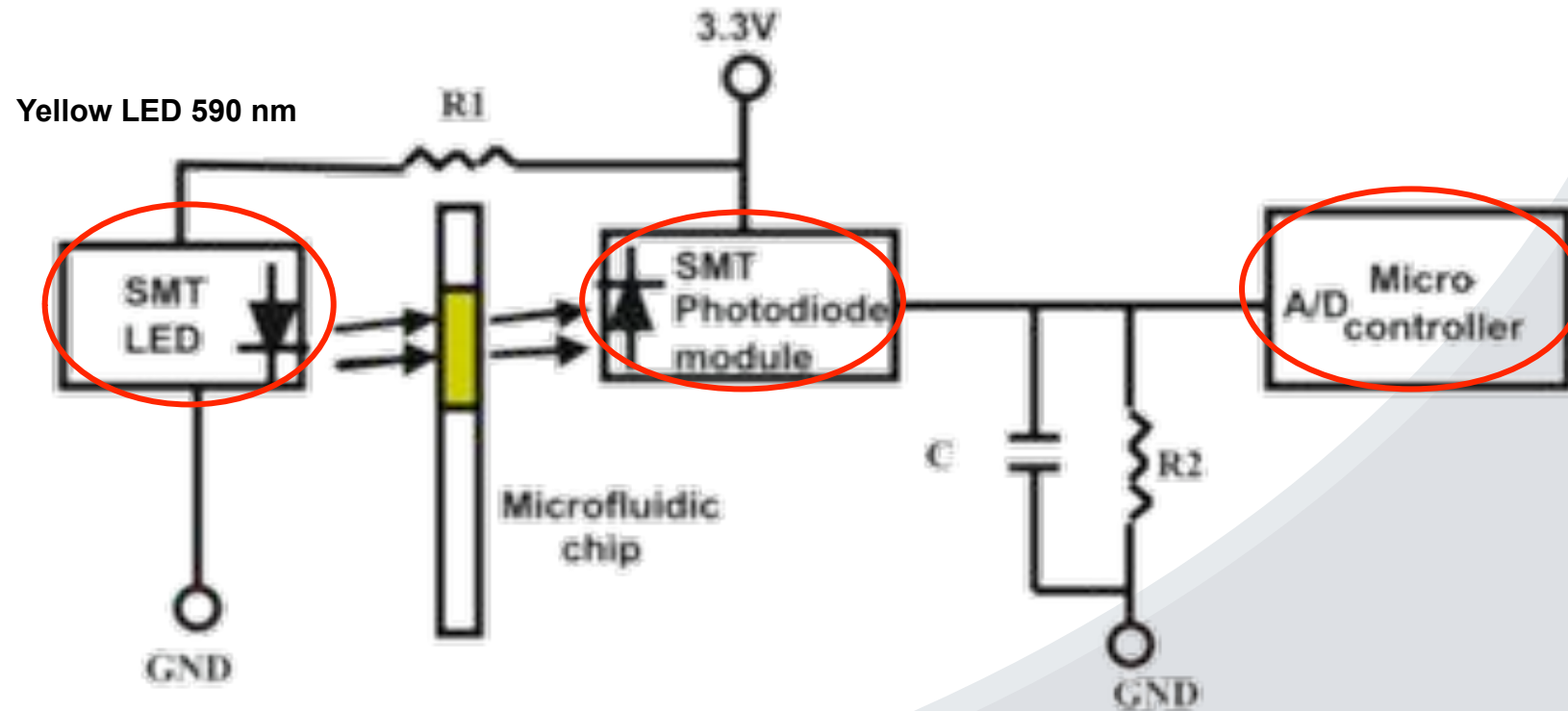

DETECTORS

Wired detector

smLED

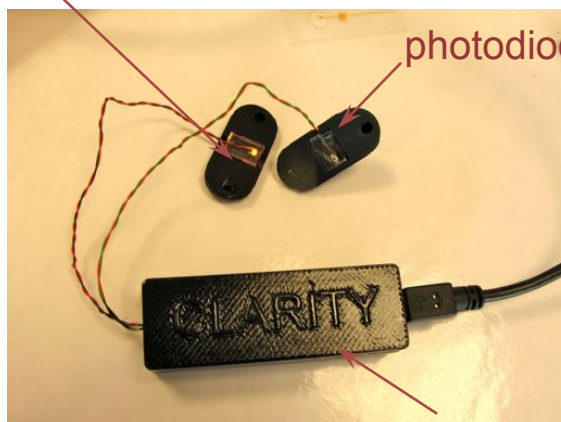

photodiode

Microcontroller

Wireless detector

- ✓ Microcontroller
- ✓ Battery Pack
- ✓ Transmitter

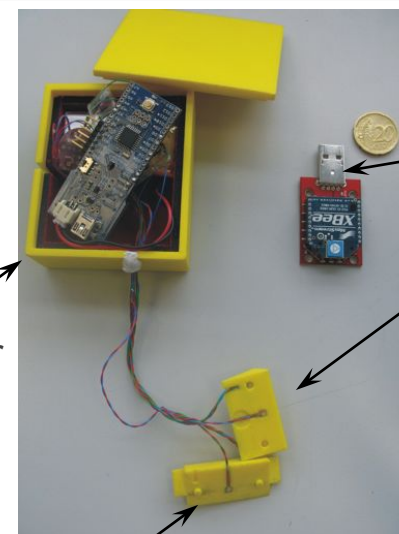

radio receiver

photodiode

smLED

smLED

Portable detector

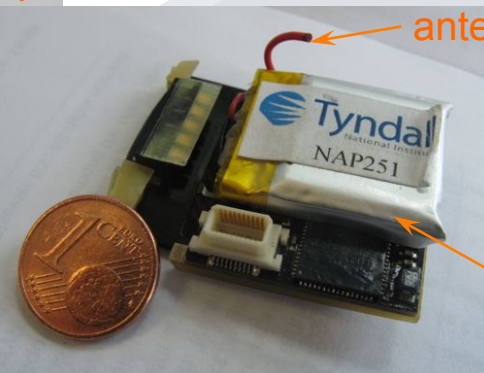
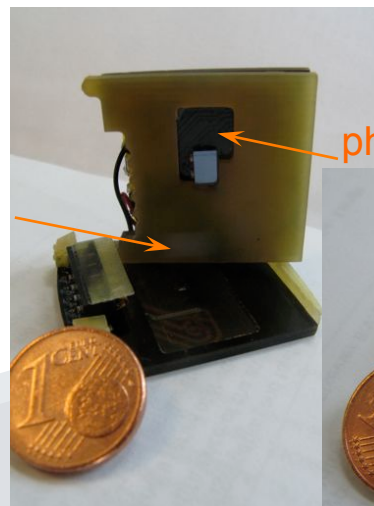

antenna

- ✓ Microcontroller
- ✓ Battery Pack

MICRO-DEVICE: Fabrication

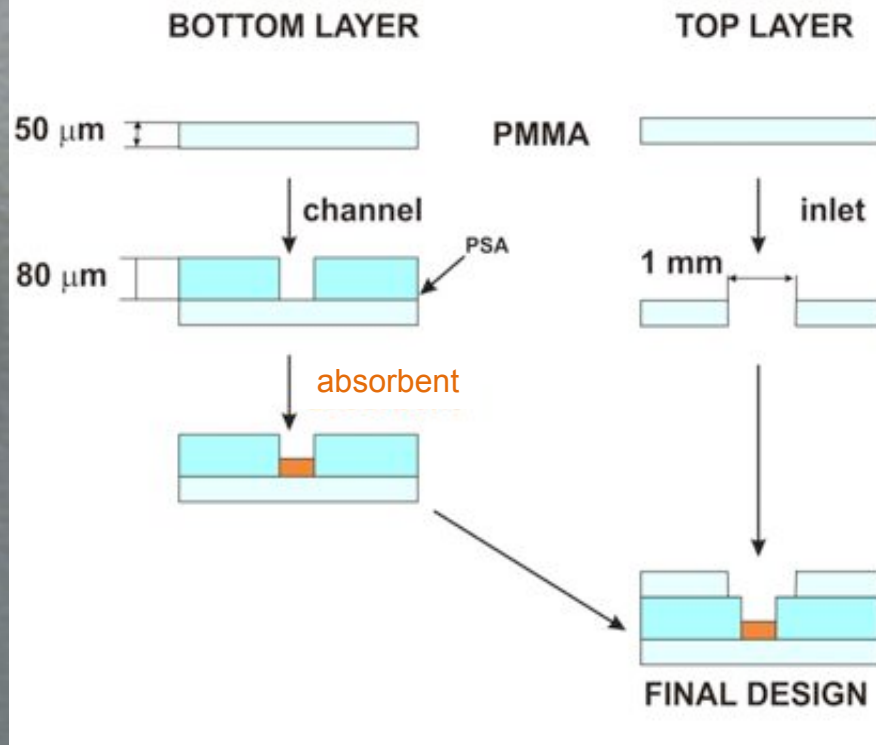
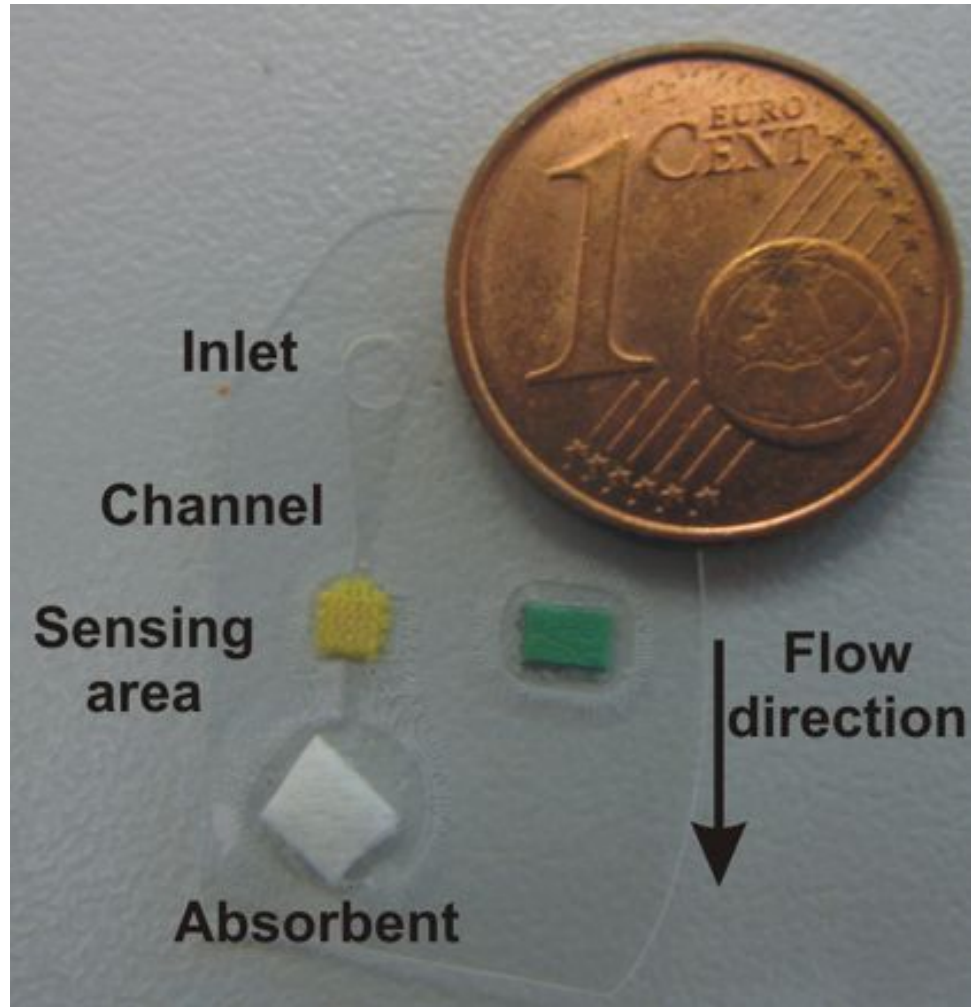

Main Characteristics:

- pH dye bromocresol purple
- Absorbent = passive pump

MICRO-DEVICE: Characterisation

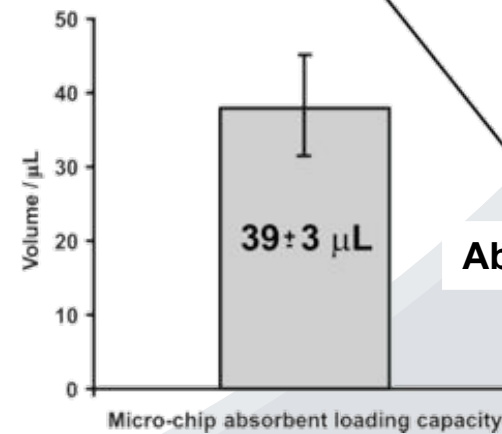

Absorbent

Loading capacity of the absorbent

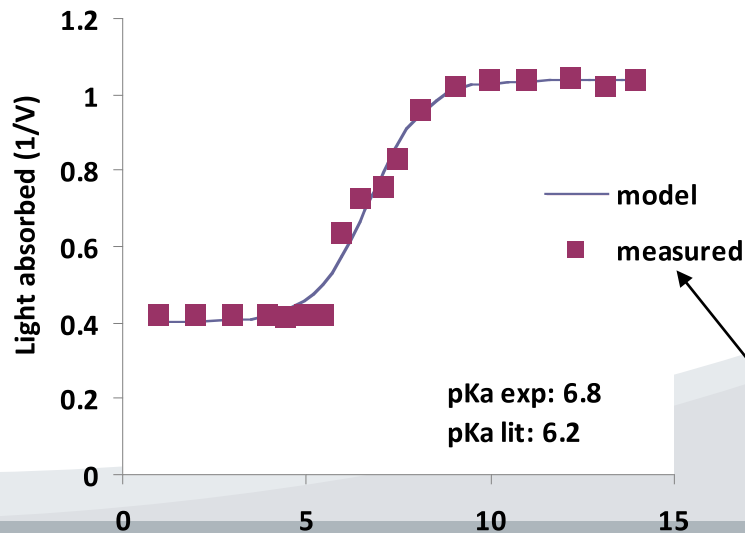

pKa determination of Bromocresol purple in the chip

PERFORMANCE

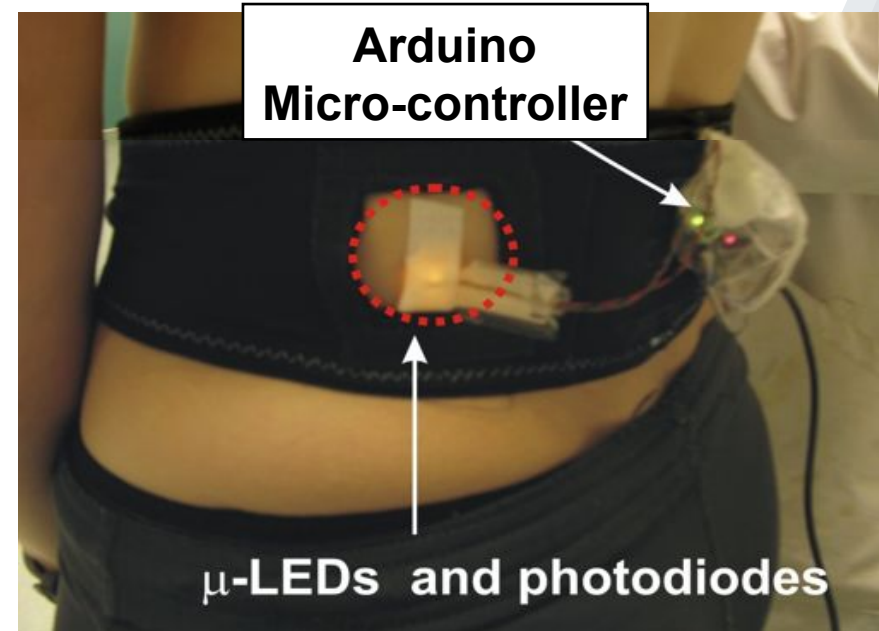

LED-PHOTODIODE STABILITY

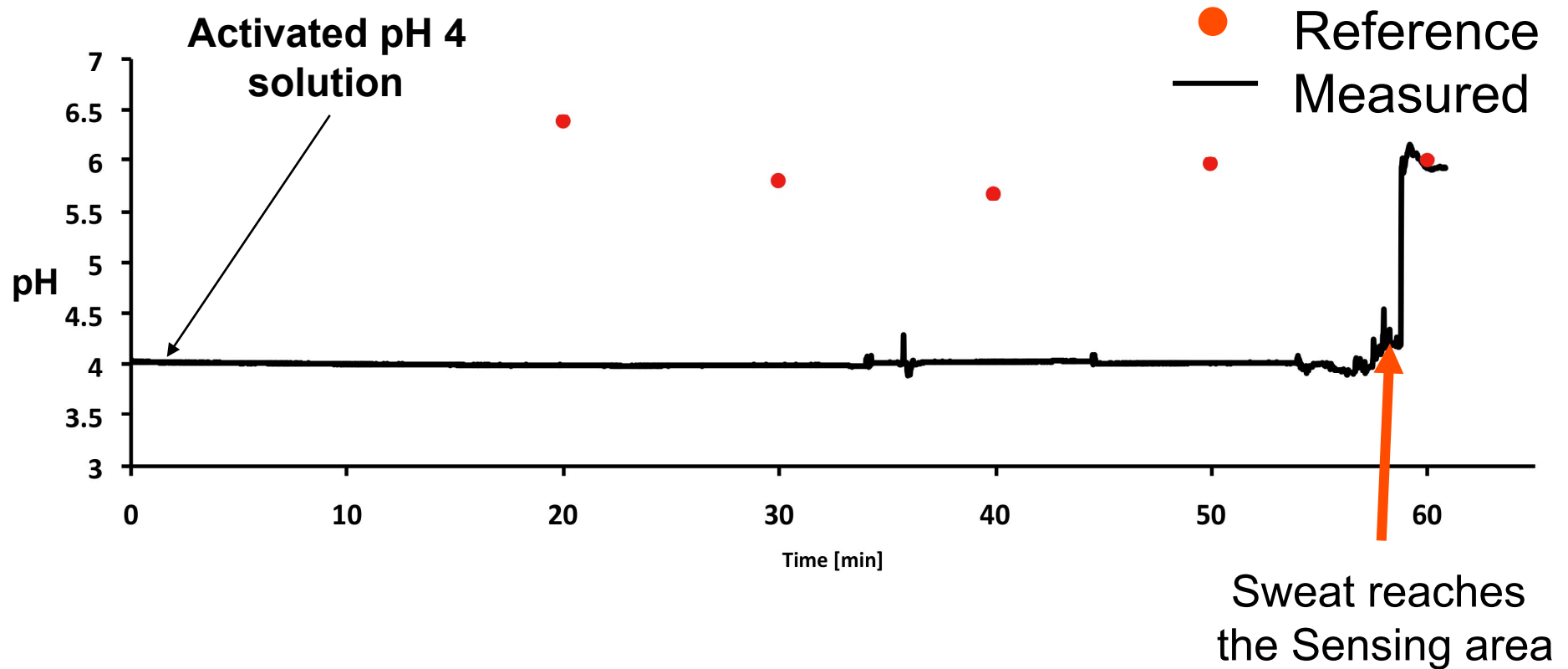

**Stability of the signal after 50 min. exercise.
LED alignment is not perturbed with athlete movement**

MICRO-DEVICE: Fabrication

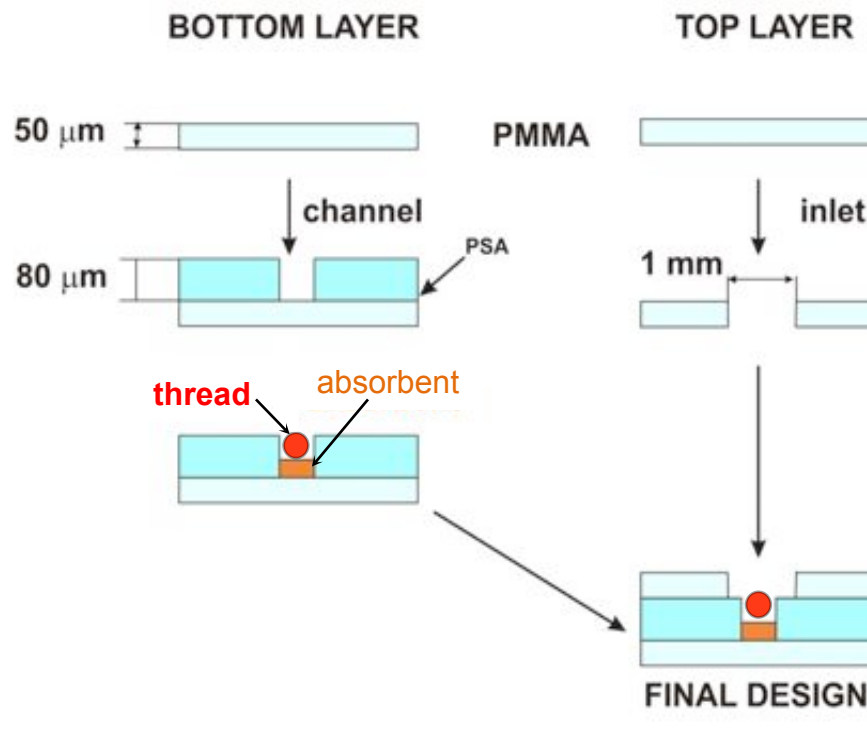
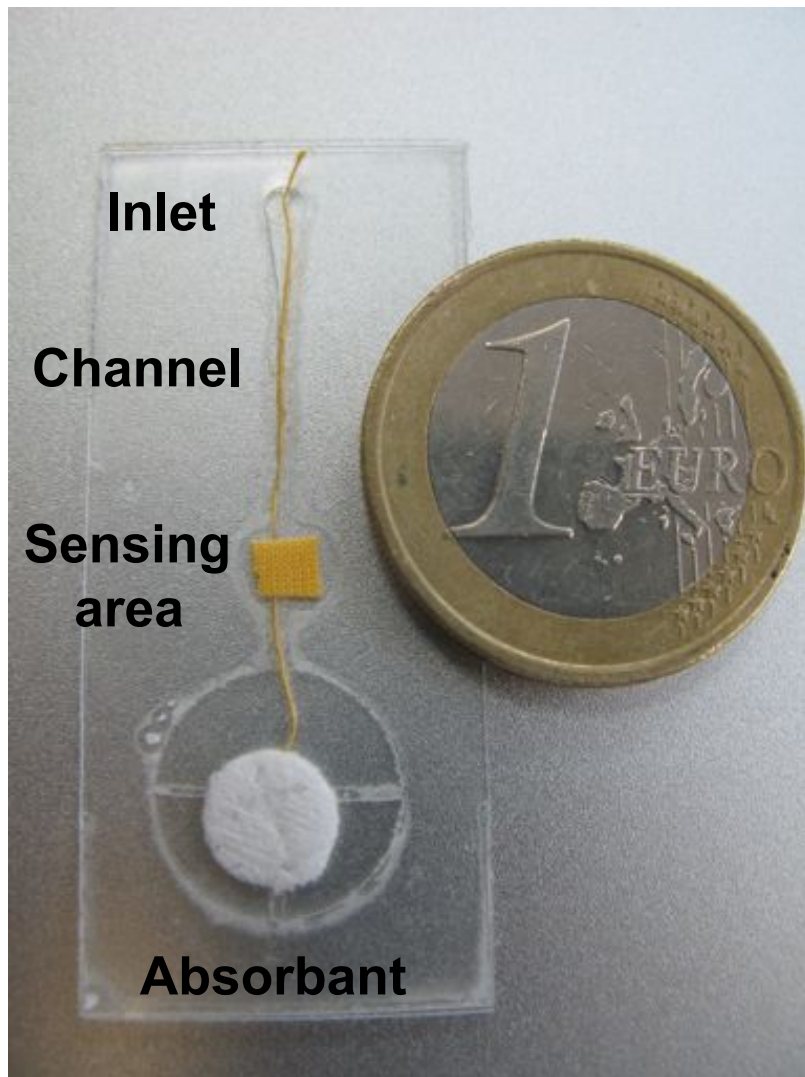

- pH dye bromocresol purple
- Flow = controlled by the thread
- Absorbant = passive pump

MICRO-DEVICE: Characterisation

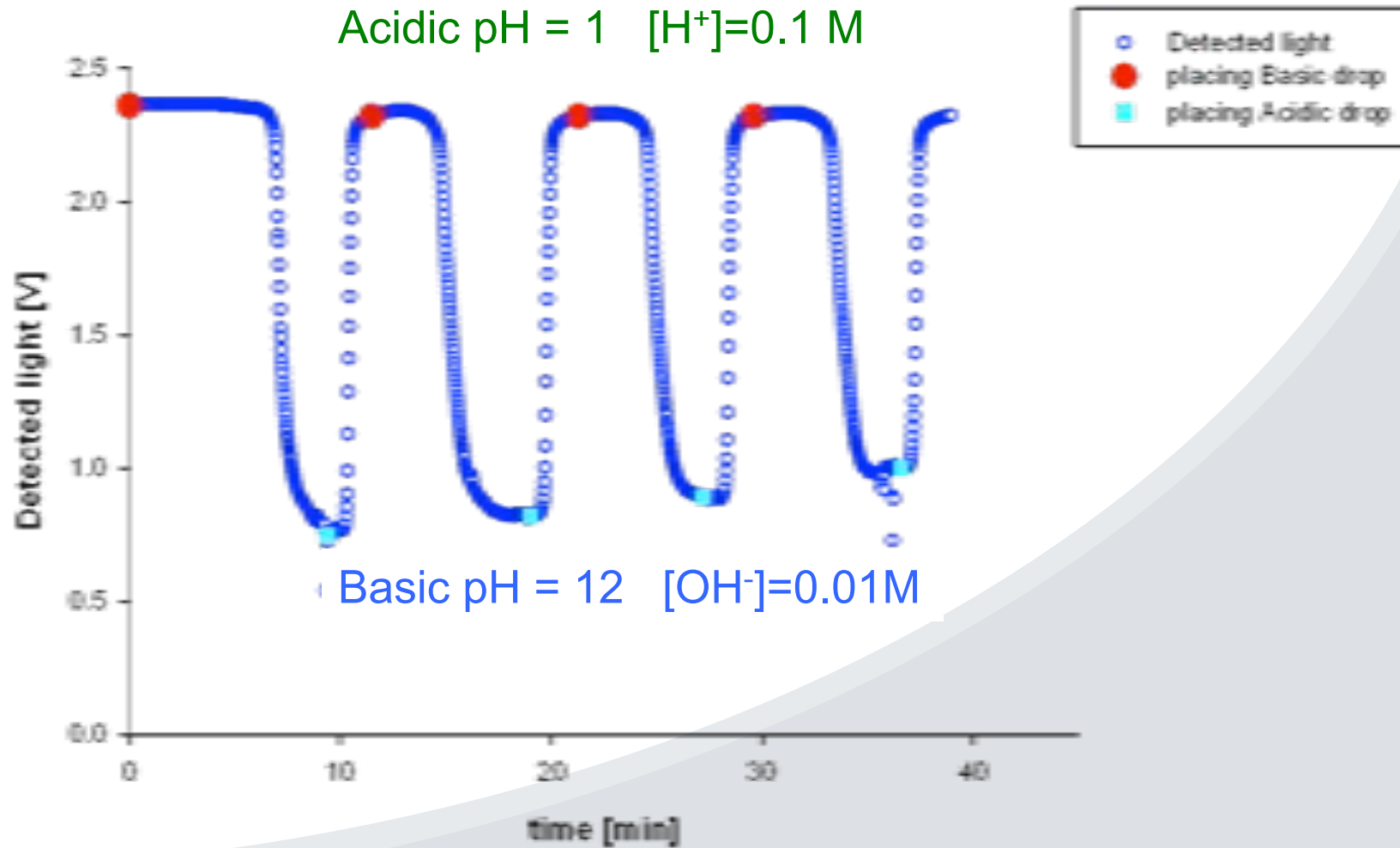

MICRO-DEVICE: Characterisation

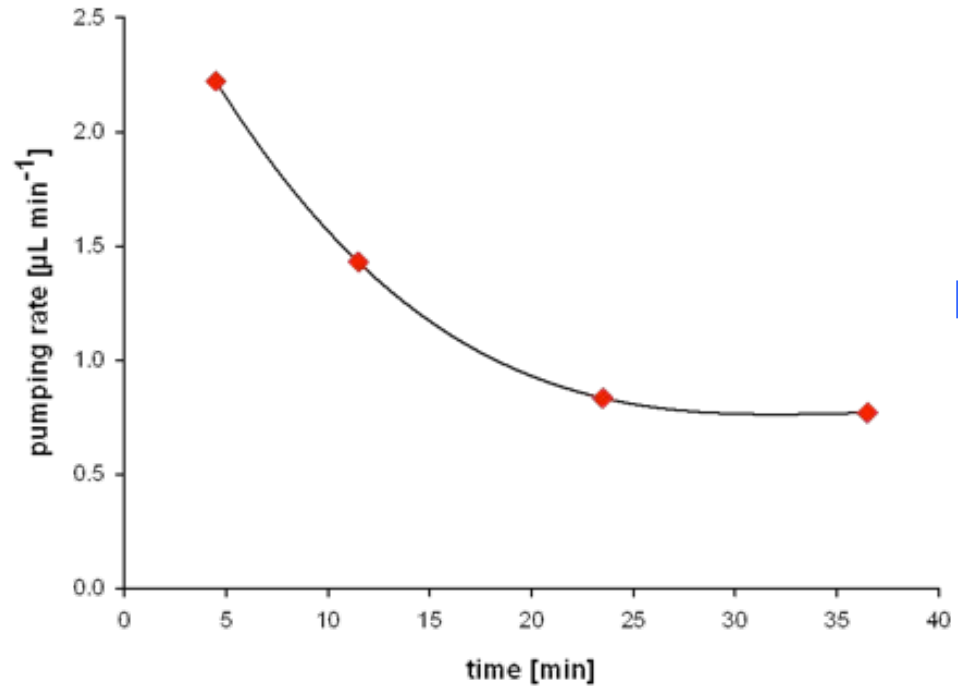

LIFE-TIME: ~ 63 MINUTES

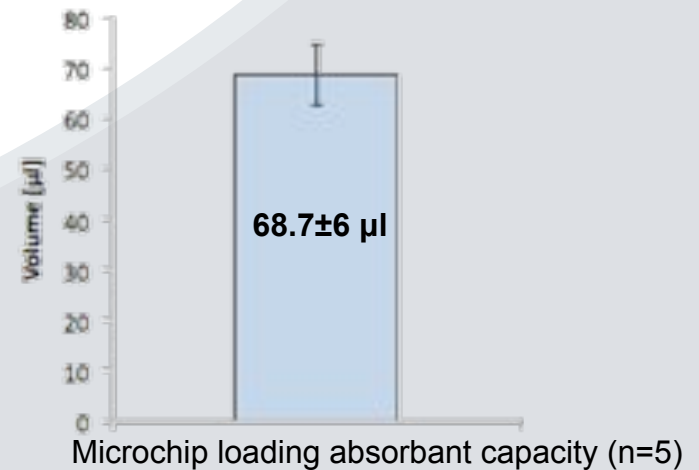
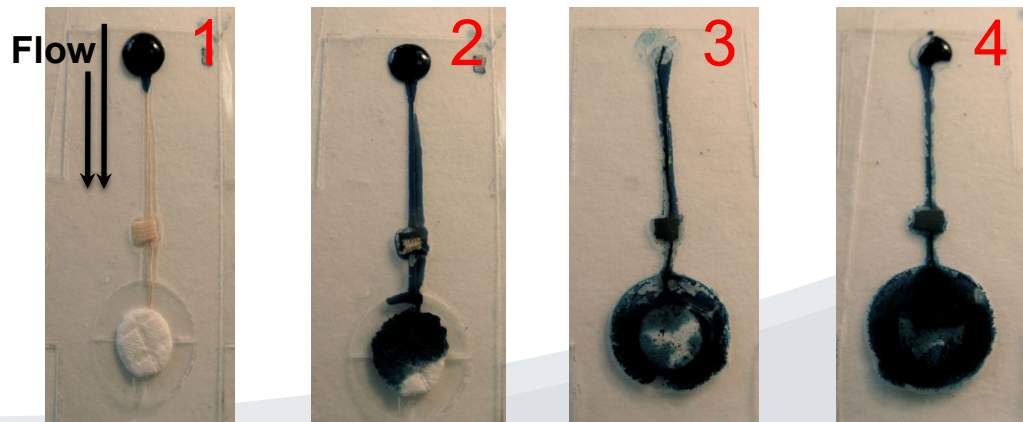

ON BODY TRIAL

Resting time (easy cycling)

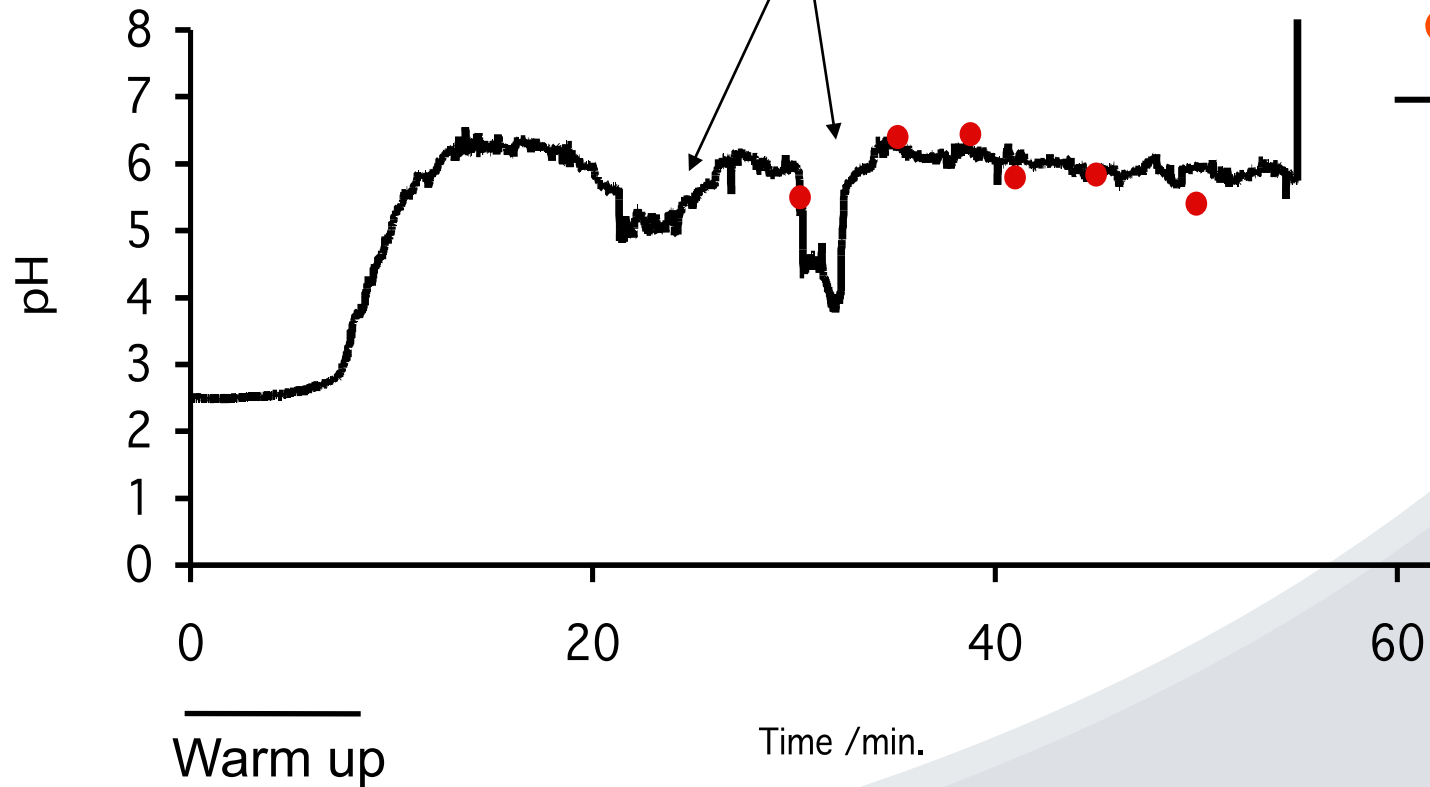

CONCLUSIONS

- The fabrication, characterisation and the performance of a wearable micro-fluidic system based on a textile fabric for monitoring in real time mode the pH of the sweat generated during an exercise period has been presented.
- Miniaturisation of the detector system
- Durability and accuracy of the device during athlete performance.
- Immediate feedback regarding sweat composition, pH, to individuals during sport activities.

FUTURE WORK:

- Run on body trials using the fully Autonomous Cordless platform by Tyndall.
- Establishment of a correlation between pH of the sweat and other physiological parameters, such as pH and lactate of blood and sweat electrolytes.

Acknowledgements



Dr. Fernando Benito Lopez



Dr. Shirley Coyle



Prof. Dermot Diamond

Dr. Robert Byrne

Prof. Niall Moyna

Ms. Sarah Hughes



Mr. Javier Torres

Eng. Philip Angove



07/CE/I1147



Research Career Start Programme 2010



QUESTIONS?