

# Wireless ion selective electrode autonomous sensing system

*Cormac Fay*<sup>1</sup>, *Salzitsa Anastasova*<sup>1</sup>, *Conor Slater*<sup>1</sup>, *Sandra Teodora Buda*<sup>1</sup>, *Roderick Shepherd*<sup>2</sup>, *Brian Corcoran*<sup>1</sup>, *Noel E. O'Connor*<sup>1</sup>, *Gordon Wallace*<sup>2</sup>, *Aleksandar Radu*<sup>1,\*</sup>, *Dermot Diamond*<sup>1,\*</sup>

<sup>1</sup>CLARITY: Centre for Sensor Web Technologies, Dublin City University, Dublin, Ireland.

<sup>2</sup>Intelligent Polymer Research Institute, ARC Centre of Excellence for Electromaterials Science, University of Wollongong, NSW, Australia.

\*To whom correspondence should be addressed: [aleksandar.radu@dcu.ie](mailto:aleksandar.radu@dcu.ie) ([aleksandar.radu@port.ac.uk](mailto:aleksandar.radu@port.ac.uk)), [dermot.diamond@dcu.ie](mailto:dermot.diamond@dcu.ie)

## Abstract

A paradigm shift in sensing methods and principles is required to meet the legislative demands for detecting hazardous substances in the molecular world. This will encompass the development of new sensing technologies capable of performing very selective and sensitive measurements at an acceptable cost, developed by multidisciplinary teams of chemists, engineers and computer scientists to harvest information from a multitude of molecular targets in health, food and the environment. In this study we present the successful implementation of a low-cost, wireless chemical sensing system that employs a minimum set of components for effective operation. Specifically, our efforts resulted in a wireless, tri-electrode, ISE pH sensor for use in environmental monitoring. Sensor calibration and validated in-situ field trials have been carried out and are presented in this paper.

**Keywords:** Ion-selective electrode, reference electrode, potentiometry, water analysis, environmental monitoring, wireless, autonomous, sensing

## 1 Introduction

It has been well recognised that harmful substances are either directly harmful to human health or affect us adversely through their negative effect on the environment [1, 2, 3]. Furthermore, some of the most hazardous substances/pollutants are beyond our natural sensing capabilities. For instance, substances such as asbestos, certain chemical pollutants in water and air, radiation, radon gas etc. can cause serious health issues including cancer, birth defects and even death [4, 5, 6]. Due to their harmful nature, there is no doubt that these substances need policing/monitoring which is why local and global environmental agencies have been established to regulate acceptable levels (Environment Protection Agency, Office of Environment Enforcement, Office of Ground Water and Drinking Water, Water Quality Association etc.). To achieve this, in the first instance, the world constantly looks to the molecular sensor research community to develop chemo-responsive materials capable of detecting the presence of these key molecular targets, so that the resulting data can be communicated to regulating authorities. Although new breakthroughs in sensing techniques are constantly taking place, it has

proven difficult to progress the work beyond the bench top (laboratory) environment and sadly much of this work is abandoned after publication in the scientific literature. What is often missing in this research is close association with engineers who can further advance these research outputs towards prototype instruments that can be applied to real field measurements.

Over the past several decades the world has undergone a communication revolution and today we have devices that easily connect people, places and objects. The integration of inexpensive chemical/biological sensors with digital communication devices is intuitively an attractive proposition [7], which could lead to large amounts of molecular information related to our personal health, the condition of our food and the state of our environment becoming accessible. However, although wireless sensor network (WSN) research is expanding rapidly, there are very few examples that integrate molecular sensing, because of the many underlying practical problems associated with chemical and biological sensors [8]. In fact, the need to develop low-cost, low power sensing devices capable of monitoring air, water and soil much more extensively and frequently than is now possible, with significantly lower per-sample and per-measurement cost, was highlighted in a recent Analytical Chemistry editorial as the next 'grand challenge' for analytical science [9].

However, in order to meet this challenge, close cooperation between researchers with expertise across many domains is essential, beyond those areas that are normally associated with conventional analytical science. For example, developing and deploying prototype devices in the field that are capable of functioning autonomously for weeks/months unattended, and are able to make data accessible via a live website requires collaboration between analytical scientists, prototyping engineers, and web database specialists [10, 11, 12]. Demand for such data/information will be driven by an expanding legislative environment (Water Framework Directive [13], Kyoto Protocol [14] etc.) and therefore it is likely that the demand for industry/research with appropriate multidisciplinary backgrounds will also rise.

The goal was to bring together elements from the worlds of chemistry, engineering and computer science together to develop an autonomous, wireless device for in-situ measurement of water quality, specifically the development and characterization of a potentiometric chemical sensor, and its associated electronics, wireless communications, and graphical user interface (GUI). Subsequently, the device was used for in-situ measurements of pH at several locations in a river and canal system in the city of Dublin, Ireland. Due to the simple production and low cost of raw materials, we offer the work presented in this study as a basis towards a scalable infrastructure for environmental chemical sensing.

We chose potentiometric sensors (often referred to as ion-selective electrodes, or ISEs) for this project for a number of reasons. ISEs are very simple and yet very sensitive chemical sensors whose detection limits can be as low as parts-per-billion (ppb) in some cases [15]. They are robust, require virtually no power and can be easily miniaturized [16] which makes them excellent candidates for integration into WSNs. For this project, the focus was on pH-sensitive ISEs, although today there are ISEs described for more than 60 ions [17]. The electronic circuitry necessary for ISE data acquisition and wireless data transmission is also fairly simple, which makes the preparation of the wireless sensing system in-house relatively easy. Our platform design was divided into three main sections;

1. Source electronic components that offer package types suitable for bread-board and printed circuit board (PCB) implementations at an acceptable cost.
2. Construct the entire system on breadboard to ensure design functionality.
3. Transfer the design to PCB implementation for a smaller form factor and improved robustness.

The sensor and electronics were fitted within a rugged enclosure for field experiments, and the resulting data streamed to a graphic user interface (GUI) which provided remote access to captured data in real-time. This end-to-end approach provides a template for a range of chemical targets and allows for future expansion of the electronics and software elements.

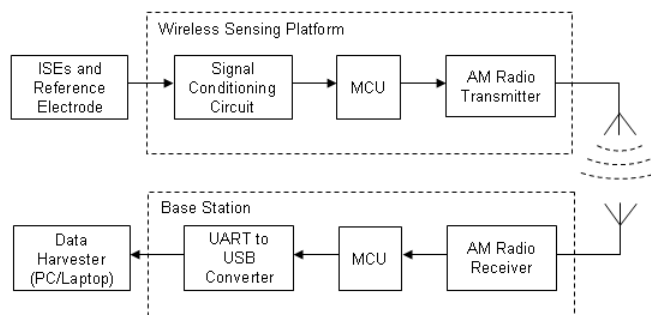

Fig. 1: Block diagram representation of the wireless chemical sensing system's architecture showing the progression of the signal/data from the sensor(s) to the data harvesting system element.

## 2 Materials and Methods

### 2.1 Ion Selective Electrodes Preparation

All chemicals were purchased from Fluka in Selectophore grade. The cocktail for preparing the pH-selective electrodes was made by dissolving 5 mmol/kg of sodium tetrakis-[3,5-bis(trifluoromethyl) phenyl] borate (NaTFPB), 15 mmol/kg of Hydrogen ionophore II (H II), 33 wt% of poly(vinylchloride) (PVC) and 65 wt% of 2-nitrophenyl octyl ether (*o*-NPOE) in 3 ml of unhydrated tetrahydrofuran (THF). The reference electrode membranes were prepared by dissolving 37.5 mg of tetrabutylammonium tetrabutylborate (TBA-TBB), 174.9 mg of *o*-NPOE and 87.5 mg of PVC in 3mL of THF. The ISEs and reference electrodes (REs) were formed using previously prepared platforms and were made using screen-printing technology, as described in the accompanying supplementary information (SI) Section 1 (S1). An intermediate polymer layer, composed of poly (3-octylthiophene-2,5 diyl) (POT), was first deposited on the screen-printed base electrodes by drop-casting using 2.5 mM POT solution in chloroform. Several of such prepared sensors were designated as REs and the cocktail for the RE was drop-cast on top of a dried POT layer. The remaining sensors were designated as pH-selective electrodes and a corresponding cocktail was drop-cast on a dried POT layer. It is important to note that if a screen-printer is not readily available, the ISEs and REs can be made very easily using the additional two protocols described in the SI S1. Prior to use, the pH-selective electrodes were conditioned overnight in a solution of universal buffer ( $10^{-3}$  M citric acid, boric acid and  $\text{Na}_2\text{HPO}_4$ ) at pH=3.5, while the RE was conditioned for two hours in  $10^{-3}$  M KCl. Lab-based calibration was carried out in a solution of universal buffer using  $\text{HNO}_3$  and NaOH to change the pH.

### 2.2 Wireless sensing system

The WISE System can be viewed as an amalgamation of four key system elements, namely: the ISE sensors, wireless sensing platform, base station and data harvester (PC/Laptop). Figure 1 shows the system architecture in block diagram format with each system element and data flow interactions thereof. For explanation purposes, each system element is presented separately and described in the following sub-sections.

#### 2.2.1 ISE sensor

From a circuit design perspective, it is important to note that even if multiple ISEs are used, only a single reference electrode is necessary using the approach in this paper. Therefore, a multi-channel instrument will require only one reference electrode and as many ISE channels as desired. For example, the signal conditioning board developed for this project had three channels; hence it has the capability to record three electrodes at the same time. Note that each ISE had its own individual response characteristics (baseline and slope), and these

can differ significantly, particularly over time as the sensors age. With ISEs, this can manifest as drift in the base line potential or decreasing slope (sensitivity). Furthermore, the initial status of slope and baseline can also vary, for example, due to imprecision in layer deposition arising during fabrication, as described below.

A typical potentiometric cell comprising of a solid-contact ISE and reference electrode (RE) can be represented through a cell diagram 1:



Here, CP denotes the conductive polymer used as an intermediate layer to establish a well-defined redox potential between a gold solid electrode (Au) and polymer membranes serving as the sample contact layer for the ISE and reference electrode (RE). The total potentiometric cell potential depends on the individual contributions of the potentials at each of the phase boundaries in the cell diagram above. Since both the ISE and RE are typically made by hand (see SI S1, ISEs with solid- and liquid-contact) there are often significant variations in each phase boundary potential, which results in sensors with significant variations in their base line potential (i.e. the potential observed in the absence of the primary or target ion). However, using screen-printing technology with a very carefully optimised production protocol, sensors with almost identical characteristics can result, as we have demonstrated in a very recent work [18].

In addition to variations in the base line between each sensor, the response slope will differ to some degree also. These parameters (baseline and slope) are defined by the so-called Nikolskii-Eisenman equation 2:

$$EMF = E_0 + \frac{RT}{z_I F} \log \left( a_I + \sum K_{I,J}^{pot} a_J \right) \quad (2)$$

This form of the equation applies to ions of equal charge.  $E_0$  is a constant potential difference that depends on the RE and temperature, but is independent of the sample composition;  $R$ ,  $T$  and  $F$  are the gas constant, absolute temperature and Faraday constant respectively,  $a_I$  and  $a_J$  is the activity of the primary ion (I) and interfering ion (J), respectively;  $K^{pot}$  is the selectivity coefficient and  $z_I$  is the charge of the primary ion.

The electronics for the ISEs must be able to cope with the fact that a user typically calibrates the sensor, and then needs to be able to adjust the baseline and slope to compensate for electrode-to-electrode variations. In addition to these features, a very important parameter of the electronic circuitry for ISEs is its input impedance. Because potentiometric cells are galvanostatic, ideally no current should be allowed to flow through either the ISE or RE. This is achieved by having an input impedance that is at least three orders of magnitude higher than the resistance of the electrodes. As polymer membrane ISEs typically have a membrane resistance in the order of  $1 - 10 \text{ M}\Omega$  [19], the circuit input impedance should be at least  $10^{10} \Omega$ . This can be achieved using a high input impedance instrumentation amplifier (IA) on the signal input end of the circuit (impedance typically  $10^{12} \Omega$ ).

## 2.2.2 Wireless sensing platform

Initially, the dynamic signal range from the ISE (with reference to the RE) needed to be adjusted to suit the measurement range of the micro controller unit (MCU) i.e.  $0\text{V} - 5\text{V}$ . This was achieved by connecting the electrodes to the inverting and non-inverting inputs, respectively, of an instrumentation amplifier (INA121VA, Texas Instruments, input impedance ca.  $10^{12} \Omega$ ). The signal gain was set using a single resistor across the two gain pins to produce a dynamic range of  $5\text{V}$ , and the adjustable offset was implemented using a standard potential divider at the reference pin to enable the initial baseline potential (in very low concentrations of the primary ion) to be set at near  $0\text{V}$  (see SI S2). Next, the MCU (PIC12F683, Micro Chip Inc. U.S.A) digitizes the conditioned signal via one of its 10-bit analogue-to-digital converter (ADC) channels. Finally, the MCU compiles and organises a minimum packet structure containing the digitized signal data to be transmitted by the AM radio (AM-RT4-433FR, RF Solutions), see SI (S2 Hardware Design) and firmware coding in SI (S3\_WirelessSensor.c).

### 2.2.3 Base station

The base station worked much in the same way as the wireless sensing platform but without conditioning circuitry. Initially, a wireless message/packet was received by the AM radio (AM-HRR3-433, RF Solutions). Subsequently, the MCU (PIC12F683, Micro Chip Inc. U.S.A) interpreted this packet structure, represented it in a meaningful way and forwarded the data to its UART channel, see firmware coding in SI (S3\_BaseStation.c). Ultimately, the USB converter (UB232R, FTDI) acted as an electronic translator where characters/data from the MCU were converted to a format suited for interpretation by a PC/laptop on a standard serial port (see SI S2 Hardware Design).

### 2.2.4 Data harvester

The purpose of the data harvester was three fold, i.e., to gather, store and visualise the data in a meaningful way. All were achieved using a purpose built control program written in the Java programming language. Firstly, the sensor data from the base station (gathered through the serial port) were parsed on a packet-by-packet basis. Next, the data were written to file and stored in Excel format (.xls) for subsequent analysis. Finally, a graphical user interface (GUI), with a visualisation program element, presented the data graphically to the user using a dynamic line plotting tool for real-time analysis, see java coding in SI (S4\_WISESystemGUI.jar).

## 2.3 Calibration of the WISE system

Before real field trials could take place, the completed system needed to be calibrated. This involved exposing the electrodes (connected to the WISE system as in Figure 4) to various concentrations of pH. Firstly, the electrodes were placed in a solution which was kept in a homogeneous state via a magnetic stirrer (728 Stirrer, Metrohm). In addition, a pH meter (RE 357 Series 3, EDT Instruments) was used as reference for pH concentration measurements. After that, the pH of the solution was altered by additions of KOH and HCl resulting in a pH range of ca. 2 to ca. 12. The response of the WISE system and the pH reported by the pH meter were noted once an incremental change in pH occurred.

## 3 Results and discussion

### 3.1 Chemical sensor (pH-selective and reference electrode)

In order to fabricate a potentiometric cell, two types of electrodes must be prepared: the ISE and the RE. Since we were planning to demonstrate the WISE System for water quality monitoring, we chose to develop a pH-selective ISE as this is the most common chemical measurement used to determine water quality. For the RE, we chose a polymer membrane-based, liquid junction-free RE format recently demonstrated by Mattinen et al. due to its excellent characteristics and simplicity of preparation [20]. Figure 2 depicts a typical characterization protocol that we employed to study the stability of the RE. The protocol involved changing the type and concentration of the electrolyte as seen in the figure. The protocol commenced by exposing the electrodes to 0.1 M KCl followed by exposure to  $10^{-4}$  M KCl,  $10^{-4}$  M NaCl, 0.1 M NaCl, and finished with the initial solution of 0.1 M KCl. The results show the behavior of this polymer membrane-based RE (blue line) in comparison to a commercially available Ag/AgCl RE (Fluka 16811, red line). An ideal RE should exhibit no change in signal when exposed to various electrolyte types. While the polymer membrane RE shows more drift and variability than the commercial (Fluka) RE, it was deemed satisfactory for the purposes of this project in view of its ease of fabrication, planar form and compatibility with the ISE fabrication (i.e. batches of ISEs and REs could be easily produced at very low cost).

Figure 3 depicts a typical calibration curve of the pH-selective electrode in combination with the polymer-based RE. Measurements were taken using a potentiometric bench top reference instrument (EMF16 Interface, Lawson Labs Inc.). The effective pH range was determined according to the IUPAC definition of the detection limit for ISEs – i.e. the intersection of the Nernstian slope and the horizontal base line at each limit (high, low concentrations). For the electrode shown in the figure, the active range spans 7.5 pH units (from pH=2

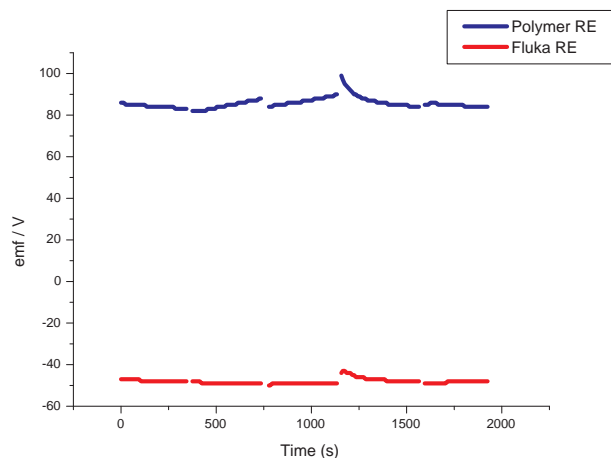

Fig. 2: Comparison of polymer membrane-based (blue, top) and Fluka (red, bottom) reference electrodes responses to various electrolytes.

to pH=9.5). Such a wide pH range is very well suited for environmental pH values expected in polluted environmental waters.

For the signal conditioning circuitry, this concentration range theoretically translates to a dynamic signal range of the pH-RE cell of ca. 450 mV. For example, against the Fluka commercial glass RE, the pH electrode signal spanned from ca. 400 mV to ca. -20 mV. In contrast, against the polymer membrane-based RE, the voltages ranged from ca. 770 mV to ca. 320 mV. Note that approximate voltage values are mentioned because the voltage range differed between electrodes from the same batch and also from different batches due to manufacturing issues as discussed above. Clearly, from the above results, it is critical that the electronic circuit is able to both offset the signal, so that the lowest voltage is around 0V, and apply a gain of about x10, to optimise the signal for the amplifier input range of 0V to +5V.

### 3.2 Data acquisition hardware

Once the signal range and electrical measurements conditions were established through initial testing (see sections 2.2.1 and 3.1) it was possible to develop the signal conditioning circuitry to interface the sensor to the microcontroller. To achieve this, an instrumentation amplifier (IA) was chosen for its high accuracy, low power, low noise, high input impedance and also for its dual signal input, single ended output feature. Furthermore, individual IAs allowed the system to accommodate the response characteristics (unique baseline and slope) of each ISE. This approach therefore reduced the number of components needed in comparison to using stand-alone operational amplifiers and dual signal input lines, which simplifies the circuitry.

A primary goal for the signal conditioning circuitry was to match the dynamic range of the ISE with reference to the RE (i.e. 450 mV) to the measurement range of the microcontroller (i.e. 0 - 5 V). The output voltage,  $V_O$ , from the IA was calculated by:  $V_O = G(V_{IN}^+ - V_{IN}^-)$  where the RE was connected to  $V_{IN}^+$ , and the ISE was connected to  $V_{IN}^-$ . The signal gain,  $G$ , was calculated by:  $G = 1 + \frac{50k\Omega}{R_G}$  where the overall gain depends on a single resistor,  $R_G$ . A resistor of ca. 5 M $\Omega$  was found to suit this criteria computationally, however we implemented this resistance using a standard 10 M $\Omega$ , 25 turn trimmer (variable resistor) to allow for a more flexible system i.e. to enable a range of electrodes with differing characteristics to be tested if needed. To enable negative-going signals to be offset, an instrumentation amplifier (IA) negative power rail was supplied through a DC-DC inverter (MAX1673) allowing for an electrical potential window between -5 V and +5 V. However, to accommodate the measurement range of the microcontroller (i.e. 0V - 5V) a signal offset was applied using

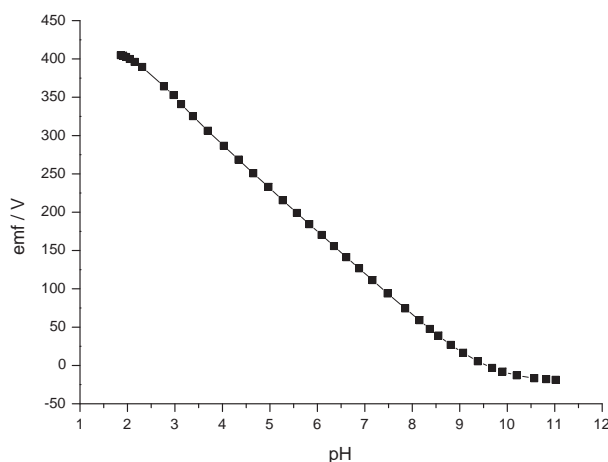

Fig. 3: Calibration curve of a typical pH-selective electrode used in this project. Upper and lower limits for determination of pH were established as pH=2 and pH=9.5. Note that the response of the pH electrode was identical, irrespective of whether the commercial RE or the polymer RE was employed, albeit with the shift of about +370 mV in  $E_0$  for the polymer RE.

a standard potential divider circuit using another standard  $10\text{ M}\Omega$  trimmer connected to the IA's offset pin which again made the system more broadly applicable.

The output of the IA,  $V_O$ , was then passed to an analogue to digital converter (ADC) on the microcontroller unit (MCU) where it was programmed in an endless loop to sample the ADC channel and transmit the values to the base station via the radio. This procedure was repeated across three input channels to enable three ISEs to be continually monitored.

Once the design functionality was proven and tested on bread board, the implementation was successfully ported to a PCB format for increased robustness and compact packaging. Figure 4 depicts the realisation of the wireless sensing platform with screen printed electrodes attached. It can be seen that the node was designed for modularity meaning that the wireless transmitter, conditioning board and electrodes can be replaced with different or upgraded parts as needed. This allows future scope for the system to either interface with readily available WSN infrastructures (i.e. by replacing the transmitter module) or even target different chemical species (i.e. by replacing the electrodes) e.g. sodium (Na), lead (Pb) etc.

Figure 5 shows the realisation of the base station. Its functionality not only included receiving wireless packets, it also doubled as an interface to program the wireless module. It should be noted that the entire base station was powered by the PC via the USB interface for convenience and packaging purposes. Ultimately, the transmitted packet from the wireless node was recompiled by the basestation and transformed into a format suitable for input to the GUI.

Although, it is outside the scope of this project, a number of further improvements can be made to the hardware making it more versatile and accommodating to similar projects. For instance, the introduction of digitally controlled potentiometers can eliminate manual gain/offset tuning and facilitate autonomous adaption of the signal conditioning to variations in the ISE sensors. Also, one can acquire a higher resolution by implementing stand alone ADC ICs, up to ca. 16,000 times more resolution using a 24-bit ADC chipset. However, it should be noted that these improvements would increase the component cost and complexity of the system. Our aim was to realise a wireless chemical sensing system with a component cost of less than €50 and suitable as a low cost, autonomous chemical sensing system.

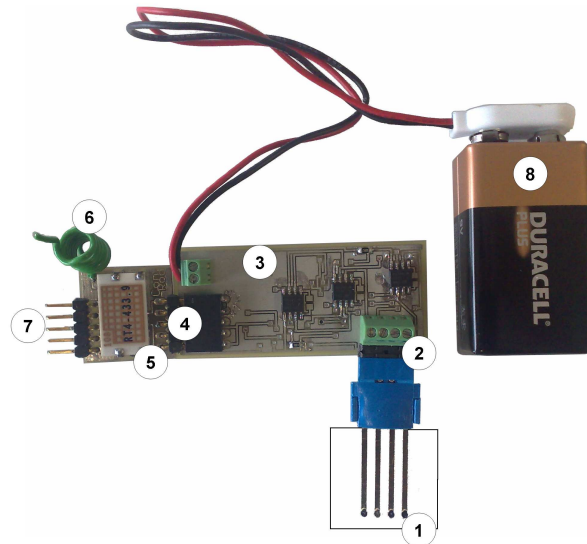

Fig. 4: PCB implementation of the wireless sensing node. (1) screen printed electrodes, (2) terminal block interfacing the electrodes and signal conditioning board, (3) signal conditioning board, (4) interface from the signal conditioning board to the wireless transmitter, (5) wireless AM transmitter module, (6) antenna, (7) programming interface, (8) power source (PP3 9V battery).

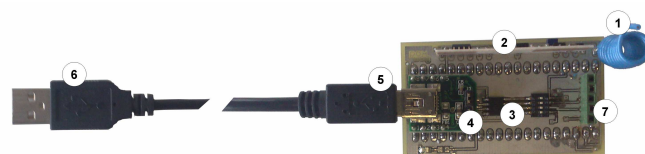

Fig. 5: PCB implementation of the base station. (1) antenna, (2) AM radio receiver, (3) PIC microcontroller, (4) USB to UART transceiver, (5) mini-B USB connection, (6) USB-A connection to PC/Laptop, (7) terminal block for programming the wireless module.



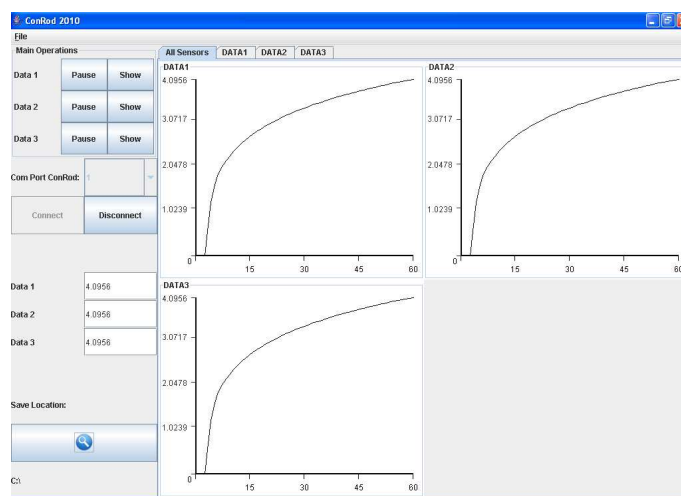

Fig. 6: Screen capture of the WISE system's front-end graphical user interface (GUI).

### 3.3 Front-end graphical user interface

The purpose of the GUI was to provide a simple and yet informative interface to a user not versed in the inner workings of the system (e.g. for regulatory personnel) and deliver a practical end-to-end system template. It was therefore important to present the data in a form that is easy to interpret, for example, through showing trends that change dynamically in real-time both numerically and graphically. In this case, we employed a dynamic plotting line graph through which the user can identify calibration curves as well as significant events during in-situ field validation (see Figure 6).

With reference to Figure 6, the first feature to implement was a simultaneous global view of all ISE plots and yet provide the flexibility to view them individually for an enlarged full screen view ('DATA1', 'DATA2' and 'DATA3' tabs). Note that the axis dynamically changes its scale in accordance to the max sensor value during a 60 second time period (x-axis). With each new streaming packet, the numerical data is also updated in the 'Data 1', 'Data 2' and 'Data 3' text fields. The data is also written and saved to file (using the 'Save Location' button) directly in Microsoft Excel 'xls' format for subsequent analysis. Other additional features have been implemented such as pausing/resuming data capture and showing/hiding the plot in the 'Main Operations' command set.

We chose the Java programming language to write this interface because of its cross-platform capability, ease of use, extensibility, speed of programming and flexibility for future development e.g. forwarding to a database and online plotting portals. Furthermore, the same base code has been successfully implemented on a palm top computer (HP iPAQ 114) and easily extended onto smart phones (e.g. iPhone) for fly-by access to data relevant to the quality of the local environment. Finally, we have left scope to easily implement alerts related to events (e.g. threshold crossing) to users in many forms such as window pop ups, emails or even text messages.

### 3.4 In situ field validation of the WISE system

The WISE System was first assembled and tested under controlled laboratory conditions. Figure 7 shows a calibration plot of the WISE system's response to various pH concentrations over a range of ca. 10 pH units. A regression model (Boltzmann) was applied to the data and a very good sigmoidal fit resulted ( $R^2 = 0.996$ ). This allowed us to calculate the pH from the WISE system measurements during field validation trials.

Special attention at this stage of the project was paid to ensure that the platform was physically rugged enough to function in field deployments, and that the structure of the data presentation was appropriate. This was followed by trips to local rivers around Dublin and in situ monitoring of their pH. A map of the sampling locations is given in the supplementary information (see SI S1). In addition, samples of rain (collected on

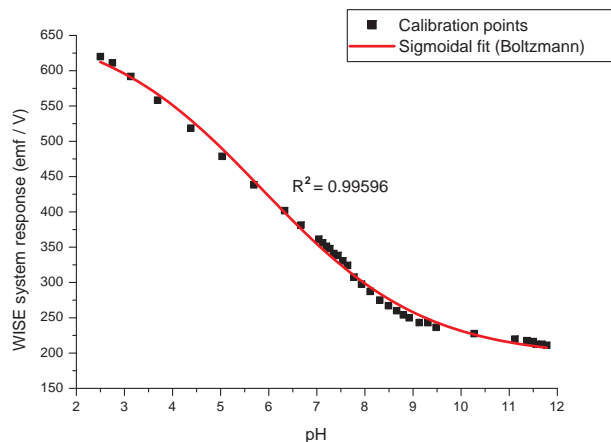

Fig. 7: Calibration of the WISE system to various concentrations of pH. Points represent known pH of the calibration solution (x axis) and the WISE system response (y axis). The line is a sigmoidal fit (Boltzmann model),  $R^2 = 0.99596$

Tab. 1: In situ measurements of pH at a series of environmental samples.

	WISE System	pH-meter	%RE
deionized water	4.30	4.38	1.8
rain water	5.85	5.96	1.8
Tap water	7.93	8.07	1.7
Tolka river (Botanic garden)	7.51	7.33	-2.5
Royal Canal (Charleville Mall)	7.52	7.33	-2.6
Royal Canal (Portland Plaza)	7.95	7.76	-2.4
Royal Canal (Shandon gardens)	7.52	7.43	-1.2
Royal Canal (Royal Canal Av.)	7.94	7.85	-1.1

12/06/2010), as well as tap water and deionized water from the laboratory were also analyzed. The data were validated using a commercially available, portable pH-meter. Table 1 gives the measured pH values for the sampling locations using the WISE System and the portable pH meter. Data were compared and the relative percentage error (%RE) calculated as:  $\frac{B-A}{B} \times 100$  where B and A take the values obtained using the pH-meter and the WISE System, respectively. Excellent correlation between the two data sets was obtained ( $R^2 = 0.991$ ,  $n=8$ ), and the errors were low ( $\%RE \leq 2.6\%$ ).

## 4 Conclusions

In this project we have successfully implemented a novel, autonomous chemical sensing platform capable of streaming data via wireless communications to a remote basestation. The data can easily be accessible via a customised web database, and can be easily integrated as a sensing element into a more comprehensive environmental web portal. We have already commenced a process to demonstrate the scalability and broad applicability of the strategy through parallel activity in the CLARITY Centre. A web portal gathering sensed information on energy consumption in home via a wireless inductive electricity meter has been implemented. Currently, data is harvested from 30 homes (sampling rate 1 point per minute); almost 40 million data points have been gathered over the past two years in this project. Furthermore, the same approach can be easily

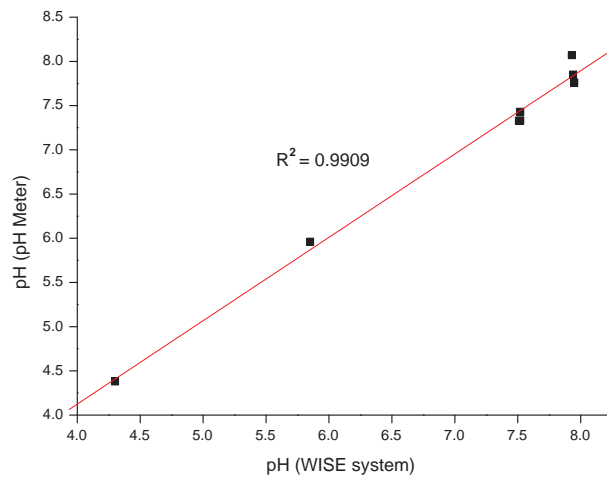

Fig. 8: Correlation plot between the WISE system (x-axis) and the portable pH meter (y-axis); points are in situ results presented in 1, line represents the linear fit.  $R^2 = 0.9909$ .

applied to environmental sensing, as essentially the same tasks apply, i.e. harvest sensed data, stream to a remote web database, make the data available via an attractive and intuitive interface, provide analytical tools (e.g. identify and classify 'events'), provide appropriate feedback to various stakeholder groups, and so on. Through this portal, we have now made environmental data available from a number of field deployments covering landfill greenhouse gas emissions, remote monitoring of gas pressures at landfill sites, and water quality monitoring.

The single most important message to appreciate is that through this integrated approach, much of the data infrastructure development is directly transferrable to new sensors and deployments, such as the pH sensors presented in this paper. This in turn makes the implementation of fully operational environmental sensor networks much more attainable than is possible through isolated efforts that tend to focus on particular aspects of the entire delivery chain for WSNs, rather than the entire system.

## Acknowledgments

This research was supported by Science Foundation Ireland (CLARITY, Centre for Sensor Web Technologies, award no. 07/CE/I1147 and NAP210), and by the EU MATERA Programme (Enterprise Ireland MASTRA - TD/2006/0341). AR also thanks DCU for a Research Fellowship and Research Career Start Award. STB is thankful for DCU-UCD ODYSSEUS internship.

*Please Note:* All code and schematics are free to use for educational/research purposes. For commercial uses, please contact the authors.

## References

- [1] M. V. Hoyer, D. L. Watson, D. J. Wills, and D. E. C. Jr., "Fish kills in florida's canals, creeks/rivers, and ponds/lakes," *Journal of Aquatic Plant Management*, vol. 47, pp. 53–56, 2009.
- [2] S. N. Al-Bahry, I. Y. Mahmoud, K. I. A. Al-Belushi, A. E. Elshafie, A. Al-Harthy, and C. K. Bakheit, "Coastal sewage discharge and its impact on fish with reference to antibiotic resistant enteric bacteria and enteric pathogens as bio-indicators of pollution," *Chemosphere*, vol. 77, pp. 1534–1539, DEC 2009.

- [3] B. Austin, *The involvement of pollution with fish health*, pp. 13–30. Multiple Stressors: A Challenge for the Future, The Netherlands: Springer, 2007.
- [4] M. Yasuda, T. Hanagiri, Y. Shigematsu, T. Onitsuka, K. Kuroda, T. Baba, M. Mizukami, Y. Ichiki, H. Uramoto, M. Takenoyama, and K. Yasumoto, “Identification of a tumour associated antigen in lung cancer patients with asbestos exposure,” *Anticancer Research*, vol. 30, pp. 2631–2639, JUL 2010. Article.
- [5] V. G. Khurana, L. Hardell, J. Everaert, A. Bortkiewicz, M. Carlberg, and M. Ahonen, “Epidemiological evidence for a health risk from mobile phone base stations,” *International Journal of Occupational and Environmental Health*, vol. 16, pp. 263–267, JUL-SEP 2010. Article.
- [6] V. Kazakov, E. Demidchik, and L. Astakhova, “Thyroid cancer after chernobyl,” *Nature*, vol. 359, p. 21, SEP 3 1992.
- [7] D. Diamond, “Internet-scale sensing,” *Analytical Chemistry*, vol. 76, pp. 278A–286A, Aug 2004.
- [8] R. Byrne and D. Diamond, “Chemo/bio-sensor networks,” *Nature Materials*, vol. 5, pp. 421–424, Jun 2006.
- [9] R. W. Murray, “Challenges in environmental analytical chemistry,” *Analytical Chemistry*, vol. 82, pp. 1569–1569, Mar 2010.
- [10] C. Slater, J. Cleary, K. T. Lau, D. Snakenborg, B. Corcoran, J. P. Kutter, and D. Diamond, “Validation of a fully autonomous phosphate analyser based on a microfluidic lab-on-a-chip,” *Water Science and Technology*, vol. 61, no. 7, pp. 1811–1818, 2010. Article.
- [11] J. Cleary, C. Slater, C. McGraw, and D. Diamond, “An autonomous microfluidic sensor for phosphate: On-site analysis of treated wastewater,” *IEEE Sensors Journal*, vol. 8, pp. 508–515, MAY-JUN 2008. Article.
- [12] C. Fay, K.-T. Lau, S. Beirne, C. . Conaire, K. McGuinness, B. Corcoran, N. E. O’Connor, D. Diamond, S. McGovern, G. Coleman, R. Shepherd, G. Alici, G. Spinks, and G. Wallace, “Wireless aquatic navigator for detection and analysis (wanda),” *Sensors and Actuators B: Chemical*, vol. 150, no. 1, pp. 425 – 435, 2010.
- [13] The European Commission for the Environment, “The eu water framework directive.”
- [14] United Nations Framework Convention on Climate Change, “Kyoto protocol.”
- [15] A. Radu, S. Peper, E. Bakker, and D. Diamond, “Guidelines for improving the lower detection limit of ion-selective electrodes: A systematic approach,” *Electroanalysis*, vol. 19, no. 2-3, pp. 144–154, 2007. Times Cited: 7 11th International Conference on Electroanalysis of the European-Society-for-Electroanalytical-Chemistry JUN 11-15, 2006 Univ Bordeaux, Natl Engn Sch Chem & Phys, Bordeaux, FRANCE.
- [16] E. Lindner and R. E. Gyurcsanyi, “Quality control criteria for solid-contact, solvent polymeric membrane ion-selective electrodes,” *Journal of Solid State Electrochemistry*, vol. 13, no. 1, pp. 51–68, 2009.
- [17] E. Pretsch, “The new wave of ion-selective electrodes,” *TrAC Trends in Analytical Chemistry*, vol. 26, no. 1, p. 46, 2007.
- [18] A. Radu, S. Anastasova-Ivanova, C. Fay, J. Bobacka, A. Lewenstam, and D. Diamond, “Low cost, calibration-free sensors for in situ determination of natural water pollution,” in *IEEE Sensors 2010*, p. accepted, 2010.
- [19] A. Radu, S. Anastasova-Ivanova, B. Paczosa-Bator, M. Danielewski, J. Bobacka, A. Lewenstam, and D. Diamond, “Diagnostic of functionality of polymer membrane - based ion selective electrodes by impedance spectroscopy,” *Analytical Methods*, vol. 1, pp. 1759–9660, 2010.
- [20] J. Bobacka and A. L. M. U., “Solid-contact reference electrodes based on lipophilic salts,” *Electroanalysis*, vol. 21, no. 17-18, pp. 1955–1960, 2009.