

Design and Operational Performance of Advanced Naturally Ventilated Buildings

by

Sung Min Hong

The Bartlett School of Graduate Studies
University College London



A Dissertation submitted in part fulfilment of the
degree of Master of Science Built Environment:
Environmental Design and Engineering

September 2008

UMI Number: U593719

All rights reserved

INFORMATION TO ALL USERS

The quality of this reproduction is dependent upon the quality of the copy submitted.

In the unlikely event that the author did not send a complete manuscript and there are missing pages, these will be noted. Also, if material had to be removed, a note will indicate the deletion.



UMI U593719

Published by ProQuest LLC 2013. Copyright in the Dissertation held by the Author.
Microform Edition © ProQuest LLC.

All rights reserved. This work is protected against
unauthorized copying under Title 17, United States Code.



ProQuest LLC
789 East Eisenhower Parkway
P.O. Box 1346
Ann Arbor, MI 48106-1346

Acknowledgements

First of all, I would like to take this opportunity to thank my supervisor Dr. Dejan Mumovic from the Bartlett School of Graduate Studies, for all the invaluable advice, co-operation, patience and support throughout the production of this dissertation. I also express my gratitude to the entire faculty for their help and guidance during my studies, particularly course director Dr. Ben Croxford.

I would also like to express my gratitude to Mr. Adrian Hobson, the facilities manager of National Assembly for Wales, for his courtesy at the site visit and Mr. David Anderson, the facilities manager of University College London, for providing valuable information on School of Slavic and East European Studies which was of great help in completing the dissertation.

Finally, I thank my colleagues in the MSc Environmental Design and Engineering 2007/08 program for their support and help throughout the course, and my family for their invaluable support throughout the study.

Abstract

In the context of growing awareness of the implications of global warming and the rising fuel cost, reducing energy consumption in the building sector, which account for significant proportion of total energy consumption and the subsequent CO₂ emission, holds considerable potential in confronting the problems at hand and in the near future.

Natural ventilation is a passive means of ventilating buildings via utilisation of natural forces that can reduce the energy consumption from air-conditioning systems, a common feature in modern non-domestic buildings, which account for almost half of the energy consumption in buildings. With surge of interest in the advanced natural ventilation system and stack ventilation in recent years, numerous buildings have demonstrated feasibility of maximising natural ventilation system in an urban environment.

This dissertation addresses the theories behind the design of naturally ventilated buildings to form a basis for understanding complicated advanced natural ventilation systems. Moreover, the design of advanced natural ventilation system in five buildings - Heelis, National Assembly for Wales, School of Slavonic and East European Studies, Lanchester Library and Harm A. Weber Library - are analysed in detail, to present information on the exemplar cases of advanced naturally ventilated buildings, together with the operational performance to evaluate the design based on the extent to which it reduces the energy consumption.

The key findings from case studies and the overview include extensive use of simulation tools which lead to introduction of various innovative design elements that propose overcoming the limitations confronted by the precedent naturally ventilated buildings. In addition, the analysis of operational performance of the buildings revealed relatively stable internal conditions in comparison to the significant difference between the estimated and post occupancy energy consumption. Moreover, a proposition has been made to expand the taxonomy for advanced naturally ventilated buildings.

In summary, the dissertation has revealed that there was immense development in the design of natural ventilation systems, some incorporating mixed-mode, where adequate internal conditions were maintained while keeping relatively high proportion of the system as natural ventilation. However, in terms of energy consumption, it was revealed that there is still much attention to be given concerning high consumption figures from buildings which degrade the purpose of applying natural ventilation.

Table of Contents

| | | |
|----------|---|-------------|
| 1 | Introduction..... | 1 |
| 1.1 | Climate change and the rising fuel price | 1 |
| 1.2 | HVAC system and natural ventilation | 2 |
| 1.3 | Simple to advanced natural ventilation..... | 4 |
| 2 | Methodology | 6 → |
| 3 | Theoretical Background | 11 |
| 4 | Design Requirements and Site Analysis..... | 14 |
| 4.1 | Client brief and design requirements | 14 |
| 4.2 | Microclimate and weather data | 14 |
| 4.3 | Air pollution..... | 15 |
| 4.4 | Noise | 15 |
| 5 | Developing a Ventilation Design Strategy | 16 → |
| 5.1 | Single sided ventilation | 16 |
| 5.1.1 | Single sided ventilation, single opening (Figure 7a): | 16 |
| 5.1.2 | Single sided ventilation, double opening (Figure 7b):..... | 16 |
| 5.2 | Cross-ventilation | 17 |
| 5.3 | Stack ventilation | 19 |
| 5.4 | Mechanically assisted ventilation | 21 |
| 5.5 | Further refinements | 23 |
| 5.6 | Integration of basic strategies | 24 |
| 5.7 | Design performance evaluation | 25 |
| 5.7.1 | Mathematical Models..... | 25 |
| 5.7.2 | Physical Models | 26 |
| 5.8 | Detailed design | 28 |
| 5.8.1 | Ventilation components | 28 |
| 5.8.2 | Control Systems..... | 29 |
| 5.9 | Theory and practice | 30 |
| 6 | Case Study 1: Heelis..... | 31 → |
| 6.1 | Site analysis..... | 32 |
| 6.2 | Building form | 34 |
| 6.3 | Ventilation components and control | 34 |
| 6.4 | Ventilation strategy..... | 35 |
| 6.5 | Seasonal operation..... | 37 |
| 6.6 | Operational performance | 37 |
| 6.7 | Overview | 40 |
| 7 | Case Study 2: National Assembly for Wales..... | 41 → |
| 7.1 | Site analysis..... | 42 |

| | | |
|-----------|--|-------------|
| 7.2 | Building form | 44 |
| 7.3 | Ventilation components and control | 44 |
| 7.4 | Ventilation strategy..... | 45 |
| 7.4.1 | Public area: café, reception area and gallery..... | 46 |
| 7.4.2 | Offices and meeting rooms..... | 47 |
| 7.4.3 | Debating chamber and viewing gallery | 47 |
| 7.5 | Seasonal operation..... | 48 |
| 7.6 | Operational performance | 48 |
| 7.7 | Overview | 49 |
| 8 | Case Study 3: School of Slavonic and East European Studies..... | 50 → |
| 8.1 | Site analysis..... | 51 |
| 8.2 | Building form | 53 |
| 8.3 | Ventilation components and control | 53 |
| 8.4 | Ventilation strategy..... | 54 |
| 8.5 | Seasonal operation..... | 56 |
| 8.6 | Operational performance | 58 |
| 8.7 | Overview | 59 |
| 9 | Case Study 4: Lanchester Library..... | 60 → |
| 9.1 | Site analysis..... | 61 |
| 9.2 | Building form | 62 |
| 9.3 | Ventilation components and control | 63 |
| 9.4 | Ventilation strategy..... | 64 |
| 9.5 | Seasonal operation..... | 67 |
| 9.6 | Operational performance | 67 |
| 9.7 | Overview | 68 |
| 10 | Case Study 5: Harm A. Weber Library | 69 → |
| 10.1 | Site analysis..... | 70 |
| 10.2 | Building form | 71 |
| 10.3 | Ventilation components and control | 72 |
| 10.4 | Ventilation strategy..... | 72 |
| 10.5 | Seasonal operation..... | 75 |
| 10.6 | Operational performance | 75 |
| 10.7 | Overview | 76 |
| 11 | Discussion and Analysis | 77 |
| 12 | Conclusion..... | 83 → |
| 12.1 | Limitations | 85 |
| 12.2 | Further work | 85 |
| 13 | Bibliography..... | 86 → |

List of Figures

| | |
|--|----|
| Figure 1: Atmospheric CO ₂ and CH ₄ concentration level measured in various locations of the World (Source: Hacker, 2007) | 1 |
| Figure 2: Global average land and sea surface temperature from direct thermometer measurements since 1850 (Source: Hacker, 2007) | 2 |
| Figure 3: Comparison of annual CO ₂ emission per treated floor area of PROBE Study buildings (Source: Bordass et. al., 2001) | 3 |
| Figure 4: Wind pressure acting on an isolated building (a) elevation (b) plan..... | 12 |
| Figure 5: Combined buoyancy and wind driven ventilation. Reproduced from CIBSE AM10 (CIBSE, 2005) by permission of the Chartered Institution of Building Services Engineers. | 13 |
| Figure 6: Wind pressure acting on an urban building..... | 14 |
| Figure 7: Single sided ventilation: (a) single opening (b) double opening..... | 17 |
| Figure 8: Cross-ventilation strategy..... | 17 |
| Figure 9: Flow around and inside of a squared roof mounted ventilator | 18 |
| Figure 10: Atrium stack ventilation. Reproduced from CIBSE Guide B2 by permission of the Chartered Institution of Building Services Engineers..... | 20 |
| Figure 11: The stack ventilation strategies (Source: Lomas, 2007) | 21 |
| Figure 12: different ventilation strategies: (a) day time, (b) night time..... | 23 |
| Figure 13: Integration of basic ventilation strategies | 24 |
| Figure 14: Saltbath test. Source: Dr Liora Malki-Epshtein, UCL..... | 27 |
| Figure 15: Main view of the building (Source: photograph by author) | 31 |
| Figure 16: Annual temperature and moisture content data of Bristol, UK (Source: Square One) | 32 |
| Figure 17: Heating and cooling degree hours in Bristol (Source: Square One)..... | 33 |
| Figure 18: Site location and the surroundings (Source: Google) | 33 |
| Figure 19: Interior space (a) atrium space (Source: FCB Studios) (b) courtyard (Source: photo by author) | 34 |
| Figure 20: Ventilation components (a) Inlets on East and West façades (b) security grills (c) snout (Source: photo by author) | 35 |
| Figure 21: TAS simulation model of the building (Source: Max Fordham) | 35 |
| Figure 22: Simplified floor and plan showing air flow and main elements | 36 |
| Figure 23: Natural ventilation strategy: (a) East-West section (b) North-South section (adopted from: Max Fordham) | 36 |
| Figure 24: Summary of annual internal temperatures (Source: Max Fordham)..... | 38 |
| Figure 25: Annual CO ₂ emission of Heelis compared with other buildings and benchmark (Source: Max Fordham..... | 39 |

| | |
|--|----|
| Figure 26: Occupant satisfaction survey result of Heelis in 2006 (Source: Bunn, 2007 pp. 12) | 39 |
| Figure 27: Main view of National Assembly for Wales (Source: photo by author) | 41 |
| Figure 28: Annual temperature and moisture content data of Cardiff, Wales (Source: Square One) | 42 |
| Figure 29: Heating and cooling degree hours in Cardiff (Source: Square One) | 43 |
| Figure 30: Site location and the surroundings (Source: Google) | 43 |
| Figure 31: General form of the building observed from east and west side of the building (Source: photo by author) | 44 |
| Figure 32: Ventilation components (a) west façade (b) view of actuators (c) wind cowl on the roof (Source: photo by author) | 45 |
| Figure 33: Simplified floor and roof plan showing air flow (adopted from RSHP) | 45 |
| Figure 34: View of public areas (Source: photo by author) | 46 |
| Figure 35: Ventilation strategy for public areas (adopted from RSHP) | 46 |
| Figure 36: Ventilation strategy for the meeting chamber (adopted from RSHP) | 47 |
| Figure 37: Main view of the School of Slavonic and East European Studies (Source: photo by author) | 50 |
| Figure 38: Annual temperature and moisture content data of London, UK (Source: Square One) | 51 |
| Figure 39: Variation in the urban heat island intensity across London on 2 August 1999 at 02.00 hours. Temperatures (K) are relative to the rural source. (Source: Watkins et al., 2007) | 52 |
| Figure 40: Site location and the surroundings (Source: Google) | 52 |
| Figure 41: Ventilation components (a) View of the central lightwell (Source: Short and Associates) (b) view of the stair hall (c) exhaust stack (Source: photo by author) | 53 |
| Figure 42: CFD simulation model showing temperature distribution (Source: Lomas et al., 2008a) | 54 |
| Figure 43: Water bath model of SSEES testing down-draught cooling strategy at the BP Institute (Source: Lomas et al., 2008a) | 54 |
| Figure 44: Simplified floor and roof plan illustrating air flow and termination points (adopted from Short et al., 2004) | 55 |
| Figure 45: Winter ventilation strategy (adopted from Short et al., 2004) | 56 |
| Figure 46: Summer ventilation strategy (adopted from Short et al., 2004) | 57 |
| Figure 47: Mid-season ventilation strategy (adopted from Short et al., 2004) | 58 |
| Figure 48: Energy consumption comparison (Source: Short et al., 2004) | 59 |
| Figure 49: Main view of Lanchester Library (Source: Short and Associates) | 60 |
| Figure 50: Annual temperature and moisture content data of Birmingham, UK (Source: Square One) | 61 |

| | |
|--|----|
| Figure 51: Heating and cooling degree hours in Birmingham (Source: Square One) | 62 |
| Figure 52: Site location and the surroundings (Source: Google) | 62 |
| Figure 53: View of interior space (a) library (b) central lightwell (Source: Short and Associates) | 63 |
| Figure 54: Components (a) high level vents to perimeter stack (b) low level inlets from central lightwell to occupied Spaces (Source: Cook et al.) | 63 |
| Figure 55: View of the central lightwell and the vents (Source: Cook et al.) | 64 |
| Figure 56: Internal temperature profile of the ground and third floor for a summer day (Source: Cook et al.) | 64 |
| Figure 57: Images from CFX simulations investigating air temperature and flow (Source: Cook et al.) | 65 |
| Figure 58: Simplified floor and roof plan illustrating air flow and components (adopted from Short et al.) | 65 |
| Figure 59: Simplified supply strategy of Lanchester Library (adopted from Short et al. 2004) | 66 |
| Figure 60: Simplified exhaust strategy of Lanchester Library (adopted from Short et al. 2004) | 66 |
| Figure 61: Internal and external temperatures during the monitoring period (June 2004-June 2005). (Source: Krausse B. et al., 2007) | 67 |
| Figure 62: Main view of Harm A. Weber Library (Source: Judson College) | 69 |
| Figure 63: Annual temperature and moisture content data of Chicago, US (Source: Lomas, 2007) | 70 |
| Figure 64: Site location and the surroundings (Source: Google) | 71 |
| Figure 65: Interior view: (a) architectural studio (b) top of central light well (Source: Judson college) | 71 |
| Figure 66: CFD simulation analysing temperature distribution across level two and four (Lomas et al. 2008b) | 72 |
| Figure 67: Simplified model sub merged in a water bath for simulation (Source: Lomas et al., 2008b) | 73 |
| Figure 68: Simplified floor and roof plan illustrating air flow and termination points (adopted from Short et al., 2007) | 73 |
| Figure 69: Simplified ventilation strategy of Harm A. Weber Library (adopted from Short et al., 2007) | 74 |
| Figure 70: Comparison of monthly heating, cooling and fan energy loads between Standard US academic building and Harm A. Weber Academic Center (Source: Kaiser et al.)..... | 76 |
| Figure 71: Energy consumption comparison between buildings and benchmarks | 82 |

List of Tables

| | |
|---|----|
| Table 1: List of buildings reviewed and excluded in the initial review | 8 |
| Table 2: List of conclusive buildings and their location..... | 9 |
| Table 3: Classification of windows | 28 |
| Table 4: General information of the case study buildings | 77 |
| Table 5: Simulation tools involved in the design process..... | 79 |
| Table 6: Ventilation characteristics of each building and their control methods | 80 |
| Table 7: Buildings categorised into advanced natural ventilation types according to taxonomy proposed by Dr. Kevin Lomas (Lomas, 2007) | 81 |

Chapter 1. Introduction

1 Introduction

1.1 Climate change and the rising fuel price

In recent years, observation on the occurrence of extreme weather conditions, such as heat wave and thunderstorm, around the world and events that indicate the presence of global warming, such as melting ice in the Arctic Ocean and change in local climate, has led to surge of concern and interest towards the way we use energy. While the Global Warming Hypothesis (Hacker, 2007) suggests that the phenomenon is anthropogenic there is an argument that this is just an Earth's natural cycle in which human activities do not account for the warming. However, findings from various researches, that show a rapid increase in atmospheric CO₂ concentration level (Figure 1) since the industrial revolution and the corresponding change in global average temperature (Figure 2), suggests that global warming is a product of additional greenhouse gases emitted from various human activities.

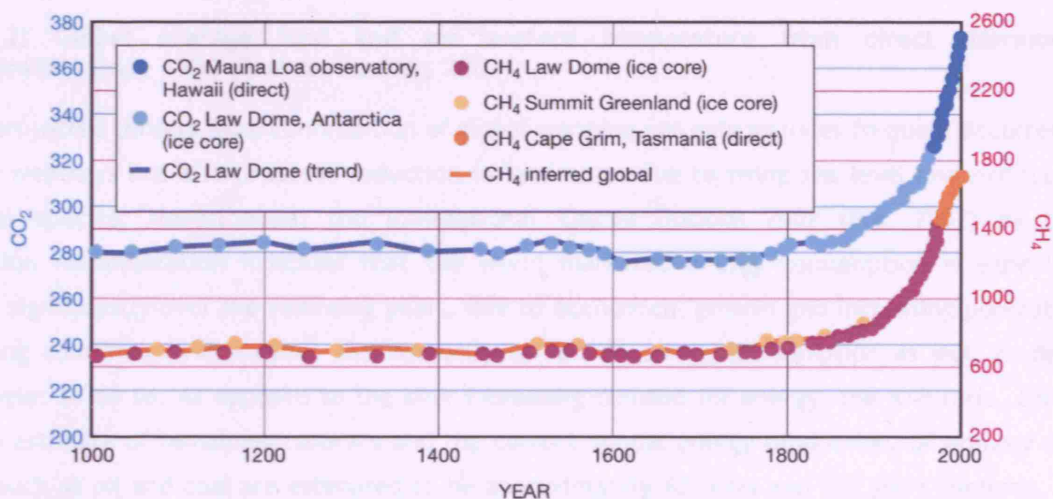

Figure 1: Atmospheric CO₂ and CH₄ concentration level measured in various locations of the World (Source: Hacker, 2007)

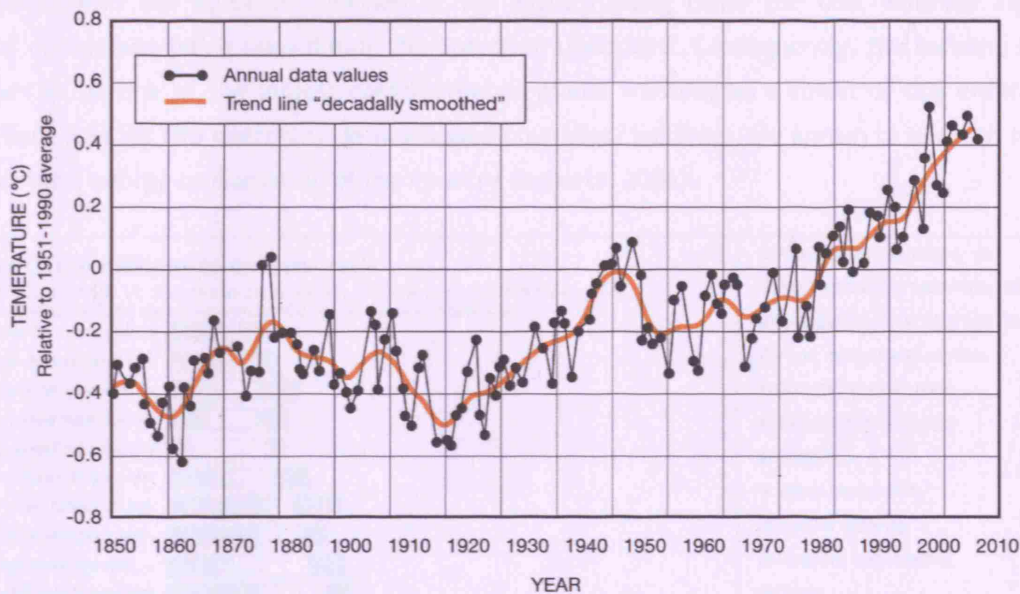

Figure 2: Global average land and sea surface temperature from direct thermometer measurements since 1850 (Source: Hacker, 2007)

The projected threats from continuation of global warming not only includes frequent occurrence of extreme weathers but also proposes reduction in land areas due to rising sea level and extinction of numerous species. Nevertheless, the International Energy Outlook 2007 (EIA, 2007) by Energy Information Administration indicates that the world marketed energy consumption is expected to increase significantly over the following years, due to economical growth and increasing population of developing countries, which raises the necessity to reduce energy consumption as well as develop technologies to do so. As opposed to the ever increasing demand for energy, the R/P ratio, the ratio between estimate of remaining reserves and the current annual energy production, of primary energy sources such as oil and coal are estimated to be approximately 40 years and 200 years (Roberts, 2006) respectively, and that the production of gas will also decrease in the future. Although this may be less significant in the short term, in a long run there is a potential that the fuel price will increase rapidly due to a mismatch in supply and demand of energy. Thus, in the building sector, the implication of rising fuel price is likely to be reflected by the significant increase in operational costs.

1.2 HVAC system and natural ventilation

In the past, simply opening a window has been the primary way to control the internal environment in buildings. However, with the development of the Heating, Ventilation and Air Conditioning (HVAC) system, and it's potential to control internal environment regardless of the prevailing weather condition, natural ventilation was no longer deemed necessary and suitable for non-domestic buildings.

Nevertheless, with the versatile function of the system along came the cost whereby significant amount of energy was being used during the operation unnoticed. Consequently, the building sector is now known to be one of the largest contributors to global warming as a result of CO₂ emitted from burning fossil fuel for the operation. In developed countries, buildings are known to account for up to 40% of the total energy consumption of the country (Roberts, 2006).

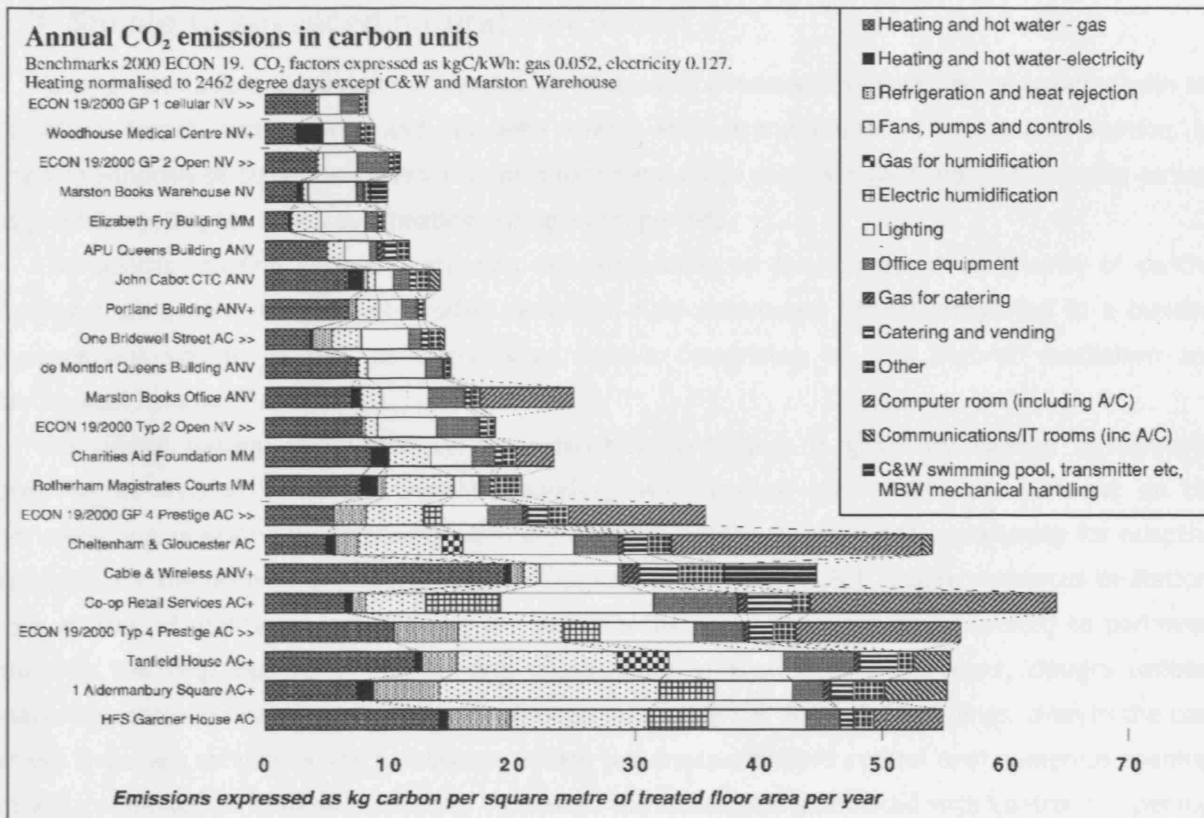

Figure 3: Comparison of annual CO₂ emission per treated floor area of PROBE Study buildings (Source: Bordass et. al., 2001)

In the UK PROBE Studies (Bordass et. al., 2001), it was discovered that the factor that contributes the most to this significant figure, amongst various services in buildings, is the HVAC system which was found to consume almost 50% of the energy in buildings. More specifically, energy consumption associated with fans and pumps to deliver conditioned air to desired spaces was found to account for up to 50% of the CO₂ emission associated with space heating and cooling. Moreover, the study revealed that nine of the ten highest CO₂ emitters were found to be either air-conditioned or operated under mixed-mode, as opposed to the lowest emitters in which nine of ten were found to be either naturally ventilated or advanced naturally ventilated. As Figure 3 clearly illustrates, utilising and maximising natural ventilation system in buildings hold considerable potential to decrease energy consumption and the associated CO₂ emission. In the context of global warming and possible increase in the fuel price in

the near future, this can be considered the most significant benefit and motive to implement natural ventilation along with an opportunity to reduce operational and maintenance cost as well as initial installation cost for a HVAC system. Moreover, numerous researches show that there is a tendency that the occupants prefer naturally ventilated buildings as well as lower sick building syndromes reported compared to air-conditioned buildings.

1.3 Simple to advanced natural ventilation

Natural ventilation, also known as passive ventilation, is a means of ventilating the building with aid of natural forces, such as wind and buoyancy effect, without any additional energy consumption, by opening windows or other components to introduce fresh air to maintain good indoor air quality as well as provide cooling to reduce overheating during warm periods.

The designs utilising natural ventilation vary depending on the degree of complexity of control ranging from simple manually controlled system to fully automated system integrated to a building management system as well as a combined system comprising of both natural ventilation and mechanical system.

The simple natural ventilation system, manually controlled, is generally applied to domestic buildings as well as some non-domestic buildings with shallow plan where the windows on the perimeter are operated by occupants. Although it holds potential to provide opportunity for adaptive approach for the occupants through degree of control of openings (CIBSE, 2006), numerous limitations such as lack of ability to control noise and pollution as well as security issues related to perimeter openings has degraded its credibility and applicability of such design. Moreover, designs utilising manually controlled natural ventilation have been unsuitable for deep plan buildings, even in the case where there are atriums or stack chimneys, which require coordinated control over numerous openings to induce enough air flow in a building. However, the limitations associated with control of openings were overcome by development of technology in the control systems area such as actuators and building management system (BMS). Moreover, with the introduction and development of computer simulation software, such as dynamic thermal simulation programs and computational fluid dynamics (CFD) as well as physical models, such as salt bath and wind tunnel testing, the possibilities of exploring and developing innovative natural ventilation strategies during the design stage expanded significantly. Consequently, this has led to emergence of the term advanced natural ventilation (Bordass et al. 2001) where complex automated control systems integrated with the BMS and various operation strategies are integrated into the design to maximise the effectiveness of natural ventilation as well as being tested for its viability in the design process.

In recent decade, numerous advanced naturally ventilated buildings that utilise stack ventilation as a predominant driving force have been introduced. While there are numerous publications that briefly describe the overall system of these buildings, there are very few studies that were conducted to

analyse the innovative natural ventilation system in these buildings, considering both design and operation, as well as address the operational performance, concerning the temperature profile, energy consumption and the associated CO₂ emission as well as occupant satisfaction, which would enable evaluation of the design. Therefore, the dissertation aims to analyse the design and operational performance of selected buildings that incorporate innovatively designed advanced natural ventilation system which demonstrate possibilities of overcoming the limitations which were faced by simple naturally ventilated design buildings from the past in an urban environment. To do so, a theoretical study on fundamentals of natural ventilation and the design process of naturally ventilated buildings will be carried out initially to form a basis of understanding. Moreover, a case study on each building will be conducted to analyse design of the building and its natural ventilation system as well as operational performance. Moreover, the findings from each case study will be assessed together to cast a general overview on the design and operational performance of advanced naturally ventilated buildings. The findings from the study may benefit architects or environmental designers, considering of adopting natural ventilation systems in an urban environment, as a source of information on the latest and innovative natural ventilation systems in non-domestic buildings.

Chapter 2. Methodology

2 Methodology

The dissertation is largely structured into three parts: theoretical part of theories behind design naturally ventilated buildings, chapters 3 to 5; case study part where advanced natural ventilation system of selected buildings are analysed, chapters 6 to 10; and discussion and analysis chapter to give an overview of the findings. In addition to these chapters, the dissertation will conclude with a conclusion chapter which comprise of summary of the report and a list of further works suggested by the author.

- **Theoretical Part**

The theoretical part details the fundamentals of basic natural ventilation techniques and addresses necessary steps to design an advanced natural ventilation system and the theory behind it.

The information collected for the review was obtained initially by searching for relevant technical documents from the following organisations:

- Chartered Institute of Buildings Services Engineers (CIBSE): Design Guide A and B, Applications Manual 10 and 13
- Building Services Research and Information Association (BSRIA): Technical Note TN 5/98, TN 3/98 and TN 4/99

Moreover, relevant scientific literature were collected to supplement the information from technical documents where specific topics, such as night ventilation, building performance, noise control, advanced natural ventilation and control were searched through the following databases:

- UCL Library Services such as MetaLib (search engine for electronic resources) and Eprints (online collection of work by UCL researchers)
- Informaworld by Informa plc (online database of journals, eBooks, abstract databases and reference works published by Taylor & Francis, Routledge, Psychology Press and Informa Healthcare)
- Science Direct by Elsevier B.V. (online database of full text and bibliographic information on science, technology and medicine)
- Sage Journal Online by Building Service Engineering Research and Technology (more than 485 journals in Business, Humanities, Social Sciences, and Science, Technology and Medicine)

In the dissertation, theoretical chapters account for a significant proportion such level of detail on basic natural ventilation techniques may be seen insignificant to advanced naturally ventilated buildings. However, this was written under the intension to elaborate that advanced natural ventilation systems, regardless of the complexity, are an integration of basic techniques. Moreover, it should be noted that the reason for allocating such a large proportion of the dissertation to the theoretical part is partly due to a publication in which the theoretical part will form a chapter 'Designing natural ventilation for urban buildings' due to be published in the near future.

- **Selection process of case study buildings**

The initial search for buildings to conduct case study started from browsing through the following sources:

- Building Services Journal, the official journal of the Chartered Institution of Building Services Engineers (CIBSE) (Building Analysis and Building Services Awards section in 2000 to the latest edition of 2008);
- Building Research Establishment website (the BREEAM Awards section);
- Websites of renowned architects and engineering companies (Fosters and Partners, Rogers Stirk Harbour + Partners, Arup, Max Fordham, etc)

By reading through a description or an article and briefly examining the design and ventilation strategy of buildings from these sources, the buildings that were related to any of the three criteria: advanced natural ventilation, stack ventilation and mixed-mode ventilation, were selected as an initial list concluding the search with total 23 buildings. The list was then screened, to eliminate the buildings which did not comply with more detailed requirement: completed after 2000 (to discard buildings in the UK Probe Study (Bordass et al. 2001)); natural ventilation as a predominant ventilation mode; and innovative design element. In the process, numerous buildings which were highly dependent on mechanical ventilation and simple natural ventilation were eliminated (Table 1).

After the initial screening, the remaining 10 buildings were thoroughly reviewed on the adequacy of available information to understand and describe the building and its natural ventilation strategy. This was done by accessing the online catalogue of the RIBA British Library (an index to articles in over 300 of the world's most respected architectural periodicals details of books and audio visual materials acquired by the RIBA Library) on the website of Royal Institute of British Architects (RIBA), searching by the name of each building as a keyword such as National Assembly for Wales. The list of search results was then searched again in the University College London catalogue to obtain a hard copy.

Table 1: List of buildings reviewed and excluded in the initial review

| No. | Building | Reason for exclusion |
|-----|-------------------------------------|---|
| 1 | Innovate Green Office | Predominant mechanical ventilation |
| 2 | Swindon Central Library | Insufficient data |
| 3 | London School of Economics Library | Insufficient data |
| 4 | The Gibbs Library | Predominant mechanical ventilation |
| 5 | RBS Gogarburn | No innovative design element |
| 6 | BBC Birmingham at the mail box | Mechanical cooling |
| 7 | Red Kite House | No innovative design element |
| 8 | Queens Building | Completed before 2000 |
| 9 | Durham County Council | Insufficient data |
| 10 | University of Portsmouth's Library | Mixed-mode with relatively simple natural ventilation |
| 11 | Civil Justice Centre for Manchester | Only partly naturally ventilated |
| 12 | John Madejeski Academy | No innovative design element |
| 13 | London City Hall | Insufficient data (Governmental) |
| 15 | Booths Headquarters | No innovative design element |
| 16 | Welcome Trust | Mechanical Ventilation |
| 17 | Fingal County Hall | Insufficient data |
| 18 | Plantation Place | Only partly naturally ventilated |
| 19 | The Garrick Theatre | No innovative design element |
| 20 | The Swiss Building | Mechanical ventilation and cooling |
| 21 | Porticulus House | Mechanical ventilation and cooling |
| 22 | The BRE Building | Completed before 2000 |
| 23 | Inland Revenue Building | No innovative design element |

Using the same approach, scientific literature were collected by searching through the database of Science Direct where the literature that are unrelated to the scope, ie. Welsh nationalism and the challenge of 'inclusive' politics, were eliminated. Moreover, public scholarly literature search engine Google Scholar was accessed using same methodology. Furthermore, the varying information of each building was balanced by directly contacting either an architect or engineer who was involved in the design process of the building or current facilities manager of the building for insufficient information.

The review of the gathered information revealed that 5 of 10 remaining buildings had insufficient information to proceed into the case study, leaving 5 buildings as conclusive (Table 2).

Table 2: List of conclusive buildings and their location

| No. | Name | Location | Country |
|-----|--|----------|--------------------------|
| 1 | National Assembly for Wales | Cardiff | United Kingdom |
| 2 | Heelis Building, National Trust HQ | Swindon | United Kingdom |
| 3 | School of Slavonic and East European Studies | London | United Kingdom |
| 4 | Lanchester Library | Coventry | United Kingdom |
| 5 | Harm A. Weber Library | Chicago | United States of America |

- **Case study**

In the case study chapters, each chapter comprises of 7 sub-chapters: site analysis; building form; ventilation components and control; natural ventilation strategy; seasonal operation; operational performance; and overview.

In the site analysis chapter, the two aspects of the site, weather condition and the surroundings have been analysed. The weather condition of the site was analysed by plotting the weather data, acquired from Square One website (Square One), onto a psychrometric chart using Weather Tool to study the annual variation of ambient temperature and humidity to verify the environment to which the building is exposed to. Moreover, the surroundings of the site are briefly described to verify and address any site specific constraints that may have influence on the design of natural ventilation systems.

The building form chapter addresses issues concerning the shape and the internal layout of the building as well as the materials of building elements. The shape of the building is described in terms of plan depth and presence of any significant design element, such as atrium or vertical open space, which influences the interior space and the layout. Moreover, description of how the layout was planned enhances the general understanding of the interior space. Furthermore, building elements which are designed specifically to enhance the effectiveness of natural ventilation are highlighted.

This is followed by a chapter which describes the ventilation components used in the building and how they are controlled. In the chapter, types of sensors and the degree of control are verified.

In the natural ventilation strategy chapter, natural ventilation system of buildings are analysed by describing the air flow paths through the building with aid of diagrams. In addition to the description of natural ventilation systems, analysis of the seasonal operation strategy for each building is conducted

from which operation strategies to minimise heat loss during winter as well as possible energy consumption from air conditioning during summer are identified.

Finally, case study chapter finishes with an overview part in which critical analysis of the building is carried out where limitations are elaborated and significant design elements are highlighted and criticised.

During the process of the dissertation, constant effort was made to acquire detailed information regarding the design target and actual annual energy consumption of each building, not only from available literature that illustrate post occupancy evaluation data but also by contacting the facilities managers of buildings for the data downloaded from BMS. The intention behind this was to compare the target and actual consumption as well as compare the actual consumption with bench mark figures in Energy Consumption Guide 19 (DETR, 2000) to verify if the advanced naturally ventilated buildings with innovative design are performing as intended, contributing to reduce CO₂ emission. However, due to insufficient information and responses to the requests, the detail of discussion in all operational performance parts was based on limited information from literatures and simple figures from a BMS for one building.

- **Discussion and analysis**

In this chapter, the findings from case study chapters are gathered and assessed together to produce an overview of the design and operation methods of the buildings are illustrated as well as highlighting any significant design components or details that are common amongst these buildings.

- **Conclusion**

In the conclusion chapter, a summary of all information and findings presented followed a conclusion. Moreover, the operational performance analysis that couldn't be conducted to depth in this dissertation and a list of ideas that may lead to new findings are suggested as further work at the end of the chapter.

Chapter 3. Theoretical Background

3 Theoretical Background

The magnitude and pattern of natural air movement through a building depends on the pressure difference acting across the ventilation path and the resistance of that flow path. The pressure difference driving the air flow is a function of two driving forces - wind and buoyancy.

Figure 4 shows the air flow around an isolated pitched roof building located in a low-density suburban environment with no built or natural elements which can obstruct the flow: plan view (top) side view (bottom). The wind induced pressure fluctuation on the building surfaces varies in time and space. The approaching flow separates in front of the cube (A) and forms the front stagnation point (B) at about three-fifths of the height of building. The flow goes down towards the ground, where it has more kinetic energy than the approaching flow, rolls up and forms a primary separation vortex (C). The main, so called 'horse-shoe vortex' (D) is formed around the base of the property forming the wake (E) and has a typical converging behavior. A large separation region (F) develops behind the property ending with the reattachment point (G). The results of turbulence modeling suggest the existence of two strong three-dimensional coherent vortices (H). A region of very low pressure is generally observed on the roof surface (I). Note that flow at a certain distance from the roof should be unaffected by obstacles (J).

As can be seen, wind pressures are generally positive on the windward side of a building and negative on the leeward side. The occurrence and change of wind pressures on building surfaces depend on wind speed and wind direction relative to the building, the location and surrounding environment of the building and the shape of the building.

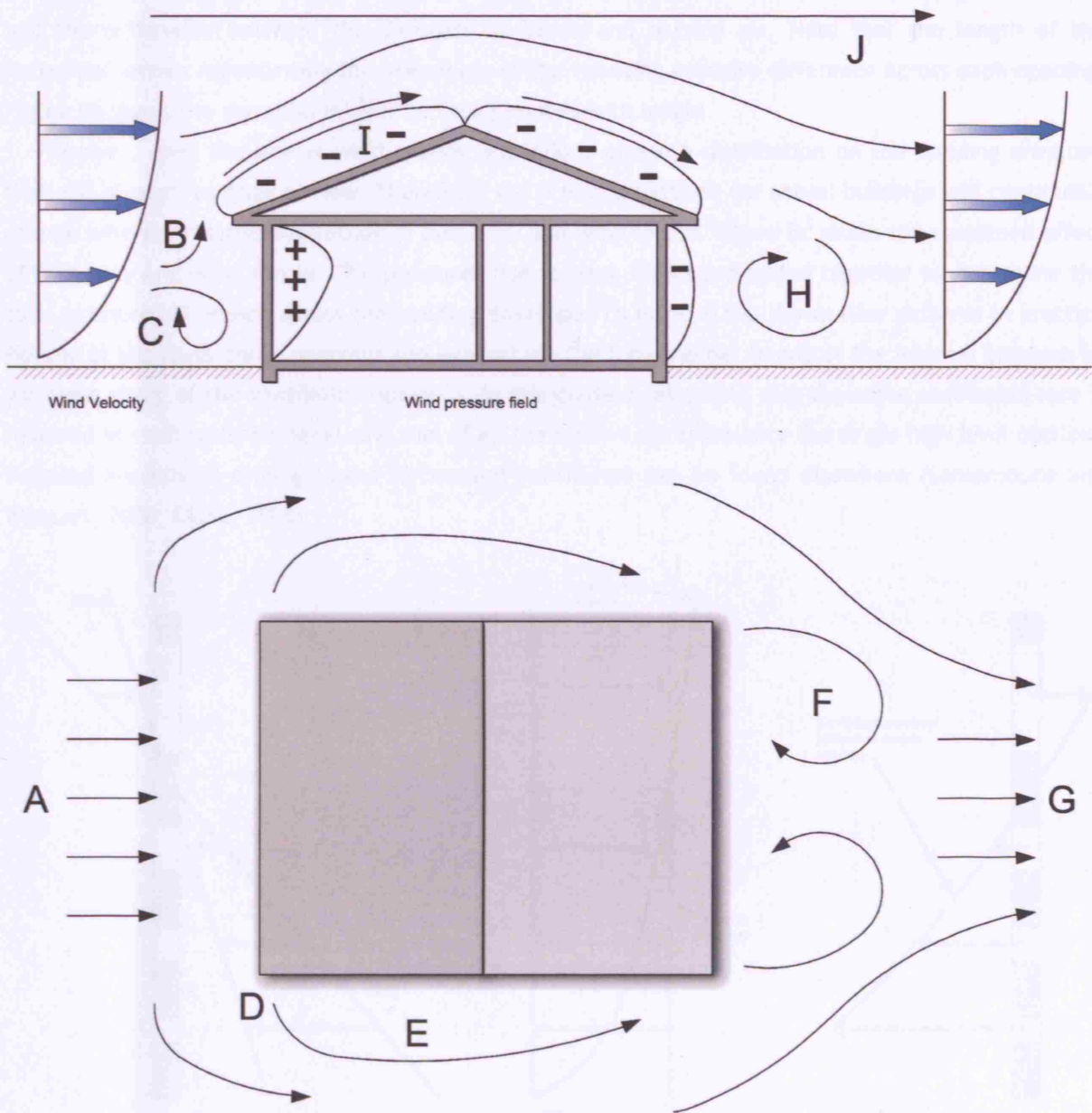

Figure 4: Wind pressure acting on an isolated building (a) elevation (b) plan

When air movement is due to temperature difference between the indoor and outdoor, the flow of air is in the vertical direction and is along the path of least resistance. The temperature difference causes density differentials, and therefore pressure differences, that drive the air to move. This is known as the stack effect. When buoyancy force is acting alone, a *neutral pressure level (NPL)* exists, where the interior and exterior pressures are equal (Figure 5a). At all other levels, the pressure

difference between the interior and exterior depends on the distance from the neutral pressure level and the difference between the densities of inside and outside air. Note that the length of the horizontal arrows representing the magnitude of the resulting pressure difference across each opening. Figure 5b shows the variation in wind surface pressure with height.

However, even the lowest wind speeds will induce pressure distribution on the building envelope that will also act to drive airflow. Therefore, the pressure patterns for actual buildings will continually change with the relative magnitude of buoyancy and wind forces. Figure 5c shows the combined effect of buoyancy and wind forces. The pressures due to each effect are added together to determine the total pressure difference across the building envelope. To achieve the shown flow patterns in practice (inflow at the lower three openings and exhaust via the top) one has to adjust the internal pressure by judicious sizing of the ventilation openings. In this context, assuming that the same ventilation rate is required at each occupied level, the sum of all the inflows has to balance the single high level outflow. Detailed analysis of driving forces for natural ventilation can be found elsewhere (Santamouris and Wouters, 2006; CIBSE, 2005)

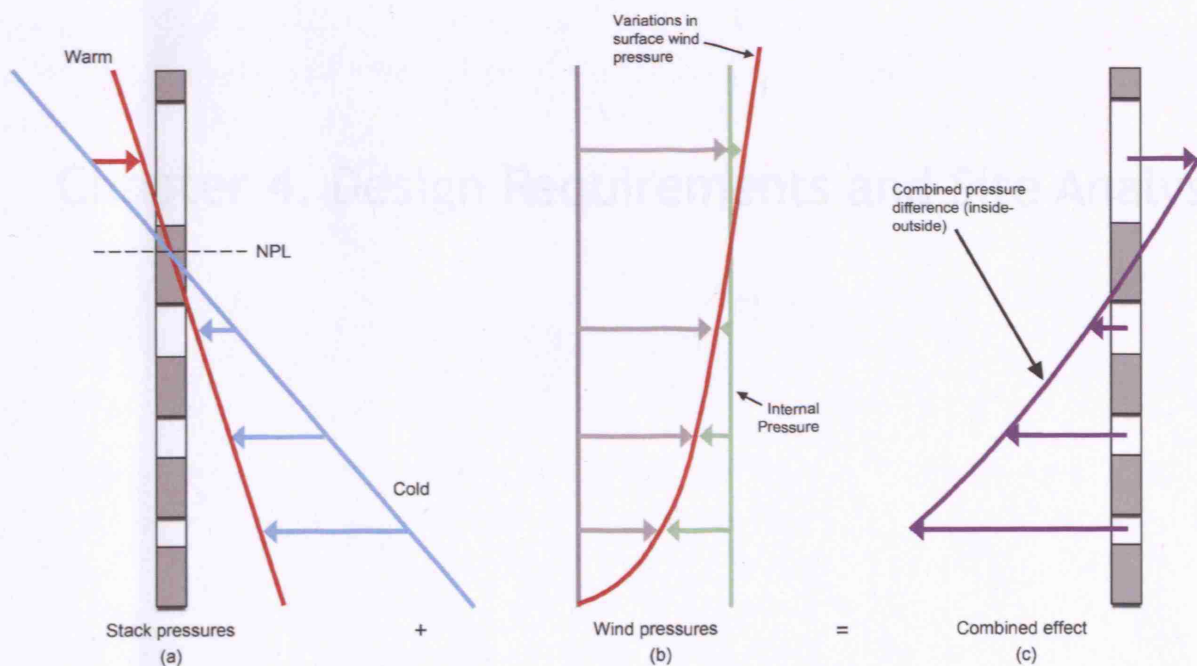

Figure 5: Combined buoyancy and wind driven ventilation. Reproduced from CIBSE AM10 (CIBSE, 2005) by permission of the Chartered Institution of Building Services Engineers.

Chapter 4. Design Requirements and Site Analysis

4 Design Requirements and Site Analysis

4.1 Client brief and design requirements

Building designs are developed in response to the client brief, to site-specific conditions and constraints and to further statutory and technical requirements. These factors set out parameters within which designs develop, with some cases where there is significant delimitation to the range of viable design responses and others where there is less so.

The client brief sets out the basics of the building such as its type - residential, offices and educational and required spaces and specific accommodations in the building as well as various items in a level of detail. Moreover, there is a general set out of environmental performance requirements, such as temperature targets and lighting levels, which are of key importance as they effectively determine the viability of natural ventilation as a response. Furthermore, other issues that can have bearing on the application of natural ventilation include the level of compartmentalisation of internal spaces, acoustic compartmentalisation requirements, occupancy patterns and densities, and internal heat gains.

When considering the use of natural ventilation in a building, it is crucial that the technical viability of natural ventilation is assessed to deliver the following points:

- To provide an appropriate level of indoor air quality by removing and diluting airborne contaminants
- To reduce overheating in the building
- To integrate with all other aspects of the building design such as the day lighting and acoustics design

4.2 Microclimate and weather data

The micro climate of a building site can have strong influence on the effectiveness of natural ventilation systems which include characteristics of wind and weather. In the urban environment, the mean velocity of wind is reduced significantly and wind direction might be changed due to urban fabric. As a consequence, the wind induced pressure on a building envelope is lower (Figure 6)

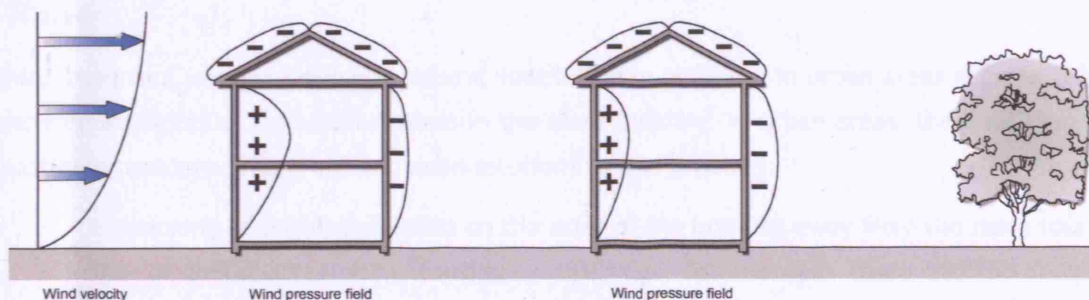

Figure 6: Wind pressure acting on an urban building

Solar radiation absorbed by urban surfaces results in a temperature increase that is important to take into account as it will limit the cooling potential of natural ventilation. In less dense urban areas, this might be only a local phenomenon for intakes located on south facing walls, while in dense urban areas it might result in a general increase of outdoor temperatures compared to rural areas. This effect is known as urban heat island effect. (Kolokotroni, et. al., 2006)

To assess the internal temperatures likely to occur in naturally ventilated buildings and to establish the required ventilation rates, CIBSE has produced two weather years for 14 UK locations:

- Design Summer Year (DSY)
- Test Reference Year (TRY)

The DSY is an actual year containing fairly extreme temperatures for the six months between April and September and should be used to assess whether or not there is an acceptably low risk of summertime overheating in the building. The TRY is a synthesised typical weather year and should be used to analyse energy use and overall environmental performance of buildings.

4.3 Air pollution

A second important issue in designing natural ventilated buildings in urban areas is the impact of outdoor air quality. While inadequate outdoor air quality affects both naturally and mechanically ventilated buildings, there are three reasons why the natural ventilation designs are more sensitive to elevated levels of outdoor air pollution:

- A typical ventilation systems do not incorporate particle filtration
- The natural ventilation systems may introduce far greater quantities of outdoor air into the building to reduce overheating particularly in summer months
- Due to low natural driving forces, the positioning of the air inlets is more limited and inlets at high level, where levels of certain pollutants are generally lower, are often not a viable option

4.4 Noise

A third important issue in designing natural ventilation in buildings in urban areas is noise, whether it comes from outdoors or from other rooms in the same building. In urban areas, the traffic noise can be of particular concern. There are two main solutions to this problem:

- Positioning of ventilation inlets on the sides of the building away from the noise source
- Use of sound attenuating ventilation openings, for example those incorporating noise reducing baffles or acoustic labyrinth

Chapter 5. Developing a Ventilation Design Strategy

5 Developing a Ventilation Design Strategy

The variety and diversity of purpose provided natural ventilation systems that have been proposed in recent years is staggering, especially in Europe. Often mechanical devices are added to enhance ventilation system performance and control adding to the complexity. Nevertheless, these systems are invariably conceived as variants of the basic forms of ventilation strategies. In this section, these basic forms of ventilation strategies are defined and related to the form and layout of the building for which they are typically best suited. General terms used are as follows:

- Vents: ventilation openings through which air flows into or out of a space
- Inlet: a vent through which air flows into a space
- Outlet: a vent through which air flows out of a space

5.1 Single sided ventilation

Single sided ventilation usually serves single rooms and relies on vents on one side only of the enclosure. It is closely approximated in many multi-room buildings with opening windows on one side of the room and a closed internal door on the other side.

5.1.1 Single sided ventilation, single opening (Figure 7a):

Relative to the other strategies, this one offers the least attractive natural ventilation solution and is characterised by lower ventilation rates and the ventilating air penetrating a smaller distance into the space. As a rule of thumb, the limiting depth for effective ventilation is about twice the floor to ceiling height, typically 4 to 6m in depth.

5.1.2 Single sided ventilation, double opening (Figure 7b):

The additional opening located at the top of the opening enhances the driving force for ventilation due to the room-scale stack effect generated by the height difference between openings. The stack induced flow increases with the vertical separation of the openings and with the temperature difference between inside and outside. As a rule of thumb, the limiting depth for effective ventilation is about 2.5 the floor to ceiling height, typically 7 to 8m.

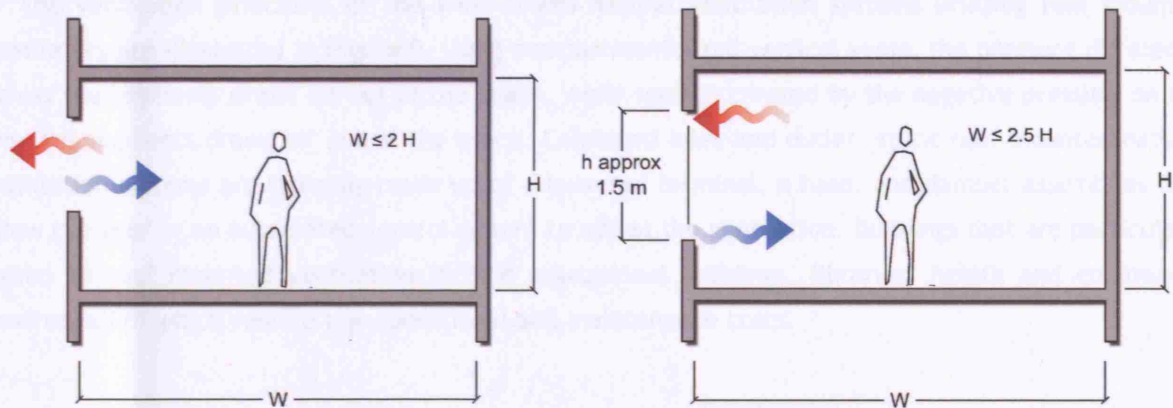

Figure 7: Single sided ventilation: (a) single opening (b) double opening

5.2 Cross-ventilation

Cross-ventilation is usually driven by wind generated pressure differences including positive (inward acting) pressures and negative (outward acting) pressures on leeward surfaces. The floor depth in the direction of ventilation has to be limited to effectively prevent heat and pollutant build-up from the space during ventilation due to typical driving forces. As a rule of thumb, the limiting depth for effective ventilation is about five times the floor to ceiling height, typically up to 15m as shown in Figure 8. This implies a relatively narrow plan depth for the building which is usually achieved by adopting either a linear built form or an open courtyard form. Note that in the latter case the significant differences in wind pressure between inlet and outlet opening will be more difficult to achieve because the courtyard and the leeward side of the building will be at similar pressures.

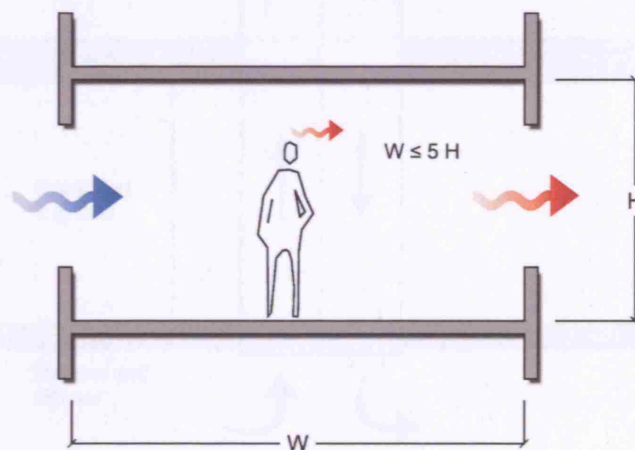

Figure 8: Cross-ventilation strategy

The ventilation principles of the wind-driven natural ventilation systems utilising roof mounted ventilators are illustrated in Figure 9. Using compartmentalised vertical vents, the pressure difference across the segments draws air out of the space, while suction created by the negative pressure on the leeward segments draws air out of the space. Combined inlet and outlet, static roof mounted natural ventilation systems are typically made up of a louvered terminal, a base, and damper assemblies that allow the user or an automated control system to adjust the ventilation. Buildings that are particularly suited to roof mounted ventilation include educational buildings, libraries, health and community centres, all of which require low operational and maintenance costs.

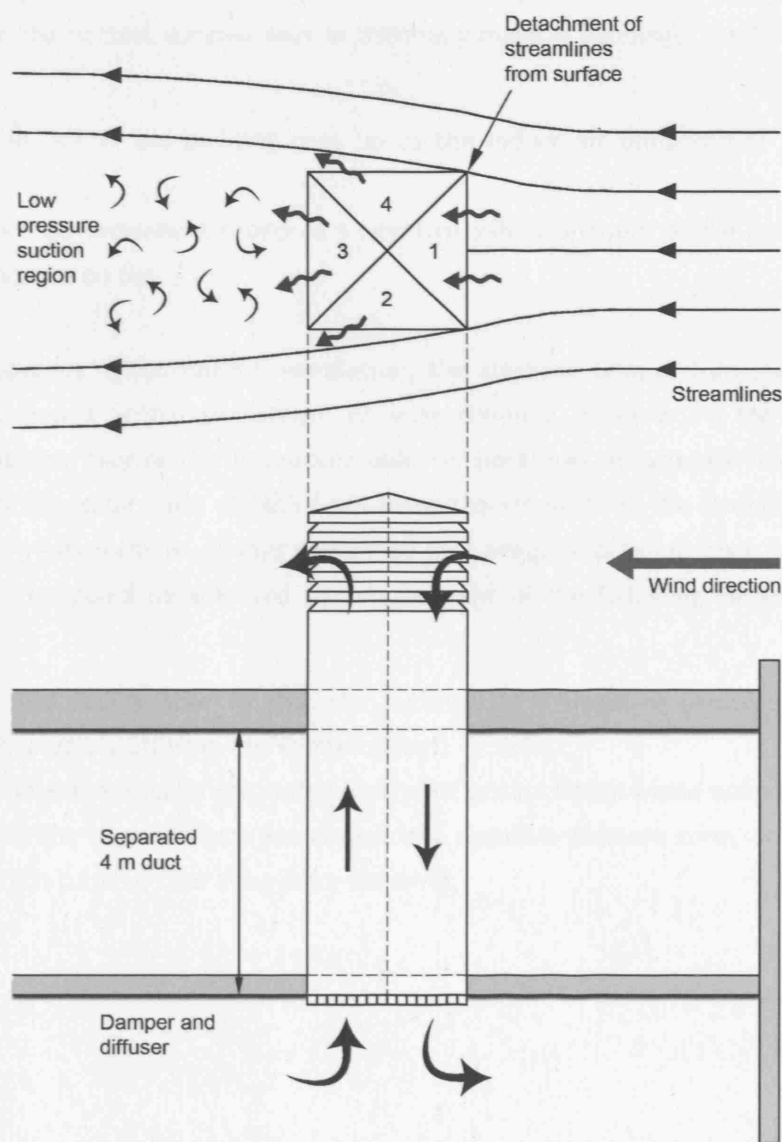

Figure 9: Flow around and inside of a squared roof mounted ventilator

5.3 Stack ventilation

A number of designers are achieving deeper floor plans than described above by providing stack ventilation within the building. This may be achieved via purpose built vertical ducts, also known as stacks or chimneys, or via an internal atrium or other type of vertical spatial continuity within the building. Stack ventilation is buoyancy driven and relies on density differences to draw cooler, denser outdoor air into a building via low level vents and exhaust warmer, less dense air via high level vents. Should the air inside of the building at any time be cooler than that outside, then the airflow direction will reverse. For anytime where indoor air temperature is higher than outdoors (generally the case in UK, other than for the hottest summer days in thermally massive buildings) the following stack effect occurs (Figure 10):

- The warmer air in the building rises up as the indoor air temperature is higher than that outdoors
- The upward air movement produces a negative indoor pressure at the bottom and a positive indoor pressure on top

To promote buoyancy driven natural ventilation, the elevated temperature should be maintained over a reasonable height within the atrium or solar chimney. However, if the atrium is open to surrounding spaces this may result in unacceptable temperatures at occupied levels. This could be prevented by absorbing solar gains at high level using the elements of the structure or solar baffles. Note that the roof vents must be always positioned in a negative pressure zone with regard to wind induced pressure. This could be achieved by adopting one of the following design strategies (CIBSE, 2005):

- Designing the roof profile so that the outlet is in a negative pressure zone for all wind directions (possibly utilising the Venturi effect)
- Installing an automatically controlled multi-vent system which would open and close outlets to ensure that the opened vents are always in a negative pressure zone, or using a single vent system which turns to face away from the wind.

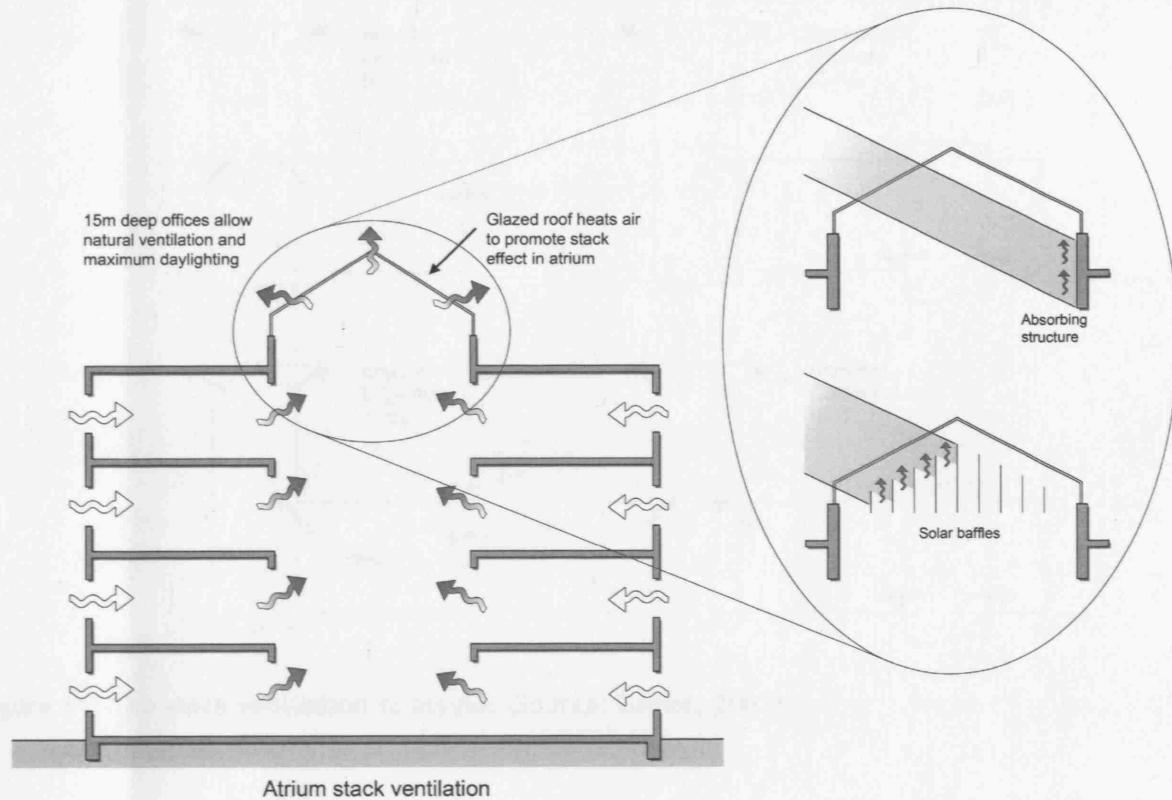

Figure 10: Atrium stack ventilation. Reproduced from CIBSE Guide B2 by permission of the Chartered Institution of Building Services Engineers

Stack ventilated buildings can be divided in four main types according to implemented stack ventilation strategies (Lomas, 2007, Figure 11):

- The edge in, centre out (E-C)
- The edge in, edge out (E-E)
- The centre in, edge out (C-E)
- The centre in, centre out (C-C)

The edge-in strategies are susceptible to the noise, pollution and security concerns associated with natural ventilation design in urban areas. During winter, perimeter heating elements could be used to preheat the outside air, while in summer the operable windows could be used to enhance the air movement throughout the building without disturbing the basic air flow strategy. The edge in, centre out strategy (E-C) allows for a deep plan naturally ventilated building design and has been widely exploited in recent years.

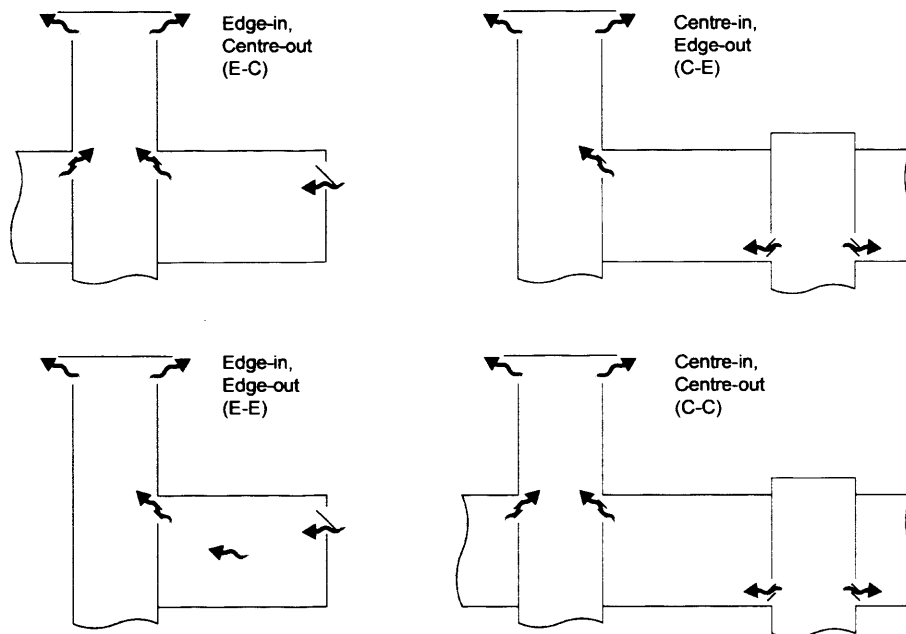

Figure 11: The stack ventilation strategies (Source: Lomas, 2007)

The centre-in strategies enables the external façade to be sealed; therefore airflow is not susceptible to localized air pollution, noise and security concerns. Apart from being the air supply route, the central stack can introduce daylight into a deep-plan building. The exhaust stacks are located at the perimeter of the building allowing more flexible internal space planning. Note that the centre-in natural ventilation strategies, if necessary, could be easily converted to the contingency or complementary mixed mode ventilation design by adding mechanically assisted ventilation. Detailed discussion on the architectural design of an advanced naturally ventilated building form is given elsewhere (Lomas, 2007).

5.4 Mechanically assisted ventilation

As promising as these advanced natural ventilation systems are, the purely natural ventilation systems will fail when the natural driving forces are simply not available (no wind for wind driven systems and no internal/external temperature difference for stack driven systems). As a consequence, recent trends have favoured mechanically assisted ventilation. For example, in stack driven systems, extract fans are often installed in chimneys and/or high level in atriums that can pull air through the building as a means of providing adequate ventilation on very hot and still days.

The inclusion of mechanical reinforcement of natural ventilation is the first step in the mixed mode direction. The physical mixed mode strategies are classified as following (CIBSE, 2000):

- Contingency design - usually naturally ventilated buildings in which the mechanical ventilation or cooling could be easily added or subtracted if necessary
- Complementary design - both natural and mechanical ventilation systems are present and designed to avoid clashes, wasteful and inefficient operation
- Zoned design - different ventilation strategies are servicing different parts of the building

For complementary systems, the operational strategies fall into two categories (CIBSE, 2000):

- Concurrent operation - an intrinsically efficient mechanical ventilation system, either with or without cooling, operates in parallel with natural ventilation systems
- Changeover operation - natural and mechanical ventilation systems are available and operate as alternatives according to need. However, they do not necessarily operate at the same time; some examples include seasonal changeover (winter, summer and mid season modes), mechanically assisted night ventilation, top-up cooling (mechanical refrigeration provided when free cooling options are insufficient) and local changeover (if window is opened the mechanical cooling is switched off automatically)

Mixed mode systems tend to be inherently more complex than pure natural ventilation systems. They also tend to expend more energy during operation although there are exceptions to this. An example would be the use of natural ventilation in summer and mechanical ventilation system with heat recovery in winter for a building located in North Europe, where energy used for mechanical ventilation in winter is more than offset by the heating energy saved via the heat recovery system. Mechanical ventilation with heat recovery for the winter season is becoming increasingly widespread in Northern Europe, particularly for high occupancy buildings, such as schools where heat loss can be predominantly via ventilation.

5.5 Further refinements

The systems outlined in previous sections have the potential to work very well under a range of conditions (both external and operational). Outside of these conditions, the options are to develop a mechanically assisted or fully mixed mode system and/or to exploit a number of further refinements in natural ventilation strategies. These further refinements are generally implemented when external temperatures and/or internal heat gains are too high to enable the limiting of internal air temperatures during occupied hours down within comfortable limits. They can be categorised as follows, those that:

- Thermally temper the building fabric via airflow outside of occupied hours
- Thermally temper incoming air prior to introduction into the space

The most commonly utilised refinement is the night ventilation cooling which falls under the first category above. Here, the intention is to offset daytime internal gains by cooling the building's thermal mass with outdoor air during the previous night assuming that the outdoor temperature drops below the upper comfort limit temperatures (Figure 12). Depending on the technique used to transfer heat between the thermal mass and the conditioned space, the night ventilation systems can be classified as either direct or indirect systems.

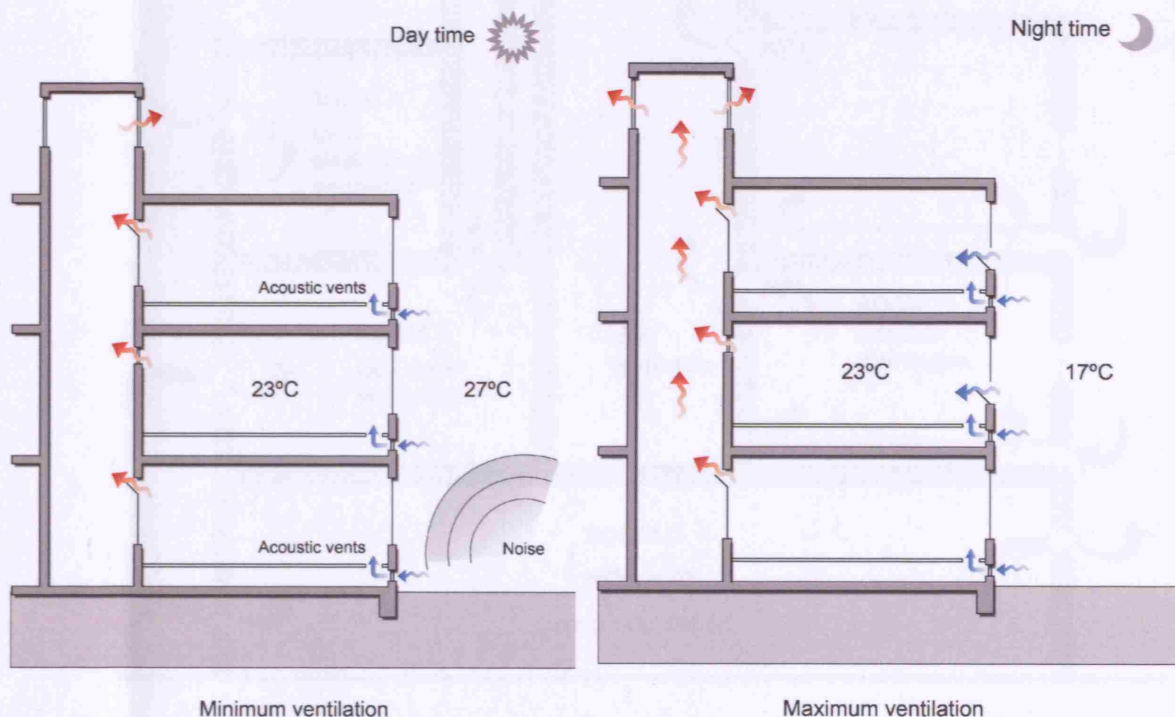

Figure 12: different ventilation strategies: (a) day time, (b) night time

5.6 Integration of basic strategies

The previously described basic strategies are commonly used concurrently in a building to handle a variety of ventilation requirements (Figure 13). For example, single sided ventilation with double opening might be adopted for a number of cellular shallow spaces (Room A). However, a local stack ventilation system might be used to provide adequate ventilation in deeper spaces (Room B). Additionally, to temper the incoming air and to provide a greater control of air distribution across the building the use of in-slab fresh air distribution could be adopted (Room C). This type of fresh air distribution is similar to displacement ventilation, most commonly implemented mechanically, and similarly relies on thermal plumes generated by equipment and by occupants to assist airflow and improve air quality in the ventilated enclosure. Finally, for deeper high occupant density spaces (Room D) the cooling potential of natural ventilation might not be sufficient to prevent overheating and an additional mechanically assisted strategy might be necessary.

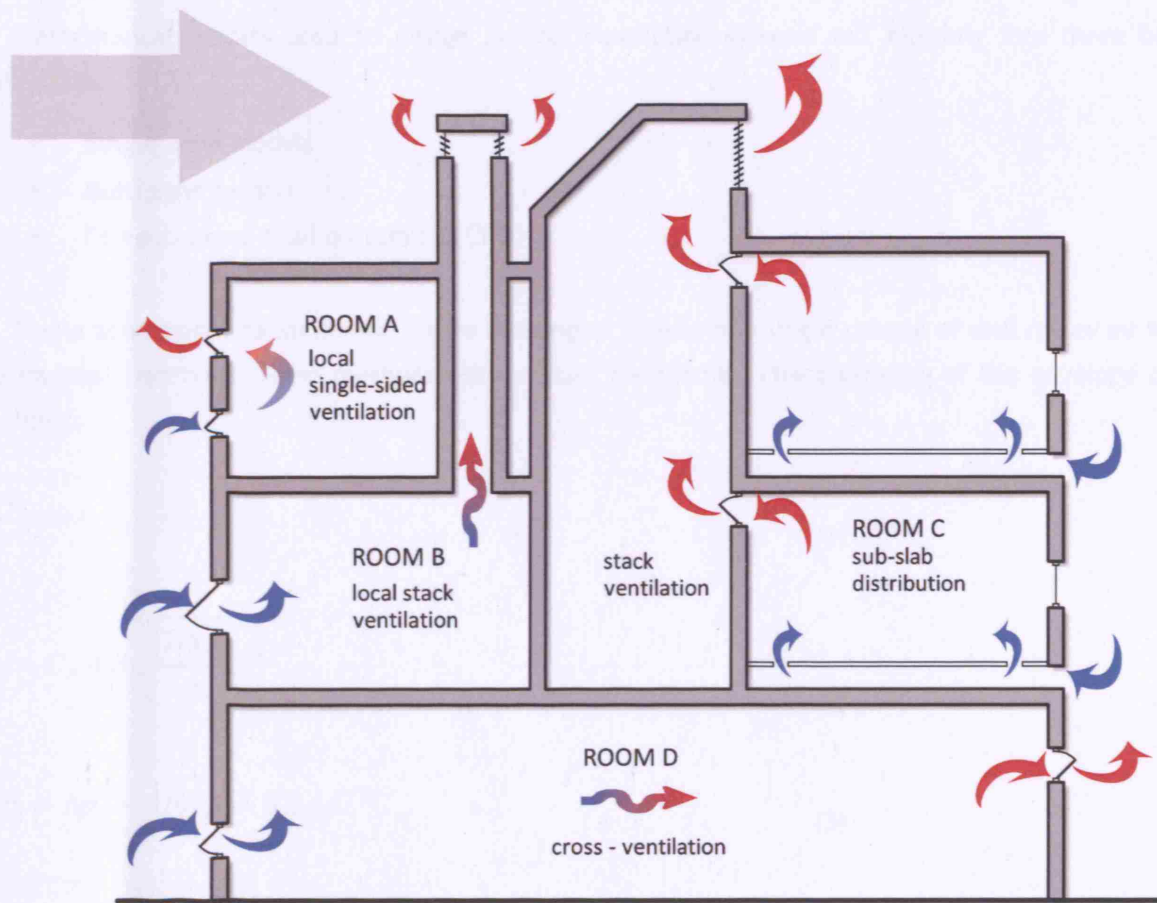

Figure 13: Integration of basic ventilation strategies

5.7 Design performance evaluation

In order to insure that the developed natural ventilation system performs adequately, it is important that sound engineering based methods are employed. This will include evaluating the design under various weather conditions and heat loads and determining potential situations where design goals might not be met. Depending on design requirements the analysis of the natural ventilation systems will require consideration of energy consumption (and associated CO₂ emission), airflow (due to wind, buoyancy effect and mechanical force in case of mixed mode systems), and air pollutants distribution. The complex interaction between building envelopes and their indoor and outdoor environment make it difficult to address all these issues using one tool only. Consequently, this has lead to the development of a wide range of different analysis tools and they typically fall into two categories, mathematical and physical models.

5.7.1 Mathematical Models

Mathematical models used to design natural ventilation systems fall typically into three basic categories:

- Single zone models
- Multi zone models
- Computational fluid dynamics (CFD)

Single zone model considers the entire building to consist of a single volume of well mixed air with no internal partitions. Some methods also account for thermal characteristics of the envelope of a building:

$$\sum q_i = 0 \quad (1)$$

$$q_i = C_{di} A_i S_i \sqrt{\frac{2|\Delta p_i|}{\rho_0}} \quad (2)$$

$$\Delta p_i = \Delta p_0 - \Delta \rho_0 g z_i + 0.5 \rho_0 U^2 C_{pi} \quad (3)$$

where i identifies the opening, q_j is the flow rate through the opening (m³/s), C_{di} is the discharge coefficient (-), A_i is the are of opening (m²), Δp_i is the pressure difference (Pa), $\Delta \rho_0$ is the

air density difference (kg/m^3), g gravitational force (m/s^2), z_i height of opening above ground level (m), sign of the pressure difference (+1 for flow entering the space; -1 for flow leaving the space), U wind speed (m/s), and C_{pi} wind pressure coefficient.

Equation (1) represents conservation of mass for the building envelope, i.e. the net mass flow into the building is equal to zero. Equation (2) defines the relationship between the flow rate through an opening and a pressure difference across it by means of the discharge coefficient and a specified geometric area. Finally, equation (3) defines the pressure difference across an opening whose inlet or outlet is situated in the external flow. Note that the single zone models ignore internal resistances to airflow and are generally considered useful for the initial calculations only.

Multi zone models are based on an idealised physical representation of building systems and can be used to describe a building as a set of zones that are interconnected to by airflow paths. It is assumed that the zones are typically well mixed. Nowadays, more advanced multizone design tools have been able to simulate airflow through openings in combination with the thermal response of a building. Using these features, one can perform simulations to investigate the differences in airflow rates obtained by varying different building features and weather conditions including the size and placement of ventilation openings in the building envelope, the orientation of the building in relation to the prevailing wind, the outdoor temperature and size and location of ventilation stacks.

CFD modelling is the process of representing a fluid flow problem by mathematical equations based on the fundamental laws of physics, and solving those equations to predict the variation of the calculated parameters within and around buildings. The applications of CFD to the design of naturally ventilated buildings include but are not limited to:

- Calculation of velocity, temperature and air pollutants distributions in single and multi-cell buildings
- Prediction of the external wind flow around a building and the resulting pressure field from which the pressure coefficient, C_{pi} [-], can be calculated
- Calculation of internal flow patterns through ventilation components

5.7.2 Physical Models

Although the mathematical models are more cost-effective, the physical models are still used by both research and building design communities as they offer relatively high accuracy. These include wind tunnel and salt bath (or water bath) modelling.

The wind tunnel modelling is usually used to determine wind pressure coefficients for individual building design. A physical model of a building and its surroundings can be constructed and placed in a wind tunnel where it is subject to a controlled flow. A boundary layer wind profile should be comparable to that appropriate for the site and can be induced in the wind tunnel by means of blockages. Moreover, it can also be used for flow visualisation by introducing smoke or other tracers in the wind tunnel and observing the flow characteristics. Lately, the wind tunnels can also be used for measuring directly the ventilation rate of a building provided that the volume of the envelope at a model scales allows a tracer gas measurements inside the model.

The salt bath or the water bath model is relatively recent development and is primarily used for testing of buoyancy driven ventilation strategies. Figure 14 shows a small scale model of a building envelope which is immersed in transparent bath containing saline solutions of different concentrations that simulate the density (temperature) differences. The blue colour indicates regions of cool air while red colour indicates where the warm air gathers in the space. It should be noted that using salt bath method is not possible to realistically simulate boundary conditions, such as solar patching on the floor of atrium.



Figure 14: Saltbath test. Source: Dr Liora Malki-Epshtein, UCL

5.8 Detailed design

5.8.1 Ventilation components

Primary vent sizing in natural ventilation systems tends to be determined by airflow rates needed to deliver ventilative summertime cooling. The issue of overheating in the summer is one of the main technical barriers related to the natural ventilation systems. To avoid overheating, the airflow will commonly need to exceed that required solely to satisfy the minimum required for indoor air quality and health. As a result, sizes of openings are at least an order of magnitude larger than that used for winter ventilation.

Windows remain the most commonly used vents in natural ventilation systems. Different types of windows create indoor air flow patterns and provide different options for controlling the direction and level of volumetric flow. The window types can be classified in four groups as shown in Table 3 below.

Table 3: Classification of windows

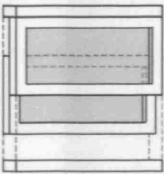
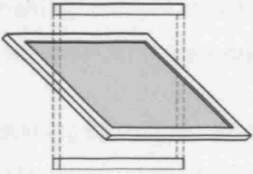
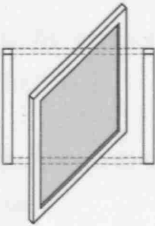
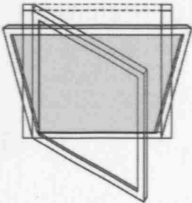
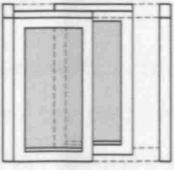
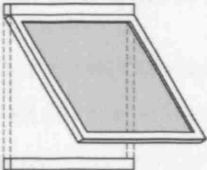
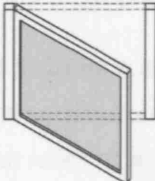
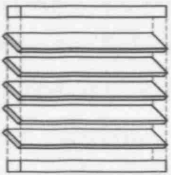
| Sliding (sash) windows | Horizontal-vane opening windows | Vertical-vane opening windows | Tilt and turn windows |
|--|---|---|--|
|  <p data-bbox="252 1368 406 1400">Vertical sash</p> |  <p data-bbox="533 1368 716 1400">Horizontal pivot</p> |  <p data-bbox="847 1368 1002 1400">Vertical pivot</p> |  <p data-bbox="1145 1368 1283 1400">Tilt and turn</p> |
|  <p data-bbox="236 1630 424 1662">Horizontal sash</p> |  <p data-bbox="523 1630 724 1662">Top/Bottom hung</p> |  <p data-bbox="858 1630 991 1662">Side hung</p> | |
| |  <p data-bbox="564 1868 683 1899">Louvered</p> | | |

Vents are generally controlled either manually or mechanically via actuators. An actuator responds to the output signal from a controller and provides the mechanical action to operate the vent, such as windows, dampers or louvers. The choice of vent type and its integration with different actuator options requires a special attention, particularly when using windows as these have generally been originally designed for manual operation.

For winter ventilation, trickle ventilators are commonly used to provide necessary background ventilation to satisfy the minimum ventilation requirements during winter. Moreover, background ventilation can also be provided via more sophisticated methods which can deliver energy saving benefits. The most common example is mechanical ventilation with heat recovery. A less commonly used option is natural ventilation with heat recovery.

In general, a special attention should be taken to ensure that the ventilation path is not obstructed by interior layout such as partitioning of rooms where design solutions such as transfer grills should be implemented to induce good air movement across the building.

5.8.2 Control Systems

The need to maintain ventilation rates reliably using natural ventilation forces is a major challenge for the development of advanced natural ventilation systems. The wind and buoyancy forces are stochastic in their nature making control more difficult. As a result of poor controllability of the natural ventilation systems the ventilated enclosures may be:

- Under-ventilated resulting in deterioration of air quality and overheating
- Over-ventilated resulting in higher ventilation losses
- Or may not provide acceptable air distribution resulting in local thermal discomfort (cold draughts or insufficient cooling) or local air quality problems (pockets and stagnant air)

An automatic control system for a naturally ventilated building is composed of one or more sensors measuring the parameters required for the implementation of any control strategy. In most cases, one or more temperature sensors are normally positioned in the room to achieve an average reading. This is the simplest method of automatic control and is suitable for most applications. For example, the dampers are normally set to commence opening at 16 °C during summer months and open 20% for every 1 °C rise in internal room temperature. Seasonal switching enables the temperature set points to be increased in the winter setting to prevent heat loss during this period. In atria and other buffer spaces the coarse on/off method is most commonly used as the close control of comfort conditions is not essential. In the case of densely populated areas of the building, such as classrooms or conference theatres, CO₂ sensors maybe used in conjunction with the temperature sensors. A key control problem

is to provide sufficient but not excessive background ventilation whilst avoiding draughts. The preferred location for the CO₂ sensor may be around seated head height and away from direct draught. In addition to the temperature and CO₂ sensors, automatic control for a naturally ventilated building could be composed of room occupancy, humidity, rain detection, outside air temperature, wind speed and wind direction sensors. Generally, these parameters can be recorded, but are usually used for performance assessment purposes.

Sensible integration of user and automated controls is therefore critical to the success of natural ventilation. In the case of the user control, the resulting control strategy is based on purely subjective criteria, i.e. perceived indoor air quality and thermal comfort. If in the control of their indoor environment, the occupants are usually willing to accept wider comfort bands, even if they are not ideal. They will rarely act in anticipation of becoming uncomfortable. However, if uncomfortable, the occupants will take action to alleviate their discomfort and in this case the rapid response is essential. Note that the automated control must not usurp control too rapidly after user intervention.

5.9 Theory and practice

The theoretical study conducted on the fundamentals and basic natural ventilation strategies as well as necessary steps in design development hereto is the basis from which advanced naturally ventilated buildings are designed in the practice. Taking into consideration the structure of the steps involved in the design development process elaborated in the theoretical study, the following case study chapters will analyse the selected exemplar advanced naturally ventilated buildings in regards to the site, the design of the building form and its ventilation components, the natural ventilation system and the operational strategy as well as its operational performance. This will not only demonstrate to what extent and how the theory is applicable in reality but also produce an opportunity to critically analyse the designed system and evaluate its effectiveness based on the operational performance.

Chapter 6. Case Study: Heelis

6 Case Study 1: Heelis



Figure 15: Main view of the building (Source: photograph by author)

The Heelis building is the new central office for the National Trust located in Swindon, UK, which was designed by the Feilden Clegg Bradley Studios with environmental consultancy by Max Fordham LLP where sustainability was considered as a most important aspect of its design. The building is a two storey office building that accommodates approximately 470 employees with floor area of approximately 7,100 m² in which there are public areas, such as café and shop, in addition to the large office area.

The following sub chapters analyse the site and design of Heelis building and its natural ventilation system based on the information acquired from a site visit, online information from various organisations involved in the design process (Max Fordham; FCB Studios; SE Controls), and literatures such as post occupancy evaluation of the building (Nasa'a, 2007). Moreover, the operational performance of the building is analysed in the later sub-chapters which is followed by an overview.

6.1 Site analysis

- Weather analysis

Within the temperate climate zone of UK, Swindon is located in the South Western part of England. Shown in Figure 16 is the weather data for Bristol, which is located close to Swindon, plotted onto a psychrometric chart using Weather Tool (Square One). The recorded temperatures can be observed to be mostly below and out of the indicative comfort zone, yellow square box, frequently falling below 0°C during cold seasons while it occasionally rises above 20°C during warm seasons.

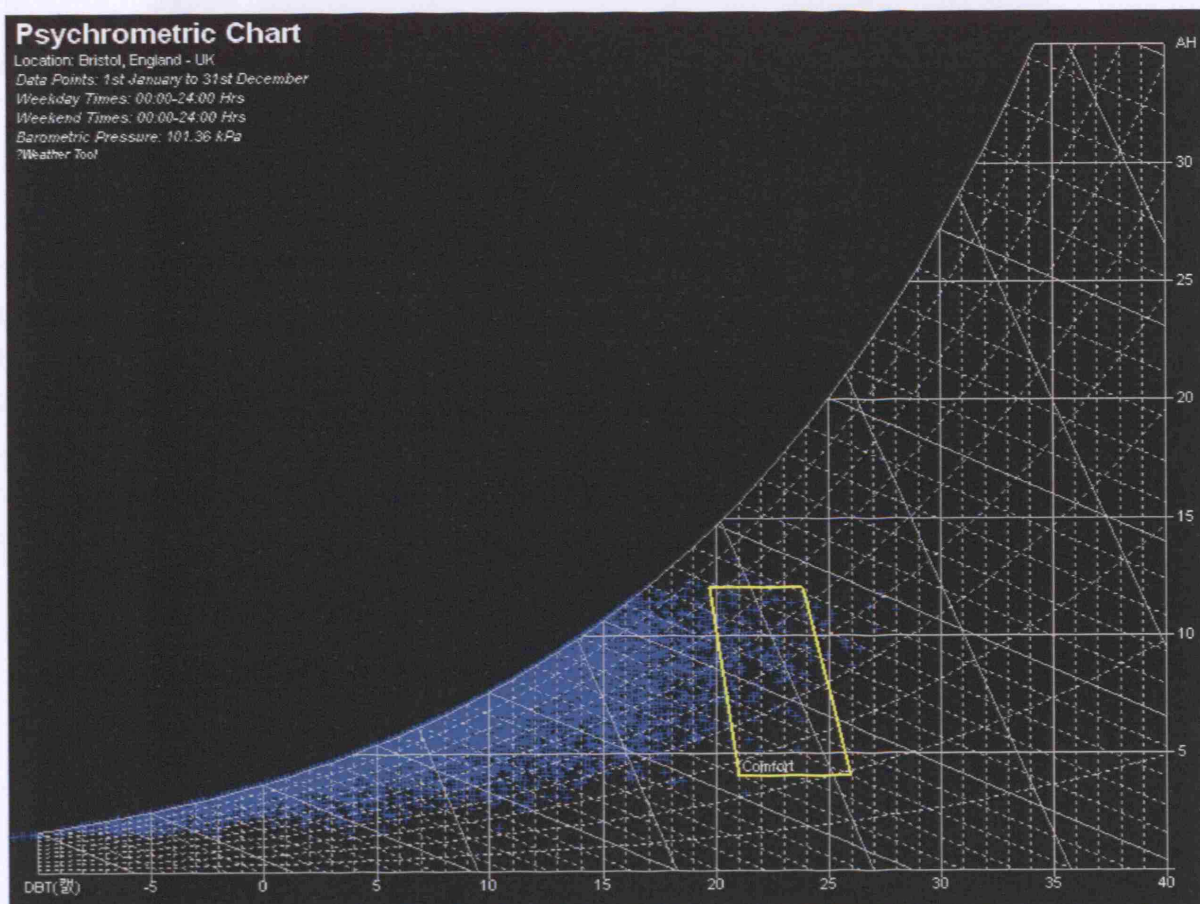

Figure 16: Annual temperature and moisture content data of Bristol, UK (Source: Square One)

Moreover, the difference between heating and cooling degree hours illustrated in Figure 17 suggest that the climate in which the building is situated is a heating dominated climate where attention should be given to ventilation heat loss during winter. In addition, mild temperature during the warm periods proposes potential for utilising natural ventilation to minimise overheating. However, it should be noted that the climate condition in Bristol is likely to be different, more severe, from Coventry as it is a coastal region and that it was used only to give a general idea of the climate of the region.

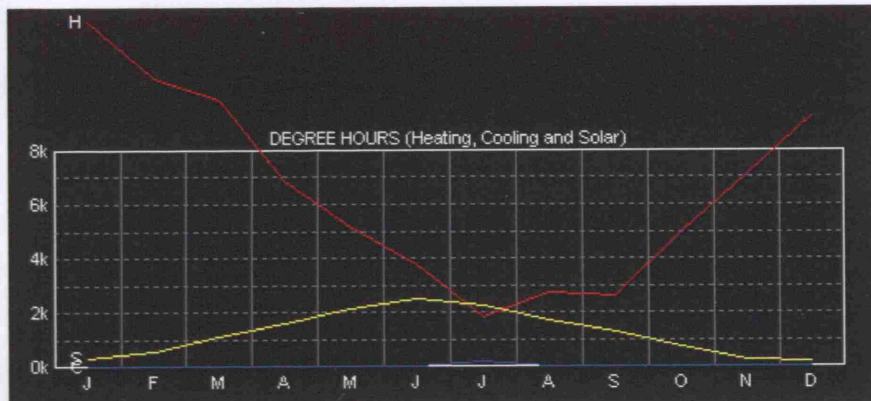

Figure 17: Heating and cooling degree hours in Bristol (Source: Square One)

- **Building context**

In Swindon, the site is situated in a low density area called Churchward which is an old heritage site of the Swindon Railway Works. As observed in Figure 18, the front façade of the building is oriented towards south, facing the open garden while it is surrounded by pedestrian walks on all sides except the north. Towards the west, there is a single storey warehouse type building, the Great Western Outlet Designer Village, which attracts numerous visitors throughout the week that may pose to be a source of noise to the exposed openings. The area that sits between the Linslade road and the building is utilised as a staff car park, which separates the building from the traffic noise. To the east is an open circulation area which is separated from the building by a line of trees.



Figure 18: Site location and the surroundings (Source: Google)

6.2 Building form

As observed in Figure 18, it is a deep-plan building with irregular foot print, approximately 100m x 65m, in which the longer facades has been designed to face north and south for easier control of solar gain and natural light. The roof is a repetition of pitched roofs, in which the opaque roofing on the south side of the pitch limits solar gain while glazed areas and openings on north side of the pitched roof provides natural light via atrium and voids. Furthermore, there are two courtyards that enhance the effectiveness of natural ventilation strategy as well as provide natural light.



Figure 19: Interior space (a) atrium space (Source: FCB Studios) (b) courtyard (Source: photo by author)

The interior layout of the building is generally open plan, which allows good air movement within the space, except the spaces that require extra attention, such as IT room. However, having such a large open space may lead to noise transfer from neighbouring spaces and cause distraction. In the building are highly dense materials where roof element was specified with highly insulated 80mm precast concrete slabs that are exposed to promote night ventilation together with exposed concrete floor slabs of the first floor.

6.3 Ventilation components and control

The opening components mostly used in the building are top hung windows and bottom hung panels which are used along the perimeter of the building together with the series of openings installed under the snouts. All openings in the building are fitted with actuators that are connected to the building management system (BMS) for automatic control. Based on the information gathered from the temperature sensors and CO₂ sensors located around the office area, BMS controls the openings to induce natural ventilation either for fresh air or cooling during summer. Moreover, a degree of control

has been provided to the occupants whereby each of the banks of windows and roof vents are fitted with manual override switch that would ignore the control from BMS for 60 minutes. Although the building has numerous openings around the perimeter, the issues concerning security from opening vents for natural ventilation have been eliminated by installation of security grills along the front façade together with highly positioned perimeter inlets.



Figure 20: Ventilation components (a) Inlets on East and West façades (b) security grills (c) snout (Source: photo by author)

6.4 Ventilation strategy

In the design process of the building, the designers utilised the thermal modelling software TAS in order to verify the validity of the proposed design and develop the performance of the building. Through the simulations, the designers have optimised the number of snouts, selected the construction materials that would have influence towards the internal conditions, and checked the validity of the proposed natural ventilation strategy and effectiveness of night ventilation based on the internal temperatures and ventilation rate acquired from simulation results.

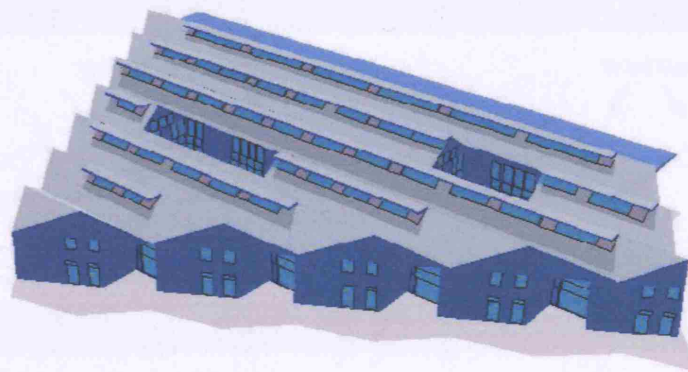

Figure 21: TAS simulation model of the building (Source: Max Fordham)

The ventilation strategy implemented to the building is a stack driven mixed-mode with mechanical assistance where natural ventilation is set as a default mode to serve most parts of the building. As shown in Figure 22, fresh air is introduced to the interior space via openings located around the perimeter of the building as well as walls facing the courtyard. The air introduced to the interior space travels across the occupied area where the air picks up heat and pollutants which then rises towards the snouts via double height spaces and atrium space due to buoyancy effect.

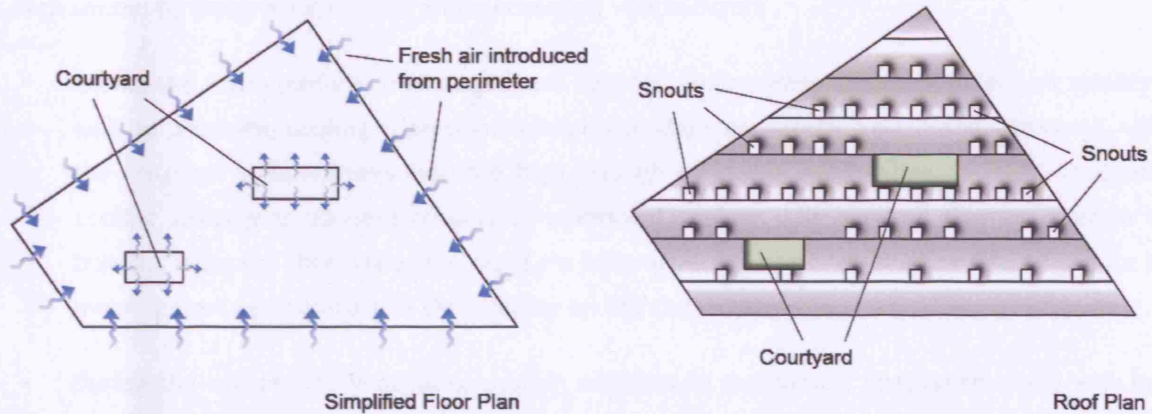

Figure 22: Simplified floor and plan showing air flow and main elements

The used air is finally exhausted through the snouts (Figure 23) which consequently induces inflow of fresh air through the inlets around the perimeter. The design height of the office, 3.7m from floor to ceiling, also contributes to enhance the buoyancy effect.

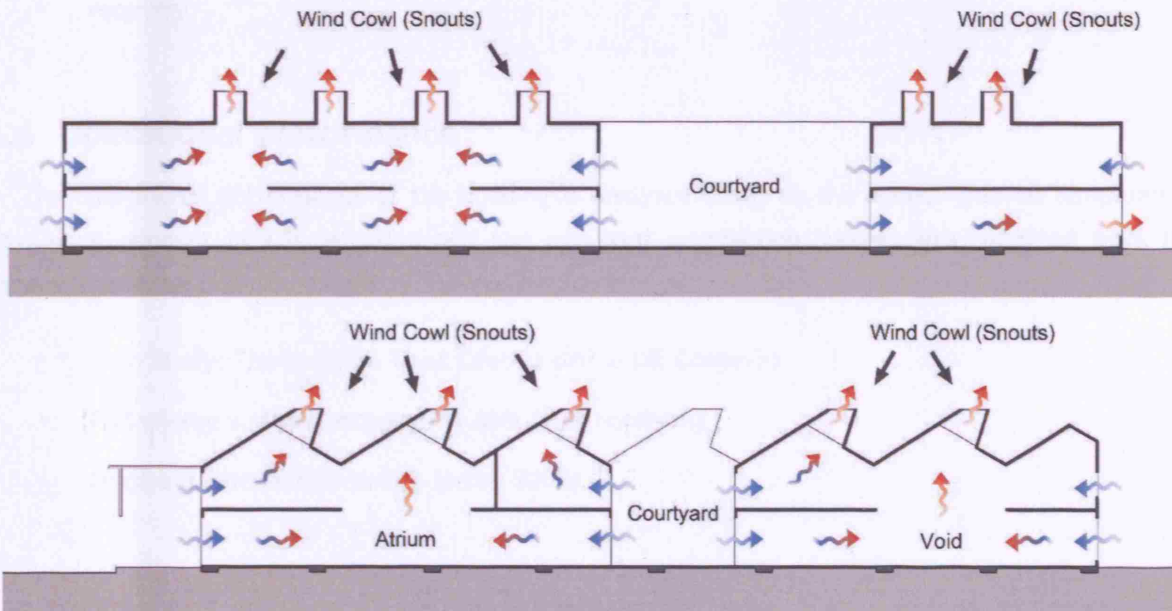

Figure 23: Natural ventilation strategy: (a) East-West section (b) North-South section (adopted from: Max Fordham)

In contrast to most parts of the building, specific rooms with higher internal gain, such as central IT equipment room, that requires careful control of the environment are mechanically cooled.

6.5 Seasonal operation

To minimise the energy consumption throughout the year, the building operates in different modes for each season by integrating natural and mechanical ventilation:

- During the warm periods, mid season and summer, maintaining adequate indoor air quality as well as providing cooling is predominantly dependent on natural ventilation. However, when the external temperatures become high enough to cause overheating, a night ventilation cooling strategy is adopted to provide additional cooling. The exposed thermal mass in the building is cooled throughout the night via natural ventilation controlled by BMS to reduce the mean radiant temperature in the building on the consecutive day.
- During the winter, the ventilation system switches to mechanical ventilation mode with heat recovery system where all perimeter openings are sealed and air intake and extract is dependent solely on the snouts. The fresh air drawn through snouts is preheated by the heat retrieved from heat exchangers installed to a number of snouts. The air is then distributed throughout the office via void under the raised floor from the air handling unit. When the air is used, it rises towards the ceiling where it is extracted through the extract grills for heat recovery.

6.6 Operational performance

The operational performance of the building is analysed based on the annual internal temperature frequency, amount of CO₂ emission and the occupant satisfaction survey data collected from the following sources:

- Case Study: The National Trust Central Office (SE Controls)
- Full energy and post-occupation data (Max Fordham)
- Occupant satisfaction survey (Bunn, 2007)

Figure 24 illustrates the % of the hours that exceed each temperature which was recorded by BMS throughout the year in 2006. The two black lines, represents the guidelines which recommends limiting indoor temperature during occupied hours from exceeding 25°C to 5% (CIBSE, 2001) and 28°C to 1% (CIBSE, 2006). Based on these guidelines, it can be seen that the internal temperatures are well within the recommended values which suggests the building is maintaining adequate condition for its occupants throughout the year.

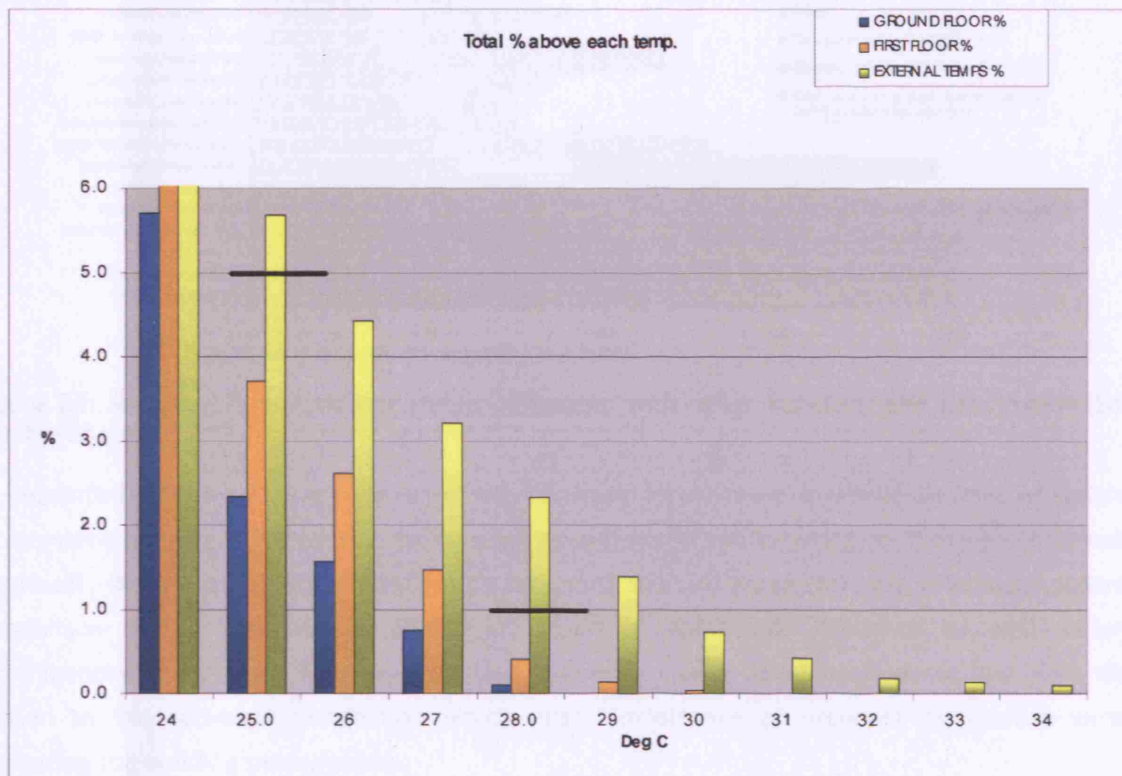

Figure 24: Summary of annual internal temperatures (Source: Max Fordham)

The information that illustrates the performance of the building is a chart (Figure 25) which shows the amount of CO₂ emission per square meter per annum compared with the buildings assessed in the UK Probe Studies (Bordass et al., 2001) and the benchmark figures illustrated in the Energy Consumption Guide ECG 19 (DETR, 2000). As shown in Figure 25, CO₂ emission in the Heelis building is positioned between the CO₂ emission rate of typical and good practice type 2 naturally ventilated open-plan buildings. Although, the total emission seem much more than that of good practice building, it can be seen that more than half of the emission results from energy consumption by other factors that are irrelevant to the environmental design of the building in terms of heating and cooling. Therefore, considering only the necessary figures, the building can be observed to be performing well.

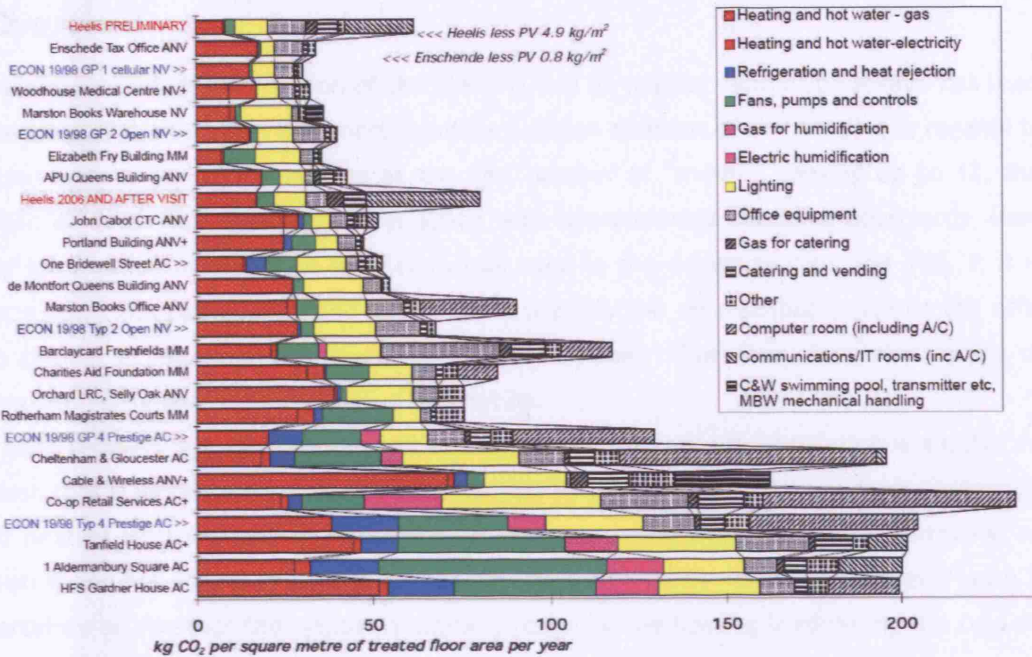

Figure 25: Annual CO₂ emission of Heelis compared with other buildings and benchmark (Source: Max Fordham)

Presented in Figure 26 is a summary of the occupant survey result in which the level of satisfaction for temperature and air movement during summer and winter are included. As it can be observed from the result, the overall levels of satisfaction regarding the two parameters are relatively moderate in comparison to the temperature profile in Figure 24 which was shown to be well within the recommended guide line. This suggests that satisfying the recommended guide line isn't directly related to the occupant satisfaction which raises importance of occupant satisfaction survey in evaluating the building performance.

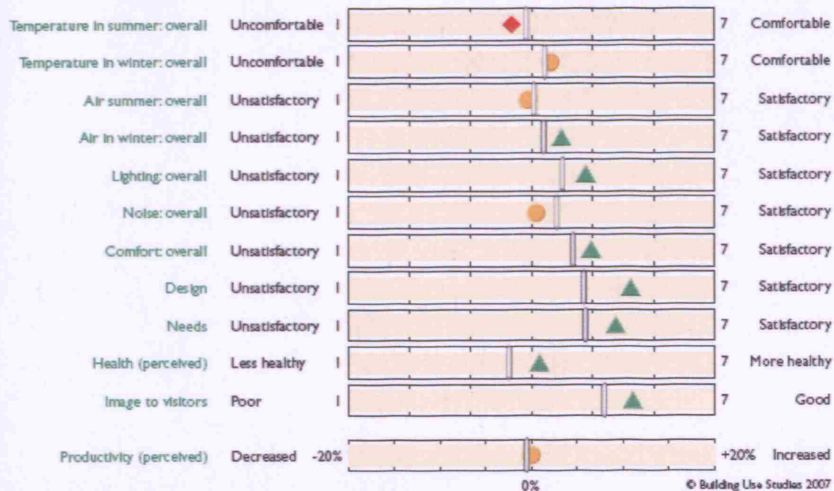

Figure 26: Occupant satisfaction survey result of Heelis in 2006 (Source: Bunn, 2007 pp. 12)

6.7 Overview

In general, abundant information of the building and its natural ventilation system has led to good understanding of the building. The most significant design element of the building in regards to natural ventilation system can be considered as the vast number of 'snouts', ranging up to 42, that allows ventilation of deep floor spaces in conjunction with appropriately allocated courtyards. However, as the only information available on simulation tool used in the design process was TAS, it is uncertain whether a study has been conducted using CFD to identify the air distribution across the office which may be critical in naturally ventilated deep plan buildings. Therefore, a closer analysis should be carried out to verify any possible areas of stagnation.

The heat recovery system incorporated in conjunction with natural ventilation is another feature of the system that is innovative which was used to minimise the heat loss during winter that would lead to reduced heating load and energy consumption. However, comparison of the CO₂ emission associated with heating and hot water with the good practice type 2 naturally ventilated offices (Figure 25) raises an uncertainty on whether the system is actually reducing the heating load during the cold seasons to balance off the increased consumption from fans, pumps and controls.

Chapter 7. Case Study: National Assembly for Wales

7 Case Study 2: National Assembly for Wales



Figure 27: Main view of National Assembly for Wales (Source: photo by author)

The National Assembly for Wales building, located in Wales, UK, is a civic building which was designed by Richard Rogers Partnership with environmental consultancy by BDSP aimed to minimise energy consumption and waste as well as creating an exemplary model for sustainable buildings. The building comprises of three storeys and floor area of 4,000m² in which there is a debating chamber, also called as the Siambwr that accommodates up to 60 members, committee rooms, general meeting rooms, IT/media facilities and members' lounge that are used by assembly members. Moreover, the building also houses public areas such as reception area, café and the public viewing gallery of the debating chamber.

The following sub chapters analyse the site and design of National Assembly for Wales building and its natural ventilation system based on the information acquired from a site visit, online information from various organisations involved in the design process (Richard Rogers; BDSP) as well as publications (Bode, 2007; Correnza et al.), and literatures such as information booklets (NAW, 2006). Moreover, the operational performance of the building is analysed in the later sub-chapters which is followed by an overview.

7.1 Site analysis

- Weather analysis

Within the temperate climate zone of UK, Cardiff is located in the south part of Wales. Figure 28 shows the weather data for Cardiff plotted onto a psychrometric chart in Weather Tool (Square One). The recorded temperatures are mostly below and out of the indicative comfort zone, yellow box, rarely falling below 0°C during cold seasons and rises above 25°C during warm seasons.

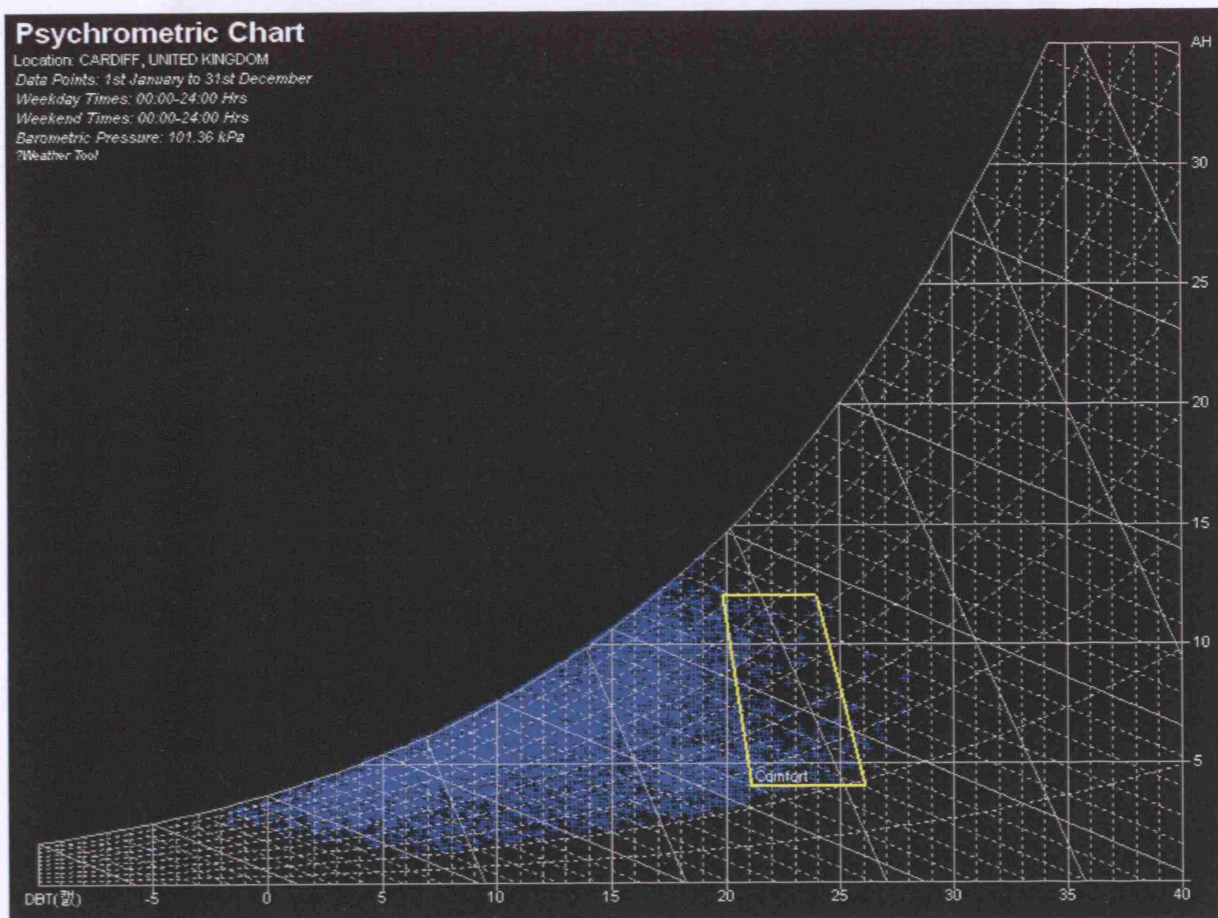

Figure 28: Annual temperature and moisture content data of Cardiff, Wales (Source: Square One)

Moreover, the climate can be better understood by looking at Figure 29, which illustrates the heating and cooling degree hours required to maintain comfortable indoor environment at Cardiff. In the graph, both heating and cooling degree hours are observed to be relatively high which suggests that attention should be given to minimise heat losses during winter as well as overheating during summer.

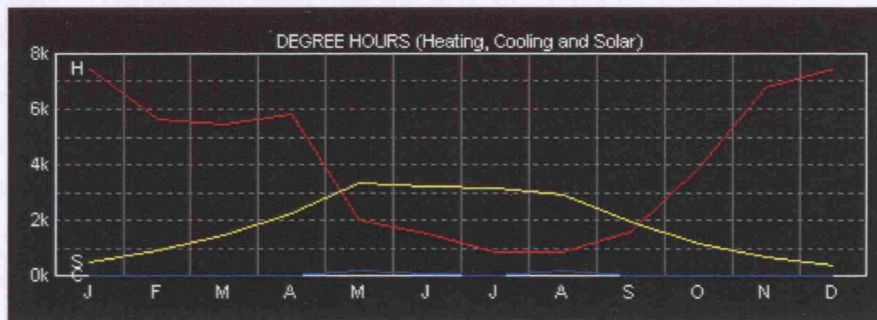

Figure 29: Heating and cooling degree hours in Cardiff (Source: Square One)

- **Building context**

The site is situated in a low density suburban area by waterfront of Cardiff Bay (Figure 30). The building faces southwest towards the bay while it is surrounded by low rise, three to four storey, buildings such as Pierhead Building and the new Welsh Millennium Centre. In general, it is a quiet area for sightseeing, in which there is a road, Pierhead St, with low level of traffic that passes around the building that may be of concern regarding the pollution. Moreover, small attractions such as merry-go-round and a number of restaurants are found towards the southwest along the bay. Although the characteristics of wind on site is uncertain, being located in such an open area by the bay is likely to provide sufficient wind throughout the year for natural ventilation.

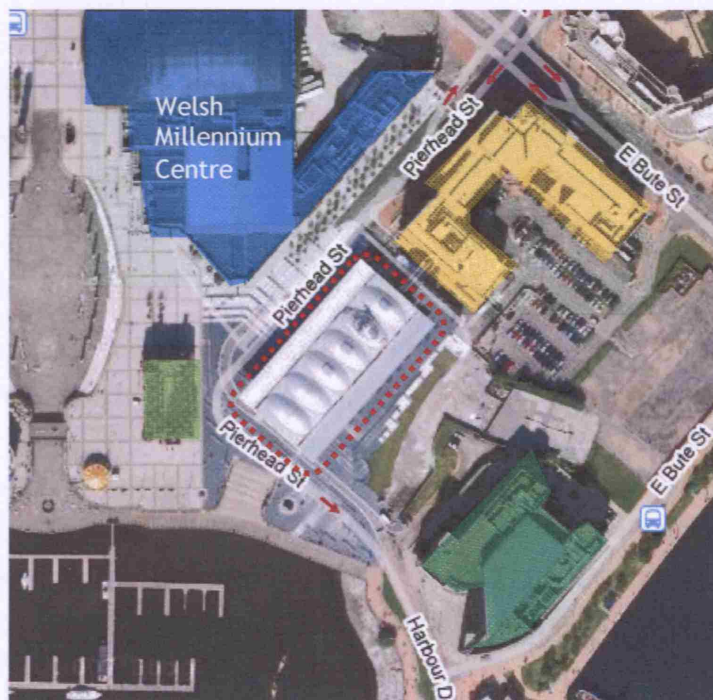

Figure 30: Site location and the surroundings (Source: Google)

7.2 Building form

The building has a rectangular foot print, approximately 33m by 55m, with a large circular funnel at the middle of the building that penetrates through from basement level to the roof that induces natural ventilation. The external wall of the building is a single-glazed blast-resistant facade (Correnza et al., 2006) on which numerous openings are located. Moreover, the overhangs of the roof and external louvers on the West façade provide shading to the façade from the sun on all sides the building.



Figure 31: General form of the building observed from east and west side of the building (Source: photo by author)

The high density materials in the buildings are the slate flooring in the building and the exposed concrete columns and soffits of the floors which are utilised to provide effective night ventilation cooling. However, due to the steel roof structure and the wood cladding, thermal mass is limited to previously mentioned elements.

7.3 Ventilation components and control

The opening type used for ventilation of the public area is a top hung window which is located at the top and bottom of the external wall, all of which are fitted with actuators for automatic control (Figure 32b). Due to limited information, it is uncertain which sensors the buildings if installed with for BMS. However, it is likely that they are controlled according to the information gathered from temperature sensors located around the space and possibly both temperature and CO₂ sensors in the debating chamber. Another important component of the building is the six metre high wind cowl that rotates according to varying wind direction, always positioning the extract vent on the lee ward side of the cowl, utilising the negative pressure to discharge used air while minimising possibilities of back flow. This will be an effective way of extracting used air from the building with aid of high velocity wind which is likely in the bay area.



Figure 32: Ventilation components (a) west façade (b) view of actuators (c) wind cowl on the roof (Source: photo by author)

7.4 Ventilation strategy

The ventilation strategy of the building is a mixed-mode comprising of cross ventilation and stack ventilation with mechanical assistance whereby building is divided into different zones which are served by different strategies: public area; meeting chamber with public gallery; and meeting rooms.

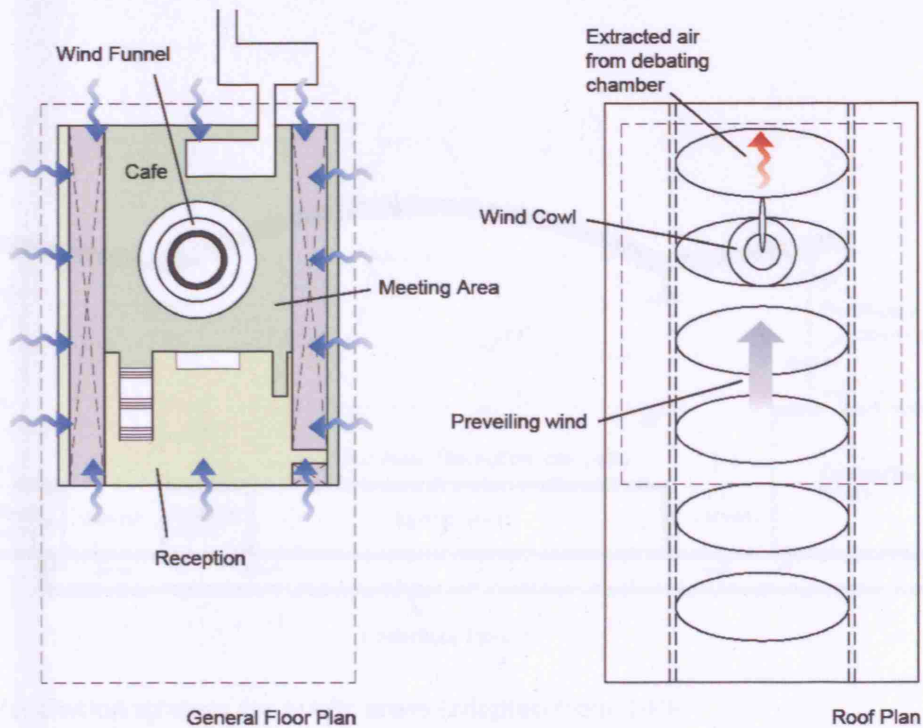

Figure 33: Simplified floor and roof plan showing air flow (adopted from RSHP)

7.4.1 Public area: café, reception area and gallery



Figure 34: View of public areas (Source: photo by author)

In general, observation of the building suggests that the public areas (Figure 34) are ventilated by single sided and cross ventilation which is likely to be enhanced by supplementary stack effect induced by the large height difference between the high and low level perimeter openings on external walls as illustrated in Figure 35.

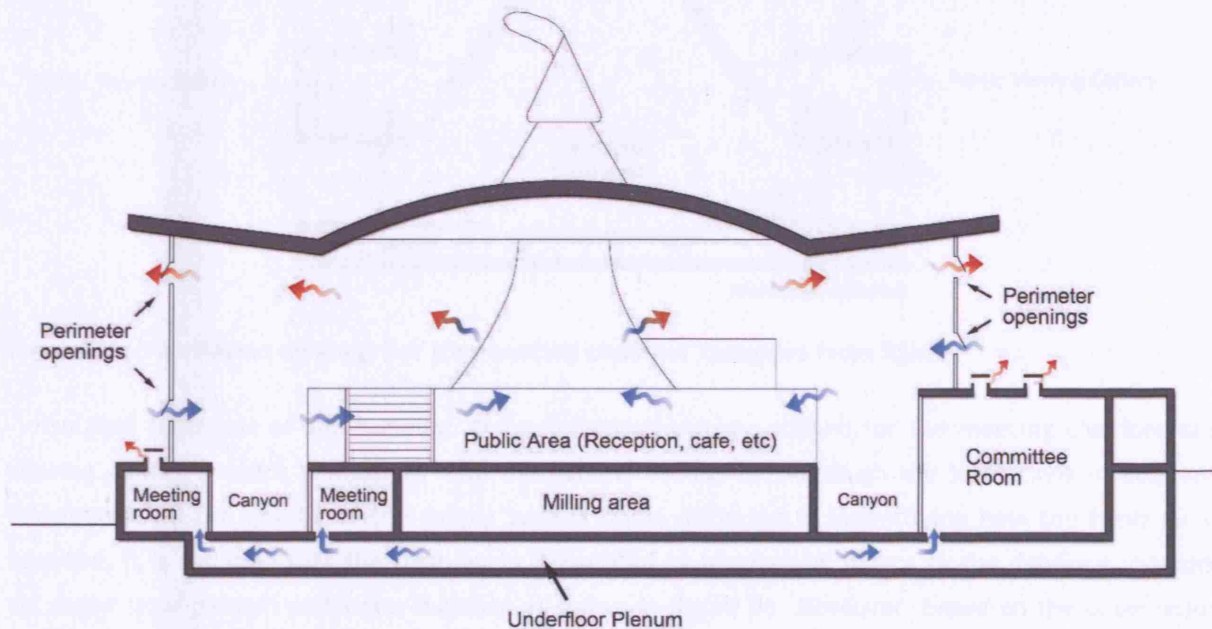

Figure 35: Ventilation strategy for public areas (adopted from RSHP)

7.4.2 Offices and meeting rooms

The meeting rooms and offices are located on the basement level along the perimeter of the building. In these rooms, fresh air is introduced by mechanical means via under floor plenum while the used air is extracted through the bespoke roof vents or openings connected to the outside (Figure 35).

7.4.3 Debating chamber and viewing gallery

The ventilation strategy for the meeting chamber is utilised by the funnel located at the centre of the building, which acts as an exhaust stack that is dedicated to serve the debating chamber and the viewing gallery (Figure 36).

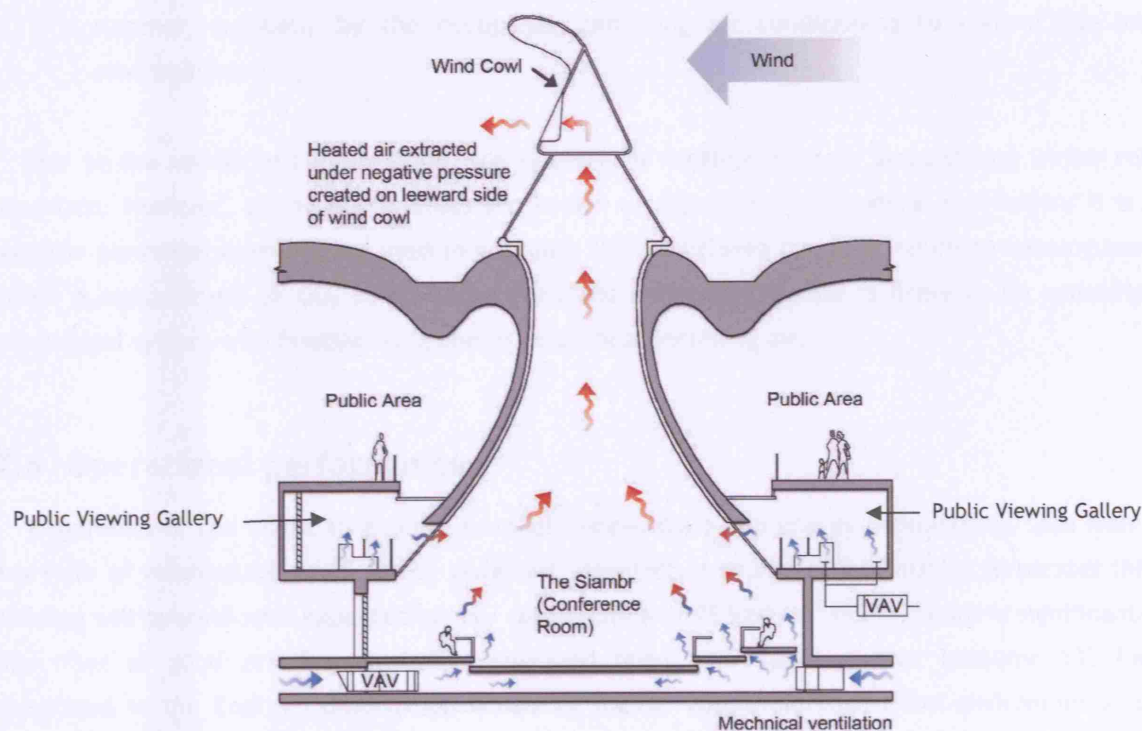

Figure 36: Ventilation strategy for the meeting chamber (adopted from RSHP)

Isolated from rest of the building, the ventilation strategy utilised for the meeting chamber and viewing gallery is stack ventilation with mechanical assistance. Although the limitations in acquired information on the details of the supply system raises difficulty in identifying how the fresh air is supplied, it is assumed that the fresh air is introduced by mechanical means to the debating chamber via under floor plenum under the chamber as shown in Figure 36. Moreover, based on the observation of exterior of the building and available floor plans (RSHP), the air intakes for basement spaces are likely to be located on the north side of the building. Consequently, the introduced fresh air rises up the funnel and becomes discharged through wind cowl.

7.5 Seasonal operation

- Public areas

During the mid-seasons and summer, additional cooling is provided by under floor system connected to the Ground Source Heat Pump whenever the cooling capacity of natural ventilation is insufficient.

- Meeting rooms and the debating chamber

The default strategy is a mixed-mode with natural discharge but the system is designed so that it can be changed over to HVAC system when there is an overheating due to high gains during summer, manually by the occupants, providing air conditioning to control the internal environment.

Due to the insufficient information, the operational strategy of both areas during winter remains uncertain. However, as the public areas are known to depend only on natural ventilation, it is likely that the perimeter openings are used to ventilate the public area but with minimum opening based on either a temperature or CO₂ sensor. Moreover, the debating chamber is likely to be ventilated via mechanical system with heating components to preheat incoming air.

7.6 Operational performance

Regardless of the effort to acquire internal temperature and energy consumption data from BMS, any form of information could not be obtained. However, a source of information illustrates that the building will operate with expected energy consumption of 75 kWh/m² (RSHP) which is significantly less than that of good practice naturally ventilated open plan buildings that consume 133 kWh/m² illustrated in the Energy Consumption Guide 19 (DETR, 2000). Moreover, the environmental design systems including the natural ventilation system in NAW are to reduce the operational cost by approximately 30 to 50% (Correnza et al., 2006) which suggest that the building will bring not only the benefit of significantly reduced energy consumption but also subsequent financial benefits given that the building performs as predicted. However, as this is based merely on the expected performance, the actual consumption data should be compared to the target values to evaluate the performance in conjunction with an internal temperature profile in all areas which will reveal the comfort level of the internal environment.

7.7 Overview

In the course of analysis, lack of available information on details of control and ventilation strategy has led to numerous assumptions to analyse the system based on the understanding of the building from site visit and available resources. This includes operational systems and natural ventilation strategies of public areas and the debating chamber where the uncertainty of whether the debating chamber is mechanically ventilated throughout the year or only when the air conditioning system is used may have considerable influence on the predominance of natural ventilation in the building.

In terms of design, the central element of the building, funnel, acting as a prime element in inducing stack ventilation in the debating chamber with aid of supplementary extraction by wind cowl, is an innovative approach that minimises the potential for back flow from changing wind directions which is frequently a problem in stack ventilated buildings. However, regardless of such an innovative design element, it is to one's surprise how the building is designed with such a large glazing area, more specifically single glazing likely with a high U-value which would lead to considerable heat loss during winter, when the requirement was to design an exemplary model for sustainable buildings. Although the details of construction of buildings fabric and their U-value are unknown at this stage as well as its performance, this clearly demonstrates the extent to which the efficiency of sustainable buildings can be compromised for design purposes.

Chapter 8. Case Study: School of Slavonic and East European Studies

8 Case Study 3: School of Slavonic and East European Studies



Figure 37: Main view of the School of Slavonic and East European Studies (Source: photo by author)

The School of Slavonic and East European Studies (SSEES), located in London, UK, is an educational building which was designed by Short and Associates Architects and completed in 2005. The building is a six storey building with floor area of 3,600m² which houses numerous academic and research facilities, such as offices and rooms for tutorials and group teaching in addition to the library.

The following sub chapters analyse the site and design of SSEES and its natural ventilation system based on the information acquired from a site visit, online information from organisations involved in the design process (Short and Associates; IESD) and literatures (Short et al. 2004; Lomas 2007). Moreover, the operational performance of the building is analysed in a sub-chapters which is followed by an overview.

8.1 Site analysis

- Weather analysis

While the building is located in the temperate climate zone of UK, the urban environment of central area in London is likely to pose higher ambient temperature due to the urban heat island effect. The recorded temperatures plotted onto a psychrometric chart shows most measurements below and out of the indicative comfort zone, yellow box, occasionally falling below 0°C. However, being in the warmer part of the country, temperature during warm seasons exceed 25°C frequently and maximum temperature rises above 30°C that suggest high potential for overheating summer.

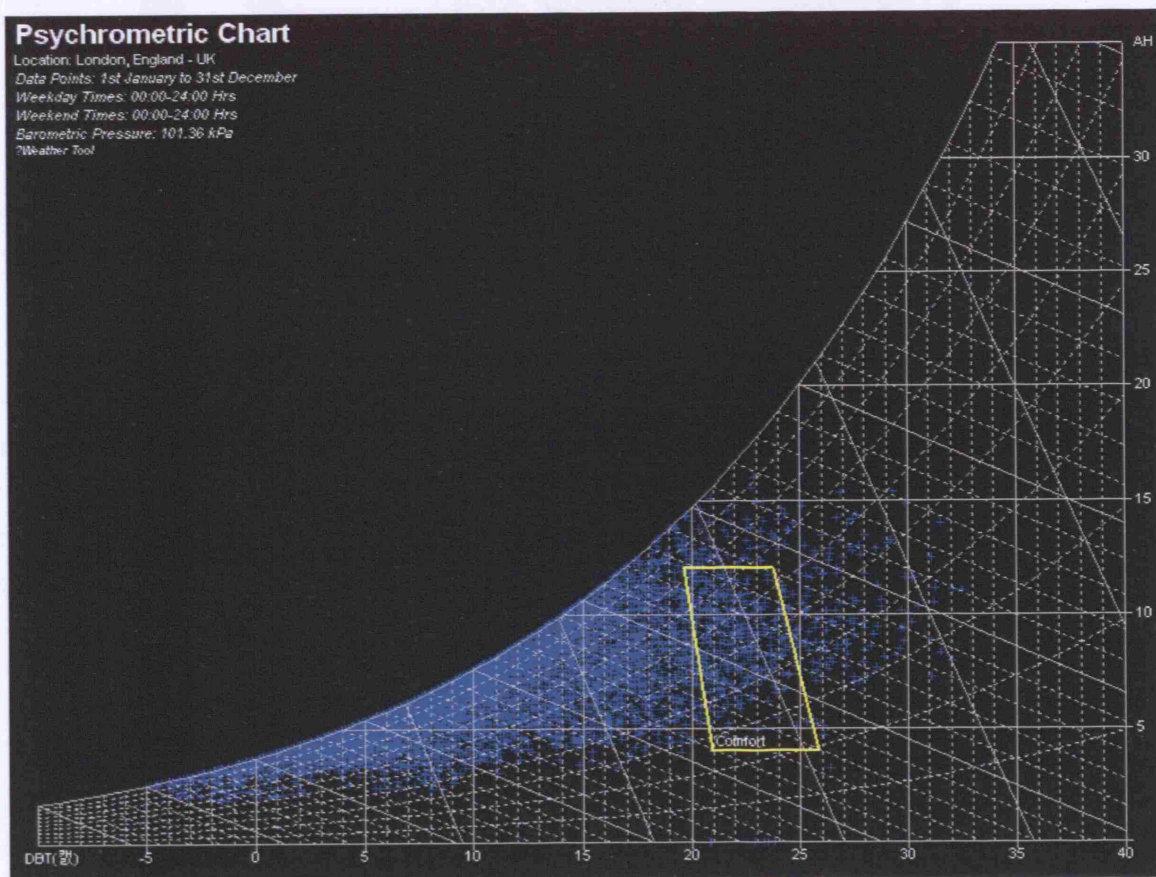

Figure 38: Annual temperature and moisture content data of London, UK (Source: Square One)

In addition to the above, potential for overheating during summer is increased due to the urban heat island effect which is illustrated in Figure 39 where average ambient temperature is observed to be few degrees higher than that of suburban area.

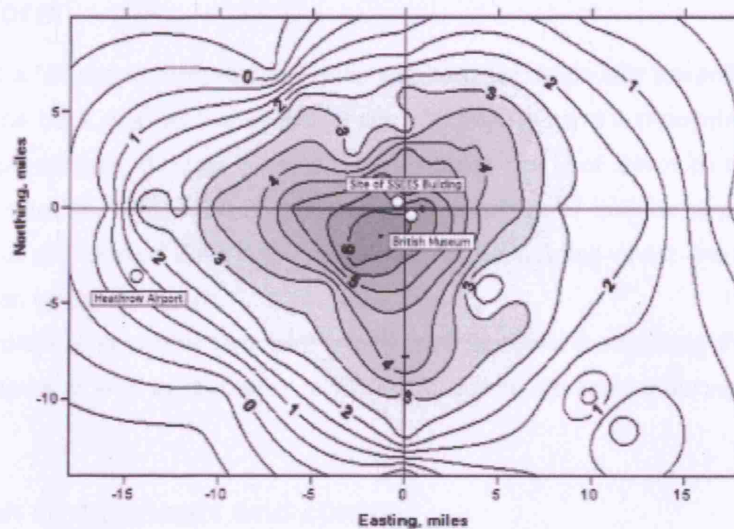

Figure 39: Variation in the urban heat island intensity across London on 2 August 1999 at 02.00 hours. Temperatures (K) are relative to the rural source. (Source: Watkins et al., 2007)

- Building context

The building is situated in a tight site (Figure 40) which is surrounded by neighbouring UCL buildings such as chemistry building to the west and Georgian terraces to the north and across the Tavion Street which passes in front of the building. As it is situated in this dense area, the elements that could impose as a concern for natural ventilation are the traffic noise and pollution from the road, urban canyon effect and urban heat island which would reduce the potential of passive cooling by natural ventilation.



Figure 40: Site location and the surroundings (Source: Google).

8.2 Building form

The building has a 'D' shape footprint by which semicircular shape lies towards the back that draws natural light from the back side. At the centre of the building, there is a triangular shaped light well, a large void, which penetrates through all floors levels from the roof down to the ground floor that induces natural ventilation. The interior space is a combination of cellular and open plan spaces in which cellular spaces are located around the perimeter of the building whilst the central area adjacent to the light well is an open plan space.

The building consists of concrete structure which contributes in moderating the peak temperatures during different seasons as well as promotes night ventilation to aid cooling during summer.

8.3 Ventilation components and control

In order to control the ventilation rate to maintain indoor environment throughout the year, all the ventilation components, such as dampers and louvers used widely throughout the building and top hung windows used for the roof of light well, are automatically controlled by a BMS based on information collected from temperature sensors around the building.

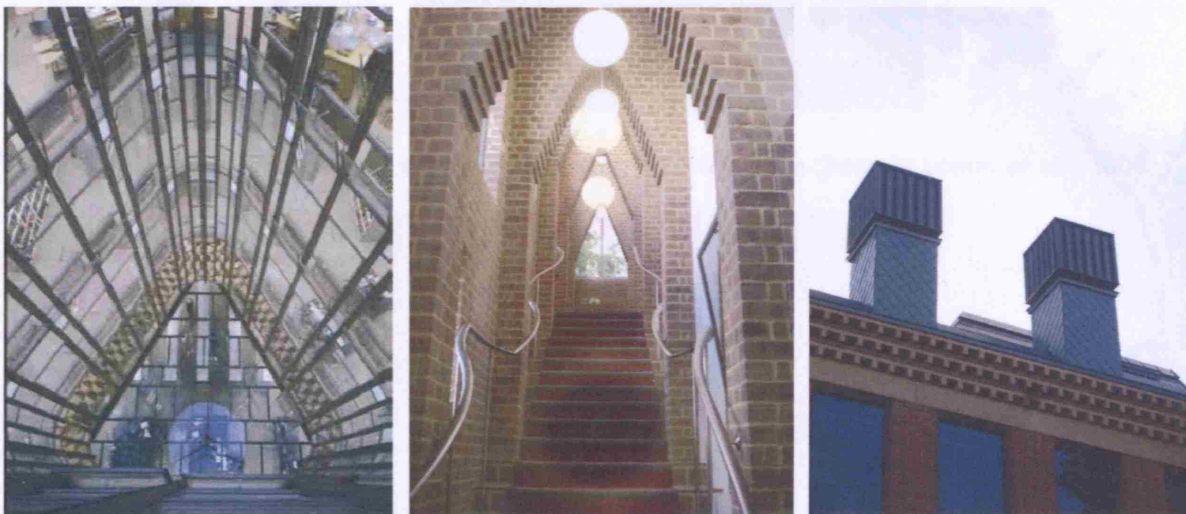

Figure 41: Ventilation components (a) view of central lightwell (Source: Short and Associates) (b) view of stair hall (c) exhaust stack (Source: photo by author)

8.4 Ventilation strategy

In the design process of the building, the designers were found to utilise the dynamic thermal model ESP-r to investigate the validity of the passive down draught cooling and develop design of the building. The two most significant findings highlighted from these simulations are the need for mechanical cooling, passive down draught cooling, to deal with overheating during summer and possibility of back flow of exhaust air resulting from accumulation of stale air at termination points that would flow back into the top floor. Consequently, the design was developed to deal with such issues and the detailed explanation of the strategy of the final design is elaborated in the following page.

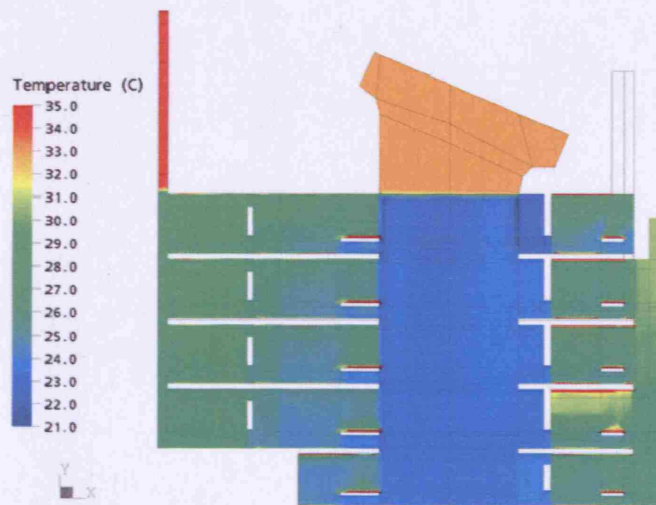

Figure 42: CFD simulation model showing temperature distribution (Source: Lomas et al., 2008a)

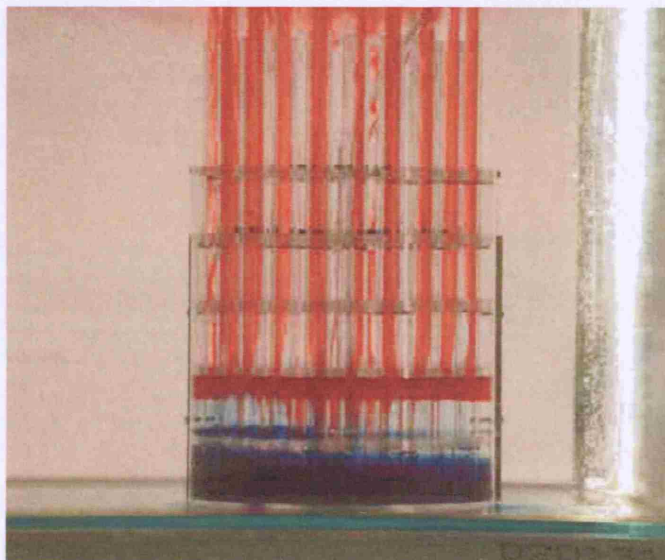

Figure 43: Water bath model of SSEES testing down-draught cooling strategy at the BP Institute (Source: Lomas et al., 2008a)

In order to maintain adequate internal conditions throughout the year, the building utilises mixed-mode comprising of natural ventilation with passive down draught cooling system. The main components designed to induce advanced natural ventilation in the building are the central lightwell, stair hall adjacent to the front façade and the exhaust stacks at the back of the building.

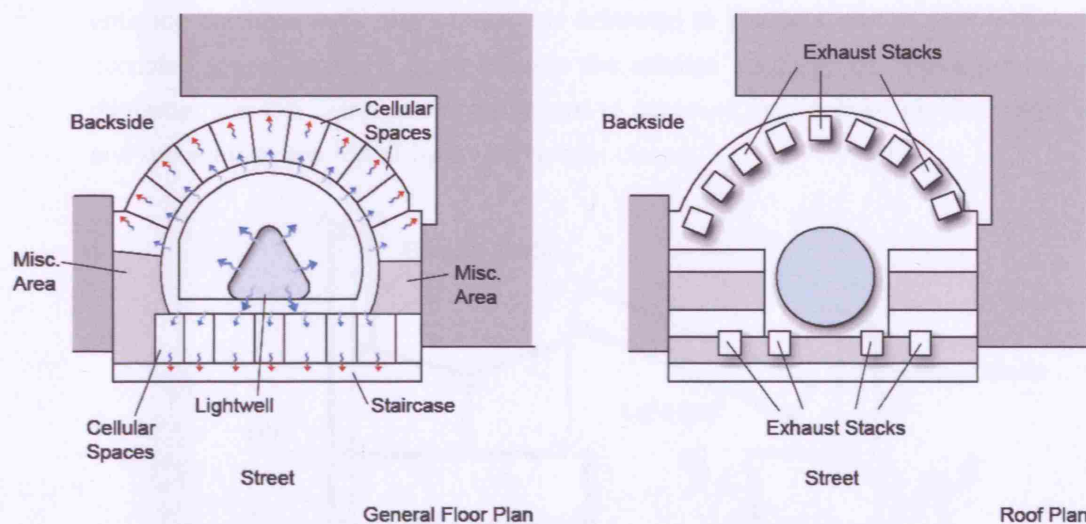

Figure 44: Simplified floor and roof plan illustrating air flow and termination points (adopted from Short et al., 2004)

In general, fresh air can be drawn in to the building either through the plenum between the ground floor and the basement, through vents located at the front and back of the building, or top of the lightwell, with aid of passive down draught cooling, depending on the mode of operation. Once the air is drawn into the building, it is delivered to the light well from which the air is introduced to the occupied spaces, through low level openings with dampers and louvers, due to air movement induced by the exhaust stacks, stair hall and chimneys, which are located around the perimeter of the building. While the supply of fresh air is solely carried out through the light well, the discharge of used air from various parts of the building is made via various vertical and horizontal paths (Figure 44 and 45). In terms of horizontal movement, the used air from cellular spaces located along the front façade is discharged through the parapet via stair hall while the used air from the cellular spaces along the back of the building are discharged via exhaust stack chimney. In terms of vertical movement, ground to second floor spaces facing the road are ventilated via stair hall while the third and fourth floors are served by a separate exhaust stack that has internal partition inside to prevent back draught of exhaust air. Similarly, first and second floor and third and fourth floor on the rear side of the building are ventilated by separate exhaust stacks. Moreover, the fifth floor spaces facing the rear side is provided with a dedicated stack (Figure 45).

8.5 Seasonal operation

- Winter

During winter, the building is in full natural ventilation mode where the buoyancy effect draws fresh air in to the building through the underfloor plenum where it is preheated before entering the light well. The warmed air delivered to the light well is then introduced to the occupied spaces where it flows towards the exhaust stacks to be discharged to outside. To minimise heat loss, ventilation rate is kept to minimum only to maintain the indoor air quality and the vents at the top of light well remain closed.

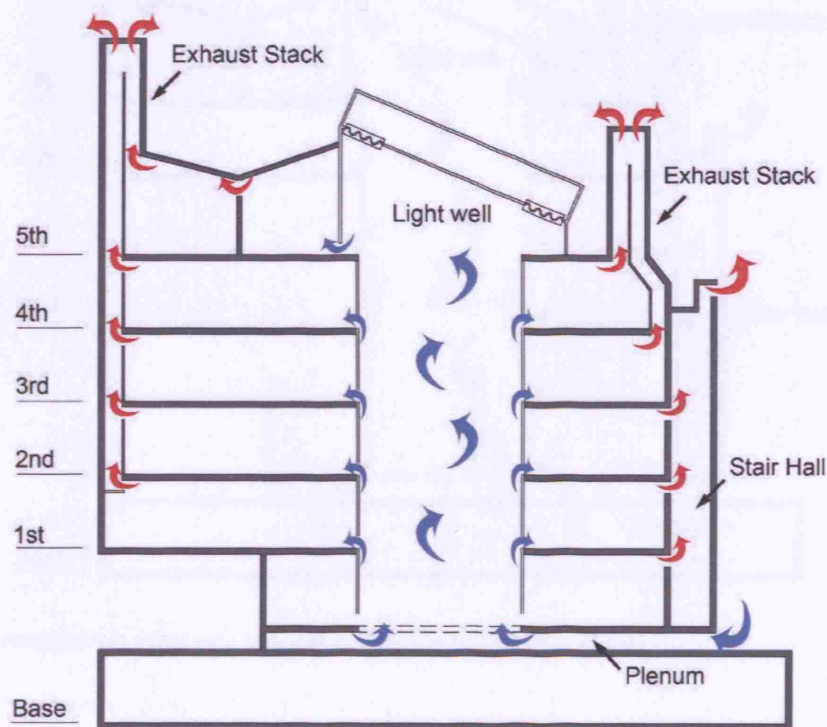

Figure 45: Winter ventilation strategy (adopted from Short et al., 2004)

- Summer

During summer, the down draught cooling system causes the air flow to reverse by which cooled air from the roof flows down the lightwell where it is accumulated. The cooled air is then introduced to the occupied spaces via low level openings following the route towards various termination points.

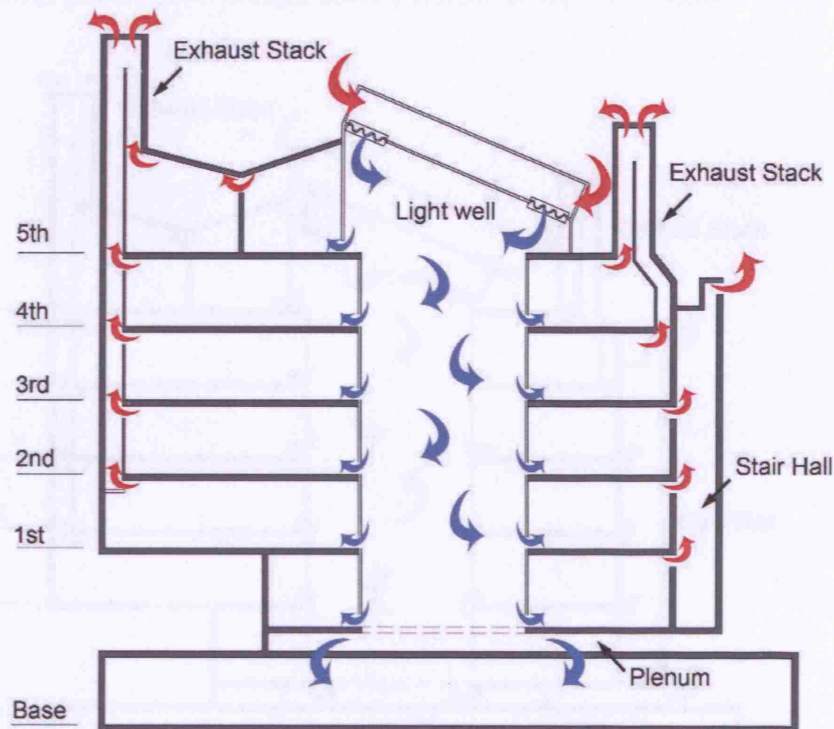

Figure 46: Summer ventilation strategy (adopted from Short et al., 2004)

- Mid-season

During the mid-season, the building is in concurrent mixed mode where fresh air is drawn through the plenum at the same time as the cooled air from the roof flows downwards to the lightwell. Moreover, the heat accumulated in the structure during the day is purged via night ventilation strategy using the same ventilation strategy. However, it is uncertain whether the building utilises passive down draught cooling system for night ventilation.

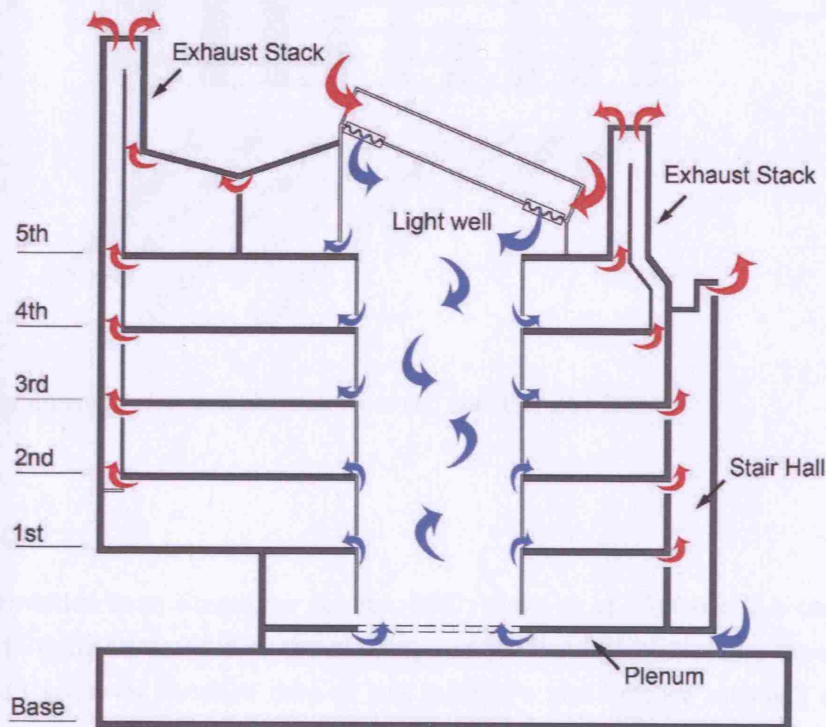

Figure 47: Mid-season ventilation strategy (adopted from Short et al., 2004)

8.6 Operational performance

According to Figure 48 below and assuming that it is a graph illustrating predicted energy consumption of SSEES, the building was estimated to consume approximately 150 kWh/m² which is significantly less than that of a standard air-conditioned building which consumes 404 kWh/m² (DETR, 2000). However, the actual energy consumption recorded by BMS acquired from the facilities manager of the building showed that the building consumes total of 245.6 kWh/m² which comprises of 122 kWh/m² for gas, likely from space heating and hot water, 123.6 kWh/m² for electricity used for cooling and others. Although the actual consumption figure is still significantly less than that of standard air-

conditioned building, it is clear that the building isn't performing as predicted where actual consumption is almost 64% more than the predicted consumption.

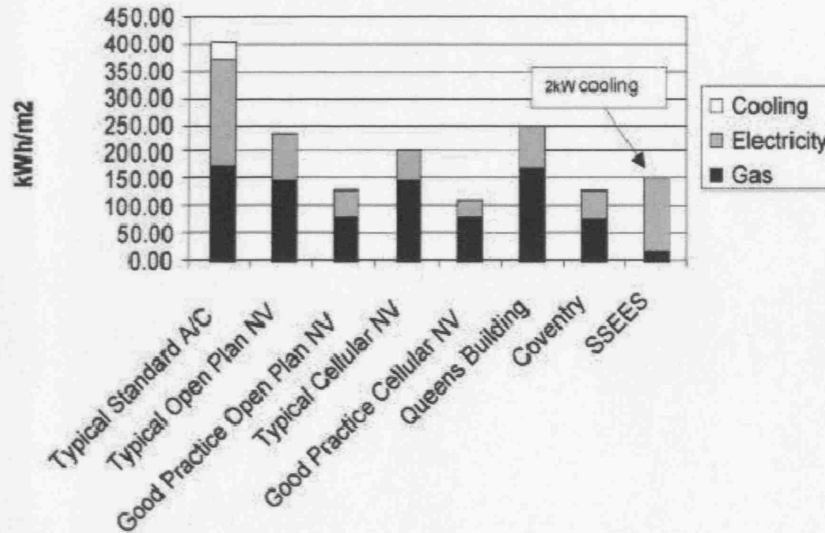

Figure 48: Energy consumption comparison (Source: Short et al., 2004)

8.7 Overview

Abundant information from literatures (Lomas, 2007; Short et al., 2004) and a case study (Lomas 2008a) has led to detailed analysis of the building and its ventilation strategy. However, there was much limitation in acquiring detailed data of the building's performance although a simple energy consumption figure was provided by the facilities manager.

The most significant design element of the building is the use of multiple numbers of stacks in conjunction with a central lightwell which enabled sealing the front façade to deal with noise from the traffic. Moreover, the degree of innovation of the building is further enhanced by the passive draught cooling method which reverses the airflow in stack ventilation to supply occupied areas with cool air to deal with high urban temperature of central London during summer while emitting relatively less CO₂ compared to a carbon intensive air conditioning system.

While the building incorporates an innovative system, the annual energy consumption data acquired from BMS was found to be significantly higher than that of expected performance which even exceeds the consumption of a good practice air conditioned office (DETR, 2000). This raises a strong necessity to conduct an occupant survey and closer monitoring of the BMS data to identify the source of problems and perhaps reduce the consumption with appropriate measures.

Chapter 9. Case Study: Lanchester Library

9 Case Study 4: Lanchester Library



Figure 49: Main view of Lanchester Library (Source: Short and Associates)

The new library and learning resource centre of the University of Coventry is the Lanchester Library located in Coventry, UK. The building was designed by Short and Associates Architects and completed in 2000 aimed to design a highly energy efficient building under the brief. The building is a four storey building with floor area of approximately 9,100m² in which all four upper floors comprise of library and book archives, and computer suites in the basement.

The following subchapters analyse the site and design of Lanchester Library and its natural ventilation system based on the information acquired online from organisations involved in the design process (Short and Associates; IESD) and literatures (Krausse et al. 2007; Lomas 2007; Short et al. 2004). Moreover, the operational performance of the building is analysed in a subchapter which is followed by an overview.

9.1 Site analysis

- Weather analysis

Within the temperate climate zone of UK, Coventry is located in the midland of England. Shown in Figure 50 is the weather data for Birmingham which is located in the vicinity of Coventry. In general, recorded temperatures are mostly below and out of the indicative comfort zone but there is relatively high proportion is in the comfort zone. The ambient temperature rarely falls below 0°C and exceeds 25°C which suggests the weather is favourable to utilise natural ventilation to limit overheating.

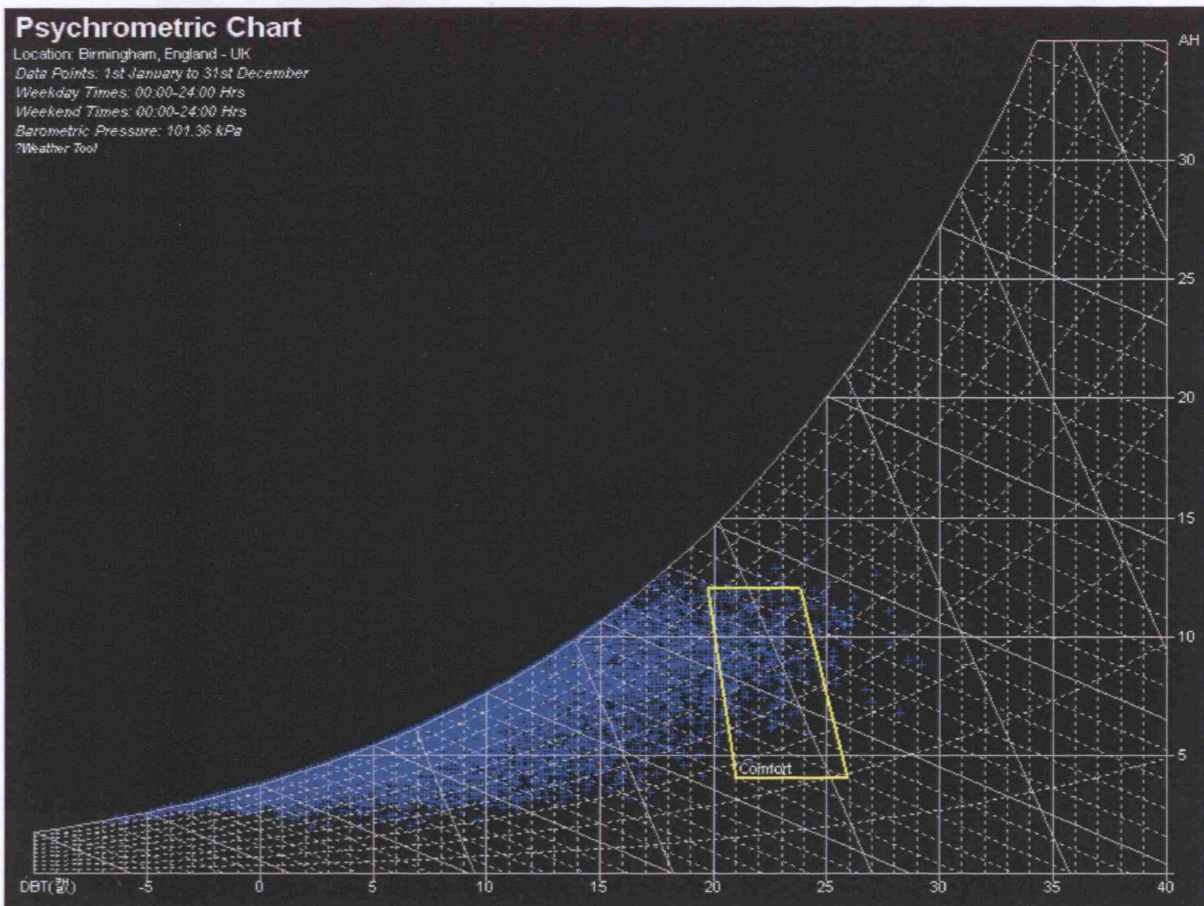

Figure 50: Annual temperature and moisture content data of Birmingham, UK (Source: Square One)

Moreover, the heating degree hours for a building in Figure 51 shows that there is significantly more heating required than cooling in this region. This raises necessity to carefully design the building to minimise heat loss during winter while maximising passive cooling methods to deal with peak temperatures during the warmer seasons which should be sufficient to maintain adequate internal environment.

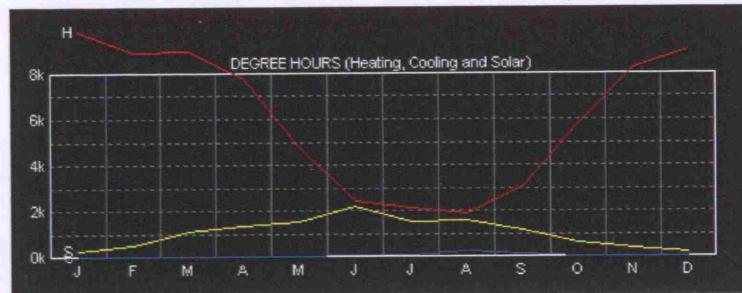

Figure 51: Heating and cooling degree hours in Birmingham (Source: Square One)

- **Building context**

The site is situated in the premises of Coventry University in central area of the city. The adjacent buildings are low rise two story high Gulson Road Hospital building to the south and the five storey high William Morris Building to the north. Moreover, to the east is a car park for the library that may act as constraints to natural ventilation concerning noise and pollutants from vehicles. Furthermore, the ring way running past on the west side of the building is likely to be a potential source of constant noise.



Figure 52: Site location and the surroundings (Source: Google)

9.2 Building form

The building has a deep-plan interior space with a square shape foot print, approximately 00m x 00m, in which there is a total of five light wells, penetrating through all floor levels, for natural ventilation. The interior space is mostly open plan with partially partitioned spaces to be used as offices or study room. In the building, the exposed concrete ceiling is utilised to enhance the cooling

potential of the building during hot periods. Moreover, the steel structure that support the concrete slab are perforated to allow good contact of fresh air with the slab as well as reducing resistance against air flow.



Figure 53: View of interior space (a) library (b) central lightwell (Source: Short and Associates)

9.3 Ventilation components and control

The air flow in the building is mainly controlled at points of introduction and termination by louvers and dampers as well as top hung windows that are used at the top of central lightwell for extraction. To maintain adequate internal environment, all ventilation components are controlled by a BMS based on the information such as temperature, wind speed and direction, and CO₂ concentration inside the library collected from sensors around the building.



Figure 54: Components (a) high level vents to perimeter stack (b) low level inlets from central lightwell to occupied Spaces (Source: Cook et al.)



Figure 55: View of the central lightwell and the vents (Source: Cook et al.)

9.4 Ventilation strategy

In the design process of the building, the designers were found to utilise a dynamic thermal modelling tool EPS-r and the CFX, a Computational Fluid Dynamics (CFD) code, to assess and develop the natural ventilation strategy. Through the EPS-r, the designers had been able to predict the internal condition and energy consumption throughout the year.

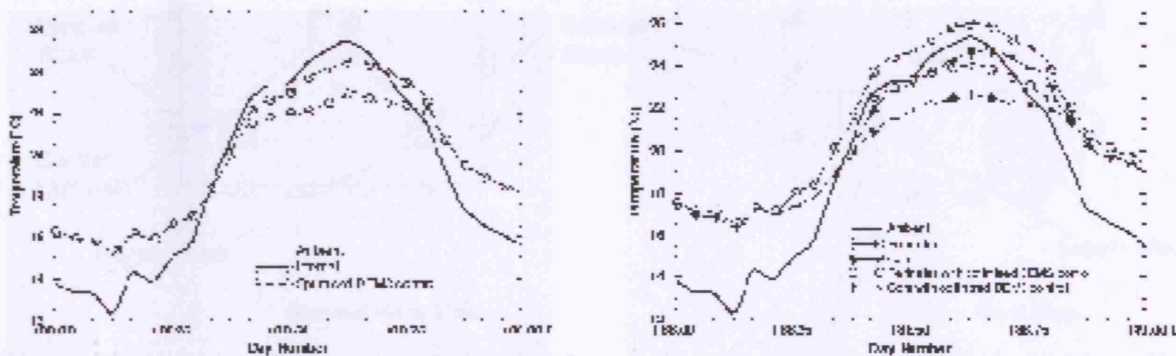

Figure 56: Internal temperature profile of the ground and third floor for a summer day (Source: Cook et al.)

Moreover, through the CFX, the designers had identified the risk of back flow on the top floor if it was to share the same stack with lower floors. Accordingly, series of detailed study of air flow and temperature around the stacks allowed change of design to isolate the top floor with dedicated stack.

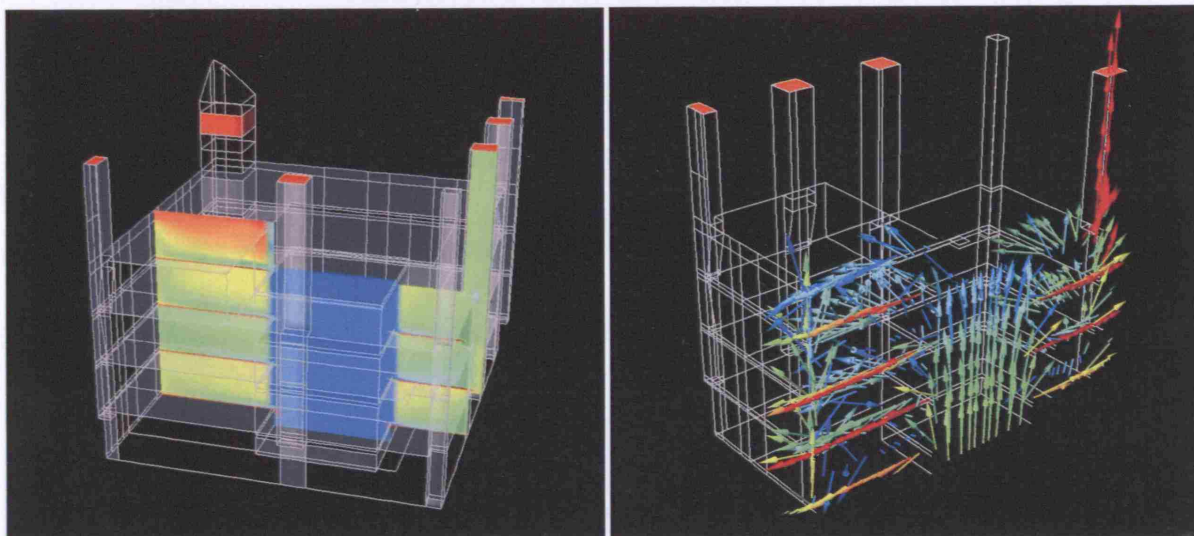

Figure 57: Images from CFX simulations investigating air temperature and flow (Source: Cook et al.)

The Lanchester library is a fully naturally ventilated building which relies on advanced natural ventilation throughout the year to provide both adequate fresh and cooling during summer.

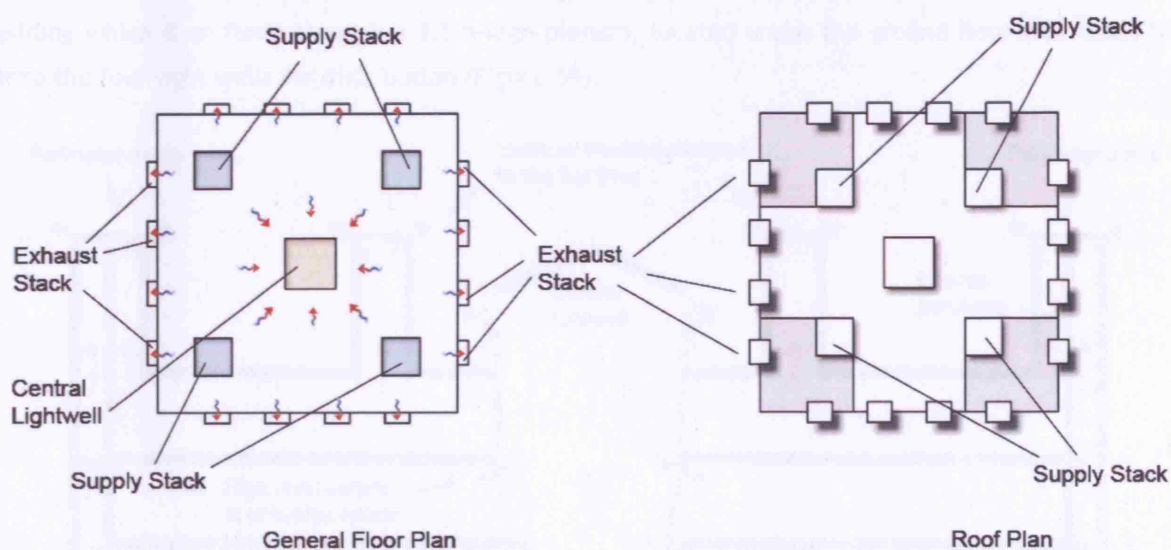

Figure 58: Simplified floor and roof plan illustrating air flow and components (adopted from Short et al.)

The main components of the building that induces stack ventilation comes from the five light wells, of which central light well is used as an exhaust stack as opposed to the surrounding four which are used to supply fresh air. Moreover, there are numerous exhaust stacks located around the perimeter that serve adjacent areas (Figure 58).

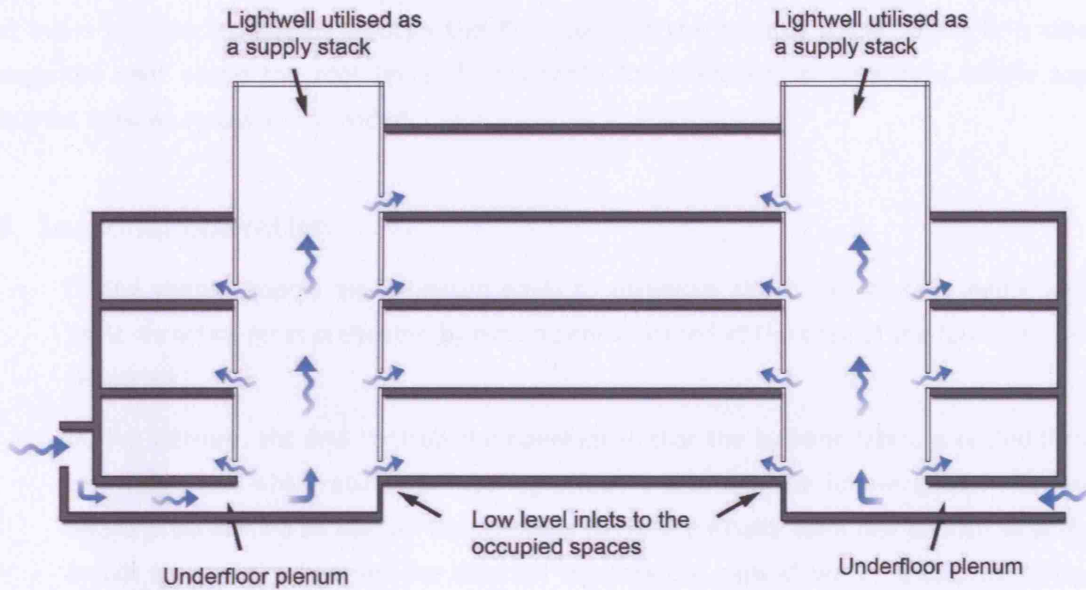

Figure 59: Simplified supply strategy of Lanchester Library (adopted from Short et al. 2004)

In general, the fresh air enters the building through the low level vents allocated around the building which then flows through a 1.5m high plenum, located under the ground floor that leads the air to the four light wells for distribution (Figure 59).

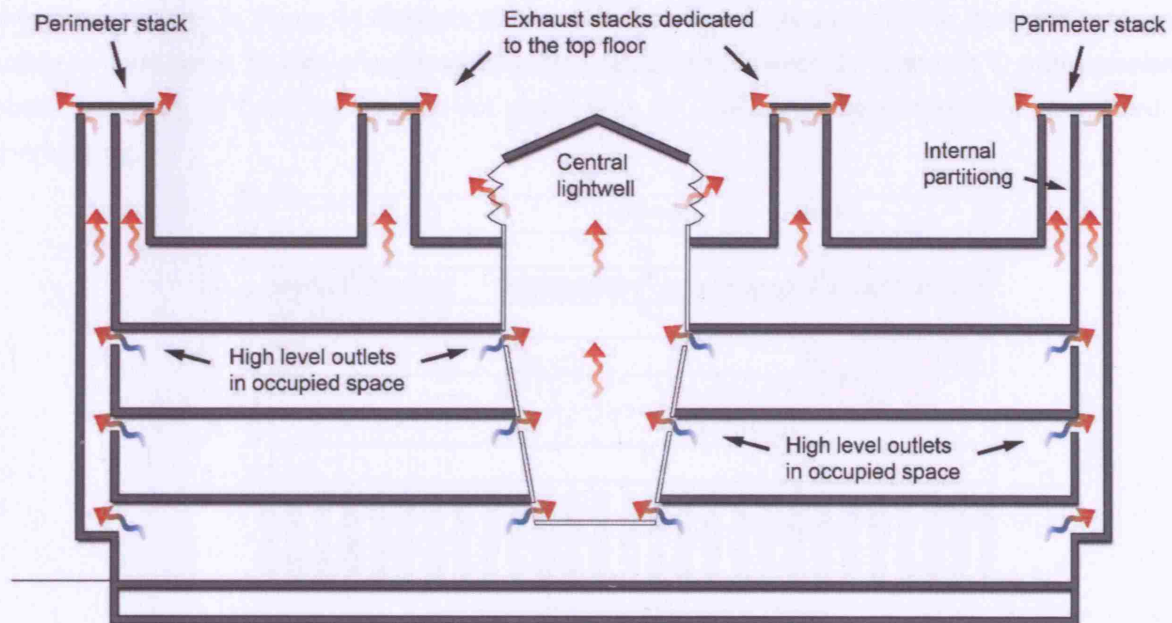

Figure 60: Simplified exhaust strategy of Lanchester Library (adopted from Short et al. 2004)

Due to airflow induced by the exhaust stacks and the central light well, the air moves through low level inlets in occupied spaces through the floor towards the exhaust stacks where it is discharged through the vent above the roof level. To eliminate the possibility of back flow to the top floor, dedicated exhaust stacks are provided.

9.5 Seasonal operation

- During winter, supply air is limited down to minimum aimed to maintain indoor air quality while incoming air is preheated by heating coils located at the base of the four light wells that supply air.
- During summer, the BMS controls the openings so that the building fabric is cooled throughout the night from which additional cooling effect is provided the following day. Moreover, the BMS is programmed so that all the openings become partially open just enough to achieve the indoor air quality whenever the external temperature rises above 24°C to prevent the warm incoming air from heating the space.

9.6 Operational performance

The operational performance of the building is evaluated by the internal temperature profile and the annual energy consumption data. The graph illustrating the internal temperature measured by BMS shown over a year in Figure 61 suggests that the environmental condition in the library is extremely stable in comparison to that of external condition remaining between 21°C and 24°C with occasional peaks exceeding 25°C during summer but well below 28°C which is the temperature considered as overheating.

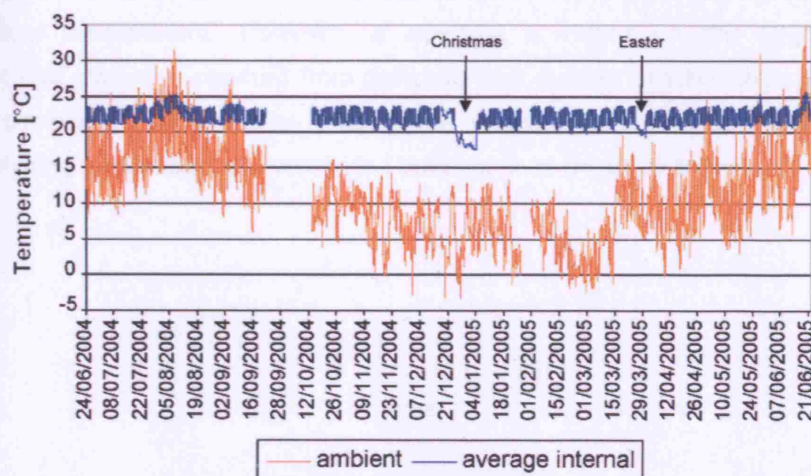

Figure 61: Internal and external temperatures during the monitoring period (June 2004-June 2005). (Source: Krausse B. et al., 2007)

In terms of energy consumption, the total annual energy consumption recorded by BMS was found to be 198 kWh/m². Compared with the benchmark figures proposed by the Energy Consumption Guide 19 (DETR, 2000), the building consumes 51% less energy than the standard air-conditioned building, which uses 404 kWh/m², and 16% less than a typical naturally ventilated open-plan building, which uses 236 kWh/m². Considering that the building is fully naturally ventilated all year round and that it is a deep plan building, the building can be considered to perform very well in maintaining adequate indoor condition as well as reduce energy consumption and the associated CO₂ emission compared to air-conditioned buildings.

9.7 Overview

Being an oldest building amongst the case study buildings, there was abundant information available which lead to thorough understanding of the building and its natural ventilation system. However, although it may be due to the unique occupancy pattern of the library, there was no occupant satisfaction survey or post occupancy evaluation conducted on the building which may have revealed valuable information to evaluate the building in detail.

The significant aspect of the design of the building is an effectively sealed façades with aid of complicated stack ventilation strategy that proposed a possibility to deal with the noise from the ring way even when it is naturally ventilated. In addition, utilising underfloor plenum not only enables sealing the façade but also reduces the vulnerability to theft through operable windows which may remain open during the unoccupied hours for night ventilation.

The temperature profile of the interior space shows a surprisingly stable condition throughout the year except for short hot spells during summer. Taking into consideration that there aren't any active means of cooling in the building, the building can be observed to perform very well in maintaining comfortable indoor environment. However, a question is raised on the degree of additional construction cost that may have resulted from designing vast number of stack chimneys which is yet to be verified in comparison to installing mechanical system. Nevertheless, the building proposes potential for designing a fully naturally ventilated building in an urban environment.

Chapter 10. Case Study: Harm A. Weber Library

10 Case Study 5: Harm A. Weber Library



Figure 62: Main view of Harm A. Weber Library (Source: Judson College)

Located in Chicago, US, the Harm A. Weber Library is part of the Academic Centre for the Judson College which was designed by Short and Associates Architects and completed in 2007. The building is a three storey building with approximately 4,600m² in floor area and consists of academic spaces, library, and architecture studio and seminar rooms accommodating up to 160 occupants and 30 computer workstations.

The following sub chapters analyse the site and design of Harm A. Weber Library and its natural ventilation system based on the information acquired from online resources by organisations involved in the design process (Short and Associates; IESD) and literatures (Woods et al. 2005; Kaiser et al., Short et al. 2007). Moreover, the operational performance of the building is analysed in a subchapter which is followed by an overview.

10.1 Site analysis

- Weather analysis

The site is located in a temperate zone (Met Office) amongst various climatic regions in US. Figure 63 shows the distribution of annual temperature and humidity from the Chicago TMY2 (Test Meteorological Year) weather data plotted onto a psychrometric chart where the recorded temperatures are observed to frequently fall below -10°C in winter and occasionally exceeding 30°C during summer. Thus, the severe condition during winter raises necessity to carefully control ventilation rate to minimise heat loss and cold draught while the occasional occurring high temperatures during summer proposes necessity to employ mechanical assistance.

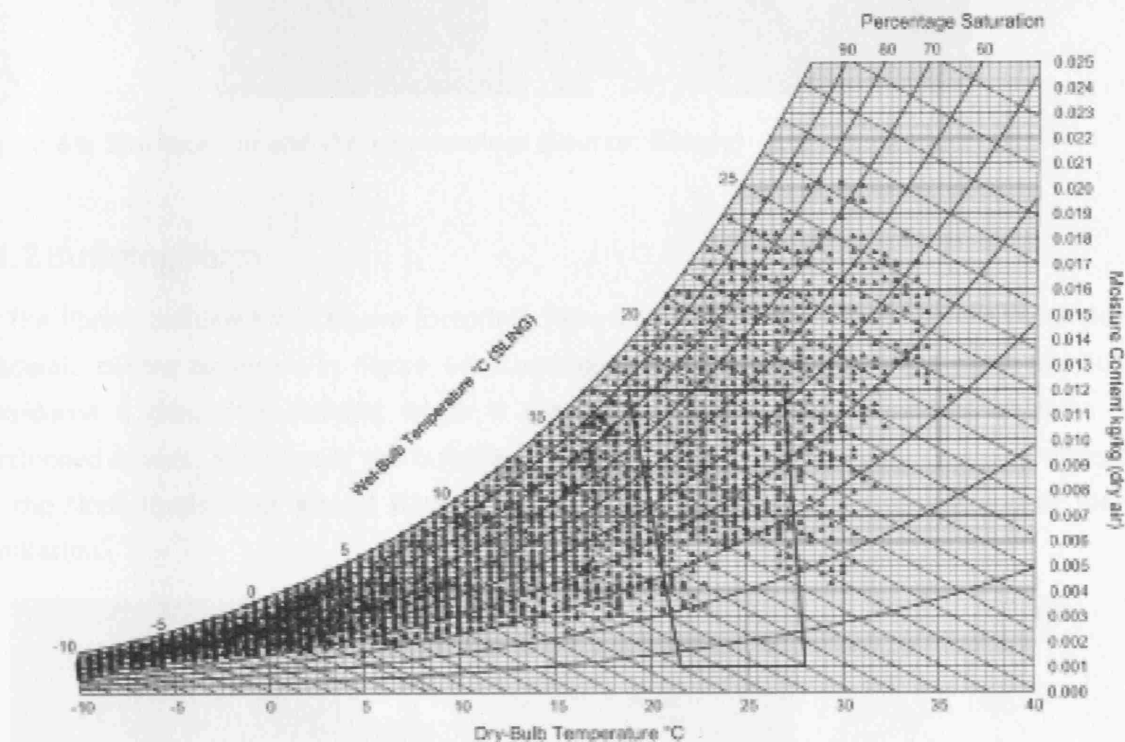

Figure 63: Annual temperature and moisture content data of Chicago, US (Source: Lomas, 2007)

- Building context

Situated in the premises of Judson College, the building is located near the entrance to the campus facing a small river to the west with natural forest beyond. To the south are open areas with a number of detention ponds that assist the sustainable drainage scheme. As for the east side, there is another green area full of trees creating boundary between the school and the local community. The only element of the site that raises concern towards natural ventilation is traffic noise from the highway on the north-east which is clearly audible from the college campus (Short et al., 2007).

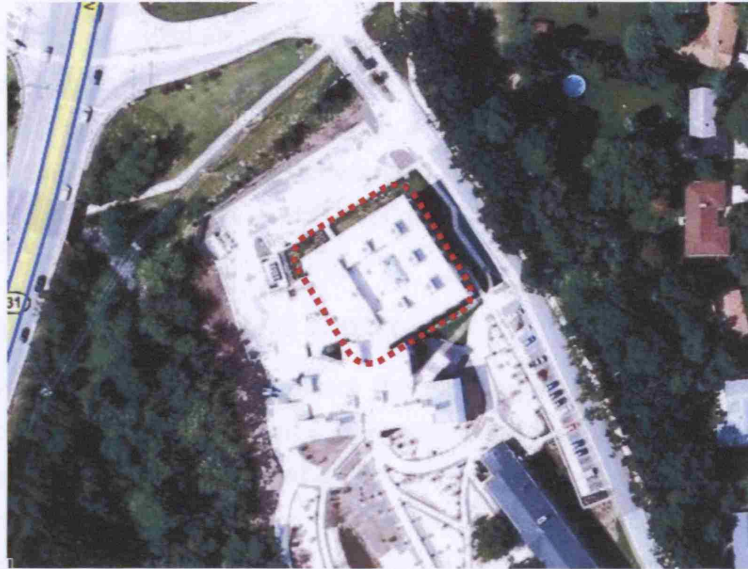

Figure 64: Site location and the surroundings (Source: Google)

10.2 Building form

The library building has a square footprint, 34 m x 34 m, which is located on the north side of the academic centre as shown in Figure 64. Considering the depth of the floor plan, the building is considered a deep plan building which is mostly open space with a number of areas partially partitioned spaces. At centre of the building is a glazed lightwell (Figure 65b) that penetrates through all the floor levels from ground floor to the roof which serves as a fresh air supply for natural ventilation.



Figure 65: Interior view: (a) architectural studio (b) top of central light well (Source: Judson college)

In terms of construction materials, numerous elements of the building, such as floor, wall and ceiling, are of exposed concrete which contribute in moderating the temperature fluctuation as well as promote night ventilation. Moreover, building has a sealed façade with aid of underfloor plenum system to deal with traffic noise from the highway and was designed to be air tight in all parts of the building to minimise air leakage as well as high level of insulation.

10.3 Ventilation components and control

The ventilation components used to control the air flow rate in the building are louvers and dampers that are connected to a BMS. Based on the settings set for the system, these are controlled by actuators according to the information gathered from various sensors located around the building. Moreover, in order to deal with unexpected high internal gains in cellular spaces located around the perimeter of the building, operable windows are provided to avoid use of distributed cooling plant.

10.4 Ventilation strategy

In the design process of the building, the designers were found to utilise the dynamic thermal modelling tool EPS-r and the CFX, a Computational Fluid Dynamics (CFD) code, as well as water bath model to assess and develop the natural ventilation strategy. Through the EPS-r, the designers had tested various operating modes of the building, natural and mechanical ventilation modes, with aid of a DTS program that enables zonal airflow model, to optimise the operation schedule of the BMS system and achieve comfort conditions.

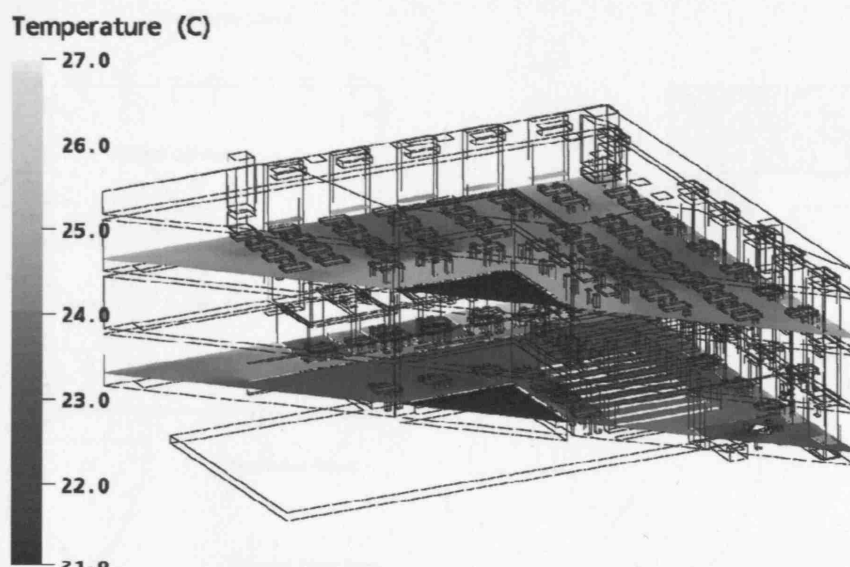

Figure 66: CFD simulation analysing temperature distribution across level two and four (Lomas et al. 2008b)

Through the CFX, the designers had analysed the air flow through the building to check the validity of the intended air flow is achieved due to internal gain. Moreover, a simplified model of the building was tested in a water bath to further verify the influence of internal gain from, occupants and computers, on stack ventilation as shown in the Figure 67.



Figure 67: Simplified model sub merged in a water bath for simulation (Source: Lomas et al., 2008b)

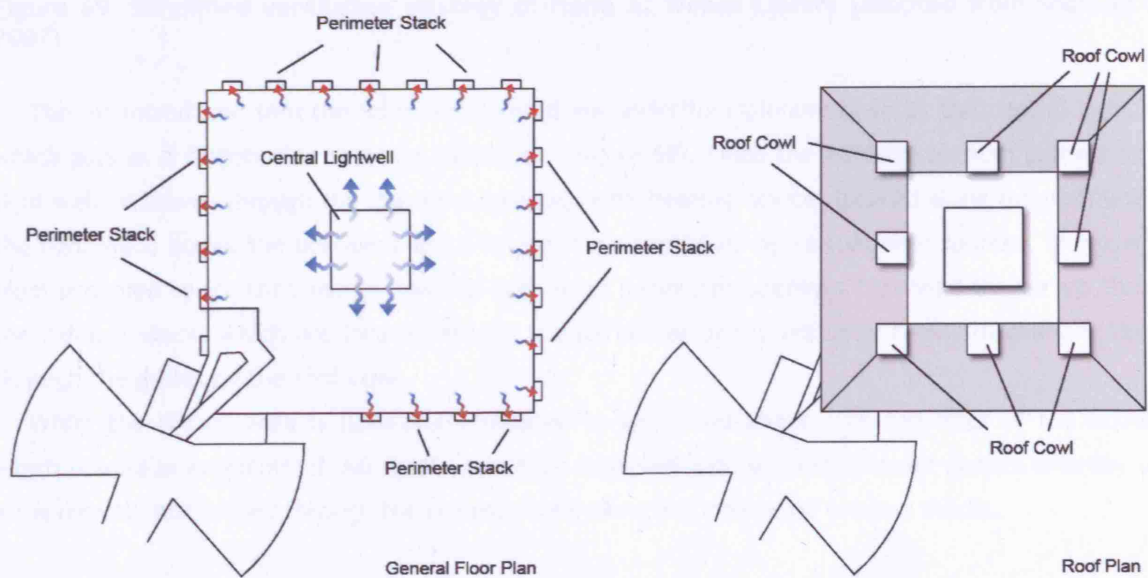

Figure 68: Simplified floor and roof plan illustrating air flow and termination points (adopted from Short et al., 2007)

In order to maintain adequate indoor air quality as well as satisfying thermal comfort, the building utilises buoyancy effect as a main driving force for natural ventilation. In general, cool fresh external air is drawn into the building through the inlets located on the north and south side of the building near the ground level.

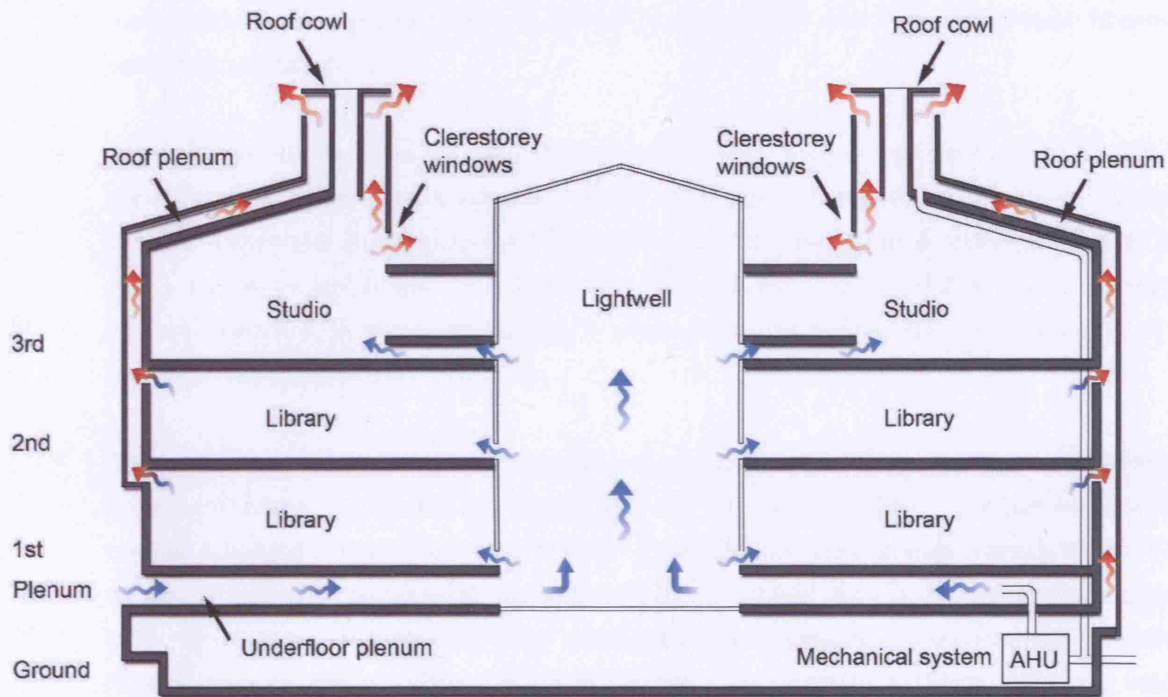

Figure 69: Simplified ventilation strategy of Harm A. Weber Library (adopted from Short et al., 2007)

The air introduced into the inlet is delivered via underfloor plenum towards the central light well which acts as a distribution route of supply air (Figure 69). Once the air from plenum gathers in the light well, it moves through the low level openings with heating device, located along the perimeter of the light well, across the occupied space where it is warmed up by various heat sources. The used air from occupied space then moves towards high level perimeter openings that lead the air up through the exhaust stack, which are located around the perimeter of the building, finally discharging the air through the grilles on the roof cowl.

While the library area is naturally ventilated as explained above, the top floor of the building, which is used as an architectural studio, has been designed with separate extract system whereby used air is directly discharged through the clerestory windows and dedicated exhaust stacks.

10.5 Seasonal operation

The building operates on a mixed-mode switching seasonally from full natural ventilation mode to full mechanical ventilation mode in order to deal with the severe climate of Chicago.

- During mid seasons, spring and autumn, the building operates primarily in natural ventilation mode utilising the cooling effect of thermal mass coupled with night ventilation whenever cooling is necessary.
- During winter, all openings are controlled to minimise air flow through the building via natural ventilation while maintaining adequate indoor air quality for occupants. Moreover, incoming air from the outside is preheated by the heaters placed in the low level inlets and further fine tuned by perimeter heaters located within the occupied space. Furthermore, whenever relative humidity of the incoming air is observed to be inadequate, the incoming air is humidified and supplied mechanically.
- During summer, all perimeter openings are sealed and the building operates in mechanical ventilation mode. The cooled air, supplied by the mechanical system, is accumulated in the central light well and the internal condition of the library is controlled by varying the air flow rate of cool air from the central lightwell to occupied spaces. In order to minimise the cooling load, night cooling ventilation strategy is utilised to the maximum whereby mechanical cooling is used only to top up whenever extra cooling is required to maintain adequate indoor environment.

10.6 Operational performance

As the building was completed only recently the available information on the performance of the building was very limited. However, the acquired information illustrates that the building is expected to consume approximately 43 to 47% less energy per annum (Kaiser et al., ^{Yew}) compared to that of a standard US academic building as shown below in Figure 70. However, it is uncertain to what extent the actual consumption will exceed the estimation, if it does, and remains to be assessed in detail when various information including the energy consumption from BMS becomes available.

Standard US Academic Building Compared to Harm A. Weber Academic Center

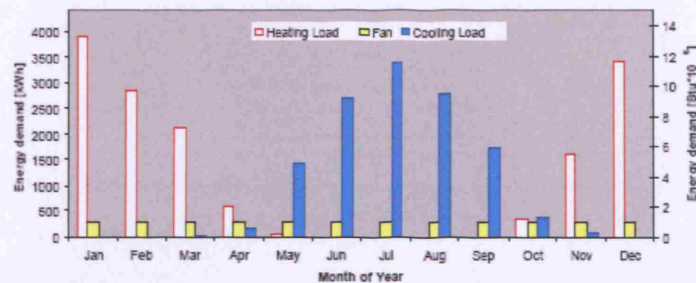

Standard US Academic Building, Monthly Heating, Cooling and Fan Energy Loads

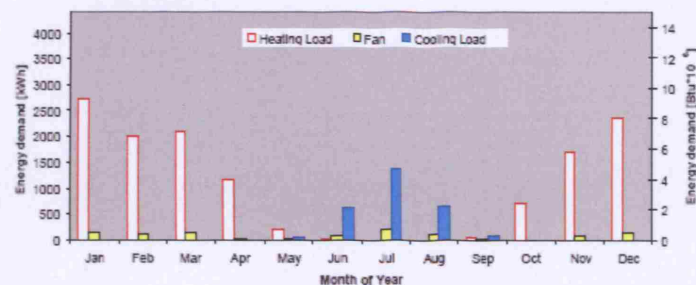

Harm A. Weber Academic Center, Monthly Heating, Cooling and Fan Energy Loads

Source: Short and Associates, Chartered Architects

Figure 70: Comparison of monthly heating, cooling and fan energy loads between Standard US academic building and Harm A. Weber Academic Center (Source: Kaiser et al.) *Year*

10.7 Overview

Due to relatively recent completion date of the building and the location of the building being overseas from the author, there was much limitation in gathering useful data to analyse the design, such as type of sensors and openings, and operational performance in detail. Nevertheless, the collected information suggests that the building is one of the most recently and innovatively designed academic buildings in the US which is expected to consume significantly less energy compared to the standard academic buildings. However, it is uncertain why the designers have implemented a highly carbon intensive air conditioning system instead of providing comfort cooling via sustainable cooling techniques, such as chilled beams or ceiling system, which would further reduce energy consumption as well as CO₂ emission. Although, it is difficult to evaluate the design in relation to the performance due to insufficient information, it should be conducted in the future based on the actual consumption data along with annual temperature profile to assess the effectiveness of its mixed mode operations.

Chapter 11. Discussion and Analysis

11 Discussion and Analysis

Although the five case study buildings, Heelis, NAW, SSEES, Lanchester Library and HAWL, are located in different locations and of different types, the size of the buildings were generally large, ranging from 3,500 to 9,100m², which were built in tight site conditions. The buildings are generally built in a compact form where most of the buildings are deep plan buildings amongst which the highest, SSEES, rises up to 6 stories. Except for the two buildings, Heelis and NAW, the rest were designed with sealed façade and most were observed to have large amount of thermal mass as structural element and some only to certain extent to provide opportunities for night ventilation and attenuate temperature fluctuation.

Table 4: General information of the case study buildings

| Category | Heelis | NAW | SSEES | Lanchester Library | HAWL |
|-----------------|----------------------|------------------------------|-----------------------|------------------------|-----------------------|
| Location | Swindon, UK | Cardiff, UK | London, UK | Coventry, UK | Chicago, USA |
| Building Type | Office | Civic | Academic | Library | Library |
| Floor Area | 4,000m ² | 7,100m ² | 3,500m ² | 9,100m ² | 4,600m ² |
| Foot Print | 100m x 65m | 33m x 55m | 31.5m x 27m | 50m x 50m | 34m x 34m |
| Size | Ground + 1 | Ground + 2 | Basement + Ground + 5 | Basement + Ground + 3 | Basement + Ground + 2 |
| Completion Date | June 2005 | 2005 | December 2005 | September 2000 | April 2007 |
| Plan type | Deep Plan | Deep Plan (Debating Chamber) | Deep Plan | Deep Plan | Deep Plan |
| Façade | Open | Open | Sealed | Sealed | Sealed |
| Thermal Mass | Ceiling, First Floor | Floor | Wall, Floor, Ceiling | Exposed concrete slabs | Wall, Floor, Ceiling |

- **Innovative design elements**

The five buildings studies are all predominantly naturally ventilated buildings that utilise stack ventilation as main driving force. With aid of computer simulation tools, the designers have explored

the benefits of stack ventilation to a large extent from which innovative design elements were introduced to overcome the limitations, such as lack of ability to deal with noise and security, which were faced by existing naturally ventilated buildings in urban environments.

Amongst the buildings, four buildings were found to implement under floor plenum to the design where fresh air was drawn from the perimeter of the building through the shallow plenum under the ground floor that was connected to a central space to be distributed to occupied space. In the SSEES, Lanchester Library and Harm A. Weber Library, designers have solved the security issue associated with valuables in libraries, a typical problem of naturally ventilated buildings which use perimeter opening for night ventilation, through employment of underfloor plenum to disconnect the direct connection between outside and occupied spaces, and specifying security grills at the air intakes to the plenum. Moreover, by redirecting the supply route of fresh air with use of underfloor plenum and lightwell, the façade of these buildings were able to be sealed whereby noise sensitive library spaces were protected from direct transmission of noise either from traffic or surroundings while noise introduced through the plenum were attenuated considerably before entering occupied spaces. However, it should be noted that by sealing the façade, the opportunity for adaptive approach is lost and the implications of sealed façade should be investigated on whether the benefits are sufficient to trade off for loss of adaptive approach regarding occupant's perception of their thermal comfort. Moreover, similar approach was found at the National Assembly for Wales building in which fresh air to the noise sensitive debating chamber was supplied via underfloor space, either via duct or open space, preventing noise penetration as well as security issue.

In comparison to the previously or concurrently designed buildings that were situated in spacious sites to employ large atriums and courtyards to reduce the effective depth of floor plan, as in the cases of Barclaycard headquarters and Inland Revenue headquarters, the case study buildings showed extensive and innovative use of multiple numbers of small vertical spaces, dedicated to natural ventilation, in the form of lightwells and exhaust stacks, to effectively ventilate the deep plan areas without compromising floor area to a large extent. In Heelis building, approximately 42 roof vents called "snouts" were widely spread across the roof to induce stack effect in all areas. The distinctive design elements that was found amongst the SSEES, Lanchester Library and Harm A. Weber Library, were lightwells, an inaccessible and sealed vertical void space rising from ground to top floor, which were used as either supply or exhaust route of fresh air. The number of lightwells varied from single to multiple numbers depending on the depth of the floors where supply and exhaust points were evenly or symmetrically allocated across the floor plan depending on the depth. In addition to the lightwell, vast numbers of exhaust stacks that extend high above the roof line were found around perimeter of buildings serving different parts of these buildings. In the case of SSEES, allocation of perimeter stacks were found to induce enough pressure difference to enable stack ventilation to ventilate cellular spaces which are generally ventilated using single sided ventilation.

An interesting element found at NAW was the combination of wind cowl and funnel which induces air movement through utilisation of both wind and buoyancy effect. By coupling the two elements, stratification caused by internal gain induces stack ventilation up the funnel towards the roof where negative pressure zone created at the exhaust point due to rotating wind cowl supplements discharging the used air which is likely to reduce the possibility of back flow of used air which is a sensitive issue in stack ventilated buildings.

- **Simulation tools and their role**

Extensive use of simulation tools, both mathematical and physical, is another aspect that was observed in the design process of the buildings aimed to pre-assess the performance of the proposed natural ventilation strategy and to optimise its performance through iteration.

Table 5: Simulation tools involved in the design process

| Category | Heelis | NAW | SSEES | Lanchester Library | Harm A. Weber Library |
|-------------------|--------|-------------|------------------------|--------------------|------------------------|
| Thermal Modelling | TAS | Unknown | ESP-r | ESP-r | ESP-r |
| Airflow Analysis | - | Wind Tunnel | CFD + Water Bath Model | CFD | CFD + Water Bath Model |

Thermal dynamic simulation tools, such as TAS and ESP-r, were observed to be used from an early stage of design process for the assessment of necessity for employing mechanical system into the building, which is perhaps the most important issue in sustainable buildings. In the design process of SSEES, the necessity of employing draught cooling was assessed by comparing the annual temperature profile from two different simulations, with and without draught cooling, where the results indicated possibility of overheating during summer without cooling measures. In addition, numerous simulations were conducted to: optimise the size of openings; verify the cooling potential of thermal mass and night ventilation strategy; test various operation modes; and optimise the control settings of the BMS system, for example the temperature limits for night ventilation, based on the internal temperatures and ventilation rates. Moreover, although the thermal dynamic simulation tools enable analysis of air flow to certain extent, additional tools such as CFD, wind tunnel and water bath models, were utilised to study the air movement in depth to test the viability of the proposed ventilation strategy and prevent any unintended air movement. In SSEES, Lanchester Library and Harm A. Weber Library, these simulations had lead to identifying possibility of back flow of stale air from lower floors from entering the higher floors when they share a same stack. As a result, the designers

had developed the design of stacks by partitioning them to isolate the vulnerable floors from the shared stack, hence eliminating the possibility of back flow.

- **Natural ventilation and mixed-mode**

The five case study buildings, Heelis, NAW, SSEES, Lanchester Library and HAWL, which were subject to analysis in this paper were mostly located in the temperate climate region, in which temperature rarely falls below -5°C during winter and rises over 25°C during summer, except for HAWL which is located in more harsh weather conditions of Chicago, in which ambient temperature frequently fell below -10°C during winter and exceeded 28°C during summer. To deal with these local climates, buildings were found to operate either solely on natural ventilation or on mixed-mode. Out of five buildings, four, the Heelis, NAW, SSEES and HAWL, were found to operate on mixed-mode either during winter or summer where mechanical cooling or heat recovery system was used to maintain adequate indoor condition. The main reasons for selecting mixed-mode were the limited cooling potential of the natural ventilation and night ventilation strategy in an urban environment and possibility of substantial heat loss via natural ventilation during winter. Although, pure natural ventilations can reduce energy consumption and the associated CO_2 emission considerably, the fact that even the case study buildings located in the UK, exposed to mild summer, requires mechanical cooling to certain extent and under the context of continuous increase in global temperature, it is likely that mixed-mode system will become essential in non-domestic buildings in urban environment. Therefore, there is a strong necessity to focus on improving and developing an efficient and sustainable mixed-mode system.

Table 6: Ventilation characteristics of each building and their control methods

| Category | Heelis | NAW | SSEES | Lanchester Library | HAWL |
|----------------|-----------------------------|----------------------------|---|---------------------|----------------------------|
| Site | Sub urban | Sub urban | Urban | Sub urban | Sub urban |
| Climate Region | Temperate | Temperate | Temperate (Urban Heat Island) | Temperate | Temperate |
| Ventilation | Mixed-Mode | Mixed-Mode | Mixed-Mode | Natural Ventilation | Mixed-Mode |
| Cooling Method | Natural + Night Ventilation | Natural Ventilation + HVAC | Natural Ventilation + Passive Draught Cooling | Natural Ventilation | Natural Ventilation + HVAC |

● Taxonomy: Advanced Natural Ventilation Systems

The taxonomy proposed by Dr. Kevin Lomas, addressed as part of chapter 5.3, largely categorises stack ventilation systems into four categories (Lomas, 2007): Centre in - Edge Out (C-E); Centre in - Centre out (C-C); Edge in Edge out (E-E); and Edge in Centre out (E-C). As shown in Table 4, the ANV type of SSEES, Lanchester Library and HAWL were previously categorised in the case studies conducted elsewhere (Lomas, 2007) while it was applied to Heelis and NAW based on ones judgement.

In regards to the previously defined ANV types of the buildings mentioned above, there was awkwardness in describing the ANV type of Lanchester Library as Centre in Edge out (C-E) and Centre in Centre out (C-C) where the point of introduction of fresh air is actually located along the perimeter to draw air into the underfloor plenum which would be more clear if categorised as 'Edge in' instead of 'Centre in'. Although the intension may have been to illustrate that the air delivered to the occupied space is introduced from the central lightwell, therefore defining the system as Centre in, and that the noise penetration is reduced due to this, the physical location of the intake in relation to the source of noise and pollutants is at the edge of the building. Moreover, it is believed that 'Centre in' method should be applied to the cases only when the air is actually introduced from centre as demonstrated in two cases: fresh air supplied from centre via courtyard in Heelis; and fresh air introduced via central lightwell with aid of passive down draught cooling. Therefore, a proposition is made to reinforce the taxonomy to express the complexity of a ventilation route for buildings such as HAWL more clearly by using three letters, for example E-C-E, where the first letter "E" is used to describe the point of introduction, the middle letter "C" to illustrate the distribution route, and the last letter "E" to describe the point of termination.

Table 7: Buildings categorised into advanced natural ventilation types according to taxonomy proposed by Dr. Kevin Lomas (Lomas, 2007)

| Category | Heelis | NAW | SSEES | Lanchester Library | HAWL |
|----------|----------|------------------------|-------|--------------------|----------|
| ANV Type | E-C, C-C | E-C (debating chamber) | C-E | C-E, C-C | C-E, E-E |

● Operational Performance

In general, the analysis of operational performance of case study buildings was conducted based on insufficient information due to limitations faced in the research process where internal temperature profiles were found to be maintained at an adequate level throughout the year.

In terms of energy consumption, the target energy consumptions estimated during the design stage were found to be close to the good practice benchmark consumption figures (DETR, 2000) of naturally ventilated buildings, ranging from as little as 75 kWh/m² to approximately 150 kWh/m², proposing significant potential for saving energy and the associated CO₂ emission as well as operational cost. However, the two consumption figures from SSEES and Lanchester Library were found to be significantly higher than the estimated consumption which is comparable to the type 3 good practice air-conditioned building (Figure 71). However, this is subject to further study in detail to analyse the consumption data and identify the source of surplus consumption on whether it is due to the inadequate design of the natural ventilation system, by looking into the gas consumption associated with heating and electricity consumption associated with fans, pumps and control, or a result of poor management of the system.

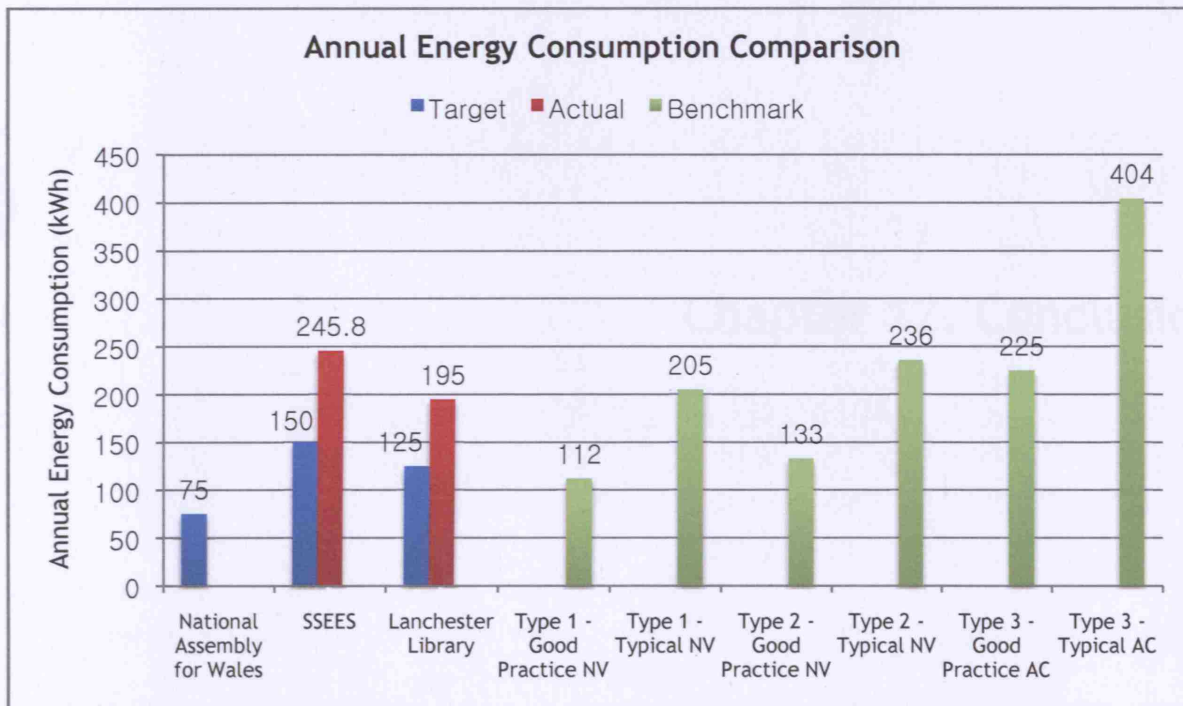

Figure 71: Energy consumption comparison between buildings and benchmarks

Nevertheless, there seems to be a tendency that the actual consumption figures frequently exceed target consumption estimated during the design stage which reduces the credibility of the estimated energy consumption and the certifications such as BREEAM rating (BRE) that are awarded based on such estimation. Therefore, this raises a strong necessity to draw focus towards the post construction performance of buildings, for example by conducting post occupancy evaluation or enforcing the Energy Certificate Scheme as a mandatory requirement for completed buildings to promote buildings that not only has good design but also performs as well as the design.

Chapter 12. Conclusion

12 Conclusion

The recent surge of interest in advanced natural ventilation and the introduction of numerous innovatively designed non-domestic buildings have proposed potential to confront the implications of global warming and the rising fuel price. In this dissertation, the design of advanced naturally ventilated buildings - Heelis, National Assembly for Wales, School of Slavonic and East European Studies, Lanchester Library and Harm A. Weber Library - and their operational performance has been analysed in order to present detailed information on the recently introduced concept of advanced natural ventilation system through a theoretical study and case study of a number of exemplar cases as well as evaluate the effectiveness of these innovative systems in offsetting the energy consumption from air-conditioning.

Following the theoretical chapters in which theories behind basic natural ventilation strategies and the design process of naturally ventilated buildings were studied in detail to form a basis for understanding the complexity of advanced natural ventilation systems, the design and operational performance of each building was analysed in detail in the case study chapters. The subchapters weather analysis and building context has analysed the environment in which the building is exposed to and identified site specific constraints such as noise from adjacent highway. The subchapters building form and ventilation components and control revealed how the buildings were designed, both externally and internally, identifying components of a natural ventilation system such as thermal mass, openings and control system. The ventilation strategy and seasonal operation chapters analysed how the building is naturally ventilated and operated during different seasons through which clear and detailed understanding on how the buildings were ventilated was acquired. In the operational performance chapter, the performance of each building was assessed based on the temperature profile and annual energy consumption. Lastly, limitations faced during the case study were elaborated in the overview part as well as critical analysis of the design and operational performance of each building.

Based on the analysis from case studies, an overview of all buildings was conducted in the discussion and analysis chapter from which key findings listed below were found:

- A number of innovative design elements were found to enhance the effectiveness of natural ventilation and enable these buildings to overcome the limitations faced by typical naturally ventilated buildings in an urban environment. An underfloor plenum located between the ground and basement floor used as a supply route of fresh air enabled the façades to be sealed against noise and reduce security issues. Extensive use of vertical spaces such as lightwells and exhaust stacks used as either a distribution or extract route in combination with exhaust stacks allowing natural ventilation to serve deep plan buildings. Combination of a vertical space with wind cowl which proposed potential for minimising or preventing back flow in stack ventilated buildings.

- Extensive use of simulation tools, dynamic thermal simulation tool and computational fluid dynamics (CFL), was found to thoroughly check the validity of the proposed design and operational strategies as well as explore the design in significant depth that lead to design of innovative design elements.
- Importance and necessity of mixed-mode system was highlighted where most buildings were provided with allowance for mechanical system operating in mixed-mode to either minimise heat loss during winter with aid of heat exchange system or provide cooling during summer even when most buildings were located in a temperate climate of UK with mild summer.
- A proposal has been made to expand the taxonomy for ANV type proposed by Dr. Kevin Lomas whereby the current taxonomy was deemed inadequate to clearly express the complexity of some ANV systems. The proposal is to categorise the ANV types with three letters, for example E-C-E, instead of two, E-C, to clearly express the complexity of an ANV system where the first letter would indicate the point of introduction, the second the air distribution route and the last letter the point of termination.
- A significant difference between the estimated or estimated energy consumption and the post occupancy consumption in few buildings with the data was found. This suggested that there is a tendency that post occupancy consumption is generally higher than the estimated consumption figures which require close attention to identify the source of this difference.

To summarise, the findings from the dissertation suggest that the design aspect of naturally ventilated buildings have developed immensely over the years where the innovative design elements that improve the effectiveness of stack ventilation and the extent to which the simulation tools are utilised significantly pushed the boundaries of applicability of naturally ventilated buildings in urban environments with aid of appropriate implementation of mixed-mode as supplementary system. However, while the buildings were observed to be maintaining adequate thermal environment for occupants, the significant difference between the expected or published energy consumption and the post occupancy energy consumption highlighted the weak association between the design phase and the post construction occupancy phase whereby post occupancy evaluation was found conducted in only one building. In comparison to the degree of interest in sustainable buildings during the design phase until the completion, clearly illustrated by numerous publications that state how these buildings are expected to consume less energy, the degree of commitment in properly managing the system and reducing the energy consumption after occupancy seems minimal where some facilities managers were found unfamiliar with the natural ventilation system of a building. Moreover, during the research phase

of the study, it was observed that many so called 'sustainable' buildings were focussed in publishing only the expected performance but persistent to reveal the post occupancy energy consumption possibly due to possibility of degrading the value of the building. Therefore, there is a strong necessity to raise awareness on the assessment of energy consumption by making commitment to analyse the consumption after completion and take necessary measures to operate the building appropriately.

12.1 Limitations

Although there was a constant effort to acquire detailed information on operational performance of each building, data recorded by BMS such as temperature profile and annual energy consumption, to analyse the implications of proposed systems in regards to energy and CO₂ emission as well as operational cost against air conditioned buildings, the limitations associated in the process has lead to insufficient set of data that vary between each building. Consequently, to a disappointment, a comparison of post occupancy energy consumption and the thermal comfort level to that expected in the design process, which were believed to be significant to verify whether the innovatively designed case study buildings are well designed and operated as well as learn any lessons that may have arisen from the analysis, could not be conducted in depth as hoped.

12.2 Further work

Presented below are several works which couldn't be conducted in the dissertation and some ideas which are presented for further work:

- Conduct thorough analysis of energy consumption based on data collected from BMS to assess the energy consumption for fans, cooling and heating to verify the extent to which maximising natural ventilation can reduce energy consumption and associated CO₂ emission compared to that of HVAC system.
- Thorough analysis of annual temperature profile and conduct occupant satisfaction survey to identify whether proposed design strategy is adequate to provide thermally comfortable environment to occupants.
- Conduct investigation on the cost implication design elements of advanced naturally ventilated buildings and compare the results with similar size and type buildings that employ full HVAC system to verify the degree of financial benefit of natural ventilation in regards to initial cost.

Chapter 13. Bibliography

13 Bibliography

Bode, K., Winter, M. (2007) Passive and active systems in harmony, *Refocus*, Volume 8, Issue 6, November-December, Pages 44-49

Bordass, W., Cohen, R., Standeven, M., Leaman, A. (2001) Assessing building performance in use 3: Energy performance of the Probe buildings, *Building Research and Information* 29 (2), pp. 114-128

Bunn, R. (2007) Trust in Construction, *Delta T*, March, pp. 10-13

CIBSE (2000) CIBSE Application Manual 13: Mixed Mode Ventilation, Chartered Institution of Building Services Engineers, London

CIBSE (2001) CIBSE Guide J: Weather, Solar and Illuminance Data, Chartered Institution of Building Services Engineers, London

CIBSE (2005a) CIBSE Application Manual 10: Natural Ventilation in Non-domestic Buildings, Chartered Institution of Building Services Engineers, London

CIBSE (2005b) CIBSE Guide B: Heating Ventilating Air Conditioning and Refrigeration, The Chartered Institution of Building Services Engineers, London

CIBSE (2005c) CIBSE Technical Memorandum 36: Climate change and the indoor environment: impacts and adaptation, Chartered Institution of Building Services Engineers, London

CIBSE (2006) CIBSE Guide A: Environmental Design, The Chartered Institution of Building Services Engineers, London

Cinqualbre, O. (2007) Richard Rogers + Architects, Editions Du Centre Pompidou, Paris

Correnza, J., Hyde, G., Kerr, G., Lake, R. Newman-Sanders, E., Skuse, M. (2006) The National Assembly for Wales, *The Arup Journal*, 2/2006, pp. 3-14

Hacker, J. (2007) Climate as a driver of change Part 1: Global warming - the evidence and the causes, *Arup Journal*, 42(1), pp. 38-51

- Krause, B., Cook, M., Lomas, K. (2007) Environmental performance of a naturally ventilated city centre library, *Building Research and Information*, 39, pp. 792-801
- Lomas, K., Cook, M., Fiala, D. (2006) Low energy architecture for a severe US climate: Design and evaluation of a hybrid ventilation strategy, *Energy and Buildings* 39, pp. 32-44
- Lomas, K. (2007) Architectural design of an advanced naturally ventilated building form, *Energy and Buildings* 39, pp. 166-181
- Nasa'a R. (2007) Post Occupancy Review of Comfort Conditions at Heelis, Central Office Building for the National Trust, unpublished MSc, The Bartlett School of Graduate Studies, University College London.
- NAW, 2006, Sustainability, Information booklet, National Assembly for Wales, ASP/003/1/05-06
- Ortiz, J. Pout, C. Perez-Lombard, L. (2006) Go Figure, *Buildings Services Journal*, pp. 38-40
- Randall, T. (2006) Environmental Design, Chapter 18: Heelis, Central Office for the National Trust, Taylor and Francis, Oxon
- Roberts, S. (2006) Energy as a driver of change, *Arup Journal*, 41(2), pp22-28
- Short, C., Lomas, K., and Woods, A. (2004) Design strategy for low-energy ventilation and cooling within an urban heat island, *Building Research and Information*, 32:3, pp. 187-206
- Short, A., Lomas, K. (2007) Exploiting a hybrid environmental design strategy in a US continental climate, *Building Research & Information*, 35:2, pp. 119 – 143
- Wargocki, P., Sundell, J., Bischof, W., Brundrett, G., Fanger, P. O., Gyntelberg, F., Hanssen, S. O., Harisson, P., Pickering, A., Seppanen, O., Wouters, P., (2002), Ventilation and health in non-industrial indoor environments: report from a European Multidisciplinary Scientific Consensus Meeting (EUROVEN), *Indoor Air* 12, pp 113-128

- **Internet resources**

Cook, M., Lomas, K., Rees, S., Design Concept for an Innovative Naturally Ventilated Library, Available from: <<http://www.iesd.dmu.ac.uk/posters/simon.pdf>> [Accessed July 2008]

DETR (2000) Energy use in offices, Energy Consumption Guide 19, Building Research Energy Conservation Support Unit, Energy Efficiency Best Practice Programme, Available from: <<http://www.cibse.org/pdfs/ECG019.pdf>> [Accessed May 2008]

EIA (2007), International Energy Outlook 2007, Available from: <[http://www.eia.doe.gov/oiaf/ieo/pdf/0484\(2007\).pdf](http://www.eia.doe.gov/oiaf/ieo/pdf/0484(2007).pdf)> [Accessed May 2008]

Kaiser, K., Ogoli, D. The Harm A. Weber Academic Centre and the Greening of Judson University, Available from: <http://www.judsonu.edu/uploadedFiles/Judson_Public/Support_Judson/New_Academic_Center/HAWAC.pdf> [Accessed May 2008]

Lomas, K., Cook, M., Fiala, M. (2008a) Passive Draught Cooling for Non-Domestic Buildings, Available from: <<http://www.iesd.dmu.ac.uk/posters/kevin2.pdf>> [Accessed July 2008]

Lomas, K., Cook, M., Fiala, M. (2008b) Low Energy Architecture in a Severe Climate, Available from: <<http://www.iesd.dmu.ac.uk/posters/kevin3.pdf>> [Accessed July 2008]

Max Fordham, National Trust HQ reviewed, Full energy and post-occupation data, Available from: <http://www.building.co.uk/Journals/Builder_Group/Building/2007_Issue_37/attachments/HeelistData.pdf> [Accessed May 2008]

RSHP, Rogers Stirk Harbour + Partners, Drawings & Models, Available from: <http://www.richardrogers.co.uk/Asp/uploadedFiles/Image/News/RRP_4000_Drawings_P_060322.pdf> [Accessed July 2008]

SE Controls, Case Study The National Trust Central Office, Available from: <http://www.secontrols.co.uk/images/uploads/1646_national_trust_6pp_case_study.pdf> [Accessed May 2008]

Woods, A., Fitzgerald, S. (2005) Experimental and Theoretical Modelling of Natural Ventilation in Judson College, Elgin, Illinois, Available from: http://www.judsonu.edu/uploadedFiles/_Judson_Public/Academics/Undergraduate/Art_Design_and_Architecture/Experimental%20and%20Theoretical%20Modeling%20by%20BPI.pdf [Accessed June 2008]

- **Websites**

BDSP, BDSP [Online], Available from: <<http://www.bdsp.com/index2.html>> [Accessed June 2008]

BRE, BREEAM: BRE Environmental Assessment Method [Online], Available from: <<http://www.breeam.org/index.jsp>> [Accessed July 2008]

Google, Google Maps [Online], Available from: <<http://maps.google.co.uk/maphp?sourceid=navclient&ie=UTF-8>> [Accessed June 2008]

IESD, Institute of Energy and Sustainable Development [Online], Available from: <<http://www.iesd.dmu.ac.uk>> [Accessed June 2008]

Met Office, Met Office: World Climate Averages [Online], Available from: <<http://www.metoffice.gov.uk/education/data/climate/index.html>> [Accessed June 2008]

RSHP, Rogers Stirk Harbour + Partners , Design [Online], Available from: < http://www.richardrogers.co.uk/work/buildings/national_assembly_for_wales/design> [Accessed May 2008]

Short and Associates, Short and Associates: Projects [Online], Available from: < <http://www.shortandassociates.co.uk/projects.asp>> [Accessed May 2008]

SMC, Shales Mcnutt Construction, Judson Univeristy - Harm A. Weber Academic Center [Online], Available from: <<http://www.shalesmcnutt.com/projects/education/judson-harm-weber.php>> [Accessed June 2008]

Square One, | The Weather Tool | Ecotect [Online], Available from: <<http://squ1.com/products/weathertool>> [Accessed February 2008]