

Aus dem Institut für Laboratoriumsmedizin  
der Ludwig-Maximilians-Universität München

Vorstand: Univ. Prof. Dr. med. Daniel Teupser

**Untersuchungen zur Anwendung der Flüssigkeitschromatographie-Tandem-  
Massenspektrometrie in der medizinischen Laboratoriumsdiagnostik**

Dissertation

zum Erwerb des Doktorgrades der Humanbiologie

an der Medizinischen Fakultät der

Ludwig-Maximilians-Universität zu München

vorgelegt von

Fabian Kirchhoff

aus

Dachau

2013

Mit Genehmigung der Medizinischen Fakultät der Universität München

Berichterstatter: Prof. Dr. med. Michael Vogeser

Mitberichterstatter: Priv. Doz. Dr. Stefan Lichtenthaler  
Prof. Dr. Bernhard Olgemöller  
Prof. Dr. Wolfgang Keil

Dekan: Prof. Dr. med. Dr. h.c. M. Reiser, FACR, FRCR

Tag der mündlichen Prüfung: 17.12.2012

## **Kumulative Dissertation**

# Inhaltsverzeichnis

<b>1. Einleitung</b> .....	<b>1</b>
1.1 Tandem-Massenspektrometrie in der Klinischen Chemie.....	1
1.2 Einzelne Publikationen.....	5
1.2.1 Kirchhoff F, Lorenzl S, Vogeser M. An on-line solid phase extraction procedure for the routine quantification of urinary methylmalonic acid by liquid chromatography-tandem mass spectrometry. Clin Chem Lab Med 2010;48:1647-50.....	5
1.2.2 Kirchhoff F, Briegel J, Vogeser M. Quantification of free serum cortisol based on equilibrium dialysis and isotope dilution-liquid chromatography-tandem mass spectrometry. Clin Biochem 2011;44:894-9. ....	6
1.2.3. Kirchhoff F, Maier B, Rieger C, Ostermann H, Spöhrer U, Vogeser M. An on-line solid Phase extraction procedure for the routine quantification of caspofungin by liquid chromatography-tandem mass spectrometry. Clin Chem Lab Med 2012;50:521-4. ....	7
1.2.4 Vogeser M, Kirchhoff F. Progress in automation of LC-MS in laboratory medicine. Clin Biochem 2011;44:4-13. ....	7
1.3 Zusammenfassung/ Summary .....	8
<b>2. Originalpublikationen</b> .....	<b>9</b>
2.1 Kirchhoff F, Lorenzl S, Vogeser M. An on-line solid phase extraction procedure for the routine quantification of urinary methylmalonic acid by liquid chromatography-tandem mass spectrometry. Clin Chem Lab Med 2010;48:1647-50.....	9
2.2 Kirchhoff F, Briegel J, Vogeser M. Quantification of free serum cortisol based on equilibrium dialysis and isotope dilution-liquid chromatography-tandem mass spectrometry. Clin Biochem 2011;44:894-9 .....	14
2.3 Kirchhoff F, Maier B, Rieger C, Ostermann H, Spöhrer U, Vogeser M. An on-line solid Phase extraction procedure for the routine quantification of caspofungin by liquid chromatography-tandem mass spectrometry. Clin Chem Lab Med 2012;50:521-4. ....	21
2.4 Vogeser M, Kirchhoff F. Progress in automation of LC-MS in laboratory medicine. Clin Biochem 2011;44:4-13 .....	26

# 1. Einleitung

## 1.1 Tandem-Massenspektrometrie in der Klinischen Chemie

Im methodisch-analytischen Spektrum der medizinischen Labordiagnostik besitzt die Quantifizierung von Marker-Substanzen in diagnostisch zugänglichen Untersuchungsmaterialien eine Schlüsselrolle; dies betrifft sowohl endogen vorkommende Substanzen wie auch Xenobiotica. Die gegenwärtig in der Routinediagnostik dominierenden Basis-Technologien sind die Photometrie und Liganden-Bindungsassays wie vor allem die Immunoassays. Die Einführung dieser Technologien in den 1960er bis 1980er-Jahren hat die medizinische Diagnostik revolutioniert, so dass Laboranalysen inzwischen für einen Großteil ärztlicher Entscheidungen von wesentlicher Bedeutung sind. Sowohl Photometrie- wie auch Immunoassay-basierte Analyseverfahren konnten mittlerweile komplett automatisiert werden, was zu einem sehr hohen Niveau an Effizienz und Zuverlässigkeit dieser klinisch-chemischen Basis-Technologien geführt hat. Gleichwohl weisen diese Analysensysteme wesentliche Limitierungen auf; dies betrifft die Analyt-Spezifität der Tests (z.B. kompetitive Immunoassays kleiner Moleküle wie Steroide), die Nachweisstärke (v.a. bei photometrischen Tests) und das realisierbare Analytspektrum.

Über die erwähnten Technologien der Routineanalytik hinaus verfügt die Klinische Chemie seit den 1980er Jahren über metrologisch höherrangige Referenzmethoden auf Basis der Gaschromatographie-Massenspektrometrie (GC-MS). Resultate dieser Technologie können – im Gegensatz zu Photometrie und Ligandenbindungs-Assays direkt auf die molekulare Struktur der Zielanalyten zurückgeführt werden, was einen sehr hohen Grad an analytischer Spezifität eröffnet. GC-MS-Methoden sind seit vielen Jahren von zentraler Bedeutung für die Standardisierung klinisch-chemischer Analysen, da z.B. Kalibrations- und Qualitätskontroll-Materialien sowie Ringversuchsproben hierdurch konsistent spezifiziert werden können. Darüber hinaus hat sich die GC-MS zu einer Schlüsseltechnik in der Toxikologie entwickelt, da sie die Identifikation von sehr vielen, auch primär nicht erwarteten Substanzen in diagnostischen Proben anhand von Spektren-Bibliotheken erlaubt („unknown screening“); ebenso sind umfangreiche Multi-Analyt-Quantifizierungen realisierbar. Höchste analytische Zuverlässigkeit kann durch die Verwendung von stabilisotopen-markierten internen Standards erreicht werden (Isotopenverdünnungs-Technik). Da das Handling der GC-MS außerordentlich anspruchsvoll und personalintensiv ist, konnte sich diese Technologie außerhalb von wenigen Speziallabors in der labormedizinischen Routineanalytik

allerdings nicht durchsetzen.

Ende der 1990er Jahre fand mit der Flüssigkeitschromatographie-Tandem-Massenspektrometrie (syn. LC-MS/MS) eine weitere, innovative massenspektrometrische Technologie Einzug in die medizinische Analytik<sup>1,2</sup>. Diese Technologie teilt wichtige Potentiale mit der GC-MS (v.a. hohe Analyt-Spezifität, Anwendbarkeit der Isotopenverdünnungs-Technik, Multianalyt-Quantifizierung etc.), weist aber darüber hinaus wesentliche praktische Vorteile auf:

- Im Gegensatz zur GC-MS erfordert die LC-MS/MS im Allgemeinen keine chemische Derivatisierung der Zielanalyten.
- Da die Ionisation außerhalb des Hochvakuumbereichs erfolgt, ist die LC-MS/MS-Technologie weitaus robuster.
- Durch die Tandem-Anordnung zweier Massenselektoren (Quadrupole) mit zwischengeschalteter Kollisionszelle ist es möglich, die Analyt-Detektion auf das spezifische Fragmentationsverhalten zurückzuführen. Durch die hohe Spezifität dieses Detektionsprinzips kann die chromatographische Vor-Fraktionierung der Proben minimiert werden. Dadurch werden Multi-Analyt-Quantifizierungen mit sehr kurzen analytischen Laufzeiten möglich (z.B. Laufzeiten unter 3 min, gegenüber typischerweise 20 min bei der GC-MS).
- Während die Anwendung der GC-MS auf thermostabile Analyte unterhalb eines Molekulargewichts von ca. 600 begrenzt ist, kann die LC-MS/MS alle biologisch relevanten Stoffklassen adressieren.

Die genannten Eigenschaften stellen für die gesamte Bioanalytik eine geradezu revolutionäre Novität dar. Bezüglich der Labormedizin eröffnet die LC-MS/MS die Perspektive, hoch-spezifische massenspektrometrische Verfahren nicht mehr nur in wenigen Speziallabors, sondern auch in Routinelabors einzusetzen. Um dieses Ziel, das zahlreiche konkrete Optionen für die Verbesserung der Patientenversorgung eröffnen kann, zu realisieren ist jedoch noch eine weitere Verbesserung der Anwenderfreundlichkeit gegenüber dem gegenwärtigen Stand erforderlich. Dies betrifft insbesondere die Probenvorbereitung. Da medizinisch-biologische Proben, wie Serum oder

---

<sup>1</sup> Maurer HH. Current role of liquid chromatography-mass spectrometry in clinical and forensic toxicology. *Anal Bioanal Chem* 2007;388:1315–25.

<sup>2</sup> Vogeser M, Seger C. A decade of HPLC-MS/MS in the routine clinical laboratory--goals for further developments. *Clin Biochem* 2008;41:649-62.

Urin eine extrem komplexe und stoffreiche Matrix darstellen, ist trotz der hohen analytischen Selektivität der Tandemmassenspektrometrie (MS/MS) -Technologie eine Vorfraktionierung der Probe erforderlich. Dabei gilt es insbesondere, Stoffe abzureichern, die die Ionisation der Zielanalyte beeinträchtigen. In der Analytik kleiner Moleküle betrifft dies vor allem Salze, Peptide und Proteine, sowie Phospholipide. Neben der Flüssigphasen-Extraktion mit organischen Lösungsmitteln wird hierfür häufig die Festphasenextraktion verwendet. Im klassischen Ansatz werden Extraktionskartuschen zur einmaligen Anwendung benutzt. Diese Verfahren sind materialaufwendig und bedingen eine hohe Personalbindung. Die Verwendung von permanent genutzten Extraktionssäulen hingegen ermöglicht eine weitgehende Automation der Festphasen-Extraktion. Nach einer meist vorgeschalteten Proteinfällung wird über eine zweite HPLC-Pumpe sowie ein Hochdruckschaltventil ein Flußsystem realisiert, das die extraktiven Schritte Adsorption, Waschen und Elution in einem geschlossenen Flußschema realisiert (siehe Abbildung mit Legende). Da diese sogenannte on-line solid phase extraction (SPE) die Probenvorbereitung von LC-MS/MS-Analysen gegenüber Standardmethoden drastisch vereinfacht, ist sie für die Routineanwendung der LC-MS/MS von besonderem Interesse.

Die Technologie der on-line SPE verbessert nicht nur die Praktikabilität und Großserientauglichkeit der LC-MS/MS im klinischen Labor sondern kann auch die analytische Qualität optimieren: Eine weitgehende Reduktion von Begleitsubstanzen durch eine effiziente Extraktion führt im allgemeinen zu stabilen Ionisationsverhältnissen. Störungen der Ionisation (sogenannte ion-suppression) können die Richtigkeit von massenspektrometrischen Analysen beeinträchtigen sobald die Ionisation von Zielanalyt und Internem Standard differentiell beeinflusst werden.

Die übergreifende Aufgabe des Promotionsprojektes bestand in der Entwicklung und Validierung neuer LC-MS/MS-Methoden für die klinisch-chemische Routinediagnostik. Hierbei wurde insbesondere der Aspekt der Probenvorbereitung adressiert, da dieser die Zuverlässigkeit und Praktikabilität der Verfahren ganz wesentlich determiniert.

**Abbildung:** Prinzip der on-line SPE (integriert in LC-MS/MS-Technologie), exemplarisch dargestellt an beschriebenen Methoden; aus Vogeser M, Kirchhoff F. Progress in automation of LC-MS in laboratory medicine. Clin Biochem 2011;44:4-13.

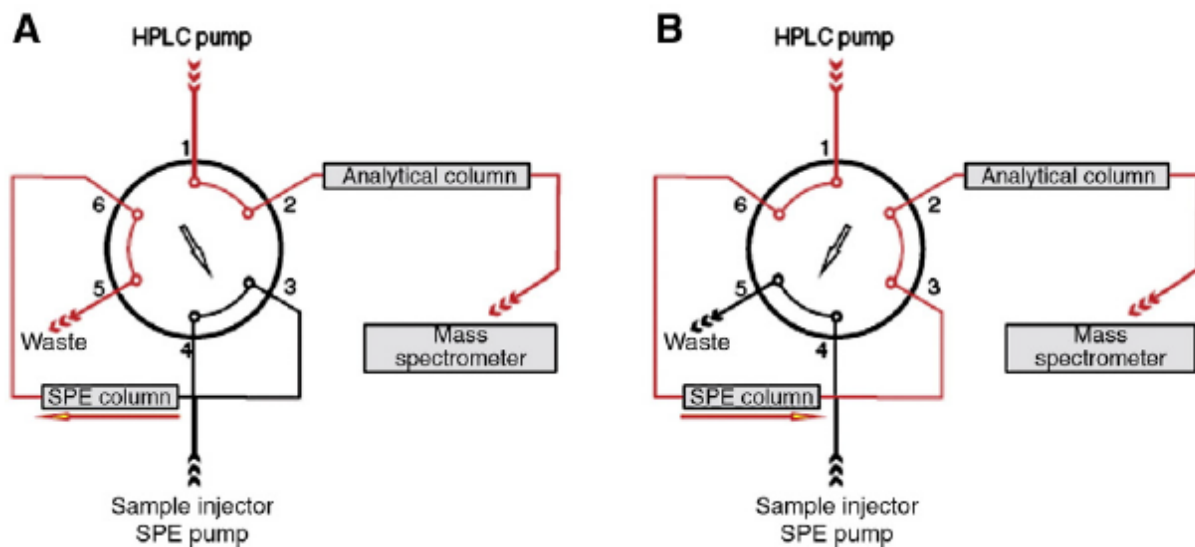

1. Beladung der SPE-Säule: Ein überwiegend wässriges Lösungsmittelgemisch transportiert Matrix und Substanzen auf die SPE-Säule. Dabei passieren polare Bestandteile die Säule ungehindert und werden in den Abfall gespült, unpolares Sorbens wird an der Säule retiniert (Abbildung 1, A).
2. Elution des unpolaren Sorbens von der SPE-Säule: Durch ein überwiegend organisches Lösungsmittelgemisch werden die retinierten Sorbentien von der SPE-Säule gelöst. Anschließend erfolgen Chromatographie und Detektion im Massenspektrometer (Abbildung 1, B).
3. Rekonditionierung der SPE-Säule: Die SPE-Säule wird auf die nächste Injektion vorbereitet. Zunächst wird die Säule mit Hochorganik gereinigt und im Anschluss wieder mit den Startbedingungen äquilibriert (Abbildung 1, A).

Für die on-line SPE werden zwei HPLC-Pumpen, darunter eine quartärnere Gradientenpumpe und ein 2-Positionen, 6-Port-Schaltventil benötigt.



## 1.2 Einzelne Publikationen

### 1.2.1 Kirchhoff F, Lorenzl S, Vogeser M.

**An on-line solid phase extraction procedure for the routine quantification of urinary methylmalonic acid by liquid chromatography-tandem mass spectrometry.**

**Clin Chem Lab Med 2010;48:1647-50.**

Vitamin B<sub>12</sub>- (Cobalamin-) Mangel ist ein **relativ häufiger** Befund, der durch die Serumcobalaminbestimmung **als labordiagnostischer Primärtest diagnostiziert** wird.<sup>3</sup> Eine wesentlich höhere diagnostische Selektivität wird über die Quantifizierung von funktionellen Markermolekülen des Vitamin-B<sub>12</sub>Mangels - Methylmalonsäure bzw. Homocystein - erreicht. So kann als Goldstandard der Vitamin B<sub>12</sub>-Mangeldiagnostik die Bestimmung der Methylmalonsäure/Kreatinin Ratio aus Spontanurin mittels LC-MS/MS gelten.

Der Fokus der im Rahmen der Promotionsarbeit entwickelten und in o.g. Publikation beschriebenen Methode lag auf der Optimierung der Routinetauglichkeit der Urin-Methylmalonsäure-Messung mittels LC-MS/MS.

Einer Flüssig/Flüssig-Extraktion mit anschließender Evaporation und Derivatisierung folgt eine on-line SPE. Mittels HPLC wird die isobare und ubiquitär vorkommende Bernsteinäure von der Methylmalonsäure abgetrennt. Die abschließende Detektion erfolgt im Tandemmassenspektrometer. Validierungsdaten charakterisieren die Methode als robust und leistungsfähig.

Im Vergleich zu bis dato publizierten Methoden konnte eine Verbesserung der Routinetauglichkeit durch Kompensation eines zweiten Evaporationsschritts durch die wesentlich schnellere on-line SPE erzielt werden .

---

<sup>3</sup> Lechner K, Födinger M, Grisold W, Püspök A, Sillaber C. Vitamin B<sub>12</sub>-Mangel. Neue Daten zu einem alten Thema. Wien Klin Wochenschr 2005;117/17: 579–591.

### **1.2.2 Kirchhoff F, Briegel J, Vogeser M.**

#### **Quantification of free serum cortisol based on equilibrium dialysis and isotope dilution-liquid chromatography-tandem mass spectrometry.**

**Clin Biochem 2011;44:894-9.**

Die biologisch und analytisch akurate Charakterisierung der adrenocorticalen Funktionslage ist für eine Vielzahl medizinischer Fragestellungen von wesentlicher Bedeutung; dies gilt insbesondere für die Objektivierung von Stresseffekten und für die Intensivmedizin. Aufgrund der nicht-linearen Bindungscharakteristik von Cortisol mit dem Corticosteroidbindenden-Globulin (CBG) und individuell unterschiedlichen CBG-Konzentrationen, ist die Bestimmung des freien, nicht proteingebundenen Serum-Cortisols der Quantifizierung des totalen Cortisols überlegen. Da die FSC-Bestimmung grundsätzlich ein mehrschrittiges und komplexes Analyseverfahren darstellt, ist eine Referenzmethode erforderlich. An dieser sollen sich auch mögliche automatisierte Testverfahren orientieren.

Für die Entwicklung einer gut praktikablen Kandidaten-Referenzmethode der freien Serum-Cortisol (FSC) Analytik wurde die Technik der Equilibrium-Dialyse zur Gewinnung des freien Cortisols aus Serum verwendet. Die Quantifizierung von Cortisol im Dialysat erfolgte mittels LC-MS/MS mit vorgeschalteter on-line SPE.

Die neu entwickelte Methode erwies sich im Rahmen von umfangreichen Untersuchungen als robust und gut praktikabel.

Aufbauend auf die in der Publikation dargestellte Entwicklungsarbeit kann in weiteren Projekten nun die Etablierung eines Referenzmeßsystems für den Analyten FSC angegangen werden.

### **1.2.3. Kirchhoff F, Maier B, Rieger C, Ostermann H, Spöhrer U, Vogeser M.**

**An on-line solid phase extraction procedure for the routine quantification of caspofungin by liquid chromatography-tandem mass spectrometry.**

**Clin Chem Lab Med 2012;50:521-4.**

Die Quantifizierung der systemischen Wirkkonzentration eines Arzneimittels zur Optimierung der Dosierung wird als Therapeutisches Drug Monitoring (TDM) bezeichnet.

Eine TDM-Empfehlung für Medikamente kann nur auf einer ausreichenden Datenlage von klinischen Studien ausgesprochen werden. Voraussetzung hierfür sind genaue und präzise Quantifizierungsmethoden.

Caspofungin, der im Klinikalltag am häufigsten zum Einsatz kommende Wirkstoff der neueren Generation aus der Gruppe der Echinocandine, wurde in der beschriebenen Methode adressiert. Die Methodenentwicklung orientierte sich an bis dato publizierten Arbeiten. Verbesserungen wurden in mehreren Punkten erzielt: Mit Tylosin, einem Wirkstoff aus der Veterinärmedizin, wurde ein kommerziell verfügbarer Interner Standard verwendet, der bedingt durch Co-Elution eine verlässliche Quantifizierung ermöglicht. Außerdem konnte der lineare Bereich, ein wichtiges Validierungskriterium, wesentlich erweitert werden.

Durch den Einsatz von online SPE wurde eine verbesserte Routinetauglichkeit erzielt. Die LC-MS/MS Methode kann für potentiell TDM und weitere klinische Studien zum Einsatz kommen.

### **1.2.4 Vogeser M, Kirchhoff F.**

**Progress in automation of LC-MS in laboratory medicine.**

**Clin Biochem 2011;44:4-13.**

Eine Vielzahl von kleinen Molekülen kann mittels LC-MS/MS quantifiziert werden, was sie zu einer wertvollen Technologie für die Klinische Chemie macht. Wesentliche Limitierungen erschweren jedoch das Etablieren der Technologie im klinischen Routinelabor: Fachpersonal bleibt weiterhin bei Methodenimplementierung und -anwendung unverzichtbar, die Robustheit der LC-MS/MS – Systeme ist noch ungenügend und für den Routinebetrieb erforderliche automatisierte Anwendungen fehlen derzeit gänzlich.

In unserer Übersichtsarbeit werden die bisherigen Ansätze zur Entwicklung gut praktikabler und voll routinetauglicher LC-MS/MS-basierter Analysensysteme für das klinische Routinelabor

systematisch aufgearbeitet und analysiert.

Als wesentliches Fazit wird gezogen, dass die relevanten Einzelkomponenten für derartige Systeme bereits verfügbar sind, und die technisch-industrielle Umsetzung damit realisierbar erscheint.

### **1.3 Zusammenfassung/ Summary**

Im Rahmen der Promotionsarbeit wurden LC-MS/MS Methoden für drei wichtige Analyte in den Bereichen der Ernährungsmedizin, Endokrinologie und dem Therapeutischen Drug Monitoring entwickelt. Bei diesen Methoden konnte gegenüber bislang publizierten Methoden vor allem eine deutliche Verbesserung der Routinetauglichkeit erzielt werden. Dies gelang insbesondere durch den Einsatz einer semi-automatisierten Probenvorbereitung, der on-line SPE-Technologie. Der derzeitigen Stand der Automatisierung in LC-MS Laboren wurde zudem in einer Übersichtsarbeit analysiert und bewertet. Insgesamt wurden mit den Einzelarbeiten des Promotionsprojektes Beiträge zur Verbesserung der labormedizinischen Diagnostik durch Anwendung der innovativen Technologie LC-MS/MS geleistet.

Within the period of the PhD work, LC-MS/MS method development was performed for three important analytes in the fields of nutritional medicine, endocrinology and therapeutic drug monitoring. Based on previously published methods, improvements concerning mainly the applicability for routine analyses were achieved, particularly by semi-automated sample preparation protocols – applying on-line solid phase extraction prior to LC-MS/MS. Moreover, current characteristics of automatisisation in LC-MS laboratories were analysed in a review.

Application of the innovative technology LC-MS/MS in the published studies makes a substantial contribution to diagnostics in laboratory medicine.

## **2. Originalpublikationen**

### **2.1 Kirchhoff F, Lorenzl S, Vogeser M.**

**An on-line solid phase extraction procedure for the routine quantification of urinary methylmalonic acid by liquid chromatography-tandem mass spectrometry.**

**Clin Chem Lab Med 2010;48:1647-50.**

## Short Communication

# An on-line solid phase extraction procedure for the routine quantification of urinary methylmalonic acid by liquid chromatography-tandem mass spectrometry

Fabian Kirchhoff<sup>1,\*</sup>, Stephan Lorenzl<sup>2</sup> and Michael Vogeser<sup>1</sup>

<sup>1</sup> Institute of Clinical Chemistry, Hospital of the University of Munich, Munich, Germany

<sup>2</sup> Clinic of Neurology, Hospital of the University of Munich, Munich, Germany

## Abstract

**Background:** The goal of this study was to develop and to validate an improved isotope-dilution-liquid chromatography-tandem mass spectrometry (LC-MS/MS) method for the quantification of methylmalonic acid (MMA) in urine.

**Methods:** A previously described sample preparation protocol requires two solvent extraction steps, including evaporation. The first extraction is to extract the analyte from the sample, and second occurs following derivatization of the extract. In the method described here, the second evaporation step was substituted by on-line solid phase extraction employing column-switching and a permanent co-polymer based extraction cartridge. A standard validation protocol was applied to investigate the performance of the method.

**Results:** The method was found to be linear in the clinically relevant range of concentrations (6–100  $\mu\text{mol/L}$ ). Total coefficients of variation were below 10% and inaccuracy was <10% for quality control samples at three concentrations.

**Conclusions:** By omitting one evaporation step, the semi-automated method described in this article enables for more convenient work-flow in the quantification of urinary MMA compared to the previous protocol. This is of relevance for MMA measurement in the routine clinical laboratory setting. Validation demonstrated acceptable analytical performance. Clin Chem Lab Med 2010;48:1647–50.

**Keywords:** liquid chromatography-tandem mass spectrometry (LC-MS/MS); methylmalonic acid (MMA); on-line solid phase extraction (SPE); urine.

Increased concentrations of methylmalonic acid (MMA) are recognized as a useful tool for the detection of cobalamin (vitamin B12) deficiency at the tissue level (1–3). Whereas serum cobalamin concentrations can be determined using high throughput ligand binding methods, reliable quantification of MMA in biological matrices requires the use of mass spectrometric methods. Since the degree of automation in mass spectrometric assays is limited (4), MMA quantification is not used at present for screening of cobalamin deficiency. Rather, it is typically used as a confirmatory second line test in cases where vitamin B12 concentrations are below 300 pg/mL.

The assessment of MMA concentrations in serum is hampered by the fact that a decreased glomerular filtration rate is associated with increased serum MMA concentrations, irrespective of the cobalamin status (5, 6). In contrast, quantification of the urinary MMA/creatinine-ratio is not subject to interference by impaired renal function, and is thus superior to serum MMA measurements (7). Furthermore, urine MMA concentrations are about 100-fold higher compared to serum, which favours the robustness of analytical methods for urine as the sample material (reference ranges (8): serum MMA, <0.44  $\mu\text{mol/L}$  [conversion of units for methylmalonic acid: ( $\mu\text{mol/L}$ ) $\times$ 0.118=(mg/L)]; urinary MMA/creatinine-ratio, <3.56 mmol/mol; assuming a typical mean urinary creatinine concentration of roughly 8.5 mmol/L, urinary MMA concentrations <30  $\mu\text{mol/L}$  can be considered normal).

Gas chromatography-mass spectrometry (GC-MS) methods for the quantification of urinary MMA were introduced in the late 1970s (9). To date, two liquid chromatography-tandem mass spectrometry (LC-MS/MS) methods for quantification of urinary MMA have been described (10, 11). Due to the highly-specific detection principle, the need for time consuming chromatographic separation is, in general, minimized in LC-MS/MS and many laboratories are now trying to switch MMA quantification from GC-MS to LC-MS/MS.

The methods that have been described for quantification of urinary MMA using LC-MS/MS include a multi-step sample preparation protocol. While the method described by Magera et al. (11) uses solid phase extraction, the method by Kushnir et al. (10) employs the more economic principle of solvent extraction. This protocol includes a solvent extraction step with evaporation of the extracts both before and after the derivatization step. The aim of our work was to

\*Corresponding author: Fabian Kirchhoff, Institute of Clinical Chemistry, Hospital of the University of Munich, Marchioninistraße 15, 81377 Munich, Germany  
Phone: +49 89 7095 3248, Fax: +49 89 7095 6220,  
E-mail: Fabian.Kirchhoff@med.uni-muenchen.de  
Received December 23, 2009; accepted May 21, 2010;  
previously published online August 13, 2010

improve this previously reported process of sample preparation for quantification of urinary MMA using LC-MS/MS by applying on-line solid phase extraction (SPE) with a permanent extraction cartridge (a scheme of the on-line SPE procedure is shown in Figure 1A).

We used a Waters Alliance 2795 HPLC module (Waters, Milford, MA, USA), coupled splitless to a Micromass Quattro LC tandem mass spectrometry system (Waters, Manchester, UK). For on-line solid phase extraction, a SPE column was used, together with a six-port high-pressure switching valve. Mass spectrometric conditions are listed in the online data supplement, Appendix 1.

Calibrators were made by diluting a stock solution of MMA with water to obtain MMA concentrations of 101.6, 76.2, 50.8, 38.1, 25.4, 12.7, 6.4  $\mu\text{mol/L}$ . We used three levels of quality control samples, prepared by spiking pooled

urine from healthy volunteers. Before spiking, the MMA concentration of this pool was determined by an independent GC-MS method, with cross-validation by an external laboratory. Target concentrations of the three quality control samples were calculated from the concentration of the pool and from the amount of spiked MMA. Aliquots of the quality control samples, as well as calibrators were stored at  $-20^{\circ}\text{C}$ .

Two urine pools were prepared for additional validation of reproducibility in the use of the method in an epidemiological study.

The complete sample preparation and on-line SPE procedure is provided in the legend to Figure 1. The retention time of dibutyl-MMA and the internal standard dibutyl- $\text{d}_3$ -MMA was approximately 4.9 min after injection onto the extraction column. The total analytical run time was 6.5 min. For quantification, the peak area-ratios of the multiple reaction mon-

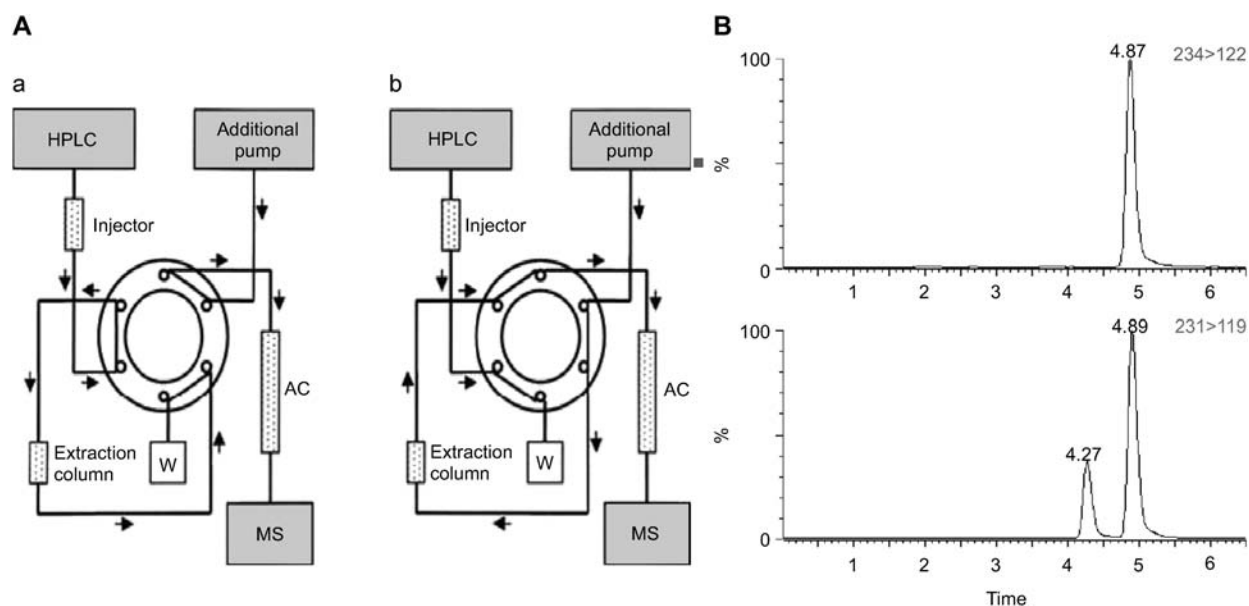

**Figure 1** (A) Scheme of the on-line solid phase extraction system (AC, analytical column; W, waste; MS, mass spectrometry system). (B) Representative MRM chromatograms obtained from a normal urine sample (MMA 9.3  $\mu\text{mol/L}$ ). Upper panel: dibutyl- $\text{d}_3$ -MMA. Lower panel: dibutyl-MMA (retention time approx. 4.9 min) base-line separated from dibutyl-SA (retention time approx. 4.3 min).

Sample preparation protocol: Into 1.5 mL polypropylene cups, 50  $\mu\text{L}$  of calibrator, quality control samples or human urine samples was mixed with 50  $\mu\text{L}$  of  $\text{d}_3$ -MMA (8.32  $\mu\text{mol/L}$ ) and 25  $\mu\text{L}$  of 1 M HCl. After equilibration, 1600  $\mu\text{L}$  methyl tertiary butyl ether (MTBE) was added and the cups were shaken for 10 min using a horizontal shaker. After stopping the shaking, a complete separation between aqueous and organic phase was obtained within seconds without centrifugation, with the organic layer above the aqueous phase. The organic phase was transferred into a 2.0 mL polypropylene cup, which was then placed into an evaporation device, thermostated at  $37^{\circ}\text{C}$  (Barkey Vapotherm, Labortechnik Barkey, Leopoldsheim, Germany). The extract was evaporated to dryness under a flow of nitrogen. The residue was dissolved in 50  $\mu\text{L}$  of the derivatization reagent 3 N HCl/BuOH by vortex mixing. The cups were opened and placed uncapped into a derivatization oven which was housed in a hood. Derivatization was performed at  $70^{\circ}\text{C}$  for 30 min. Subsequently, 300  $\mu\text{L}$  AcN/ $\text{H}_2\text{O}$  (75/25 by volume) was added to the tubes. After mixing, 100  $\mu\text{L}$  of this solution were transferred into HPLC vials. On-line solid phase extraction protocol: A Waters Oasis HLB column (25 mm,  $2.1 \times 20$  mm, stationary phase: specific ratio of two monomers, hydrophilic N-vinylpyrrolidone and lipophilic divinylbenzene; Waters, Milford, USA) was used. First 30  $\mu\text{L}$  of derivatized sample extract was injected and loaded onto the extraction column in valve position A. The mobile phase was water/methanol 90/10 (v/v), delivered at a flow rate of 4 mL/min. Potentially interfering compounds were washed into waste. In parallel, the analytical column (Waters xBridge Shield RP18,  $2.1 \times 150$  mm; 3.5 mm particle size) was equilibrated with 1 g/L formic acid-acetonitrile/10 mM ammonium formate 60/40 (v/v), delivered at a flow rate of 0.4 mL/min. After 1 min, the switching valve was changed to position B; the extraction column was now eluted in a back-flush mode onto the analytical column. After another 2 min, the valve was switched back to position A. During the analytical chromatography into the mass spectrometer in position A, the extraction column was washed with acetonitrile/methanol 50/50 (v/v) at a flow rate of 4 mL/min for 1 min and the extraction column subsequently re-equilibrated with water/methanol 90/10 (v/v). The analytical column was kept at  $38^{\circ}\text{C}$  in a column oven, while the extraction column was kept at ambient temperature.

itoring (MRM) trace of dibutyl-MMA and the internal standard dibutyl- $d_3$ -MMA were assessed. No fit weighting or axis transformation was applied.

An essential characteristic of quantification of MMA by LC-MS/MS is the need to obtain specificity towards succinic acid (SA) – which is isobaric with MMA and occurs naturally. While Kushnir et al. report that these isobaric compounds are distinguishable based on different fragmentation patterns, we were not able to obtain differentiation by MS/MS. Consequently, baseline chromatographic separation of MMA from SA is required for reliable quantification of urinary MMA (molecular structures of MMA, SA and  $d_3$ -MMA are shown in the data Supplement Figure 1). To verify complete chromatographic separation of dibutyl-MMA from dibutyl-SA, we analyzed pure solutions of the respective compounds as well as a mixture of both. We were able to demonstrate baseline separation and a representative MRM-chromatogram is shown in Figure 1B.

To test the efficacy of the on-line solid phase extraction protocol, derivatized samples were injected directly onto the analytical column, and for comparison, onto the entire analytical system including the on-line solid phase extraction. This was performed in triplicate for the three quality control samples. We observed approximately 30% higher MRM peak areas in the MRM trace of dibutyl- $d_3$ -MMA when applying on-line SPE compared to direct injection of the extracts (mean peak area of the QC samples without on-line SPE, 986 and using on-line SPE, 1271).

To study the recovery of the method, five urine samples were spiked with a pure solution of MMA (50  $\mu$ L sample was spiked with 50  $\mu$ L of a 101.6  $\mu$ mol/L MMA solution) prior to sample preparation. Comparative analyses of spiked vs. unspiked samples demonstrated a mean recovery rate of 95.4% (range: 91.8%–97.9%).

In order to characterize the sensitivity of the analytical system, a MMA solution with a concentration of 3.2  $\mu$ mol/L was analyzed in triplicate. A mean signal-to-noise ratio of 36:1 was found.

Ion-suppression characteristics of the method were assessed by connecting a T-piece between the chromatographic column and the ion source. Using a syringe pump, a pure solution of dibutyl-MMA (12.7  $\mu$ mol/L) was delivered at a constant flow rate (0.2 mL/min) into the T-piece. With this post-column infusion, a baseline offset was generated in the MRM-trace of dibutyl-MMA. We did not observe any significant variation of this offset upon injection

of human urine samples, ruling out relevant ion suppression by residual matrix components.

Potential carry over was excluded by injecting extracts from the highest quality control sample in quadruplicate, immediately followed by injection of a blank sample. The chromatogram for this sample showed no peaks in the MRM trace of dibutyl-MMA.

In four analytical series, applying full calibration, the mean observed results of the three quality control samples were compared with the expected concentrations and accuracy was calculated. We demonstrated mean accuracy and coefficients of variation below 10% (Table 1). Furthermore, we found that the coefficient of determination of the seven calibrator samples was  $>0.99$  in all series.

In addition, inter-assay coefficients of variation were calculated for two different quality control samples which were analyzed over a six week period in 14 series for application of the method in an epidemiological study. These two pool samples showed a coefficient of variation of 8.2% (mean concentration 5.3  $\mu$ mol/L) and 5.2% (mean concentration 20.0  $\mu$ mol/L).

Apart from several articles which describe analysis of underivatized MMA by LC-MS/MS using electrospray ionisation in the negative mode (12, 13), the majority of published work uses the positive mode. This may be attributed to a rather low ion yield, using negative ionization in many instruments including ours. In order to use the positive ionisation mode, derivatization of MMA to dibutyl-MMA is required. SPE is used in the method presented here, primarily to protect the ion source from the aggressive derivatization mixture and second, in order to avoid the second evaporation step which was applied by Kushnir et al. (10) following the derivatization step. Our modified sample preparation protocol realizes a time saving of more than 1 h for a batch of 50 samples when compared to the method described by Kushnir et al.

We confirmed close agreement between the method described here and the method described by Kushnir et al. Ten samples analyzed by both methods showed a mean deviation of 2.2%; range: –9.6% to +11.0%.

The additional analytical run time required for the auxiliary on-line SPE sample clean-up step is moderate with 1 min (or approx. 15% of the run-time); only one additional isocratic pump and a switching valve is required. According to our extensive experience with quantification of immunosuppressants (14), on line SPE columns made of multifunc-

**Table 1** Results of the method validation study (four-fold determination of spiked quality control samples in four analytical series).

	Target concentration, $\mu$ mol/L	Found concentration (mean), $\mu$ mol/L	Mean accuracy (n = 16 in 4 series), %	Total coefficient of variation (n = 16 in 4 series), %	Intra-assay coefficient of variation (n = 4; range)
QC level 1	29.4	28.9	–2.0	8.2	5.3%–11.6%
QC level 2	80.2	73.2	–8.7	5.5	2.3%–6.7%
QC level 3	173	159	–8.3	6.0	3.0%–6.6%



tional co-polymer are very robust and can be used for several thousand injections.

The results of the method validation study (sensitivity, ion suppression effects, carry over, as well as imprecision and accuracy), qualify the assay described here as being suitable for routine clinical application. However, when considering that the method incorporates isotope-dilution internal standardisation, coefficients of variation above 5% are surprising; which is in qualitative agreement with previous studies (10, 11). It may be assumed that isotope effects involved in the processes of derivatization, ionisation, and/or fragmentation could account for this observation. It has been shown previously that LC-MS/MS may be more prone to isotope effects than that observed in GC-MS (15).

The method was found to be convenient and robust with the approach of on-line SPE employing column switching in a large scale application: analysis of several hundred samples did not lead to any visible spoiling of the ion source components and no loss in sensitivity.

In summary, based on our results and experience, we can recommend the improved protocol described here. Our protocol involves the first on line SPE, and omits one evaporation step for the quantification of urinary MMA in the routine clinical laboratory setting.

## Acknowledgements

This study was supported by the Hans-Fischer-Gesellschaft München.

## Conflict of interest statement

**Authors' conflict of interest disclosure:** The authors stated that there are no conflicts of interest regarding the publication of this article. Research support played no role in the study design; in the collection, analysis, and interpretation of data; in the writing of the report; or in the decision to submit the report for publication.

**Research funding:** None declared.

**Employment or leadership:** None declared.

**Honorarium:** None declared.

## References

- Bolann BJ, Solli JD, Schneede J, Grøttum KA, Loraas A, Stokkeland M, et al. Evaluation of indicators of cobalamin deficiency defined as cobalamin-induced reduction in increased serum methylmalonic acid. *Clin Chem* 2000;46:1744–50.
- Klee GG. Cobalamin and folate evaluation: measurement of methylmalonic acid and homocysteine vs vitamin B<sub>12</sub> and folate. *Clin Chem* 2000;46:1277–83.
- Stover PJ. Physiology of folate and vitamin B12 in health and disease. *Nutr Rev* 2004;62:S3–12.
- Vogeser M, Seger C. A decade of HPLC–MS/MS in the routine clinical laboratory – goals for further developments. *Clin Biochem* 2008;41:649–62.
- Lindgren A. Elevated serum methylmalonic acid. How much comes from cobalamin deficiency and how much comes from the kidneys? *Scand J Clin Lab Invest* 2002;62:15–20.
- Vogiatzoglou A, Oulhaj A, Smith AD, Nurk E, Drevon CA, Ueland PM, et al. Determinants of plasma methylmalonic acid in a large population: implications for assessment of vitamin B12 status. *Clin Chem* 2009;55:2198–206.
- Norman EJ. Urinary methylmalonic acid/creatinine ratio defines true tissue cobalamin deficiency. *Br J Haematol* 1998;100:605–18.
- Rasmussen K, Nathan E. The clinical evaluation of cobalamin deficiency by determination of methylmalonic acid in serum or urine is not invalidated by the presence of heterozygous methylmalonic-acidaemia. *J Clin Chem Clin Biochem* 1990;28:419–21.
- Norman EJ, Berry HK, Denton MD. Identification and quantitation of urinary dicarboxylic acids as their dicyclohexyl esters in disease states by gas chromatography mass spectrometry. *Biomed Mass Spectrom* 1979;6:546–53.
- Kushnir MM, Komaromy-Hiller G, Shushan B, Urry FM, Roberts WL. Analysis of dicarboxylic acids by tandem mass spectrometry. High-throughput quantitative measurement of methylmalonic acid in serum, plasma, and urine. *Clin Chem* 2001;47:1993–2002.
- Magera M, Helgeson JK, Matern D, Rinaldo P. Methylmalonic acid measured in plasma and urine by stable-isotope dilution and electrospray tandem mass spectrometry. *Clin Chem* 2000;46:1804–10.
- Blom HJ, van Rooij A, Hogeveen M. A simple high-throughput method for the determination of plasma methylmalonic acid by liquid chromatography-tandem mass spectrometry. *Clin Chem Lab Med* 2007;45:645–50.
- Lakso HA, Appelblad P, Schneede J. Quantification of methylmalonic acid in human plasma with hydrophilic interaction liquid chromatography separation and mass spectrometric detection. *Clin Chem* 2008;54:2028–35.
- Vogeser M, Fleischer C, Meiser B, Groetzner J, Spöhrer U, Seidel D. Quantification of sirolimus by liquid chromatography-tandem mass spectrometry using on-line solid-phase extraction. *Clin Chem Lab Med* 2002;40:40–5.
- Lindegardh N, Annerberg A, White NJ, Day NP. Development and validation of a liquid chromatographic-tandem mass spectrometric method for determination of piperazine in plasma stable isotope labeled internal standard does not always compensate for matrix effects. *J Chromatogr B Analyt Technol Biomed Life Sci* 2008;862:227–36.

**2.2 Kirchhoff F, Briegel J, Vogeser M.**

**Quantification of free serum cortisol based on equilibrium dialysis and isotope dilution-liquid chromatography-tandem mass spectrometry.**

**Clin Biochem 2011;44:894-9.**



## Quantification of free serum cortisol based on equilibrium dialysis and isotope dilution-liquid chromatography–tandem mass spectrometry

Fabian Kirchoff<sup>a,\*</sup>, Josef Briegel<sup>b</sup>, Michael Vogeser<sup>a</sup>

<sup>a</sup> Institute of Clinical Chemistry, Hospital of the University of Munich, Munich, Germany

<sup>b</sup> Clinic of Anesthesiology, Hospital of the University of Munich, Munich, Germany

### ARTICLE INFO

#### Article history:

Received 17 December 2010  
Received in revised form 18 February 2011  
Accepted 5 April 2011  
Available online 22 April 2011

#### Keywords:

Liquid chromatography–tandem mass spectrometry (LC–MS/MS)  
Cortisol  
Free serum cortisol (FSC)  
Equilibrium dialysis (ED)

### ABSTRACT

**Objectives:** Only unbound serum cortisol is bioactive and protein binding of cortisol is highly variable. Thus, the quantification of free serum cortisol (FSC) is of superior biological relevance compared to total serum cortisol quantification. Consequently, the development of automated routine tests for FSC for endocrine testing is desirable – along the lines of free thyroid hormone measurement. Since the availability of a reliable and matrix-independent method is an important tool for this goal, we have developed a highly standardised mass spectrometric FSC method.

**Design and methods:** We used equilibrium dialysis (ED) to obtain a protein-free fraction from serum samples. The cortisol content of the dialysate was quantified using isotope-dilution two dimensional liquid chromatography (LCxLC–MS/MS).

**Results:** Comprehensive evaluation characterised the method as reliable and robust; using commercially available dialysis cells, convenient handling was realised.

**Conclusions:** The method described in this article can be suggested for the implementation of a reference measurement system for FSC.

© 2011 The Canadian Society of Clinical Chemists. Published by Elsevier Inc. All rights reserved.

### Introduction

Quantification of cortisol in serum is a cornerstone in the diagnostic work-up of patients with suspected abnormalities in adrenocortical function, such as Cushing's disease or Addison's disease, but also in patients at risk for critical illness-related corticosteroid insufficiency [1]. Several automated immunoassays are available for routine quantification of total serum cortisol (TSC) concentrations. Under normal conditions more than 90% of circulating cortisol in human serum is bound to proteins, mainly to corticosteroid-binding globulin (CBG) and to a minor proportion to albumin and to erythrocytes [2]. Since cortisol can interact with its intracellular receptors only after free diffusion through cell membranes, merely the unbound fraction of cortisol (free serum cortisol, FSC) is considered to be bioactive.

The protein binding of serum cortisol is highly variable due to non-linear molecular binding characteristics and due to very substantial inter- and intra-individual variation in CBG concentrations. During acute illness, CBG is cleaved and concentrations decrease profoundly

[3]; if the molar concentration of TSC exceeds the molar concentration of CBG, the bio-availability of cortisol increases dramatically due to spill-over [4]. Several xenobiotics, such as synthetic estrogens, in contrast, induce hepatic CBG synthesis resulting in decreased bioavailability of cortisol. For these reasons, quantification of FSC is considered to be biologically far more meaningful compared to TSC quantification in the context of endocrinological *in vitro*-diagnostics. Therefore, it is desirable that routine tests for FSC will be developed by the diagnostic industry, along the lines of free thyroid hormone testing. Notably, the biological variability of cortisol protein binding is much more pronounced compared to thyroxin.

FSC can be estimated mathematically from TSC and CBG concentrations, either by simple division (FSC index [5]) or by applying formulas, described by Coolens et al. [6] or by Dorin et al. [7]. Both equations incorporate the *typical* binding characteristics between cortisol and CBG. This approach has several shortcomings: CBG quantification by radioimmunoassay is time consuming and not standardised; individual variability in CBG binding properties – e.g. determined by competing steroids, free fatty acids, drugs or potentially also disease-related – is not considered. Moreover the contribution of cortisol binding to albumin is either estimated and simplified in the formula [6] or albumin quantification is required [7]. Furthermore, calculated results are biased by the cumulative total error of two or three distinct tests.

Future routine FSC tests will most likely rely on immunoassays by omitting the analyte-release step which is included in the assay protocol of total hormone tests – as applies for free thyroid hormone

**Abbreviations:** CBG, corticoid steroid binding globulin; FSC, free serum cortisol; TSC, total serum cortisol; ED, equilibrium dialysis; UF, ultrafiltration; ERM, European reference material; LCxLC, for two dimensional liquid chromatography; IS, internal standard; ID, isotope dilution; SPE, solid phase extraction; MRM, multiple reaction monitoring.

\* Corresponding author at: Institute of Clinical Chemistry, University of Munich, Marchioninstraße 15, D-81377 Munich, Germany. Fax: +49 89 7095 6220.

E-mail address: [Fabian.Kirchoff@med.uni-muenchen.de](mailto:Fabian.Kirchoff@med.uni-muenchen.de) (F. Kirchoff).

assays. However, it has to be objectified during the development of such one-step routine tests, that protein binding is entirely unaffected by the assay protocol and that matrix effects are controlled. Thus, for the development of such routine FSC tests, the availability of a reliable matrix independent comparison method is crucial. The aim of our project was to develop a respective mass spectrometry based method.

Free hormone reference assays are typically based on obtaining a protein free preparation from a serum or plasma sample aliquot in which the target analyte is quantified subsequently. This can be achieved by ultrafiltration (UF) using filter devices with a defined molecular cut-off, ranging between the molecular weight of the hormone analyte and its binding protein [8–10]. This approach is hampered by potential protein concentration effects on the filter layer and a cumbersome handling of UF devices. Alternatively, equilibrium dialysis (ED) can be used. This technique is time consuming but probably less prone to artefacts and easy to handle if commercial dialysis cells are used. Once a binding-protein-free preparation is obtained from serum, reliable quantification of cortisol ideally involves a mass spectrometric method based on the principle of isotope dilution (ID) internal standardisation. Gas chromatography–mass spectrometry may be applied for this aim; however, liquid chromatography–tandem mass spectrometry (LC–MS/MS) is now more widely available and is much more convenient, since no derivatisation is required. Based on these considerations, we decided to employ ED and ID–LC–MS/MS for the development of a working reference assay for the quantification of FSC. In particular we aimed to investigate whether a standard LC–MS/MS instrument is applicable in this context with respect to analytical sensitivity. In this manuscript a method is described in detail and results of a comprehensive evaluation study are given.

## Materials and methods

We obtained methanol and water, both HPLC gradient grade, from Baker (Deventer, The Netherlands). Ammonium formate was from Sigma-Aldrich (Steinheim, Germany); a stock solution (500 mM) was made in water. NaCl, KCl, Urea, NaN<sub>3</sub>, ZnSO<sub>4</sub>·7H<sub>2</sub>O and NaOH were all obtained from Merck (Darmstadt, Germany); Na<sub>3</sub>PO<sub>4</sub>·12H<sub>2</sub>O, MgSO<sub>4</sub>·7H<sub>2</sub>O, HEPES (free acid), and CaCl<sub>2</sub>·2H<sub>2</sub>O were from Sigma-Aldrich. All compounds were of the highest purity available.

Cortisol as a pure compound (98.7% purity by HPLC; Vetrinal®) was purchased from Sigma-Aldrich. Threefold deuterated cortisol (d<sub>3</sub>-cortisol), used as the internal standard (IS), was purchased from Cambridge Isotope Laboratories (Andover, USA). Molecular structures of the compounds are shown in Fig. 1.

We prepared stock solutions of cortisol (500.9 mg/L) and d<sub>3</sub>-cortisol (17.3 mg/L) in methanol in 10 ml volumetric flasks made of glass. A 50 µg/L cortisol working solution was prepared in protein-free buffer (see next paragraph). An IS working solution, containing 200 µg/L d<sub>3</sub>-cortisol was prepared in MeOH/ZnSO<sub>4</sub>·7H<sub>2</sub>O (4/1 by volume).

A 200 ml working solution of the protein-free buffer (dialysis buffer) was prepared according to Yue et al. [11]. In brief, for 200 ml dialysis buffer NaCl (1.038 g), Na<sub>3</sub>PO<sub>4</sub>·12H<sub>2</sub>O (0.25 g, which is equivalent to 0.1 g Na<sub>3</sub>PO<sub>4</sub>), KCl (0.0646 g), MgSO<sub>4</sub>·7H<sub>2</sub>O (0.0492 g), 4-(2-hydroxyethyl)-1-piperazineethanesulfonic acid (HEPES) (7.44 g), Urea (0.06 g), CaCl<sub>2</sub>·2H<sub>2</sub>O (0.055 g), NaN<sub>3</sub> (0.104 g) was dissolved in 200 ml of gradient grade water. The pH was adjusted to 7.28 ± 0.01 using 2.0 M NaOH at 22 °C.

We purchased Rapid Equilibrium Dialysis (RED) Device Inserts and a reusable base plate from Thermo Scientific Inc. (Pierce Biotechnology, Thermo Scientific, Waltham, USA). Fig. 2 illustrates the application of these devices. The base plate has a standard 96-well MTP footprint. Dialysis device inserts consist of a buffer chamber and of a sample chamber, separated from each other by a vertical cylinder membrane with a molecular weight cut-off of approximately 8000 Da. These

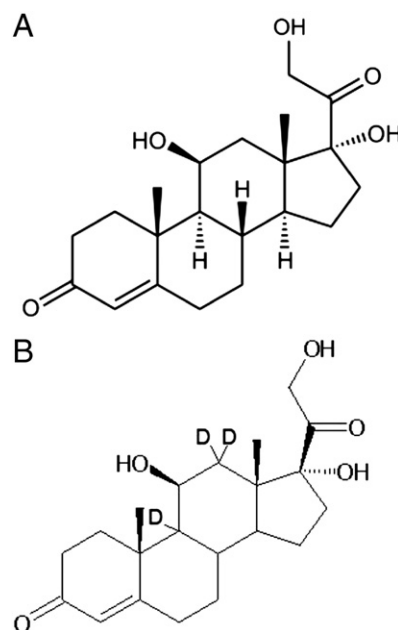

Fig. 1. Molecular structure of A) cortisol and B) d<sub>3</sub>-cortisol.

devices are inserted into the base plate and extracted after use with a special tool.

## Experimental

### Investigation of the ED variables

The manufacturer of the ED devices provides a pre-use washing protocol which might be useful for some of the potential analytes (soaking of the inserts for 10 min in ultra-pure water). In order to investigate if this washing/preconditioning step is necessary in case of FSC, we compared results found for patients' samples using pre-washed and not pre-washed devices. Randomly selected leftover serum (n=6) was used for this experiment. Close agreement was found and consequently no washing step was applied in the future study.



Fig. 2. Rapid Equilibrium Dialysis (RED) Device from Thermo Scientific. Single ED-units (highlighted in the picture) are inserted into a reusable base plate. Removing of used cells with an extraction tool is shown.

We furthermore evaluated the ratio of serum to dialysis buffer. For this aim, volumes of spiked buffer of 400, 500 and 600  $\mu\text{L}$ , respectively, were dialysed against 600  $\mu\text{L}$  of buffer. Four different concentrations were analysed in duplicate. Contrary to suggestions from Thermo Scientific (recommending a sample to buffer ratio from 1:1.5–3), in our experiments only the 1:1 volume ratio resulted in complete equilibration.

Subsequently, we tested if the volume of serum and dialysis buffer has an impact on results. Serum volumes of 400, 500 and 600  $\mu\text{L}$ , respectively, were dialysed against the same volume of buffer ( $n = 6$ ). FSC results obtained were compared. We did not observe an impact of the fluid volume on results.

To investigate the dialysis time required, pool serum was submitted to analysis in separate devices for 3, 4, 6, 7, 8, 10, 12, 14 and 16 h, and FSC was determined. This experiment was done in duplicate. Cortisol concentrations in dialysate increased from 3 to 10 h of dialysis and remained constant thereafter.

Based on these experiments (and applying the quantification protocol described below) analyses were standardised to the following conditions: Aliquots of 400  $\mu\text{L}$  serum samples were dialysed against 400  $\mu\text{L}$  dialysis buffer at  $37 \pm 0.2$  °C for 16 h with constant horizontal shaking of 100 rpm at ambient air. The base plate was covered with aluminium foil and additionally fixed with sealing tape. We discarded the single-use inserts and washed the reusable base plate as recommended by Thermo Scientific for the next application.

#### Calibration and quality control materials

Calibrators were made by diluting the working solution of cortisol with dialysis buffer to obtain cortisol concentrations of 50.0, 25.0, 12.5, 6.3, 3.1, 1.6, and 0.8  $\mu\text{g/L}$ . Additionally, dialysis buffer was used as blank-sample and zero-calibrator. Aliquots of the calibrators were stored in polypropylene vials at  $-80$  °C.

Quality control samples in three concentration levels were made by spiking dialysis buffer to 45.1, 15.0 and 1.0  $\mu\text{g/L}$  of cortisol. For this aim, a cortisol stock solution was separately weighted in; aliquots of the quality control samples were stored in polypropylene vials at  $-80$  °C.

An aliquot of European Reference Material ERM-DA192 (cortisol in human serum (unspiked)) was obtained from LGC Standards (Midlex, England; specified total cortisol concentration  $98.8 \pm 2.0$   $\mu\text{g/L}$ ).

Three serum pools were prepared to study the imprecision of the method. We used two distinct blood collections from one healthy volunteer. The first sample was taken at 11 p.m., in order to characterise a low cortisol concentration range, whereas the second sample was taken at 8 a.m., characterising physiological high serum cortisol concentrations. The third serum pool was prepared from residual serum send for standard clinical chemistry analyses from several intensive care unit patients. The pools were aliquoted in polypropylene vials and stored at  $-80$  °C.

#### Post-ED sample preparation

After dialysis, 150  $\mu\text{L}$  of dialysate was transferred into 1.5 ml polypropylene cups; the same applied for calibration and quality control samples, which were not submitted to ED. Subsequently, 50  $\mu\text{L}$  of IS working solution was added to the samples. The cups were vortexed and then shaken for 10 min using a horizontal shaker. This was followed by centrifugation for 10 min at 21,470 rcf. Supernatant was transferred into HPLC vials.

#### Instruments

A Waters Alliance 2695 HPLC module (Waters, Milford, USA) was used, together with a second isocratic HPLC pump (CLC300; Chromsystems, Munich, Germany) in the on-line solid phase extraction (SPE) configuration described below. A Micromass Quattro

LC tandem mass spectrometry system (Waters, Manchester, UK) was used for analyte detection. The chromatographic system was coupled splitless with the MS-system.

#### Chromatography

On-line solid phase extraction was used for sample clean up in a two dimensional liquid chromatography (LCxLC) set-up. For this aim, a Waters Oasis HLB column ( $2.1 \times 20$  mm; 25  $\mu\text{m}$  particle size, Waters, Milford, USA) was used together with a six-port high-pressure switching valve (Rheodyne, Rohnert Park, CA, USA) which was controlled by the Micromass MassLynx 4.0 mass spectrometry software. The automated extraction procedure consisted of three steps. First 50  $\mu\text{L}$  of the supernatant was injected and loaded onto the extraction column in valve position A (Fig. 3). The mobile phase was water/methanol 90/10 (v/v), delivered at a flow rate of 4 mL/min. Potential interfering compounds were washed into waste. In parallel, the analytical column (Kinetex C-18,  $2.1 \times 100$  mm; 2.6  $\mu\text{m}$  particle size; Phenomenex, Torrance, USA) was equilibrated with 80/20 (v/v) methanol/40 mM ammonium formate, delivered at a flow rate of 0.2 mL/min. After 1 min, the switching valve was changed to position B; the extraction column was now eluted in a back-flush mode onto the analytical column. After another 2 min, the valve was switched back to position A. During the analytical chromatography into the mass spectrometer in position A, the extraction column was washed with pure methanol at a flow rate of 4 mL/min for 1 min and the extraction column was subsequently re-equilibrated with water/methanol 85/15 (v/v). The analytical column was kept at 40 °C in a column oven, while the extraction column was kept at ambient temperature.

The retention time of cortisol and  $\text{d}_3$ -cortisol was  $\sim 2.8$  min after injection onto the extraction column. The total analytical run-time was 4.0 min. For quantification, the peak area-ratios of the multiple-reaction monitoring (MRM) trace of cortisol and the internal standard  $\text{d}_3$ -cortisol were assessed. No fit weighting or axis transformation was applied.

#### Mass spectrometric conditions

Electrospray ionisation in the positive mode was used. Source parameters were tuned to obtain the protonated quasi-molecular ions of cortisol and  $\text{d}_3$ -cortisol, respectively (363 and 366 m/z). The following settings resulted in optimal ion yield: capillary voltage, 2.45 kV; cone voltage, 35 V; source temperature, 120 °C; desolvation temperature, 350 °C; nitrogen flow,  $\sim 700$  L/h; cone gas flow,  $\sim 140$  L/h. The collision energy with argon as the collision gas was 20 V. For

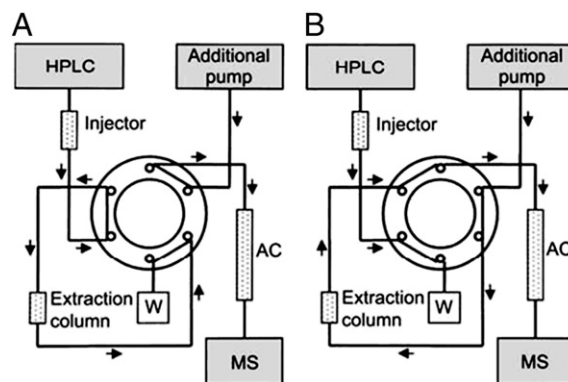

Fig. 3. Scheme of the on-line solid phase extraction system used in the quantification of cortisol in dialysate (AC, analytical column; W, waste; MS, mass spectrometry system). Position A, injection and adsorption of analytes to the extraction column; position B, elution of the analytes from the extraction column onto the analytical column and the mass spectrometer.

quantification the following MRM transitions were recorded: cortisol, 363 > 121; d<sub>3</sub>-cortisol 366 > 121. The dwell time for the MRM traces for cortisol and d<sub>3</sub>-cortisol, respectively, was 0.2 s.

A representative chromatogram acquired from a serum sample dialysate is given in Fig. 4.

#### Assay validation

Reproducibility, accuracy and linearity of the method were validated in 12 analytical series over a period of 20 weeks applying full calibration. The matrix-free spiked quality control samples at three concentrations were analysed without the dialysis step in three-fold determination within these series in order to determine accuracy of the quantification part of the method. Imprecision of the entire method (including ED) was studied by analysing the three serum pools in each run applying the entire protocol. For calculation of the intra-assay coefficient of variation, 10 aliquots of each pool were analysed in one series.

To study the recovery of the quantification method, pool serum samples were spiked with different amounts of the cortisol working solution in order to obtain three different concentration levels (+5, +10 and +20 µg/L cortisol). Comparative TSC analyses of spiked versus unspiked samples were evaluated in duplicate in one run (n = 6).

To determine the sensitivity of the quantification method (lower limit of quantification, LLOQ), we analysed spiked dialysis buffer in duplicate in three runs (concentration of cortisol, 0.1, 0.2, 0.4 µg/L); to investigate the upper limit of quantification (ULOQ) we prepared samples with cortisol concentrations of 400, 450 and 500 µg/L, respectively. Deviation of ±20% from the target concentrations was defined as the criterion for acceptance.

Lyophilized serum cortisol reference material ERM-DA192 was reconstituted in water. Subsequently, aliquots were analysed for total cortisol concentrations not applying the ED procedure in order to proof accuracy of the method with reference to an international standard preparation. Moreover we quantified FSC of ERM-DA 192 in triplicate in order to allow comparison of the results if the assay is implemented on a different site.

With respect to the selectivity of the method, two databases (NIST Mass spectral database; Metlin Metabolite Database) were searched for compounds with similar molecular weight (±2 Da) as cortisol or d<sub>3</sub>-cortisol. 4 compounds were found to be potentially relevant. In order to exclude interference by isobaric compounds in patients' samples, extended chromatography was applied in pool samples (column: Lichrospher 100 C-18, 250 × 4 mm; 5 µm particle size; flow 0.7 ml/min, split approximately 1:3). MRM traces were inspected for peaks with retention times differing from that of cortisol and d<sub>3</sub>-cortisol. The retention time of cortisol was 5.3 min in this chromatographic configuration.

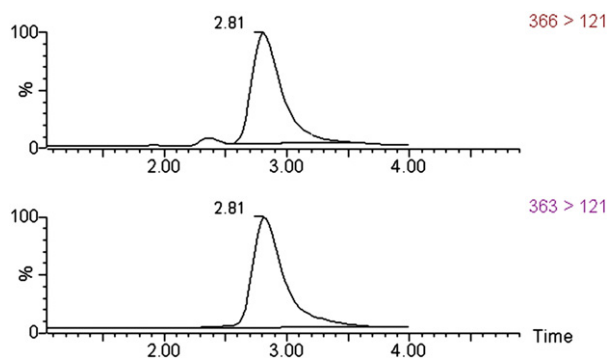

Fig. 4. Quantification of cortisol in dialysate from serum by LCxLC-MS/MS: Representative chromatogram obtained from a pooled serum sample from intensive care unit patients (FSC: 57 µg/L). Upper panel: d<sub>3</sub>-cortisol; lower panel: cortisol.

Ion-suppression characteristics of the method were assessed by connecting a T-piece between the chromatographic column and the ion source. Using a syringe pump, a pure solution of cortisol and d<sub>3</sub>-cortisol (each 500 µg/L) was delivered with a constant flow rate of 10 µL/min into the T-piece. By this post-column infusion, a baseline offset was generated in the MRM-traces of cortisol and d<sub>3</sub>-cortisol. The variation of this baseline signal was observed upon injection of samples derived from human sera.

Potential carry over was tested by injecting samples of the highest quality control material in quadruplicate, immediately followed by injection of a blank sample. The chromatogram of this sample was inspected for peaks in the MRM traces of cortisol.

In order to determine stability of FSC we applied the “Guidance for Industry” protocol suggested by the Food and Drug Administration (FDA) [12]. We used two serum pools and investigated freeze and thaw-, short-term temperature-, long-term-, stock-solution- and post-preparative stability.

#### ED device comparison

As a final experiment, we investigated the agreement between FSC results observed using ED devices from a different manufacturer (Scienova Xpress Equilibrium Dialyzer, Scienova, Jena, Germany) by comparative analysis of 16 samples. Apart from the ED devices, all ED variables were identical in this experiment.

#### Results

We found excellent linearity with a coefficient of determination of the 7 calibrator samples >0.999 in all validation series. Mean accuracy of the three QC samples ranged from 94.6 to 102.5%. Interassay coefficients of variation found for the three serum pools ranged from 3.1 to 9.8%. The raw data of the evaluation are given in Table 1.

LLOQ was 0.20 µg/L (mean accuracy: 105.6%, coefficient of variation: 10.4%; n = 6). Linearity was observed far above the calibration range, with a mean deviation from the target result of –10.9% for a sample with a cortisol concentration of 500 µg/L (n = 6).

Comparison of calculated and observed results in spiking experiments demonstrated a mean spiking recovery of 108.9% (range: 105.4%–113.1%) for the quantification of cortisol.

For the total serum cortisol reference material (ERM-DA 192), a concentration of 96.10 µg/L was found, corresponding to –2.7% of expected value (analysis without ED). A FSC concentration of 7.55 µg/L (mean of three determinations) was found for this reference material.

In the two databases screened, we identified 4 relevant compounds as potentially interfering with mass spectrometric detection of cortisol and d<sub>3</sub>-cortisol according to similar molecular masses: Three endogenous molecules (aldosterone, 18-OH-corticosterone and tetrahydrocortisone) and one drug (prednisolone) were investigated for interference by an experiment. We introduced pure solutions with concentrations above the physiological range (c = 200 µg/L) of aldosterone (mass/charge ratio: 361.4), 18-OH-corticosterone (363.2) and tetrahydrocortisone (365.5), as well as for prednisolone (361.4), with a concentration of 1000 µg/L to our chromatographic procedure. We did not observe peak signals in the MRM traces of cortisol or d<sub>3</sub>-cortisol, respectively.

Analysis of dialysate obtained from pool samples using extended chromatography did not disclose additional peaks with retention times differing from that of cortisol. Only samples from intensive care unit patients showed a minor peak, eluting earlier than d<sub>3</sub>-cortisol in the MRM-trace of d<sub>3</sub>-cortisol (366 > 121). This peak was base-line separated using the standard chromatographic conditions (Fig. 4).

No evidence of ion suppression or carry over effects was observed.

In the stability experiments (freeze and thaw-, short-term temperature-, long-term-, stock solution- and post preparative stability tests) deviation of <10% from expected results was observed.

**Table 1**  
Quantification of free serum cortisol by equilibrium dialysis and isotope dilution, two-dimensional liquid chromatography and tandem mass spectrometry: results of the method validation study. Analysis of the spiked quality control (QC) samples 1–3 did not include ED. Results obtained in 12 validation series.

	Pool low	Pool medium	Pool high
Observed concentration (mean)	2.33 µg/L	3.99 µg/L	56.8 µg/L
Total coefficient of variation (n = 21 in 12 series)	9.8%	7.6%	3.1%
Intra-assay coefficient of variation (n = 10)	9.8%	8.9%	3.5%
	QC sample 1	QC sample 2	QC sample 3
Target concentration	1.00 µg/L	15.0 µg/L	45.1 µg/L
Observed concentration, mean	1.03 µg/L	14.9 µg/L	42.7 µg/L
range	0.87–1.15 µg/L	13.8–16.0 µg/L	40.7–45.7 µg/L
Accuracy, mean	102.5%	98.8%	94.6%
range	–13.1–+14.6%	–8.2–+6.5%	–9.9–+1.3%
Total coefficient of variation (n = 36 in 12 series)	7.4%	4.0%	2.8%
Intra-assay coefficient of variation (range; n = 3 in 12 series)	2.1–14.4%	1.4–6.0%	0.2–4.7%

Post preparative stability investigation showed deviation of less than 5% from target results.

We found good agreement of FSC results obtained for 16 samples using different commercially available ED devices ( $y = 0.8243x + 0.1808$ ;  $r^2 = 0.97$ ).

During the time period of method validation we analysed more than 300 samples for FSC in the context of a clinical study [13]. We found good practicability of the protocol under these conditions of larger scale application.

In healthy volunteers (n = 47, male marathon athletes, sampling between 8 and 10 a.m.) a mean FSC of 13.1 µg/L was found (SD: 5.3 µg/L) with this method. Previously reported normal ranges for FSC are 16.5 µg/L (SD: 5.6 µg/L) for sampling at 8 a.m. and 2.3 µg/L (SD 1.8 µg/L) for sampling at 10 p.m. [6].

## Discussion

We here describe a convenient isotope dilution mass spectrometry method for the quantification of free, bioactive cortisol in serum; evaluation data characterise this method as reliable and applicable for both clinical studies and in the context of the development of routine ligand binding tests for this innovative analyte.

In previous clinical studies we so far employed self manufactured dialysis cells for the quantification of free serum cortisol [14]; here we used convenient dialysis devices which have become commercially available meanwhile. This realises a substantially higher degree of standardisation and offers far better practicability, also allowing a substantial throughput of samples.

For free hormone reference methods, ED is preferred to UF [15] since it can be assumed that a forced filtration process can induce disequilibrium artefacts on the site of the filtration membrane [16]. This may potentially introduce bias in previously described FSC methods [8–10]. In our experience, the technique of UF for FSC quantification is furthermore flawed by a very substantial between-sample variation in the yield of filtrate at a given constant centrifugal filtration time, often with >100% differences in the volume of filtrates obtained from different samples. The filtration, as well as the dialysis process has to be performed at exactly 37 °C, due to the fact that the binding affinity of CBG to cortisol is very sensitive to temperature variations [17,18]. Precise temperature control inside a centrifuge and of the filtration devices however is difficult to obtain with commercially available centrifuges; this compromises the reliability of UF methods for FSC quantification [19]. For these reasons we assume ED superior to UF for FSC measurement.

The unbound fraction of serum cortisol represents roughly one tenth of the total cortisol concentrations and thus very low analyte concentrations have to be addressed. Our results, however, demonstrate that reproducible quantification of this analyte does not require “high-

end” mass spectrometry instruments but can be achieved also using standard LC–MS/MS equipment. By using on-line solid phase extraction (also termed LCxLC), matrix effects on the ionisation of the target analyte could be minimised in our method. No matrix induced ion suppression was observed in our experiments. Potential occurrence of ion suppression in *individual* samples is compensated for by the principle of isotope dilution applied in this method.

For the method described herein acceptable reproducibility with inter-assay CVs <10% for authentic sample materials in a physiologically very low concentration range was observed, as well as good accuracy with <5% deviation from target concentrations for matrix-free spiked samples. The development of an actual reference method for FSC quantification based on our protocol must aim to improve the reproducibility, to CVs of ideally  $\leq 2\%$ . This seems feasible when applying latest high-end MS/MS instruments with superior signal-to-noise characteristics compared to the system used here.

A drawback in the evaluation of FSC measurement is given by the fact that authentic but analyte-free serum matrix for investigation of accuracy by spiking experiments is not available. Thus, our results on accuracy are restricted to the mass spectrometric analysis but did not address the process of equilibrium dialysis.

Membrane leakage is an important and omnipresent potential pitfall of ED. Gross leakage becomes evident from a serum-like colour of the dialysate. We have observed this in about 2% of the dialysis devices. Minor leakage, in contrast, may remain undetected by visual inspection. The results of our imprecision study – where one sample was excluded, due to serum-like colour of the dialysate –, however, suggest that the degree of a device-individual micro-leakage was minor. Nevertheless, analyses in duplicate should be considered depending of the scope of application.

In a sub-set of evaluation samples we used dialysis devices from a different manufacturer for comparison. Close correlation of the results but an approximate 20% systematic bias was observed. This might be explained by adsorption of the analyte to surfaces of protein-free compartments of the comparison devices. Whatsoever, standardisation of dialysis devices seems important and also lot-to-lot variations of ED devices must be assessed critically in the context of specifying a reference method in the future.

The method described in this manuscript should undergo – after this mono-centric evaluation – an extended multi-centric validation process. Selectivity experiments applying extended chromatography should be performed for individual instruments, since interference from isobaric compounds can potentially occur in an instrument specific manner [20].

Our method is also applicable for clinical studies; in particular, reference ranges for FSC in the context of endocrine function testing (e.g. ACTH stimulation test and dexamethasone suppression test) should be established on a high level of reliability using an isotope

dilution assay now. If this is realised, the method can as well be applied for diagnostic purposes since LC–MS/MS becomes more and more used in endocrinological clinical laboratories. Overnight incubation for equilibrium dialysis might be acceptable also in a routine setting, since turnaround-time is not critical in the diagnostic work-up of suspected adrenocortical pathologies in most cases. Dialysis devices create extra costs of approximately 7 € per sample which also might be acceptable in a clinical setting.

It seems very likely that the diagnostic use of free serum cortisol will result in superior diagnostic power compared to total serum cortisol measurement, because of the substantial inter- and intra-individual variation serum cortisol binding and the well-founded assumption that only unbound cortisol is biologically active [21]. Salivary cortisol measurement may be an alternative to FSC measurement [22], however, drawbacks of this approach have to be considered: Dissociation between blood and saliva free cortisol levels under challenge conditions are observed and discussed with respect to the presence of CBG also in saliva [23,24]. Moreover, it must be considered that cortisol undergoes enzymatic conversion to cortisone by 11 $\beta$ -hydroxysteroid dehydrogenases in salivary glands to a considerable proportion with potentially substantial between-individual variation. Furthermore, reliable collection of saliva is difficult in severely ill patients with suspected critical illness related corticosteroid insufficiency (CIRCI).

Since ligand binding assays are still the predominant technology in the clinical endocrinology laboratory worldwide, the introduction of routine FSC tests on respective automated platforms – as was realised for free thyroid hormones many years ago – is highly desirable. The availability of a convenient isotope-dilution mass spectrometry method– as described in this report – for analytical reassurance during routine assay development might encourage the diagnostic industry in the decision to develop such tests. This might be along the lines of 25-hydroxyvitamin D measurement, where LC–MS/MS is now established and accepted as the key technology during the development of reliable routine ligand binding assays [25,26].

## Acknowledgement

This study was supported by the Hans-Fischer-Gesellschaft München.

## References

- [1] Marik PE, Pastores SM, Annane D, Meduri GU, Sprung CL, Arlt W, et al. Recommendations for the diagnosis and management of corticosteroid insufficiency in critically ill adult patients: consensus statements from an international task force by the American College of Critical Care Medicine. *Crit Care Med* 2008;36:1937–49.
- [2] Lentjes EG, Romijn FH. Temperature-dependent cortisol distribution among the blood compartments in man. *J Clin Endocrinol Metab* 1999;84:682–7.
- [3] Hammond GL, Smith CL, Underhill DA. Molecular studies of corticosteroid binding globulin structure, biosynthesis and function. *J Steroid Biochem Mol Biol* 1991;40:755–62.
- [4] Hamrahian AH, Oseni TS, Arifah BM. Measurements of serum free cortisol in critically ill patients. *N Engl J Med* 2004;350:1629–38.
- [5] Bonte HA, van den Hoven RJ, van der Sluijs Veer G, Vermes I. The use of free cortisol index for laboratory assessment of pituitary–adrenal function. *Clin Chem Lab Med* 1999;37:127–32.
- [6] Coolens JL, van Baelen H, Heyns W. Clinical use of unbound plasma cortisol as calculated from total cortisol and corticosteroid-binding globulin. *J Steroid Biochem* 1987;26:197–202.
- [7] Dorin RI, Pai HK, Ho JT, Lewis JG, Torpy DJ, Urban FK, et al. Validation of a simple method of estimating plasma free cortisol: role of cortisol binding to albumin. *Clin Biochem* 2009;42:64–71.
- [8] Vogeser M, Möhnle P, Briegel J. Free serum cortisol: quantification applying equilibrium dialysis or ultrafiltration and an automated immunoassay system. *Clin Chem Lab Med* 2007;45:521–5.
- [9] Huang W, Kalthorn TF, Baillie M, Shen DD, Thummel KE. Determination of free and total cortisol in plasma and urine by liquid chromatography–tandem mass spectrometry. *Ther Drug Monit* 2007;29:215–24.
- [10] Ionita IA, Akhlaghi F. Quantification of unbound prednisolone, prednisone, cortisol and cortisone in human plasma by ultrafiltration and direct injection into liquid chromatography tandem mass spectrometry. *Ann Clin Biochem* 2010;47:350–7.
- [11] Yue B, Rockwood AL, Sandrock T, La'ulu SL, Kushnir MM, Meikle AW. Free thyroid hormones in serum by direct equilibrium dialysis and online solid-phase extraction–liquid chromatography/tandem mass spectrometry. *Clin Chem* 2008;54:642–51.
- [12] Guidance for industry, bioanalytical method validation. FDA/CDER/CVM; Mai 2001.
- [13] Kerlik J, Rovenský J, Vogeser M, Vlcek M, Imrich R, Penesová A, Rádková Z. Evaluation of 11beta-hydroxysteroid dehydrogenase type 1 activity in female patients with rheumatoid arthritis. *Vnitr Lek* 2010;56:1274–8.
- [14] Vogeser M, Groetzner J, Küpper C, Briegel J. Free serum cortisol during the postoperative acute phase response determined by equilibrium dialysis liquid chromatography–tandem mass spectrometry. *Clin Chem Lab Med* 2003;41:146–51.
- [15] Ekins R. Measurement of free hormones in blood. *Endocr Rev* 1990;11:5–46.
- [16] Holm SS, Hansen SH, Faber J, Staun-Olsen P. Reference methods for the measurement of free thyroid hormones in blood: evaluation of potential reference methods for free thyroxine. *Clin Biochem* 2004;37:85–93.
- [17] Vogeser M, Briegel J. Effect of temperature on protein binding of cortisol. *Clin Biochem* 2007;40:724–7.
- [18] Cameron A, Henley D, Carrell R, Zhou A, Clarke A, Lightman S. Temperature-responsive release of cortisol from its binding globulin: a protein thermocouple. *J Clin Endocrinol Metab* 2010;95:4689–95.
- [19] Van Uytenghe K, Stöckl D, Ross HA, Thienpont LM. Use of frozen sera for FT4 standardization: investigation by equilibrium dialysis combined with isotope dilution-mass spectrometry and immunoassay. *Clin Chem* 2006;52:1817–21.
- [20] Vogeser M, Seger C. Pitfalls associated with the use of liquid chromatography–tandem mass spectrometry in the clinical laboratory. *Clin Chem* 2010;56:1234–44.
- [21] Bornstein SR. Predisposing factors for adrenal insufficiency. *N Engl J Med* 2009;360:2328–39.
- [22] Zerikly RK, Amiri L, Faiman C, Gupta M, Singh RJ, Nutter B, et al. Diagnostic characteristics of late-night salivary cortisol using liquid chromatography–tandem mass spectrometry. *J Clin Endocrinol Metab* 2010;95:4555–9.
- [23] Hellhammer DH, Wüst S, Kudielka BM. Salivary cortisol as a biomarker in stress research. *Psychoneuroendocrinology* 2009;34:163–71.
- [24] Levine A, Zagoory-Sharon O, Feldman R, Lewis JG, Weller A. Measuring cortisol in human psychobiological studies. *Physiol Behav* 2007;90:43–53.
- [25] Vogeser M, Kyriatsoulis A, Huber E, Kobold U. Candidate reference method for the quantification of circulating 25-hydroxyvitamin D3 by liquid chromatography–tandem mass spectrometry. *Clin Chem* 2004;50:1415–7.
- [26] Vogeser M. Quantification of circulating 25-hydroxyvitamin D by liquid chromatography–tandem mass spectrometry. *J Steroid Biochem Mol Biol* 2010;121:565–73.



**2.3 Kirchhoff F, Maier B, Rieger C, Ostermann H, Spöhrer U, Vogeser M.**

**An on-line solid phase extraction procedure for the routine quantification of caspofungin by liquid chromatography-tandem mass spectrometry.**

**Clin Chem Lab Med 2012;50:521-4.**

## Short Communication

# An on-line solid phase extraction procedure for the routine quantification of caspofungin by liquid chromatography-tandem mass spectrometry

Fabian Kirchhoff<sup>1,\*</sup>, Barbara Maier<sup>1</sup>,  
Christina Rieger<sup>2</sup>, Helmut Ostermann<sup>2</sup>,  
Ute Spöhrer<sup>3</sup> and Michael Vogeser<sup>1</sup>

<sup>1</sup>Institute of Clinical Chemistry, Hospital of the University of Munich, Munich, Germany

<sup>2</sup>Department of Internal Medicine III, Hospital of the University of Munich, Munich, Germany

<sup>3</sup>Hospital Pharmacy, Hospital of the University of Munich, Munich, Germany

## Abstract

**Background:** Extensive sets of data are required to investigate the potential use of a therapeutic drug monitoring with individualization of dosage of the antimycotic compound caspofungin. The goal was to develop an improved liquid chromatography-tandem mass spectrometry (LC-MS/MS) method for this aim.

**Methods:** Following protein precipitation, on-line solid phase extraction was performed for sample preparation. As the internal standard compound the veterinary drug tylosin was used. A standard validation protocol was applied.

**Results:** Good reproducibility and accuracy of the method were observed. On-line solid phase extraction resulted in a convenient work-flow and good robustness of the method.

**Conclusions:** This improved LC-MS/MS method was found reliable and convenient. It can be suggested for further work on the clinical pharmacology of caspofungin in the setting of clinical research laboratories.

**Keywords:** caspofungin; liquid chromatography-tandem mass spectrometry (LC-MS/MS); on-line solid phase extraction (SPE); tylosin.

Invasive fungal infections represent a leading cause of morbidity and mortality in immunocompromized patients today.

\*Corresponding author: Fabian Kirchhoff, Hospital of the University of Munich, Institute of Clinical Chemistry, Marchioninistraße 15, D-81377 Munich, Germany  
Phone: +49 89 7095 3248, Fax: +49 89 7095 6220,  
E-mail: fabian.kirchhoff@med.uni-muenchen.de  
Received July 12, 2011; accepted November 3, 2011; previously published online November 30, 2011

During the last decade the therapeutic armamentarium has expanded substantially and now includes almost 10 compounds to be considered for prophylaxis and treatment of invasive fungal infections (1). Therapeutic drug monitoring (TDM) is increasingly discussed for each of these drugs, however – in contrast to immunosuppressants used in transplantation medicine – guidelines for TDM of anti-mycotic drugs have scarcely been defined or evaluated (2).

For the triazole compounds (itraconazol, posaconazol, voriconazol) chromatographic and mass spectrometric methods are now available in a substantial number of clinical research centers; the analytics of the more novel group of echinocandins has been addressed only by a few groups so far. Among the echinocandins, on the one hand caspofungin plays the most important role in clinical practice to date, on the other hand a higher incidence of side-effects and potential for drug-drug interactions is known for caspofungin (3).

Caspofungin steady-state concentrations in plasma between 0.25 and 2.5 mg/L have been described for different administration regimens (4); clinically relevant caspofungin levels range up to approximately 10 mg/L (5).

The aim of our work was to develop a reliable liquid chromatography-tandem mass spectrometry (LC-MS/MS) method for respective clinical investigations, applicable in the setting of routine laboratories, thereby addressing some limitations of previously published methods (see online data Supplemental Appendix 1). Beyond published work on caspofungin measurement by LC-MS/MS two issues were addressed by our work in particular: investigation of a suited and commercially available compound for internal standardization and development of a semi-automated sample preparation protocol based on on-line solid phase extraction (SPE) prior to a standard LC-MS/MS system. This principle has been used in our laboratory for over 10 years now and is found to enable very robust methods with short run times and minimal down-times required for maintenance.

Twenty-five microliters of calibrator, quality control sample, or serum was shortly vortexed with 50 µL of phosphate buffered saline (PBS) solution in 1.5 mL polypropylene cups. Thereafter 75 µL of internal standard (IS) working solution [approx. 100 µg/L tylosin in acetonitrile/methanol (9:1 by volume)] was added. Cups were shaken for 10 min using a horizontal shaker. This was followed by centrifugation for 10 min at 15,000 g. Ten microliters of each supernatant was injected into the LC-MS/MS system (Waters Alliance 2795

HPLC module; Waters, Milford, MA, USA), coupled splitless to a Micromass Quattro Micro tandem mass spectrometry system; mass spectrometric conditions are listed in the online data Supplemental Appendix 4. Sample clean-up was performed online using on-line SPE.

Supernatant was injected and loaded onto a Waters Oasis HLB column (2.1×20 mm; 25 µm particle size; Waters, Milford, MA, USA) in valve position A (scheme of the on-line SPE is given in Figure 1). The mobile phase was water/methanol 90/10 (v/v), delivered at a flow rate of 4 mL/min. Potential interfering compounds were washed into waste. In parallel, the analytical column (xTerra C-8, 2.1×50 mm; 3.5 µm particle size; Waters, Milford, MA, USA) was equilibrated with 70/30 (v/v) acetonitrile/15 mM ammonium formate, delivered at a flow rate of 0.2 mL/min. After 1 min, the switching valve was changed to position B; the extraction column was now eluted in a back-flush mode onto the analytical column. After another 2 min, the valve was switched back to position A. During the analytical chromatography into the mass spectrometer in position A, the extraction column was washed for 1 min with 80/20 (v/v) methanol/1% formic acid at a flow rate of 4 mL/min. The total run time was 3.5 min.

For quantification, we applied 1/x fit weighting of the peak area ratios of analyte/IS vs. the concentration to obtain the calibration curves.

Calibrators were made by diluting the working solution of caspofungin (see online data Supplemental Appendix 5) with drug-free human serum to obtain caspofungin concentrations of 20.0, 10.0, 5.0, 2.5, 1.25, 0.62 and 0.31 mg/L. In the same manner, we prepared quality control samples in three concentration levels (16.0, 1.6 and 0.4 mg/L). We used one serum pool, in order to additionally study the imprecision of the method. This pool was prepared from residual serum sent for standard clinical chemistry analyses from patients, treated with caspofungin. Aliquots of quality control samples,

calibrators and serum pool were stored in polypropylene vials at -80°C.

In 11 analytical series, applying full calibration, we demonstrated mean accuracy ranged from 94.0% to 97.3% and coefficients of variation (CV) below 8% (complete data is shown in online data Supplemental Appendix 2). The coefficient of determination of the seven calibrator samples was >0.99 ( $R^2$ ) in all series (average y-intercept and slope values:  $y=1.01x-0.03157$ ).

Lower- and upper limit of quantification (LLOQ, ULOQ) were assessed by analyzing different concentrations of spiked drug-free serum in duplicate in three runs. LLOQ was 0.25 mg/L and ULOQ was 40 mg/L for caspofungin (criterion for acceptance: accuracy of 80%–120%, precision with a CV<20%).

Specificity of the method was demonstrated, when analyzing 50 samples from residual serum of intensive care patients. None of the samples showed peaks in the multiple reaction monitoring (MRM) trace of caspofungin.

Ion-suppression characteristics of the method were assessed by connecting a T-piece between the chromatographic column and the ion source. Using a syringe pump, a pure solution of caspofungin (approx. 1 mg/L) and tylosin (0.1 mg/L) was delivered with a constant flow rate of 10 µL/min into the T-piece. By this post-column infusion, a baseline offset was generated in the MRM-traces of caspofungin and tylosin. At the respective retention times we did not observe any significant variation of this offset upon injection of human serum samples, ruling out relevant ion suppression by residual matrix components.

To verify recovery of the method, aliquots of a serum pool, from patients treated with caspofungin, was spiked with different amounts of caspofungin working solution, resulting in five different concentration ranges. Quantification in the absence and presence of addition of caspofungin working

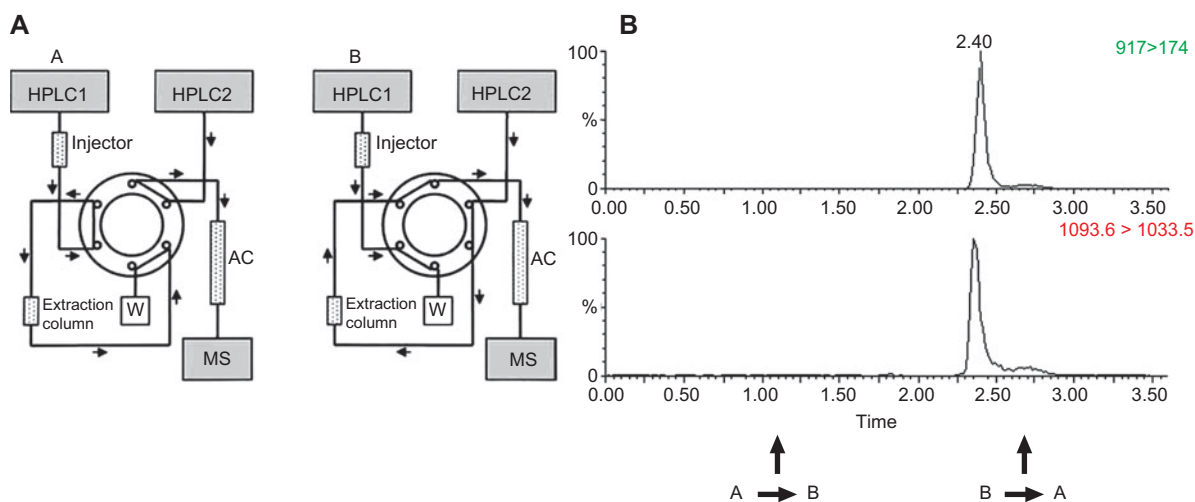

**Figure 1** (A) Scheme of the on-line solid phase extraction system (AC, analytical column; W, waste; MS, mass spectrometry system). (B) Representative MRM chromatograms obtained from a pooled serum sample (caspofungin approx. 2.5 mg/L). Upper panel: tylosin. Lower panel: caspofungin (retention time approx. 2.35 min); total run time: 3.5 min. Arrows indicate switching valve positions.

solution resulted in a mean recovery rate of 92.5% (range: 83.3%–99.3%).

Recovery of the two-step extraction process was evaluated. Samples in three concentration levels were analyzed with and without the on-line SPE procedure. A pure solution of caspofungin in 20% human serum albumin was directly injected onto the analytical column, by omitting the on-line SPE procedure, whereas spiked serum samples in the same concentration levels were submitted to the entire analytical process. A mean signal recovery of 111.7% was found (n=9).

Carry-over was evaluated by injecting the highest QC sample 10 times, immediately followed by a blank sample. The chromatogram of this sample was inspected for peaks in the MRM trace of caspofungin and resulted in a carry-over effect of <1%.

Stability of precipitation extracts was evaluated by reanalysis of deproteinized samples of a calibration series, 24 h after their initial analysis. Extracts obtained by protein precipitation were found stable for at least 24 h – a mean deviation of 105.5% of the peak areas of the MRM trace of caspofungin was noted (n=6).

In this article a convenient LC-MS/MS method for quantification of caspofungin in serum is described; validation data characterize the method as applicable for clinical research use. Regarding previously described LC-MS/MS methods for the quantification of caspofungin in blood, our method is novel with respect to the IS compound and with respect to a convenient semi-automated sample preparation protocol: in three of the previous methods (6–8) an isoster of caspofungin is used as the IS. This compound may be suited, but was obtained from the manufacturer of caspofungin and is not commercially available; thus the method cannot easily be reproduced. Decosterd et al. (9) rely on stable isotope labeled voriconazole for internal standardization. This is questionable as well, since molecular weight and molecular structure of this compound is completely different from that of caspofungin. The compound tylosin, however, has a heterocyclic structure, as is the case for caspofungin, and a similar molecular weight (see online data Supplemental Appendix 3). It is commercially available and not in use in human medicine, but exclusively in veterinary medicine. Therefore, we considered tylosin to be a good candidate for use as IS; this was confirmed by our validation results. Egle et al. (10) completely abdicate the use of an IS, which is very uncommon in clinical mass spectrometry. Also, a complex and fully automated LC-ion trap MS method for caspofungin quantification in serum, which requires two switching valves, two gradient HPLC pumps, a complicated chromatographic set-up and very extended chromatographic run times is described. In our experience, such application of crude serum to on-line extraction cartridges may be convenient but is hampered by the very limited life time of the extraction materials. Applying protein precipitation prior to simple on-line SPE, an extended performance of the extraction columns and – compared to direct analysis of deproteinized samples to HPLC – very good ionization efficacy is guaranteed.

In agreement with previous articles, we identified three particular problems for quantification of caspofungin using

LC-MS/MS: linearity of response over a wider calibration range (6–8, 10); adsorption of the analyte to surfaces (7, 11–13); and asymmetrical peak shape due to isomers of the analyte (8, 10). Regarding linearity issues we found dilution with PBS necessary to obtain acceptable calibration functions. Adsorption problems as carry-over issues should be addressed by rather long washing cycles and high proportions of organic solvents. Sub-optimum peak shape due to isomers (as demonstrated in Figure 1) requires consistent peak integration criteria.

In summary we suggest the use of tylosin as an IS together with on-line SPE after protein precipitation as an alternative for quantification of caspofungin in blood using LC-MS/MS.

## Conflict of interest statement

**Authors' conflict of interest disclosure:** The authors stated that there are no conflicts of interest regarding the publication of this article.

**Research funding:** None declared.

**Employment or leadership:** None declared.

**Honorarium:** None declared.

## References

1. Smith J, Andes D. Therapeutic drug monitoring of antifungals: pharmacokinetic and pharmacodynamic considerations. *Ther Drug Monit* 2008;30:167–72.
2. Andes D, Pascual A, Marchetti O. Antifungal therapeutic drug monitoring: established and emerging indications. *Antimicrob Agents Chemother* 2009;53:24–34.
3. Eschenauer G, Depestel DD, Carver PL. Comparison of echinocandin antifungals. *Ther Clin Risk Manag* 2007;31:71–97.
4. Stone JA, Holland SD, Wickersham PJ, Sterrett A, Schwartz M, Bonfiglio C, et al. Single- and multiple-dose pharmacokinetics of caspofungin in healthy men. *Antimicrob Agents Chemother* 2002;46:739–45.
5. Keating GM, Jarvis B. Caspofungin. *Drugs* 2001;61:1121–9.
6. Chavez-Eng CM, Schwartz M, Constanzer ML, Matuszewski BK. Determination of a cyclic hexapeptide, a novel antifungal agent, in human plasma by high-performance liquid chromatography with ion spray and turbo ion spray tandem mass spectrometric detection. *J Chromatogr B Biomed Sci Appl* 1999;721:229–38.
7. Rochat B, Bolay S, Pascual A, Calandra T, Marchetti O. Liquid chromatography-mass spectrometry method for quantification of caspofungin in clinical plasma samples. *J Mass Spectrom* 2007;42:440–9.
8. Farowski F, Cornely OA, Vehreschild JJ, Hartmann P, Bauer T, Steinbach A, et al. Quantitation of azoles and echinocandins in compartments of peripheral blood by liquid chromatography-tandem mass spectrometry. *Antimicrob Agents Chemother* 2010;54:1815–9.
9. Decosterd LA, Rochat B, Pesse B, Mercier T, Tissot F, Widmer N, et al. Multiplex ultra-performance liquid chromatography-tandem mass spectrometry method for simultaneous quantification in human plasma of fluconazole, itraconazole, hydroxyitraconazole, posaconazole, voriconazole, voriconazole-N-oxide, anidulafungin, and caspofungin. *Antimicrob Agents Chemother* 2010;54:5303–15.
10. Egle H, Trittler R, Kümmerer K. An advanced double column-switching technique (LC-LC) for liquid chromatography/electrospray ionisation tandem mass spectrometry for fully automated

- analysis of caspofungin. Rapid Commun Mass Spectrom 2004;18:2871–7.
11. Neoh CF, He H, Li J, Fullinaw RO, Leung L, Misra A, et al. Rapid and sensitive liquid chromatography/mass spectrometry assay for caspofungin in human aqueous humor. Antimicrob Agents Chemother 2010;54:4467–70.
  12. Schwartz M, Kline W, Matuszewski B. Determination of a cyclic hexapeptide (L-743 872), a novel pneumocandin antifungal agent in human plasma and urine by high-performance liquid chromatography with fluorescence detection. Anal Chim Acta 1997;352:299–307.
  13. Traunmüller F, Steiner I, Zeitlinger M, Joukhadar C. Development of a high-performance liquid chromatography method for the determination of caspofungin with amperometric detection and its application to *in vitro* microdialysis experiments. J Chrom B 2006;843:142–6.

**2.4 Vogeser M, Kirchhoff F.**

**Progress in automation of LC-MS in laboratory medicine.**

**Clin Biochem 2011;44:4-13.**



## Review

## Progress in automation of LC-MS in laboratory medicine

Michael Vogeser\*, Fabian Kirchhoff

Institute of Clinical Chemistry, University of Munich, Munich, Germany

## ARTICLE INFO

## Article history:

Received 29 March 2010

Received in revised form 1 June 2010

Accepted 8 June 2010

Available online 19 June 2010

## Keywords:

LC-MS/MS, Liquid chromatography–tandem mass spectrometry

Automation

Sample preparation

Robustness

## ABSTRACT

**Background:** LC-MS/MS is an almost universal technology for the quantification of small molecules in human sample materials. The widespread use of this technology in laboratory medicine is so far limited mainly by the extensive occupation of highly trained personnel which is required for method implementation and application. Furthermore, robustness of function and results is still a critical issue of routine quantitative applications of LC-MS/MS.

**Content:** This article reviews approaches to the automation of essential processes of LC-MS/MS applications in clinical laboratories. Furthermore, perspectives of further steps towards highly robust and fully automated LC-MS/MS methods and instrument configurations are discussed.

**Conclusions:** There is a variety of efficient approaches to automation of LC-MS/MS methods in use which mainly address sample preparation. Such configurations allow a substantial increase of sample throughput and convenience when compared to standard protocols. However, these applications still have to be implemented for individual methods in heterogeneous instrument configurations and still require highly trained experts. Based on existing technologies, however, the development of fully automated LC-MS/MS front-end modules or MS/MS-based analyzers which offer a degree of user-friendliness and robustness similar to current standard clinical chemistry analyzers seems feasible today. Only such systems will make the entire analytical potential of LC-MS/MS amenable to clinical medicine also outside from tertiary care centres.

© 2010 The Canadian Society of Clinical Chemists. Published by Elsevier Inc. All rights reserved.

## Contents

Introduction . . . . .	5
Characteristics of current standard LC-MS/MS applications . . . . .	5
Scope of automation . . . . .	6
Automation of sample preparation. . . . .	6
Requirements of sample preparation in LC-MS/MS . . . . .	6
Basic principles of sample preparation . . . . .	6
Automated liquid handling systems . . . . .	7
Automated protein precipitation (PPT) . . . . .	7
Automated protein filtration . . . . .	7
Automated solvent extraction . . . . .	7
Automated solid phase extraction . . . . .	7
On-line solid phase extraction . . . . .	8
Automated off-line solid phase extraction . . . . .	8
Emerging techniques of sample preparation . . . . .	9
Robustness and reliability. . . . .	9
Productivity and throughput . . . . .	10
Goals for comprehensive automation . . . . .	10
Future of LC-MS/MS application in laboratory medicine. . . . .	11

*Abbreviations:* IVD, *in-vitro* diagnostics; LC-MS/MS, liquid chromatography–tandem mass spectrometry; LLE, liquid–liquid extraction; MTP, micro titer plate; PPT, protein precipitation; SPE, solid phase extraction, TFC, turbulent flow chromatography; TFC, turbulent flow chromatography.

\* Corresponding author. Institute of Clinical Chemistry, Hospital of the University of Munich, Munich, Germany, Marchioninstr. 15, D-81377 Munich, Germany. Fax: +49 89 7095 6220.

*E-mail address:* [Michael.Vogeser@med.uni-muenchen.de](mailto:Michael.Vogeser@med.uni-muenchen.de) (M. Vogeser).

Summary and conclusions . . . . .	11
References. . . . .	11

## Introduction

Standard techniques of analyte detection in clinical chemistry rely on indirect characteristics of an analyte, e.g. its absorption of light, chemical reactivity or physical interaction with macro-molecules. In mass spectrometric methods, in contrast, analytes are detected directly from molecular characteristics as molecular mass and molecular disintegration patterns. Thus, mass spectrometric techniques are very attractive for the quantification of biomarkers or xenobiotics in the context of diagnostic procedures, since those techniques can enable analyses of much higher specificity compared to standard technologies such as photometry or ligand binding tests. With gas chromatography–mass spectrometry (GC–MS), first mass spectrometric methods were introduced to laboratory medicine about 40 years ago. GC–MS allowed the highly specific and sensitive quantification of thermo-stable molecules below a molecular weight of about 500. Thus, GC–MS became a key technology, e.g. in toxicology. With respect to standardisation and quality assurance of small molecule analytical routine methods the introduction of GC–MS as a reference method was an essential progress, in particular for endocrinology. However, for several reasons the application of GC–MS remained restricted to few specialized institutions in laboratory medicine (mainly toxicological laboratories, metabolism centres, and reference laboratories). The handling and maintenance of GC–MS instruments is very demanding and time-consuming; sample preparation is very laborious and includes sample extraction and analyte derivatization; the analytical run times are long with a typical sample throughput of less than 50 samples per *day*.

The introduction of atmospheric pressure ionisation techniques about 20 years ago made practically all potential bio-medical analytes amenable for mass spectrometry. Furthermore, powerful new technologies of ion-analyses (tandem mass spectrometry, time-of-flight mass spectrometry, ion-trap mass spectrometry) substantially increased the capabilities of MS analyzers with respect to specificity and to the extent of data read-out in the 1990s. These developments suggested a widespread use of mass spectrometric methods in routine laboratory medicine.

In particular tandem mass spectrometry (MS/MS) instruments hyphenated to liquid chromatography (LC) systems used for sample introduction and pre-fractionation have been implemented in a constantly growing number of clinical laboratories worldwide now [1]. These instruments are mainly used for small molecule analyses in neonatal screening of inborn diseases of metabolism and therapeutic drug monitoring but also in endocrinology and toxicology, while applications for peptide and protein quantification are not yet used in routine laboratories.

LC-MS/MS is attractive for laboratory medicine for three main reasons.

- the development of new methods is in general straightforward and independent from the diagnostic industry, without the need e.g. to develop analytical antibodies
- highly multiplexed analyses are feasible with very low current costs; the range of potential analytes is practically unlimited; individual “metabolomic analyses” addressing hundreds of analytes from different biochemical pathways and from different chemical classes are possible, as well as a comprehensive and individual description of xenobiotics (“xenobiom”).
- when applying the principle of isotope dilution internal standardisation, analyses on a reference method-level of accuracy can be performed in a routine laboratory setting.

## Characteristics of current standard LC-MS/MS applications

When compared to contemporary clinical chemistry or immunoanalyzer systems, however, the practicability and also the robustness of standard LC-MS/MS configurations is still poor. A multi-step preparation of diagnostic samples – mainly aiming to remove macromolecules – is required; preparation of samples typically includes manual labelling of several secondary tubes; manual data input to sample list is necessary; individual inspection of chromatograms is necessary as well as the manual transfer of results to a laboratory information management system (LIMS); instrument handling includes open manipulation of toxic compounds and several subsystems of the instrument configuration have to be monitored (solvent and oil levels, gas flows, temperatures). Maintenance procedures and trouble shooting in LC-MS/MS instruments are typically poorly standardized and can be a substantial challenge for the user. LC-MS/MS methods have to be developed and/or implemented by the end-user to very heterogeneous instrument configurations. This also includes minute supervision of the assay performance. Typically far longer down-times must be expected in case of technical problems compared to contemporary clinical chemistry analyzer applications. Consequently, for method implementation and support, highly trained personnel are required in a clinical laboratory if an acceptable degree of robustness has to be maintained.

LC-MS/MS today holds enormous potentials for improvements in laboratory medicine (mainly in therapeutic drug monitoring, endocrinology, toxicology, and metabolomic analyses) but the features of standard instruments are at present hardly compatible with the workflow of contemporary *standard* clinical laboratories. Development of solutions for extensive automation is clearly the key to a widespread application of LC-MS/MS in laboratory medicine in the future.

Most of the developments in LC-MS/MS automation originated from applications in the pharmaceutical industry [2–6]. In this field, LC-MS/MS has become a key technology for pharmacokinetic studies and on all levels of drug development. Typically large series of samples have to be analyzed for single drug candidates on a *good laboratory practice* (GLP) level. Consequently, automation in pharmaceutical industry targets extended batch analyses. In pharmaceutical research laboratories but also in environmental and food testing laboratories typically highly trained technicians are available and the number of different analytical technologies is small. In clinical laboratories, in contrast, the availability of skilled technicians is increasingly a critically limited resource in many countries. Consequently, the need for automation is far more pronounced in medical diagnostics application of LC-MS/MS when compared to “traditional” main areas of application of this technology.

In different clinical laboratory MS units’ work-flows and the range of applications are quite heterogeneous. In commercial referral laboratories, large series for few analytes may be typical (e.g., 25-hydroxyvitamin D, plasma metanephriins, androgens, immunosuppressants, methylmalonic acid). Often one instrument system is permanently used for one method. Since turnaround time is less critical in these cases, analyses can be run in a batch mode which can favourably be automated with generic liquid handling systems in a micro titer plate (MTP) format, similar to applications in drug development. In hospital laboratories, in contrast, a far wider range of parameters is typically intended to be quantified using a limited number of LC-MS/MS instruments and within a short turnaround time (in particular with respect to therapeutic drug monitoring). It is generally desired to develop generic methods for a class of analytes



(mainly characterized by the degree of polarity), however switching between methods (including solvents and columns) is typically necessary in such a setting. In particular, such change of methods impairs the work-flow and is prone to down-times. Thus, it is evident that the requirements for automation differ substantially between hospital laboratories and commercial medical laboratories. While the concept of a paralleled batch-processing is appropriate for referral laboratories, for hospital laboratories automation aiming to a random-access, multi-channel work-flow is clearly preferable.

### Scope of automation

Automation has to address a number of different processes in laboratory medicine application of LC-MS/MS; this includes management of primary samples, assay-specific work-up of samples prior to actual MS analysis, integrated control of the subunits of LC-MS/MS systems, processing of primary read-outs, and further handling of result data.

During recent years it has become evident that most and even all of these issues can be subject to automation.

Besides (and beyond) reducing manual work-load, automation in LC-MS/MS also aims to increase the reliability of results by avoiding gross errors.

Solutions for automation in LC-MS/MS are so far predominantly home-made and based on generic components (e.g., liquid handling robotic systems, switching valves, autosamplers) while dedicated systems for this aim are hardly commercially available at present. Solutions of automation are applied in a growing numbers of laboratories and were successful in increasing the throughput. However, automation has still not yet overcome the fact that LC-MS/MS is applicable only in rather few, highly specialized clinical laboratories to date.

Partial Automation of HPLC analyses has long been established by introduction of autosamplers which inject defined volumes of sample extracts and by introduction of programmable gradient pumping systems which modify the composition of the mobile phase during an analytical run. These components are still important for reliable results. In particular potential carry-over of autosamplers has to be addressed. Beyond autosamplers, without doubt most efforts of automation in clinical LC-MS/MS have so far addressed sample preparation for batch analyses [7].

In the following sections we will describe the now widely used tools of automation in sample preparation, as well as emerging techniques. Further on we will discuss the perspective of fully automated LC-MS/MS systems which might become compatible with the work-flow and characteristics of today's standard clinical laboratories in the future.

### Automation of sample preparation

#### *Requirements of sample preparation in LC-MS/MS*

So far, application of LC-MS/MS in clinical chemistry involves to the quantification of small molecules in blood and urine while analysis of peptides and proteins is a future perspective. Thus, in present methods a key requirement of sample preparation is to remove peptides and proteins from the sample. Peptides and proteins are incompatible with standard chromatographic set-ups since HPLC columns would be blocked after few injections [5]. Furthermore, peptides tend to interfere with atmospheric pressure ionisation by occupying protons and generate substantial background "noise".

Beyond de-proteinization, sample preparation for LC-MS/MS aims to deplete further compounds which impair the ionisation of target analytes (e.g., salts, polar compounds as amino acids) and to deplete compounds which cause unspecific signals (such as phospholipids). For many analytes of low abundance, sample preparation aims to

concentrate the analyte in order to decrease lower limits of quantification; while for other analytes dilution is necessary (in particular when using high-end analyzers) in order to avoid saturation effects of detection and non-linearity. Removal of salts also minimizes contamination of the ion source and is thus relevant for robustness.

During a decade of LC-MS/MS application in the clinical laboratory the preferences for the purity of samples injected to the LC-MS/MS system has changed to some degree. In the earlier years a straightforward "dilute-and-shoot" approach was widely approved. Now an efficient and selective sample preparation is more and more advocated which substantially limits ion-suppression effects. On the other hand, with increasing sensitivity of MS/MS detectors, concentration of target compounds during sample preparation becomes necessary for a decreasing number of analytes. Efficient removal of proteins (beyond the efficiency of simple protein precipitation) also becomes increasingly important with respect to the lifetime of innovative sub-3 µm columns. These columns enable highly efficient chromatographic fractionation, but are easily blocked by residual proteins.

A less stringent sample preparation may be tolerable with respect to ion suppression if extended chromatography is applied; on the other hand, very selective sample preparation can potentially reduce the demands of chromatographic fractionation in some LC-MS/MS applications. Thus, sample preparation and chromatographic fractionation of a method interact and should be looked upon as one functional system.

The evident final goal for the automation of sample handling and preparation in LC-MS/MS is evidently to allow the introduction of crude serum or plasma, whole blood (where necessary) or urine into a hyphenated sample preparation/LC-MS/MS systems with no need for any further manual intervention. Centrifugation and de-capping of primary blood sampling containers is done by use of a central pre-analytic automate in many laboratories now; thus, introduction also of these very essential steps of laboratory sample management into a LC-MS/MS pre-analytic module does not seem useful.

#### *Basic principles of sample preparation*

Four main principles of sample extraction are applied in liquid chromatography: Protein precipitation (PPT) (by addition of organic solvents, inorganic acids and/or chaotropic salts); protein filtration; solvent extraction (syn. liquid-liquid extraction, LLE); and solid phase extraction (SPE).

Protein precipitation is straightforward, but does not allow concentration of the analytes; instead, typically a dilution of at least 1:2 is obtained. Typically not a very high degree of protein removal is achieved. Solvent extraction and solid phase extraction – based on differential solubility and surface affinity of target analyte and potentially interfering compounds – typically result in very clean extracts; ion-suppression effects due to residual matrix components are reduced with solvent extraction and solid phase extraction compared to mere protein precipitation [8,9]. While LLE is predominantly based on differential polarity, a variety of different extraction surfaces is available for SPE (such as carbohydrates (C2, C8 and C18), ion exchange materials [10,11], phenylic groups, amino groups, copolymer mixed mode materials [12], immobilized on particles packed in cartridges). Therefore, SPE can address much more specifically molecular characteristics of target analytes and allows the design of protocols which are far more analyte specific compared to LLE. Consequently, the principle of SPE is the most versatile method to be used for sample preparation. SPE materials can have added particular functions, as removing of phospholipids. Both LLE and SPE allow up to ten-fold concentration of analytes; however, these methods are technically far more demanding compared to PPT. The optimum choice of one of the four main principles of sample preparation is

specific for the respective analyte but also for the individual MS/MS system.

While automated solvent extraction is rarely used in clinical LC-MS/MS applications, automated solid phase extraction (SPE) is widely used now. SPE materials can be packed in single use cartridges, in single use 96 position arrays or they can be packed within permanently used extraction cartridges used for *on-line* SPE. In many applications precedent protein precipitation is combined with SPE, in particular with *on-line* SPE.

“Paralleling” automated sample preparation protocols in 96 position arrays – based on protein precipitation, protein filtration, or SPE – result in batching of analyses, which is useful for some settings, as mentioned above. However, in many hospital laboratory applications of LC-MS/MS, a sequential, sample-by-sample approach of automation is preferred. For such an aim – e.g. in therapeutic drug monitoring with desired short turnaround times – *on-line* SPE after preceding protein precipitation using single vials is often applied now.

#### Automated liquid handling systems

Paralleled sample preparation solutions for LC-MS/MS based on 96-position arrays can be operated manually (as is the case for ELISA tests in most laboratories) but are typically run on generic liquid handling robotic systems. Such instruments are configured to prepare extracts into a secondary sample carrier which is then manually transferred into the autosampler of the LC-system, representing an “off-line” solution. This approach is discontinuous but has the strength that one sample preparation module can potentially be used for several LC-MS/MS systems. Respective robotic platforms are available from a number of companies (e.g., Tecan (<http://www.tecan.com>), Hamilton (<http://www.hamiltoncompany.com>), Gilson (<http://www.gilson.com>), PerkinElmer (<http://www.perkinelmer.com>), Zinsser (<http://www.zinsser-analytic.com>), Beckman Coulter (<http://www.beckmancoulter.com>)). They represent “open” systems, allowing flexible configuration of many different devices (e.g., bar code readers, vacuum stations, pipette arms, grippers for micro titer plates, shaker). Such platforms are widely used for ELISA handling or in the context of blood banking. Also for the processing of LC-MS/MS batch analyses comprehensive liquid handling systems have been used for more than a decade now, particularly in the field of drug development. Advanced autosampler systems with robotic components are also increasingly used for sample preparation procedures (e.g., from CTC PAL (<http://www.ctc.ch>) or Gerstel (<http://www.gerstel.com>)).

Robotic liquid handling systems for sample preparation typically also perform addition of the internal standard solution into a sample aliquot, but potentially also bar code reading of primary tubes and generation of a sample list [13] (Fig. 1).

Direct coupling of a sample preparation module with the LC-MS/MS system potentially also allows automated sample injection and a “walk-away” mode of working [14,15].

In the following sections the different strategies of automated sample preparation are discussed.

#### Automated protein precipitation (PPT)

For manual handling, protein precipitation is the most convenient technique of sample preparation. After addition of the internal standard solution and addition of a precipitation liquid (e.g., methanol, acetonitrile, zinc sulphate and perchloric acid) the sample is centrifuged for several minutes in a bench-top centrifuge (at >10000 g) and a water-clear extract is obtained. Full automation of protein precipitation, however, is difficult, since a centrifuge has to be incorporated into a sample preparation module [16]. However, automated transfer of sample aliquots from primary tubes into a MTP, automated addition of internal standard and precipitation

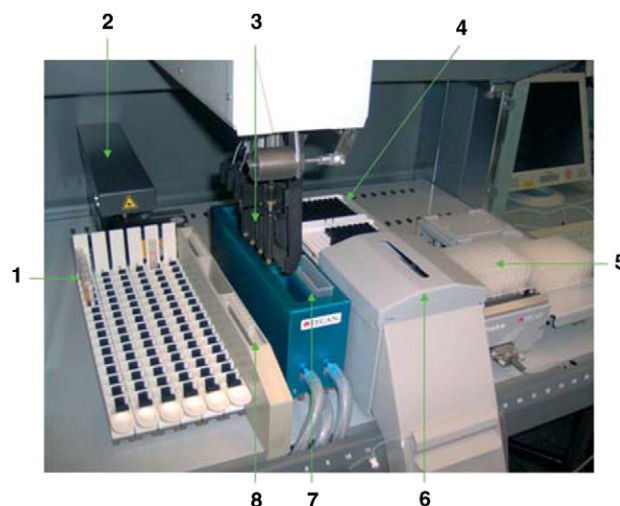

**Fig. 1.** Automated liquid handling system employed for sample preparation for LC-MS/MS. Worktable of the Tecan Freedom EVO pipetting system. 1, sample trays with decapped whole-blood samples; 2, barcode reader; 3, liquid handling arm with four pipette carriers; 4, disposable pipetting tips; 5, 96-position 2-mL deep-well plate on a horizontal shaker; 6, dropping station for used pipette tips; 7, chilled reagent troughs (internal standard and precipitation solution, respectively); and 8, washing station. from [13].

cocktails for subsequent off-line centrifugation and transfer of the MTP to an autosampler is an attractive option for batch analyses [13,16,17,18]. Notably, only few types of centrifuges allow centrifugation of MTPs on g-levels which are required for efficient deproteinization of plasma samples.

#### Automated protein filtration

Protein filtration – with or without prior addition of protein precipitating fluids – can be automated when applying vacuum or positive pressure to filtration cartridges. Proteins are retained by single use filtration membranes, and protein free filtrate is collected. Such protocols are typically applied in a 96-array plate format [19]. In contrast to protein precipitation, automated removal of proteins can be achieved without manual intervention (as is required for the transfer of plates into a centrifuge when applying protein precipitation). However, the expenses for single use protein precipitation plates are relevant.

#### Automated solvent extraction

Also solvent extraction can be subject to automation, albeit with substantial effort [20]. Respective methods are mainly used in food and environmental analyses where large and inhomogeneous sample volumes (e.g., soil samples) have to be processed. Recent modifications of solvent extraction use gel-like materials (immobilized liquid extraction) with a perspective of more straightforward automation.

#### Automated solid phase extraction

The most widely used principle for automated sample preparation in LC-MS/MS is so far solid phase extraction (SPE). Such methods can be based on single use extraction cartridges (Gilson, Aspec); on extraction plates in a microtiter plate format; on permanently used extraction cartridges within the HPLC system (also referred to as *on-line* solid phase extraction, or two-dimensional LC); and on ferromagnetic micro-particles. If crude serum or plasma without previous protein precipitation is applied to SPE materials, a re-use of extraction devices is usually not possible. If deproteinized samples are

applied, SPE material can potentially be re-used; in case of on-line SPE for up to thousands of analytical cycles.

SPE protocols include the following steps: activation and conditioning of the extraction material, e.g. by an organic solvent followed by water; application of the sample with adsorption of the target analytes; washing of the loaded extraction material; elution of the extract; in case of re-use, washing and re-equilibration of the extraction material. A wide range of SPE materials is available today and a highly efficient extraction protocol can be tailored for practically all analytes by optimizing the content of organic solvents, pH or ion strength.

*On-line solid phase extraction*

On-line solid phase extraction after precedent protein precipitation is the most simple and probably the most widely used approach of automation in clinical LC-MS/MS application at present. In most cases an additional isocratic HPLC pump and a six-port high-pressure switching valve is used together with an extraction column [21,22], but more sophisticated configurations are used as well [23]. Deproteinized sample is injected by the autosampler onto the extraction column in a flow of mobile phase containing a low proportion of organic solvent. Here the analytes are retained; residual polar matrix components (amino acids and salts) are not retained and are washed into the waste. Using the switching valve, the flow of the additional pump containing a high proportion of organic solvent is directed onto the extraction column in a back-flush. Thus, the analytes are eluted from the extraction column and are transferred to the analytical column of the chromatographic set-up (Fig. 2). Such a configuration requires connection of tubing according to a relatively complex scheme, and the control of the switching valve by the chromatography software. In addition, one additional reservoir of mobile phase has to be handled. However, once implemented, the use of on-line SPE is convenient.

An on-line SPE cycle typically takes about 30 to 60 s of additional analysis time per sample. Short standard C-18 columns can be used as the trap column, but in most cases dedicated on-line SPE columns are used. Modern polymeric materials, and also co-polymer materials with a polar and an apolar constituent allow a wide range of applications [24–28]; also ion exchange materials are available [10,11,29].

A variant of on-line SPE applies the principle of turbulent flow chromatography (TFC); very high flow rates generate specific distribution effects dependent on the molecular size of components on restricted access materials which can result in favourable clean-up properties [30–34]. Applications for the direct injection of serum or plasma have been described for TFC [35] but also for other SPE materials [36]; however, the lifetime of the extraction columns is in

general extended substantially by use of deproteinized samples instead of crude serum.

Very high back-pressures in UPLC were first considered to be a problem for on-line SPE configurations, however, respective solutions have been described now [37].

The improvement in robustness and sensitivity – by reducing ion-suppression – achieved by on-line SPE for sample clean-up may be substantial for some analytes and some analyzers, or may as well be marginal for others. There are few published data on direct comparison of methods applying mere protein precipitation compared to methods applying on-line SPE [38].

The additional analysis time of typically 1 min required for on-line SPE can be considered substantial with short overall analysis times of about 3 min in many assays now. Furthermore, additional highly pure and expensive liquids have to be used. An additional pump and the switching valve introduce further potential sources of technical failures when compared to methods with simple (one-dimensional) chromatography of deproteinized samples. Many modern API ion sources can be removed and cleaned very easily causing minimal down-time; therefore, more pronounced source contamination found when *not* applying additional clean-up after protein precipitation can be accepted by many users.

Nevertheless, on-line SPE is a standard method in many laboratories today. Recently commercial LC-MS/MS assay kits for the quantification of 25-hydroxyvitamin D and of immunosuppressant involving on-line SPE have been introduced (Chromsystems, Munich, Germany).

*Automated off-line solid phase extraction*

On-line SPE requires only little additional instrumentation but allows only partial automation by substituting manual extraction procedures. Automated off-line SPE, in contrast, can realize a far higher degree of automation but requires a robotic liquid handling system [3,4,39,40].

A typical work-flow protocol includes bar code reading of serum or plasma sample tubes; (potentially re-suspension of whole blood samples); transfer of a sample aliquot into a MTP well; addition of the internal standard solution to the well; mixing; conditioning of the extraction material (single cartridge or cell in a 96-position array); application of sample spiked with the internal standard to the SPE material; paralleled washing; paralleled elution of the extract from the extraction material into a second MTP, which can be sealed for subsequent LC-MS/MS analysis. In most systems 4 to 8 pipetting channels are operated. Vacuum or positive pressure has to be applied to achieve a sufficiently speedy transfer of fluids through the SPE

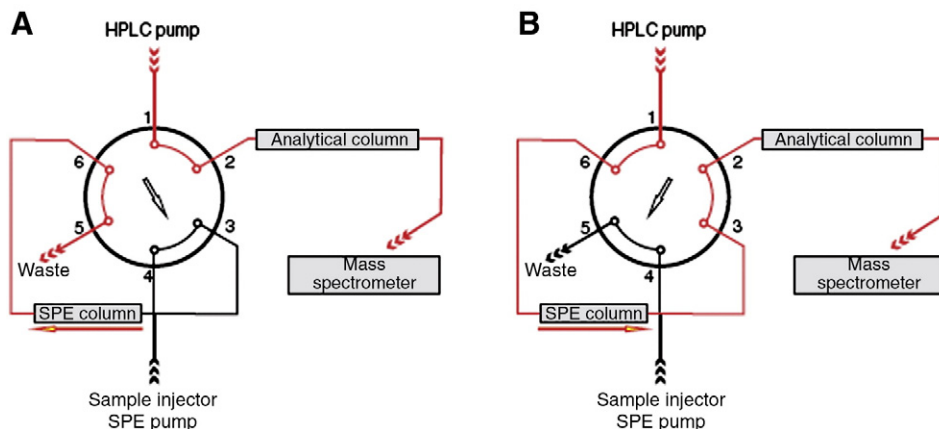

**Fig. 2.** Typical on-line solid phase extraction configuration. Plumbing of the six-port switching valve located in the column compartment and connecting the SPE and HPLC chromatography step. (A) In the load sample position of the valve (right, 1 → 2), the specimen aliquot delivered from the autosampler with the solvent flow from the SPE pump (yellow arrow) is flushed onto the first chromatographical stationary phase (SPE column). (B) In the elute sample position of the valve (left, 1 → 6), the specimen fraction adsorbed onto the SPE material is eluted with the HPLC solvent (yellow arrow) and transported through the second chromatographical stationary phase (HPLC column) to the MS/MS detector. from [66].

materials, which is technically demanding. Fixed steel needles or single use disposable tip solutions are available. The costs per sample for single use extraction materials are in the range of 2–4 Euro.

“Off-line” SPE can be convenient for batch analyses of large series which do not require short turnaround time for *individual* samples. Without doubt, implementation and programming of a sample preparation module requires experts, while the daily handling can be reduced to few simple interventions as re-filling of liquids and consumables, removing waste, and handling of the plates.

The off-line SPE approach using liquid handling instruments still represents incomplete automation as long as MTPs containing the sample extracts have to be transferred from the liquid handling system to the HPLC autosampler by an operator. A direct coupling of a pre-analytics module directly with a LC-MS/MS instrument is feasible as well, either by a dedicated systems, as realized by the Spark Symbiosis system (Spark Holland, The Netherlands) [14,15]; or by implementing a HPLC injection valve onto a generic liquid handling system [41].

The Spark Symbiosis system should be mentioned here as the most sophisticated instrument for complete automation of sample preparation for LC-MS/MS today. It employs very small cartridges available containing a variety of defined extraction materials. However, the system primarily aims to the analysis of research samples in micro-vials and is not yet useful for the direct application of standard sample containers as used in clinical laboratories.

A wide range of different sample preparation protocols at present is in use in clinical LC-MS/MS laboratories, from mere manual, non-automated protein precipitation using centrifugation of single samples and direct transfer of single vials to the LC-MS/MS system or direct analysis of urine [42], over semi-automated on-line SPE protocols, to almost completely automated SPE for large batches in 96-well arrays. From the viewpoint of practicability, the first and very simple non-automation protocol avoids additional instruments with their inherent sources of malfunctions and enables de-batching which may be important in the work-flow of many clinical laboratories [43]. The use of a liquid handling system in contrast usefully requires batching, resulting in extended turnaround times for an *individual* sample. However, for applications where the turnaround-time (within a range of 24 h) is less relevant – as for steroid or vitamin analyses – batching is clearly preferable and a liquid handling system can certainly limit the occupation of personnel to a substantial degree and help to avoid gross errors in sample preparation as for example mixing-up of samples.

For most of the typical LC-MS/MS applications in laboratory medicine fully or partially automated protocol have been described and are in use (Table 1). Besides peer reviewed journals, application notes of LC-MS/MS manufacturers can be a useful source of information about automated LC-MS/MS methods for individual analytes.

#### Emerging techniques of sample preparation

While SPE in a 96 position array, protein precipitation in an array, and on-line solid phase extraction is used in many clinical MS

laboratories now, several further methods of sample preparation may become useful for clinical LC-MS/MS applications in the future. Some of them are already in use, e.g. in environmental and food analyses.

Solid phase extraction materials can be packed into pipetting tips; the steps of solid phase extraction can be performed within these tips by automated pipetting of sample, washing solution and finally elution medium with direct injection of the eluate into an injection port (*ZipTip* principle; Millipore (<http://www.millipore.com>) [44]).

A clear separation between sample preparation and chromatographic fractionation can indeed be overcome. For the Nanomate System from Advion (<http://www.advion.com>) [45] an application for immunosuppressant quantification is described with automated clean-up of the haemolysed samples by chromatographic zip-tips and direct injection to an 400 nozzle nano flow-ESI chip source without further chromatographic separation (application note).

Solid phase extraction materials can be packed in permanently used syringes of autosamplers as well. This principle is also referred to as solid phase micro extraction (SPME) or microextraction by packed sorbents (MEPS) [46–50]. Respective methods can be implemented in modern high-end autosampler devices (e.g., CTC PAL) and may represent an alternative to on-line SPE.

Ferromagnetic micro-particles with modified surfaces (e.g., C-18 material) might be interesting for the automation of sample preparation for chromatographic methods as well [51]. Such particles represent a solid phase, however, can be handled in a suspension as a liquid. The use of such particles in mass spectrometry might parallel the achievements in the automation of heterogenous immunoassays which also require a convenient handling of solid phases. Ferromagnetic particles may also be handled within a HPLC system [52].

Approaches of sample preparation for mass spectrometry also include miniaturized “lab-on-the-chip” solutions, as realized by Agilent (<http://www.agilent.com>) for microfluidic applications [53].

#### Robustness and reliability

In general, today's MS/MS detectors – representing the core unit of the entire LC-MS/MS analytical configuration – are very robust components. Given appropriate sample clean-up (e.g., protein precipitation followed by on-line SPE), quite simple maintenance of the MS/MS analyzer is typically required only after several thousands of samples. In this respect, LC-MS/MS systems even offer superior robustness compared to standard clinical chemistry analyzers. However, technical malfunctions (such as a failure of a pre-vacuum rotary pump) sometimes cause down-times of several days, since the response time of MS/MS manufacturers' service centres is typically far longer compared to the service of standard laboratory analyzers in most regions. Consequently, for clinical LC-MS/MS applications a back-up instrument is in most cases inevitable. Interestingly, in the experience of most users, clearly the majority of system malfunctions is related to the HPLC module and not to the MS/MS core unit.

The individual practice of sample preparation determines the degree of instrument contamination. Straightforward simple protein precipitation typically requires more frequent cleaning of the instrument and thus down-times, while extensive sample clean-up minimizes the need for interventions.

Protocols for a standardized assessment of the robustness of LC-MS/MS instruments and of analyte specific assay solutions have not been published so far. In manufacturers commercials often the peak areas of compounds observed over hundreds of sequential injections are shown in order to demonstrate the robustness of an instrument or an application. More relevant, however, would be data about the frequency of interventions needed to maintain a defined signal-to-noise ratio for exemplary analytes in relation to the number of samples analyzed over periods of weeks and months.

Technical optimisation of standard maintenance interventions typically performed by the user should be a general aim for the

**Table 1**

Examples of automation protocols for analytes which are quantified using LC-MS/MS in many laboratories.

Analyte	References
17-hydroxyprogesterone	[67]
25-hydroxyvitamin D	[25,34,68,69]
Androgens	[32,70]
Antimycotic drugs	[26,27]
Antiretroviral drugs	[15,71]
CNS active drugs	[31,72,73]
Drugs of abuse	[74,75]
Immunosuppressants	[24,33,66,76–78]
Metanephrins	[10]
Methylmalonic acid	[79]

construction of future instruments. This is in particular related to the cleaning of source components and to the exchange of electrospray capillaries.

Robustness of an analytical technology does on the one hand refer to function and down-times but on the other hand refers to analytical reliability. LC-MS/MS-specific potential sources of inaccuracy include interference by in-source transformation of conjugate metabolites [54], interference by isobaric compounds [55], and bias due to differential impact of ion-suppression or enhancement on target analyte and internal standard [56]. Sufficient pre-fractionation and reduction of the samples' complexity prior to analysis (involving both sample preparation and chromatography as a functional unit) is of essential importance to control such effects and to obtain analytical robustness. It must be noted, however, that the degree of pre-fractionation which is necessary to obtain reliable and robust results is dependent on the individual target analyte; it is determined e.g., by presence or absence of conjugate metabolites or isomers and by the susceptibility to matrix effects on the ionisation using a given individual MS/MS instrument.

Besides specific analytical issues, the reliability of results obtained from an analytical system also depends on the robustness towards gross handling errors. With this respect automation of the pre-analytical part of LC-MS/MS methods is clearly of essential importance. All manual operations (such as labelling of secondary tubes for manual protein precipitation, transfer of vials into a defined autosampler position or creating a sample list) are prone to errors such as mixing-up. It must be assumed that at present the risk of gross errors is much higher in LC-MS/MS when compared to standard clinical chemistry analyzer. Automation of the entire analytical process beginning with a bar code reading of primary tubes' identification until data transfer from the analytical system to a LIMS is evidently essential to improve the overall robustness of LC-MS/MS methods.

Robustness towards down-times and malfunctions is as well determined by the degree of manual actions. For example, erroneous handling or running out of mobile phase is in our experience one of the most frequent cause of problems and delayed reporting of results in daily routine. A solution with pre-prepared mobile phases supplied in mix-up proof and bar code registered containers and a liquid level detection could avoid down-times necessary for trouble shooting.

Further improvements in the sensitivity of MS/MS analyzers may potentially allow a further reduction of injected sample volumes thus minimizing contamination and improving the robustness. The same may apply for chromatographic methods with very low flow rates, reducing contaminations due to residues in mobile phases [57].

Besides hardware components the robustness and reliability of LC-MS/MS analyses is also determined by the commercial availability of appropriate materials for internal standardisation, calibration, and quality control. In particular the availability of stable isotope labelled internal standard compounds is desirable for all LC-MS/MS applications in laboratory (which typically aim to be quantitative). The more similar the ionisation characteristics of target analyte and internal standard compound are, the more reliable and robust towards matrix effects a method is [8,9]. Indeed, improper calibration and insufficient quality control has discredited LC-MS/MS in the public perception with respect to 25-hydroxyvitamin D quantification [58] but also to immunosuppressant monitoring [59]. Clearly, reference materials are as important for the robustness of LC-MS/MS methods as applies for the current standard techniques of laboratory medicine.

### Productivity and throughput

Compared to standard manual sample preparation protocols automation of sample preparation has clearly the potential to increase the productivity of clinical LC-MS/MS laboratory units. However, besides sample preparation, the analytical run-time of LC-MS/MS itself is an important limitation today. Standard run times are typically

in a range between 3 and 8 min per sample, e.g., for immunosuppressants or 25-hydroxyvitamin D, corresponding to a sample throughput of less than 20 samples per hour. This is a fraction of the sample throughput achieved with immunoanalyzer systems (70–200 samples/h) or clinical chemistry analyzers (>1000 samples/h). Furthermore, changing between different LC-MS/MS assays (e.g. from a method applying on-line SPE to a method which does not allow this approach) is often time-consuming, includes running a new standard series and thus further reduces the daily sample throughput. Thus, technical solutions aiming to increase the sample throughput of LC-MS/MS are of particular interest for laboratory medicine.

Indeed, introduction of UPLC together with latest MS/MS instruments allowing a very fast acquisition of data-points over narrow peaks now enables, e.g. the analysis of immunosuppressants within 1 min. including on-line solid phase extraction [37]. A further interesting approach is paralleled chromatography. An autosampler injects samples onto several analytical columns via a switching valve in an alternating and staggered manner; only during elution of the analyte of interest, the eluate of a respective column is directed via a second switching valve to the MS/MS analyzer [17,60]; alternatively a multiplexed electrospray inlet system (MUX) can analyse the eluate of four columns simultaneously [39,61]. Such elegant solutions can increase the throughput substantially but require much expertise.

Another way to increase the throughput of LC-MS/MS analyses is a paralleled off-line chromatography with collection of fractions [62]. If the fractionation achieved this way is sufficient (e.g., if conjugate metabolites are reliably removed), flow injection of the collected fractions from 96-position arrays without further chromatographic separation can be performed in cycles of few seconds. Such cycle times have been reported for MALDI-MS/MS of drugs from dried spots without chromatographic separation [63].

Innovative and highly specific technologies of mass spectrometric selection may potentially minimize the need for sample fractionation prior to analysis. For example hybrid linear ion-trap instruments enable MS<sup>3</sup> analyses of potentially extremely high specificity. Similarly highly mass specific detection by Fourier-transform mass spectrometry (FT-MS) may minimize the need for time-consuming sample preparation.

### Goals for comprehensive automation

The diverse approaches to automation of LC-MS/MS analyses discussed so far can without doubt help to improve the work of LC-MS/MS units of clinical laboratories. However, on its own, partial solutions e.g. of automated sample preparation do not really address the key problem of LC-MS/MS application in laboratory medicine, namely the limited availability of experts. Also – and in particular – complex high-throughput automation solutions require highly skilled staff which is increasingly a limiting resource in medicine in general. Beyond tertiary care institutions in industrialized countries LC-MS/MS will only become a useful new tool for laboratory medicine if indeed full automation will be reached with systems offering the same degree of user-friendliness as applies for standard clinical analyzers today. Such *plug-and-play* instruments with *ready-to-use* reagent kits must be designed to be operated by ordinarily trained technicians without the need for specialists with academic background on site. It can reasonably be assumed that the development of such systems is feasible for the diagnostic industry, based on the described technical partial solutions. Such systems might be stand-alone analyzers or even become incorporated into clinical chemistry hybrid systems.

Key specification of future *plug-and-play* LC-MS/MS-based clinical analyzer systems should include the following issues:

Random-access mode (with re-calibration on demand); multi-channel mode (assay- and sample specific selection of sample pre-fractionation conditions from a set of generic basic methods, including e.g., column switching); handling of standard clinical laboratory sample

tubes, bar code reading of tubes for positive identification, data down- and up-load from/to a LIMS; complete and closed management of ready-made solvents, with a reduction and minimization in the use of toxic solvents; ready-to-use and bar code identified internal standard mixtures; comprehensive auto-start-, auto-tuning, auto-validation and auto-QC functions; comprehensive control of all subsystems (including e.g., gas flows); web-based on-line technical and applicative support; automated trouble shooting work-flows; times-to-result of few minutes for individual samples; sample throughput of above 100 samples per hour; auto-maintenance features. Implementation and down-load of method protocols with assay-specific reagents and all instrument settings with no need for further manual tuning or interventions, in an open channel architecture.

### Future of LC-MS/MS application in laboratory medicine

At present only rather few clinical laboratories worldwide are equipped with LC-MS/MS systems, and in these laboratories this technology typically makes up for less than 1% of all analyses. The success of efforts to *substantially* improve the practicability and robustness of LC-MS/MS application by automation will be crucial for a more widespread application of this technology in the future. But is application of LC-MS/MS in laboratory medicine beyond the *status quo* really reasonable?

Indeed LC-MS/MS can close substantial gaps in the parameter portfolio of laboratory medicine:

- LC-MS/MS can allow routine analyses on a reference method level of accuracy (incorporating isotope dilution technology) for important analytes for which immunoassays offer critically limited accuracy or cannot be applied at all (e.g., steroid hormones [64], plasma metanephrens, 25-hydroxyvitamin D, drug of abuse testing; methylmalonic acid, asymmetric dimethyl arginin, microbial antigens).
- LC-MS/MS can allow really comprehensive therapeutic drug monitoring (including assessment of metabolism) for a personalized drug therapy; this is of utmost importance in the context of recent findings of pharmacogenetics for a large variety of drugs. The availability of companion testing will probably also become a key issue in the licensing of new drugs.
- LC-MS/MS enables highly multiplexed metabolic profiling which probably holds substantial potentials for disease monitoring. LC-MS/MS will probably be the analytical platform for all analytes which will be discovered to be useful in the context of metabolomic research [65].

Automation of ligand binding technologies was not less of a challenge compared to the automation of LC-MS/MS but seemed to be performed in a more straightforward manner. After introduction of ELISA-plates, washers, readers, pipetting automats, soon fully automated batch-analyzers and finally random-access, multi-channel immunoanalyzers were developed by the diagnostic industry. Now these platforms are – besides photometry based instruments – the cornerstone in the portfolio of *in-vitro* diagnostics (IVD) companies. While essential input to the process of ligand binding assay automation was from researchers, the driving force in the development of routine immunoassay analyzers was obviously the IVD industry. Such a driving force seems to be missing for the automation in LC-MS/MS at present. Traditional IVD companies seem to avoid the substantial investments which might ultimately seemingly result in competition products to their own immunoanalyzers. At present, probably less than 20% of the sales of MS/MS manufacturers are made in the field of clinical diagnostics. Since furthermore the clinical diagnostic market is very discerning and regulated, MS/MS manufacturers seem to be very reluctant towards the expensive development of MS-based clinical analyzers as well. Consequently, it is

unclear at present if companies actually decide to make the very substantial investments which would be required to realize such dedicated, fully automated MS analyzers. Nonetheless, the market of user-friendly stand-alone/front-end automation solutions for clinical LC-MS/MS applications can be attractive for more specialized automation companies now; also LC-MS/MS reagent kits have a small but important market at present.

### Summary and conclusions

A variety of approaches to automation of LC-MS/MS has been described now and is increasingly used in clinical laboratories. These approaches range from on-line SPE over sophisticated off-line robotic systems to direct coupling of a sample preparation module to a LC-MS/MS system. Such solutions of automation are helpful to increase throughput, to avoid sources of gross errors, to increase the productivity and reliability of analyses and to reduce hand-on-time of skilled technicians. However, these solutions have not yet changed the fact that a specialist (typically with academic background) is required on site to implement and to run a LC-MS/MS laboratory, which is the most critical limitation of resources for application of LC-MS/MS in laboratory medicine. A next-level of automation has to aim to system solutions with features of practicability which are similar to those of today's immunoanalyzer systems and which can fully be run by ordinarily trained technicians. Only progress towards such solutions will make the analytical power of LC-MS/MS actually useful for clinical medicine without limitation to specialized centres.

### References

- [1] Vogeser M, Seger C. A decade of HPLC-MS/MS in the routine clinical laboratory – goals for further developments. *Clin Biochem* 2008;41:649–62.
- [2] Kronkvist K, Gustavsson M, Wendel AK, Jaegfeldt H. Automated sample preparation for the determination of budesonide in plasma samples by liquid chromatography and tandem mass spectrometry. *J Chromatogr A* 1998;823:401–9.
- [3] Simpson H, Berthemy A, Buhrman D, Burton R, Newton J, Kealy M, et al. High throughput liquid chromatography/mass spectrometry bioanalysis using 96-well disk solid phase extraction plate for the sample preparation. *Rapid Commun Mass Spectrom* 1998;12:75–82.
- [4] Schütze D, Boss B, Schmid J. Liquid chromatographic-tandem mass spectrometric method for the analysis of a neurokinin-1 antagonist and its metabolite using automated solid-phase sample preparation and automated data handling and reporting. *J Chromatogr B Biomed Sci Appl* 2000;748:55–64.
- [5] Masucci JJ, Caldwell GG, Jones WW, Juzwin SS, Sasso PP, Evangelisto M. The use of on-line and off-line chromatographic extraction techniques coupled with mass spectrometry for support of *in vivo* and *in vitro* assays in drug discovery. *Curr Top Med Chem* 2001;1:463–71.
- [6] O'Connor D. Automated sample preparation and LC-MS for high-throughput ADME quantification. *Curr Opin Drug Discov Devel* 2002;5:52–8.
- [7] Xu RN, Fan L, Rieser MJ, El-Shourbagy TA. Recent advances in high-throughput quantitative bioanalysis by LC-MS/MS. *J Pharm Biomed Anal* 2007;44:342–55.
- [8] Annesley TM. Ion suppression in mass spectrometry. *Clin Chem* 2003;49:1041–4.
- [9] Taylor PJ. Matrix effects: the Achilles heel of quantitative high-performance liquid chromatography-electrospray-tandem mass spectrometry. *Clin Biochem* 2005;38:328–34.
- [10] de Jong WH, Graham KS, van der Molen JC, Links TP, Morris MR, Ross HA, et al. Plasma free metanephrine measurement using automated online solid-phase extraction HPLC tandem mass spectrometry. *Clin Chem* 2007;53:1684–93.
- [11] W.H. de Jong, M.H. Wilkens, E.G. de Vries, I.P. Kema. Automated mass spectrometric analysis of urinary and plasma serotonin. *Anal Bioanal Chem* 2010;396:2609–13.
- [12] Dunér K, Bäckström J, Magnell N, Svennberg H, Ahnoff M, Logren U. Determination of ximelagatran, melagatran and two intermediary metabolites in plasma by mixed-mode solid phase extraction and LC-MS/MS. *J Chromatogr B Analyt Technol Biomed Life Sci* 2007;852:317–24.
- [13] Vogeser M, Spöhrer U. Automated processing of whole blood samples for the determination of immunosuppressants by liquid chromatography tandem-mass spectrometry. *Clin Chem Lab Med* 2006;44:1126–30.
- [14] Alnouti Y, Srinivasan K, Waddell D, Bi H, Kavetskaia O, Gusev AI. Development and application of a new on-line SPE system combined with LC-MS/MS detection for high throughput direct analysis of pharmaceutical compounds in plasma. *J Chromatogr A* 2005;1080:99–106.
- [15] Koal T, Sibum M, Koster E, Resch K, Kaever V. Direct and fast determination of antiretroviral drugs by automated online solid-phase extraction-liquid chromatography-tandem mass spectrometry in human plasma. *Clin Chem Lab Med* 2006;44:299–305.

- [16] Ma J, Shi J, Le H, Cho R, Huang JC, Miao S, et al. A fully automated plasma protein precipitation sample preparation method for LC-MS/MS bioanalysis. *J Chromatogr B Analyt Technol Biomed Life Sci* 2008;862:219–26.
- [17] Briem S, Petterson B, Skoglund E. Description and validation of a four-channel staggered LC-MS/MS system for high-throughput in vitro screens. *Anal Chem* 2005;77:1905–10.
- [18] Briem S, Martinsson S, Bueters T, Skoglund E. Combined approach for high-throughput preparation and analysis of plasma samples from exposure studies. *Rapid Commun Mass Spectrom* 2007;21:1965–72.
- [19] Gardner ER, Dahut W, Figg WD. Quantitative determination of total and unbound paclitaxel in human plasma following Abraxane treatment. *J Chromatogr B Analyt Technol Biomed Life Sci* 2008;862(1–2):213–8.
- [20] Peng SX, Branch TM, King SL. Fully automated 96-well liquid–liquid extraction for analysis of biological samples by liquid chromatography with tandem mass spectrometry. *Anal Chem* 2001;73:708–14.
- [21] Zell M, Husser C, Hopfgartner G. Column-switching high-performance liquid chromatography combined with ionspray tandem mass spectrometry for the simultaneous determination of the platelet inhibitor Ro 44-3888 and its pro-drug and precursor metabolite in plasma. *J Mass Spectrom* 1997;32:23–32.
- [22] Veuthey JL, Souverain S, Rudaz S. Column-switching procedures for the fast analysis of drugs in biologic samples. *Ther Drug Monit* 2004;26:161–6.
- [23] Xia YQ, Whigan DB, Powell ML, Jemal M. Ternary-column system for high-throughput direct-injection bioanalysis by liquid chromatography/tandem mass spectrometry. *Rapid Commun Mass Spectrom* 2000;14:105–11.
- [24] Vogeser M, Fleischer C, Meiser B, Groetzner J, Spöhrer U, Seidel D. Quantification of sirolimus by liquid chromatography–tandem mass spectrometry using on-line solid-phase extraction. *Clin Chem Lab Med* 2002;40:40–5.
- [25] Vogeser M, Kyriatsoulis A, Huber E, Kobold U. Candidate reference method for the quantification of circulating 25-hydroxyvitamin D3 using liquid chromatography–tandem mass spectrometry. *Clin Chem* 2004;50:1415–7.
- [26] Vogeser M, Schiel X, Spöhrer U. Quantification of voriconazole in plasma by liquid chromatography–tandem mass spectrometry. *Clin Chem Lab Med* 2005;43:730–4.
- [27] Vogeser M, Rieger C, Ostermann H, Spöhrer U. A routine method for the quantification of the novel antimycotic drug posaconazole in plasma using liquid chromatography–tandem mass spectrometry. *Clin Chem Lab Med* 2009;47:579–84.
- [28] Wagner M, Bourgogne E, Varesio E, Hopfgartner G. Quantitation of polar analytes using column-switching: Application to oxycodone and three metabolites in human plasma. *J Chromatogr B Analyt Technol Biomed Life Sci* 2010;878:637–44.
- [29] Guillén D, Cofán F, Ros E, Millán O, Cofán M, Rimola A, et al. Determination of atorvastatin and its metabolite ortho-hydroxyatorvastatin in human plasma by on-line anion-exchange solid-phase extraction and liquid chromatography tandem mass spectrometry. *Anal Bioanal Chem* 2009;394:1687–96.
- [30] Zimmer D, Pickard V, Czembor W, Müller C. Comparison of turbulent-flow chromatography with automated solid-phase extraction in 96-well plates and liquid–liquid extraction used as plasma sample preparation techniques for liquid chromatography–tandem mass spectrometry. *J Chromatogr A* 1999;854:23–35.
- [31] Sauvage FL, Gaulier JM, Lachâtre G, Marquet P. A fully automated turbulent-flow liquid chromatography–tandem mass spectrometry technique for monitoring antidepressants in human serum. *Ther Drug Monit* 2006;28:123–30.
- [32] Singh RJ. Validation of a high throughput method for serum/plasma testosterone using liquid chromatography tandem mass spectrometry (LC-MS/MS). *Steroids* 2008;73:1339–44.
- [33] Wang S, Miller A. A rapid liquid chromatography–tandem mass spectrometry analysis of whole blood sirolimus using turbulent flow technology for online extraction. *Clin Chem Lab Med* 2008;46:1631–4.
- [34] Bunch DR, Miller AY, Wang S. Development and validation of a liquid chromatography–tandem mass spectrometry assay for serum 25-hydroxyvitamin D2/D3 using a turbulent flow online extraction technology. *Clin Chem Lab Med* 2009;47:1565–72.
- [35] Xu XS, Yan KX, Song H, Lo MW. Quantitative determination of a novel dual PPAR alpha/gamma agonist using on-line turbulent flow extraction with liquid chromatography–tandem mass spectrometry. *J Chromatogr B Analyt Technol Biomed Life Sci* 2005;814:29–36.
- [36] Zang X, Luo R, Song N, Chen TK, Bozgian H. A novel on-line solid-phase extraction approach integrated with a monolithic column and tandem mass spectrometry for direct plasma analysis of multiple drugs and metabolites. *Rapid Commun Mass Spectrom* 2005;19:3259–68.
- [37] Meinitzer A, Gartner G, Pilz S, Stettin M. Ultra fast liquid chromatography–tandem mass spectrometry routine method for simultaneous determination of cyclosporin A, tacrolimus, sirolimus, and everolimus in whole blood using deuterated internal standards for cyclosporin A and everolimus. *Ther Drug Monit* 2010;32:61–6.
- [38] Verdirame M, Veneziano M, Alfieri A, Di Marco A, Montegudo E, Bonelli F. Turbulent Flow Chromatography TFC–tandem mass spectrometry supporting in vitro/vivo studies of NCEs in high throughput fashion. *J Pharm Biomed Anal* 2010;51:834–41.
- [39] Deng Y, Wu JT, Lloyd TL, Chi CL, Olah TV, Unger SE. High-speed gradient parallel liquid chromatography/tandem mass spectrometry with fully automated sample preparation for bioanalysis: 30 seconds per sample from plasma. *Rapid Commun Mass Spectrom* 2002;16:1116–23.
- [40] M.J. Ahsman, B.C. van der Nagel, R.A. Mathot. Quantification of midazolam, morphine and metabolites in plasma using 96-well solid-phase extraction and ultra-performance liquid chromatography–tandem mass spectrometry. *Biomed Chromatogr* 2010; doi:10.102/bmc.1394.
- [41] Daurel-Receveur M, Titier K, Picard SP, Ducint D, Moore N, Molimard M. Fully automated analytical method for mycophenolic acid quantification in human plasma using on-line solid phase extraction and high performance liquid chromatography with diode array detection. *Ther Drug Monit* 2006;4:505–11.
- [42] Eichhorst JC, Etter ML, Rousseaux N, Lehotay DC. Drugs of abuse testing by tandem mass spectrometry: a rapid, simple method to replace immunoassays. *Clin Biochem* 2009;42:1531–42.
- [43] Marney LC, Laha TJ, Baird GS, Rainey PM, Hoofnagle AN. Isopropanol protein precipitation for the analysis of plasma free metanephines by liquid chromatography–tandem mass spectrometry. *Clin Chem* 2008;54:1729–32.
- [44] Erve JC, Beyer CE, Manzano L, Talaat RE. Metabolite identification in rat brain microdialysates by direct infusion nano-electrospray ionization after desalting on a ZipTip and LTQ/Orbitrap mass spectrometry. *Rapid Commun Mass Spectrom* 2009;23:4003–12.
- [45] Almeida R, Mosoarca C, Chirita M, Udrescu V, Dinca N, Vukelić Z, et al. Coupling of fully automated chip-based electrospray ionization to high-capacity ion trap mass spectrometer for ganglioside analysis. *Anal Biochem* 2008;378:43–52.
- [46] Shen JX, Tama CI, Hayes RN. Evaluation of automated micro solid phase extraction tips (micro-SPE) for the validation of a LC-MS/MS bioanalytical method. *J Chromatogr B Analyt Technol Biomed Life Sci* 2006;843:275–82.
- [47] Shen JX, Xu Y, Tama CI, Merka EA, Clement RP, Hayes RN. Simultaneous determination of desloratadine and pseudoephedrine in human plasma using micro solid-phase extraction tips and aqueous normal-phase liquid chromatography/tandem mass spectrometry. *Rapid Commun Mass Spectrom* 2007;21:3145–55.
- [48] Blomberg LG. Two new techniques for sample preparation in bioanalysis: microextraction in packed sorbent (MEPS) and use of a bonded monolith as sorbent for sample preparation in polypropylene tips for 96-well plates. *Anal Bioanal Chem* 2009;393:797–807.
- [49] D. Vuckovic, X. Zhang, E. Cudjoe, J. Pawliszyn. Solid-phase microextraction in bioanalysis: New devices and directions. *J Chromatogr A* 2010;1217:4041–60.
- [50] M. Abdel-Rehim. Recent advances in microextraction by packed sorbent for bioanalysis. *J Chromatogr A* 2010;1217:2569–80.
- [51] Vogeser M, Geiger A, Herrmann R, Kobold U. Sample preparation for liquid chromatography–tandem mass spectrometry using functionalized ferromagnetic micro-particles. *Clin Biochem* 2008;41:1417–9.
- [52] Vogeser M, Geiger A, Herrmann R, Kobold U. Preparation of plasma samples for chromatographic analyses using functionalized ferromagnetic micro-particles manipulated in a high pressure liquid system. *Clin Biochem* 2009;42:915–8.
- [53] Koster S, Verpoorte E. A decade of microfluidic analysis coupled with electrospray mass spectrometry: an overview. *Lab Chip* 2007;7:1394–412.
- [54] Vogeser M, Zachoval R, Spöhrer U, Jacob K. Potential lack of specificity using electrospray tandem-mass spectrometry for the analysis of mycophenolic acid in serum. *Ther Drug Monit* 2001;23:722–4.
- [55] Vogeser M, Spöhrer U. Pitfall in the high-throughput quantification of whole blood cyclosporin A using LC-MS/MS. *Clin Chem Lab Med* 2005;43:400–2.
- [56] Vogeser M, Seger C. Pitfalls Associated with the Use of Liquid Chromatography–Tandem Mass Spectrometry in the Clinical Laboratory. *Clin Chem* 2010 May 28 [Epub ahead of print].
- [57] Hu L, Boos KS, Ye M, Wu R, Zou H. Selective on-line serum peptide extraction and multidimensional separation by coupling a restricted-access material-based capillary trap column with nanoliquid chromatography–tandem mass spectrometry. *J Chromatogr A* 2009;1216:5377–84.
- [58] Carter GD. 25-Hydroxyvitamin D assays: the quest for accuracy. *Clin Chem* 2009;55:1300–2.
- [59] CBC News. Eastern Health uncovers lab testing problem [document on the internet]. CBC online. Available from: <http://www.cbc.ca/canada/newfoundland-labrador/story/2010/02/23/nl-lab-cyclosporine-230210.html> 2010 February 22.
- [60] Wu JT. The development of a staggered parallel separation liquid chromatography/tandem mass spectrometry system with on-line extraction for high-throughput screening of drug candidates in biological fluids. *Rapid Commun Mass Spectrom* 2001;15:73–81.
- [61] Morrison D, Davies AE, Watt AP. An evaluation of a four-channel multiplexed electrospray tandem mass spectrometry for higher throughput quantitative analysis. *Anal Chem* 2002;74:1896–902.
- [62] Staack RF, Varesio E, Hopfgartner G. The combination of liquid chromatography/tandem mass spectrometry and chip-based infusion for improved screening and characterization of drug metabolites. *Rapid Commun Mass Spectrom* 2005;19:618–26.
- [63] Wagner M, Varesio E, Hopfgartner G. Ultra-fast liquid chromatography–tandem mass spectrometry with matrix-assisted laser desorption/ionization and selected reaction monitoring mode detection. *J Chromatogr B Analyt Technol Biomed Life Sci* 2008;872:68–76.
- [64] Briegel J, Sprung CL, Annane D, Singer M, Keh D, Moreno R. Multicenter comparison of cortisol as measured by different methods in samples of patients with septic shock. *Intensive Care Med* 2009;35:2151–6.
- [65] Sreekumar A, Poisson LM, Rajendiran TM, Khan AP, Cao Q, Yu J, et al. Metabolomic profiles delineate potential role for sarcosine in prostate cancer progression. *Nature* 2009;457:910–4.
- [66] Seger C, Tentschert K, Stöggel W, Griesmacher A, Ramsay SL. A rapid HPLC-MS/MS method for the simultaneous quantification of cyclosporine A, tacrolimus, sirolimus and everolimus in human blood samples. *Nat Protoc* 2009;4:526–34.
- [67] Rauh M, Gröschl M, Rascher W, Dörr HG. Automated, fast and sensitive quantification of 17 alpha-hydroxy-progesterone, androstenedione and testosterone by tandem mass spectrometry with on-line extraction. *Steroids* 2006;71:450–8.
- [68] Calton LJ, Molloy BJ, Keevil BG, Cooper DP. The analysis of 25-hydroxyvitamin D in serum using semi-automated solid phase extraction and LC/MS/MS. *Clin Chem* 2009;A187–8.

- [69] Knox S, Harris J, Calton L, Wallace AM. A simple automated solid-phase extraction procedure for measurement of 25-hydroxyvitamin D3 and D2 by liquid chromatography-tandem mass spectrometry. *Ann Clin Biochem* 2009;46:226–30.
- [70] Ceglarek U, Kortz L, Leichtle A, Fiedler GM, Kratzsch J, Thiery J. Rapid quantification of steroid patterns in human serum by on-line solid phase extraction combined with liquid chromatography-triple quadrupole linear ion trap mass spectrometry. *Clin Chim Acta* 2009;401:114–8.
- [71] Martin J, Deslandes G, Dailly E, Renaud C, Reliquet V, Raffi F, et al. A liquid chromatography-tandem mass spectrometry assay for quantification of nevirapine, indinavir, atazanavir, amprenavir, saquinavir, ritonavir, lopinavir, efavirenz, tipranavir, darunavir and maraviroc in the plasma of patients infected with HIV. *J Chromatogr B Analyt Technol Biomed Life Sci* 2009;877:3072–82.
- [72] de Castro A, Concheiro M, Quintela O, Cruz A, López-Rivadulla M. LC-MS/MS method for the determination of nine antidepressants and some of their main metabolites in oral fluid and plasma. Study of correlation between venlafaxine concentrations in both matrices. *J Pharm Biomed Anal* 2008;48:183–93.
- [73] Breaud AR, Harlan R, Di Bussolo JM, McMillin GA, Clarke W. A rapid and fully-automated method for the quantitation of tricyclic antidepressants in serum using turbulent-flow liquid chromatography-tandem mass spectrometry. *Clin Chim Acta* 2010 Mar 4 [Epub ahead of print].
- [74] Feng J, Wang L, Dai I, Harmon T, Bernert JT. Simultaneous determination of multiple drugs of abuse and relevant metabolites in urine by LC-MS-MS. *J Anal Toxicol* 2007;31:359–68.
- [75] Badawi N, Simonsen KW, Steentoft A, Bernhoft IM, Linnet K. Simultaneous screening and quantification of 29 drugs of abuse in oral fluid by solid-phase extraction and ultraperformance LC-MS/MS. *Clin Chem* 2009;55:2004–18.
- [76] Ansermot N, Fathi M, Veuthey JL, Desmeules J, Rudaz S, Hochstrasser D. Simultaneous quantification of cyclosporine, tacrolimus, sirolimus and everolimus in whole blood by liquid chromatography-electrospray mass spectrometry. *Clin Biochem* 2008;41:728–35.
- [77] Lensmeyer GL, Poquette MA. Therapeutic monitoring of tacrolimus concentrations in blood: semi-automated extraction and liquid chromatography-electrospray ionization mass spectrometry. *Ther Drug Monit* 2001;23:239–49.
- [78] Poquette MA, Lensmeyer GL, Doran TC. Effective use of liquid chromatography-mass spectrometry (LC/MS) in the routine clinical laboratory for monitoring sirolimus, tacrolimus, and cyclosporine. *Ther Drug Monit* 2005;27:144–50.
- [79] Schmedes A, Brandslund I. Analysis of methylmalonic acid in plasma by liquid chromatography-tandem mass spectrometry. *Clin Chem* 2006;52:754–7.