

Aus der Chirurgischen Klinik und Poliklinik – Innenstadt,  
Klinikum der Ludwig-Maximilians-Universität zu München,  
Chirurgisches Forschungslabor  
Vorstand: Prof. Dr. med. Wolf Mutschler

**Establishment of a clonal immortalized human mesenchymal stem  
cell line expressing hTERT using lentiviral gene transfer**

Dissertation  
zum Erwerb des Doktorgrades der Medizin  
(Dr. med.)  
an der Medizinischen Fakultät  
der Ludwig-Maximilians-Universität zu München

vorgelegt von  
Zhanhai Yin

Aus  
Aus Xi'an, Shaanxi Province, P.R.China

Jahr  
2012

Mit Genehmigung der Medizinischen Fakultät  
der Universität München

Berichterstatter: Prof. Dr. med. Wolf Mutschler

Mitberichterstatter: Priv. Doz. Dr. Wolfgang Thasler  
Prof. Dr. Rainer Glaß, PhD

Mitbetreuung durch den  
promovierten Mitarbeiter: Prof. Dr. med. Matthias Schieker  
Priv.-Doz. Dr.med. Wolfgang Böcker

Dekan: Prof. Dr. med. Dr. h.c. M. Reiser, FACR, FRCR

Tag der mündlichen Prüfung: 05.07.2012

## Contents

<b>1. Introduction .....</b>	<b>5</b>
1.1. Research basis .....	5
1.1.1. Tissue engineering and human mesenchymal stem cells (hMSCs) .....	5
1.1.2. Senescence and telomerase .....	6
1.1.3. immortalization of hMSCs by human telomerase reverse transcriptase (hTERT) transduction .....	8
1.1.4. Importance of examination of malignant transformation potential of hTERT-transduced hMSCs.....	10
1.2. Aim of the experiment .....	12
<b>2. Material and methods.....</b>	<b>13</b>
2.1. Culture of hMSCs.....	13
2.2. Construction of pLenti6/V5-hTERT .....	16
2.3. Producing lentivirus in 293FT cells.....	18
2.4. Transduction and analysis.....	19
2.4.1. RNA extraction .....	20
2.4.2. Reverse transcription of RNA into cDNA .....	21
2.4.3. Detection of hTERT gene expression by polymerase chain reaction (PCR) .....	23
2.5. Single cell picking.....	24
2.6. Proliferation assay.....	25
2.6.1. Morphological observation.....	25
2.6.2. Cumulative population doubling level (PDL) and population doubling time (PDT).....	25
2.7. Senescence-associated $\beta$ -gal staining .....	28
2.8. Differentiation assay.....	30
2.8.1. Adipogenic differentiation .....	30
2.8.2. Chondrogenic differentiation.....	32
2.8.3. Osteogenic differentiation.....	34
2.9. Karyotype (cytogenetics) analysis.....	36
2.10. Tumor suppressor gene assay.....	37
2.11. Cell transformation soft agar assay.....	40
2.12. <i>In vivo</i> implantation assay .....	42

<b>3. Results .....</b>	<b>43</b>
3.1. Construction of pLenti6/V5-hTERT and transduction of hMSCs .....	43
3.2. Expression of hTERT .....	44
3.3. Growth kinetics of hTERT-transduced hMSCs cell lines .....	45
3.4. Morphological change during passaging .....	47
3.5. Senescence associated $\beta$ -gal staining .....	49
3.6. Differentiation assay .....	51
3.7. Karyotype (cytogenetics) analysis .....	54
3.8. Tumor suppressor gene assay .....	55
3.9. Soft agar assay .....	56
3.10. <i>In vivo</i> implantation assay .....	58
<b>4. Discussion .....</b>	<b>59</b>
4.1. Senescence of hMSCs hindered its usage as tissue engineering seed cell.....	59
4.2. Transduction with telomerase reverse transcriptase (hTERT) would bypass senescence.....	59
4.3. Differentiation capability was not hampered by lentiviral hTERT transduction and long term <i>in vitro</i> culture.....	61
4.4. Replication incompetent HIV-1-based lentiviral vector transduction weighed better than traditional Moloney Leukemia Virus (MoMLV)-based retroviral transduction .....	62
4.5. No malignant transformation was observed in lentivirally hTERT- transduced hMSCs .....	63
<b>5. Summary .....</b>	<b>67</b>
<b>6. References .....</b>	<b>69</b>
Supplement.....	72
List of abbreviations.....	81
Acknowledgement .....	83
Curriculum vitae .....	84
Publications.....	87

## 1. Introduction

### 1.1. Research basis

#### 1.1.1. Tissue engineering and human mesenchymal stem cells (hMSCs)

Tissue and organ defect or dysfunctions were hard to treat. Large scale bone loss after tumor resection or trauma needed to be refilled by autogenous bone or allograft bone. As immune rejection and possible propagation of infectious disease limited usage of allogeneic graft, restricted bone-harvesting amount and donor sites limited the usage of autogenous bone graft, a new strategy to reconstruct bone and other tissue defect (cartilage, tendon, etc) or even to rehabilitate organ function needed to be exploited.

“**Tissue engineering**” was the application of the principles and methods of engineering and the life sciences towards the development of biological substitutes to restore, maintain or improve functions. In the USA it had been actively fostered by the “National Science Foundation”, both through research grants and the sponsorship of a series of workshops starting in 1988 (Nerem 1992). Cell transplantation and tissue engineering techniques were being developed to generate new functional tissues for human applications. New techniques had been developed to generate new bone, cartilage and even liver tissue for reconstruction or replacement therapy.

Devices were constructed using synthetic polymers as scaffold attached to tissue-specific cells were seeded on crude (coral, silk, alginate, etc) or synthetic (polylactic acid, PLA, polyglycolic acid, PGA, etc) scaffolds, different types of tissues were engineered in static or dynamic culture devices, thereby allowing for tissue remodeling and functional replacement. Basically there were three aspects of tissue engineering: seed cell, scaffold and *in vitro* culture system (device) to construct tissue-engineered tissue or organ.

Many different cell types had been employed to construct tissue and organ. Autologous somatic cells seemed to be a good choice for its autologous feature without causing any immune rejection, but resource of autologous somatic cells were limited, collecting of autologous somatic cells would cause damage to original unimpaired tissue and these cells were mostly inert to proliferation, these would limit the application of autologous somatic cell for tissue engineering. Allogeneic cells were relatively easier to attain, but due to the problem of possible immune rejection and disease contamination, their usage in tissue engineering was also limited.

**Human mesenchymal stem cells (hMSCs)** represented a non-hematopoietic cell population in bone marrow with the ability of self-renewing and multi-lineage differentiation. hMSCs could be easily separated from bone marrow or adipose tissue by penetration and aspiration. Isolation and characterization of hMSCs had been performed by investigators using a variety of techniques including gradient centrifugation, plastic adherence, antibodies-mediated fluorescence-activated cell sorting (FACS), fibronectin-mediated adherence in low serum condition or *in vitro* growth selection under low oxygen tension in the presence of hematopoietic cells. Many researches proved *in vitro* and *in vivo* that hMSCs not only possessed prominent capacity to duplicate themselves (self-renewal) to serve as a cell source reservoir for cell replacement and tissue regeneration, but also had multi-lineage differentiation potential, which could be induced to differentiate into different mesoderm type cells including osteoblasts, chondrocytes, adipocytes, myocytes, and even into other non-mesodermal lineages, such as hepatic and Schwann cell-like myelinating cells (Pittenger et al. 1999). Based on their high reproductivity of generating progeny cells, multi-lineage differentiation potential and relative easiness to separate, autogenous hMSCs could be adapted as a promising seed cell candidate for tissue engineering without causing any immune responses.

### **1.1.2. Senescence and telomerase**

Although hMSCs was recognized to have noticeable self-renewing capacity, the abundance of hMSCs in bone marrow was very low (about  $1/10^5$ - $1/10^4$ ), when large amount of hMSCs was needed for construction of a large scale tissue or a specific organ *in vitro*, small amount of initial separated cells needed to be passaged and

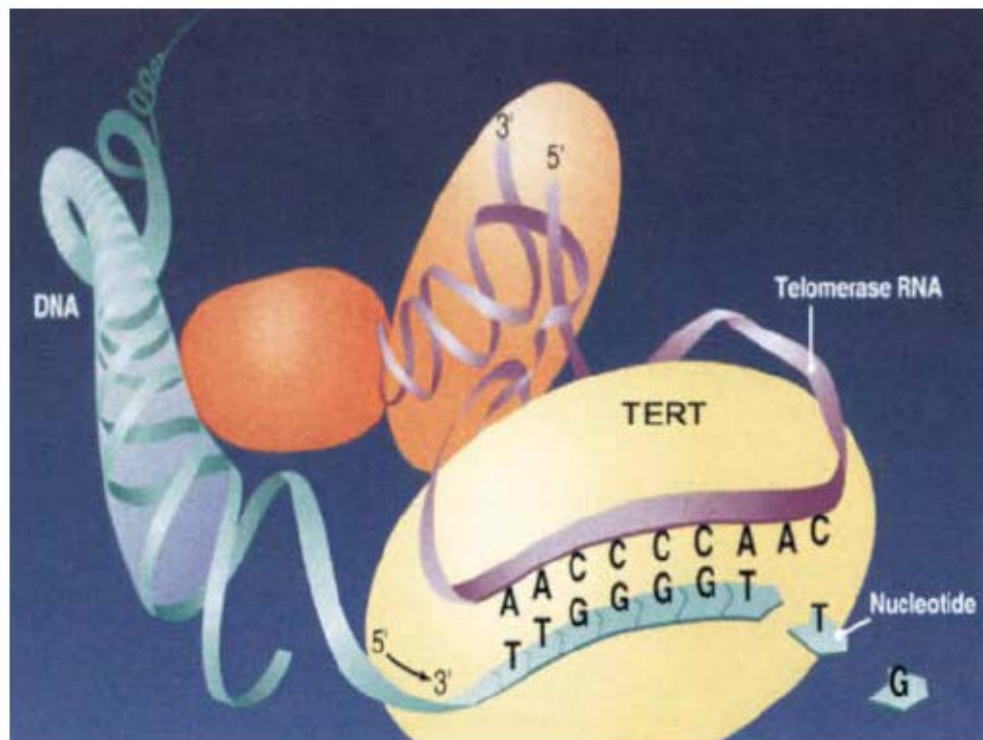
expanded *in vitro* for relatively long period and more than 10 passages until enough cell number for tissue engineering. During the long period of passage *in vitro*, due to high concentration of oxygen (20% in incubator, while 3%-5% *in vivo*), toxic substances, malnourishment in culture system, the growth rate of hMSCs would be slowed down; cells would become flat, show increased adherence to the culture vessel, change their molecular expression profile and even lose their differentiation potential. This was a common phenomenon faced by cells in culture and most of somatic cells in living organism — **replicative senescence**.

Senescence was originally defined as an 'irreversible' state of cell cycle arrest that reflected consumed proliferative capacity of the cell (Hayflick limit). In eukaryotic cells, each chromosome shortened from telomeres during every round of DNA replication due to end-replication problem of DNA polymerase. The structure of telomeres with repetitive sequences (TTAGGG)<sub>n</sub> functioned as a cap to prevent chromosome end fusions and genomic instability (Collins and Mitchell 2002; de Lange 2006). While germ cells expressed telomerase, which resynthesized the telomeric repeats to maintain the chromosomal length, most human somatic cells did not express telomerase, consequently these telomerase-shortage somatic cells got into senescence after limited time of *in vitro* culture. Although hMSCs was recognized to have noticeable self-renewing capacity, no telomerase activity was detectable in these cells by nowadays well accepted telomeric repeat amplification protocol (TRAP) method. Telomere length in hMSCs was also not significantly longer than normal somatic cells.

In cells proliferating continuously, attrition of telomeres beyond a threshold triggered a response leading to replicative senescence. Recent studies had indicated that telomere attrition provoke DNA damage-responsive signaling pathways, such as tumor suppressing "cyclin-dependent kinase inhibitor 2A (p16<sup>INK4a</sup>) - retinoblastoma 1 (RB1)" and "alternative reading frame (p14<sup>ARF</sup>) - tumor protein 53 (TP53)" pathways, to induce cell cycle control and replicative senescence (Kiyokawa 2006).

**Telomerase** had the enzymatic activity to maintain and elongate telomere length. It contained three components. The essential catalytic component was telomerase reverse transcriptase (TERT), which provided the catalytic center for addition of

telomere-specific sequence  $(TTAGGG)_n$  to the end of telomeres. The other two important components were the synthesis template of telomere - telomerase RNA component (TERC) and additional function-modulating proteins (Figure 1). Since TERT was the key catalytic unit of telomerase, ectopic expression of TERT was proved to be able to maintain the telomere length in cells, thus prevent cells from replicative senescence and loss of function (Cech 2004).



**Figure 1.** Schematic illustration of telomerase in Action. The RNA subunit (purple)-TERC had the template sequence of *Tetrahymena* telomerase. Proteins included the catalytic subunit, TERT (yellow), and additional less-conserved proteins (orange). [6]

### 1.1.3. Immortalization of hMSCs by human telomerase reverse transcriptase (hTERT) transduction

Since there was no detectable telomerase activity in hMSCs, then transduction of hMSCs with hTERT could be a practical way to bypass senescence and extend the lifespan of hMSCs. Many authors had gained successful results using non-viral or viral vectors to transfect cells with hTERT and immortalized human endothelial cell, hematopoietic progenitor cell, bone marrow stromal cell, fibroblast-like cell from embryonic stem cell, adipose tissue-derived stromal cell, osteoblast from hMSCs,



umbilical cord blood-derived cells, et al (Zimmermann et al. 2004;Xu et al. 2004;Ramirez et al. 2004;Jun et al. 2004) (Table 1).

**Table 1** hTERT immortalization of somatic cells

<i>Cell type and donor age</i>	<i>Tissue</i>	<i>Immortal</i>	<i>References</i>
Fibroblasts			
fetal	lung	yes	(McSharry <i>et al.</i> , 2001)
fetal	lung	yes	(MacKenzie <i>et al.</i> , 2000)
fetal	lung	yes <sup>1</sup>	(Franco <i>et al.</i> , 2001)
newborn	foreskin	yes	(Bodnar <i>et al.</i> , 1998)
newborn	foreskin	yes	(Vaziri and Benchimol, 1999)
adult			
normal	skin	yes	(Wyllie <i>et al.</i> , 2000)
normal	?	yes	(Oullette <i>et al.</i> , 2000)
normal	mammary	no <sup>2</sup>	(O'Hare <i>et al.</i> , 2001)
Fanconi anemia	skin	yes <sup>3</sup>	(Oullette <i>et al.</i> , 2000)
Blooms	skins	yes <sup>3</sup>	(Oullette <i>et al.</i> , 2000)
Roberts	skin	yes <sup>3</sup>	(Oullette <i>et al.</i> , 2000)
XP (E&V)	skin	yes <sup>3</sup>	(Oullette <i>et al.</i> , 2000)
Werner	skin	yes <sup>3</sup>	(Oullette <i>et al.</i> , 2000)
Werner	skin	yes <sup>3</sup>	(Choi <i>et al.</i> , 2001)
Werner	skin	yes <sup>3</sup>	(Wyllie <i>et al.</i> , 2000)
Progeria	skin	yes <sup>3</sup>	(Oullette <i>et al.</i> , 2000)
Ataxia telangiectasia	skin	yes	(Wood <i>et al.</i> , 2001)
Nijmegen breakage	skin	yes <sup>3</sup>	(Ranganathan <i>et al.</i> , 2001)
Endothelial Cells			
newborn	umbilical vein	yes	(Yang <i>et al.</i> , 1999)
adult	aortic artery	yes	(Yang <i>et al.</i> , 1999)
adult	saphenous vein	yes	(Yang <i>et al.</i> , 1999)
newborn	skin microvasc.	yes	(Yang <i>et al.</i> , 1999)
adult	mammary	no <sup>2</sup>	(O'Hare <i>et al.</i> , 2001)
adult	liver sinusoid	yes	(Salmon <i>et al.</i> , 2000)
Keratinocytes			
newborn	foreskin	yes	(Ramirez <i>et al.</i> , 2001)
newborn	foreskin	no <sup>4</sup>	(Farwell <i>et al.</i> , 2000)
newborn	foreskin	no <sup>4</sup>	(Dickson <i>et al.</i> , 2000)
newborn	foreskin	no <sup>4</sup>	(Kiyono <i>et al.</i> , 1998)
newborn	foreskin	yes <sup>5</sup>	(Jiang, X.-R. unpublished data)
adult	skin	yes <sup>5</sup>	(Jiang, X.-R. unpublished data)
RPE cells, child	eye	yes	(Bodnar <i>et al.</i> , 1998)
Other epithelial cells			
adult	bronchial	yes	(Chiu, C.-P. unpublished data)
adult	mammary	yes	(Ramirez <i>et al.</i> , 2001)
adult	mammary	no <sup>4</sup>	(Farwell <i>et al.</i> , 2000)
adult	mammary	no <sup>4</sup>	(Kiyono <i>et al.</i> , 1998)
?	adenoid	no <sup>4</sup>	(Farwell <i>et al.</i> , 2000)
?	throid	no <sup>4,6</sup>	(Jones <i>et al.</i> , 2000)
Melanocytes, newborn	skin	yes <sup>7</sup>	(Bandyopadhyay <i>et al.</i> , 2001)
Smooth muscle, adult	coronary artery	yes	(Chiu, C.-P, unpublished data)
Myoblasts/satellite cells			
normal and DMD children	skeletal muscle	no <sup>2</sup>	(Seigneurin-Venin <i>et al.</i> , 2000a; Seigneurin-Venin <i>et al.</i> , 2000b)
Lymphocytes	blood, CD8 +	yes	(Hooijberg <i>et al.</i> , 2000)
	blood, CD8 +	no	(Migliaccio <i>et al.</i> , 2000)
Adrenocortical cells			
bovine, transformed	adrenal gland	yes <sup>8</sup>	(Thomas <i>et al.</i> , 2000)
Osteoblasts, adult	bone	yes	(Yudoh <i>et al.</i> , 2001)
Islet cells (beta enriched)			
adult primary	pancreas	no <sup>9</sup>	(Halvorsen <i>et al.</i> , 2000)
adult transformed	pancreas	yes <sup>10</sup>	(Halvorsen <i>et al.</i> , 1999)

<sup>1</sup>26 clones examined, ≈1/3 immortalized; <sup>2</sup>hTERT+T-antigen required for immortalization; <sup>3</sup>Primary genetic mutant phenotype preserved; <sup>4</sup>cells grown on plastic; <sup>5</sup>two independant strains; <sup>6</sup>primary cells survived <3 doublings; <sup>7</sup>extended lifespan, not clear if immortal; <sup>8</sup>hTERT immortalized bovine T-antigen transformed cells and these cells had an apparently normal phenotype when transplanted into mice; <sup>9</sup>primary cells survived <15 doublings; <sup>10</sup>T-antigen transformed

**Table 1.** hTERT immortalization of somatic cells (Harley 2002)

Most of these authors used traditional Moloney murine leukemia virus (MoMLV) – based retroviral systems to transduce cells, but MoMLV–based retroviral vectors could only infect dividing cells, therefore limited their application in non-dividing cells. And due to their integration bias for transcription start site (TSS) and cancer-associated genes, cells transduced with MoMLV–based retroviral vectors were predisposed to malignant transformation. Meanwhile, human immunodeficiency virus (HIV)-1-based lentiviral vectors could infect both dividing and non-dividing cells, and had superior proficiency at integrating into cells without TSS or cancer-associated genes preference, therefore lentiviral vectors could be a better choice for transferring gene of interest (GOI) into target cells.

In our experiment, lentiviral vector would be employed to transfer hTERT gene into hMSCs, and the resulting expression of hTERT and senescence-bypassing function of hTERT transduction would also be explored.

#### **1.1.4. Importance of examination of malignant transformation potential of hTERT-transduced hMSCs**

hTERT transduction could bypass senescence and expand life span of hMSCs, but according to some authors' observations, hTERT transduction was reported to have tumorigenic potential that it could predispose hMSCs to chromosome instability, or even neoplastic transformation. Serakinci et al noticed that, long-term *in vitro* culture of retrovirally hTERT-immortalized hMSCs had high incidence of neoplastic transformation and alteration in tumor related genes, such as v-Ki-ras2 Kirsten rat sarcoma viral oncogene homolog (KRAS), neuroblastoma RAS viral oncogene homolog (NRAS), cyclin-dependent kinase inhibitor 2A/alternative reading frame (Ink4a/ARF), deleted in bladder cancer chromosome region candidate 1 (DBCCR1) (Serakinci et al. 2004). Noble et al noticed altered TP53, cyclin-dependent kinase inhibitor 1A (p21) expression and deletion of chromosome in hTERT-immortalized human fibroblasts after long term *in vitro* culture (Noble et al. 2004).

One thing to be noticed in these observations was that, all of the chromosome abnormalities were detected in TERT-transduced cells after long term continuous *in vitro* culture. Miura et al had observed that, murine bone marrow-derived MSCs,

without any aberrance in chromosome at the beginning of the observation, had acquired spontaneous accumulated chromosomal abnormalities and malignant transformation after numerous *in vitro* passages. They also noticed that this transformation was associated with increased oncogene v-myc myelocytomatosis viral oncogene homolog (c-myc) expression (Miura et al. 2006). Based on these observation and the proved tumorigenic potential of commonly used MoMLV-based retroviral vectors, one speculation could be prompted that, it could be the accumulated chromosomal instability during long-term *in vitro* culture and the specific trait of retroviral vectors used in hTERT transduction that predispose hTERT-transduced hMSCs to neoplastic transformation in the observations above.

In order to check and exclude the potential malignant transformation of our lentivirally hTERT-transduced cells, karyotyping of chromosomes, soft agar assay of anchorage-independence and nude mice implantation assay would be employed. As the normal prosperous self-renewal proliferation of stem cells was under surveillance by two important tumor suppressing pathways—RB1 and TP53. The expression of these tumor suppressing genes would be monitored along with the time course of continuous *in vitro* culture of our lentivirally hTERT-transduced hMSCs.

## **1.2. Aim of the experiment.**

1.2.1. To establish immortalized hMSCs cell line by lentiviral hTERT - transduction and single cell picking.

1.2.2. To explore the effect of hTERT on the biological behaviour of hMSCs.

1.2.3 To explore the potential transformation capacity of lentiviral hTERT-transduction in hMSCs.

## 2. Material and Methods

### 2.1. Culture of human mesenchymal stem cells (hMSCs)

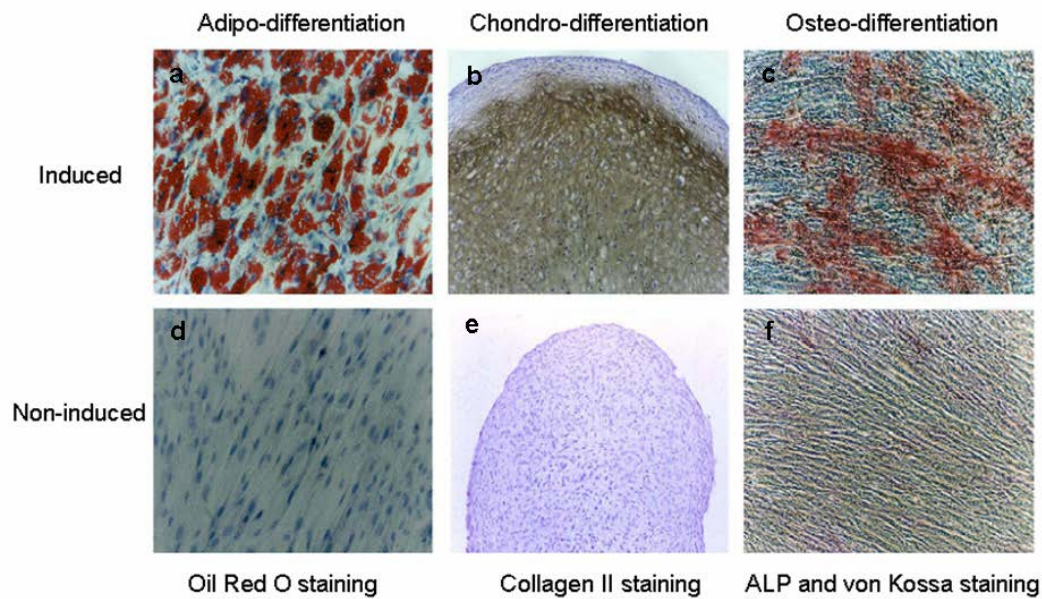
Material:

Cells: As proposed by the “Mesenchymal and tissue stem cell committee of the international society for cellular therapy”, three criteria should be fulfilled to define MSCs. First, MSC needed to be plastic-adherent when maintained in standard culture conditions using tissue culture flasks. Second, more than 95% of the MSC population needed to express specific mesenchymal stem cell markers such as cluster of differentiation (CD) 105 as measured by flow cytometry; and lack expression of hematopoietic cell markers such as CD14, CD34 and CD45 (elucidated in table 2). Third, the cells needed to be able to differentiate to osteoblasts, adipocytes and chondroblasts under standard *in vitro* differentiation conditions (Dominici et al. 2006; Horwitz et al. 2005).

Human mesenchymal stem cells (Catalog Number-Cat. No: POPT-2501, cryopreserved) were purchased from Cambrex (Lonza) Corporation USA. Human bone marrow was withdrawn from the posterior iliac crest of the pelvic bone of normal volunteers, centrifuged with density gradient method, plated into culture flask followed by sequential medium change to eliminate non-adherent hematopoietic cells. The cells were passaged and obtained at the 3<sup>rd</sup> passage after isolation. All cells were tested negative for HIV-1, hepatitis-B and C, mycoplasma, bacteria, yeast and fungi. Cells were tested for purity by flow cytometry and analyzed for surface markers, which were positive for CD105, CD166, CD29 and CD44 and negative for CD14, CD34 and CD45 (Table 2). All Cells were also performance assayed and certified to have the ability to differentiate into osteogenic, chondrogenic and adipogenic lineages (Figure 2).

		<b>Alternative name</b>	<b>Cellular function</b>
<b>Positive</b>	CD105	Endoglin	a. Component of the transforming growth factor (TGF) $\beta$ receptor complex. b. Modulator of cellular responses to TGF- $\beta$ 1.
	CD166	Stem cell antigen-1 (SC-1)	Cell adhesion.
	CD29	Integrin, $\beta$ 1 (fibronectin receptor)	Cell adhesion and recognition.
	CD44	Homing-associated cell adhesion molecule (H-CAM)	a. Recyclable receptor for hyaluronic acid (HA). b. Interacting also with other ligands such as osteopontin, collagens, and matrix metalloproteinases-MMPs.
<b>Negative</b>	CD14	Lipopolysaccharide (LPS) receptor	a. Surface protein preferentially expressed on monocytes / macrophages. b. Binding with lipopolysaccharide binding protein and apoptotic cells.
	CD34	Glycoprotein 105-120	a. Cell-cell adhesion. b. Inhibition of hematopoietic differentiation. c. Cell surface antigen selectively expressed on human hematopoietic progenitor cells.
	CD45	a. Leukocyte common antigen (LCA) b. Protein tyrosine phosphatase, receptor type C	T and B cell antigen receptor-mediated activation.

**Table 2.** Surface makers tested for purity of hMSCs by Cambrex



**Figure.2** Differentiation assay of hMSCs from Cambrex. hMSCs were stained positive for fat droplets (a), collagen II (b), alkaline phosphatase (ALP) and extracellular calcium deposition (c) after adipo-, chondro-, and osteo-differentiation, while non-induced cells were stained negative (d.e.f).

From presentation of “Marshak DR. Human somatic stem cell and progenitor cell systems for research in cell therapy, toxicity screening, and target validation”. Cambrex corporation, USA. (<http://www.cambrex.com/content/general/sitesearch.asp?searchResponse=search&searchOperator=and&category=ALL&searchString=stem%20%20cell>)

Culture medium: The Poietics™ mesenchymal stem cell growth medium (MSCGM) BulletKit® (Cambrex, Cat. No. PT-3001, USA) was applied to culture hMSCs. MSCGM was developed for growing large numbers of mesenchymal stem cells without inducing differentiation. The MSCGM BulletKit contained one bottle of mesenchymal stem cell basal medium (MSCBM, Cat.No. PT-3238) and one MSCGM SingleQuot® Kit (Cat.No. PT-4105). MSCBM is one 440 ml bottle of mesenchymal stem cell basal medium. MSCGM SingleQuot® Kit contained mesenchymal stem cell growth supplement (MCGS) 50 ml, L-Glutamine 10 ml and Penicillin-Streptomycin 0.5 ml. The MSCGM was prepared by adding of MSCGM SingleQuot® Kit into MSCBM before use.

Culture flask: Nunc EasYFlasks™ Nunclon™Δ, Polystyrene, Sterile, T-75 (Culture area 75 cm<sup>2</sup>), (Nunc, Cat. No. 156499, Denmark).

Trypsin/ ethylene diamine tetraacetic acid (EDTA) (10x) (PAA, Cat. No. L11-003, Austria), diluted with PBS 1:10 into 1x before use.

Phosphate-buffered saline (PBS) without  $\text{Ca}^{2+}$ ,  $\text{Mg}^{2+}$ , (PAA, Cat. No. H15-002, Austria).

#### Methods:

Cells were seeded at 5000-6000 cells/cm<sup>2</sup> in T-75 flasks in a humidified incubator with 5% CO<sub>2</sub>, 37°C for subculture. Media were changed every 3-4 days. For further cultivation cells were trypsinized by 1x trypsin / EDTA before 40% confluence and reseeded.

## 2.2. Construction of pLenti6/V5-hTERT

#### Material:

human TERT cDNA: The cDNA was kindly provided within the pBABE-PURO plasmid by Robert Weinberg (Whitehead Institute, MIT, Boston, USA).

Sal I (New England Biolabs, Cat. No. R0138T, USA)

Not I (New England Biolabs, Cat. No. R0189S, USA)

Klenow large fragment (New England Biolabs, Cat. No. M0210, USA)

NucleoSpin Extract II kit (Machery-Nagel, Düren, Cat. No. 740609.50, Germany)

Quick T4 ligase (Quick ligation kit) (New England Biolabs, Cat. No. M2200S, USA).

pENTR11 vector (Invitrogen, Cat. No. 11819018, USA)

pLenti6/V5-DEST vector (Invitrogen, Cat. No. 11819018, USA)

TOP10 competent E.coli (Invitrogen, Cat. No. C404010, USA)

GeneElute Plasmid MiniPrep Kit (Machery-Nagel, Düren, Germany)

LR Clonase™ II enzyme mix (Invitrogen, Cat. No. 11791-019, USA)

One Shot® Stbl3™ chemically competent E. coli (Invitrogen, Cat. No. C7373-03, USA)

QIAfilter Plasmid Midi Kit (Qiagen, Cat. No.12243, Germany)

EndoFree Plasmid Buffer Set (Qiagen, Cat. No. 19048, Germany)

#### Methods:

Coding domain sequence of hTERT was isolated from pBABE-PURO plasmid by digestion with Sal I and linearized with Klenow large fragment. Therefore, 10 µg of



pBAGE-PURO plasmid was digested for 2 hours with 20 units of Sal I in 50 µl reaction volume. The resulting hTERT fragment was isolated from agarose gel by NucleoSpin Extract II kit according to manufacturer's protocol. Blunt ends were generated using 2 µg of the hTERT fragment in 50 µl total volume with 10% (v/v) 10x NE Buffer2 with 8% (v/v) dNTP mix (10 nM) and 5 units of Klenow enzyme. After 60 min incubation at 37°C the reaction was stopped with the addition of EDTA (final concentration 10 mM) and incubation for 20 min at 75°C. The blunt end hTERT fragment was isolated by NucleoSpin Extract II kit.

pENTR11 plasmid was digested with NotI and blunt ends were generated by Klenow large fragment. The resulting pENTR11 vector and hTERT fragment were ligated using Quick T4 ligase. 50 ng of vector were ligated with 3 molar excess of the insert hTERT. The fragments were diluted in 10 µl of water before adding 10 µl of Quick Ligation Buffer (2x) and 1 µl of Quick ligase, followed by a 5 min incubation period at 25°C. 5 µl of the reaction was used for transformation of 50 µl TOP10 competent *E.coli* bacteria were incubated on ice for 1 hour with DNA, then heat shocked for 45 sec at 42°C and incubated again on ice for 2 min. 250 µl of room temperature super optimized culture (SOC) medium was added to the bacteria and incubated at 37°C in a cell shaker for 1 hour. 50 µl of bacterial suspension was plated on agar plates containing kanamycin. After overnight incubation at 37°C, colonies were isolated and grown in 5 ml of double-yeast-trypton (dyt)-medium overnight at 37°C. For isolation of the plasmid GeneElute Plasmid MiniPrep Kit was used according to the manufacturer's protocol. The correct colony was identified by restriction analysis.

The coding sequence of hTERT was then transferred from pENTR11 into pLenti6V5-Dest by using LR Clonase reaction according to manufacturer's protocol. 150 ng of purified plasmid DNA of the entry clone pENTR11-hTERT and 150 ng of the destination vector pLenti6/V5-DEST were suspended in 8 µl TE, pH 8.0) and 2 µl of LR Clonase™ II enzyme mix was added. Recombination was performed at 25°C for 60 min and stopped with 1 µl protein K solution for 10 min at 37°C. 2 µl of the reaction was transformed with the standard protocol (see above) in One shot Stbl3 competent *E.coli*. After identification of the correct clone by restriction analysis and mini preparation, larger amounts of plasmid DNA pLenti6/V5-hTERT was generated with endotoxin-free Midi Prep Kit according to the manufacturer's protocol. To confirm that the gene of interest (hTERT) was correctly transferred into pLenti6V5-Dest vector,

expression construct of pLenti6V5-hTERT was sequenced afterwards for inserted hTERT gene.

### 2.3. Producing lentivirus in 293FT cells in T-225 flask

#### Material:

ViralPower™ Lentiviral Expression System (Cat. No. K4960-00):

ViralPower™ Blasticidin Lentiviral Support Kit:

ViralPower™ Packaging Mix (pLP1, pLP2 and pLP/VSVG plasmids) (1µg/µl)

Lipofectamine™ 2000 Reagent (4°C).

Blasticidin (concentration).

pLenti6/V5-DEST Gateway® Vector Kit:

pLenti6/V5-DEST Vector ( µg/µl, endotoxin free)

One Shot® Stbl3™ Chemically Competent E. coli

293FT cells (Invitrogen, Cat. No. R700-07, USA)

T-225 tissue culture flask (Nunc, Cat.No.159934, Denmark)

Opti-MEM® I reduced serum medium (Invitrogen, Cat. No. 31985-070, USA)

Fetal bovine medium (FBS) (Sigma, Cat. No. 103K3395, USA)

Lipofectamine™ 2000 (Invitrogen, Cat. No. 11668-019, USA)

50ml sterile, capped, conical tubes (Sarstedt, Cat. No. 62.547.254, Germany)

Polybrene (Sigma, Cat. No. H9268, USA)

HT1080 (ATCC, Cat. No.CCL-121, USA)

Blasticidin (Invitrogen, R210-01, USA)

Crystal violet (Sigma, Cat. No. C3886, USA)

#### Methods:

For generation of lentivirus the ViralPower™ Lentiviral Expression System was used with some minor modifications. For lentivirus production 293FT cells (cultured not more than 20 passages in vitro) were used. On day 1 293FT cells were plated in 10 ml of growth medium containing serum in a T-225 flask without antibiotics. On day 2 cells were trypsinized and counted.  $1.2 \times 10^6$  cells/ml 293FT cells were resuspended in Opti-MEM® I medium containing 10% FBS but no antibiotic. For each transfection

sample DNA-Lipofectamine™ 2000 complexes were prepared as follows: in a sterile 14 ml tube 35.7 µg of the ViraPower™ Packaging Mix were diluted with 11.9 µg of pLenti6/V5-hTERT in 5.9 ml of Opti-MEM® I Medium without serum. In a separate sterile 14 ml tube 142.8 µl Lipofectamine™ 2000 was mixed gently with 5.9 ml of Opti-MEM® I Medium without serum and incubate for 5 minutes at room temperature. After 5 minutes of incubation, the diluted DNA was combined with the diluted Lipofectamine™ 2000 and incubated for 20 minutes at room temperature to allow the DNA-Lipofectamine 2000 complexes to form. The DNA-Lipofectamine™ 2000 complexes were added to a T-225 tissue culture flask containing 19.8 ml Opti-MEM® I medium with serum but without antibiotics. Then 19.8 ml of the 293FT cell suspension ( $23.76 \times 10^6$  total cells) was added to the flask containing media and DNA-Lipofectamine™ 2000 complexes. The cells were incubated overnight at 37°C in a humidified 5% CO<sub>2</sub> incubator. After 6 hours of incubation, the medium containing the DNA-Lipofectamine was removed and replace with 21 ml complete culture medium without antibiotics. Virus-containing supernatants were harvested 45 hours posttransfection by removing medium into to a 50 ml sterile, capped, conical tube. The supernatants were centrifuged at 3000 rpm for 15 minutes at +4°C to pellet debris. The collected viral supernatant was stored at -80°C until further use.

To determine the titer of lentiviral stocks, a kill curve experiment was performed to determine the minimum concentration of Blastcidin required killing non-transduced mammalian cell line within 14 days after addition of antibiotic. A 10-fold serial dilution was prepared from lentiviral stocks. The different dilutions (serial dilutions ranging from  $10^{-2}$  to  $10^{-6}$ ) of hTERT-lentivirus were transduced into HT1080 in the presence of the polycation Polybrene®. The stably transduced cells were select by using Blastcidin. The cell culture plates were stained by 1% crystal violet and the number of Blastcidin-resistant colonies was counted in each dilution. The titer of the lentiviral stocks were calculated as:  $(\sum (\text{Number of colonies}) \times 10^n) / \sum (\text{Number of plates})$  transducing units (TU)/ml.

## 2.4. Transduction and Analysis

hMSCs were transduced with pLenti6/V5-hTERT (Titer:  $5 \times 10^4$  TU/ml) at 5<sup>th</sup> passage using 6 µg/ml Polybrene. Successfully transduced hMSCs were selected with 10 µg/ml Blastcidin for 10 days. Expression of hTERT was confirmed by RT-PCR.

### 2.4.1 RNA extraction

#### Material:

Cells: Cells were harvested at around 10<sup>th</sup> passage at initial stage and around 40<sup>th</sup> passage. Samples were listed as below in this thesis:

hMSCs hTERT-transduced	<b>hMSCs-hTERT</b>
hMSCs hTERT-transduced, heterogeneous	<b>TERT</b>
hMSCs hTERT-transduced, single cell picking clone	<b>SCP 1,9,11,12</b>
hMSCs non-transduced	<b>hMSCs</b>
TERT-10 Passage (10P), SCP1-9P, SCP9-8P, SCP12-9P, hMSCs-11P	
TERT-44P, SCP1-42P, SCP9-35P, SCP11-45P, SCP12-46P, hMSCs-5P	

RNeasy<sup>®</sup> Mini Kit (Qiagen, Cat. No.74106, Germany):

RNeasy Mini Spin Columns

Collection Tubes (1.5 ml)

Collection Tubes (2 ml)

Buffer RLT

Buffer RW1

Buffer RPE

RNase-Free Water

$\beta$ -mercaptoethanol ( $\beta$ -ME) (Sigma, Cat. No.M7522, USA)

Ethanol (Merck KGaA, Cat. No.818760, Germany)

QIAshredder spin column (Qiagen, Cat. No. 79656, Germany).

#### Methods:

Total RNA was extracted respectively from cell culture using RNeasy<sup>®</sup> Mini Kit.

##### I . Pre-preparation:

Added 10  $\mu$ l  $\beta$ -ME per 1 ml Buffer RLT (Dispensed in a fume hood and wore appropriate protective clothing.)

Buffer RPE was a concentrate. Before using for the first time, added 4 volumes of ethanol (96–100%) as indicated on the bottle to obtain a working solution.

##### II . Harvesting cells:

Aspirated the medium, and washed the cells with PBS, aspirated the PBS, and added 1  $\times$  trypsin/EDTA. After the cells detached from the dish or flask, added medium (containing serum to inactivate the trypsin), transferred the cells to an

RNase-free polypropylene centrifuge tube, and centrifuged at 300 x g for 5 min  
Completely aspirated the supernatant.

### III. Disrupting the cells:

Loosened the cell pellet thoroughly by flicking the tube. Added 350 µl of Buffer RLT, pipetted to mix.

### IV. Homogenized the lysate:

Pipetted the lysate directly into a QIAshredder spin column placed in a 2 ml collection tube, and centrifuged for 2 min at full speed.

V. Added 1 volume of 70% ethanol to the homogenized lysate, and mixed well by pipetting.

VI. Transferred up to 700 µl of the sample to an RNeasy spin column placed in a 2 ml collection tube, centrifuged for 15 s at ~8000 x g (~10,000 rpm). Discarded the flow-through.

VII. Added 700 µl Buffer RW1 to the RNeasy spin column, centrifuged for 15 s at ~8000 x g (~10,000 rpm) to wash the spin column membrane. Discarded the flow-through.

VIII. Added 500 µl Buffer RPE to the RNeasy spin column, centrifuged for 15 s at ~8000 x g (~10,000 rpm) to wash the spin column membrane. Discarded the flow-through.

IX. Added 500 µl Buffer RPE to the RNeasy spin column, centrifuged for 2 min at ~8000 x g (~10,000 rpm) to wash the spin column membrane.

X. Placed the RNeasy spin column in a new 2 ml collection tube, centrifuged at full speed for 1 min

XI. Placed the RNeasy spin column in a new 1.5 ml collection tube, added 30µl RNase-free water directly to the spin column membrane, centrifuged for 1 min at ~8000 x g (~10,000 rpm) to elute the RNA.

### 2.4.2 Reverse transcription of RNA into cDNA

1µg of RNA was transformed into cDNA using AMV first-strand cDNA synthesis kit (Invitrogen, USA).

Material:

RNA (1 $\mu$ g) from above sample.

Cloned AMV First-Strand cDNA Synthesis Kit (Invitrogen, Cat. No. 12328-040, USA)

Cloned AMV RT (15 U/ $\mu$ l)

5X cDNA Synthesis Buffer\*

0.1 M DTT

10 mM dNTP Mix

RNaseOUT. (40 U/ $\mu$ l)

Oligo (dT)<sub>20</sub> (50  $\mu$ M)

Random Hexamers (50 ng/ $\mu$ l)

DEPC-Treated Water

MultiCycler (MJ Research, Cat. No. PTC200, USA)

#### Methods:

I . In a 0.2 ml tube, combined 50 ng/ $\mu$ l random primer, RNA, and dNTP mix. Adjusted the volume to 12  $\mu$ l with DEPC-treated water.

Primer	1 $\mu$ l
RNA (1 $\mu$ g)	x $\mu$ l (different volume according to concentration)
10 mM dNTP Mix	2 $\mu$ l
DEPC-treated water to	12 $\mu$ l

II . Denatured the RNA and primers by incubating at 65°C for 5 min and then placed on ice.

III. Vortexed the 5X cDNA Synthesis Buffer for 5 sec.

IV. Prepared the following master reaction mix on ice and vortex gently.

5x cDNA Synthesis Buffer	4 $\mu$ l
0.1 M DTT	1 $\mu$ l
RNaseOUT. (40 U/ $\mu$ l)	1 $\mu$ l
DEPC-treated water	1 $\mu$ l
Cloned AMV RT(15 units/ $\mu$ l)	1 $\mu$ l
(Total Volume)	8 $\mu$ l

V . Pipetted 8  $\mu$ l of the master reaction mix into each reaction tube on ice.

VI. Transferred the reaction tube to the MultiCycler. Incubated at 25°C for 10 min, followed by 20-50 min at 50°C

VII. Terminated the reaction by incubating at 85°C for 5 min

### 2.4.3 Detection of the hTERT gene expression by polymerase chain reaction (PCR)

The hTERT gene at mRNA level was detected by PCR using Taq polymerase with the amplification of  $\beta$ -actin as control.

#### Material:

Taq DNA Polymerase, recombinant (Invitrogen, Cat. No. 10342-053, USA)

10X PCR Buffer, Minus  $Mg^{2+}$

50 mM Magnesium Chloride ( $MgCl_2$ )

#### Primers of hTERT:

(Forward) 5'-CTACGGCGACATGGAGAAC-3',

(Reverse) 5'-GACACTTCAGCCGCAAGAC-3'

#### Primers for $\beta$ -actin:

(Forward) 5'-GCACTCTTCCAGCCTTCC-3'

(Reverse) 5'-AGAAAGGGTGTAACGCAACTAAG-3' (Synthesized by Invitrogen).

#### Methods:

I . Added the following components to a sterile 0.5-ml microcentrifuge tube sitting on ice(Prepared master mix for multiple reactions):

10X PCR buffer, minus Mg	2 $\mu$ l (1X)
10 mM dNTP mixture	0.4 $\mu$ l (0.2 mM each)
50 mM $MgCl_2$	0.6 $\mu$ l (1.5 mM)
Primer mix (10 $\mu$ M each)	1 $\mu$ l (0.5 $\mu$ M each)
Template DNA	1–20 $\mu$ l
Taq Polymerase (5 U/ $\mu$ l)	0.2 $\mu$ l (1.0 unit)
Autoclaved distilled water to	20 $\mu$ l

II . Mixed contents of tube.

III. Capped tubes and centrifuged briefly to collect the contents to the bottom.

IV. Perform PCR amplification as follows:

<b>PCR programm: <math>\beta</math>-actin</b>			
Step	T (C°)	time	Repeats
1. Predenaturation	95	3 min	
2. Denaturation	95	1 min	25x
3. Annealing	55	1 min	
4. Extension	72	1 min	
5. Final extension	72	10 min	
6.	4	for ever	
7.	end		
Expected size of the amplified band			bp
$\beta$ -actin			385

<b>PCR programm: hTERT</b>			
Step	T (C°)	time	Repeats
1. Predenaturation	95	10min	
Hotstart			
2. Denaturation	95	30sec	35x
3. Annealing	54	30sec	
4. Extension	72	1min	
5. Final extension	72	10 min	
6.	4	for ever	
7.	end		
Expected size of the amplified band			bp
hTERT			413

V. Analyzed the amplification products by 1% agarose gel electrophoresis and visualized by ethidium bromide staining. Used 100 bp DNA molecular weight standards.

## 2.5. Single cell picking

Single cell was picked by limited dilution at 7<sup>th</sup> passage and expanded into single-cell-picking clone (SCP). Of 22 single-cell-picking clones, SCP1, SCP9, SCP11 and SCP12 were continuously passaged and compared with heterogeneous hTERT-transduced hMSCs and non-transduced hMSCs.

Material:



Petri dish 100 x 20mm (Falcon, Cat. No. 353003, USA)

6-well-plate (Nunclon, Cat. No140675, Denmark)

10 µl Pipette tips (Diamond D10 Easy Pack 1000) (Gilson, Cat. No. F 161631, France)

#### Methods:

- I . Seeded cells at 75 cells / cm<sup>2</sup> in T-25 flask or 5000 cells in the 100 x 20mm Petri dish 4-5 days earlier before single cell picking.
- II . Pipetted 100 µl medium drop in each well of 6-Well-plate (Field A1 empty for control).
- III. Trypsinized cells about 3 min and picked them up in 5 ml medium.
- IV. Diluted the above cell suspension to 1:10 in a 15 ml falcon tube (i.e. 1 ml cell solution and 9 ml PBS).
- V . Pipetted 5 ml of the dilution in a Petri dish.
- VI. Out of the flow, picked one cell with a 10 µl Pipette (positioned to 3 µl) and pipetted the cell into the drop of the medium (If it was not possible to pick single cell, diluted the cell suspension further).
- VII. Into the flow, pipetted 2 ml of the cell suspension in control well-A1.
- VIII. Pipetted 2 ml of medium into each well after 2-4 hours.
- IX. Documented the result by making pictures under microscope with digital camera.

## 2.6. Proliferation assay

### 2.6.1 Morphological observation

Cells of non-transduced, clonal and heterogeneous hTERT-transduced hMSCs were continuously passaged. Cells were observed and photographed under phase contrast microscope (Axiovert S100, Carl Zeiss, Germany) to check and document the morphology of cells.

### 2.6.2 Cumulative population doubling level (PDL) and population doubling time (PDT)

Long-term cell growth *in vitro* was monitored by cell number count and PDL and PDT calculation. Before 40% confluence, cells were trypsinized by 1× trypsin / EDTA,

stained by trypan blue and counted by a hemocytometer. Trypan blue was a vital diazo dye that was used to color dead tissues or cells blue. Live cells or tissues with intact cell membranes would not be colored. Since cells were very selective in the compounds that passed through the membrane, trypan blue was not absorbed in a viable cell; however, it traversed the membrane in a dead cell. Hence, dead cells were shown as a distinctive blue colour under a microscope. So this staining method was used to discern live cells from dead cells in counting.

#### Material:

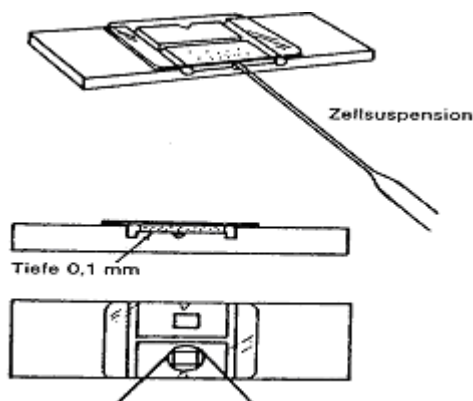
Hemocytometer (Improved Neubauer, Superior Ltd, Germany)

0.4% Trypan blue (Gibco, Cat. No. 15250-061, USA)

Invert Microscope (Diavert, Leitz Wetzlar, Germany)

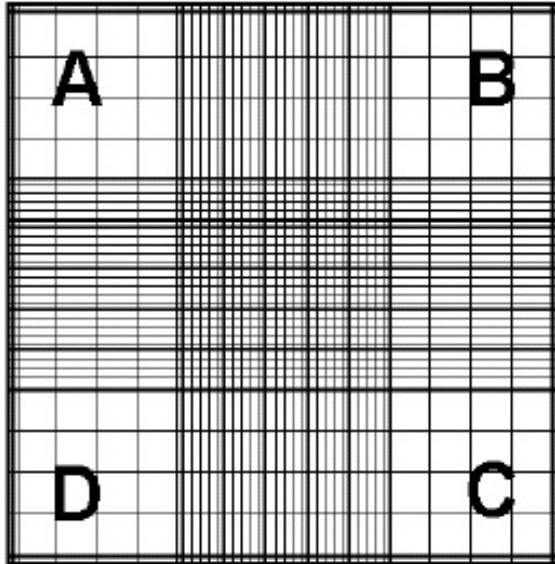
#### Methods:

- I . Trypsinized cells and resuspended in definite volume (V) of medium under laminar air flow hood;
- II . Collected 50 - 100  $\mu$ l cells suspension in one 1.5 ml microfuge tube;
- III. Put 10  $\mu$ l cell suspension and 5  $\mu$ l trypan blue into a new microfuge tube and mixed;
- IV. Put one drop (5-8  $\mu$ l) of trypan blue/cell suspension mixture under the cover glass on the hemocytometer;



**Figure 3.** Cell suspension was put under the cover glass on the hemocytometer

V. Counted Cells under 10 x object lens. Only non-blue-stained cells were counted. Cell number in the area of A, B, C, D and on the upper and left border of A, B, C, D were added together.



**Figure 4.** Cell counting area of the hemocytometer

$$\text{Cell number} = ((A+B+C+D)/4) \times 1.5 \times V \quad (V: \text{cell suspension volume})$$

VI. Population doubling was used to describe cell growth in logarithmic mode, population doubling gained at each passage was determined using the formula below:

$$PD = (\log (N_n / N_0)) / \log 2, \text{ or}$$

$$PD = (\log (N_n / N_0)) \times 3.33$$

$N_n$  = Number of cells harvested at the end of a period of growth;

$N_0$  = Number of cells plated initially in the growth vessel.

Cumulative population doubling level (PDL) was thus the sum of population doublings:

$$PDL_n = \sum PD_{(1, n)} \quad (n: \text{Number of passage})$$

VII. Population doubling time (PDT, also called the generation time), was the period of time required for cell number to double. To calculate PDT, the time period for the cells to growth was divided by the population doubling value which was gained in the same time period. The formula was as below:

PDT = Time period (day) / PD

Both PDL and PDT were used to evaluate and compare the growth rate of hTERT-transduced and non-transduced hMSCs.

## 2.7. Senescence-associated $\beta$ -gal staining

The cellular senescence process was associated with aging. The decrease in cell division was virtually irreversible and complete. In conjunction with the loss of the ability to divide, changes occurred in the morphology and in their pattern of gene expression of the cells. At the end of the senescence cell death usually occurred, although the cells might remain viable for a long time. The senescent cells staining assay was based on a histochemical stain for  $\beta$ -galactosidase activity at pH 6. Under these conditions,  $\beta$ -galactosidase activity was easily detectable in senescent cells, but undetectable in quiescent, immortal, or tumor cells. In the experiment, hMSCs, non-transduced, clonal and heterogeneous hTERT-transduced, were cultured in 6-well plates and stained by senescence cells histochemical staining kit.

### Material:

Senescent cells staining kit (Sigma, Cat. No. CS0030, USA)

Fixation buffer 10X (Product Code F 1797) solution containing 20% formaldehyde, 2% glutaraldehyde, 70.4 mM Na<sub>2</sub>HPO<sub>4</sub>, 14.7 mM KH<sub>2</sub>PO<sub>4</sub>, 1.37 M NaCl, and 26.8 mM KCl;

Reagent B (Product Code R 5272) 400 mM Potassium Ferricyanide;

Reagent C (Product Code R 5147) 400 mM Potassium Ferrocyanide;

X-gal solution (Product Code X 3753) 40 mg/ml.

Ultra pure water (Sigma, Cat. No. W4502-1L, USA)

6-well-plate (Nunclon, Cat. No. 140675, Denmark)

### Methods:

#### I . Preparation of staining solution:

The amounts of reagents detailed in the procedure were for 6 tests performed on 35 mm plates. For plates/wells of different sizes, calculated the volumes of the reagents required according to the table:

Plate	Well diameter (mm)	Growth area (cm <sup>2</sup> )	Volume relative to 35 mm plate
100mm	100.00	78.50	8.26 x
60mm	60.00	30.00	3.15 x
35mm	35.00	9.50	1 x
6 well	34.80	9.50	1 x
12 well	22.10	3.80	0.4 x
24 well	15.60	1.90	0.2 x
96 well	6.40	0.32	0.034 x

X-gal solution: warmed the X-gal solution at 37 °C for 1 hour.

Fixation buffer 1X: diluted the fixation buffer 10X 10-fold with ultra pure water.

PBS 1X: diluted the PBS 10X 10-fold with ultra pure water.

Staining mixture (Prepared just prior to use): mixed the following for preparation of 10 ml of the staining mixture:

Staining solution 10X	1 ml
Reagent B	125 µl
Reagent C	125 µl
X-gal solution	0.25 ml
Ultra pure water	8.50 ml

Filtered the staining mixture using a 0.2 mm filter to ensure there were no aggregates in the solution (very important!).

## II. Procedure of staining:

Aspirated the growth medium from the cells.

Washed the cells twice with 1 ml of 1X PBS per well/plate. Carefully removed the entire wash solution by aspiration, so the cells did not detach.

Added 1.5 ml per well of 1X fixation buffer and incubated the plate for 6–7 minutes at room temperature.

Rinsed the cells 3 times with 1 ml of 1X PBS per well/plate.

Added 1 ml of the staining mixture per well.

Incubated at 37 °C without CO<sub>2</sub> for 12 hours until the cells were stained blue.

Sealed the plate with Parafilm to prevent it from drying out. Checked the pH value before sealing the plate, adjusted the pH value to 6 with HCl or NaOH when it was not the right pH value.

After staining the staining mixture was replaced with 1X PBS. The cells were observed under a microscope and photos were taken.

## 2.8. Differentiation assay

Clonal and heterogeneous hTERT-transduced hMSCs were induced at different passages (SCP1-47<sup>th</sup> Passage, SCP11-68<sup>th</sup> Passage, TERT-52<sup>nd</sup> Passage) into three mesodermal lineages by lineage-specific medium.

2.8.1. Adipogenic differentiation.

2.8.1.1. Adipogenic induction:

Material:

Medium: DMEM + 4500 mg/L Glucose + GlutaMAX I + Pyruvat (PAA, Cat. No. E15-843, Austria)

Fetal bovine serum (FBS), heat inactivated (Sigma, Cat. No. 103K3395, USA)

Penicillin/Streptomycin (Gibco, Cat. No. 1202798, USA)

Dexamethasone (Sigma, Cat. No. D-2915, USA)

Indomethacin (Sigma, Cat. No. I-5879, USA)

Insulin (Sigma, Cat. No. I-0516, USA)

3-Isobutyl-1-methylxanthin (IBMX) (Sigma, Cat. No. I-7378, USA)

Methods:

I . Prepared medium for induction according to the chart below:

Substance	Concentration in stock solution	Concentration in medium	Amount
Medium DMEM h-g			8600 µl
FBS	100 %	10 %	1000 µl
Penicillin/Streptomycin	10000 IU/ml	40 IU/ml	40 µl
Dexamethasone	50 µM	1 µM	200 µl
Indomethacin	50 mM	0,2 mM	40 µl
Insulin	10 mg/ml	0,1 mg/ml	100 µl
IBMX	500 mM	1 mM	20 µl
			10000 µl

II. Prepared medium for conservation according to the chart below:

Substance	Concentration in stock solution	Concentration in medium	Amount
Medium DMEM h-g			8900 $\mu$ l
FBS	100 %	10 %	1000 $\mu$ l
Penicillin/Streptomycin	10000 IU/ml	40 IU/ml	40 $\mu$ l
Insulin	10 mg/ml	0,1 mg/ml	100 $\mu$ l
			10040 $\mu$ l

III. Counted the cells.

IV. Plated the cells in a concentration of 10000 cells/cm<sup>2</sup>.

V. Started the differentiation at total confluence.

VI. Used induction medium for 5 days and conservation medium for 2 days.

VII. Differentiated cells for 21 days.

2.8.1.2. Adipogenic staining:

After adipogenic differentiation, cells in well-plate were stained by Oil red O for intracellular fat droplets.

Material:

Oil red O (Sigma, Cat. No. O-0625, USA)

Isopropanol (Merck KGaA, Cat. No.1.09634.2500, Germany)

Distilled water (dH<sub>2</sub>O)

4 % Formaldehyde solution, neutralized (Fischer GmbH, Cat. No. 6333115, Germany)

Filter Whatmann 42 (Herolab GmbH, Laborgeräte Wieloch, Germany)

50 % Ethanol (Merck KGaA, Cat. No.818760, Germany)

Methods:

I. Prepared Oil red O staining solution.

0.3% Oil red O stock solution:

Diluted 150 mg Oil red O in 50 ml Isopropanol, mixed for 10 min with stirrer (Stable for use within one month).

0.2% Oil red O working solution:

Mixed 12 ml stock solution with 8 ml dH<sub>2</sub>O, stood on bench for 10 min, filtered with Filter Whatman 42 (Stable for use within 3 hours).

II. Aspirated culture medium.

III. Fixed cells with pre-colded 4 % formaldehyde for 2 min at –20°C.

IV. Washed with pre-colded 50% ethanol.

V. Stained cells with 0.2% Oil red O Working solution for 20 min

VI. Washed with 50% ethanol.

VII. Washed with dH<sub>2</sub>O for 1 min with shaking.

VIII. Observed under microscope. Positive cells were stained strong orange or red in the cytoplasm.

## 2.8.2. Chondrogenic differentiation.

### 2.8.2.1. Chondrogenic induction:

#### Material:

Medium: DMEM + 4500 mg/L Glucose + GlutaMAX I + Pyruvat (PAA, Cat. No. E15-843, Austria)

Penicillin/Streptomycin (Gibco, Cat. No. 1202798, USA)

Dexamethasone (Sigma, Cat. No. D-2915, USA)

Sodium pyruvate (Sigma, Cat. No.: S-8636, USA)

L– Ascorbic acid (Sigma, Cat. No. A-8960, USA)

L-Proline (Sigma, Cat. No.: P-5607, USA)

ITS 100x (Sigma, Cat. No.: I-3146, USA)

Linoleic acid (Sigma, Cat. No.: L5900, USA)

Bovine serum albumin (BSA) (Sigma, Cat. No.: A-9418, USA)

15mL polypropylene tube (Sarstedt, Cat. No. 62.554.502 ,Germany)

Recombinant human transforming growth factor-β3 (TGF-β3) (R & D Systems, Cat. No. 243-B3, USA),

#### Methods:

I . Prepared the incomplete medium according to the chart below:



Substance	Concentration in stock solution	Concentration in medium	Amount
Medium DMEM h-g			47100 $\mu$ l
Penicillin/Streptomycin	10000 IU/ml	40 IU/ml	200 $\mu$ l
Dexamethasone	50 $\mu$ M	0,1 $\mu$ M	100 $\mu$ l
Sodium pyruvate	100 mM	1 mM	500 $\mu$ l
L- Ascorbic acid	12,5 mM	0,195 mM (50 $\mu$ g/ml)	780 $\mu$ l
L-Proline	175 mM	0,35 mM	100 $\mu$ l
ITS	100x	6,25 $\mu$ g/ml Insulin 6,25 $\mu$ g/ml transferrin 6,25 ng/ml Selenite	625 $\mu$ l
Linoleic acid	2,677 mg/ml (500x)	5,35 $\mu$ g/ml	100 $\mu$ l
BSA	125 mg/ml	1,25 mg/ml	500 $\mu$ l
			50005 $\mu$ l

II . Added 1  $\mu$ l TGF- $\beta$ 3 to 2 ml incomplete medium to establish complete medium with the final concentration of TGF- $\beta$ 3 was 10ng/ml.

III. Trypsinized and harvested the cells by 1 $\times$  trypsin/EDTA.

IV. Counted the cells (200000 cells were needed for one pellet).

V . Transferred the cell-suspension into a 15 ml tube.

VI. Centrifuged the cells at 150g, RT for 5min, and evacuated the medium.

VII. Resuspended the cells in 1 ml incomplete medium (control pellet with normal DMEM medium).

VIII. Centrifuged the cells and evacuated the medium.

IX. Resuspended the cells in 1 ml complete medium (control pellet with normal medium).

X . Centrifuged the cells (Did not evacuate the medium).

XI. Untwisted the cap of the tube for incubation in the incubator.

XII. Incubated the pellets (Did not take the tubes out of the incubator in the first 24 hours). After 24 hours the pellet should swim in the medium.

XIII. Changed the medium every two to three days (Did not aspirate the pellet).

XIV. Flipped the tube carefully after changing the medium to relieve the pellet from the wall of the tube.

XV. Control pellets were cultured with DMEM.

XVI. The pellets were fixed and sectioned for toluidine blue staining after 5 weeks.

#### 2.8.2.2. Chondrogenic staining:

Toluidine blue staining was employed to stain proteoglycan that was formed during chondrogenic differentiation. Extracellular proteoglycan formation was stained bright blue during chondrogenesis.

#### Material:

Toluidine blue O (Merck KGaA, Cat. No. 52040, Germany)

#### Methods:

##### I . Prepared 1% Toluidine blue stain:

Weighed toluidine blue 1g and natrium tetraborate 1g, diluted them in 100ml dH<sub>2</sub>O, filtered twice with filter paper.

##### II . Stained section slides with 1% Toluidine blue for 1 min

III. Washed slides with tap water for 120 min (Changed water every 20 min until no stain would be washed off from the slides).

IV. Mounted the 6-well-plates with Di-n-butylPhthalate in Xylene (DPX), took photos under microscope.

#### 2.8.3. Osteogenic differentiation.

##### 2.8.3.1. Osteogenic induction:

#### Material:

Medium: DMEM + 4500 mg/L Glucose + GlutaMAX I + Pyruvat (PAA, Cat. No. E15-843, Austria)

Fetal bovine serum (FBS), heat inactivated (Sigma, cat. No. 103K3395, USA)

Penicillin/Streptomycin (Gibco, Cat. No. 1202798, USA)

Dexamethasone (Sigma, Cat. No. D-2915, USA)

β- Glycerophosphate (Sigma, Cat. No. G-9891, USA)

L- Ascorbic acid (Sigma, Cat. No. A-8960, USA)

#### Methods:

##### I . Prepared the osteogenic differentiation medium according to the chart below:

Substance	Concentration in stock solution	Concentration in medium	Amount
Medium DMEM h-g			22100 $\mu$ l
FBS	100 %	10 % (v/v)	2500 $\mu$ l
Penicillin/Streptomycin	10000 IU/ml	40 IU/ml	100 $\mu$ l
Dexamethasone	50 $\mu$ M	100 nM	50 $\mu$ l
$\beta$ – Glycerophosphate	1.66 M	10 mM	151 $\mu$ l
L – Ascorbic acid	12.5 mM	50 $\mu$ M	100 $\mu$ l
			25001 $\mu$ l

II. Trypsinized and counted cells.

III. Seeded cells at 4000 – 5000 cells /  $\text{cm}^2$  in 6-well plates.

IV. Started differentiation at 70% - 80% confluence (24h – 48h after seeding)

V. Changed medium twice a week (Inducing medium could be used in 4 weeks after preparation);

VI. Induced cells for 21 days.

VII. Control cells were cultured without inducing supplements.

#### 2.8.3.2. Osteogenic staining:

Cells in well-plates were stained by van Kossa reagents and photographed under invert microscope. Von Kossa staining was applied for demonstrating deposits of extracellular calcium or calcium salt. In this method, tissue or cell culture were treated with a silver nitrate solution and the silver was deposited by replacing the calcium reduced by the strong light, and thereby visualized as metallic silver.

Material:

Methanol (Aldrich, Cat. No. 49443-7, USA)

Distilled water ( $\text{dH}_2\text{O}$ )

5% Silver Nitrate ( $\text{AgNO}_3$ ) solution (Carl Roth GmbH, Cat. No. 7908.1, Germany)

1% Pyrogallol solution (Apotheke innenstadt Uni München, Cat. No. P0121, Germany)

5% Sodium hydroxide ( $\text{NaOH}$ ) (Merck KGaA, Cat. No. B948769 301, Germany)

Tap water

May-Grünwald's eosine-methylene blue solution modified (Merck KGaA, Cat. No. OB486153, Germany)

#### Methods:

- I . Fixed cells with methanol for 15 min
- II . Washed with dH<sub>2</sub>O for 20 min
- III. Stained with 5% AgNO<sub>3</sub> for 20 min at dark place.
- IV. Washed with dH<sub>2</sub>O for 3 min, twice.
- V . Stained with 1 % pyrogallol for 5 min to demonstrate cytoplasm.
- VI. Washed with dH<sub>2</sub>O for 3 min
- VII. Fixed with 5% NaOH for 4 min
- VIII. Washed with tap water carefully for 3 min, twice.
- IX. Washed with dH<sub>2</sub>O.
- X . Stained with May-Grünwald's eosine-methylene blue solution modified for 10 min to demonstrate cell nucleus.
- XI. Washed with dH<sub>2</sub>O.
- XII. Took photos under microscope, sealed well-plate with Parafilm and stored.
- XIII. Staining result: Calcified region-dark black, cell nucleus-blue, cytoplasm-red.

## 2.9. Karyotype (cytogenetics) analysis

Cytogenetics studies were performed on metaphase cells derived from clonal hMSCs-hTERT SCP1 at 92<sup>nd</sup> passage, SCP11 at 89<sup>th</sup> passage and SCP12 at 80<sup>th</sup> passage. Harvesting and fixation followed standard protocols. Chromosome analysis was performed using the GTG-banding technique with a 400 bphs resolution. Fifteen metaphases captured by a CCD-camera were analysed and karyotyped using a karyotyping software. Chromosome identification and karyotype description were made in accordance with the International System for Chromosome Nomenclature.

To investigate whether the identified deletion found in cytogenetics analysis already pre-existed, two-colour fluorescence *in situ* hybridization (FISH) was performed on hTERT-hMSCs (passage 11) and hMSC (passage 12) using subtelomeric probes 16PTER and 16QTER (Abbott Diagnostics, Wiesbaden, Germany). The

16PTER-probe was labelled in green (SpectrumGreen) and the 16QTER-probe in red (SpectrumOrange). Hybridization solution and probes were mixed 1:1 (followed manufacturer's protocols), dropped onto chromosome slides and covered. Co-denaturation of the slides was performed at 73°C for 2 min. followed by incubation at 37°C in a humidified chamber over night. After hybridization, the slides were washed following probe protocols and mounted in vectrashield mounting medium for fluorescence with DAPI (4',6-diamino-2-phenylindole) (Linaris, Wertheim, Germany). Fluorescence signals were observed with a Zeiss fluorescence microscope. A total of 198 interphase nuclei were analyzed.

## 2.10. Tumor suppressor gene assay

RNA from different passages of clonal, heterogeneous hTERT-transduced and non-transduced hMSCs were extracted respectively and checked for the expression of the tumor suppressor genes —retinoblastoma 1 (RB1), tumor protein 53 (TP53) and cyclin-dependent kinase inhibitor 1A (CDKN1A, p21) by polymerase chain reaction (PCR).

Material:

Cells:

Initial period: SCP1-9 P, SCP9-8P, SCP11-13P, SCP12-9P, TERT-10P.

Plateau period: SCP1-42P, SCP9-35P, SCP11-45P, SCP12-46P, TERT-44P

Rapid-growing period: SCP1-62P, SCP11-63P

Non-transduced hMSCs-5P, MG63 (osteosarcoma cell line) were employed as control.

RNeasy<sup>®</sup> Mini Kit (Qiagen, Cat. No.74106, Germany).

Cloned AMV First-Strand cDNA Synthesis Kit (Invitrogen, Cat. No. 12328-040, USA)

Taq polymerase (Invitrogen, Cat. No. 10342-053, USA)

Primers (Synthesized by invitrogen):

Primers of RB1:

(Forward) 5'-TTTCAGAAGGTCTGCCAACACCAA-3',

(Reverse) 5'-GTGTCCACCAAGGTCCTGAGATCC-3'

Primers of TP53:

(Forward) 5'- AAGGAAATTTGCGTGTGGAG-3'

(Reverse) 5'- TTCTGACGCACACCTATTGC-3'

Primers of p21:

(Forward) 5'-GAACTTCGACTTTGTCACCGAG-3'

(Reverse) 5'-CGTTTTTCGACCCTGAGAGTCTC-3'

Primers for  $\beta$ -actin (internal control):

(Forward) 5'-GCACTCTTCCAGCCTTCC-3'

(Reverse) 5'-AGAAAGGGTGTAACGCAACTAAG-3'

Methods:

- I . Extracted RNA from cells by RNeasy<sup>®</sup> Mini Kit.
- II . Reverse transcriptized RNA into cDNA by AMV first-strand cDNA synthesis kit.
- III. Detected RB1, TP53 and p21 gene expression by PCR using Taq polymerase, with the amplification of  $\beta$ -actin as control.
- IV. Performed PCR amplification as follows:

<b>PCR programm: RB1</b>			
Step	T (C°)	time	Repeats
1. Predenaturation	95	5 min	
2. Denaturation	94	1 min	35x
3. Annealing	58	1 min	
4. Extension	72	1 min	
5. Final extension	72	10 min	
6.	4	for ever	
7.	end		
Expected size of the amplified band			bp
RB1			368

<b>PCR programm: TP53</b>			
Step	T (C°)	time	Repeats
1. Predenaturation	95	5 min	
2. Denaturation	95	45 sec	32x
3. Annealing	58	45 sec	
4. Extension	72	1 min	
5. Final extension	72	5 min	
6.	4	for ever	

7.	end		
Expected size of the amplified band			bp
TP53			702

<b>PCR programm: p21</b>			
Step	T (C°)	time	Repeats
1. Predenaturation	94	1 min	
2. Denaturation	92	30 sec	30x
3. Annealing	60	30 sec	
4. Extension	75	90 sec	
5. Final extension	72	10 min	
6.	4	for ever	
7.	end		
Expected size of the amplified band			bp
p21			279

<b>PCR programm: <math>\beta</math>-actin</b>			
Step	T (C°)	time	Repeats
1. Predenaturation	95	3 min	
2. Denaturation	95	1 min	25x
3. Annealing	55	1 min	
4. Extension	72	1 min	
5. Final extension	72	10 min	
6.	4	for ever	
7.	end		
Expected size of the amplified band			bp
$\beta$ -actin			385

V. Analyzed the amplification products by 1% agarose gel electrophoresis and visualized by ethidium bromide staining. Used 100 bp DNA molecular weight standards.

## 2.11. Cell transformation soft agar assay

### Test principle

Neoplastic cell transformation resulted from the accumulation of genetic mutations that permitted uncontrolled proliferation and independence from normal homeostatic regulation. Cell changes manifested by escape from control mechanisms, increased growth potential, alterations in cell surface, karyotypic abnormalities, morphological and biochemical deviations, and other attributes conferring the ability to invade, metastasize and kill.

Neoplastic transformation was associated with certain phenotypic changes *in vitro*, such as loss of contact inhibition (cells could grow over one another) and anchorage independence (cells formed colonies in soft agar). Anchorage independence could be described in the light of primary fibroblasts and many fibroblastic cell lines (e.g. BALB/c3T3, NIH-3T3, etc.) that had to attach to a solid surface before they could divide. They failed to grow when suspended in a viscous fluid or gel (e.g. agar or agarose). However when these cell lines were transformed, they were able to grow in a viscous fluid or gel and became anchorage-independent. The process, by which these phenotypic changes occurred, was assumed to be closely related to the process of *in vivo* carcinogenesis. Cells derived from transformed colonies after passaging in culture were capable of tumor formation when inoculated in a suitable host animal.

Cell transformation soft agar assay was an anchorage-independent growth assay in soft agar, which was considered the most stringent assay for detecting malignant transformation of cells. For this assay, cells were cultured with appropriate control cells in soft agar medium for 21-28 days. Following this incubation period, formed colonies could be analyzed morphologically using cell stain solution.

### Material:

Agarose powder

Crystal violet (Sigma, Cat. No. C3886, USA) (Stock solution: 1% Crystal violet in 10% ethanol)



Cells: SCP1-40<sup>th</sup> P, SCP11-40<sup>th</sup> P, and SCP12-41<sup>st</sup> P. Human fibrosarcoma cell line-HT1080 and non-transduced hMSCs-13<sup>th</sup> P were employed as positive and negative control.

#### Methods:

I . Prepared 0.8% base agar layer as listed in below:

<b>Culture dish</b>	96-well	48-well	24-well	6-well	35mm	60mm	100mm
<b>Volume(ml/well)</b>	0.1	0.2	0.5	1.0	2.0	3.0	5.0

II . Prepared 0.4% top agar solution as listed in below:

<b>Culture dish</b>	96-well	48-well	24-well	6-well	35mm	60mm	100mm
<b>Volume(ml/well)</b>	0.05	0.1	0.25	0.5	1.0	1.5	2.5

III . Trypsinized and counted cells, harvested the appropriate number of cells according to table below by gentle centrifugation.

<b>Culture dish</b>	96-well	48-well	24-well	6-well	35mm	60mm	100mm
<b>Amount (cells/well)</b>	500	1000	1250	2500	5000	7500	12500
<b>Top agar with cells (ml/well)</b>	0.05	0.1	0.25	0.5	1.0	1.5	2.5

IV . Resuspended harvested cells in appropriate amount of 0.4% top agar solution ( $37\pm 2^{\circ}\text{C}$ ) according to the table above, made sure that a single cell suspension was obtained; aliquoted appropriately on top of base agar layer (pre-warmed to  $37^{\circ}\text{C}$ ). A well containing only base and top agar layers without cells was included; this would serve as a background control.

V . Incubated cells for 28 days at  $37^{\circ}\text{C}$  with 5%  $\text{CO}_2$  until colonies were formed.

VI . Fed cells 1-2 times per week with cell culture media.

VII . Stained well plates with 0.005% crystal violet for 2 hour after 28 days of culture.

VIII . Took photograph under a microscope.

## 2.12. *In vivo* implantation assay

### Material:

Athymic nude mice (Harlan-Winkelmann, Borchon, Germany)  
HT1080 (ATCC, Cat. No.CCL-121, USA)

### Methods:

Twenty athymic nude mice were divided into four groups with five mice in each group. A total of  $1 \times 10^6$  cells of each cell type (SCP-1, SCP-11, untransduced hMSCs and HT1080) were suspended in 250  $\mu$ l of phosphate buffered saline (PBS) and injected subcutaneously over the right ribcage. Injections were performed under general anaesthesia with isoflurane. Mice were sacrificed after 8 weeks by CO<sub>2</sub> overdose. All procedures were performed according to German animal protection legislation and approved by the Government Committee of Upper Bavaria (file reference 07-07). Animals were kept in individually ventilated cages "type II long" (Tecniplast, Italy). Free access to food and water was secured at all times.

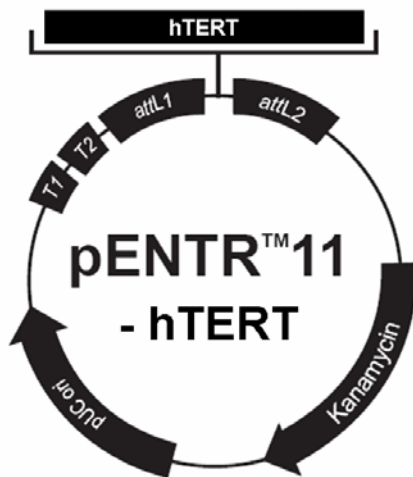
<b>Animals (number)</b>	<b>Cells (<math>1 \times 10^6</math> /250 <math>\mu</math>l)</b>	<b>Passage</b>	<b>Sample harvesting time (number of animals)</b>
5	SCP 1	90 <sup>th</sup>	8 weeks (5)
5	SCP 11	89 <sup>th</sup>	8 weeks (5)
5	hMSCs	11 <sup>th</sup>	8 weeks (5)
5	HT 1080		10 days (4), 8 weeks (1)

Photographs were taken for macroscopic evaluation. Skin and underlying soft tissue of the relevant area were dissected. Specimens were fixated in 4% paraformaldehyde. Samples were processed via cryosectioning. Samples were fixated and tissues were infiltrated with sucrose solution (3 hrs in 5% sucrose, 3 hrs in 10% sucrose, 12 hrs 20% sucrose). Specimens were frozen in Tissue Freezing Medium (Jung, Germany). Serial cuts were prepared with a slice thickness of 12 $\mu$ m. Representative slides of each animal were stained with haematoxylin and eosin (H.E.) and investigated for possible tumour growth.

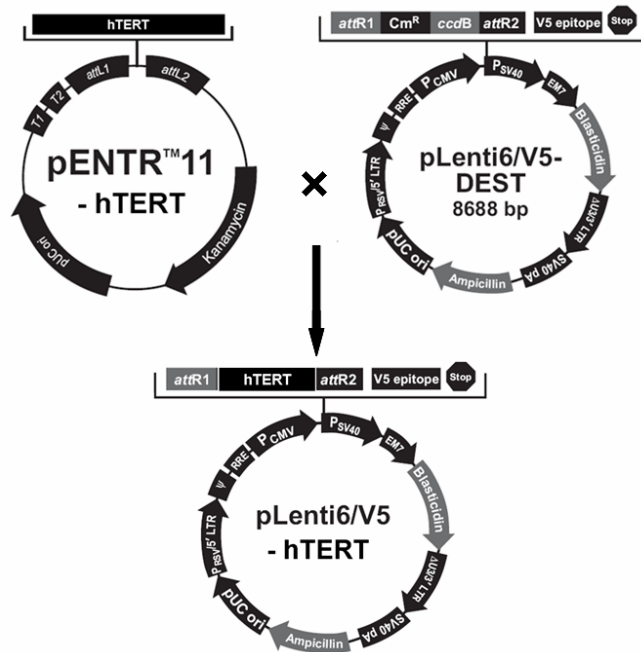
### 3. Results

#### 3.1. Construction of pLenti6/V5-hTERT and transduction of hMSCs

hTERT was isolated from pBABE-PURO plasmid by digestion with Sal I and linearized with Klenow large fragment. pENTR11 plasmid was digested with NotI and blunt ends were generated by Klenow. The resulting pENTR11 vector and hTERT fragment were ligated using Quick T4 ligase and pENTR11-hTERT was constructed (Figure 5). The coding sequence of hTERT was then transferred from pENTR11 into pLenti6V5-Dest by using LR Clonase reaction (Figure 6). To confirm that hTERT was correctly transferred into pLenti6V5-Dest vector, expression construct of pLenti6V5-hTERT was sequenced. The sequencing result showed that the coding sequence in the expression construct was totally in accordance with the gene record from the database of “National Institute of Health (NIH)” (Supplement II) .



**Figure 5.** Construct of pENTR11-hTERT. hTERT was inserted into pENTR11 vector between the recombination sites attL1,2.



**Figure 6.** LR recombination reaction and construction of pLenti6/V5-hTERT. An LR recombination reaction was performed between the attL-containing entry clone pENTR11-hTERT and the attR-containing destination vector pLenti6/V5-DEST to generate an expression clone pLenti6/V5-hTERT.

Lentivirous containing hTERT was generated by co-transfecting 293FT with pLenti6/V5-hTERT and packaging mix. hMSCs were transduced with pLenti6/V5-hTERT at 5<sup>th</sup> passage using 6 µg/ml Polybrene. Successfully transduced hMSCs were selected with 10 µg/ml Blasticidin for 10 days.

### 3.2. Expression of hTERT

Ectopic hTERT overexpression was detected in lentiviral hTERT-transduced heterogenous hMSCs (TERT), clonal SCP1, SCP9, SCP11 and SCP12 around 10<sup>th</sup> passage (TERT-10P, SCP1-9P, SCP9-8P, SCP12-9P) (Figure.7A), and around 40<sup>th</sup> passage (SCP1-42P, SCP9-35P, SCP11-45P, SCP12-46P, TERT-44P) by RT-PCR, while not in non-transduced hMSCs (Figure.7B).



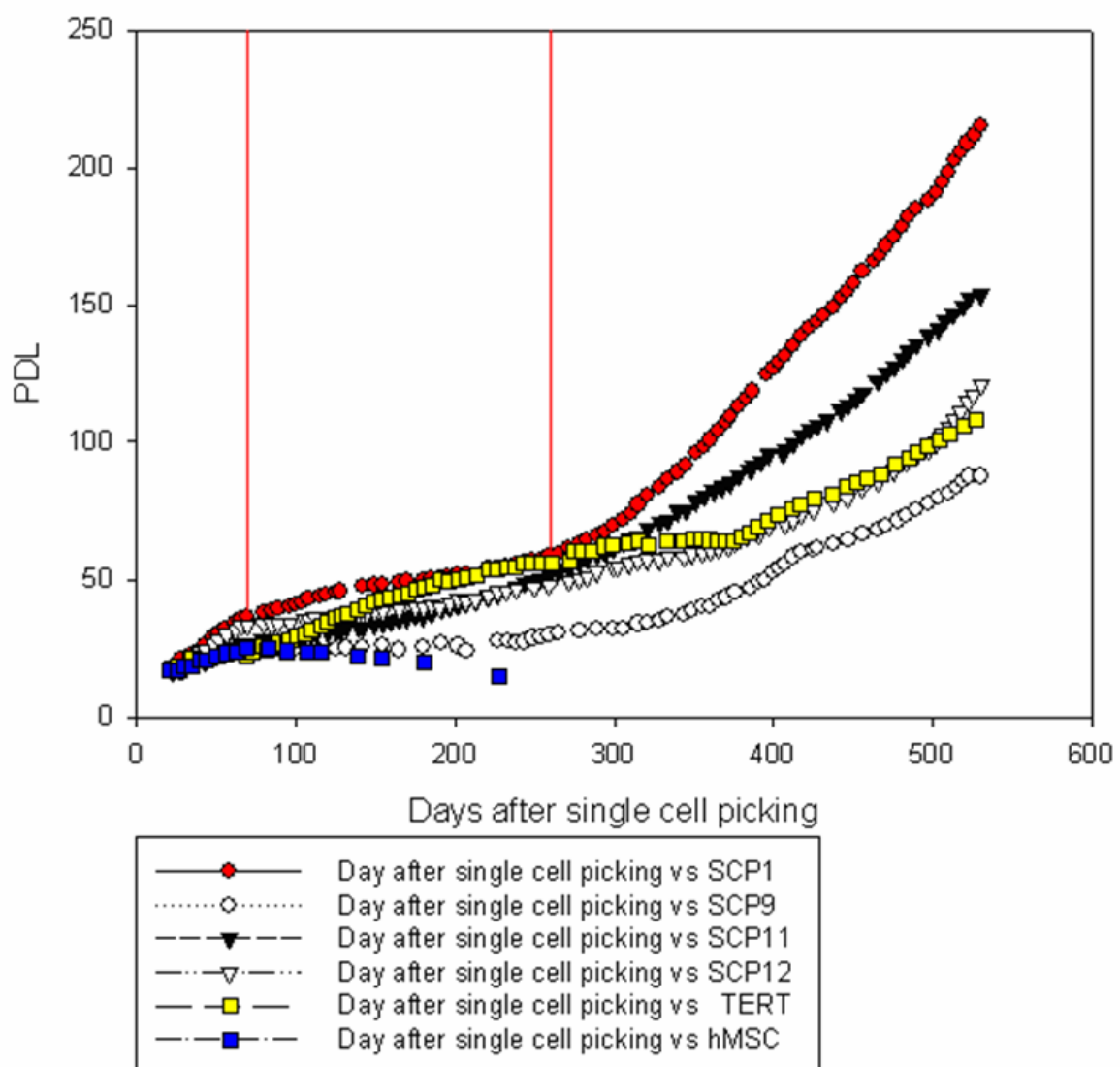
**Figure. 7** RT-PCR of hTERT in hTERT-transduced hMSCs. hTERT mRNA was detected positive in hTERT-transduced heterogeneous hMSCs (showed as TERT), single-cell-picking clone 1 (SCP1), SCP9, SCP11, SCP12 around 10<sup>th</sup> passage (**A.** TERT-10P, SCP1-9P, SCP9-8P, SCP12-9P, hMSCs-11P) and around 40<sup>th</sup> passage (**B.** SCP1-42P, SCP9-35P, SCP11-45P, SCP12-46P, TERT-44P, hMSCs-5P); while no hTERT expression was detected in non-transduced hMSCs.  $\beta$ -actin was amplified as control.

### 3.3. Growth kinetics of hTERT-transduced hMSCs cell lines

Growth characteristics of clonal SCP1, SCP9, SCP11, SCP12, heterogeneous hMSCs-hTERT (TERT) and untransduced hMSCs were monitored by calculating cumulative population doubling level (PDL) and population doubling time (PDT). As showed in figure 8 and table 3, three distinct growth periods of hMSCs-hTERT could be noticed. In the “initial period”, single cell picked clonal hMSCs-hTERT (SCP1, SCP9, SCP11 and SCP12) and heterogeneous hMSCs-hTERT had PDT from 2.3 to 5.5 (PDL from 20.7 to 27.1), comparable to non-transduced hMSCs that it was 8.5 for PDT (21.0 for PDL). Then the growth of hMSCs-hTERT, either clonal or heterogenous, got into a growth “plateau period”, with PDT from 9.2 to 22.1 (PDL from 30.6 to 48.2), while non-transduced hMSCs got into senescence, with a negative PDT of -15.3.

After this growth-retarding plateau period, all of hMSCs-hTERT exhibited a higher growth rate, with PDT from 2.1 to 6.1 (PDL from 53.7 to 105.6), which was noticed as the “rapid-growing period”. Thus, both clonal single-cell-picking and heterogenous hTERT-transduced hMSCs experienced a similar growth pattern of three different periods: Initial, plateau and rapid-growing, showing that all hMSCs-hTERT bypassed senescence.

**Fig.8** Cumulative population doubling level (PDL) of hMSC-hTERT



**Figure. 8** Cumulative population doubling level (PDL) of hMSCs-hTERT. Clonal SCP1, SCP9, SCP11, SCP12, heterogeneous TERT and non-transduced hMSCs. All hTERT-transduced hMSCs proliferated continuously. Three growth periods of SCP1 were showed being divided by two red vertical lines. Non-transduced hMSCs (blue dots) went into senescence.

Cell type	Initial period		Plateau period		Rapid-growing period	
	PDL	PDT	PDL	PDT	PDL	PDT
SCP1	27.1 (1st - 18th P)	2.3	48.2 (19th - 49th P)	10.9	105.6 (50th P~)	2.1
SCP9	20.7 (1st - 15th P)	5.5	30.6 (16th - 49th P)	22.1	53.7 (50th P~)	3.9
SCP11	20.9 (1st - 15th P)	4.7	38.2 (16th - 52nd P)	9.2	82.9 (53rd P~)	3.7
SCP12	25.7 (1st - 17th P)	2.7	46.5 (18th - 66th P)	20.6	71.1 (67th P~)	6.1
hTERT, heterogenous	21.6 (1st - 15th P)	4.6	48.1 (16th - 68th P)	12.2	74.4 (69th P~)	3.8
hMSCs	21.0 (1st - 18th P)	8.5	22.1 (19th P~)	-15.3 $\Delta$		

\* PDL: cumulative population doubling level; PDT: population doubling time in days.

$\Delta$  Non-transduced hMSCs got into senescence.

**Table. 3** Cumulative population doubling level (PDL) and population doubling time (PDT) of hTERT-transduced hMSCs. hTERT-transduced hMSCs experienced a three periods of growth, with PDT of 2.3-5.5 in the initial period, 9.2-22.1 in the plateau period and 2.1-6.1 in the rapid-growing period; while non-transduced hMSCs went into senescence with a negative PDT of -15.3.

### 3.4. Morphological change during passage

In accordance to the growth characteristics, morphology of clonal and heterogenous hMSCs-hTERT changed with culture time. In the initial period, most of clonal, heterogeneous hMSCs-hTERT and non-transduced hMSCs were small, round and spindle-shaped with less than 30% percent of flat cells (Figure. 9A). 90 days after single cell picking, hTERT-transduced cells grew slower with more cells changed their form into polygonal or flat (Figure. 9B), while almost all of the non-transduced hMSCs turned flat and broke into pieces (apoptosis). In the third part of growth period (rapid-growing), hTERT-transduced hMSCs regained and strengthened their proliferation capacity, while most of the cell became smaller and spindle-shaped and proliferated fast (Figure. 9C).





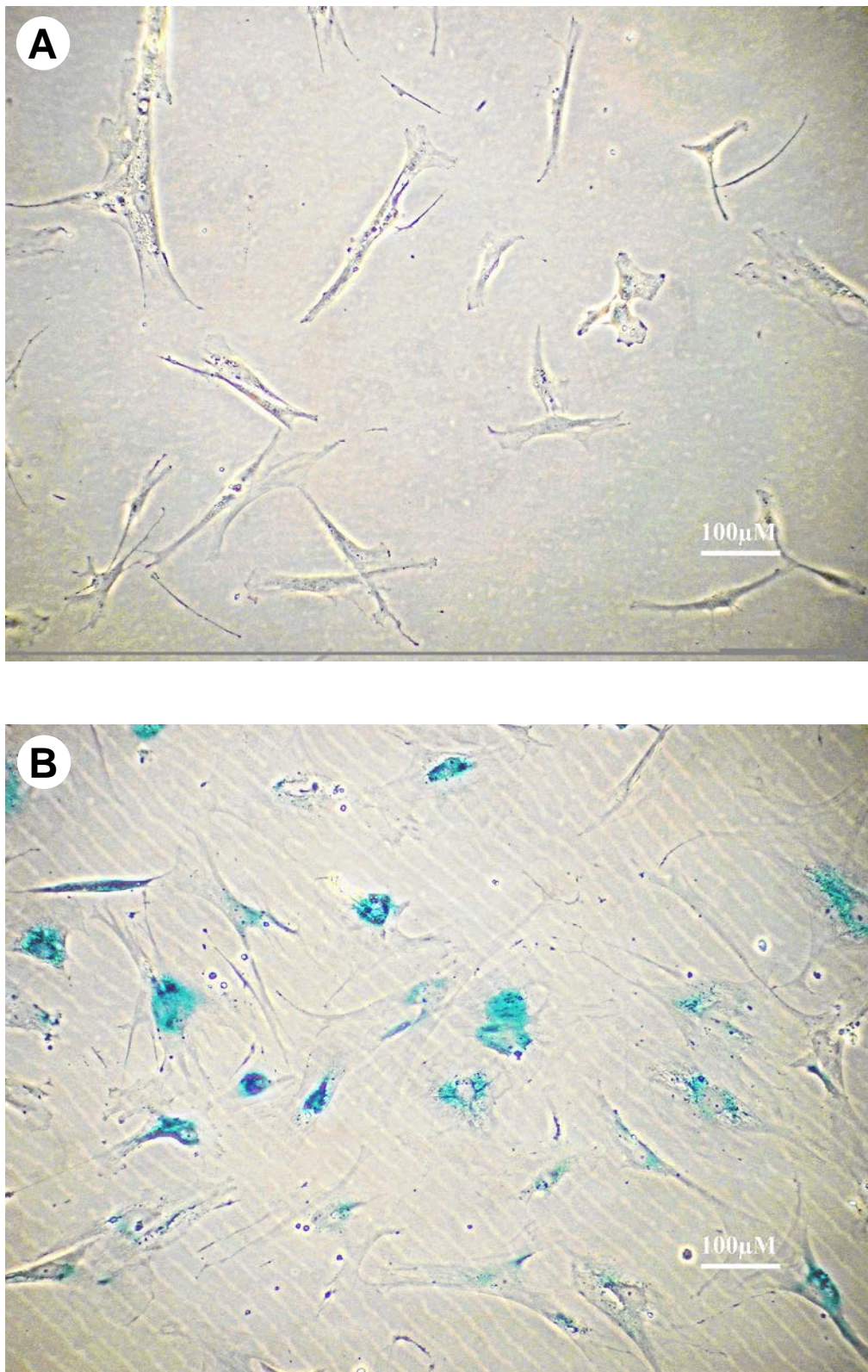


**Figure. 9** Morphology change of hTERT-transduced hMSCs.

Heterogenous hTERT-transduced hMSCs at 15<sup>th</sup> passage in the initial period (**A**), 42<sup>nd</sup> passage in the plateau period (**B**) and 74<sup>th</sup> passage in the rapid-growing period (**C**). More flat cells were seen in the growth plateau period (**B**), while increased number of small, spindle-shaped cells were noticed in the third rapid-growing period (**C**).

### 3.5. Senescence associated $\beta$ -gal staining

Ectopic overexpression of hTERT in hMSCs extended the lifespan of the cells, thus bypassed replicative senescence. Senescence associated  $\beta$ -gal staining was a well-accepted staining method to discern senescent cells. As shown in Figure 10, SCP1 of hTERT-transduced hMSCs had very low or undetectable senescence-associated  $\beta$ -gal staining at 42<sup>nd</sup> passage (Figure. 10A). In contrast, non-transduced hMSCs were strongly positive for  $\beta$ -galactosidase activity even at 24<sup>th</sup> passage, indicating that non-transduced normal hMSCs would get into senescence even at earlier passage than hTERT-transduced hMSCs (Figure. 10B).

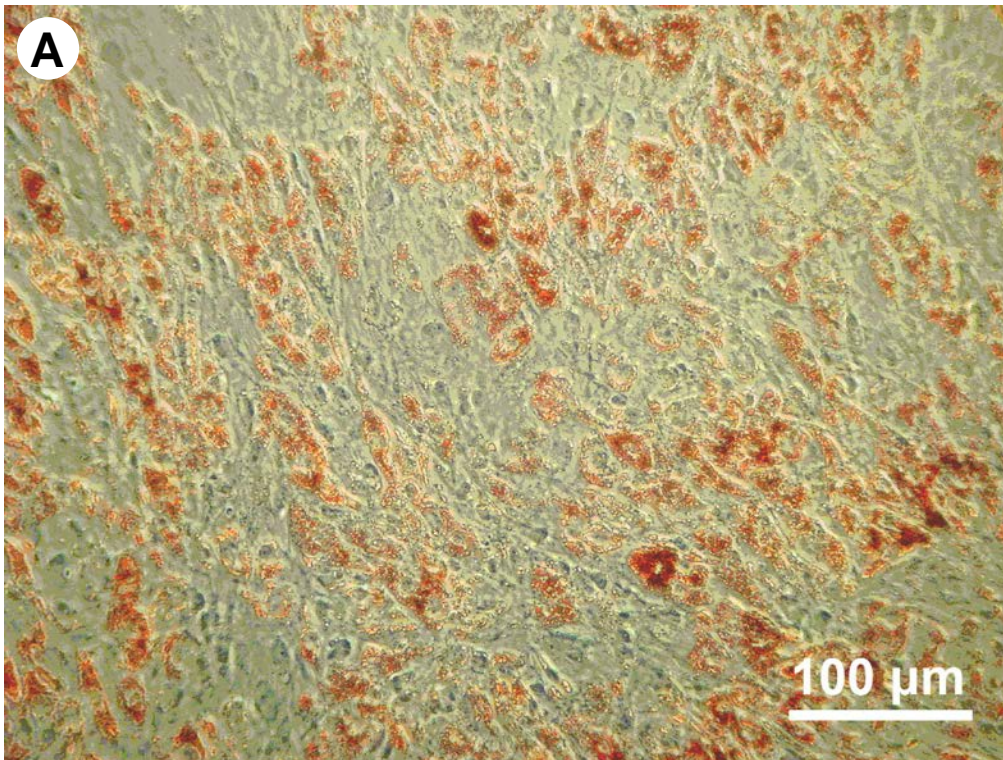


**Figure. 10** Senescence-associated  $\beta$ -gal staining of hTERT-transduced hMSCs. Clonal hTERT-transduced SCP1 was stained negative at 42<sup>nd</sup> passage (A), while non-transduced hMSCs were stained positive at 24<sup>th</sup> passage (B).

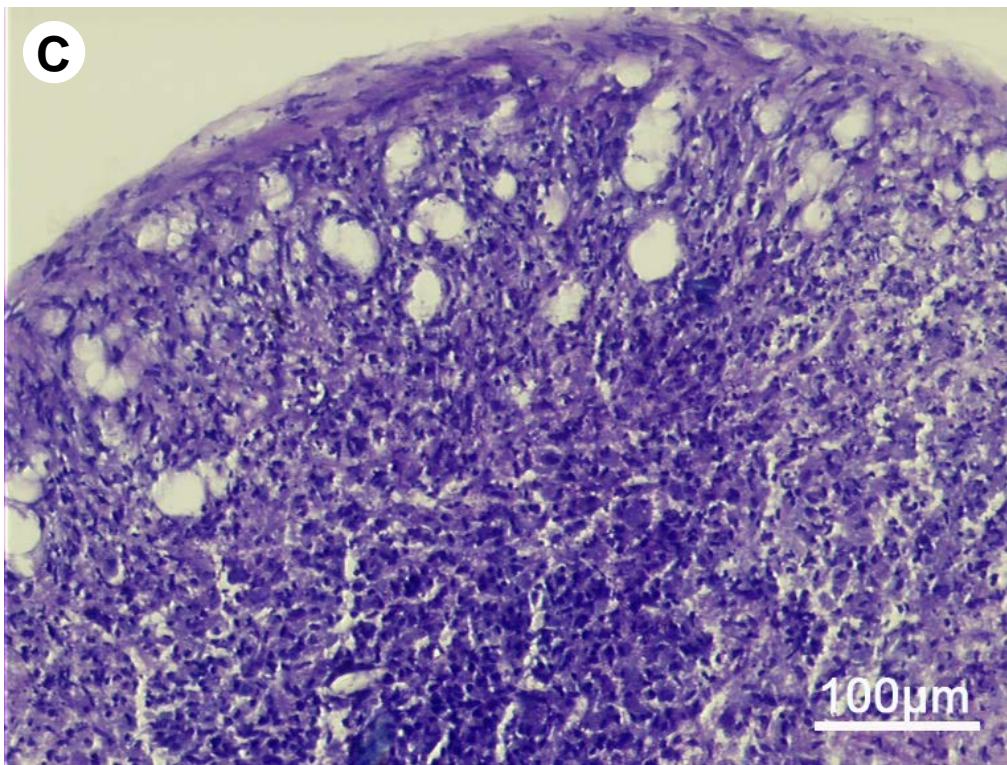
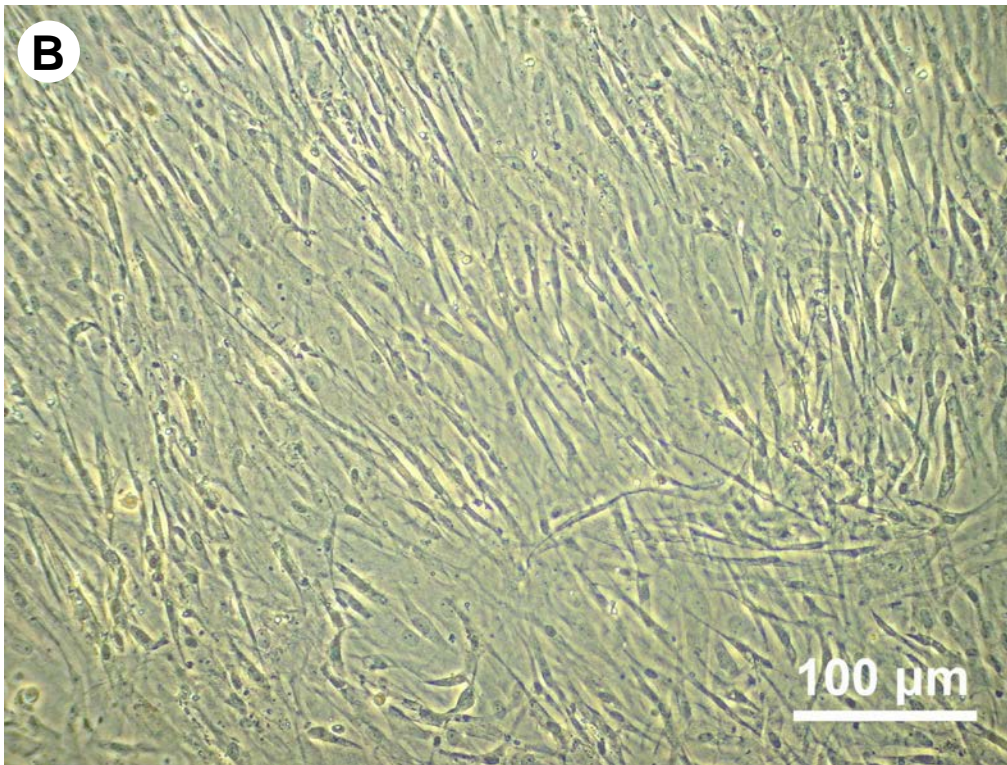


### 3.6. Differentiation assay

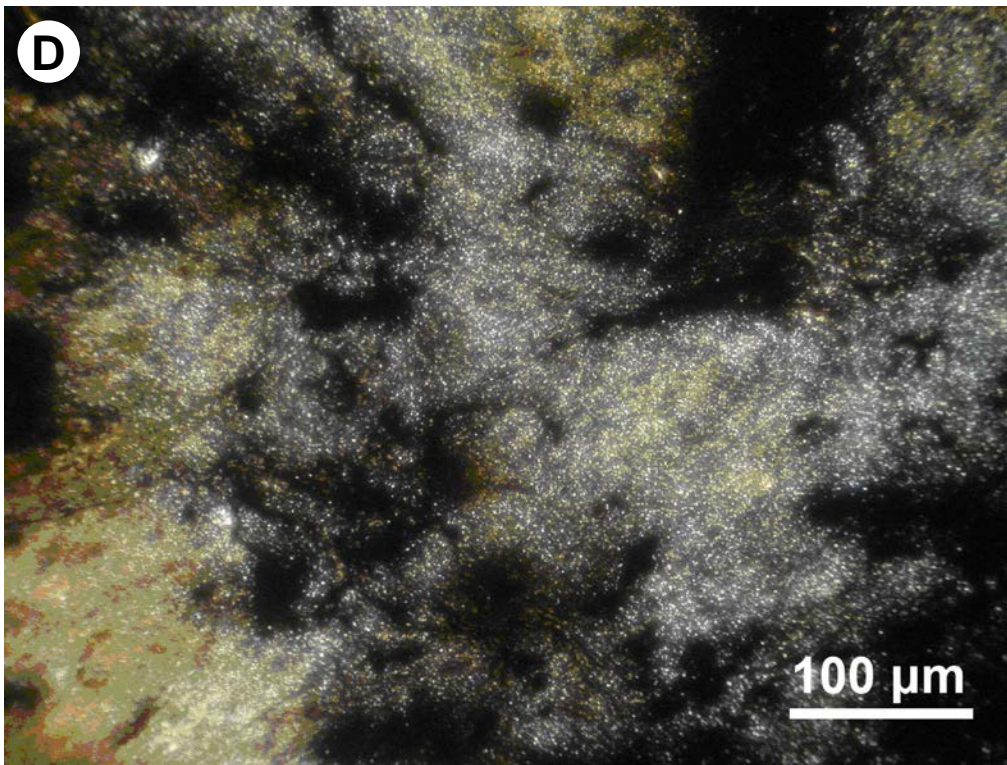
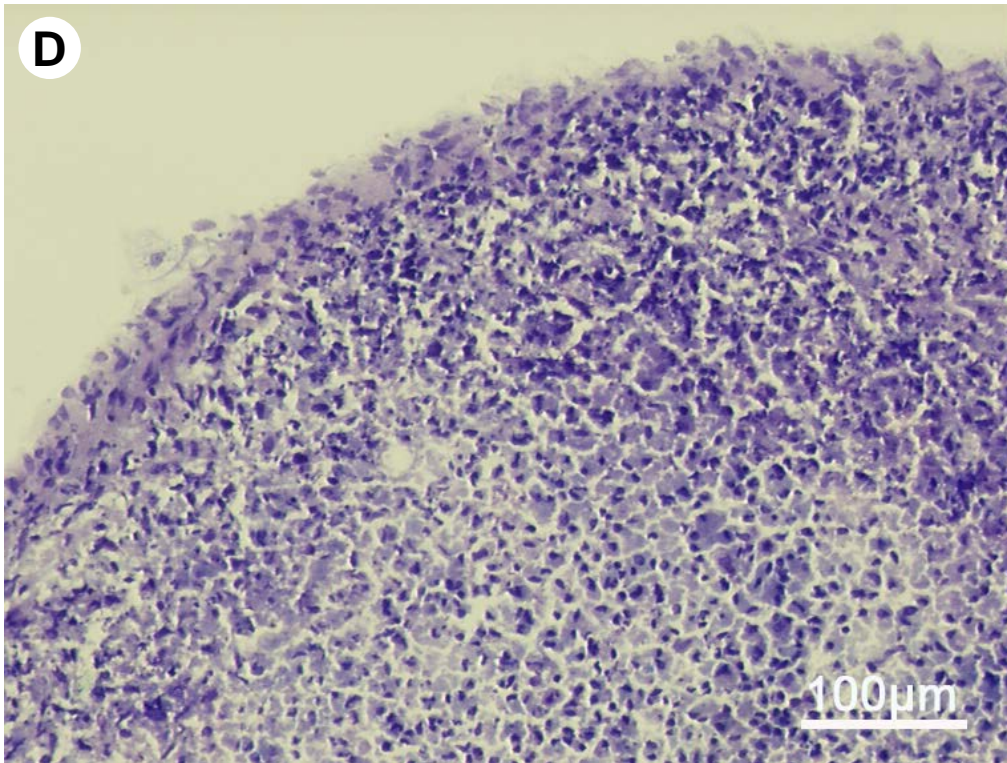
hMSCs-hTERT were induced into three mesodermal lineages (adipocytes, chondrocytes and osteoblasts) by lineage-specific inducing medium. All of the hTERT-transduced hMSCs maintained their differentiation capacity in response to inducing medium during long-term of culture. Intracellular lipid droplets were stained orange to red in adipogenic differentiation by Oil red O staining (Figure. 11A); extracellular proteoglycan was stained blue in chondrogenic differentiation (Figure. 11C); deposited extracellular calcium was stained dark-black in osteogenic differentiation by van Kossa staining (Figure. 11E). Lineage specific staining was low or negative in non-induced control (Figure. 11B,D,F).

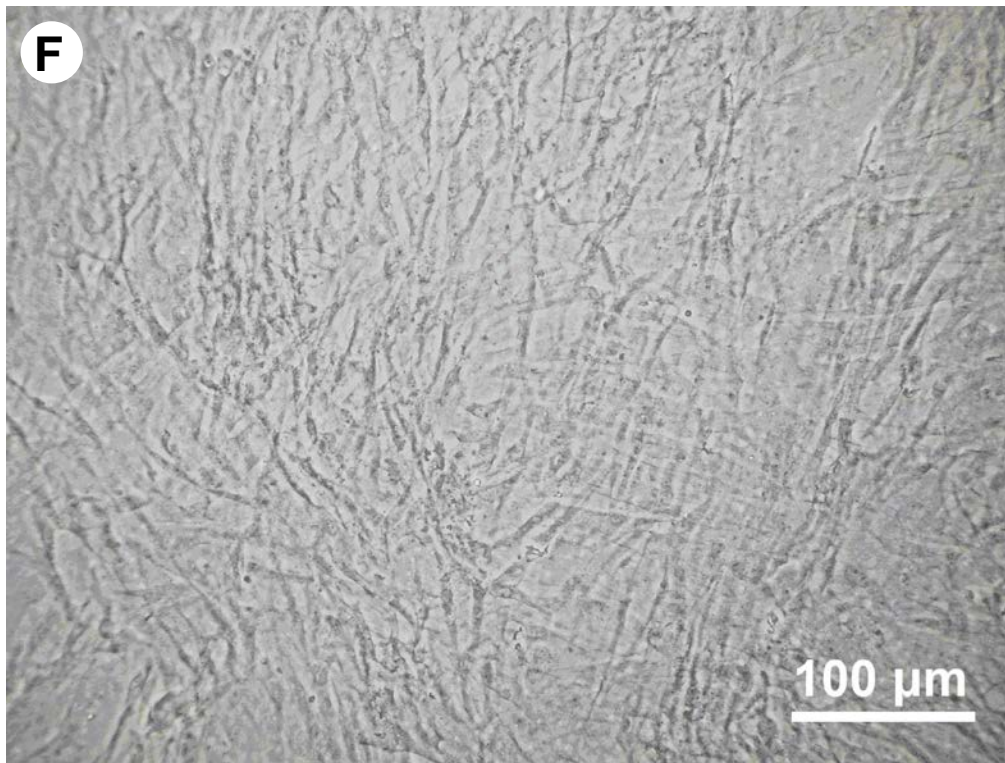












**Figure 11.** Differentiation assay of hTERT-transduced hMSCs.

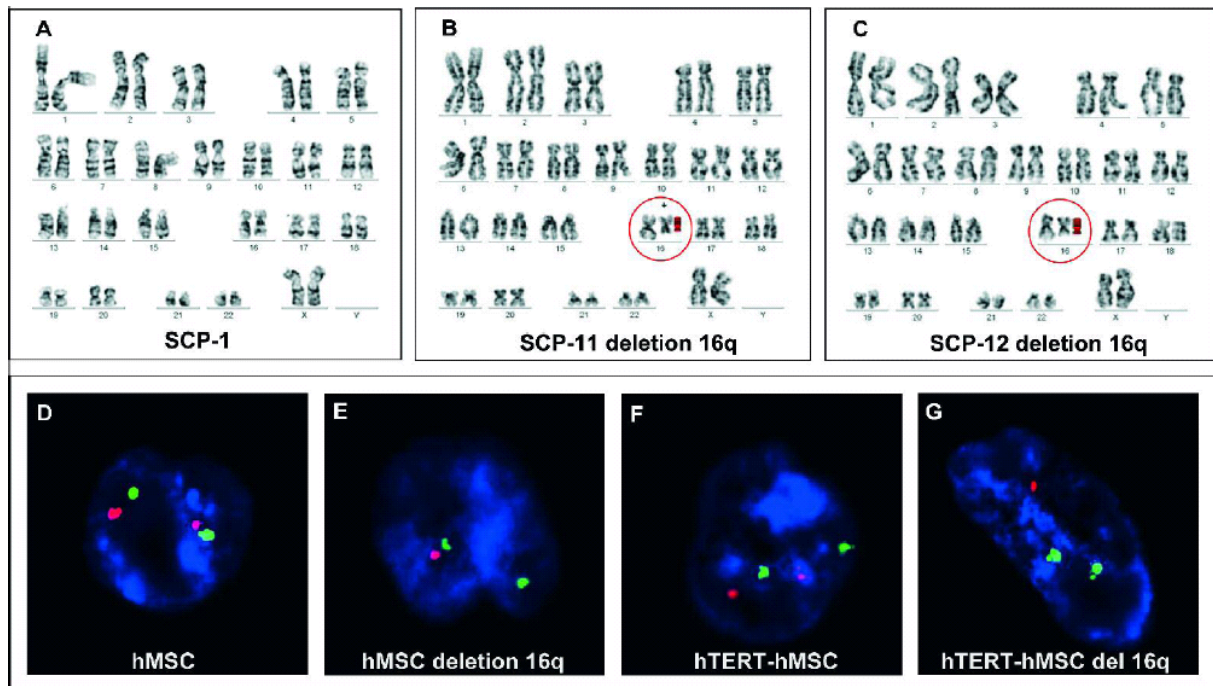
hMSCs-hTERT SCP1-47<sup>th</sup> passage were stained positive as orange-red in adipogenic differentiation(A), dark-blue in chondrogenic differentiation(C) and dark-black in osteogenic differentiation (E); while no or less staining was observed in non-induced control (B,D,F).

### 3.7. Karyotype (cytogenetics) analysis

The hTERT-transduced hMSC clones SCP-1, SCP-11 and SCP-12 were found to be diploid with 46 chromosomes. There was no chromosomal aberration seen in SCP-1 cell clones (Fig. 12A). In contrast, SCP-11 and SCP-12 showed an identical deletion of the long arm of chromosome 16 (Fig. 12B and C). In order to exclude a chromosomal aberration related to lentiviral gene transfer, we went back to the original untransduced hMSCs (passage 12) and young hTERT-transduced cells (passage 11 after transduction) from the same donor. Fluorescence in situ hybridization (FISH) revealed that these deletions have already been present in the donor cells before lentiviral transduction. In the sub-telomer analysis of untransduced hMSCs, 5 of 194 (2.6%) interphase nuclei contained only one signal for the region 16qter (Fig. 12D and E). In heterogeneous hTERT-expressing hMSCs, 17 of 198 (8.6%) interphase nuclei lacked one region of 16qter (Fig. 12F and G). These results



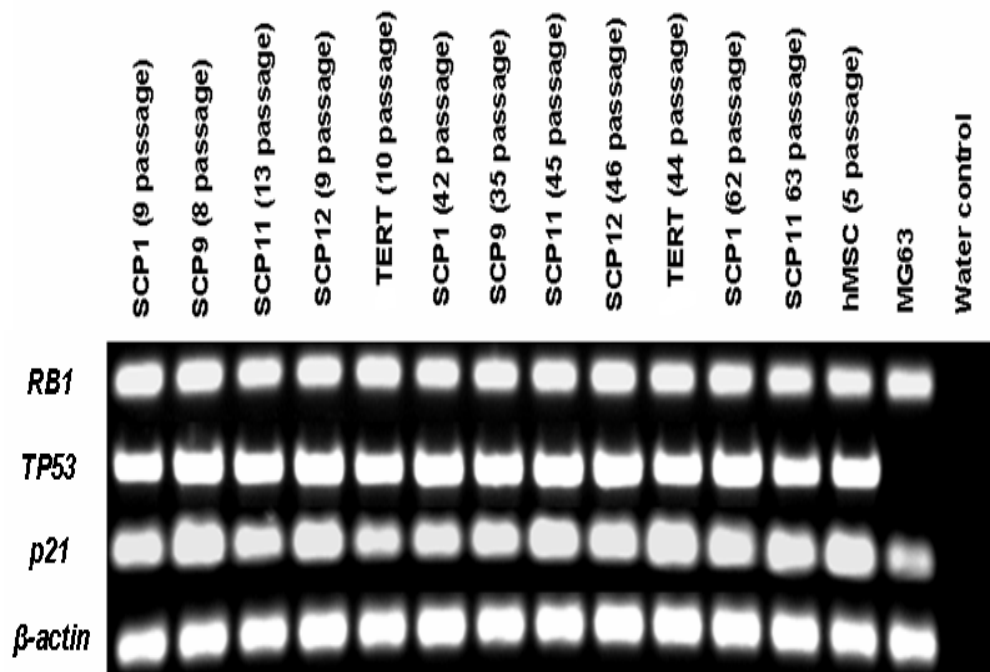
indicate that the chromosomal aberration already existed in donor hMSCs before lentiviral transduction.



**Figure. 12** Karyotype (cytogenetics) analysis of hTERT-hMSCs. (A–C) Karyotyping revealed no change in hTERT-transduced SCP-1 clone (passage 92), while SCP-11 (passage 89) and SCP-12 (passage 80) showed identical deletions in the long arm of chromosome 16 (16q). (D–G) FISH analysis revealed that these deletions already existed in younger passages of untransduced and hTERT-transduced hMSCs.

### 3.8. Tumor suppressor gene assay

The expression level of tumor suppressor genes of *RB1*, *TP53* and *p21* were positive and comparable to non-transduced hMSCs by time-course RT-PCR detection at different passages, while *TP53* was not detectable and *p21* was down-regulated in osteosarcoma cell line-MG63 (Figure.13), suggesting that the growth of hTERT-transduced hMSCs was under control of these tumor suppressor genes, while it was not in MG63.

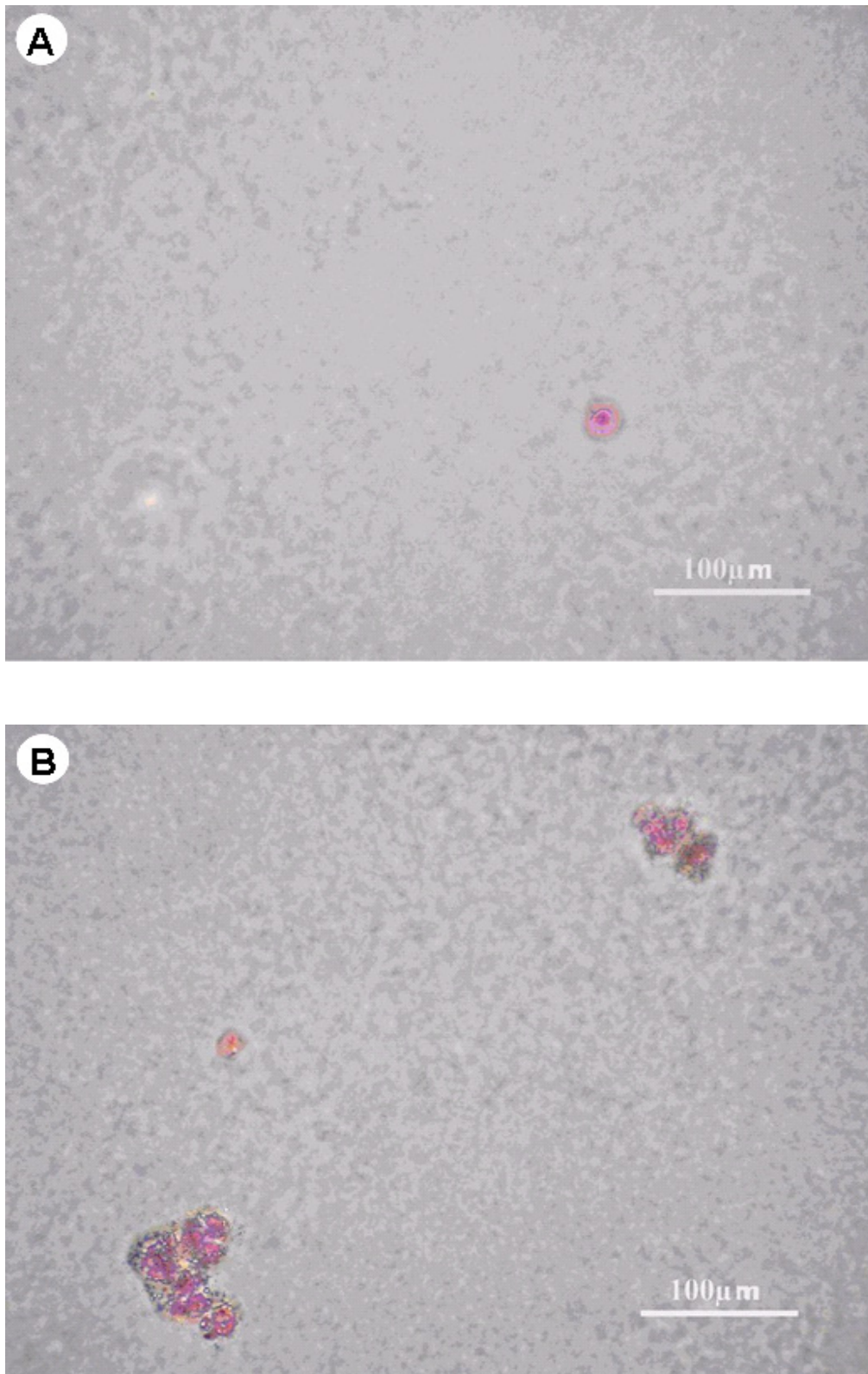


**Figure. 13** Time course of expression of tumor suppressor genes---*RB1*, *TP53* and *p21* in different passages of hTERT-transduced hMSCs. The expression level of *RB1*, *TP53* and *p21* of clonal and heterogeneous hTERT-transduced hMSCs were positive and comparable to non-transduced hMSCs at different passages by time-course RT-PCR analysis; while *TP53* was negative and *p21* was down-regulated in osteosarcoma cell line—MG63.

### 3.9. Soft agar assay

To check whether hMSCs-hTERT had got malignantly transformed, the anchorage independence capacity of these cells was checked in soft agar. SCP1-39P, SCP11-39P, SCP12-40P, hMSCs-13P failed to form colonies and remained as single cell in soft agar (Figure. 14A) after 28 days of culture, while fibrosarcoma HT1080 cells formed colonies in soft agar, showing the malignant characteristic of these transformed cells (Figure. 14B).

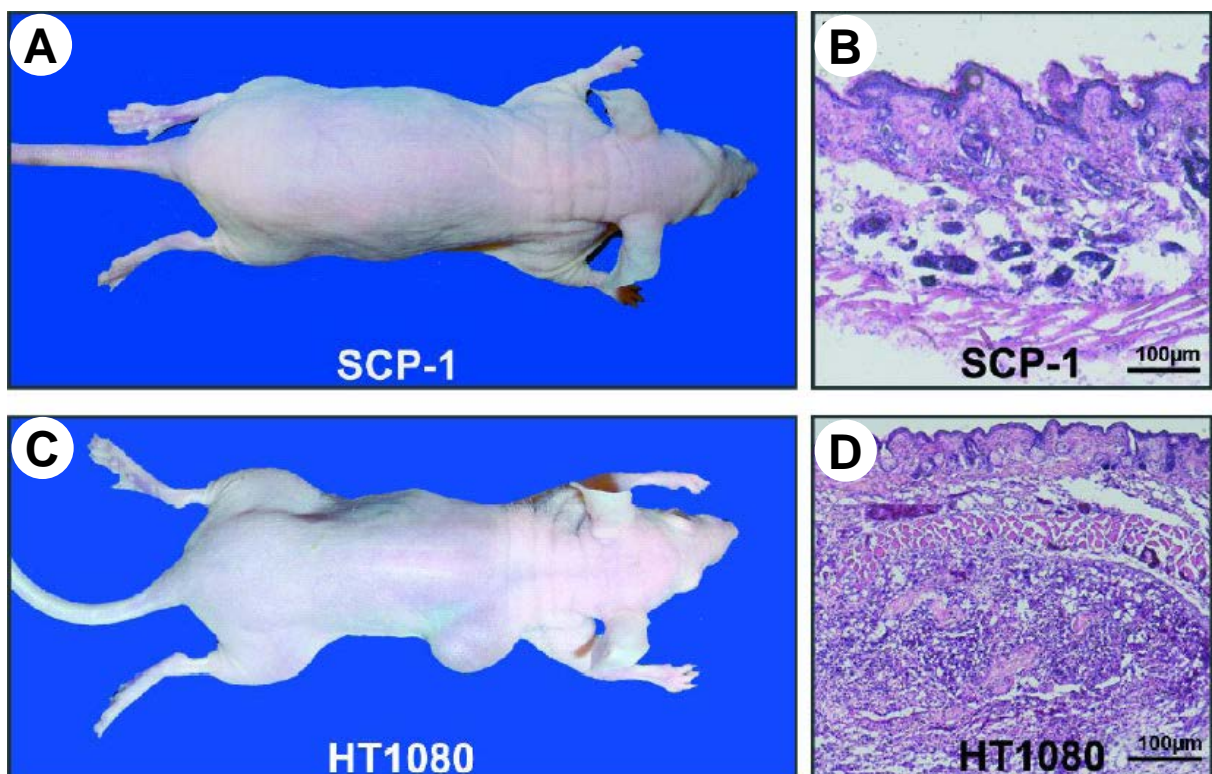




**Figure. 14** Soft agar assay of TERT-transduced hMSCs. No colonies were formed in soft agar by hTERT-transduced SCP1-40P (**A**); while colonies were noticeably formed by H1080 in soft agar (**B**).

### 3.10. *In vivo* implantation assay

We tested whether hTERT-transduced hMSCs show tumour formation *in vivo*. Therefore, two clones (SCP-1 and -11), untransduced hMSCs and the tumour cell line HT1080 were injected subcutaneously into five nude mice each. None of the animals in the SCP-1, SCP-11 and hMSC groups developed a macroscopically detectable tumour by 8 weeks after implantation (Fig. 15A). Four of five animals in the HT1080 group were sacrificed 10 days after injection because of extensive tumour growth at the site of injection (Fig. 15C). The fifth animal had a macroscopically visible tumour upon explantation after 8 weeks. Histological evaluation of the injection sites confirmed the macroscopic findings. In all the animals from the SCP-1, SCP-11 and hMSC groups, a normal structure of the skin and subcutaneous tissue was observed (Fig. 15B). At the same time, extensive tumour growth was observed at the site of injection of all the animals that had received HT1080 cells (Fig. 15D).



**Figure 15.** *In vivo* tumor formation assay. HTERT-transduced hMSCs (here shown SCP-1) did not show macroscopic (A) and microscopic (B, HE stain) after 8 weeks. In contrast, HT1080 formed macroscopically visible tumors within 1 week (C). H.E. stain revealed a characteristic tumor growth (D).

## 4. Discussion

### 4.1. Senescence of hMSCs hindered its usage as tissue engineering seed cell

Although hMSCs has a remarkable self-renewing capacity, no telomerase activity was detectable in hMSCs strains established from different donors (Kolquist et al. 1998). Telomere length of expanded hMSCs was also not longer than that of expanded somatic chondrocytes (Parsch et al. 2004). With continuous passaging of hMSCs *in vitro*, as a result of continuous telomere shortening and DNA damage caused by reactive oxygen species (ROS) and other cytotoxic agents, primary hMSCs would get into aging (senescence) or apoptosis, as shown in Figure 8. As for tissue engineering, a big amount of seed cells were needed for constructing tissue-engineered tissue or organ *in vitro*. But being limited by low incidence of MSC in human bone or adipose tissue ( $1/10^5 \sim 1/10^4$ ), researchers always needed to expand and passage isolated hMSCs for a relative long time *in vitro*, thus predisposed hMSCs to pre-senescence[3], hindering its usage in tissue engineering.

### 4.2. Transduction with telomerase reverse transcriptase (hTERT) would bypass senescence

Telomerase reverse transcriptase (TERT), the catalytic unit of telomerase, was the key deciding factor that maintained and prolonged telomere length. In this way, telomerase could rescue cell from telomere length-dependent proliferation check, prevented uncapping of chromosome ends and resultant chromosome fusion, thus stabilized the chromosome and extended life span of cells. Successful transduction of human TERT (hTERT) and lengthening of lifespan (immortalization) were reported in different human cell types. Among them, B.M. Abdallah et al had passaged hMSCs for more than 3 years with cumulative population doubling level (PDL) of more than 430 by using retroviral vector to transduce hTERT into cells (Abdallah et al. 2005). In our experiment, lentiviral vector was employed to transduce hMSCs with hTERT (Figure.6). As shown in Figure 7, all of the hTERT transduced hMSCs, single-cell-picking clone and heterogeneous cells, overexpressed hTERT; while non-transduced hMSCs had no detectable hTERT expression at all.

hTERT-transduced hMSCs proliferated continuously, reaching more than 200 PDL for nearly 530 days (single-cell-picking clone 1-SCP1), while non-transduced hMSCs got into replicative senescence, with the cells were reduced in harvested cell number and a negative population doubling (Figure 8, Table 3). At the same time, hMSCs-hTERT were stained negative for well-accepted senescence-associated  $\beta$ -gal staining (Figure 10A), while non-transduced hMSCs stained positive (Figure 10B) indicating that these cells were senescent (Xu et al. 2004;Dimri et al. 1995). Thus, the data from our experiment proved that lentiviral hTERT-transduction could expand the life-span (immortalize) of hMSCs, bypass the replicative senescence.

There was also a trend to be noticed in the proliferation of hTERT-transduced hMSCs. As showed in Figure 8 and Table 3, proliferation of hMSCs-hTERT could be divided into three parts: initial period, plateau period and rapid-growing period. In the “initial period”, hTERT-transduced hMSCs had population doubling time from 2.3 days to 5.5 days. After that, the proliferation rate of hTERT-transduced hMSCs became slower and the cells got into a “growth plateau”, with a prolonged PDT from 9.2 days to 22.1 days. Closely accompanying this phenomenon, non-transduced hMSCs went into replicative senescence, with dramatic reduction in cell number and negative PDT. While in the “rapid-growing period”, all of the hTERT-transduced hMSCs seemed to regain their proliferation capacity, with a shortened PDT from 2.1 days to 6.1 days. Similar to changes in the growth pattern, morphological changes were also observed in this three periods. More cells changed from small, spindle-shaped into polygonal or flat when the cells grew from “initial period” into “plateau period”, and when cells regained and strengthened their proliferation capacity in “rapid-growing period”, most of them regressed smaller and spindle-shaped (Figure 9). These results were quite in accordance with the observation of D.C. Colter et al. In their researches, morphologically smaller type I hMSCs (rapid self-renewing cells) had more rapid rate of replication and enhanced potential for multilineage differentiation than inactive flat type II cells (Mets and Verdonk 1981;Colter et al. 2001).

As the growth “plateau period” began quite in time with the beginning of growth declination (senescence) of non-transduced hMSCs in our experiment, a possible explanation for the growth “plateau period” could be that, due to accumulative damage to DNA and organelles induced by reactive oxygen species (ROS) and other

toxic reagent in continuous *ex vivo* culture, heterogeneous hMSCs-hTERT, and also the cells in single-cell-picking clone that had different metabolic status being influenced by *in vitro* culture circumstances, experienced a “self-selection” process. Morphologically bigger, flat type II cells in the cell-pool of hMSCs-hTERT with lower self-renewing capacity went into senescence or apoptosis, while the cells with intact chromosome and higher self-renewing capacity survived, thus contributing to the prominent growth capacity in the third rapid-growing period. Yet, the mechanism behind this reflection needed to be further investigated.

### **4.3. Differentiation capability was not hampered by hTERT transduction and long term *in vitro* culture**

Long-term *in vitro* culture of hMSCs usually resulted in impaired differentiation capacity, thus limited the feasibility of expanding hMSCs to a large number of cells that was needed for therapeutic applications. During *in vitro* subculturing, human osteoblasts showed impaired osteogenic potential evidenced by decreased expression of osteoblast-specific genes, such as core-binding factor 1/Runx-related transcription factor 2 (Cfba1/Runx2), alkaline phosphatase (ALP), collagen type I (Col I) and osteocalcin (OC) (Christiansen et al. 2000). Marrow stromal cells failed to differentiate into adipocytes following serial passage in continuous culture (Digirolamo et al. 1999). As the loss of differentiation capacity was related to aging (senescence) of the cells, researchers transduced hMSCs with hTERT and proved that ectopic hTERT expression by retroviral vector could maintain differentiation potential and even enhance osteogenesis of hMSCs (Shi et al. 2002; Simonsen et al. 2002).

In our experiment, differentiation potential of lentivirally hTERT-transduced hMSCs were checked at different passages (47, 52, 68, 80, 82 passages), all of the clonal and heterogeneous hMSCs-hTERT were capable of differentiating into osteogenic (von Kossa stain positive), adipogenic (Oil red O stain positive) and chondrogenic (Toluidine blue stain positive) lineage (Figure 11). These results confirmed the notion that ectopic expression of hTERT in hMSCs by lentiviral vector would extend the proliferative life-span (immortalize) of hMSCs and would not interfere with the differentiation potential of hMSCs, thus providing a practical method to construct a hMSCs cell line both for *in vitro* experiment on the biology of hMSCs and also for

therapeutic application of hMSCs *in vivo*. Additionally, single cell picking could offer a convenient way to establish genetically identical hMSCs-hTERT clone that had the same genetic background for further characterization of hMSCs.

#### **4.4. Replication incompetent HIV-1-based lentiviral vector transduction weighed better than traditional Moloney Leukemia Virus (MoMLV)-based retroviral transduction**

Viral transduction of gene of interest (GOI) into target cell was an efficient way to express target gene. Till now, all of the authors employed MoMLV-based retroviral vector to transduce hMSCs with hTERT and gained positive results. Nevertheless, due to its specific transduction feature, transduction of GOI with retroviral vectors had disadvantages in application. First, MoMLV-based retroviral vectors could only infect dividing cells. Second, MoMLV-based retroviral vectors had a bias of integration site selection. Based on tumor-prone cyclin-dependent kinase inhibitor 2a (Cdkn2a)  $-/-$  mouse model, E. Montini et al exploited hematopoietic stem cells to compare the oncogenicity of prototypical retroviral and lentiviral vectors. They transduced hematopoietic stem cells in matched clinically relevant conditions, and compared integration site selection and tumor development in transplanted mice. After 450 days of observation, they noticed that retroviral vectors triggered dose-dependent acceleration of tumor onset contingent on long terminal repeat (LTR) activity. In contrast, tumorigenesis was unaffected by lentiviral vectors and did not enrich for specific integrants, despite the higher integration load and robust expression of lentiviral vectors in all hematopoietic lineages. They found out that retroviral vector integrations had an additional hot spot upstream of the transcriptional start site (TSS) of genes. This pattern might increase the potential for strong enhancer elements in the retroviral LTR to transactivate the adjacent cellular gene promoter. They also showed that a statistically significant bias of retroviral vectors for cancer-associated genes (as defined in retrovirus tagged cancer gene database-RTCGD), gene ontology (GO) classes such as transcription factors, and genes associated with cell cycle control, which underlay the mechanism of insertional oncogenesis (Kohn 2007; Akagi et al. 2004; Montini et al. 2006). So due to their intrinsic infection spectrum and integration feature, MoMLV-based retroviral vector had disadvantages in hTERT gene transduction into hMSCs.

Another factor that might be involved in the malignant transformation of retroviral hTERT-transduction experiment was the long term *in vitro* culture. Researchers had observed that, after numerous *in vitro* passages, murine bone marrow-derived MSC had acquired spontaneous accumulated chromosomal abnormalities and malignant transformation. They also noticed that this transformation was associated with increased c-myc expression [14]. As telomerase activity and hTERT expression were normally maintained in germline cells, embryonic stem cells and some active somatic cells and these cells were not malignantly transformed [11]. Based on these observations, one speculation could be prompted that, that were the specific trait of MoMLV-based retroviral vectors used in hTERT transduction, accumulated chromosomal instability and growth selection during long-term *in vitro* culture that predisposed hTERT-transduced hMSCs to neoplastic transformation.

Replication incompetent HIV-1-based lentiviral vector was employed in our experiment to transduce hMSCs with hTERT. This lentiviral vector could transduce both dividing and non-dividing mammalian cells, thus having a broadened spectrum of application beyond traditional MoMLV-based retroviral vectors. It also had a different integration-site selection pattern, targeting gene-rich regions at even higher frequency and integration loads than retroviruses but without the predilection for the 5' ends (TSS) of genes and even lower genotoxic effects (Biffi et al. 2004; Hematti et al. 2004; De Palma et al. 2005). Lentiviral vector in our experiment was developed by using design strategies to optimize safety and effectiveness, such as 'self-inactivation' by a deletion in the 3' LTR, minimal viral sequences in the transfer vector, splitting genes for packaging functions over multiple plasmids and pseudotyping with alternative VSV-G envelope proteins. In these ways, replication incompetent HIV-1-based lentiviral vector transduction of gene of interest weighed better than traditional MoMLV-based retroviral transduction.

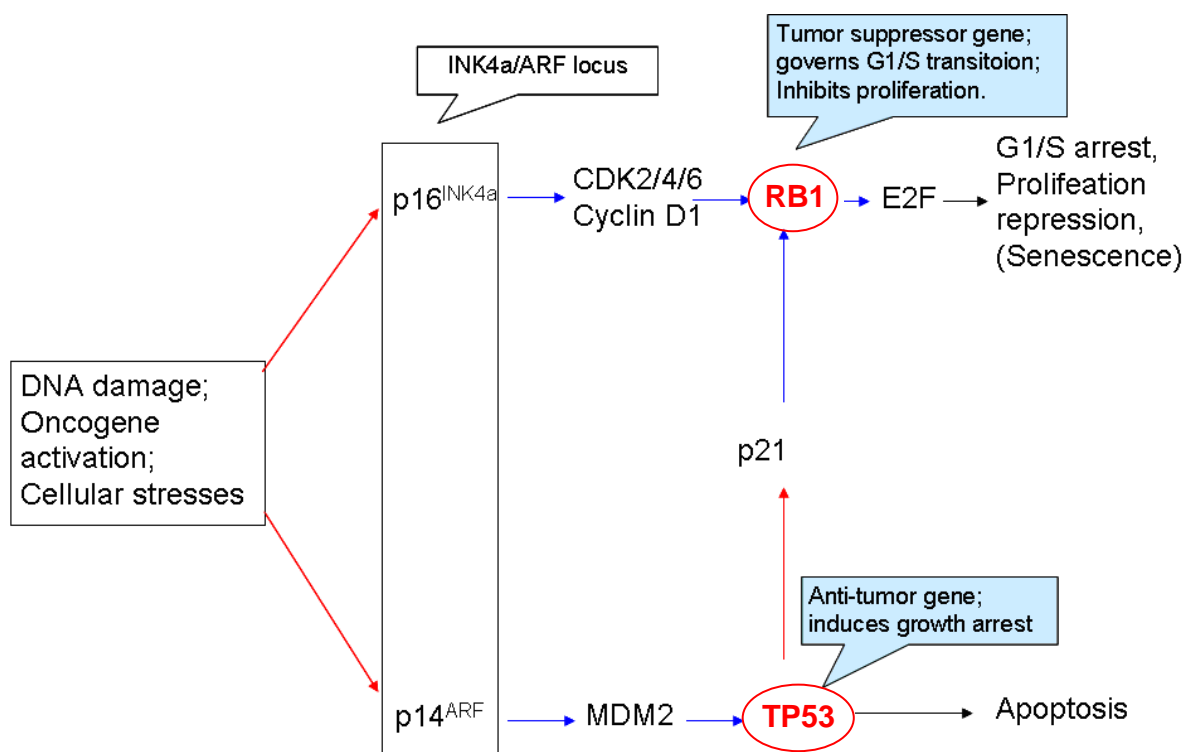
#### **4.5. No malignant transformation was observed in lentivirally hTERT- transduced hMSCs**

The persistence and continued mitotic activity of stem cells throughout life made these cells a potential reservoir for the accumulation of oncogenic mutations. The



self-renewal mechanisms that allowed stem cells to persist consistently involve proto-oncogene pathways such as Wnt, Shh and Notch. The activation of these pathways in stem cells throughout life might predispose these cells to neoplastic transformation. There were evidences that some cancers arose from mutations that transformed stem cells (Kiyokawa 2006;Reya et al. 2001).

The danger of neoplastic transformation being originated from constitutively activated self-renewal pathways in stem cells made it critical to incorporate tumor suppressor mechanisms into this process. Tumor suppressors came in two varieties: "caretakers", such as ataxia telangiectasia mutated (ATM), that prevented mutations by detecting and promoting the repair of DNA damage, and "gatekeepers" that promoted senescence or cell death when cells became mutated or stressed. Predominantly, cells growth and DNA replication were under surveillance of two well-established pathways, RB1 and TP53 that acted as "gatekeepers" to promote senescence or cell death when cells became mutated or stressed (Pardal et al. 2005) (Figure 16).



**Figure.16** The RB1 and TP53 pathways in tumor suppression and cell cycle control. (p16 INK4a: cyclin-dependent kinase inhibitor 2A; p14ARF: alternative reading frame (of INK4a/ARF locus)



CDK2/4/6: cyclin-dependent kinase 2/4/6; RB1: retinoblastoma 1; E2F: E2F transcription factors; MDM2: mouse double minute 2 homolog; TP53: tumor protein 53; p21: cyclin-dependent kinase inhibitor 1A)

As showed in Figure 16, in the unstressed state, TP53 was rapid degraded by MDM2; a process which was inhibited by ARF. Also, TP53 could be stabilized by N-terminal serine phosphorylation in response to genotoxic stresses such as DNA damage, oncogene activation and cellular stresses, and this phosphorylation inhibited its interaction with MDM2. TP53 activation potently induced either senescence or apoptosis. The “gatekeeping” activity of TP53 in part resulted from p21 expression, which was a TP53 transcriptional target. RB1 pathway also took an important effect in cell cycle control, which crossed out mutated cells by growth arrest induction (Sharpless and DePinho 2004).

As the RB1 and TP53 pathways were very important in balancing the effect of lentiviral hTERT-transduction and accumulative chromosomal stability, it was very necessary to detect these genes in the hTERT-transduced hMSCs in different culture period. Time-course analysis of RB1 and TP53 expression were showed in Figure 13, in three different proliferation periods, these two key tumor suppressors were not down-regulated, suggesting the growth of hTERT-transduced hMSCs were under control of these “gatekeeping” tumor suppressing genes. This result was consistent with the result of other authors (Chapman et al. 2006; Terai et al. 2005). In order to check the potential malignant transformation of our lentiviral hTERT-transduced cells further, anchorage independence soft agar assay and nude mice implantation assay were employed. When being checked with *in vitro* soft agar colony-forming assay and *in vivo* implantation tumor-forming assay, our lentiviral hTERT-transduced hMSCs did not form any colonies *in vitro* (Figure. 14) or any tumors *in vivo* (Figure 15).

Transformation of retrovirally hTERT-transduced cells reported in other researches [12] might have evolved from spontaneous chromosomal aberrations in prolonged culture with multiple cell divisions and might not have been directly related to ectopic hTERT expression. This hypothesis was supported by the finding that spontaneous accumulation of chromosomal abnormalities and malignant transformation occurred after numerous passages even in untransduced murine bone marrow-derived MSCs [14]. On the other hand, mathematical modelling indicated that rather a selective

growth of cells with mutations in tumour suppressor genes was the driving force in the development of most human tumours, than an increased mutation rate. Spontaneous transformation in cultured cells was efficiently evoked by progressive selection under prolonged contact inhibition at high population density or during multiplication at low population density in suboptimal concentrations or types of serum (Rubin 2001). Therefore, malignant transformation of hTERT-transduced hMSCs might have been the result of progressive selection of malignant cells under particular culture conditions. Since germline cells, embryonic stem cells and some active somatic cells expressed hTERT *in vivo* and many different cell types had been immortalized by hTERT without malignant transformation, hTERT was not considered an oncogene [11] and cells transduced by hTERT was not destined to be malignantly transformed. In our experiment, karyotype (cytogenetics) analysis was employed to check chromosomal status of hTERT transduced hMSC, subtelomeric chromosomal deletion of 16q was found in SCP11 and SCP12 while it was normal in SCP1; retrospective FISH analysis revealed that this deletion already existed in donor hMSCs (2.6%) before lentiviral transduction. With prolonged growth time *in vitro* supported by hTERT transduction, the deletion on chromosome 16 might be accumulated with culture time. The lentivirally hTERT-transduced hMSCs clones in our experiment were proved to be not transformed by karyotype, soft agar, tumor suppressor gene and *in vivo* implantation assays, nevertheless a dose-dependant tumour acceleration triggered by retroviral vectors employed in other experiments reminded us that caution would be taken in the use of lentivirally hTERT-immortalized hMSCs in cell and gene therapy applications, and monitoring of genetic instability and accumulation of mutations of these cells would also be needed.

In summary, we reported for the first time a hMSC clone successfully immortalized by ectopic expression of hTERT using lentiviral gene transfer. The immortalized clonal hMSCs revealed no change of karyotype with no signs of malignant transformation *in vitro* and *in vivo*, making them an attractive candidate for cell and gene therapy applications. Nevertheless, due to a potential risk of selecting preexisting tumour cells, careful screening for mutations and malignant transformation was mandatory.

## 5. Summary

### Objective:

To establish a immortalized hMSCs cell line by hTERT transduction using lentiviral vector;

To explore the biological effect of lentiviral hTERT transduction on hMSCs;

To elucidate the transformation potential of hTERT-transduction in hMSCs.

### Material and Methods:

hMSCs were infected with lentivirus containing hTERT, clonal hMSCs-hTERT was obtained by single cell picking. Expression of hTERT was confirmed by RT-PCR in hMSCs-hTERT. Cell proliferation was monitored by morphological observation and population doubling level (PDL) and population doubling time (PDT) calculation. Senescence-bypassing effect of hTERT-transduction was confirmed by senescence-associated  $\beta$ -gal staining with non-transduced hMSCs as control. Differentiation capacity of hMSCs-hTERT was checked by adipogenic, chondrogenic and osteogenic induction. In order to elucidate the potential transformation capacity of lentiviral hTERT-transduction in hMSCs, karyotype and FISH analysis, time course tumor suppressor genes assay of RB1, TP53 and p21, *in vitro* soft agar assay and *in vivo* nude mice implantation assay were employed to check both the clonal and heterogeneous hMSCs-hTERT.

### Results:

hTERT was successfully transduced into hMSCs and single-cell-picking clones (SCP) were established. hTERT expression was confirmed in hTERT-transduced hMSCs by RT-PCR but not detected in non-transduced hMSCs. Both clonal and heterogeneous hTERT-transduced hMSCs had grown for more than 500 days and proliferated still continuously, while non-transduced had gotten into senescence for less than 250 days. A three periods of proliferation of hMSCs-hTERT could be noticed with different proliferation capacity and different PDT, PDL. Cell morphology of hMSCs-hTERT changed from mixed phenotype in "initial period" (PDT 2.3 to 5.5, PDL 20.7 to 27.1) to high incidence of flat cell in "plateau period" (PDT 9.2 to 22.1, PDL 30.6 to 48.2) which was quite in accordance with the senescence process of non-transduced hMSCs, and then to high incidence of small, spindle-shaped cells (PDT 2.1 to 6.1,

PDL 53.7 to 105.6) in “rapid-growing period”, indicating the potential “self-selection” process in continuous *in vitro* culture. The differentiation capacity of hTERT-transduced hMSCs was confirmed both in clonal and heterogeneous hMSCs-hTERT by positive adipogenesis-specific Oil red O staining, chondrogenesis-specific toluidine blue staining and osteogenesis-specific von Kossa staining. Malignant transformation of hMSCs-hTERT was excluded by karyotype analysis, persistent tumor suppressor genes expression (RB1, TP53 and p21), no colonies formation in soft agar *in vitro* and no tumor formation in nude mice *in vivo*.

#### Conclusion:

In summary, we firstly reported that lentiviral transduction of hTERT was an efficient and relative secure way to generate an “immortalized” (life-span extended) hMSCs cell line. Although it needed to be checked for differentiation capacity and tumorigenic potential for considerable even longer time, but based on our more than 500 days of *in vitro* culture, clonal lentiviral hTERT-transduced hMSCs were proved to be a promising cell line to be applied in researches on the biological behaviour of hMSCs, and also for therapeutic applications in tissue engineering.

## 6. References

1. Abdallah, B.M., M. Haack-Sorensen, J.S. Burns, B. Elsnab, F. Jakob, P. Hokland, M. Kassem, 2005. Maintenance of differentiation potential of human bone marrow mesenchymal stem cells immortalized by human telomerase reverse transcriptase gene despite [corrected] extensive proliferation. *Biochem. Biophys. Res. Commun.* **326**: 527-538.
2. Akagi, K., T. Suzuki, R.M. Stephens, N.A. Jenkins, N.G. Copeland, 2004. RTCGD: retroviral tagged cancer gene database. *Nucleic Acids Res.* **32**: D523-D527.
3. Biffi, A., M. De Palma, A. Quattrini, U. Del Carro, S. Amadio, I. Visigalli, M. Sessa, S. Fasano, R. Brambilla, S. Marchesini, C. Bordignon, L. Naldini, 2004. Correction of metachromatic leukodystrophy in the mouse model by transplantation of genetically modified hematopoietic stem cells. *J. Clin. Invest* **113**: 1118-1129.
4. Cech, T.R., 2004. Beginning to understand the end of the chromosome. *Cell* **116**: 273-279.
5. Chapman, E.J., C.D. Hurst, E. Pitt, P. Chambers, J.S. Aveyard, M.A. Knowles, 2006. Expression of hTERT immortalises normal human urothelial cells without inactivation of the p16/Rb pathway. *Oncogene* **25**: 5037-5045.
6. Christiansen, M., M. Kveiborg, M. Kassem, B.F. Clark, S.I. Rattan, 2000. CBFA1 and topoisomerase I mRNA levels decline during cellular aging of human trabecular osteoblasts. *J. Gerontol. A Biol. Sci. Med. Sci.* **55**: B194-B200.
7. Collins, K., J.R. Mitchell, 2002. Telomerase in the human organism. *Oncogene* **21**: 564-579.
8. Colter, D.C., I. Sekiya, D.J. Prockop, 2001. Identification of a subpopulation of rapidly self-renewing and multipotential adult stem cells in colonies of human marrow stromal cells. *Proc. Natl. Acad. Sci. U. S. A* **98**: 7841-7845.
9. de Lange, T., 2006. Lasker Laurels for telomerase. *Cell* **126**: 1017-1020.
10. De Palma, M., E. Montini, F.R. Santoni de Sio, F. Benedicenti, A. Gentile, E. Medico, L. Naldini, 2005. Promoter trapping reveals significant differences in integration site selection between MLV and HIV vectors in primary hematopoietic cells. *Blood* **105**: 2307-2315.
11. Digirolamo, C.M., D. Stokes, D. Colter, D.G. Phinney, R. Class, D.J. Prockop, 1999. Propagation and senescence of human marrow stromal cells in culture: a simple colony-forming assay identifies samples with the greatest potential to propagate and differentiate. *Br. J. Haematol.* **107**: 275-281.
12. Dimri, G.P., X. Lee, G. Basile, M. Acosta, G. Scott, C. Roskelley, E.E. Medrano, M. Linskens, I. Rubelj, O. Pereira-Smith, ., 1995. A biomarker that identifies senescent human cells in culture and in aging skin in vivo. *Proc. Natl. Acad. Sci. U. S. A* **92**: 9363-9367.

13. Dominici, M., K. Le Blanc, I. Mueller, I. Slaper-Cortenbach, F. Marini, D. Krause, R. Deans, A. Keating, D. Prockop, E. Horwitz, 2006. Minimal criteria for defining multipotent mesenchymal stromal cells. The International Society for Cellular Therapy position statement. *Cytotherapy*. **8**: 315-317.
14. Harley, C.B., 2002. Telomerase is not an oncogene. *Oncogene* **21**: 494-502.
15. Hematti, P., B.K. Hong, C. Ferguson, R. Adler, H. Hanawa, S. Sellers, I.E. Holt, C.E. Eckfeldt, Y. Sharma, M. Schmidt, C. von Kalle, D.A. Persons, E.M. Billings, C.M. Verfaillie, A.W. Nienhuis, T.G. Wolfsberg, C.E. Dunbar, B. Calmels, 2004. Distinct genomic integration of MLV and SIV vectors in primate hematopoietic stem and progenitor cells. *PLoS. Biol.* **2**: e423.
16. Horwitz, E.M., K. Le Blanc, M. Dominici, I. Mueller, I. Slaper-Cortenbach, F.C. Marini, R.J. Deans, D.S. Krause, A. Keating, 2005. Clarification of the nomenclature for MSC: The International Society for Cellular Therapy position statement. *Cytotherapy*. **7**: 393-395.
17. Jun, E.S., T.H. Lee, H.H. Cho, S.Y. Suh, J.S. Jung, 2004. Expression of telomerase extends longevity and enhances differentiation in human adipose tissue-derived stromal cells. *Cell Physiol Biochem*. **14**: 261-268.
18. Kiyokawa, H., 2006. Senescence and cell cycle control. *Results Probl. Cell Differ.* **42**: 257-270.
19. Kohn, D.B., 2007. Lentiviral vectors ready for prime-time. *Nat. Biotechnol.* **25**: 65-66.
20. Kolquist, K.A., L.W. Ellisen, C.M. Counter, M. Meyerson, L.K. Tan, R.A. Weinberg, D.A. Haber, W.L. Gerald, 1998. Expression of TERT in early premalignant lesions and a subset of cells in normal tissues. *Nat. Genet.* **19**: 182-186.
21. Mets, T., G. Verdonk, 1981. In vitro aging of human bone marrow derived stromal cells. *Mech. Ageing Dev.* **16**: 81-89.
22. Miura, M., Y. Miura, H.M. Padilla-Nash, A.A. Molinolo, B. Fu, V. Patel, B.M. Seo, W. Sonoyama, J.J. Zheng, C.C. Baker, W. Chen, T. Ried, S. Shi, 2006. Accumulated chromosomal instability in murine bone marrow mesenchymal stem cells leads to malignant transformation. *Stem Cells* **24**: 1095-1103.
23. Montini, E., D. Cesana, M. Schmidt, F. Sanvito, M. Ponzoni, C. Bartholomae, S.L. Sergi, F. Benedicenti, A. Ambrosi, C. Di Serio, C. Doglioni, C. von Kalle, L. Naldini, 2006. Hematopoietic stem cell gene transfer in a tumor-prone mouse model uncovers low genotoxicity of lentiviral vector integration. *Nat. Biotechnol.* **24**: 687-696.
24. Nerem, R.M., 1992. Tissue engineering in the USA. *Med. Biol. Eng Comput.* **30**: CE8-12.
25. Noble, J.R., Z.H. Zhong, A.A. Neumann, J.R. Melki, S.J. Clark, R.R. Reddel, 2004. Alterations in the p16(INK4a) and p53 tumor suppressor genes of hTERT-immortalized human fibroblasts. *Oncogene* **23**: 3116-3121.

26. Pardal,R., A.V.Molofsky, S.He, S.J.Morrison, 2005. Stem cell self-renewal and cancer cell proliferation are regulated by common networks that balance the activation of proto-oncogenes and tumor suppressors. *Cold Spring Harb. Symp. Quant. Biol.* **70**: 177-185.
27. Parsch,D., J.Fellenberg, T.H.Brummendorf, A.M.Eschlbeck, W.Richter, 2004. Telomere length and telomerase activity during expansion and differentiation of human mesenchymal stem cells and chondrocytes. *J. Mol. Med.* **82**: 49-55.
28. Pittenger,M.F., A.M.Mackay, S.C.Beck, R.K.Jaiswal, R.Douglas, J.D.Mosca, M.A.Moorman, D.W.Simonetti, S.Craig, D.R.Marshak, 1999. Multilineage potential of adult human mesenchymal stem cells. *Science* **284**: 143-147.
29. Ramirez,R.D., S.Sheridan, L.Girard, M.Sato, Y.Kim, J.Pollack, M.Peyton, Y.Zou, J.M.Kurie, J.M.Dimaio, S.Milchgrub, A.L.Smith, R.F.Souza, L.Gilbey, X.Zhang, K.Gandia, M.B.Vaughan, W.E.Wright, A.F.Gazdar, J.W.Shay, J.D.Minna, 2004. Immortalization of human bronchial epithelial cells in the absence of viral oncoproteins. *Cancer Res.* **64**: 9027-9034.
30. Reya,T., S.J.Morrison, M.F.Clark, I.L.Weissman, 2001. Stem cells, cancer, and cancer stem cells. *Nature* **414**: 105-111.
31. Rubin,H., 2001. The role of selection in progressive neoplastic transformation. *Adv. Cancer Res.* **83**: 159-207.
32. Serakinci,N., P.Guldberg, J.S.Burns, B.Abdallah, H.Schroder, T.Jensen, M.Kassem, 2004. Adult human mesenchymal stem cell as a target for neoplastic transformation. *Oncogene* **23**: 5095-5098.
33. Sharpless,N.E., R.A.DePinho, 2004. Telomeres, stem cells, senescence, and cancer. *J. Clin. Invest* **113**: 160-168.
34. Shi,S., S.Gronthos, S.Chen, A.Reddi, C.M.Counter, P.G.Robey, C.Y.Wang, 2002. Bone formation by human postnatal bone marrow stromal stem cells is enhanced by telomerase expression. *Nat. Biotechnol.* **20**: 587-591.
35. Simonsen,J.L., C.Rosada, N.Serakinci, J.Justesen, K.Stenderup, S.I.Rattan, T.G.Jensen, M.Kassem, 2002. Telomerase expression extends the proliferative life-span and maintains the osteogenic potential of human bone marrow stromal cells. *Nat. Biotechnol.* **20**: 592-596.
36. Terai,M., T.Uyama, T.Sugiki, X.K.Li, A.Umezawa, T.Kiyono, 2005. Immortalization of human fetal cells: the life span of umbilical cord blood-derived cells can be prolonged without manipulating p16INK4a/RB braking pathway. *Mol. Biol. Cell* **16**: 1491-1499.
37. Xu,C., J.Jiang, V.Sottile, J.McWhir, J.Lebkowski, M.K.Carpenter, 2004. Immortalized fibroblast-like cells derived from human embryonic stem cells support undifferentiated cell growth. *Stem Cells* **22**: 972-980.
38. Zimmermann,S., S.Glaser, R.Ketteler, C.F.Waller, U.Klingmuller, U.M.Martens, 2004. Effects of telomerase modulation in human hematopoietic progenitor cells. *Stem Cells* **22**: 741-749.

## Supplement

### I. Protocol

Producing Lentivirus in 293FT Cells in T-225 flask

#### Materials

- Lentiviral packaging mix (Invitrogen)
- pLenti expression vector containing your gene of interest (endotoxin free)
- 293FT cells cultured in complete growth medium containing 500 µg/ml Geneticin (You will need  $8 \times 10^6$  293FT cells for each sample)
- Lipofectamine™ 2000 transfection reagent (store at +4°C and mix gently before use; **DO not vortex; Never freeze**)
- Opti-MEM® I Reduced Serum Medium (pre-warmed; see the next page)
- Fetal bovine serum (FBS)
- Complete growth medium (*i.e.* D-MEM containing 10% FBS, 2 mM L-glutamine, 0.1 mM MEM Non-Essential Amino Acids, 1% penicillin-streptomycin, and 1 mM MEM Sodium Pyruvate)
- Sterile, T-75 tissue culture flasks (one for each lentiviral construct)
- 5 ml sterile polystyrol tubes
- Sterile, tissue culture supplies
- 50 ml sterile, capped, conical tubes
- 15 ml sterile, capped, conical tubes

#### Transfection Procedure

**1. For each transfection sample**, prepare DNA-Lipofectamine™ 2000 complexes as follows:

**a.** In a sterile 5 ml polystyrol tube, dilute:

11,9 µg (11,9 µl) ViraPower lentiviral packaging mix, and

3,97 µg of pLenti expression plasmid DNA

-pLenti-RFP (0,661 µg/µl): 6,0 µl

-pLenti-GFP (0,2 µg/µl): 19,9 µl

-pLenti-BFP (1 µg/µl): 4,0 µl

-pLenti-Tet-ON-dBla (0,98 µg/µl): 4,1 µl

in 1.98 ml of Opti-MEM® I Medium without serum. Mix gently.



- b.** In a separate sterile 5 ml polystyrol tube, mix Lipofectamine™ 2000 gently before use, then dilute 47,6µl in 1,98 ml of Opti-MEM® I Medium without serum. Mix gently and incubate for 5 minutes at room temperature.
  - c.** After the 5 minute incubation, combine the diluted DNA with the diluted Lipofectamine™ 2000. Mix gently.
  - d.** Incubate for 20 minutes at room temperature to allow the DNA-Lipofectamine™ 2000 complexes to form.
- 2.** Trypsinize and count the 293FT cells. Resuspend the cells at a density of  $1,2 \times 10^6$  cells/ml in Opti-MEM® I Medium containing 10% fetal bovine serum. **Do not include antibiotics in the medium.**
  - 3.** Add the DNA-Lipofectamine™ 2000 complexes to a T-75 tissue culture flask containing 6,61 ml Opti-MEM® I Medium containing serum. **Do not include antibiotics in the medium.**
  - 4.** Add 6,61 ml of the 293FT cell suspension ( $7,9 \times 10^6$  total cells) to the flask containing media and DNA-Lipofectamine™ 2000 complexes. Mix gently by rocking the flask back and forth. Incubate cells for 6 h at 37°C in a CO<sub>2</sub> incubator.
  - 5.** After 6 h incubation, remove the medium containing the DNA-Lipofectamine™ 2000 complexes and replace with 10 ml complete culture medium.
  - 6.** Harvest virus-containing supernatants 45 hours posttransfection by removing medium to a 15 ml sterile, capped, conical tube.
  - 7.** Centrifuge at 3000 rpm for 15 minutes at 4°C to pellet cell debris. Collect viral supernatant.
  - 8.** Store viral stocks in aliquots at -80°C.

## II. Sequencing result of pLenti6/V5-hTERT

```

1  ttaagtttga ccttaggtca ctggaaagat gtcgagcggg tgcctcacia
aattcaaaact ggaatccagt gacctttcta cagctcgcct agcagagtgtt

51  ccagtcggta gatgtcaaga agagacgttg ggttaccttc tgctctgcag
ggtcagccat ctacagttct tctctgcaac ccaatggaag acgagacgtc

101 aatggccaac ctttaacgtc ggatggccgc gagacggcac ctttaaccga
ttaccggttg gaaattgcag cctaccggcg ctctgccgtg gaaattggct

151 gacctcatca cccagggtta gatcaaggtc ttttcacctg gcccgcatgg
ctggagtagt gggccaatt ctagttccag aaaagtggac cgggcgtacc

201 acaccagac caggtcccct acatcgtgac ctgggaagcc ttggcttttg
tgtgggtctg gtccagggga tgtagcactg gacccttcg g aaccgaaaac

251 accccctcc ctgggtcaag ccctttgtac accctaagcc tccgcctcct
tggggggagg gaccagttc gggaaacatg tgggattcgg aggcggagga

301 cttcctccat ccgccccgtc tctccccctt gaacctctc gttcgacccc
gaaggaggta ggcggggcag agagggggaa cttggaggag caagctgggg

351 gcctcgatcc tccctttatc cagccctcac tccttctcta ggcgccggcc
cggagctaag agggaaatag gtcgggagtg aggaagagat ccgcggccgg

401 ggatcccagt gtggtggtac gtaggaattc gtctgctgc gcacgtggga
cctagggtca caccaccatg catccttaag caggacgacg cgtgcacct

451 agccctggcc ccggccacc ccgcgatgcc gcgcgctccc cgctgccgag
tcgggaccgg ggccgggtgg ggcgctacgg cgcgcgaggg gcgacggctc
>>.....hTERT.....>
      m p r a p r c r

501 ccgtgcgctc cctgctgcgc agccactacc gcgaggtgct gccgctggcc
ggcacgcgag ggacgacgcg tcggtgatgg cgctccacga cggcgaccgg
>.....hTERT.....>
      a v r s l l r s h y r e v l p l a

551 acgttcgtgc ggcgcctggg gccccagggc tggcggctgg tgcagcgcgg
tgcaagcacg ccgcggaccc cgggggtccc accgcccacc acgtcgcgcc
>.....hTERT.....>
      t f v r r l g p q g w r l v q r

601 ggaccggcg gctttccgcg cgctgggtgg ccagtgcctg gtgtgcgtgc
cctggggccgc cgaaaggcgc gcgaccaccg ggtcacggac cacacgcacg
>.....hTERT.....>
      g d p a a f r a l v a q c l v c v

651 cctgggacgc acggccgccc cccgcccgcc cctccttcg ccaggtgtcc
ggaccctgcg tgccggcggg gggcggcggg ggaggaaggc ggtccacagg
>.....hTERT.....>
      p w d a r p p p a a p s f r q v s

701 tgctgaagg agctggtggc ccgagtgctg cagaggctgt gcgagcgcgg
acggacttcc tcgaccaccg ggctcacgac gtctccgaca cgctcgcgcc
>.....hTERT.....>
      c l k e l v a r v l q r l c e r

751 cgcaagaac gtgctggcct tcggcttcgc gctgctggac gggggccgcg
gcgcttcttg cacgaccgga agccgaagcg cgacgacctg ccccgggcgc
>.....hTERT.....>

```

g a k n v l a f g f a l l d g a r

801 ggggcccc cgaggccttc accaccagcg tgcgcagcta cctgccccaac  
ccccgggggg gctccggaag tgggtggcgc acgcgtcgat ggacgggtg  
>.....hTERT.....>  
g g p p e a f t t s v r s y l p n

851 acggtgaccg acgactgcg ggggagcggg gcgtgggggc tgctgctgcg  
tgccactggc tgcgtgacgc cccctgccc cgcacccccg acgacgacgc  
>.....hTERT.....>  
t v t d a l r g s g a w g l l l

901 ccgctggggc gacgacgtgc tggttcacct gctggcacgc tgcgcgtct  
ggcgcacccg ctgctgcacg accaagtgga cgaccgtgcg acgcgcgaga  
>.....hTERT.....>  
r r v g d d v l v h l l a r c a l

951 ttgtgctggt ggtcccagc tgcgcctacc aggtgtgcg gcccgcgctg  
aacacgacca ccgagggtcg acgcggatgg tccacacgcc cggcggcgac  
>.....hTERT.....>  
f v l v a p s c a y q v c g p p l

1001 taccagctcg gcgctgccac tcaggcccgg cccccgccac acgctagtgg  
atggtcgagc cgcgacgggtg agtccggggc gggggcgggtg tgcgatcacc  
>.....hTERT.....>  
y q l g a a t q a r p p p h a s

1051 acccgaagg cgtctgggat gcgaacgggc ctggaacct agcgtcaggg  
tggggcttcc gcagacccta cgcttgcccg gaccttggtg tgcagtccc  
>.....hTERT.....>  
g p r r r l g c e r a w n h s v r

1101 aggccgggggt cccctgggc ctgccagccc cgggtgcgag gaggcgggg  
tccggcccc gggggaccgc gacggtcggg gccacgctc ctccgcgcc  
>.....hTERT.....>  
e a g v p l g l p a p g a r r r g

1151 ggcagtgcc gccaagtct gccgttgccc aagaggcca ggcgtggcgc  
ccgtcacggt cggcttcaga cggcaacggg ttctccgggt cgcaccgcg  
>.....hTERT.....>  
g s a s r s l p l p k r p r r g

1201 tgcccctgag cggagcggg ccccgttg gcaggggtcc tgggccacc  
acggggactc ggcctgcct ggggcaacc cgtcccagc acccgggtg  
>.....hTERT.....>  
a a p e p e r t p v g q g s w a h

1251 gggcaggac gcgtggacc agtgaccgtg gtttctgtgt ggtgtcacct  
gcccgtctg cgcacctggc tcaactggcac caaagacaca ccacagtgga  
>.....hTERT.....>  
p g r t r g p s d r g f c v v s p

1301 gccagaccgc ccgaagaagc cacctcttg gagggtgcg tctctggcac  
cggctcgggc ggcttcttcg gtggagaaac ctcccacgc agagaccgtg  
>.....hTERT.....>  
a r p a e e a t s l e g a l s g

1351 gcgccactcc cacccatcc tgggcccga gcaccacgc gggccccat  
cgcggtagg gtgggtagg acccggcgg cgtggtgcg cggggggta  
>.....hTERT.....>  
t r h s h p s v g r q h h a g p p

1401 ccacatcgc gccaccacgt ccctgggaca cgccttgctc cccgggtgac

```
ggtgtagcgc cggtggtgca gggaccctgt gcggaacagg gggccacatg
>.....hTERT.....>
s t s r p p r p w d t p c p p v y

1451 gccgagacca agcacttctt ctactcctca ggcgacaagg agcagctgcg
cggctctggt tcgtgaagga gatgaggagt ccgctgttcc tcgtcgacgc
>.....hTERT.....>
a e t k h f l y s s g d k e q l

1501 gccctccttc ctactcagct ctctgaggcc cagcctgact ggcgctcgga
cgggaggaag gatgagtcga gagactccgg gtcggactga ccgagagcct
>.....hTERT.....>
r p s f l l s s l r p s l t g a r

1551 ggctcgtgga gaccatcttt ctgggttcca ggcctggat gccagggact
ccgagcacct ctggtagaaa gaccaaggt ccgggaccta cggtcctga
>.....hTERT.....>
r l v e t i f l g s r p w m p g t

1601 ccccgaggt tgccccgcct gccccagcgc tactggcaaa tgcgggccct
ggggcgcca acggggcgga cggggtcgcg atgaccgttt acgccggga
>.....hTERT.....>
p r r l p r l p q r y w q m r p

1651 gtttctggag ctgcttggga accacgcgca gtgccctac ggggtgctcc
caaagacctc gacgaacct tggtgcgcg caggggatg cccacgagg
>.....hTERT.....>
l f l e l l g n h a q c p y g v l

1701 tcaagacgca ctgcccgtg cgagctgagg tcacccagc agccggtgct
agttctgctg gacgggcgac gctcgacgcc agtggggtcg tcggccacag
>.....hTERT.....>
l k t h c p l r a a v t p a a g v

1751 tgtgcccggg agaagccca gggctctgtg gggcccccg aggaggagga
acacgggcc tcttcgggt cccgagacac cgccggggc tctctctct
>.....hTERT.....>
c a r e k p q g s v a a p e e e

1801 cacagacccc cgtcgcttg tgcagctgct ccgccagcac agcagccct
gtgtctgggg gcagcggacc acgtcgacga ggcggtcgtg tcgtcgggga
>.....hTERT.....>
d t d p r r l v q l l r q h s s p

1851 ggcaggtgta cggcttcgtg cgggcctgcc tgcgcccggct ggtgccccca
ccgtccacat gccgaagcac gcccggacgg acgcccga ccacgggggt
>.....hTERT.....>
w q v y g f v r a c l r r l v p p

1901 ggcctctggg gctccaggca caacgaacgc cgcttctca ggaacaccaa
ccgagacccc cgaggtccgt gttgcttgcg gcgaaggagt ccttgtggtt
>.....hTERT.....>
g l w g s r h n e r r f l r n t

1951 gaagttcatc tccctgggga agcatgcaa gctctcgctg caggagctga
cttcaagtag agggaccctt tcgtacggtt cgagagcgac gctctcgact
>.....hTERT.....>
k k f i s l g k h a k l s l q e l

2001 cgtggaagat gagcgtgagg ggctgagctt ggctgagcag gagcccaggg
gcaccttcta ctgcacgcc ccgacgcgaa ccgacgcgtc ctcgggtccc
>.....hTERT.....>
t w k m s v r g c a w l r r s p g
```

2051 gttggctgtg ttccggccgc agagcaccgt ctgcgtgagg agatcctggc  
caaccgacac aaggccggcg tctcgtggca gacgactcc tctaggaccg  
>.....hTERT.....>  
v g c v p a a e h r l r e e i l

2101 caagttcctg cactggctga tgagtgtgta cgtcgtcgag ctgctcaggt  
gttcaaggac gtgaccgact actcacacat gcagcagctc gacgagtcca  
>.....hTERT.....>  
a k f l h w l m s v y v v e l l r

2151 ctttctttta tgtcacggag accacgtttc aaaagaacag gctctttttc  
gaaagaaaat acagtgcctc tggtgcaaag ttttcttgtc cgagaaaaag  
>.....hTERT.....>  
s f f y v t e t t f q k n r l f f

2201 taccggaaga gtgtctggag caagttgcaa agcattggaa tcagacagca  
atggccttct cacagacctc gttcaacgtt tcgtaacctt agtctgtcgt  
>.....hTERT.....>  
y r k s v w s k l q s i g i r q

2251 cttgaagagg gtgcagctgc gggagctgtc ggaagcagag gtcaggcagc  
gaacttctcc cacgtcgacg ccctcgacag ccttcgtctc cagtccgtcg  
>.....hTERT.....>  
h l k r v q l r e l s e a e v r q

2301 atcgggaagc caggcccgcc ctgctgacgt ccagactccg cttcatcccc  
tagcccttcg gtccggcgcg gacgactgca ggtctgaggc gaagtagggg  
>.....hTERT.....>  
h r e a r p a l l t s r l r f i p

2351 aagcctgacg ggctgcgcc gattgtgaac atggactacg tcgtgggagc  
ttcgactgc ccgacgccg ctaacacttg tacctgatgc agcaccctcg  
>.....hTERT.....>  
k p d g l r p i v n m d y v v g

2401 cagaacgttc cgcagagaaa agagggccga gcgtctcacc tcgaggggtga  
gtcttgcaag gcgtctcttt tctcccggct cgcagagtgg agtcccact  
>.....hTERT.....>  
a r t f r r e k r a e r l t s r v

2451 aggcactggt cagcgtgctc aactacgagc gggcgcgggc ccccggcctc  
tccgtgacaa gtcgacagag ttgatgctcg cccgcgccgc ggggccggag  
>.....hTERT.....>  
k a l f s v l n y e r a r r p g l

2501 ctgggcgcct ctgtgctggg cctggacgat atccacaggg cctggcgcac  
gaccgcgga gacacgacc ggacctgcta taggtgtccc ggaccgctg  
>.....hTERT.....>  
l g a s v l g l d d i h r a w r

2551 cttcgtgctg cgtgtgcggg ccaggaccc gccgcctgag ctgtactttg  
gaagcacgac gcacacgcc gggctctggg cggcggactc gacatgaaac  
>.....hTERT.....>  
t f v l r v r a q d p p p e l y f

2601 tcaaggtgga tgtgacggc gcgtacgaca ccatccccca ggacaggctc  
agttccacct aactgcccc cgcagtctgt ggtagggggg cctgtccgag  
>.....hTERT.....>  
v k v d v t g a y d t i p q d r l

2651 acggaggtca tcgccagcat catcaaacc cagaacacgt actgcgtgcg  
tgccctccagt agcggtcgta gtagtttggg gtcttgtgca tgacgcacg

```
>.....hTERT.....>
  t e v i a s i i k p q n t y c v

2701 tcggtatgcc gtggtccaga aggccgccca tgggcacgtc cgcaaggcct
agccatacgg caccaggctt tccggcgggt acccgtgcag gcgttccgga
>.....hTERT.....>
  r r y a v v q k a a h g h v r k a

2751 tcaagagcca cgtctctacc ttgacagacc tccagccgta catgagacag
agttctcggg gcagagatgg aactgtctgg aggtcggcat gtacgctgct
>.....hTERT.....>
  f k s h v s t l t d l q p y m r q

2801 ttggtggctc acctgcagga gaccagcccg ctgagggatg ccgtcgtcat
aagcaccgag tggacgtcct ctggtcgggc gactccctac ggcagcagta
>.....hTERT.....>
  f v a h l q e t s p l r d a v v

2851 cgagcagagc tcctccctga atgaggccag cagtggcctc ttcgacgtct
gctcgtctcg aggagggact tactccggtc gtcaccggag aagctgcaga
>.....hTERT.....>
  i e q s s s l n e a s s g l f d v

2901 tcctacgctt catgtgccac cagcccgctg gcatcagggg caagtccctac
aggatgcgaa gtacacgggtg gtgcggcacg cgtagtcccc gttcaggatg
>.....hTERT.....>
  f l r f m c h h a v r i r g k s y

2951 gtccagtgcc aggggatccc gcagggctcc atcctctcca cgctgctctg
caggtcacgg tcccctaggg cgtcccggag taggagaggt gcgacgagac
>.....hTERT.....>
  v q c q g i p q g s i l s t l l

3001 cagcctgtgc tacggcgaca tggagaacaa gctgtttgcg gggattcggc
gtcggacacg atgccgctgt acctcttggt cgacaaacgc ccctaagccg
>.....hTERT.....>
  c s l c y g d m e n k l f a g i r

3051 gggacgggct gctcctgcgt ttggtggatg atttcttggt ggtgacaact
ccctgccccg cgaggacgca aaccacctac taaagaacaa cactgtgga
>.....hTERT.....>
  r d g l l l r l v d d f l l v t p

3101 cacctacccc acgcgaaaac cttcctcagg accctggctc gaggtgtccc
gtggagtggg tgcgcttttg gaaggagtcc tgggaccagg ctccacaggg
>.....hTERT.....>
  h l t h a k t f l r t l v r g v

3151 tgagtatggc tgcgtggtga acttgccgaa gacagtgggt aacttccctg
actcataccg acgcaccact tgaacgcctt ctgtcaccac ttgaagggac
>.....hTERT.....>
  p e y g c v v n l r k t v v n f p

3201 tagaagacga ggcctgggt ggcacggctt ttgttcagat gccggcccac
atcttctgct ccgggaccca ccgtgccgaa aacaagtcta cggccgggtg
>.....hTERT.....>
  v e d e a l g g t a f v q m p a h

3251 ggcctattcc cctggtgctg cctgctgctg gataccgga cctggaggt
ccgataaagg ggaccacgcc ggacgacgac ctatgggcct gggacctcca
>.....hTERT.....>
  g l f p w c g l l l d t r t l e
```

3301 gcagagcgac tactccagct atgcccggac ctccatcaga gccagtctca  
cgtctcgtcg atgaggtcga tacgggcctg gaggtagtct cggtcagagt  
>.....hTERT.....>  
v q s d y s s y a r t s i r a s l

3351 ccttcaaccg cggcttcaag gctgggagga acatgcgtcg caaactcttt  
ggaagttggc gccgaagttc cgaccctcct tgtacgcagc gtttgagaaa  
>.....hTERT.....>  
t f n r g f k a g r n m r r k l f

3401 ggggtcttgc ggctgaagtg tcacagcctg tttctggatt tgcaggtgaa  
cccagaacg ccgacttcac agtgtcggac aaagacctaa acgtccactt  
>.....hTERT.....>  
g v l r l k c h s l f l d l q v

3451 cagcctccag acggtgtgca ccaacatcta caagatcctc ctgctgcagg  
gtcggagggtc tgccacacgt ggtttagat gttctaggag gacgacgtcc  
>.....hTERT.....>  
n s l q t v c t n i y k i l l l q

3501 cgtacagggt tcacgcatgt gtgctgcagc tcccatttca tcagcaagtt  
gcatgtccaa agtgcgtaca cagcagctcg agggtaaagt agtcgttcaa  
>.....hTERT.....>  
a y r f h a c v l q l p f h q q v

3551 tggaagaacc ccacattttt cctgcgcgtc atctctgaca cggcctcct  
accttcttgg ggtgtaaaaa ggacgcgcag tagagactgt gccggaggga  
>.....hTERT.....>  
w k n p t f f l r v i s d t a s

3601 ctgctactcc atcctgaaag ccaagaacgc agggatgtcg ctgggggcca  
gacgatgagg taggactttc ggttcttgcg tccctacagc gacccccggt  
>.....hTERT.....>  
l c y s i l k a k n a g m s l g a

3651 agggcgccgc cggccctctg ccctccgagg ccgtgcagtg gctgtgccac  
tcccgcggcg gccgggagac gggaggctcc ggcacgtcac cgacacggtg  
>.....hTERT.....>  
k g a a g p l p s e a v q w l c h

3701 caagcattcc tgctcaagct gactcgacac cgtgtcacct acgtgccact  
gttctgtaagg acgagttcga ctgagctgtg gcacagtgga tgcacgggtga  
>.....hTERT.....>  
q a f l l k l t r h r v t y v p

3751 cctgggggtca ctcaggacag cccagacgca gctgagtcgg aagctcccgg  
ggacccaggt gagtcctgtc gggctctgct cgactcagcc ttcgagggcc  
>.....hTERT.....>  
l l g s l r t a q t q l s r k l p

3801 ggacgacgt gactgcctg gaggccgcag ccaaccggc actgcctca  
cctgctgca ctgacgggac ctccggcgtc ggttgggccc tgacgggagt  
>.....hTERT.....>  
g t t l t a l e a a a n p a l p s

3851 gacttcaaga ccatcctgga ctgagtcgac cctgtggaat gtgtgtcagt  
ctgaagttct ggtaggacct gactcagctg ggacacctta cacacagtca  
>.....hTERT.....>>  
d f k t i l d -

3901 tagggtgtgg aaagtcccca ggctccccag caggcagaag tatgcaaagc  
atcccacacc ttccaggggt ccgaggggtc gtccgtcttc atacgtttcg

3951 atgcatctca attagtcagc aaccaggtgt ggaaagtccc caggctcccc  
tacgtagagt taatcagtcg ttggtccaca cctttcaggg gtccgagggg

4001 agcaggcaga agtatgcaaa gcatgcatct caattagtca gcaaccatag  
tcgtccgtct tcatacgttt cgtacgtaga gttaatcagt cgttggtatc

4051 tcccgccctt aactccgcc atcccgcctt taactccgcc cagttccgcc  
agggcgggga ttgagggcgg tagggcgggg attgagggcgg gtcaagggcg

4101 cattctccgc cccatggctg actaattttt tttatttatg cagagggcga  
gtaagaggcg gggtagccgac tgattaataa aaataaatac gtctccggct

4151 ggccgcctcg gcctctgagc tattccagaa gtagtgagga ggcttttttg  
ccggcgggagc cggagactcg ataaggctt catcactcct ccgaaaaaac

4201 gaggcctagg cttttgcaaa aagcttacca tgaccgagta caagcccacg  
ctccggatcc gaaaacgttt ttcgaatggt actggctcat gttcgggtgc

4251 gtgcgcctcg ccaccgcga cgac  
cacgcggagc ggtgggcgct gctg



**List of abbreviation**

ALP	Alkaline phosphatase
ARF	Alternative reading frame, p14
ATM	Ataxia telangiectasia mutated
CD	Cluster of differentiation
CDK	Cyclin-dependent kinase
CDKN1A	Cyclin-dependent kinase inhibitor 1A, p21
CDS	Coding domain sequence
Cfba1/Runx2	Core-binding factor 1/Runt-related transcription factor 2
c-myc	v-myc myelocytomatosis viral oncogene homolog
Col I	Collagen type I
DBCCR1	Deleted in bladder cancer chromosome region candidate 1
DMEM	Dulbecco's Modified Eagle's Medium
DPX	Di-n-butylPhthalate in Xylene
E2F	E2F transcription factors
EDTA	Ethylene diamine tetraacetic acid
FBS	Fetal bovine serum
FISH	Fluorescence <i>in situ</i> hybridization
GO	Gene ontology
GOI	Gene of interest
HA	Hyaluronic acid
H-CAM	Homing-associated cell adhesion molecule
HIV	human immunodeficiency virus
hMSCs	human mesenchymal stem cells
hTERT	human telomerase reverse transcriptase
IBMX	3-Isobutyl-1-methylxanthin
INK4a(Cdkn2a)	Cyclin-dependent kinase inhibitor 2A, p16
KRAS	v-Ki-ras2 Kirsten rat sarcoma viral oncogene homolog
LCA	Leukocyte common antigen
LPS	Lipopolysaccharide
LTR	Long terminal repeats
MCS	Multiple cloning site
MDM2	Mouse double minute 2 homolog

MMPs	Matrix metalloproteinases
MoMLV	Moloney Leukemia Virus
NRAS	Neuroblastoma RAS viral oncogene homolog
OC	Osteocalcin
PBS	Phosphate-buffered saline
PDL	Cumulative population doubling level
PDT	Population doubling time
Retinoblastoma 1	RB1
ROS	Reactive oxygen species
RTCGD	Retrovirus tagged cancer gene database
RT-PCR	Reverse transcription-polymerase chain reaction
SC-1	Stem cell antigen-1
SCP	Single Cell Picking
TERC	Telomerase RNA component
TGF- $\beta$	Transforming growth factor beta
TRAP	Telomeric repeat amplification protocol
TSS	Transcription start site
Tumor protein 53	TP53
$\beta$ -ME	$\beta$ -Mercaptoethanol

## Acknowledgement

First, I'd like to thank my tutor Prof. Dr. med. Wolf Mutschler. From him I have learned a lot. His earnest attitude toward research and clinical work, his kindness give me a deep remembrance of the surgical clinic and Germany. For all the doctoral work I have finished, I need to give my respect to Prof. Dr. med. Matthias Schieker, who is the leader of "ExperiMed-Experimental surgery and regenerative medicine". With his kind help and thorough instruction I finished my doctoral work successfully. I will thank Priv.-Doz. Dr. med. Wolfgang Boecker and Dr. rer.nat. Denitsa Docheva for their help in research work design; thank Brigitte Hackl for every detailed help in the experiment; thank Dipl. Hdl. Sandra Peter and Dr. med. Michael Stengele for help with basic working needs; thank Hella Thun and Birgit Sigl for their help in presentation preparation and literature searching; thank Khrystyna Ern, Claudia Harbauer, Tzvetan Popov, Oliver Rossmann and Martina Burggraf for their help with histological observation and molecular research work; thank Dr. med. Elias Volkmer, Florian Haasters, Stephanie Schindler, Thomas Lemberger, Daniela Padula, Inga Drosse, Sophia Poppe, Borys Frankewycz, Ulrich Lenze, Florian Pohlig, Andreas Leib and Tobias Schiergens for their every minor but thoughtful help in both my research work and living in Munich, that will be a treasure in my memory.

Last but not the least, I would like to thank my wife, Dr. Zhang Jing and my parents for their years-long silent support and love, which give me strength to fulfill.

## Curriculum vitae

Zhanhai Yin

Birthday: 14. Jan. 1974

E-mail address: [zhanhaiyin2002@yahoo.com.cn](mailto:zhanhaiyin2002@yahoo.com.cn)

Nationality: P.R.China

Marriage: Married

## EDUCATION

**1980-1986 Qing'an Elementary School, Xi'an, Shaanxi, China**

**1986-1992 Qing'an Middle School, Xi'an, Shaanxi, China**

**1992-1999 Xi'an Medical University, Xi'an, Shaanxi, China**

Attended Xi'an Medical University directly as a candidate for master's degree for higher records in national high-education entrance examination.

Carried out research work on "Experimental Study on Repair of Bone Defect in Femoral Head by Enhanced Autogenous Bone Combined with Bone Morphogenetic Protein". Master of Medicine.

## PROFESSIONAL EXPERIENCE

**1999-2002**

**Department of Orthopaedics, First Affiliated Hospital, College of Medicine, Xi'an Jiaotong University, Xi'an, Shaanxi, China** **Resident Doctor**

Got systemic training in the department of orthopaedics of the first hospital of Xi'an Jiaotong University.

Carried out research work on "Repair of osteochondral defects by 'two-phase' tissue engineered cartilage --autologous bone marrow mesenchymal stem cells seeded onto 'two-phase' allogeneic bone matrix gelatin", got satisfying results.

Jointly applied for and got "Scientific Research Foundation of the First Affiliated Hospital (2000)" for research on tissue engineering.

Jointly got "Natural Scientific Foundation of Shaanxi Province (2001)" for research on tissue-engineering cartilage.

**2002-2005**

**Department of Orthopaedics, First Affiliated Hospital, College of Medicine, Xi'an Jiaotong University, Xi'an, Shaanxi, China** **Attending Doctor**

Jointly cared nearly 405 patients and nearly 140 outpatients, carried out nearly 284 operations on cervical spondylosis, lumbar spinal canal stenosis and intervertebral disc herniation, scoliosis, fracture, tuberculosis, inflammation of motor system, etc.

Supervised 2 grades of native medical students in clinical practice and gave lectures. Gave lessons to nearly 160 foreign medical students on orthopaedics.

Awarded "Outstanding Teacher in 2002-2003" and "Outstanding Teacher in 2004-2005" by the hospital.

Participated in a helping medical group, which was appointed by "Health Ministry of China", one month in outlying counties-"Zichang", "Yanchang" in the North of Shaanxi Province. Helped to care nearly 120 patients and carry out 2 orthopedic operations, highly praised by local people and governments.

Jointly got "Scientific Achievement Award of Higher-education Bureau in Shaanxi Province (second-class)" and "Science and Technology Achievement Award of Shaanxi Province (Third-class)" for research on "Construction and Application of Tissue-engineered Cartilage".

**2005-2007**

**Institute of Experimental Surgery and Regenerative Medicine, Department of Surgery-Downtown, Ludwig-Maximilians-University, Munich, Germany.**

**Doctoral Candidate of Dr. Med**

Carried out research on "Introducing a single-cell-derived human mesenchymal stem cell line expressing hTERT after lentiviral gene transfer".

This work was presented at the "1st Congress of the German Society for Stem Cell Research" and was awarded the 2nd poster price.

**2007-2009**

**Department of Orthopaedics, First Affiliated Hospital, College of Medicine, Xi'an Jiaotong University, Xi'an, Shaanxi, China** **Attending Doctor**

**2010**

**Department of Orthopaedics, First Affiliated Hospital, College of Medicine, Xi'an Jiaotong University, Xi'an, Shaanxi, China**

**Associate Chief Physician**

**Associate Professor**

Selected and appointed as "Youth Mainstay Teacher" of Xi'an Jiaotong University.

**2011**

**Department of Orthopaedics, Royal Liverpool and Broadgreen University hospital, Liverpool, UK.**

**Visiting Surgeon**

### **SPECIAL COMPETENCIES**

Passed level 5 of the "Public English Test System (PETS)", which was held by Ministry of Education of China. Fluent in reading, speaking and writing of English.

Successfully completed the "Intensive German Language Training Course" in the preparatory department of "Shanghai International Studies University" for overseas education / studies (456 credit hours from Sep. 2004 to Jan. 2005)

## Publications

### AUTHORED

1. Experimental Study on Repair of Bone Defect in Femoral Head by Enhanced Autogenous Bone Combined with Bone Morphogenetic Protein. *Zhongguo Xiu Fu Chong Jian Wai Za Zhi (Chinese Journal of reparative and reconstructive Surgery)*,2002;16(2):93-96
2. The Chondrogenic Potential of Rabbit Bone-marrow-derived Mesenchymal Stem Cells (MSCs) Assayed under the Influence of Growth Factors". *Nanjing Yi Ke Da Xue Xue Bao(Journal of Nanjing Medical University)*,2002;16(3):121-126
3. Isolation and induction of rabbit bone marrow mesenchymal stem cells to express chondrocytic phenotype. *Xi'an Jiao Tong Da xue Xue bao(Academic Journal of Xi'an Jiaotong University)*,2002;14(2):147-152
4. Repair of osteochondral defects by "two-phase" tissue engineered cartilage –autologous bone marrow mesenchymal stem cells seeded onto "two-phase" allogeneic bone matrix gelatin. *Zhongguo Xiu Fu Chong Jian Wai Za Zai(Chinese Journal of reparative and reconstructive Surgery)*,2005;19(8): 652-657
5. Tissue engineered cartilage constructed by growth factor-induced bone marrow mesenchymal stem cells and allogenic bone matrix gelatin. *Zhonghua Gu Ke Za Zhi (Chinese Journal of Orthopaedics)*, 2005;25(3):170-175
6. Wolfgang Böcker #, Zhanhai Yin # ( Shared first authorship), Inga Drosse, Florian Haasters, Oliver Rossmann, Matthias Wierer, Cvetan Popov, Melanie Locher, Wolf Mutschler, Denitsa Docheva, Matthias Schieker. Introducing a single-cell-derived human mesenchymal stem cell line expressing hTERT after lentiviral gene transfer. *J Cell Mol Med* 2008;12(4):1347-1359 (2008 SCI Impact factor: 5.114)
7. Bo Yang#, Zhanhai Yin#( Shared first authorship), Junling Cao, Zhongli Shi, Zengtie Zhang, Hongxing Song, Fuqiang Liu and Bruce Caterson. In vitro cartilage tissue engineering using cancellous bone matrix gelatin as a biodegradable scaffold. *Biomed. Mater.* 5 (2010) 045003. (2009 SCI Impact factor: 1.963)