

Aus dem Institut für Klinische Neurowissenschaften der

Ludwig-Maximilians-Universität München

Vorstand: Prof. Dr. med. Dr. h.c. Thomas Brandt, FRCP

Subcortical Control of Visual Fixation

Dissertation

zum Erwerb des Doktorgrades der Humanbiologie

an der Medizinischen Fakultät der

Ludwig-Maximilians-Universität zu München

vorgelegt von: Lorenzo Guerrasio

aus: Mailand (Italien)

Jahr: 2011

Mit Genehmigung der Medizinischen Fakultät
der Universität München

Berichterstatter: Prof. Dr. Ulrich Büttner

2.Berichterstatter: Prof. Dr. Oliver Ehrt

Mitberichterstatter: Prof. Dr. Peter Bartenstein

Priv. Doz. Dr. Karl Heinz Brisch

Mitbetreuung durch den

promovierten Mitarbeiter: Laurent Goffart, PhD

Dr.-Ing. Thomas Eggert

Dekan: Prof. Dr. med. Dr. h. c. M. Reiser, FACR, FRCR

Tag der mündlichen Prüfung: 23.05.2011

Erklärung:

Hiermit erkläre ich, dass ich diese Arbeit selbst verfasst und keine anderen als die angegebenen Quellen und Hilfsmittel benutzt habe.

München, den 06.09.2010

Index

1. Introduction	1
2. Background	4
2.1. Eye Movements	4
2.1.1. Saccades	5
2.1.2. Saccade parameters	6
2.2. Fixational Eye Movements	10
2.2.1. Qualitative and quantitative description of fixation and fixational eye movements.....	12
2.2.2. Factors modulating fixational eye movements	15
2.2.3. Origin and purpose of microsaccades	17
2.3. Neuronal substrate for the control of eye movements during fixation	21
2.3.1. Brainstem control of eye position	21
2.3.2. The role of the oculomotor cerebellum.....	27
3. Methods	32
3.1. Eye movement analysis.....	35
3.2. Measuring fixation	37
3.2.1. Calculation of the spatial distribution of dwell times	37
3.2.2. Analysis of the direction of fixational saccades	39
3.2.3. Graphical representation of saccade directions.....	41
3.2.4. Analysis of the amplitude of fixational saccades.....	42
4. Results	44
4.1. Qualitative description of the impairments on fixation following unilateral FOR inactivation.....	44
4.2. Effects on the corrective nature of fixational saccades.....	48
4.3. Effects on the control of directions	51
4.4. Effects on the control of amplitude.....	55
4.5. Effects on the foveating behaviour	58
4.6. Slow control and saccade triggering	63
5. Discussion & Conclusion	65
5.1. A novel analysis of the fixation behaviour	65
5.2. Foveation of a visual target.....	67
5.3. Effects of the unilateral FOR inactivation	68
5.4. Hypothetical role for the fastigio-tectal and the fastigio-reticular pathways.....	69
5.5. Foveation and generation of fixational saccades	71
5.6. Possible application in understanding pathological foveation and vision in patients.....	74
5.7. Conclusions.....	75
6. Summary	77
7. Zusammenfassung	79
A. Appendix	i
A.1. List of abbreviations	i
A.2. Test of directional bimodality.....	ii
A.3. Graphical representation of directions	v
B. List of References	viii
C. Acknowledgement	xvii

1.Introduction

One of the challenges of neuroscience since its early times is to understand how the brain uses sensory information in order to perform a motor task. Within the general field of sensory-motor transformation, the study of eye movements has always been regarded with particular attention; indeed, it adds to the intrinsic interest on a specific sensory-motor system, a broader interest for the neuronal control of movements due to their relative simplicity.

In this work, I analyze **movements** occurring when the gaze is held directed toward a visual target, a task commonly called **fixation**. The oxymoron in the previous sentence suggests that “fixation” could be a misleading word, interpreted as “absence of movement”. Perfect immobility is alien to biological systems: For instance, when we try to stand still, small movements always occur, and the body actually swings around a position of balance.

Similarly, when fixating a small target, the eyes of both human and non-human primates are known to perform small movements, called *fixational eye movements*, whose role and features have been broadly discussed and debated for a long time (Collewyn and Kowler 2008; Martinez-Conde et al. 2004; Rolfs 2009).

Interestingly, some of these movements have been associated with saccades. Saccades are very fast conjugate movements of the eyes; they are present even in primitive vertebrates in the form of quick phasic oculomotor responses that accompany head movements (Robinson 1981).

In foveate animals, they move the eyes to interesting portions of the visual scene in order to view them with the portion of retina providing the highest visual acuity, i.e. the fovea (Goffart 2009). Saccades occurring during fixation have been named in the past literature *flutters*, *microsaccades* or *fixational saccades*. Despite their different names, an increasing amount of evidence suggests that microsaccades share the same neural mechanisms as those involved in

the generation of larger saccades (Martinez-Conde et al. 2009). However, very few studies have been done to verify to which extent fixational saccades are generated in the same way as larger saccades: Perhaps is for this reason that their role is still a matter of debate.

Among the different areas involved in the generation of saccades, the caudal part of the Fastigial Nuclei (cFN), the most medial of the Deep Cerebellar Nuclei (DCN) have been recognized to play a fundamental role in the control of their accuracy (Robinson and Fuchs 2001). Lying beneath the cerebellar cortex, cFN neurons represent virtually the unique cerebellar output to the saccade-related structures in the brainstem; consequently, this portion of the fastigial nucleus has been named Fastigial Oculomotor Region (FOR).

Recordings of single neurons in this area show a sustained firing rate interrupted by bursts of activity during saccades in any direction. However the exact mechanism by which these neurons control saccadic eye movement is still under discussion (Fuchs et al. 1993; Kleine et al. 2003; Ohtsuka and Noda 1991). Its involvement in the control of saccade accuracy is demonstrated by the dysmetria that follows any lesion involving this area. In particular, the temporary inactivation of the FOR neurons by local injection of muscimol (a GABA-agonist) in the cFN causes visually guided horizontal saccades to overshoot ipsilateral target (hypermetric saccades) whereas contralateral saccades fall short of the target (hypometric saccades) (Goffart et al. 2004; Iwamoto and Yoshida 2002; Robinson et al. 1993). In addition, an impairment of acquiring the central target has been observed (Goffart et al. 2004; Robinson et al. 1993); in particular, monkeys use eye positions which are shifted towards the side of the injection, an impairment called fixation offset. The origin of this impairment is still not understood.

In the thesis at hand, the role of FOR neurons in visual fixation will be analyzed and discussed. To this purpose, a novel technique has been developed to quantify fixation and fixational saccades. By means of this and of more traditional analysis methods, the effect of unilateral

temporary inactivation of FOR neurons on fixation will be described and discussed. The analysis proposed provides also a mean of studying fixation as a dynamic behavior, integrating the classical view of maintaining a specific eye position. It will be shown that when looking at a small target, the eyes explore a relative extended visual area, and how the cerebellum contributes to this behaviour. The results will be used to provide a more general view of the subcortical control of visual fixation. Speculation can be made on the particular role of the oculomotor cerebellum in foveate vision.

2.Background

2.1.Eye Movements

To view objects, their image has to be projected on the retina, the photosensible part of the eyes.

From an oculomotor point of view, animals can be divided in two broad groups, depending on the presence of the fovea, a portion of the retina with a higher density of cone photoreceptors (corresponding to a highest resolving power). In general, afoveate animals use eye movements mainly to prevent the visual image from slipping on the retina; foveate animals add to these mechanisms of image stabilization, other movements which bring selected part of the visual field onto the fovea and hold them there (Robinson 1981).

From a kinematic point of view, it is possible to distinguish three kinds of eye movements: Slow and fast conjugate movements and convergence movements. As they are controlled by partially different neuronal structures (Büttner and Büttner-Ennever 2006), a classical subdivision (Dodge 1903) in five different types of movements is commonly used:

- Slow movements: (1) The slow phase of the *Vestibulo-Ocular Reflex* (VOR) and (2) of the *OptoKinetic Response* (OKR), (3) *smooth pursuit eye movements* (SPEM).
- Fast movements: (4) *Saccadic movements*, including fast phases of OKR and VOR; saccades occurring during smooth pursuit movements (catch-up saccades).
- Convergence movements: (5) Non-conjugate movements made to place the fovea of both eyes on the same near object.

2.1.1. Saccades

Saccades are quick, conjugate and simultaneous movements of the eyes. In afoveate animals they are always present as fast phases of optokinetic and vestibular nystagmus. In foveate animals, they also occur when the gaze has to be rapidly redirected towards a relevant point of the surround (Goffart 2009); saccades are normally produced for visually scanning the environment (Yarbus 1967) or while reading (Javal 1879; Rayner 1998). In a nutshell, saccadic eye movements cover a wide hierarchy of behaviors, from the most rudimentary (simple counter-effect of head movements) to the highest cognitive behaviour, such as saccades towards remembered locations (Leigh and Zee 2006). During saccades, the acuity of vision is strongly impaired, both because the motion of the image on the retina and because visual suppression occurring during these movements (Campbell and Wurtz 1978; Diamond et al. 2000; Morrone et al. 1997). Therefore, while on the one hand saccades help the perception of the whole visual scene even though visual information is sampled with high resolution only from discrete points (Yarbus 1967), on the other hand they often represent a nuisance, an obstacle to the optimal vision (but see also Castet and Masson 2000). For this reason, and because it is important that new relevant visual stimuli (e.g. potential threats or preys) are localized as soon as possible, saccades have to be extremely fast. The need of high speed of execution represents a requirement which can compromise the accuracy. Theoretically, the eye trajectory during motion could be continuously monitored and adjusted by visual feedback signals for an optimal accuracy. However, the duration of most saccades is too short for allowing an on-line guidance of saccade trajectory by visual signals. The fact of being accurate although very fast, has suggested that the oculomotor system might work in a feedforward-feedback modality (Glasauer 2003). In other words, the system may exploit an “internal knowledge” of the physical characteristics of eyes (the plant, in the jargon of automatic control

theory) to issue an appropriate motor command. The feedback control would regulate the representation of the plant, giving plasticity to the system. Consistent with this view, saccades display quite a stereotyped and ballistic nature. In particular, it has been observed a consistent relation (known as main sequence, see next paragraph) between the amplitude of saccades and their duration (or peak velocity). Furthermore, an unexpected shift of the target does not modify the trajectory of the movements if it occurs during a certain (refractory) time (about 130 ms), suggesting a pre-planning of saccades (Becker and Jürgens 1979; Lisberger et al. 1975; Westheimer 1954; Wheelless et al. 1966).

Although to a great extent saccades can be considered repetitive and predictable movements, other experimental observations indicate a probably more complex system for their generation. For instance, the main sequence shows some variability (Bollen et al. 1993), depending on several physiological (e.g., muscular fatigue) and psychological (e.g., attention, expectation of a reward) corollary factors (Becker 1989). Unsurprisingly, many models accounting for the generation of saccades have been proposed in the past, from the easiest to the most complex (Girard and Berthoz 2005), and more have to be done to explain all the characteristic of this particular behaviour.

2.1.2. Saccade parameters

The interest in saccadic eye movements increased from the 18th century together with the improvements of the recording techniques (Eggert 2007; Ratliff and Riggs 1950; Robinson 1981; Wade and Tatler 2005). The ease of recording their dynamic properties, the enormous amount of data available and their apparently lawful behavior made (and still make) saccades a popular means of investigation of brain functions (Leigh and Kennard 2004). The most

relevant parameters of saccades are summarized in figure 2.1 and will be shortly described here.

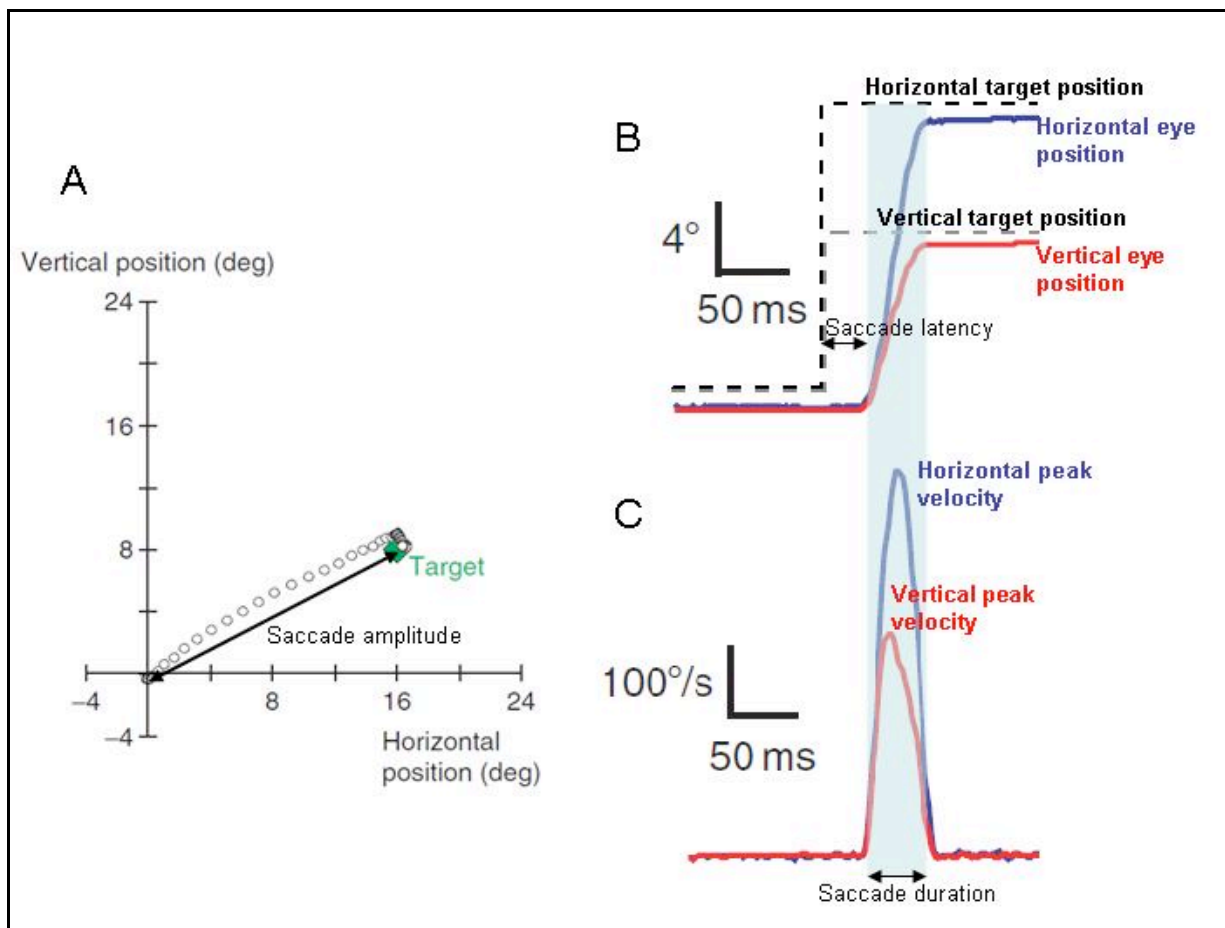

Figure 2.1: Principal parameters of saccadic eye movements.

A: The horizontal and vertical position of the eyes are sampled at regular temporal intervals (each circle is a sample); the amplitude of a saccade is defined as the difference between the initial and final position. **B:** The time course of the horizontal (blue trace) and vertical (red trace) component of eye position during a visually guided saccade (position of the target indicated by the black dashed line). Saccade latency is the time between the shift of the target position and the onset of the saccade, usually defined as the time the velocity of the movement become larger than a threshold value. **C:** Velocity trace derived from the movement in panel **B**. The peak velocity is an important parameter, varying with the saccade's amplitude. Figure adapted from Goffart 2009.

The most important measure of a movement is its amplitude: In primates, saccades range from few seconds of arc up to 90°. Larger gaze shifts are normally accompanied by head movements; during normal activity, the amplitude of most saccades is smaller than 15° (Bahill

et al. 1975). On the other extreme, very small saccades represent a puzzle under many aspects, and will be presented in detail in chapter 2.2. As a general indication, even though smaller saccadic movements can be identified, the size of the smallest voluntary saccade is about 3 min arc (Haddad and Steinman 1973).

In order to measure the amplitude of a saccade, it is necessary to define the moment when the movement starts and ends. Because they are characterized by a high speed and by the fact of occurring at the same time in both eyes, the most common ways of flagging saccades rely on velocity and/or acceleration thresholds and binocularity (when binocular recording is available). The method chosen for labeling the beginning and end of saccades affects both the measure of their amplitude and of their duration. Instead, the saccade peak velocity's measure is independent from an arbitrary definition of threshold; consequently, this is the most "popular" dynamic saccade parameter. The maximal eye velocity can exceed $700^{\circ}/\text{sec}$ in humans, and reach $1000^{\circ}/\text{sec}$ in non human primates.

Regardless small analytical measuring differences, a striking feature, which has been noticed since early times (Hyde 1959; Westheimer 1954), characterizes saccades: Their duration, amplitude and peak velocity display a rather lawful relation between each other. Early studies found a strong relationship linking the amplitude and the duration of saccades within a range of movements between 5 and 50 degrees (Becker 1989). The relation between saccade amplitude and peak velocity, also known as the main sequence (Bahill et al. 1975), shows that the peak velocity rises almost linearly up to saccades of $10\text{-}15^{\circ}$, and then starts to saturate as saccades size becomes larger (Becker 1989). The main sequence owes its name to the fact that it holds over several orders of magnitude, from small microsaccades to the largest (Bahill et al. 1975; Zuber and Stark 1965) (fig.2.2). These relations display some variability, both across different species and between individuals of the same species; many factors, including the movement's

direction, the nature of the target (e.g., auditory, visual, somesthetic or cognitive) and the level of attention and motivation of the subject contribute to the variability.

A further important parameter for stimulus-related saccades is their latency, i.e. the time between the occurrence of a stimulus and the subsequent saccade onset. Saccade latency is related to the level of alertness of the subject; for visual guided saccades, it is generally 180-220 ms, even though tested under certain experimental conditions, it can be sensibly lower both in monkeys (75ms) and humans (100 ms, Fischer and Ramsperger 1986). Latency is an important parameter because it gives an idea of the “computational” time required for generating a particular action.

Finally, the general accuracy of the saccadic system in a visually-guided task has been studied since long time (Bartz 1967; Hyde 1959; Westheimer 1954).

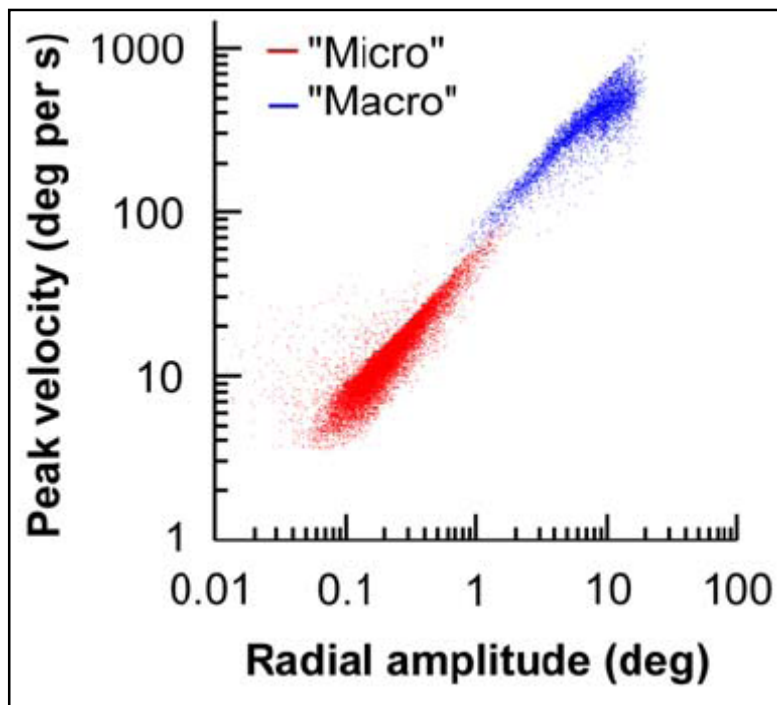

Figure 2.2: Main sequence across micro- and macrosaccades.

The same relation between the amplitude and peak velocity holds for saccades made during fixation (here plotted in red) and of larger visually guided saccades (blue). Figure from Haged et al. 2009

Accuracy is often measured by means of the ratio between the amplitude of a saccade and the eccentricity of the target that elicited the movement, a value that borrows the name of “gain” from the control theory, and that is widely used also in the physiology of reaching movements (Abel et al. 1978; Andersen et al. 1997; Optican and Robinson 1980; Selhorst et al. 1976). A gain values smaller than 1 indicates that the movement is too short to reach the target; conversely, a gain value bigger than 1 indicates an overshoot of the movement. This kind of impairment is generally named dysmetria: In particular, a movement is called hypermetric when its amplitude is too big and hypometric when it is too small to correctly reach the target.

2.2. Fixational Eye Movements

The difficulty of holding the eye perfectly still in a certain position was already acknowledged by early physicians. James Jurin (1738), in a letter to the English mathematician Robert Smith claimed that it was because of “the trembling of the eyes” that two near points were confused even if they were separated by an angle which is greater than the minimal angle a subject needs to discriminate an object. More than one hundred years later, Helmholtz (1867) described “the wandering of the gaze” as a means of the oculomotor system to avoid retinal fatigue, anticipating the most modern theory of vision. In between the 19th and the 20th century, many techniques were developed for recording the position and the movements of the eyes. These techniques were specifically adopted for studying fixation already in the first years of the 20th century (Marx and Trendelenburg 1911; McAllister 1905) and confirmed that, when fixating, the eyes were covering a relative large area because of movements which were independent from those of the head (thus not driven by the vestibular system). The technological improvement of eye recording techniques (see table 1 of Ditchburn and Ginsborg 1953 or the first chapter of Yarbus 1967 for reviews) made during those years allowed a more rigorous

study of the eye movements during fixation. In particular Adler and Fliegelman (1934) were already able to describe the 3 types of movements which are known to occur during the attempted fixation of a visual target. In particular, Adler and Fliegelman observed:

1. **Flicks:** Rapid shifts of the eyes occurring at a rate of about one per second; they were qualified as saccadic movements for the first time by Barlow (1952). Later, because of their small amplitude it became common to name these movements *microsaccades* (Zuber and Stark 1965).
2. **Slow waves:** Early papers were distinguishing between slow waves and drifts but, because of the difficulties in disentangle the two components (Cornsweet 1956), soon slow movements were generally indicated as eye drifts.
3. **Fine vibratory movements** (frequency between 30 and 100Hz): Because of their extremely small amplitude (15secarc to 2minarc) their existence was doubted for more than twenty years. Still now, the so called *microtremor* is the least studied of the fixational eye movement (see Martinez-Conde et al. 2004 for a review).

The subdivision proposed by Adler and Fliegelman established with the first extensive studies of Ratliff and Riggs (1950) in the US, Ditchburn and Ginsborg (1953) in the UK and Yarbus (1967) in Russia, who independently developed methods (the optical lever) for recording eye movements with high precision.

In the following chapters, the main features of fixational eye movements, which factors have an influence on them and the main hypotheses on their physiological function will be reviewed.

2.2.1. Qualitative and quantitative description of fixation and fixational eye movements

The movements performed during fixation are normally described according to their amplitude, the velocity of the eye and their frequency. In contrast to their specific visual role, there is a broad agreement on the general features of fixational eye movements:

Microtremor is the smallest of the fixational movements; its amplitude (rarely bigger than 1 minarc, see table 1 of Martinez-Conde et al. 2004) is often overlapping with the instrumental noise, and rarely exceeds the dimension of one receptor in the eye (Ratliff and Riggs 1950). Like the drift, it has been found in different species across all vertebrates (Martinez-Conde and Macknik 2008), but it remains unclear whether the microtremor accomplishes any physiological function. Because of that, I will not go more in detail of microtremor and hereafter fixation will be considered simply as the succession of small saccadic-like movements interrupting periods of relative stability of the eyes (fig.2.3A and B).

Drifts are commonly defined as those epochs between two microsaccades. Their amplitude (the distance between the end point and the starting point of two consequent microsaccades) and velocity can vary greatly between different subjects (Martinez-Conde et al. 2004). Because of drifting, a small target is projected over a dozen of retinal photo-receptors during fixation (Ratliff and Riggs 1950). Drift and microsaccades were found to be generally in the opposite direction (Cornsweet 1956; Nachmias 1959).

Microsaccades: Of all the fixational eye movements, microsaccades are the most easily recognizable. These rapid movements distinguished the behaviour of the head and the eyes during fixation (Lord and Wright 1948). Like larger saccades, they start simultaneously in the two eyes (Krauskopf et al. 1960; Lord 1951) and are in general conjugate (Møller et al. 2002; St Cyr and Fender 1969). Moreover, they share with larger saccades the main sequence (Zuber

and Stark 1965), i.e. the relation between their amplitude and peak velocity. During fixation also torsional saccades have been reported (Fender 1955; Morisita and Yagi 2001; Ott et al. 1992); these movements are an example of violation of the Listing law (according to which the torsional position of the eye can be entirely described by its horizontal and vertical component) being much larger as this law would predict. Microsaccades frequency (about 1 Hz), direction and amplitude have been reported to depend on the experimental conditions. In particular their amplitude is still a matter of debate (Collewijn and Kowler 2008). Indeed, classical studies done by means of optical lever reported mean amplitudes generally below 15minarc (see Martinez-Conde et al. 2004 for a collection of data). Although even in early studies saccades of almost a degree were reported as microsaccades (Ditchburn et al. 1959), according to some investigators true microsaccades are only those below 20minarc (Collewijn and Kowler 2008). In contrast, because there is no discontinuity in the main sequence (Zuber and Stark 1965, fig.2.2) and because voluntary saccades as small as microsaccades can be made (about 6minarc, Haddad and Steinman 1973), other investigators believe that no differentiation can be made on the basis of the amplitude (Engbert and Kliegl 2003; Hafed and Clark 2002; Martinez-Conde et al. 2004; Otero-Millan et al. 2008; Rolfs 2009).

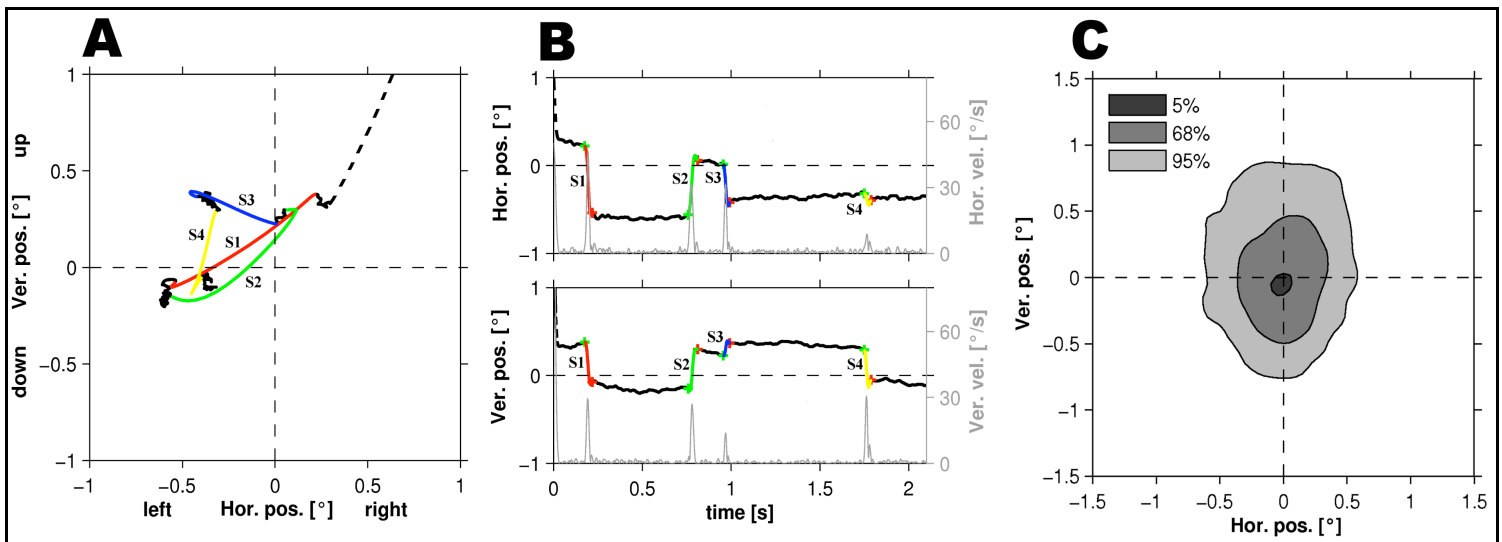

Figure 2.3: Typical oculomotor behaviour of a monkey fixating a small target located straight ahead.

The same single trial (2 seconds) is presented displaying the horizontal versus vertical component of the eye position (A) and considering the time course of the horizontal (upper) and vertical (bottom) component separately (B). Same saccades are indicated with same color and label. The thick black dashed trajectory is the end of a saccadic movement considered as primary i.e., bringing the eyes from the periphery to the central target. C displays the distribution of dwelling time for the whole experimental session. Darker colors are used for those positions which are dwelled longer. Each region encloses an increasing fraction of the total amount of time (percentage expressed in the legend). Therefore, the darker area represents the positions where the eyes dwell the most, and it encloses 5% of the total fixation time. In all panels, the positions are measured referring to the mean position of all the trials made during this experimental session; the thin dashed lines in all panels indicates this particular position (called in the text averaged position, AP).

Note that the distribution of dwelling time is centered around the AP; this is always the case for pseudo-normal distributions of dwelling time.

Accordingly, they proposed a functional definition for these movements; any saccade occurring during fixation was called “fixational saccades” (even saccades as large as 2°) and included in their set of fixational eye movements. It is worth to mention that in clinical neurology a further classification has been made between microsaccades and saccadic intrusions (as described in Abadi and Gowen 2004).

Fixational saccades have been found in different species, mostly in those having a retinal area of higher receptors’ density (Martinez-Conde and Macknik 2008). In particular, it has been found that non-human primates perform fixational tasks in a way very similar to human

subjects (Steinman et al. 1973). The rate of fixational saccades is also comparable in humans and monkeys, but monkeys have been found to produce slightly larger microsaccades (Skavenski et al. 1975). A comparative study further observed that fixational saccades in monkeys move mostly vertically, while in human the preferred direction is horizontal, and that fixation in monkeys seems to be more affected by external factors, like the type of the task (Snodderly and Kurtz 1985).

2.2.2 Factors modulating fixational eye movements

Each individual has its own way of fixating objects (Møller et al. 2002; St Cyr and Fender 1969). Excluding pathology impairing gaze holding, reported measurements of fixational behaviors display a great variability, due both to endogenous (experimental condition) and exogenous (recording and analytical technique) factors. Because of fast and slow movements occurring during fixation, the retina dwells over a rather extended visual area (fig 2.3C).

Several factors have been found to modulate the frequency, the direction and the amplitude of fixational eye movements, therefore modifying the way of looking at an object and, possibly, the way of perceiving it. Because fixational saccades are responsible for the biggest displacements, they stimulated a greater interest on their origin and purpose than other fixational eye movements. Those elements which can affect fixation will be now shortly described.

The term *visual* fixation itself underline the important relation existing between the optical properties of the viewed object and the pattern of eye movements used to look at it. The presence of a target is indeed fundamental to hold the gaze in a certain position. When fixation is attempted in complete darkness without the aid of visual target, the eyes quickly drift from the initial position (Cornsweet 1956; Nachmias 1961). Unintended small saccades are

produced also when attempting fixation without visual feedback, and they have on average a bigger amplitude (Ditchburn and Ginsborg 1953; Sansbury et al. 1973; Skavenski and Steinman 1970; Steinman et al. 1967). Also the smallest voluntary saccades without a visual target are on average 3-4 times bigger (Haddad and Steinman 1973). These observations hint the important influence of the target on the system controlling small eye movements. However, until 1965 the intrinsic influence of a visual target on fixational eye movements was not clear. On the one hand, early studies did not find any significant change in microsaccades features related to the shape of target (Ratliff and Riggs 1950), or its color (Barlow 1952), nor by the structure of the background (Ditchburn and Ginsborg 1953). On the other hand, Fender (1955) reported different mean positions of the eye while fixating target of different colors and Gaarder (1960) showed an influence of the visual background on saccade directions. To shed light on the matter, Steinman (1965) manipulated the size, the color and the luminance of the target, finding small (4minarc) but significant changes in mean eye positions with the different stimuli. In addition he reported a reduction of saccades frequency with bigger target (a result later replicated by Steinman et al. 1967), and an overall improvement of fixation stability with higher luminance. He proposed the bivariate Gaussian distribution as a statistical means to describe the stability of fixation (a methods that then became very popular), and observed that target size influenced stability only marginally in the subject he studied while he himself was able to keep the eye stable with different target size. Later on, Rattle (1969), extending the range of target diameters, proposed that a peak of eye instability is obtainable when the target size is comparable with the size of the fovea. St Cyr and Fender (1969) qualitatively described the profound effect of the target conformation on the direction of eye movements, whereas Kaufman and Richards (1969), testing naïve subjects looking at target with different shapes, found a “re-centering effect”. Sansbury et al. (1973) analyzed the ability of keeping the eye still using peripheral target, and saw that the more eccentric the targets were, the worse the fixation stability was. More recently, Hamstra and colleagues (2001) also showed that the

width of the bars they were using as a target had an influence on the stability of fixation. However there have been also other contrasting results. For instance Murphy and coworkers (1974) trained subjects to fixate target of different shape, and found that after a short training subjects were able to dissociate eye movement pattern from the retinal stimulus. Epelboim and Kowler (1993) replicated Sansbury's experiment, finding no effect on the bivariate area due to target eccentricity or disposition. These discrepancies are due to the ability of humans to voluntarily control (and suppress) fixational saccades; simple verbal instructions ("fixate" or "hold your eyes still") can change the behaviour of the subject looking at the target (Steinman et al. 1967). Such an ability raised doubts on a possible function of microsaccades.

2.2.3 Origin and purpose of microsaccades

We are unaware of moving our eyes when we fixate the object. For this reason, microsaccades are often thought to be involuntary. However, it can be pointed out that there are a number of actions that we do unwarily and that have different grades of voluntariness, e.g. walking, scratching, looking around or breathing. Microsaccades rate can be voluntarily decreased, but the suppression for long period requires training in this special task (Steinman et al. 1973). Do these movements have a purpose? This question raised a lively debate that reached its apex at the end of the seventies (Ditchburn 1980; Ditchburn and Foley-Fisher 1979; Kowler and Steinman 1980), and the controversy is still not resolved (Collewyn and Kowler 2008). Several hypotheses have been suggested on the role of these miniature eye movements, and many methods and evidences have been proposed to support or cast doubt upon them.

One of the first hypothesis, and still one of the most popular, is that microsaccades avoid retinal fatigue and improve visibility. This hypothesis was supported by studies of retinal stabilization (Ditchburn and Ginsborg 1952; Ratliff 1952; Riggs et al. 1953; Yarbus 1967).

With particular techniques, it was possible to avoid relative movements between the target and the retina; the absence of movement causes adaptation of retinal photoreceptors, inducing in short time a loss of visibility. More generally, several evidence supported the idea that microsaccades could improve visibility. Clowes (1961) showed that saccades suppression could lead to color confusion, and that saccades helps in contrast discrimination tasks (Clowes 1962). Steinman found an inverse relation between target size and saccades rate, suggesting that when the target is smaller, more saccades are required to see it (Steinman 1965 ; Steinman et al. 1967). However, such a broad role for microsaccades was already questioned by Cornsweet (1956), who used a special technique to show that changes in target visibility were not correlated with changes in the frequency of fixational saccades. It has also been shown that microsaccade rate actually decreased during tasks where high visual acuity was required (Bridgeman and Palca 1980; Winterson and Collewijn 1976). Evidences collected against this hypothesis (Steinman et al. 1973) pushed scientists to suggest that microsaccades were just a laboratory artifact and that, in natural conditions, head movements were sufficient to counteract visual fading (Skavenski et al. 1979). Neurophysiological experiments reopened the question (Martinez-Conde et al. 2004), and recent studies found an important role of microsaccades in preventing the fading of a peripheral stimulus (Morisita and Yagi 2001). More specifically it has been shown that microsaccades contrast the so called “Troxler effect”, consisting in the disappearance of peripheral visual objects while viewing a central target (Martinez-Conde et al. 2006). It has also been demonstrated an important function of microsaccades in detecting fine details (Rucci et al. 2007). The dependence on the visual context and the difficulty to distinguish the specific contribution of saccadic and slow movements are among the factors making it hard to understand the role of fixational eye movements in vision.

Another role scientists acknowledged to microsaccade was to keep the eyes on the target. It was initially observed that saccades starting from most eccentric position moved the eye back

to the centre (Ditchburn and Ginsborg 1953). In his influential paper, Cornsweet (1956) showed that target eccentricity was a clear triggering factor for saccades. He then postulated that microsaccades corrected for retinal eccentricity caused by a noisy control of eye position, represented by drifts. Based on his results, Cornsweet proposed the existence of a fixation system controlling the direction, the amplitude and the triggering of microsaccades. Even though the corrective nature of fixational saccades was then broadly accepted (Carpenter 1988; Collewijn and Kowler 2008), the idea that microsaccades were necessary to keep the eyes onto a target to counteract the error-producing action of drifts was successively downsized. First, it was shown that drifts, especially along some directions, could be as corrective as microsaccades (Nachmias 1959). Then, it was demonstrated that even if microsaccades move generally towards the target, the global effect of the gaze shift was often to increase target eccentricity (the absolute distance to the target), instead of reducing it (Boyce 1967; St Cyr and Fender 1969), and that after larger saccades, drifts brought back the eye to the mean position (Barlow 1952). Finally, it was proved that in many people drifts were actually more effective to maintain the gaze in a certain position, while saccades were increasing the instability of fixation (Steinman et al. 1973). This results supported the idea of a slow control of fixation (Kowler 1991), contributing to the uncertainty on the role of fixational saccades, in particular to the smallest ones (Collewijn and Kowler 2008). Many scientists postulated the existence of a dead zone, i.e. a part of the retina where photoreceptors were equally effective to drive saccades (Bennet-Clark 1964; Ditchburn and Ginsborg 1953). Such an area could be inferred from the direction of microsaccades (because coinciding to the position of minimal error, as suggested by Cornsweet in his 1956 paper), or from testing directly the smallest detectable target jump that subjects could correctly follow (Timberlake et al. 1972; Wyman and Steinman 1973). Results were not clear enough to prove and define such an area. More recently, it has been proposed that only some saccades can be effective for precise fixation (Hamstra et al. 2001), and that previous discrepancy on the corrective nature of microsaccades could arise from

considering together fixational saccades having actually different roles (Engbert and Kliegl 2004).

The last factor modulating the execution of saccades during fixation is the mental state. Already Barlow (1952) noticed that while doing mental activity (counting), the rate of microsaccades dropped. The same drop is observed in high acuity tasks, like threading a needle or shooting with a rifle (Winters and Collewijn 1976). This phenomenon could be interpreted as a way to avoid a possible effect of visual suppression (Collewijn and Kowler 2008). Alternatively, if microsaccades are nothing else than “busy work” (Steinman et al. 1973), it can be simply viewed as the consequence of a reduced availability of “brain resource”. The possibility of linking fixational eye movements with mind states boosted research in this field in the last years. In particular, it has been argued that through the analysis of fixational saccade it would be possible to reveal the covert shifts of attention, i.e. attentional shifts that are not accompanied by eye movements (Engbert and Kliegl 2003; Gowen et al. 2007; Hafed and Clark 2002).

To conclude, the exact role of fixational saccades is still under debate. This uncertainty might be due to the fact that only few studies have tested the neurological substrate of these movements. The fact that microsaccades modulate the activity in several areas of the visual brain (Martinez-Conde et al. 2009), pushed scientists to look again to a specific role. If fixational eye movements helped somehow vision, it could be useful to understand if and how they are controlled. It is for this reason that in this thesis I will focus on the possible role in visual fixation of subcortical structures that are intimately involved in the reflexive execution and control of ocular movements.

2.3 Neuronal substrate for the control of eye movements during fixation

In the previous paragraph visual fixation was defined as the observed interplay between slow drifts and small saccades occurring when a subject is looking at a target. The two movements both contribute to hold gaze direction. However this task can be optimally executed without microsaccades, thus their role is still unclear. Here the neuronal substrate of gaze holding and saccades will be reviewed. Because fixational saccades are unwillingly and uncontrollably generated, we will only deal with the control of reflexive saccades.

2.3.1 Brainstem control of eye position

Eye movements are the result of the synergistic action of three pairs of extra-ocular muscles: The medial and lateral rectus (MR and LR, respectively) for horizontal movements and the inferior and superior rectus (IR and SR, respectively) and the two oblique (SO, superior oblique and IO, inferior oblique) for vertical movements (fig.2.4). These muscles are innervated by motor neurons located in the brainstem (in the III, IV and VI cranial nerve nuclei, respectively named oculomotor, trochlear and abducens).

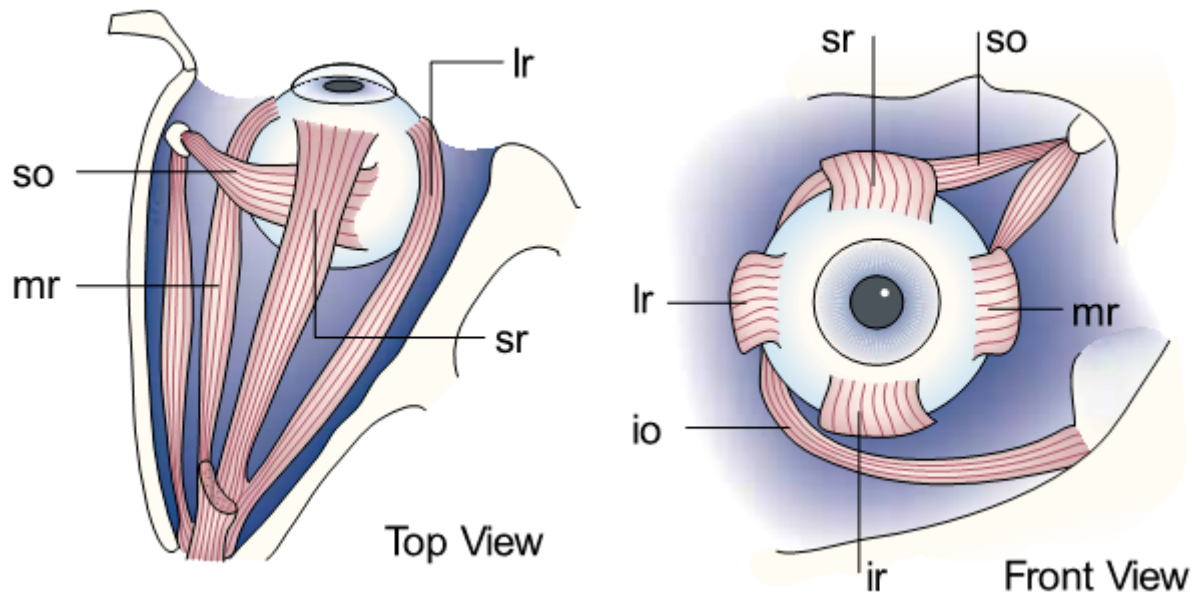

Figure 2.4: Extra-ocular muscles.

All eye movements result from the synergistic action of three pairs of muscles: The medial and lateral rectus and the inferior and superior rectus (mr, lr, ir, sr, respectively) and the inferior and superior oblique (io and so). From Sparks 2002

Because they are active during all the different kinds of eye movements, the oculomotor neurons were in the past viewed as a “final common pathway” of the oculomotor system. Most recent studies have shown that the oculomotor organization is slightly more complex: Each extra-ocular muscles participate to all movements in different directions (Crawford and Vilis 1992) and neurons within the oculomotor nuclei can be further subdivided (Büttner-Ennever and Horn 2002). The oculomotor neurons activity is proportional to the position of the eye: Each motoneurons display a specific firing rate for any eye position, suggesting a gradual recruitment of muscular fibers to maintain the eye in lateral positions (Sparks 2002). Saccades are accompanied by a burst of spikes (Fuchs and Luschei 1971; Schiller 1970; Sylvestre and Cullen 1999) i.e., an abrupt increase of the firing rate (pulse) followed by a slower decrease (slide) to the new tonic rate (step) (Fuchs et al. 1985). This pulse-slide-step pattern is tightly connected with the physical properties of the plant, and was indeed theorized even before neuronal recordings were made in behaving monkeys (Robinson 1964).

Oculomotor action is driven by neurons (called pre-motor) located in different regions of the brainstem (see Büttner and Büttner-Ennever 2006 or Moschovakis et al. 1996 for reviews). In particular, agonistic motoneurons are activated by a population of excitatory burst neurons (EBNs), located in the ipsilateral Paramedian Pontine Reticular Formation (PPRF, Luschei and Fuchs 1972) and in the rostral interstitial nucleus of the Medial Longitudinal Fasciculus (RIMLF, Büttner et al. 1977; Büttner-Ennever and Büttner 1978). The first group of neurons makes monosynaptic connection with the VI (abducens) nucleus, thus providing the pulse force for horizontal saccades (Cohen and Komatsuzaki 1972; Sparks et al. 2002). The VI nucleus also houses internuclear neurons, providing the pulse signal to the contralateral motor neurons required for a conjugate movement. The amplitude, duration and velocity of saccades are respectively related to the number of spikes, duration of the burst and peak firing rate (Sparks 2002); this relation holds for saccades of all size, even in the range of microsaccades (Van Gisbergen et al. 1981). EBNs project also caudally towards the medullary Reticular Formation (medRF), where inhibitory burst neurons (IBN) are located. IBN axons terminate in the contralateral abducens nucleus, thus contributing to the relaxation of the antagonist muscle (Scudder et al. 1988). Unlike the horizontal, the vertical saccades generator is bilaterally organized; EBNs active during upward and downward movement are intermingled in both the right and left RIMLF. Also the activity of these neurons relates to the saccade velocity (duration and amplitude). The activity of both horizontal and vertical EBNs is inhibited by neurons located in the Raphe Interpositus Nucleus (RIP); this midline structure contains neurons pausing for saccades in all directions (Büttner-Ennever et al. 1988), and sending their inhibitory projections to the PPRF and to the RIMLF (Curthoys et al. 1984). These omni-pause neurons (OPN) act as a gate for saccadic movements, and are thought to play a role in the coordination of oblique saccades (Sparks 2002). If EBNs provide the velocity signal necessary to overcome viscous forces and move the eye, other neurons must provide the drive to the tonic activity of motoneurons, necessary to hold the gaze in eccentric positions against elastic forces that would bring the globe of the eye back to the central position. Neurons displaying a tonic activity

related to the horizontal position are found in the Medial Vestibular Nucleus (MVN) and in the Nucleus Prepositus Hypoglossi (NPH, see Catz and Thier 2007). It has been proposed that these neurons act like a “neural integrator” (NI), providing a positional signal integrating the velocity signal coming from the EBNs. Indeed, lesion study in the NPH demonstrated gaze holding impairment (Kaneko 1997). A similar role for the vertical position signal has been attributed to neurons in the Interstitial Nucleus of Cajal (NIC, Crawford et al. 1991).

Up to this point, it has been discussed which neurons provide the command to move and keep the eye stable; now, the process by which a sensory stimulus is transformed in this motor command will be briefly reviewed. Reflexive saccades are eye movements generated in response to an external stimulus (auditory, visual, tactile). In the case of a visual stimulus, the target stimulates photosensible receptors in the retina. The ganglion cell of the retina send their output through the optic nerve; most of the fibers target the Lateral Geniculate Nucleus (LGN), while only a small part directly projects to the Superior Colliculus (SC), a brainstem structure which is thought to be central in the sensory motor transformation process (May 2006). The cortical visual pathway starts from the LGN that in turn relays visual information in the striate cortex (also called primary visual cortex, V1, located in the occipital lobe). From V1 the visual information is sent to adjacent cortical areas (commonly known as V2, V3, V4 and V5) through two different pathways (for a review, see Schiller 1986). Microsaccades were found to modulate the activity in the LGN (Martinez-Conde et al. 2002), in V1 (Kagan et al. 2008; Martinez-Conde et al. 2000; Snodderly et al. 2001) and in the Medial Temporal cortex (MT, that is V5) (Bair and O'Keefe 1998), a region housing neurons known to be sensitive to the speed and direction of the target (Maunsell and Van Essen 1983). MT and the adjacent MST (medial superior temporal cortex) are involved in smooth pursuit eye movements, and thus might play a role in the control of the slow fixational movements. The cortical control of eye movements is then distributed over many cortical areas organized in two parallel systems, anatomically located in the frontal and parietal cortex (Büttner and Büttner-Ennever 2006; Leigh and Zee 2006). As depicted in fig.2.5, all the cortical saccade-related structures ultimately

project to the Superior Colliculus (SC) and to the pontine nuclei (in particular the Nucleus Reticularis Tegmenta Pontis, NRTP, and the Dorsolateral Pontine Nucleus, DLPN, Selemon and Goldman-Rakic 1988). In particular the SC appears to modulate all the visual information coming from the cortex: Although its ablation in non human primates has a surprisingly mild (if compared with other species) effects on saccade generation when not combined with lesion in the Frontal Eye Field (Schiller et al. 1980), it prevents the possibility of eliciting saccades by FEF microstimulation (Hanes and Wurtz 2001). Histology reveals that the SC is a laminated structure composed by seven layers, functionally subdivided into superficial and deeper layers (King 2004). The superficial layers represent primarily visual information, gathered directly from the retina and indirectly from the thalamus and visual cortex (Johnston and Everling 2008; May 2006). The deeper layers receive multisensory information. Collecting input from the cortex, from the superficial collicular layers and from other subcortical areas, the deeper layers build overlapping maps representing the sensory world. While the layers located dorsally appear to have a purely sensory role, the intermediate and deeper layers are viewed as combining sensory and motor functions. Neurons located in these layers project toward the premotor areas involved in the generation of eye and head movements (May 2006; Sparks 2002); therefore, their activity was thoroughly investigated to understand how visual input are transformed into motor commands for rapidly and accurately shift gaze toward a target. Early experiments showed that the intermediate and deeper layers of the SC form a motor map of eye movements (Mohler and Wurtz 1976; Robinson 1972; Sparks et al. 1976). Microstimulation of the SC evokes contralateral saccades, whose amplitude and direction depend on the site of the stimulation; the same cells burst before saccades of the corresponding size and direction.

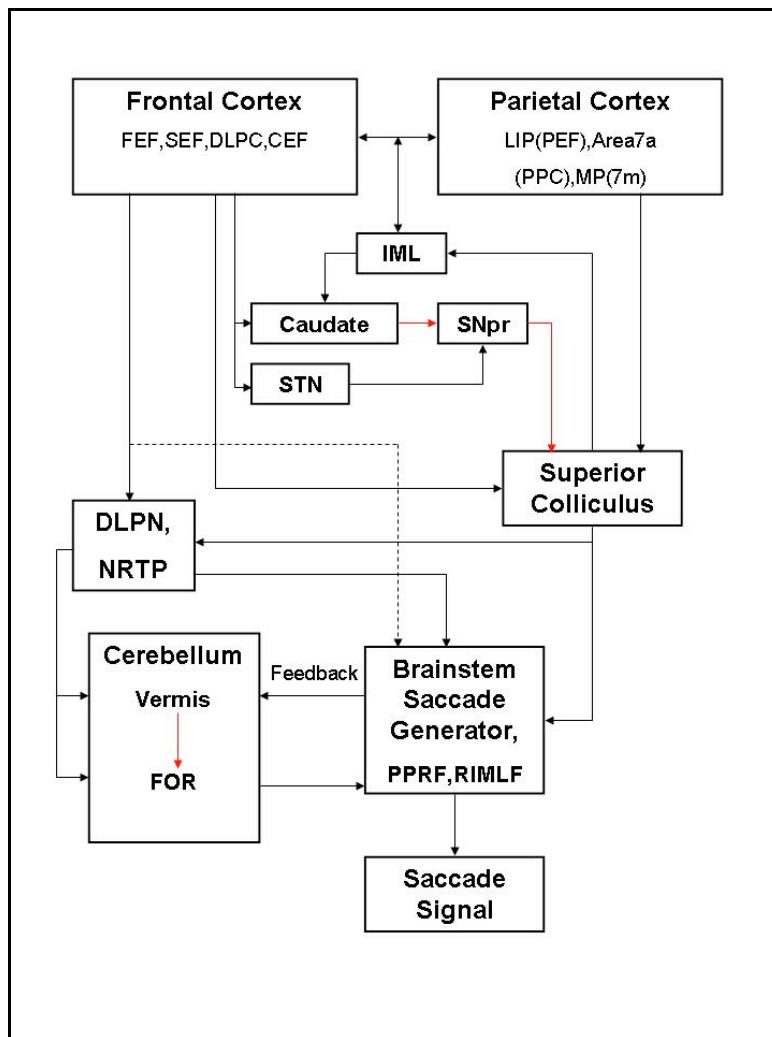

Figure 2.5: Major structures involved in saccade control.

In this thesis I will deal with subcortical structures involved in the control of eye movements. This figure gives a more complete view on how the brain is organized for the control of this very simple sensory-motor task.

It is interesting to observe that all the cortical activity is gated by the Superior Colliculus. The only direct pathway of the cortical area to the brainstem is via two pontine structures, the dorsolateral pontine nucleus (DLNP) and the nucleus reticularis tegementa pontis (NRTP). In the parietal cortex, the name of the identified area in the monkeys are associated with the correspondent area in humans (in brackets). Downstream, brainstem saccadic centers provide the signals that motoneurons use to drive the eyes. Red arrows indicate inhibitory connections.

A list of the abbreviations used in this figure can be found in the Appendix. The figure is adapted from Leigh and Zee 2006 and Büttner and Büttner-Ennever 2006; those chapters provide an extend review of the oculomotor system.

Differently from premotor neurons, there is no link between the activity of collicular neurons and the characteristic of the saccade. Instead, movements are topographically arranged, with saccades of increasing size represented from the rostral to the caudal part of the SC and the direction encoded along the medio-lateral axis (lateral representing upward saccades). More recent studies have shown

that the SC encodes gaze shifts rather than eye movements (Freedman and Sparks 1997), that the neural activity might encode the position of the goal relative to the fovea rather than the specific movement required to reach this position (Krauzlis 2005) and that the rostral end of the two SC is involved in the generation of microsaccades (Hafed et al. 2009). Despite the number of studies, several issues remain more or less unclear or under debate: How pure vertical saccades are encoded, how head and eye movements are coordinated and the exact mechanisms by which a polar topographic representation of the goal location is transformed in a Cartesian, temporal based command of eye movements (Leigh et al. 1997).

2.3.2 The role of the oculomotor cerebellum

Neurophysiological and clinical studies have shown that even if the cerebellum is not directly involved in movement generation, it plays an important role in making them more accurate, smoother and faster. Several cerebellar areas are involved in different oculomotor behaviours, including saccades, slow movements and gaze holding (Robinson and Fuchs 2001).

The most important cerebellar structures involved in saccadic movements are located in the posterior Vermis (VI and VII lobuli) and in its target area in the caudal part of the Fastigial Nucleus (cFN), named the Oculomotor Vermis (OV) and the Fastigial Oculomotor Region (FOR), respectively (Noda and Fujikado 1987; Yamada and Noda 1987). Anatomically, the OV receives visual and oculomotor information from the NRTP (Brodal 1980; Yamada and Noda 1987), a nucleus that is targeted by saccade-related neurons located both in the SC (Scudder et al. 1996) and in the FEF (Brodal 1980). Electrical stimulation of the OV leads to ipsiversive saccades with very low current (10 μ A) and short latencies (25ms); the amplitude of the evoked saccades depends upon the initial eye position (Fujikado and Noda 1987; Ron and Robinson 1973). Position-dependent impairments were also observed in early lesional studies

(Ritchie 1976), leading to hypothesize a role of the OV in compensating viscoelastic forces acting on the eye. This hypothesis did not find support in single unit recordings (Thier et al. 2002), which, instead, reported a correlation between the activity of the population of OV neurons and the temporal termination of saccades (Thier et al. 2000). The activity of the OV is mediated by the FOR, since all cortical neurons send their inhibitory projection toward this small fastigial area (Yamada and Noda 1987). Accordingly, both microstimulation and temporary inactivation lead to mirrored effects when performed in the OV (Noda and Fujikado 1987; Sato and Noda 1992) and in the FOR (Goffart et al. 2004; Quinet and Goffart 2009).

Although the primary input of the FOR is the inhibitory action of OV Purkinje Cell (Yamada and Noda 1987), this region also receives excitatory inputs from collateral axons of the same brainstem neurons targeting the OV (Gonzalo-Ruiz and Leichnetz 1990; Noda et al. 1990) and from neurons in the inferior olive (IO, Noda et al. 1990). FOR neurons send their axons to most of the oculomotor regions in the brainstem; in particular, connections with EBNs and IBNs in the contralateral PPRF and medRF have been found. Double labeling techniques also showed connections to the Mesencephalic Reticular Formation (MRF), including the RIMLF where vertical premotor neurons are located, and to the OPN in the NIC (Noda et al. 1990). The existence of cerebellotectal and cerebellotalamic pathways has also been shown (Kato et al. 2000; May et al. 1990; Noda et al. 1990; Scudder et al. 2002).

Maybe because its discovery is quite recent or because the wide spreading of its efferences, the exact role of the FOR is still unclear. Like for the OV, early lesional studies showed positional-dependent impairments, pushing the idea of an involvement of the FOR in compensating viscoelastic forces in the orbit (Vilis and Hore 1981); even though some other evidence of position-dependency were found (Murakami et al. 1991), successive studies failed to find decisive proof in favor of this hypothesis (Kleine et al. 2003; Ohtsuka et al. 1994; Robinson et al. 1993). Single unit recording studies in this region agreed on two main considerations; the

first is that almost every saccade-related neurons display a tonic activity and a burst of activity occurring earlier during contralateral than during ipsilateral saccades. Secondly, all the authors agreed on the large variability both in the single unit activity and across the neuronal population (Fuchs et al. 1993; Helmchen et al. 1994; Kleine et al. 2003; Ohtsuka and Noda 1991). However, there is still little agreement on what fastigial activity encode, and notably whether it is mostly contributing in determining saccade timing (Ohtsuka and Noda 1991), acceleration (Fuchs et al. 1993; Helmchen et al. 1994), velocity or eye position (Kleine et al. 2003).

Unilateral temporary inactivation by means of local muscimol injection provided further insight on the role of the FOR. In particular, after the unilateral FOR inactivation, the horizontal component of visually guided saccades is hypermetric (too large) for ipsilesional saccades and hypometric (too small) for contralesional ones (fig.2.6). In addition vertical saccades bend toward the inactivated side; the magnitude of the horizontal deviation increases with saccade size (Goffart et al. 2004; Iwamoto and Yoshida 2002; Robinson et al. 1993). More in detail, contralesional hypometria is associated with a reduced peak velocity, while ipsilesional hypermetria is the consequence of an abnormal length of the deceleration phase combined with a higher peak velocity (Goffart et al. 2004; Quinet and Goffart 2005). The unbalanced fastigial activity also impairs the ability to fixate small targets, an impairment know as “fixation offset”. When compared to the positions taken before inactivation, the gaze is directed toward positions which are shifted by approximately 1° toward the side of the injection, whether the head is restrained (Goffart et al. 2004; Robinson et al. 1993) or unrestrained (Quinet and Goffart 2005). Several other area of the cerebellum, including the posterior interpositus nucleus, the basal interstitial nucleus and the lateral nucleus house saccade-relate neurons, and might be involved in saccade control (see for a review Robinson and Fuchs 2001). Their precise contribution is however still unknown.

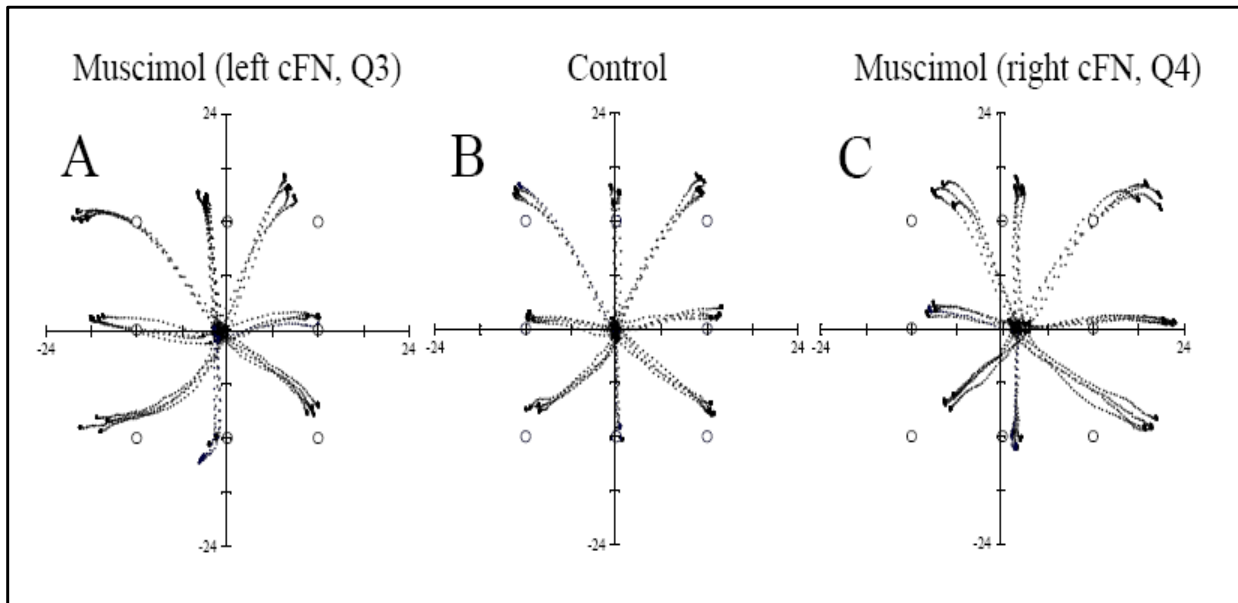

Figure 2.6: Effects of unilateral FOR inactivation on visually guided saccades.

Trajectories of saccades starting from straight ahead and directed to peripheral targets ($\pm 12^\circ$ on the horizontal and vertical meridian) before (panel B) and after the unilateral injection of muscimol in the left (panel A) and right FOR (panel C) are displayed. The horizontal component of ipsiversive movements is larger than in the control condition, while in contralesional movements it is always smaller. Note also that after the lesion, the starting position is shifted (about 1°) towards the site of the injection. Figure from Goffart et al. 2004

The cerebellum is also involved in the control of slow movements. Two distinct regions appear to be involved in slow movement control, notably the medial posterior cerebellum (OV+FN) and the flocculus/ventral paraflocculus (Robinson and Fuchs 2001). Besides its participation in slow eye movements, the flocculus/ventral paraflocculus play also a role in horizontal and vertical gaze holding (Fukushima et al. 1992). In figure 2.7 the subcortical control of eye movements is summarized.

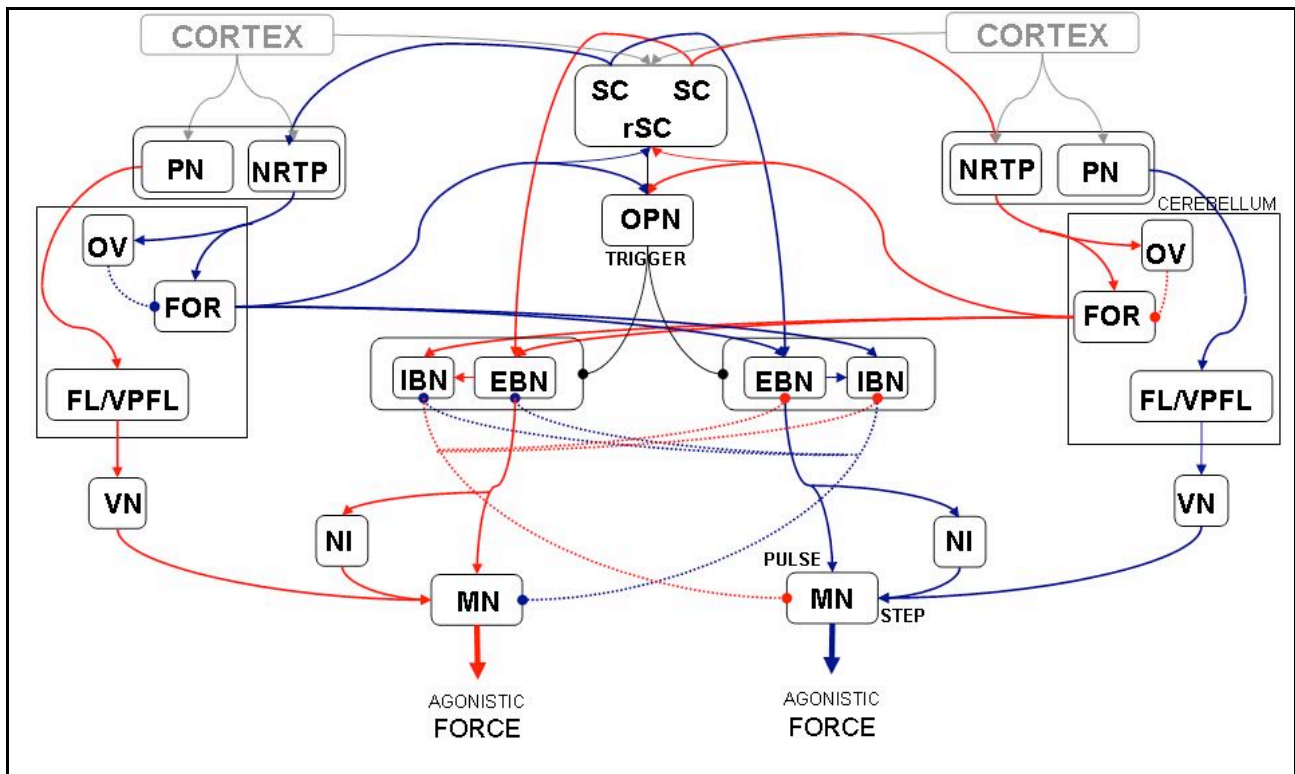

Figure 2.7: Major subcortical structures involved in the control of eye movements.

This figure details the subcortical contribution to eye movements that is only roughly indicated in the more general figure 2.5. The different colors differentiate the neuronal path activated for rightward (blue) and leftward (red) movements. Inhibitory connections are indicated by dotted lines and circular endings of the line, while excitatory connections are represented with full lines terminating with an arrow. Of particular interest are the cerebellar connections towards the EBNs in the PPRF: Their activity results from the simultaneous excitatory action of the contralateral FOR and the inhibition of IBNs, that are in turn activated by the ipsilateral FOR. Unilateral inactivation impairs this balanced activity, causing the effects depicted in figure 2.6.

3. Methods

The experiments described in this thesis were aimed at investigating the role of the Fastigial Oculomotor Region in visual fixation by means of temporary unilateral inactivation of fastigial neurons. Conclusions are made comparing the foveation behaviour before and after the injection of muscimol, a GABA agonist, in the caudal part of the fastigial nucleus.

Two adult Rhesus monkeys (monkey E, 5.7kg and monkey B, 8.8kg) were used in these experiments. Monkeys were prepared for head restrained eye coil measurements, neuronal recording, microstimulation and muscimol injection as described in Quinet and Goffart 2005. All surgical procedures and experiments were performed in accordance with the guidelines from the French Ministry of Agriculture (87/848) and from the European Community (86/609/EEC).

Experimental set-up: Animals were seated in a primate chair with their head restrained and facing the centre of a spherical LED board. Red LEDs (visual angle 0.16° , luminance= 10.7cd/m^2) were placed equally spaced (2° horizontally and vertically) so to cover 80° of the visual space. The board was located at a viewing distance of 110 cm, in a dimly illuminated environment (luminance= 0.05cd/m^2). Gaze position was measured with a phase detection system (CNC engineering, 3-ft-diam coil frame). The horizontal and vertical eye position signals were sampled with the search coil technique at 500Hz (SD of the noise = 0.004° and 0.006° on the horizontal and vertical position, respectively).

Behavioral task (fig. 3.1). The animals were trained to direct their gaze toward a central LED target after a brief tone warned the onset of each trial. The task required the monkeys to maintain their

gaze within a spatial window (radius of 3° during the control, pre-injection sessions) around the central LED for a randomly variable duration (1, 1.5 or 2 sec).

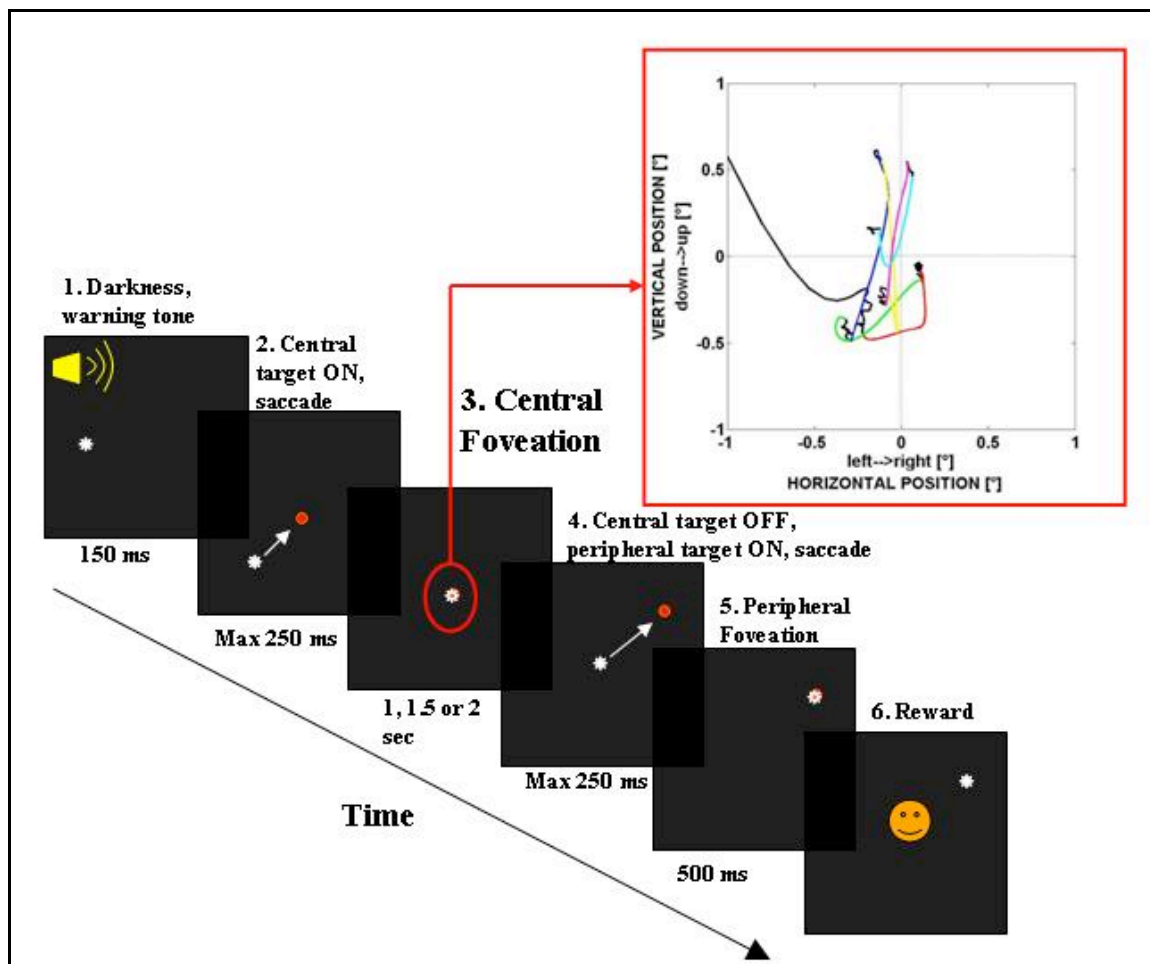

Figure 3.1: Behavioral task.

Black panels sketch the different steps of a single trial. (1) After an acoustic warning signal, the central target (red dot) was set. The monkey had to move the eye (white star) towards the target within a temporal window of 250ms (2). (3) The animal was then required to hold the gaze on the central target for a variable amount of time. Eye movements during the central foveation were recorded and analyzed (red square box). (4) After the time of central fixation, the central target was replaced with a peripheral one; the monkey was required to shift the gaze toward the peripheral target and hold the position for 500ms (5). After successful trials, a drop of water was delivered for rewarding the animal.

After this fixation interval, the central target was extinguished and a second LED target was presented at pseudo-random locations in the periphery. A reward was delivered after the monkey performed a saccade toward the peripheral target. In this study only the data regarding the foveation

of the central target were used. After unilateral FOR inactivation, because of the muscimol-induced dysmetria, the first movements towards the target frequently terminated outside the acceptance window around the central target and several saccades were often required to reach it. In order to avoid motivational drop in the animal, the radius of the window was increased after the injection (radius of 10° around the central target). Before each muscimol injection session (six injections in both monkeys) 2 to 5 sessions were performed to gather control data.

Localization of the FOR and muscimol injection. Before the injection of muscimol, the location of the saccade-related region of the fastigial nucleus was identified after several experimental sessions using electrophysiological recording and electrical microstimulation in the head-restrained and unrestrained conditions, as described in detail elsewhere (Quinet and Goffart 2007; Quinet and Goffart 2009). For the muscimol injections, a thin cannula (outer diameter: 230 µm, beveled tip) and polyethylene tubing were filled with a solution of muscimol (2µg/µl) and connected to a Hamilton syringe. The cannula was lowered to the location previously identified as the FOR. After a delay of about 3 minutes, a small amount of the solution (0.5-1.1µl) was injected by small pulses (0.1µl every 2-3 minutes), until the muscimol-induced effect on saccades became clear. Recordings started after the withdrawal of the cannula (2-5 minutes after the last pulse). The successful inactivation of the FOR was confirmed by its effects on visually-guided saccades (ipsilesional hypermetria, contralesional hypometria and ipsipulsion of vertical saccades (Goffart et al. 2004; Robinson et al. 1993). Moreover, histological analysis performed in one animal (monkey B) confirmed that the injections were performed in the medial cerebellum (see Fig. 2 in Quinet and Goffart 2007).

3.1 *Eye movement analysis*

The horizontal and vertical positions acquired by means of the eye coil technique were manually calibrated at the beginning of each experimental session. This calibration was further refined by a second off-line automated calibration which consisted of averaging eye positions during the last 750 ms of the fixation interval (before the fixation target was turned off). This Averaged Position (AP) will be used as reference direction in the analysis. The AP for post-injection data was computed from trials made before lowering the cannula for muscimol injection, that is in the same condition in which data were gathered after fastigial inactivation. Because of the size of fixational eye movements ($0.1^\circ \div 1^\circ$), it is important to consider the intrinsic noise of the measuring system in order to avoid to flag noisy fluctuations as saccades. A digital filter can be applied to improve the performance of the analysis. The position signal was filtered with a low-pass zero-phase Gaussian filter (3dB attenuation at 30 Hz, 30/3dB shape factor = 3.2); eye velocity (SD of noise = $0.37^\circ/\text{sec}$) and acceleration (SD of noise = $99.6^\circ/\text{sec}^2$) were derived from the eye position signals. Saccades were automatically detected when the velocity (horizontal or vertical) and acceleration exceeded a threshold of $5^\circ/\text{sec}$ and $1500^\circ/\text{sec}^2$, respectively. These threshold values ensure a probability of wrongly detected saccades lower than 0,1%. A second velocity threshold was used to define the beginning and the end of the saccadic movement. Saccade onset was defined when either the horizontal or vertical velocity exceeded $3^\circ/\text{sec}$. Saccade end was labeled when both horizontal and vertical velocities fell below the threshold for two consecutive samples.

Saccades used to reach the target and very large (more than 5°) or extremely curved movements were excluded from the analysis. Strongly curved movements were removed to avoid including), the so called double saccadic pulses (Abadi and Gowen 2004) in the group of normal straight saccades (the large majority: 92.5% and 95% of the total saccadic movements for monkey B and E, respectively. Double saccadic pulses are movements shifting rapidly the line of sight away and,

without pause, back near to the initial position; these movements were excluded because they may have a different etiology from that of normal saccades (Gowen et al. 2005). Saccades were considered as curved when the length of the arc formed by the movement's trajectory exceeded the length one of the cord by 0.5° or more. The 0.5° threshold was chosen after examination of the relation between saccade length and amplitude. It was restrictive enough to remove all saccades lying out of the main sequence. It has been avoided to use severe constraints on the amplitude to analyze the monkeys' fixational behavior. This study is therefore not limited to microsaccades with amplitude <20 minarc (Collewyn and Kowler 2008) but also concerns fixational saccades, as defined as any saccadic movement occurring during fixation (Engbert and Kliegl 2003; Hafed and Clark 2002). Table 1 indicates the average rejection rate in each monkey, and the median amplitude of the fixational movements used for the analysis.

	MONKEY B		MONKEY E	
	control (N=6)	muscimol (N=6)	control (N=6)	muscimol (N=6)
Detected saccades	4110 \pm 2010	1410 \pm 640	1770 \pm 400	950 \pm 600
Used saccades	3450 \pm 1700	1110 \pm 460	1330 \pm 260	750 \pm 480
Median amplitude of used saccades	0.88 \pm 0.15 $^\circ$	1.14 \pm 0.2 $^\circ$	0.58 \pm 0.04 $^\circ$	0.84 \pm 0.3 $^\circ$

Table 1: Average number and amplitude of fixational saccades used in this study.

After detecting saccades, some of them were excluded from the study because they were curved or executed too shortly after the onset of the fixation target (see text for details). The average median amplitude of saccades recorded during the control experiments is in agreement with previously reported data. Note the larger size of saccades after fastigial oculomotor region (FOR) inactivation, reflecting the impaired fixation. The average median values remain well below the size of the area of acceptance (radius = 10°), indicating that the monkeys were actually attempting fixation.

3.2 Measuring fixation

In this work the spatial distribution of dwelling times will be used in order to describe the visual area explored during fixation (see *Calculation of the spatial distribution of dwell times*). However, I propose an alternative method to describe fixation (see *Analysis of the direction of fixational saccades*), in order to identify the position of balance independently from the control of trigger and magnitude of fixational saccades. This method is inspired by the work of Cornsweet (1956), who indicated as “on-target” the position from where eye movements are “equally likely to move to the left or to the right”. This way of describing fixation rely only on the corrective nature of fixational eye movements, i.e. the observed tendency of saccades to move towards the visual target (Carpenter 1988; Cornsweet 1956; Nachmias 1959; St Cyr and Fender 1969). To test whether the well acknowledged corrective nature of fixational saccades holds after the temporary inactivation of FOR neurons, the relationship between the initial position of the eye and the direction and magnitude of a saccadic movement has been analyzed (see *Analysis of the amplitude of fixational saccades*).

3.2.1 Calculation of the spatial distribution of dwell times

To compute where the eyes dwell longer, a modified version of the methods described by Cummings et al. (1985) was adopted (fig. 3.2). The amount of time the eyes dwelled within a small square window (0.2° side) was computed summing the intersaccadic interval (time between two successive saccades) of all saccades landed within the area during a complete experimental session. This calculation was made in an iterative manner by moving the window by steps of 0.05° .

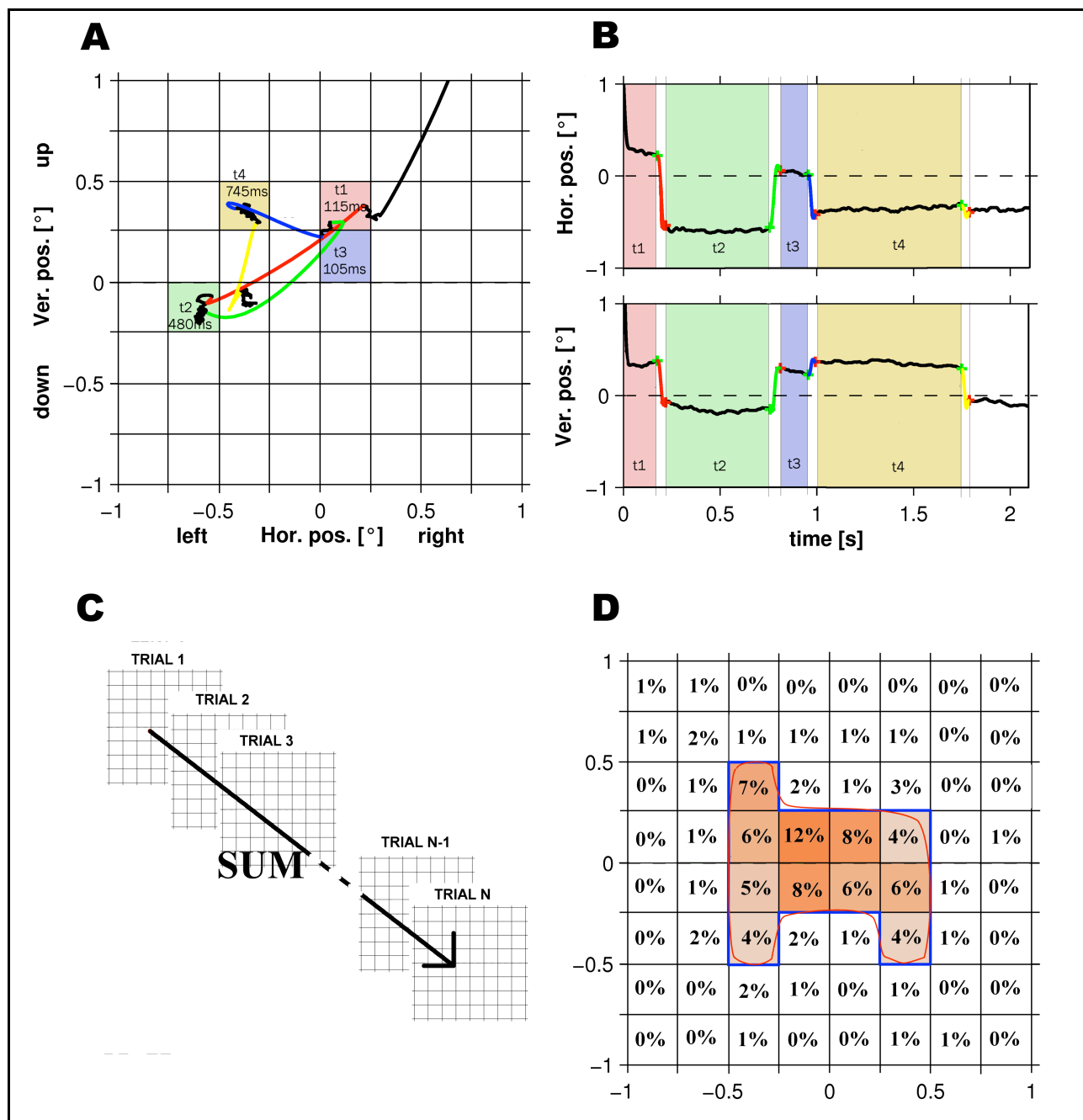

Figure 3.2: Simplified example of the dwelling time distribution's computation.

The single fixation trial presented in figure 2.3 is here used to describe the computation of the area of dwelling time.

The time spent in the starting eye position before each saccade was computed (B). This time was associated with a squared area according to the starting eye position, as illustrated in panel A. For this particular trial, four intersaccadic intervals were identified (t1,t2,t3,t4) and associated with four eye positions, corresponding with the centers of the colored square of panel A. The time dwelled within each square of the grid was computed in this way for all fixation trials, and values of each trial were summed up (C). Finally, the percentage of time spent within each squared area was computed (D): Squares were then included, starting from the one where the eyes dwelled longer, until the total percentage represented by the selected squares (red shaded in panel D) reached a desired value (in this case, 68%). A smooth line (red line in panel D) including the centers of all selected square was finally computed.

After scanning the complete range of eye positions, the matrix of values obtained for each step of the pooling window was normalized and the percentage of the total fixation time spent in each position was computed. A Gaussian 2D filter ($\sigma=1$) was applied to smooth the data and a second iterative process calculated different isoline levels containing 95%, 68% and 5% of the total dwell time (maximum error 0.5%).

3.2.2 Analysis of the direction of fixational saccades

The aim of this analysis is to define those eye positions from where saccades move in directions that can not be predicted by the position of the eyes itself. Directions are described by the angle between a reference and the measured direction. In this study, the horizontal movement to the right was defined as reference direction (0rad). The algebra that applies to linear measures is not suitable for angles (for instance the difference between 2π and 0 is 0rad). Accordingly, there is a whole field of statistic dealing with directions.

The mean angle (ANG_{mean}) of n directions, $d_1, d_2, \dots, d_i, \dots, d_n$, is defined by:

$$ANG_{mean} = \arctan^* \left(\frac{\sum_{i=1}^n \cos(d_i)}{\sum_{i=1}^n \sin(d_i)} \right)$$

Where $\arctan^*(x,y) = \arctan(y/x)$ if $x>0$, $\arctan^*(x,y) = \arctan(y/x) + \pi$ radian (rad) if $x<0$; this angle can be viewed as the direction of the vector obtained adding n unit vectors directed as d_i (versors).

The amplitude of this resulting sum vector is defined by:

$$AMP_{mean} = \frac{1}{n} \cdot \sqrt{\left(\sum_{i=1}^n \cos(d_i) \right)^2 + \left(\sum_{i=1}^n \sin(d_i) \right)^2}$$

This measure has the peculiarity of being one if all directions have the same value (no variability) and 0 if for any given direction there is its opposite. From this measure, the circular variance (CV) is derived (Fisher 1993):

$$CV = 1 - AMP_{mean}$$

The CV ranges from 0 to 1 (maximal dispersion of directions), and provides a simple measure of the group's direction variability. In order to infer its relationship with the position of the eyes from the measured data, a binning procedure is required. The chosen bins were circles, whose radius was computed for optimal binning (Shimazaki and Shinomoto 2007) by minimizing the cost function

$$C(\Delta) = \frac{(2 \cdot k - v)}{\Delta^2}$$

Where Δ is the area of the bin, k and v the mean and variance of elements counted in each bin of area Δ . In order to define the region of highest variability, a Rayleigh test of uniformity was performed any time the bin grouped 20 directions. The Rayleigh test is performed over the statistic:

$$Z = n \cdot (AMP_{mean})^2$$

Where n is the number of directions; the hypothesis of uniformity was tested against the alternative of a unimodal distribution, and the test is reliable also with small n ($n > 5$). Therefore, the area of higher variability included all the eye positions from where saccades directions were non-unimodal (uniformity could not be rejected at significant level of $p < 0.05$). The centre of the area was then defined by averaging these positions weighted by their CV . The area of maximal variability could be defined in all but one experiment, where the recorded saccades were too few and too scattered to compute a statistically significant area of higher variability.

3.2.3 Graphical representation of saccade directions

In order to graphically visualize the relation between the position of the eyes and the directional variability, the values of Z obtained gathering saccades according to their initial position were presented as a color map (this can be seen in fig. 4.4). However, the circular variance does not fully describe the behaviour of saccade directions. Exploiting directional statistic, the central values (mean) and dispersions of directions were computed; arrows were superimposed to the map of variability to indicate the average direction of group of saccades starting from neighboring positions. Since an high value of CV could derive from a uniform distribution of directions as well as from symmetrical distribution around opposite directed modes, before computing the mean direction of the pooled saccades, the statistical probability that the distribution was uni-, bi-, multimodal or uniform was tested. Such a computation was done in the first place because only a unimodal distribution is suitable to be described with a single value of central tendency and dispersion. Secondly, it let us test whether from positions of higher directional variability, saccades were moving along a preferred direction (bi-modal distribution) or if they moved with no particular preference in any direction. Such a result could be of interest when discussing the mechanisms of generation of fixational saccades (see chapter 5). Briefly, the algorithm pooled saccades according to their starting position (pooling was obtained by means of squared 0.25° bin moving horizontally and vertically by step of 0.2°). The number of modes was tested exploiting a modified version of the broken axis technique (BAT, Holmquist and Sandberg 1991), consisting in multiplying all the sampled angles by a factor α in order to reduce the CV . Numerically, this was done by multiplying every direction by different values of α (from 1 to 5 by steps of 0.01), and finding α_{max} maximizing the value of:

$$AMP_{mean}(\alpha) = \frac{1}{n} \cdot \sqrt{\left(\sum_{i=1}^n \cos(\alpha \cdot d_i)\right)^2 + \left(\sum_{i=1}^n \sin(\alpha \cdot d_i)\right)^2}$$

The test of the number of modes was performed on the values $AMP_{mean}(\alpha_{max})$, and depended also on the number of directions (n) and on the specific value of α_{max} (for details, see the appendix). In case of a unimodal distribution, the pooled saccades were represented by a single vector starting from the center of the bin and oriented as the mean direction. A further couple of vectors including the 68% of the pooled directions around the mean visualized the spread of directions for the binned saccades. In case of a bimodal distribution, a more complex fitting procedure was performed to identify the direction of the two modes and the dispersion of directions around each mode. The complete methods for testing the number of modes and for computing the averaged direction and dispersion for uni- and bimodal distributions are detailed in the appendix

3.2.4 Analysis of the amplitude of fixational saccades

This analysis was performed in order to test the corrective action of fixational saccades. The relationship between the amplitude of fixational saccade and the position from where the movements started was studied. The vertical and the horizontal component were analyzed separately. The level of correlation between the two quantities, computed with the Spearman ranking techniques, indicates how strong is the tendency of a saccade to bring the eyes back towards central positions. A common way of describing a motor system is by means of its gain, i.e. of the ratio between its (sensory) input and the (motor) output. In the analysis of fixational movements, however, computation of a gain raises several problems. In particular, it is problematic with regard to the definition of “retinal eccentricity”, i.e. the distance of the fovea from the target. Such a quantity is normally used as input of the visual system, but during fixation behaviour its definition with a single point is not admissible. Indeed, during the foveation of a target, there is no position the eye can take to prevent the generation of a saccade, and computing the gain would be senseless in the presence of an output (a saccade) with 0 input. For this reason, the gain value was

computed by fitting the relationship between the initial (horizontal or vertical) positions of the eye and the amplitude of the saccades. Because of the symmetrical organization of the oculomotor system, two different gains were computed for saccades moving in opposite directions (i.e., towards the left and towards the right). The gain values result from the fitting with a broken line having two distinct slopes for the different direction and passing through an intersection point ($X_d, 0$), representing the offset of the relationship. The three parameters of the fitting were calculated by minimizing the square error in the orthogonal sense. The orthogonal distance regression (also known as model-2 regression) was chosen instead of the ordinary least square regression (or model-1 regression) because of the uncertainty existing on the nature of the input driving fixational saccades. Moreover, this model-2 regression is less affected by data non-normalities, and the data showed that both positions and amplitudes were strongly leptokurtic (distribution more pointed than a normal). The fitting was also constrained to continuity, i.e. for any small increase in eye position, there was a small change in eye amplitude. This solution was chosen instead of fitting two different lines (with two different intercepts) for leftward and rightward movements (Goffart and Pélisson 1998). A negative gain means that when the eye was to the left of the intersection point, it moved to the right and vice versa. Robust fitting was used to reduce the influence of outliers on the calculated regression. The algorithm iteratively reweighted residuals with a sigmoid function. More specifically, the normal cumulative function with $\mu=0.5$ and $\sigma=0.15$ was used on the normalized residuals to generate weights after removing the 5% largest residuals. A small (10%) contribution to the weighting function was attributed to the relative sample size (percentage of saccades in one direction) as well as to the correlation values between eye positions and saccade amplitudes for each direction. These two additional weights attenuated the biases that the largest dataset or poorly correlated data could exert upon the fitting.

4. Results

In this chapter, the effects of unilateral inactivation of the FOR on the foveation of a central visual target are described.

4.1 Qualitative description of the impairments on fixation following unilateral FOR inactivation

Some qualitative observations on the effect of an unbalanced fastigial activity on fixation can be drawn simply by comparing the oculomotor behaviour of the monkeys before and after the pharmacological FOR inactivation.

Before the lesion, the eyes moved around the Averaged Position (AP) that is, that particular direction of the eyes obtained by averaging the horizontal and vertical values of positions used during the time of central fixation for all the trials of an experimental session (see chapter 3.1). The AP is commonly used to define the direction of the target and as a reference to measure the direction of the eyes (null position). Although in the following its common meaning of “on target” position will be disputed, I will also use the AP as a reference position, both because it is a measure familiar to the most and because it varies little when computed with different small random subsets of trials. For this reason, it is possible to compare positions measured before and after the lesion using the pre-lesional AP as common reference, thus considering same pre- and post-lesional positions as identically distant from the real “on target” position, wherever this is actually located.

Saccades moved the eyes around the AP even in a 2 seconds trial (fig. 2.3, panels A and B).

Considering all the trials, while looking at the target, the eyes were directed on positions covering a

rather extended area centred on the AP (fig. 2.3, panel C), dwelling longer on central positions and using less frequently more peripheral ones.

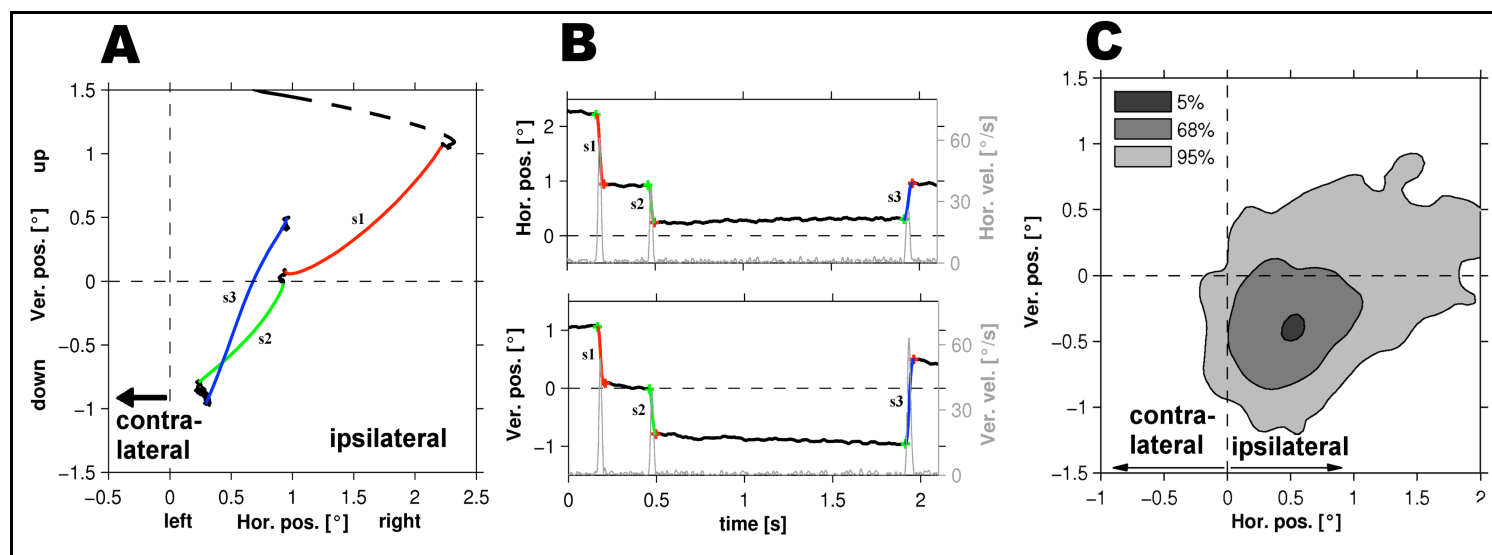

Figure 4.1: Fixational behaviour after the inactivation of the right FOR.

Panels are organized like in fig. 2.3. The thin dashed lines in all panels (their crossing in panels A and C) indicate the prelesional averaged positions (AP). As discussed in the text, positions in this figure and in fig. 2.3 can be compared.

The thicker black dashed lines in panel A represents part of a larger primary saccade (in this case, an ipsilesional movement; before the central target was turned on, the eyes were in contralateral positions). Note that in panel B the trial begins after the primary saccade. All primary saccades brought the eyes in positions that were ipsilateral with respect to the prelesional AP and the first movements (the blue and the green one, in this example) were contralesional. Ipsilesional movements (blue trace) often originated from ipsilateral positions ($89.2 \pm 21.6\%$ of ipsilesional saccade in monkey B, $66.1 \pm 22.0\%$ in monkey E). C shows in which positions the eyes dwell longer after the lesion. Compared with a normal distribution (fig. 2.3C), the eyes dwell longer on more ipsilateral positions (before the lesion the distribution of dwell time was centered on the AP, represented by the crossing of the thin dashed lines). Note also that the distribution is no longer normal-like: The most used position (darker area) are not in the middle of the area representing the overall explored area (light gray, 95% of the fixation time included), as before the lesion.

After the pharmacological inactivation of the FOR, the monkeys displayed the typical oculomotor impairments described in the introduction: Visually guided saccades directed towards the inactivated side were hypermetric, while those shifting the gaze in the opposite direction were hypometric. Because of this, the primary saccades (either an hypermetric ipsilesional or an

hypometric contralesional movement, carrying the eyes from wherever they were in the periphery to the central target at its onset) always brought the eyes in positions that were ipsilateral with respect to the prelesional AP (see the thick dashed line in fig. 4.1A). If the goal of the animal was to reach the previous AP, an increased number of corrective (contralesional) movements was expected. Indeed, in the first part of the fixation trial movements seemed to correct for the biased position (movements labelled s1 and s2 in panels A and B of fig. 4.1). However, after a variable number of “corrective” movements, a saccade in the opposite direction could be triggered (movement s3 in fig. 4.1). Overall, the eyes covered a surface which was shifted, although partially overlapping, with respect to the one explored before the lesion (compare fig. 2.3C and 4.1C). This offset was also observed from previous studies (Robinson et al. 1993, Iwamoto & Yoshida 2002, Goffart et al. 2004). In these studies the question whether the observed offset was due to a lack of time given to the animals to reach the desired target was raised. The observation of ipsilesional saccades generated before the prelesional AP (instead of further corrective movements) is not compatible with this hypothesis, and suggests that the ultimate goal for foveation might not be the same as before the injection. A detailed analysis of the horizontal component of amplitude provides additional evidence against this hypothesis. Fixational saccades were grouped according to their latency relative to the presentation of the central target; their horizontal component was averaged across a temporal window (500ms) and mean values before and after the lesion were compared. Before FOR inactivation, the horizontal component of saccades amplitude was always indistinguishable from zero. This means that the probability of moving in one or the other direction was identical at any time of the trial, and the amount of movement generated by rightward saccades within the temporal window was identical to the one generated by leftward saccades. After the lesion, on the contrary, because the first saccades were always contralesional, the averaged horizontal component was initially significantly different from 0 (Wilcoxon sign rank test $p < 0.05$). However, after a variable amount of time (mean \pm SD = 1.18 \pm 0.29 and 1.3 \pm 0.48 sec, monkey B and E) saccades in the opposite direction (ipsilesional) occurred, and the amount of movement they

generated was such to counteract the one generated by contralesional movements (the average became indistinguishable from 0, like before the injection).

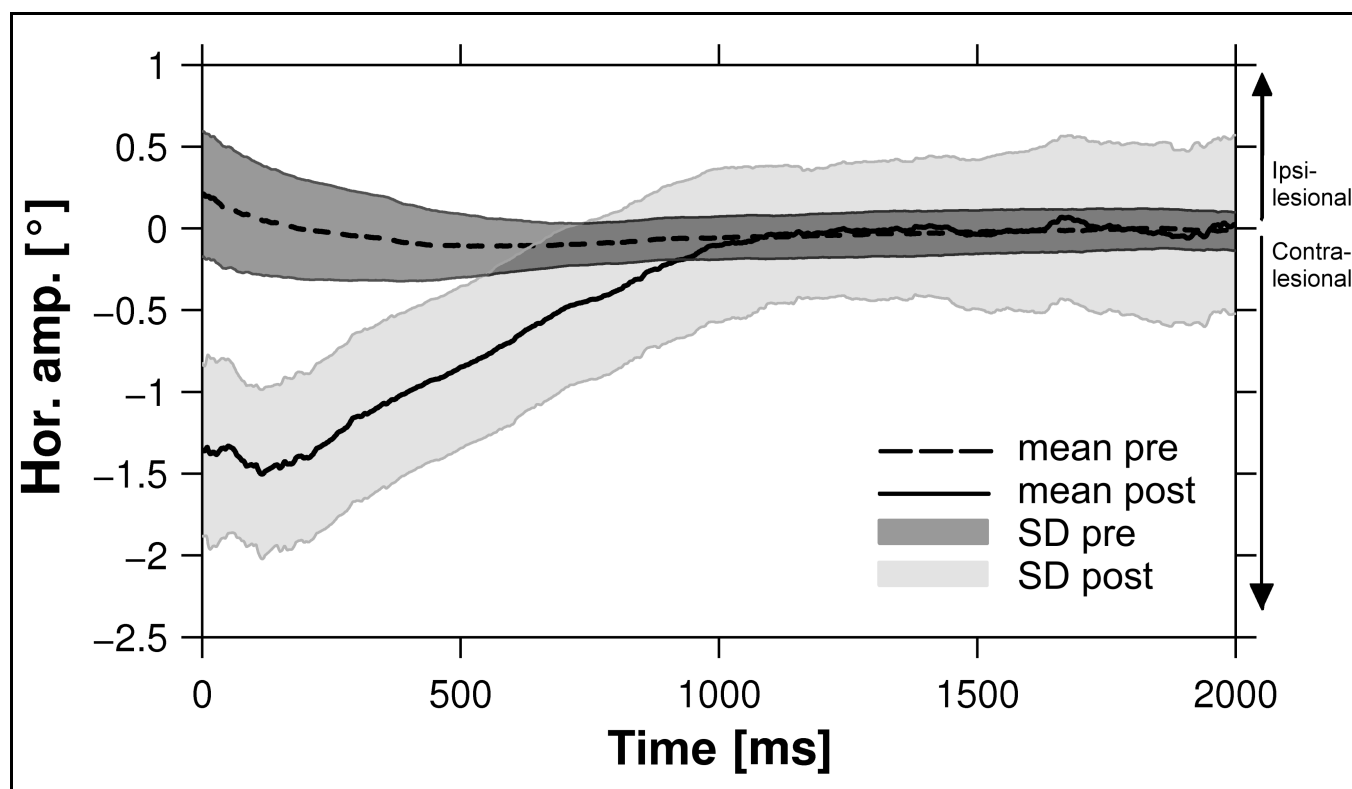

Figure 4.2: Temporal evolution of the mean horizontal amplitude.

At each time position t ($t = 1\text{ms}$), the average of the horizontal components of all the saccades of one experimental session occurring within a temporal window $t \pm 250\text{ms}$ was computed. A 0 average value means that within the temporal window, the eyes moved equally to the right and to the left. The shaded area indicates how variable the amplitude of these saccades was. Before the FOR inactivation, the amount of movements in the horizontal direction was symmetrical. On the contrary, after the lesion, saccades occurring in the first period of fixation moved the eyes more often with contralesional movements (negative amplitude). This is due to the fact that the primary saccade always brought the eyes into the ipsilateral side (fig4.1A). The average horizontal component decreased with time, both because contralesional saccades became smaller and because ipsilesional saccades occurred. After a certain time, the amount of movement generated by ipsilesional movements occurring within the temporal window (500ms) was equal to the amount of movement generated by contralesional saccades as in the prelesional condition. Note, however, that the variability of the horizontal component during fixation remained larger than the one observed in normal condition.

To sum up, after the lesion, the eyes used positions which were different compared to the ones they used before. Although similar positions could occasionally be used before and after the lesion, the

distribution of dwelling time was ipsilesionally shifted. The observation of ipsilesional saccades counteracting the action of contralesional ones suggests that the lesion changed the goal position for foveating the target. In the following paragraphs, an alternative description of the fixational behaviour will be used in order to understand what is the motor goal (if any) of saccades occurring during fixation.

4.2 Effects on the corrective nature of fixational saccades

When a target or a visually relevant object appears in the periphery, a saccade moves the eyes with the direction and amplitude required to bring it on the fovea, the most sensible part of the retina.

Does a similar mechanism affect also fixational saccades? If this was the case, these movements could be simply considered as attempts of the oculomotor system to bring the eyes in the optimal position (the goal position) to view the target. Saccades, then, should “correct” for the difference between the positions where the eyes are and the goal position; their amplitude should increase proportionally with this difference and be of an appropriate size, in order to cancel it. The proportionality between the initial position of the eyes and the amplitude of the movement can be tested on a single meridian (e.g., the horizontal or the vertical) by means of the traditional linear correlation. It is noteworthy that this analysis does not require the knowledge of the actual goal position; the problem of defining this position and verify whether fixational saccades are of an appropriate size for moving the eyes on it will be tackled in the following paragraphs (4.3 and 4.4).

Figure 4.3 displays the horizontal component of fixational saccades’ amplitude and of their horizontal starting position before and after the lesion in two monkeys (monkey E, panels A and B; monkey B, panels C and D). Note that the prelesional AP is used as a reference to measure the position of the eyes; as already said, such an arbitrary decision does not affect the analysis of correlation that is going to be presented. In panel A and C, saccades made during a control

experimental session are shown. The graphs nicely display the corrective nature of fixational saccades: When the eyes were in rightmost positions, saccades moved to the left, and vice-versa. Indeed, the correlation between the initial position of the eyes and the saccade amplitude before the unilateral FOR inactivation was high and strongly significant (mean \pm SD of Spearman correlation coefficients for the horizontal component: $R = -0.75 \pm 0.02$ and -0.74 ± 0.07 , vertical component: $R = -0.80 \pm 0.03$ and -0.81 ± 0.04 for monkey B and E respectively, $N=6$, all one-tailed $P_s < 0.001$). In panels B and D of figure 4.3, the relation between the two measures observed after unilateral injection of muscimol in the caudal part of the fastigial nucleus is displayed. It is clear that, after the lesion, ipsilesional and contralesional movements behaved differently. While contralesional saccades were still highly dependent on the eye position (average R_s : monkey B, -0.82 ± 0.06 , monkey E, -0.87 ± 0.04 , all $N=6$), ipsilesional ones became much more variable (average R_s : monkey B, -0.17 ± 0.26 , monkey E, -0.59 ± 0.04 , all $N=6$); in some cases (3 out of 12) the correlation between starting eye positions and amplitudes was even not significant (see figure 4.3, panel D: leftward saccades do not display any relation between their horizontal amplitude and the starting eye position). A similar analysis on the vertical component of saccades, revealed that the direction and amplitude of movements was related to the initial position of the eyes also along the vertical meridian. However, the vertical component of fixational saccades was not affected in a consistent manner by the fastigial inactivation. The analysis presented here shows that the amplitude depended on the initial position of the eyes; the negative correlation (leftmost position leads to rightward movements and vice versa) underlines the system's attempt to remain around (i.e., do not move too far away) a certain position. In what follows, I will present the results obtained with the novel method developed in order to identify the goal location of fixational saccades and to analyze their accuracy.

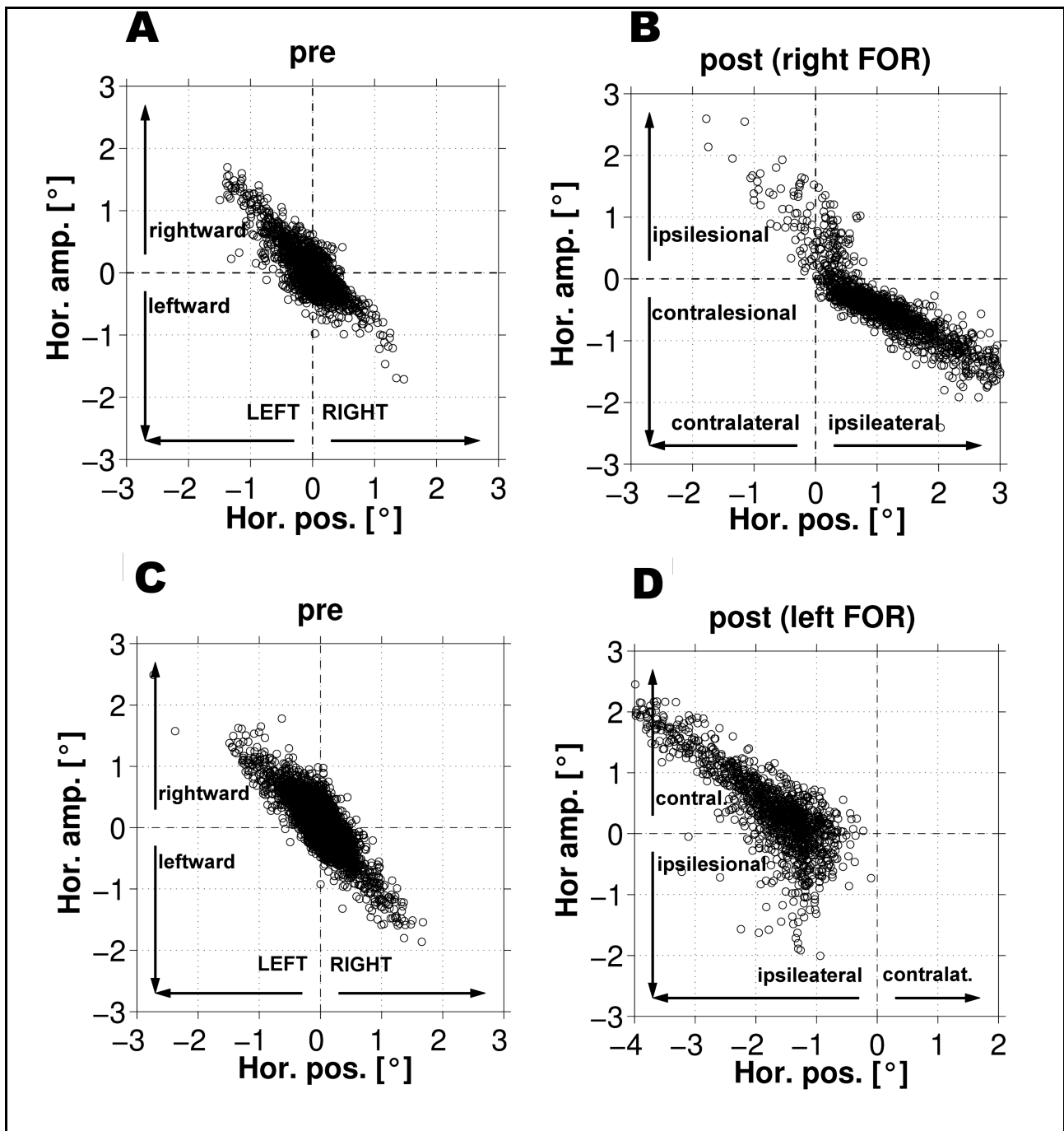

Figure 4.3: Relationship between the starting position of saccades and their amplitude.

For each saccade, the horizontal component of its amplitude and initial eye position were plotted. Positions are measured using the prelesional AP as reference (crossings of dashed thin lines). **A and C:** Fixational saccades in control session of monkey E (panel A) and B (panel C). There is a clear linear relation between the position of the eyes before a saccade and its amplitude. **B (right FOR in monkey E inactivated):** Following the inactivation, the linear relation is still present; however the behaviour of saccade moving in the two opposite directions (ipsi- and contralesional) is different. **D (left FOR in monkey B inactivated):** In this example, while the correlation was still present for contralesional movements, it was lost for the ipsilesional ones. Later in the text, changes of the relationship will be analyzed in more detail (see also fig. 4.6)

4.3 *Effects on the control of directions*

The proportionality between the position of the eyes and the amplitude of fixational saccades is in agreement with the hypothesis that these movements aim to bring the eyes on a goal position which is considered optimal for looking at the target.

In this study, a novel technique for the analysis of the relationship existing between the positions of the eyes (again with respect to the reference position AP) and the direction of movements was developed. By means of this technique, the hypothesis that fixational saccades aim to bring the eyes on a goal position will be tested. Under this hypothesis, if the system was perfectly noiseless, the eyes should move with no variability towards the goal position.

The actual behaviour is presented in fig. 4.4: During the control (pre-injection) conditions, two major observations were made. Firstly, the direction of fixational saccades indeed depended upon the initial position of the eyes. Saccades were generally directed toward a central area; however, in this central area fixational saccades were characterized by a higher value of directional variability (red-coloured area). In other words, when the monkeys' eyes were oriented toward these specific positions, the direction of the following saccade could not be predicted (the movement could take more than one direction to move away from those positions). Conversely, the further away the eyes were from the central positions, the more congruent the directions of saccades were. In other terms, saccades starting from (neighbouring) peripheral positions all moved roughly in the same direction. The second observation regards the role of the area of maximal variability. Indeed, the centre of this zone acted like a watershed, a turning point for saccade directions: When the eyes were e.g., below and right with respect to it, fixational saccades had a higher probability to be directed up and leftward. The most striking observation after FOR inactivation is that the area of high directional variability was shifted toward the injected side (fig. 4.4B). This ipsilesional shift was statistically significant in both monkeys (Wilcoxon one-tailed signed rank tests, $p < 0.05$, mean \pm SD

magnitude= $0.87^{\circ}\pm 0.44^{\circ}$ and $0.25^{\circ}\pm 0.27^{\circ}$ for monkey B and E, respectively). The shift was also characterized by a vertical component: In monkey E, the vertical shift was always downward (mean \pm SD= $-0.46^{\circ}\pm 0.39^{\circ}$, N=5), whereas it was upward in all experiments but one in the other monkey ($0.55^{\circ}\pm 0.65^{\circ}$, N=6). More generally, the observations on the variability of directions made for the prelesional movements also held after FOR inactivation: From some positions, the eyes moved with roughly the same (position-dependent) direction, aiming at an area characterized by a significantly higher directional variability of saccades starting from within it. Taken together, these results add a better insight of the fixational behaviour, and can be used to refine the hypothesis of a system whose aim is to bring the eyes on a goal position. On the one hand, the direction of fixational saccades is tightly dependent on the initial position of the eyes, and saccades are always directed toward an area acting as watershed for saccades direction. I will refer to the positions towards which saccades are directed as to the motor goal area (MGA). It is noteworthy that the relationship between the initial position of saccades and their direction changed after unilateral FOR inactivation; saccades initiated from similar positions (similar distance from the prelesional AP) moved in different directions before and after the inactivation. This observation, quantified by the shift of the MGA, suggests that the lesion can modify the encoding of the saccadic goal location. On the other hand, this analysis indicates that once the eyes are within the MGA, saccades are not prevented as it would be expected if the goal of fixational saccades was to move the eyes on a specific position. Instead, the eyes always moved with unpredictable directions away from the MGA. Hypothesis on the origin of this behaviour will be discussed in the last chapter of the thesis. A more detailed analysis of saccades initiated within the MGA is however necessary in order to attempt the formulation of a hypothesis. Indeed, as already reported in the methods, the high values of circular variance (CV) observed from positions laying within the MGA could result from two very different motor behaviours. In particular, a high CV could indicate that saccades starting from those positions moved with absolutely no specific direction.

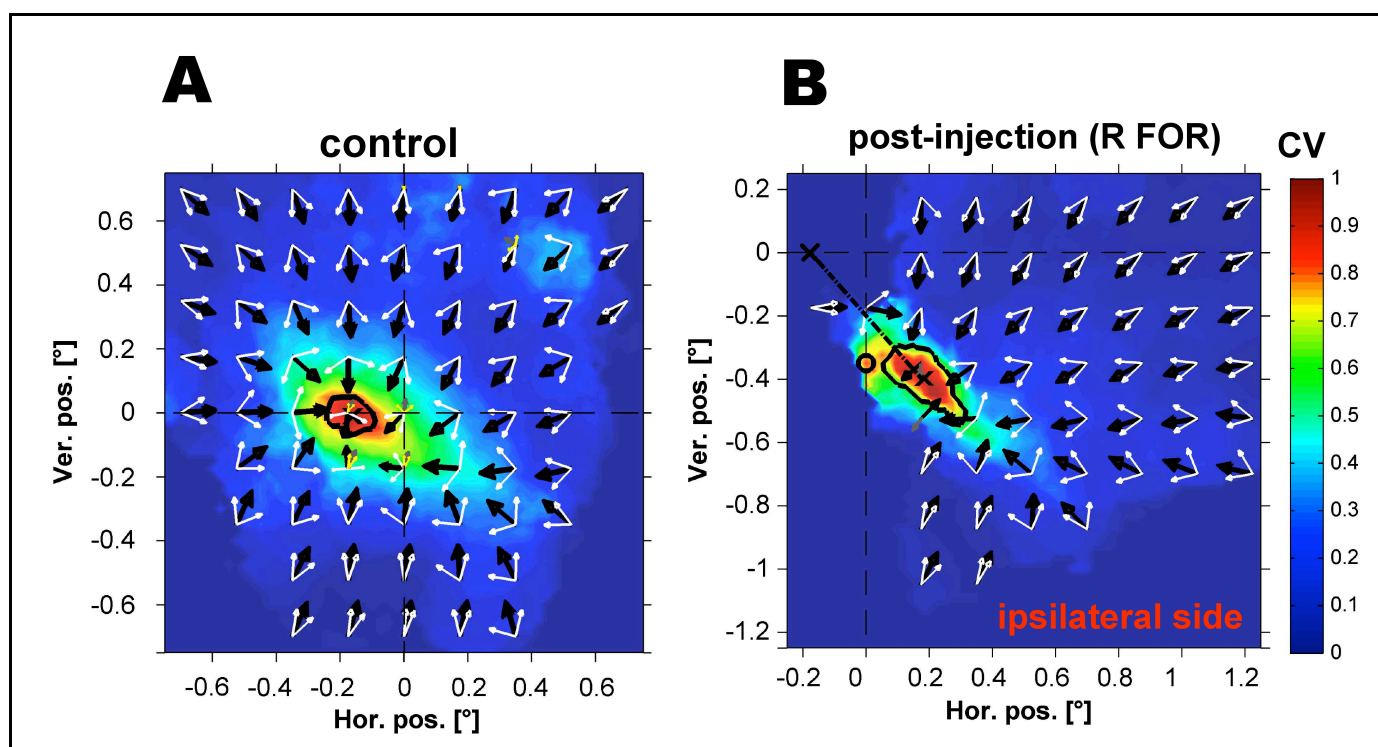

Figure 4.4: Effect of inactivating the right FOR on the relationship between the eye position and the direction of fixational saccades.

Each arrow describes statistically the direction of a variable number of saccades starting from similar position. Positions where no arrows are displayed (background darker blue) are positions not used during fixation (that is, are positions out of the 95% dwelling area proposed in panel C of figs. 2.3 and 4.1). In particular, black arrows represent the median direction of saccades starting from eye positions within a squared 0.25° area around the tail of the vectors. Pairs of white vectors enclose the 68% of directions. When a second mode was detected, its median direction is indicated by a gray vector and a pair of yellow vectors describes its variance. The length of the vectors describes the proportion of directions belonging to each mode (see Methods for more details). The colors indicate how variable is the direction of saccades when they are initiated from each specific position (value of the circular variance in the color bar). Eye positions are referred to the prelesional AP (thin dashed line). A black thick line encloses positions from where the distribution of saccade directions is most variable and statistically different from unimodal (i.e., are positions from where the eyes do not move in a unique direction, red colored region). Both before (A) and after (B) the FOR inactivation, fixational saccades aimed at the area of higher directional variability. The main effect of the lesion is an ipsilesional shift of this area (see the dot-dash black line in panel B, connecting the positions of the two centers). Also after the lesion, some eye positions were characterized by a low directional variability (arrows starting from the bluish area); from these positions saccades moved coherently towards a new goal position, different from the direction they took before the lesion (compare arrows in similar position with respect to the dotted lines in the two panels). Note that also before the lesion, saccades were not directed to the position used as reference. This experiment is an interesting exception showing clearly that motor goal and most used position are not always coincident; however, the centre of the high variability area was on average only $0.06 \pm 0.05^\circ$ off the AP in the other control experiments.

At the same time, the high CV could also result from a distribution of movements clustered with similar proportion around the two opposite directions of a singular meridian (resulting in a bimodal distribution of directions).

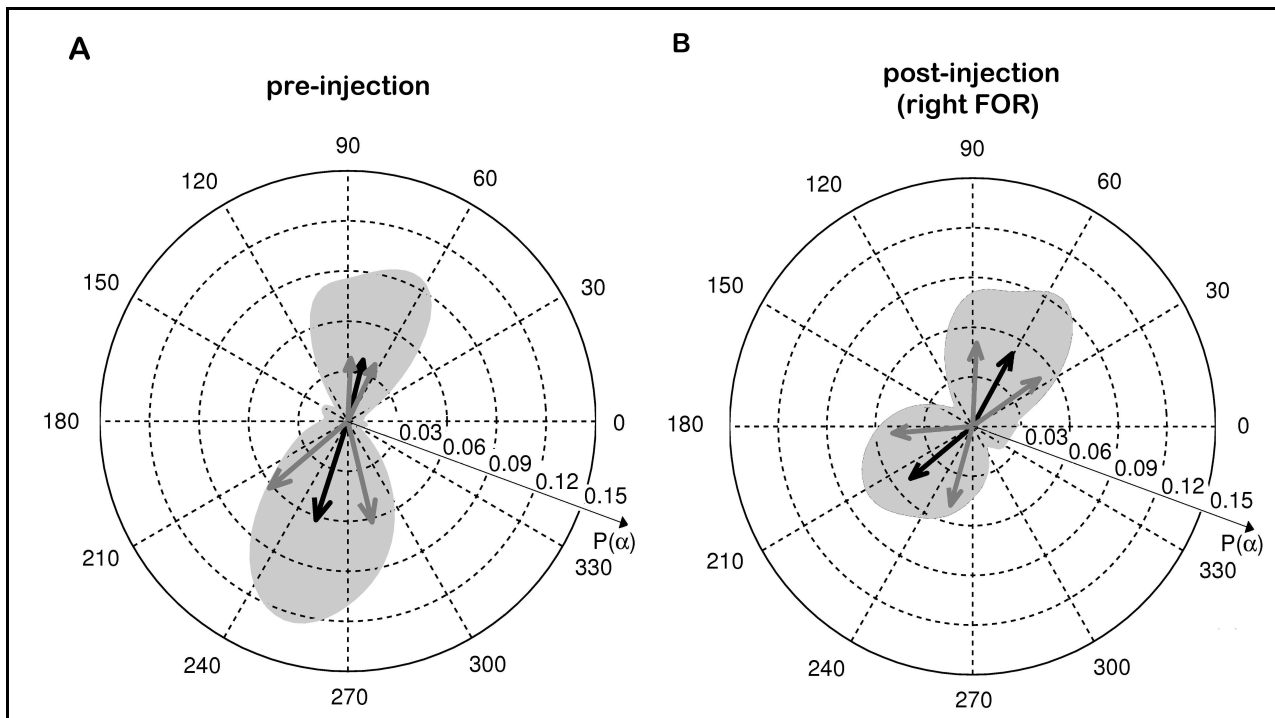

Figure 4.5: Direction distribution of saccades starting from the positions of highest directional variability (red-coloured area in fig.4.4), before (A) and after (B) unilateral FOR inactivation.

Saccades moving from positions nearest to the centre of maximal variability were considered. The shaded area represents the circular distribution of directions. The probability relative to each direction α was computed from the ratio between the number of saccades directed to $\alpha \pm \pi/8$ rad and the total number of directions. The BAT (Broken Axis Technique) was applied on the directions: in this example, $\alpha_{max} = 2.12$ and 1.6 ; $AMP_{mean}(\alpha_{max}) = 0.70$ and 0.61 , before and after the inactivation, respectively. The black arrows represent the two principal modes of saccade directions, while each of the two grey pairs of vectors embrace a circular standard deviation (CSD, see Methods). The length of the vectors is proportional to the number of directions belonging to the mode; the same radial scale as for the probability distribution was used but the mixture probability of each of the two modes was divided by 10 for clarity. The change in direction of fixational saccades after the injection is illustrated by the wider angle between the paired grey vectors in panel B and by a less peaked distribution (shaded area). The figure clearly shows that the eyes moved from the goal position not with erratic directions; instead they clustered with similar proportion around the two opposite directions of a single meridian.

As detailed in the methods section, using a modified version of the broken axis technique (BAT, Holmquist and Sandberg 1991), it was possible to extract parameters for testing the presence of a preferred direction in a group of directions. In particular, when the distribution has two opposite modes, the parameter α_{max} is about 2 and the value of $AMP_{mean}(\alpha_{max})$ is the larger, the tighter the directions are clustered around the two modes. In general, both before and after muscimol injection in the FOR, fixational saccades displayed a symmetrical bimodal distribution (see fig 4.5; mean $\alpha_{max} \pm SD = 1.79 \pm 0.13$ and 2.0 ± 0.19 before and after the injection, respectively, $N=11$). The preferred directions were up-right ($73.5^\circ \pm 12.6^\circ$ in control condition; $72.9^\circ \pm 27.8^\circ$ after FOR inactivation) and down-left (before and after the inactivation: $262.5^\circ \pm 9.2^\circ$ and $242.4^\circ \pm 30.1^\circ$). The statistic $AMP_{mean}(\alpha_{max})$ was significantly decreased after muscimol injection (mean $\pm SD = 0.69 \pm 0.05$ before and 0.56 ± 0.11 after injection), but still significantly higher than the values one should observe in the absence of any preferential direction. Functional implications regarding the observation of a preferred direction for saccades starting from the MGA will be discussed later. So far, it has been shown that fixational saccades in general moves toward a goal, the MGA; in the following section, the accuracy of these movements will be studied.

4.4 Effects on the control of amplitude

The result presented so far shows that saccades have generally the tendency to correct for a mismatch between the position of the eyes and a “goal” position (chapter 4.2). In this chapter, it will be tested whether this corrective behaviour is also accurate i.e., if the size of the movements is appropriate to cancel the error. This corresponds to computing a sort of gain for fixational saccades; however, as pointed out in previous chapter, the peculiarity of the “goal” position for fixational saccades (it can not be identified with a single position, but with an area, the MGA; once reached,

movements are not prevented) required a particular technique for the estimation of their accuracy. In particular, this technique (detailed in the methods) fits the horizontal component of fixational saccades and the horizontal position of their initiation with a broken line, with two different slopes for rightwards and leftwards movements. This analysis, therefore, provides two different values describing the relationship between eye positions and amplitude; a value is computed for saccades directed toward the lesioned side (ipsilesional gain, G_i), a different one for those moving in the opposite direction (contralesional gain, G_c). Such a technique was adopted to better describe the different behaviour of movements in the two different directions, already described earlier (fig. 4.3). Because the goal location is not always coincident with the most usual reference position (the AP, as shown for instance in figure 4.4A), and can not be restrained to a single point, the adopted fitting procedure does not to constrain the offset of the relationship (the position where the broken line display a kink, at 0 amplitude values). The offset, whose choice can obviously influences the computation of the two gains, was therefore one of the free parameter of the fit. Typical results of this analysis are shown in panels A and B of fig.4.6. This analysis was also performed considering the vertical component of saccades, and the results of both components for all the pre- and post-lesional are summarized in fig.4.6C and D. The results show that before the unilateral FOR inactivation, fixational saccades are slightly hypermetric; the gains of the horizontal and the vertical saccades were larger than one. The hypermetria is larger for the vertical component than for the horizontal one; interestingly upward saccades were more hypermetric than downwards.

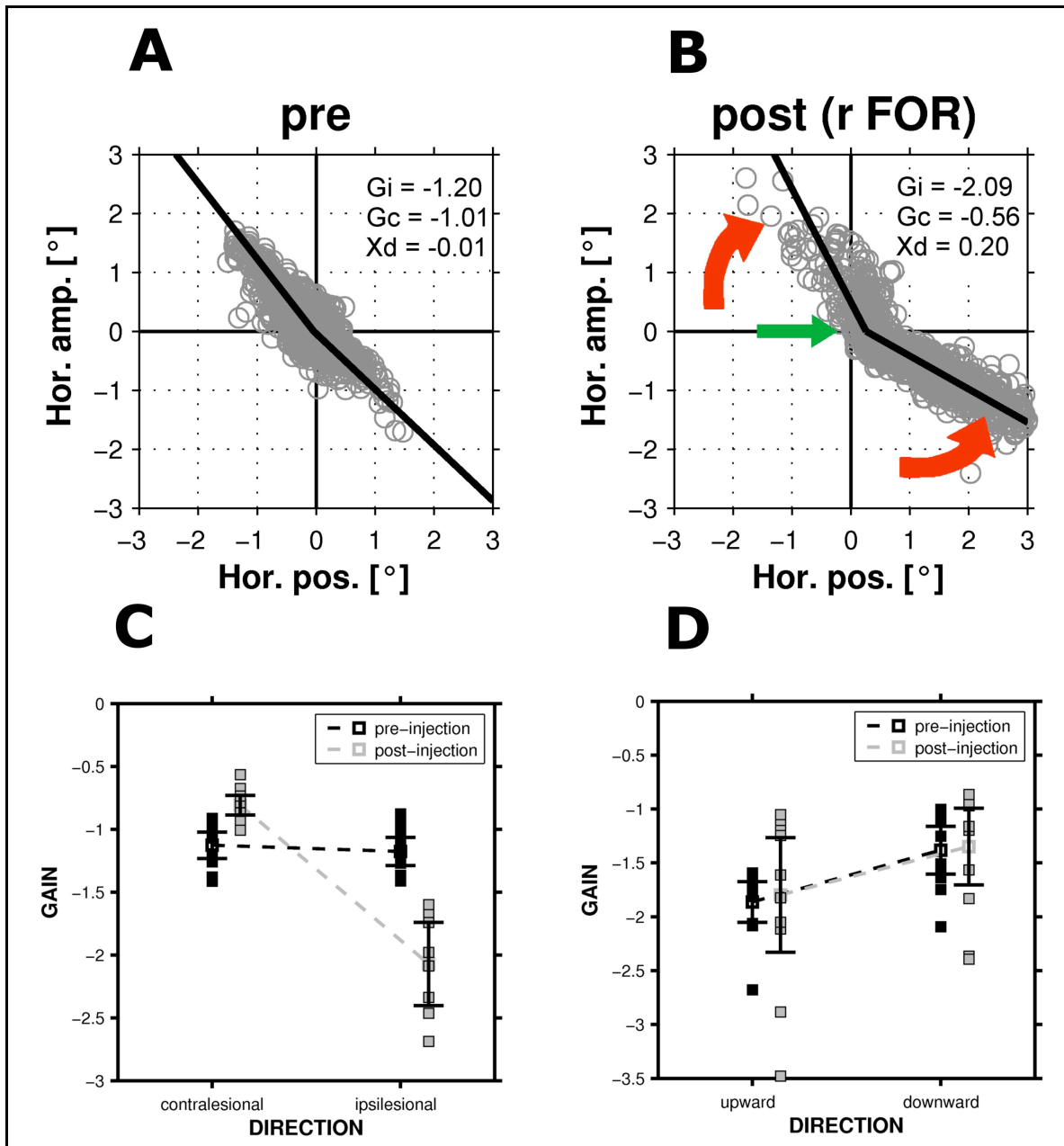

Figure 4.6: Effect of the unilateral FOR on the accuracy of saccades.

A: Before the inactivation, the linear relation observed between the horizontal component of the initial position of the eye and the amplitude of the saccade is symmetrical. Fixational saccades are slightly hypermetric (gains G_i and $G_c > 1$).

B: After unilateral injection of muscimol in the right FOR, rightward movements (positive amplitude) increased their hypermetria, while contralesional movements became hypometric. Note the whole relationship was also shifted toward the injected site ($\Delta x_d = 0.21^\circ$).

C and **D** compare the gain values before and after the unilateral inactivation, for the horizontal (**C**) and vertical (**D**) components, respectively. Negative gains indicate the corrective action of saccades demonstrated in chapter 4.2. Absolute gain value larger than one indicates hypermetria, while hypometria is revealed by absolute gain values smaller than one. The asymmetrical change on the horizontal component is evident. No statistical significance was found on the vertical component gains.

The fact that fixational saccades are slightly hypermetric adds a further similarity with visually guided saccades: Indeed, it has been shown that also very small visually guided saccades display a small hypermetria, in contrast to large visually guided saccades that are generally slightly hypometric (Bartz 1967; Becker 1989; Bötzel et al. 1993). Also the effect of an unbalanced fastigial activity on the control of fixational amplitude led to an impairment qualitatively similar to the one observed in larger visually guided saccades. Figure 4.6C shows that for all experiments, muscimol injection in one FOR altered the amplitude of fixational saccades by causing a decreased gain for contralesional movements and an increased gain for ipsilesional ones. In addition to the slope changes in the relationship between the horizontal starting eye position and the horizontal amplitude of fixational saccades, muscimol injection in the FOR also shifted the intersection point (X_d) toward the injected side (Fig. 4.6B). The magnitude of the relative shift in the intersection point was strongly correlated with the displacement of the MGA's centre (Fig. 4.7, Spearman $R=0.95$ and $R=0.99$ for the horizontal and vertical component, respectively, $P_s < 0.001$, $N=11$). This observation suggests that the centre of the high variability area could be used as the mean goal position for fixational saccades, and that the computed gains indicate their accuracy to reach this point.

4.5 Effects on the foveating behaviour

By means of the spatial distribution of dwell time (fig.2.3C and 4.1C) I have shown that, after the lesion, the eyes used positions that were different from those used before the lesion. The fact that the eyes oriented toward the target differently before and after the lesion could be due both to the impaired control of fixational saccades amplitude and to the shift of the goal location shown in the previous paragraphs.

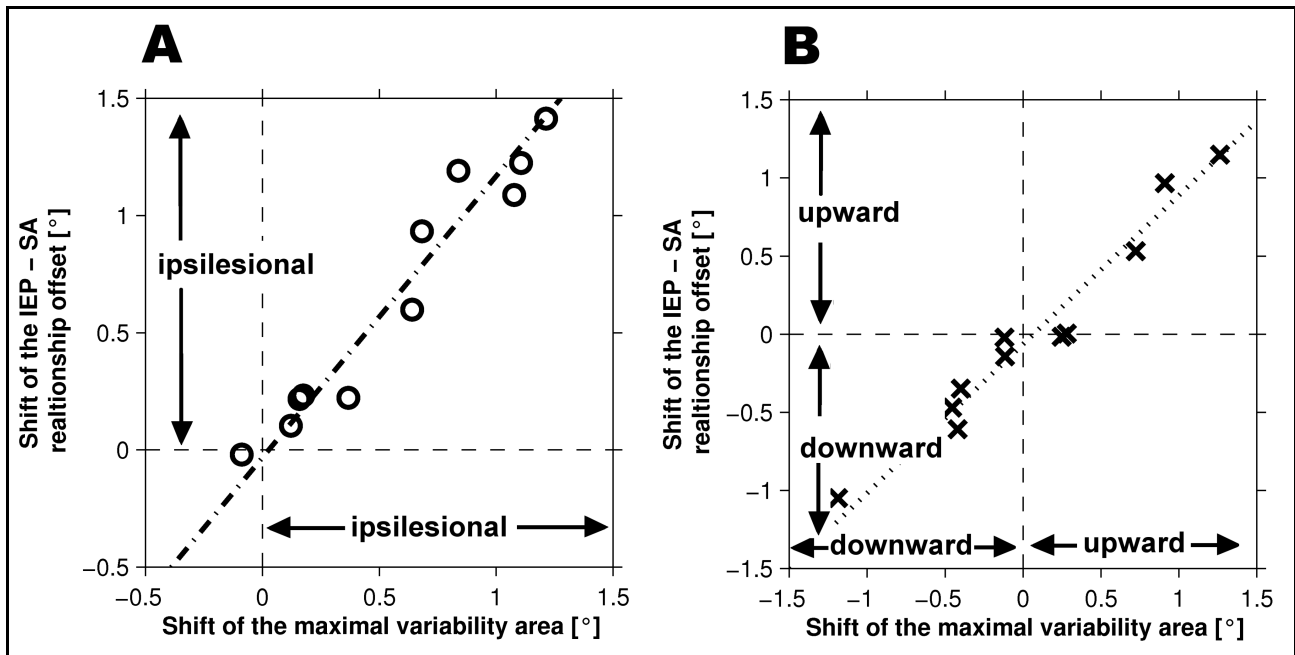

Figure 4.7: Similar lesion-induced shifts of the area of maximal variability and of the initial eye position (IEP) vs. saccade amplitude (SA) relationship.

Both the horizontal (A) and vertical (B) shifts of the area of maximal variability (MGA center) are strongly correlated with the shift of the relation between initial eye position and saccade direction and amplitude. Note that all but one experiment, horizontal shifts were towards the ipsilesional side (shifts significantly greater than 0 in both monkeys).

Vertical shifts were always downward in monkey E, always upward except in one experiment in monkey B.

Indeed, because of an asymmetrical control of saccade amplitude, the eyes need several hypometric movements, and therefore more time, to reach the “on target” position. Once arrived on the target, an hypermetric ipsilesional saccade would recreate a (large) retinal error. On the other hand, a shift of the distribution can be the consequence of misdirected saccades, too: If visual inputs (eye positions) eliciting contralesional movements in normal conditions, evoke ipsilesional movements after the inactivation, the gaze will be centered on a shifted position.

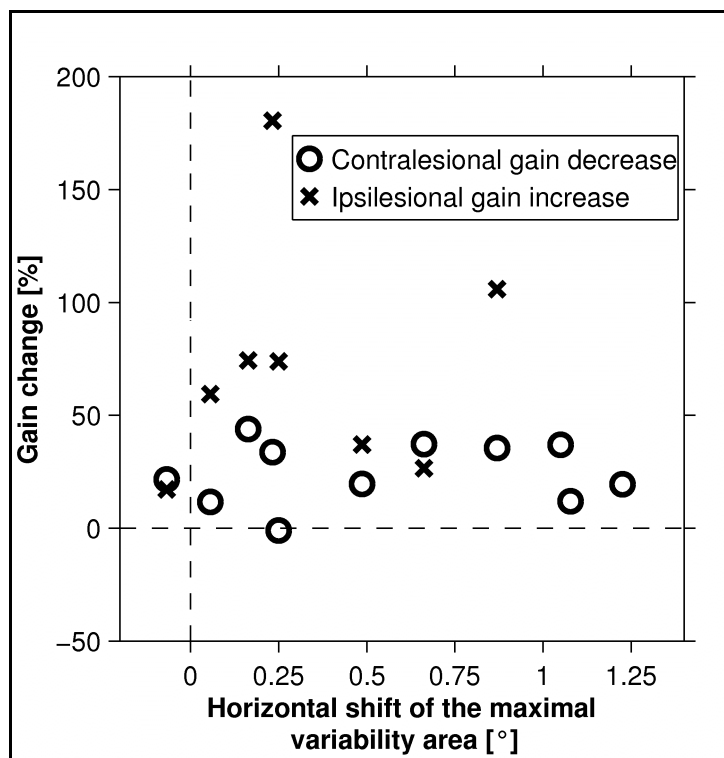

Figure 4.8: Correlation between the shifts of the area of maximal variability and the gain changes.

The observed change in gain of horizontal saccades is not correlated with the horizontal shift of the area of maximal variability, suggesting that the two impairments are independent. Note that in the three experiments where the shift was the largest, the ipsilesional gain could not be computed because there was no significant correlation between saccade amplitude and starting eye position.

The two observed impairments could be correlated: Because the monkeys found it hard to reach the target, they changed the goal position and foveate a slightly shifted area. However, the shift of the MGA was neither correlated with the gain decrease of contralesional movements ($R_s = 0.17$, $N=11$) nor with the increased gain of ipsilesional ones ($R_s = -0.24$, $N=8$, fig. 4.8).

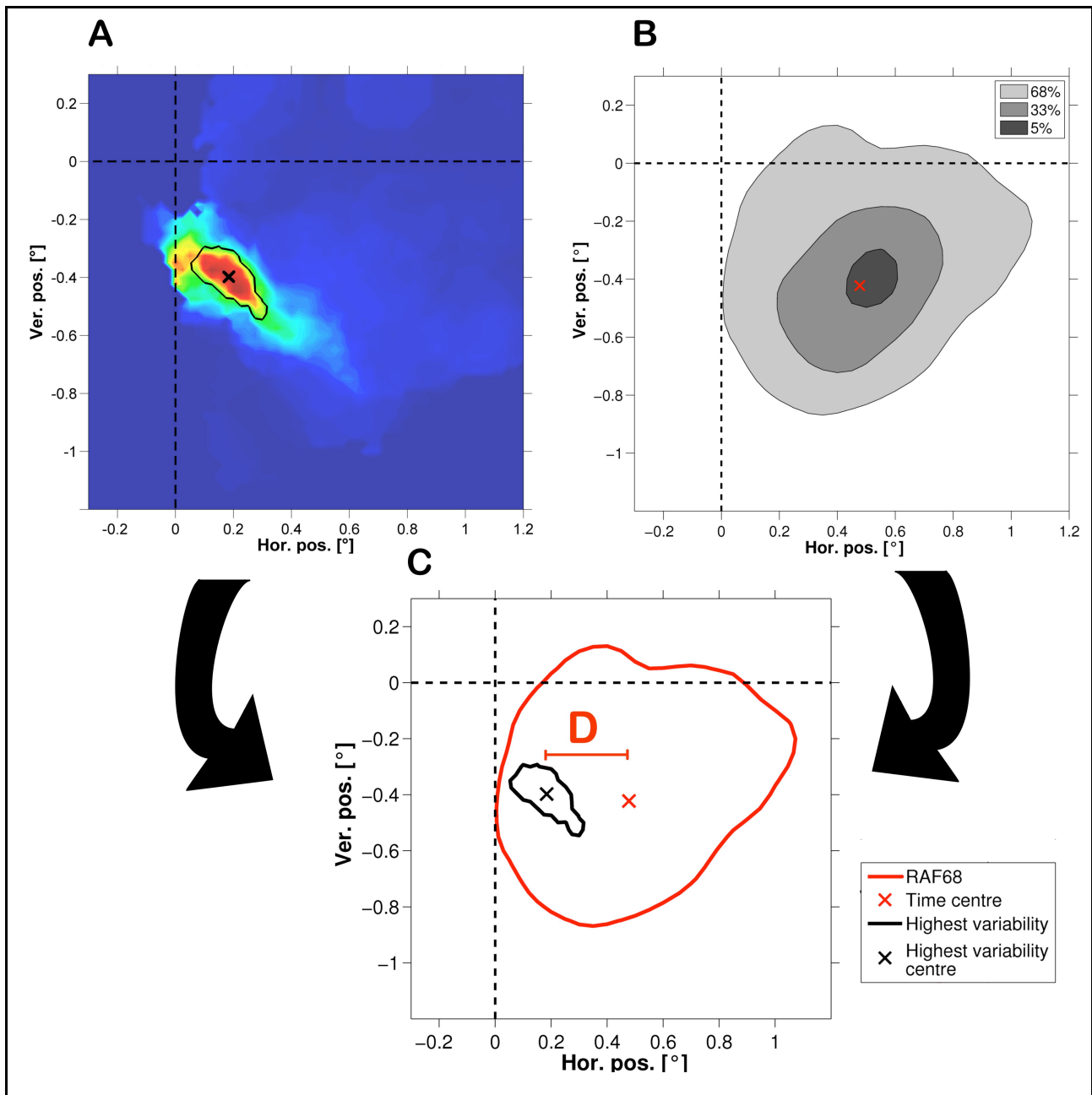

Figure 4.9: Stretching effect following unilateral (right) fastigial inactivation.

After the inactivation, both the area of maximal variability where fixational saccades are directed (also called motor goal area, MGA, panel A), and the distribution of dwell time (B) are in position which are ipsilesional with respect to the pre-lesional averaged position (AP, dashed lines). However, by comparing the two areas (C) it is clear that the position at which saccades aim (the centre of the MGA, displayed with a black cross) and the centre of the distribution of fixation time (red cross) do not overlap. The eyes dwell distribution is stretched in towards more ipsilesional positions, and the distance D between the centers of the two areas measures this effect.

Moreover, the partial correlations between the ipsilesional gain increase (x), contralesional gain decrease (y) and the shift of the area of maximal variability (z) were not statistically significant ($R(x,y/z) = -0.27$ with $P > 0.55$; $R(x,z/y) = 0.15$ with $P > 0.75$ and $R(y,z/x) = 0.46$ with $P > 0.29$). This result suggests that the shift of the goal position and the impaired accuracy were independent effects of the fastigial inactivation. If these two variables are independent and can both affect the shift of dwell time, it should be possible to separate their contribution. In particular, it should be possible, for each experiment, to distinguish to which extent the eyes dwelled longer in more ipsilesional positions because of an altered encoding of the goal direction, and which part of this shift is instead due to the difficulties to reach this goal. After the lesion, the distribution of dwell time was not centred on the centre of the high variability area, the position that, has previously shown, can be interpreted as the “goal” location. With respect to it, the eyes were always dwelling longer in more ipsilesional position (figure 4.9). The spatial distribution of dwell times “stretched” towards the injected side in such a manner that its centre was shifted further than the centre of the MGA (difference between the two centres $D = 0.20^\circ \pm 0.19^\circ$, $N=11$; see fig. 4.9). If the MGA centre is the goal of fixational movements, the effect of an asymmetrical control of movements has to be measured using this position as reference, and a relationship between the dysmetria of saccades and the stretching of the dwelling time distribution should be observed. To test this hypothesis, the correlation between the gain changes and the stretching effect (measured by the horizontal distance between the centre of the dwell time distribution and the MGA centre) was calculated. A significant correlation ($R = 0.71$, $p < 0.05$, $N=11$) was indeed found between the contralesional gains and the shifts of the dwell time distributions relative to the MGA (fig.4.10). The lack of significant correlation between the ipsilesional gain changes and the stretching effect ($R = 0.25$) suggests a limited involvement of the hypermetria in the novel fixation behaviour.

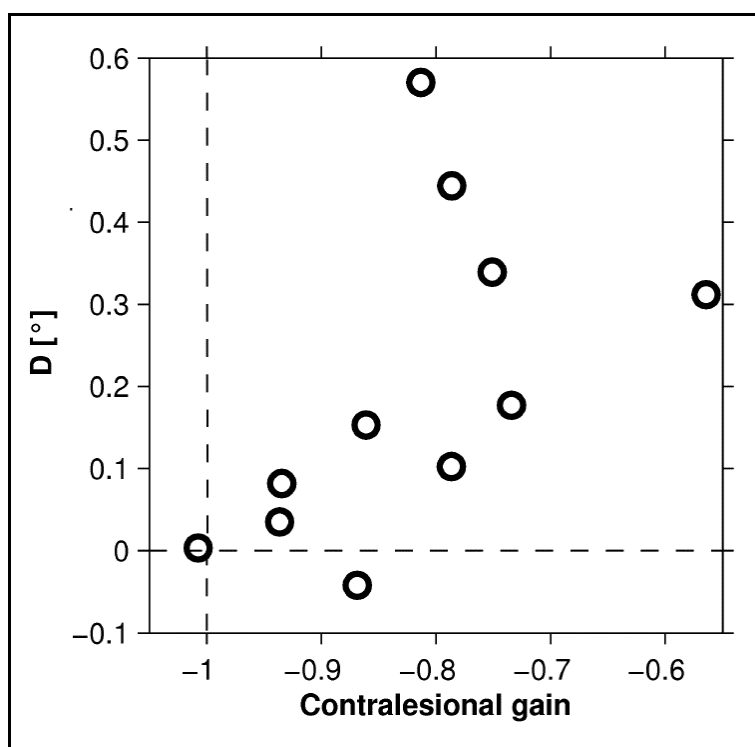

Figure 4.10: Effect of the impaired accuracy of contralesional saccades on foveation

The stretching effect (see fig. 4.9) is correlated with the impaired control of contralesional movements: The more hypometric were contralesional saccades and the longer the eye dwelled in position that were ipsilesional with respect to the center of the MGA (the “on target” position); D is the difference between the horizontal positions of the dwell time distribution and of the MGA (fig. 4.9). Positive values of D indicate that the eyes spent more time ipsilesional with respect to the MGA. The figure shows the correlation between this mismatch and the impaired control of contralesional saccades (quantified by their gain).

4.6 Slow control and saccade triggering

Although the unbalanced activity of fastigial nuclei produced a fixational offset, the function of gaze holding was not impaired. The magnitude of the drift (computed as the difference in eye position between two successive saccades (Møller et al. 2006) did not significantly differ between control and inactivation sessions ($N=6$, two tailed Wilcoxon rank-sum test), neither in the horizontal nor in the vertical component. This result is in agreement with the observation that lesions of the cerebellar midline do not impair gaze holding (Büttner and Straube 1995). However, since the monkeys were not specifically trained to maintain the eyes stable with the use of only slow

movement (like in Skavenski et al. 1975), evidence in favour or contrasting a possible fastigial role in the slow control mechanisms of fixation can not be provided in this study.

Inactivation of the FOR did not change the frequency of fixational saccades, either. After muscimol injection, the frequency (median: 2.51 and 1.31 saccades/second in monkey B and E, respectively) was not significantly different from the frequency observed during the control sessions (monkey B and E: 2.45 and 1 saccade/second, Wilcoxon rank-sum test, two tailed $P_s > 0.05$, $N=6$); this result indicates that, in monkeys, the caudal fastigial is not involved in the triggering of fixational saccades.

Moreover, contrary to what has been found in cats (Goffart and Pélisson 1998), no inactivation-induced differences between the initiation of contra- and ipsilesional movements were observed.

Differences between the intersaccadic latency of rightward and leftward movements appeared both in the control experiments and after the fastigial inactivation; those differences were, however, not congruent with the side of the lesion.

5. Discussion & Conclusion

In this thesis, the effects of an unbalanced activity between the two fastigial oculomotor regions on the fixation of a small visual target were presented. A novel technique was adopted to describe the direction of fixational saccades generated from various eye positions while attempting to look at a small visual target located straight ahead. In these conclusive paragraphs, the analytical methods used and the main results achieved will be discussed. In the final part of the chapter, the results will be linked to other studies, in order to provide a more general view of the cerebellar control of visual fixation.

5.1 *A novel analysis of the fixation behaviour*

Two major aims motivated the analysis of fixation: On the one hand, an interest in measuring how well the eyes were stable during a prolonged period of time; on the other hand, the attempt of finding out which position the oculomotor system encoded as “on target”, i.e., motor goal of fixation. Previous studies accomplished this analysis by means of the scatter of eye positions or of the spatial distribution of dwell times. In the former case, the position of the eyes is sampled at regular time intervals (in particular in early studies, e.g., in Barlow 1952) or relative to particular events (i.e., saccades; this method was adopted, among the others, by other studies of FOR inactivation; Goffart et al. 2004; Iwamoto and Yoshida 2002; Robinson et al. 1993). The second type of analysis, also known as “density of fixation” (Bennet-Clark 1964; Møller et al. 2006), computes the most used eye positions in a temporal sense (see also the method section *Calculation of the spatial distribution of dwell times*). Both methods are well suited for describing the stability of the eye during fixation: The distribution of dwelling time directly describes the visual field

inspected by the eyes during prolonged fixation or several fixation trials. The distribution of the horizontal and vertical eye positions, instead, has to be statistically analyzed in order to infer the variability of the eyes around their mean position (see, for instance, the computation of probability ellipse proposed by Steinman, 1965). Those measures, when obtained from repeated trials, have also been used to estimate the “on target” position: By doing this, it is assumed that the “on-target” position is the preferred (i.e., used more often and for longer times) when foveating a target. Such an assumption of a spatial matching between the preferred retinal locus for fixation and the position of the goal relies on a symmetric execution of eye movements. Thus, any anisotropy (pathological or not) in the mechanisms triggering and executing fixational saccades renders both the scatter of eye positions and the spatial distribution of dwell times inaccurate to define the goal of fixation. The method I propose is intended to overcome this problem; the technique takes inspiration from the work of Cornsweet (1956), who defined as “on-target” the position from where the eyes are “equally likely to move to the left or to the right”. This definition was supported by the observation that microsaccade direction was strongly influenced by the retinal stimulation, i.e. the position of the eyes with respect to the target. The reported results (chapter 4.2) show that such a relation is clearly present also in non-human primates; the direction of saccades depended upon the position of the eye, without being influenced by mechanisms regulating their timing or amplitude (variables that can instead affect the scatter of eye positions or the distribution of dwelling time). By means of this analysis, it was possible to define a motor goal area (MGA) for fixational saccades. The bigger the distance from the MGA, the stronger was the force driving the eyes back to this area. On the other hand, when the driving force was the smallest (the eyes were directed toward the position encoded as “on-target”), the variability in direction was the highest. Based on directional statistics, the algorithms adopted in this thesis also solves those problems in Cornsweet’s definition arising from its limitation to one dimension of eye movements. Indeed, considering only the horizontal component of movements does not allow differentiating between two horizontal opposite movements and two vertical movements with small opposite horizontal components (but identical,

larger vertical components). The reported results, discussed in the following sections, underline the suitability of a method that uses the dynamic nature of foveation in order to provide a sensory-motor description of this behavior.

5.2 *Foveation of a visual target*

The results presented in chapter 4, show that fixational saccades move the eye toward a zone which acts like an "attractor". Although saccades are directed toward this area, their size is variable and generally too large to place the eye in the center of this zone (fig 4.6 C and D). When the eye falls within it, the direction of saccades becomes unpredictable and equally distributed between two opposite directions (Fig. 4.4A and 4.5A). In particular, the monkeys used in this study preferentially moved their eyes along a vertical axis; in contrast, humans fixational saccades are mostly horizontal (Engbert 2006). Hypothesis on the origin of this behaviour will be proposed later in this chapter (paragraph 5.5).

More generally, this study provides additional evidence that looking at a target does not consist of bringing the eyes to a particular position and leaving them there. Indeed, despite the fact that during visual fixation the eyes are "attracted" towards specific position, no specific eye position from where saccadic eye movements were prevented was found. Thus, in my opinion, the term of *fixation* (suggesting absence of movements) is misleading and should be avoided; the expression *foveation* should be instead used, in order to indicate the oculomotor behavior which consists in orienting the fovea toward a target. The results show that fixational saccades help the fovea to scan an area which is usually centered on the zone of higher directional variability. It is noteworthy that, in spite of the large size of acceptance windows used in this study (3° before and 10° after FOR inactivation) and a relatively large anatomical fovea (Perry and Cowey 1985; Wikler et al. 1990), the area of "foveal exploration" is rather limited (Fig.2.3); the median amplitudes of fixational saccades described in

this study (approximately 0.9° and 0.6° , see Table 1) are comparable with those reported in other studies where monkeys had to perform more visually demanding tasks (Bair and O'Keefe 1998; Skavenski et al. 1975; Snodderly et al. 2001). In what follows, a theory on how the oculomotor cerebellum can influence the execution of fixational saccades and modify the foveating behaviour of animals will be proposed.

5.3 Effects of the unilateral FOR inactivation

By means of the novel technique I developed, it was possible to show that the aiming zone of fixational saccades is changed by muscimol injection in one FOR; in particular, the center of this area is shifted toward the inactivated side (Fig. 4.4B). It is noteworthy that the definition of the MGA is not influenced by the different numbers of ipsi and contralesional movements. The shift is uniquely due to the fact that saccades starting from similar positions are generated with different directions after FOR unilateral inactivation. In addition to this effect on the direction of saccades, unilateral FOR inactivation also causes asymmetrical changes in the amplitude of fixational saccades. The horizontal amplitude is hypermetric for ipsilesional saccades and hypometric for contralesional ones (fig. 4.6). These asymmetrical changes were described by two gain values whose computation was independent of the relationship between eye position and saccade direction. This study clarifies how the change in horizontal amplitude and the shift of location of the aiming zone contribute to the fixation offset observed after FOR inactivation (fig.4.9). If FOR inactivation only shifted the aiming zone without producing asymmetrical values of the gains of ipsilesional and contralesional saccades, then the eye would dwell symmetrically around a shifted position. In this case, a spatial translation of the distribution of dwell times would be the only observed effect. Conversely, if the impairment only concerned the amplitude of fixational saccades, the location of the aiming zone would not change after unilateral FOR inactivation. However, being pushed toward

ipsilesional positions by hypermetric fixational saccades, the eye would require several contralesional saccades to move back to the “on target” position, because of their hypometria. Therefore, due to the hypometria of contralesional movements, the gaze would spend more time in ipsilesional positions, and the observed effect would be a stretching of the distribution of dwell times toward the injected side. Studying independently the aiming position and the execution of movements to reach this position, it was possible to show that both a change in the horizontal component of fixational saccades and a shift of the aiming zone occur after unilateral muscimol injection in the FOR. Two observations suggest that the two impairments are independent. Firstly, the two effects are not correlated (Fig. 4.8B): Different injections in the same animal produced independently different effects on the aiming position and on the control of saccade amplitude. Secondly, the shift of the area of maximal directional variability affects both the horizontal and the vertical component, while the changes in amplitude only concern the horizontal component (Fig. 4.6C-D).

Although balanced fastigial activity is important for modulating the horizontal component of saccades (Goffart et al 2004), its pharmacological perturbation does not affect the bimodality of fixational saccades. Moreover, this study shows that inactivation of the FOR did not impair slow eye movement control of fixation, which presumably is influenced by other cerebellar structures like the flocculus (Büttner and Büttner-Ennever 2006).

5.4 Hypothetical role for the fastigio-tectal and the fastigio-reticular pathways

Independent impairments resulting from the FOR inactivation could be explained by the different targets of FOR projections to the brainstem. The shift of the aiming zone could result from a

functional perturbation of the fastigio-tectal pathway, whereas the change in horizontal amplitude could result from a dysfunction of the fastigio-reticular pathway. Indeed, in the rhesus monkey, the fastigial projections terminate bilaterally in the rostral end of the intermediate gray layer of the deep superior colliculus (May et al. 1990). Their perturbation could change the topography of active neurons in the rostral superior colliculi. Thus, an unbalanced FOR activity would change the activity of neurons in the rostral superior colliculi which, in turn, would affect the encoding of the position of foveal targets and lead to the shift of the aiming zone of fixational saccades reported in this study. The fixation offsets following local injection of muscimol in the rostral superior colliculus (Hafed et al. 2008) are compatible with this scenario. This hypothesis is also supported by the vertical component of the fixation offsets described in this study: Indeed a vertical shift of the aiming position is more compatible with a change in collicular activity during fixation, rather than with a direct effect on the vertical burst generator, because the fastigial projections to the mesodiencephalic reticular formation are quite modest (Sato and Noda 1991). A further supportive observations are the similar magnitude of the ipsilesional offsets reported in the head restrained (range = 0.7-1.6° in Robinson et al 1993; mean = 1.1° in Goffart et al. 2004) and head unrestrained monkey (Quinet and Goffart 2005), suggesting a disorder which is related to the orientation of gaze (i.e., a behavioral parameter that takes eye and head orientations into account) during fixation. Given the well-established gaze-related function of the deep superior colliculus (Sparks 1999), this similarity pulls for the hypothesis of a fastigio-tectal perturbation, too. Within the proposed hypothetical frame, the sustained firing rate displayed bilaterally by FOR neurons during intersaccadic intervals (Fuchs et al. 1993; Kleine et al. 2003; Ohtsuka and Noda 1991) would participate in the control of fixation by balancing the activity between the left and right rostral SC. The larger offsets (approx. 5°), observed in head unrestrained cats after muscimol injection in the caudal fastigial nucleus (Goffart and Pélisson 1998), could result from the larger extent of fastigial projections to the deep superior colliculus in the feline species (Hirai et al. 1982; Sugimoto et al. 1982).

With respect to the dysmetria that affects the horizontal component of fixational saccades, a perturbation of the fastigial influence upon saccade-related neurons in the contralateral pontomedullary reticular formation (Noda et al. 1990) would be the most parsimonious explanation. This reticular region is indeed known to control the horizontal component of saccades (Barton et al. 2003; Cohen et al. 1968) and the perturbation of the fastigio-reticular pathway has already been proposed to account for the horizontal dysmetria of saccades observed in the head restrained and head unrestrained monkey after FOR inactivation (Goffart et al. 2004; Quinet and Goffart 2005; Robinson and Fuchs 2001). Finally, the oculomotor function of the fastigio-reticular pathway, which is suggested by microstimulation studies in the head unrestrained monkey (Quinet and Goffart 2009), is also consistent with the independency observed in the present study, between the asymmetrical gain changes that affect ipsilesional and contralesional fixational saccades and the change in their aiming zone.

5.5 Foveation and generation of fixational saccades

It has been shown that the subcortical network for the generation of fixational saccades involves burst neurons in the Paramedian Pontine Reticular Formation (Van Gisbergen et al. 1981) and in the rostral SC (Hafed et al. 2009). When the target image falls on the fovea, the activity in the two rostral ends of the SC is almost balanced, and fixational saccades would result from fluctuations in the equilibrium of this bilateral activity (Hafed et al. 2009). The variability in the direction of fixational saccades starting from some specific positions, outlined by analytical technique proposed in the present study, could result from these fluctuations occurring when a visual target is being foveated. When the activity in the SC is unbalanced because of a distance between the actual position of the eye and the “on-target” position, saccades are generated in order to reduce this distance and to restore the balance in bilateral collicular activity. Accordingly, when the gaze is in

the direction encoded by the system as “on target”, the activity in the rostral SC would be roughly at equilibrium, and saccades are generated with an unpredictable direction. After FOR inactivation, saccades move the eyes toward an aiming zone which has shifted. This shift does not reflect an inability to correct for a small residual retinal error, but presumably a new encoding of the (foveal) target position. Indeed, the results showed that after a certain time, the average effect of fixational saccades on eye position cancel out each other (fig. 4.2) after the gaze has reached the “new” target position. Both before and after the lesion, the directions of saccades generated from the area at which the neuronal activity would be at equilibrium clearly display two modes (up and down). The distribution around two modes could result from different noise levels of the burst generator for horizontal and vertical saccades. However, a recent study has estimated similar motor noise level for the generators of vertical and horizontal movements (van Beers 2007); thus, it seems unlikely that motor noise could be the source of bimodality of fixational saccades. Instead, the fact that the two modes are vertically oriented can be explained by the worst motor control on this meridian; indeed, values for the vertical component of fixational saccades are higher than the one computed for horizontal movements (compare figure 4.6 C and D). Considering the collicular origin of fixational saccades, it is also possible that in the rostral SC horizontal and vertical movements have different gradients of representation, and that the activity elicited from the foveation of the target simply involves a larger spread of the population of active neurons along the medio-lateral axis. Additional experiments are required to test this hypothesis; since a preferred direction is also observed in humans, but on the horizontal meridian (Engbert, 2006), it would be interesting to perform more detailed analysis on their motor generation to gather additional information supporting or rejecting the proposed mechanisms underlying the bimodality of fixational saccades. Cornsweet (1956) has hypothesized three functional systems for the control of saccades. These systems would control 1) the direction and 2) the magnitude of fixational saccades, and 3) their triggering. The present study shows that the fastigial oculomotor region participates in the first two systems but not in the third. These cerebellar-dependent mechanisms would centre the area of

“foveal exploration” on the aiming zone (via the fastigio-tectal connections) and regulate the amplitude of saccades (via the fastigio-reticular connections). Instead, the saccade rate (median of 2.45 and 1 saccade/second in monkey B and E, respectively) was unaffected by FOR inactivation (monkey B and E: 2.51 and 1.31 saccades/second). The absence of changes in the saccade triggering mechanisms is consistent with the lack of significant changes in latencies after FOR inactivation in the monkey (Quinet and Goffart 2007); note that changes in latencies happen after muscimol injection in the feline caudal fastigial nucleus (Goffart and Péliesson 1998). Previous studies reported a dependency of triggering mechanisms on attentional factors (Barlow 1952; Engbert and Kliegl 2003; Hafed and Clark 2002). The presented results are therefore consistent with the observation that while several cortical areas (corresponding in the monkey to the FEF, SEF and LIP-7a) are active during both oculomotor and attentional tasks, the medial cerebellum is activated only during oculomotor tasks (Corbetta et al. 1998). Accordingly, the observed shifts of fixation after unilateral FOR inactivation have a magnitude (never more than 2°), which is not comparable with the gaze deviations observed in patients suffering from neglect after right hemispheric lesions (often more than 20° , Leigh and Zee 2006).

In the analyzed experiment, monkeys were performing a task that was easy from a visual point of view. It is possible to hypothesize that the observed behaviour while the animals were looking at the target was completely driven by subcortical mechanisms. It is however likely that cortical activity influences the otherwise reflexive behaviour. Indeed, both humans (Steinman et al. 1973) and monkeys (Skavenski et al. 1975) can suppress the generation of fixational saccades. In the monkey, this result can be obtained after a special training, while a verbal instruction to humans suffices to prevent the generation of microsaccades (Kowler and Steinman 1980). How this is achieved would require more thorough studies; suppression in the collicular activity and a reinforcement of the activity of the omni-pause neurons are two non-mutually exclusive hypotheses. Also the neuronal basis of the slow control of the eyes to maintain the gaze (Steinman et al. 1973) has to be better studied in order to have a complete picture of this particular behaviour.

5.6 Possible application in understanding pathological foveation and vision in patients.

The data presented in this work indicate an involvement of the cerebellum in foveation. An optimal control of foveation is necessary for vision; even small deviation (0.5°) from the foveola (the central part of the fovea) can impair visual acuity (Jacobs, 1979). The effect of a non-optimal foveation on vision can be studied in patients suffering from central scotoma; central vision loss impairs common activity, including reading (Falkenberg et al., 2007; Whittaker and Kitchin, 1993), driving (Petzold and Plant, 2005), and face recognition (West et al., 2002). Interestingly, subjects with macular degeneration develop a new strategy for looking at objects, using always a certain portion of the retina (pseudo-fovea or preferred retinal locus PRL; Schuchard, 2005; Timberlake et al., 2005; Varsori et al. 2004). This process involves functional and cortical adaptation (Cheung and Legge, 2005); given the result of this study, the cerebellum could also be involved in modifying the foveation strategy.

There are, however, difficulties in comparing the data coming from the monkeys experiments described in this thesis with human pathological condition. Although several lesions in the cerebellum or in the brainstem lead to an impaired fixation, usually deficits regards gaze holding functions. When gaze holding structures are affected, pathological drifts (nystagmus) can be observed. These impairment did not occur in the described experiment. Instead, the described difficulty in centering the fovea on the target supports the hypothesis that a failure in the control of fixational saccades might be to origin of other fixation impairments like the opsoclonus or the macrosaccadic oscillations (Helmchen et al. 2003; Ramat et al. 2007; Selhorst et al. 1976). Indeed, while the nystagmus can be seen also (and sometime only) in the absence of a visual target, the so called saccadic intrusions are enhanced by attempted visual fixation. The centering tendency observed during visual fixation and the effect on the gain of fixational saccades could be, then, the

origin of those ocular dysfunctions observed in cerebellar patients. Nonetheless, it must be considered the fact that very focused lesions as the one temporarily induced in the monkey so far have not been observed in humans. Saccade disorders very similar to the ones due to fastigial inactivation, are reported after dorsolateral medullary infarction (Wallenberg's syndrome; Straube et al. 1994). It would be very interesting to test whether these subjects show deviations of gaze during fixation, i.e. if they use positions of the retina that are slightly more deviated from the foveola. Because the lesion provoked by the muscimol injection is only temporary, it would be also interesting to test whether any adaptation takes place after some time from the lesion.

5.7 Conclusions

In this thesis I have shown, by means a novel quantitative approach, that the oculomotor cerebellum regulates the amplitude of fixational saccades and adjusts the position toward which gaze is directed. This novel approach can be exploited to study visual fixation in normal and pathological condition in order to provide an insight on the dynamic of this behaviour.

The presence of a control system for fixational saccades would support the hypothesis, arising from neuronal recordings in the visual cortex (Leopold and Logothetis 1998; Martinez-Conde et al. 2002; Snodderly et al. 2001), of a physiological role of fixational saccades in vision (Martinez-Conde et al. 2004). Moreover, it has been shown that the retinal portion used for foveating a target is not hardwired with the photoreceptor distribution (Putnam et al. 2005). Given the general role of the cerebellum in motor learning (Ito 1984), the FORs could play a specific role in the learning phase of the foveating behavior, compensating for idiosyncratic differences in neuromuscular morphology and anisotropies in the mechanisms triggering and executing fixational saccades. Such an involvement in optimizing the acquisition of visual information from the fovea would support a recent theory on the function of the cerebellum (Bower J 1997). Future ontogenetical and

phylogenetical studies will link the development of this part of the medio-posterior cerebellum to the development of foveal fixation in the newborn baby (Slater and Bremner 1989) and across species (Martinez-Conde and Macknik 2008).

6. Summary

Foveate animals use saccades to explore the world. Even when required to look at a small visual target for a prolonged time (visual fixation), their eyes display tiny saccadic movements ($<1^\circ$), known in the literature as microsaccades or fixational saccades. Their origin and purpose is still under debate, and only few studies were aimed at searching the neuronal mechanisms underlying their generation.

In the thesis at hand, the contribution to visual fixation of the Fastigial Oculomotor Region (FOR) is investigated. This region, located in the caudal part of the medial cerebellar nuclei (Fastigial Nuclei), contributes to the generation of saccades. Lesions in this area render saccades less accurate.

With the aid of a novel analytical technique, the fixational behaviour before and after the unilateral pharmacological inactivation of the FOR in monkeys were compared. The developed method illustrates the influence of the initial position of the eyes on the direction of fixational saccades. By means of this technique it was possible to indentify a Motor Goal Area (MGA), whose centre is defined by the location where the probability of occurrence of a saccade direction (φ) equals that of a saccade in the opposite direction ($\varphi+180$ deg). The centre of the MGA roughly indicates the position toward which fixational saccades are directed.

The results show that, after the lesion, the eyes dwelled longer on positions which were horizontally shifted towards the site of the injection; therefore the target was foveated with a different portion of the retina. It was possible to show that two distinct components accounted independently for this alteration. Firstly, the inactivation induced an ipsilesional shift of the position toward which saccades were directed, as if a change in the encoding of the target position occurred. Secondly, it impaired the execution of fixational saccades in a way similar

to larger visually guided saccades: Their horizontal component was hypermetric (too large) when moving towards the lesion, hypometric (too small) in the other direction. The asymmetrical control of saccades determined in turn an asymmetrical distribution of dwell time around the new (ipsilesional shifted) MGA's centre, causing the eyes to dwell longer position that were ipsilesional with respect to it.

These results indicate that the cerebellum can influence the foveation of a target. The two different impairments can be explained with fastigial projections towards different subcortical regions involved in the generation of saccades. In particular, I propose that fixational saccades are generated by the fluctuating activity in the rostral poles of the Superior Colliculus (rSC) which is influenced by the FOR via fastigio-tectal projections. In addition, the FOR affects the execution of horizontal saccadic movements by means of projection to the pontine reticular formation, where the pre-motor saccadic burst neurons are located.

These results might be relevant in the study of oculomotor disorders, in particular in understanding the origin of saccadic intrusions during fixation. Future research should explore the parallel evolution of the fovea and of the cerebellar control of fixation.

7. Zusammenfassung

Tiere mit zentraler Sehgrube (Fovea Centralis) erkunden ihre Umwelt durch Sakkaden. Selbst bei längerer Betrachtung eines stationären Objekts (visuelle Fixation) treten winzige Sakkaden ($<1^\circ$) auf, die in der Literatur als Mikrosakkaden oder Fixationsakkaden bezeichnet werden. Der Ursprung und der Zweck der Mikrosakkaden ist bislang unklar, und nur wenige Studien haben die grundlegenden neuronalen Wirkungsmechanismen ihrer Generierung untersucht.

Hauptanliegen dieser Dissertation war es zu erforschen, welche Rolle die okulomotorische Region des Nucleus Fastigii (fastigial oculomotor region, FOR) bei der Fixation spielt. Die FOR ist in der Sakkadengenerierung involviert; bei Läsionen in dieser Region werden Sakkaden weniger präzise, eine Störung, die allgemein als Dysmetrie bekannt ist.

In der vorliegenden Arbeit Mittels einer neuen Analytiseverfahrens wird Fixationsmuster bei Rhesus Affen vor und nach temporärer pharmakologischer Inaktivierung einer der beiden FORs verglichen. Hierdurch kann der Einfluss der Augenanzfangsposition auf die Richtung der Mikrosaccaden gezeigt werden. Das Verfahren ermöglicht es einen motorischen Zielraum (motor goal area, MAG) zu bestimmen, dessen Zentrum die Position darstellt, von der aus die Auftretswahrscheinlichkeit einer Sakkadenrichtung gleich der um 180 Grad entgegengesetzten Richtung ist. Das Zentrum des MAG bezeichnet ungefähr die Position auf die Fixationsakkaden ausgerichtet sind.

Die Ergebnisse belegen, dass sich die Augen bei einseitiger FOR Inaktivierung für längere Zeiträume in ipsilateral verschobenen Positionen aushalten, und somit das Target mit einer anderen Bereich der Retina angeschaut wird. Zwei unabhängige Komponenten, die beide zur Änderung des Fixationsverhaltens beitragen, konnten analysiert werden. Zum einen wurde der motorische Zielraum von Mikrosakkaden ipsilateral relativ zur Läsionsseite horizontal verschoben, so als ob die Kodierung der Targetposition verändert worden wäre. Zum anderen war die Metrik von

Mikrosakkaden nach einseitiger FOR-Inaktivierung auf eine ähnliche Weise beeinflusst, wie das von großen, visuell gesteuerten Sakkaden bekannt ist: die horizontale Komponente der Bewegung wurde in die ipsilesionale Richtung hypermetrisch (zu groß), und in die Gegenrichtung hypometrisch (zu klein). Insgesamt führte die einseitige FOR-Inaktivierung zu einer asymmetrischen Sakkadenkontrolle, die die Augen in asymmetrischer Art und Weise um den (neuen und verschobenen) MGA umher wandern lässt. Infolgedessen waren die Augen im zeitlichen Mittel häufiger ipsilesional zum bereits ipsilesional verschobenen MAG ausgerichtet.

Diese Ergebnisse zeigen, dass die Art und Weise der Fixation eines visuellen Targets vom Kleinhirn beeinflusst wird. Die Unabhängigkeit der zwei beobachteten Beeinträchtigungen ist möglicherweise die Folge der Projektionen des Nucleus Fastigii in verschiedene sakkadenbezogene Hirnstammregionen. Eine wesentliche Ursache von Fixationsakkaden könnte in der zeitlichen Variation der Aktivität von Neuronen in den rostralen Polen des Colliculus Superior (rSC) liegen, die durch fastigiotektalen Projektionen beeinflusst wird. Außerdem beeinflusst die FOR die Sakkadengenerierung auch durch Projektionen an den premotorischen Sakkadenneuronen in der *Formatio Reticularis Pontis*.

Die Ergebnisse dieser Studie könnten für das Verständnis von okulomotorischen Störungen, insbesondere von sakkadischen Fixierungsstörungen, Relevanz haben. Nachfolgende Studien sollten die Bedeutung des Kleinhirns in der parallelen Entwicklung der Fovea und Fixationskontrolle untersuchen.

A. Appendix

A.1 List of abbreviations

List of Abbreviations

AP	Averaged Position	mr	Medial rectus
BAT	Broken Axis Technique	MST	Medial Superior Temporal area
CEF	Cingulate Eye Field	MT	Medial Temporal area
cFN	caudal Fastigial Nucleus	MVN	Medial Vestibular Nucleus
CSTD	Circular Standard Deviation	NI	Neuronal Integrator
CV	Circular Variance	NIC	Interstitial Nucleus of Cajal
DCN	Deep Cerebellar Nuclei	NPH	Nucleus Prepositus Hipoglossi
DLPC	Dorsolateral Prefrontal Cortex	NRTTP	Nucleus Reticularis Tegmenti Pontis
DLPN	Dorsolateral Pontine Nucleus	OKR	Optokinetic Reflex
EBN	Excitatory Burst Neuron	OPN	Omni-directional Pause Neurons
FEF	Frontal Eye Field	PEF	Parietal Eye Field
FL/VPFL	Flocculus/Ventral Paraflocculus	PN	Pontine Nuclei
FOR	Fastigial Oculomotor Area	PPC	Posterior Parietal Cortex
IBN	Inhibitory Burst Neuron	PPRF	Paramedian Pontine Reticular Formation
IML	Internal Medullary areal	RIMLF	Rostral Interstitial nucleus of the Medial Longitudinal Fasciculus
IO	Inferior Olive	RIP	nucleus Raphe Interpositus
io	Inferior oblique	rSC	rostral pole of the SC
Ir	Inferior rectus	SC	Superior Colliculus
LED	Light Emitting Diode	SEF	Supplementary Eye Field
LGN	Lateral Geniculate Nucleus	SNpr	Substantia Nigra pars reticulata
LIP	Lateral Intraparietal area	so	superior oblique
lr	lateral rectus	SPEM	Smooth Pursuit Eye Movement
medRF	medullary Reticular Formation	sr	superior rectus
MGA	Motor Goal Area	STN	Subthalamic nucleus
MN	Motor Nucleus	VN	Vestibular Nuclei
MP	Medial Parietal area	VOR	Vestibulo-ocular Reflex

A.2 Test of directional bimodality

As mentioned in the methods, a modified version of the Broken Axis Technique (BAT) was used to test the number of modes in the populations of directions. The BAT consists in finding the value α that multiplying each direction of the population, d_i , minimizes its directional variability (the circular variance, CV), therefore maximizing the mean amplitude:

$$AMP_{mean}(\alpha) = \frac{1}{n} \cdot \sqrt{\left(\sum_{i=1}^n \cos(\alpha \cdot d_i)\right)^2 + \left(\sum_{i=1}^n \sin(\alpha \cdot d_i)\right)^2}$$

The modification introduced is basically to rotate clockwise all the directions by the mean angle:

$$ANG_{mean} = \arctan^* \left(\frac{\sum_{i=1}^n \cos(d_i)}{\sum_{i=1}^n \sin(d_i)} \right)$$

so that ANG_{mean} becomes the reference (0°) angle. In this situation, the multiplication has different effects on different distributions of directions.

1. In a unimodal distribution, the directions are evenly distributed around the ANG_{mean} ; any multiplication would only increase the variance of the distribution; therefore, the maximum value of $AMP_{mean}(\alpha)$ is obtained for $\alpha = 1$. Noteworthy, this result is independent from the value of ANG_{mean} .
2. For symmetrical distributions (two or more modes equally spaced), the multiplication by the number of modes transforms all the directions so that their modes lie on the same angle,

thus reducing the CV. For instance, given a distribution with three equidistant modes at $1/6\pi$, $5/6\pi$ and $9/6\pi$ rad, multiplication by a factor $\alpha=3$ brings all the three modes to the same angle ($1/2\pi$).

3. For bimodal distribution where the modes are not symmetrical, the alignment of the two modes is obtained with the multiplication of directions by a factor $\alpha = 2 \cdot \pi / D$, where D is the arithmetical difference ($d_1 - d_2$, where $d_1 > d_2$) between the direction of the two modes (note that when $D = \pi$, that is the particular case of symmetrical distribution, $\alpha=2$ as discussed in the previous point). Considering the sectors formed by two modes, ANG_{mean} lays always in the smaller section of the two parts. Thus, if ANG_{mean} is the reference (0°) angle, the arithmetical difference between the two modes, D , is larger than π rad and α smaller than two. Clearly, the result depends on the change of reference (if ANG_{mean} is at π rad, the value will always be larger than 2); this characteristic is used for a better differentiation of uni- and bimodal distribution.

The BAT estimates the direction of the two modes from the value of α_{max} (Holmquist and Sandberg 1991); moreover, the statistic $AMP_{mean}(\alpha_{max})$ can be used to test the deviation from uniformity (critical values for rejecting the null hypothesis of uniform distribution can be found in Holmquist and Sandberg, 1991).

In summary, by a change of reference, the BAT allows defining the number of modes in the distribution of angles. The procedure for classifying the distribution can be summarized as follows. The Rayleigh test is first used to test uniformity. When it rejects the null hypothesis of uniform distribution ($p < 0.05$), the BAT (with ANG_{mean} and $ANG_{mean} + \pi$ rad as reference angles) is used to classify the underlying distribution as unimodal ($\alpha_{max} = 1$ with $ANG_{mean} + \pi$ rad as reference angle) or bimodal. When the Rayleigh test fails to reject the null hypothesis, then uniformity is tested again with the broken axis technique (the Rayleigh test can be negative also if the distribution is not uniform but symmetrical; the uniform test using the BAT is not sensitive to symmetries of the

distribution); if the BAT reveals a significant deviation from uniformity, α_{max} is used to classify the distribution as bimodal or multimodal ($\alpha_{max} > 2.5$). The power of the algorithm was tested with directions randomly selected from uniform, uni-, bi- and multimodal distributions (Table 2).

		Results (% of the simulations)			
$P(\alpha)$	n	UNI-DIRECTIONAL	BI-DIRECTIONAL	MULTI-DIRECTIONAL	UNIFORM
Unimodal $(1 + \cos(\alpha)) / 2\pi$	12	57.32%	7.91%	0.68%	34.09%
	24	81.71%	11.92%	0.04%	6.33%
	36	88.18%	11.22%	0%	0.60%
	48	89.07%	10.89%	0%	0.04%
Bimodal $(1 + \cos(2\alpha)) / 2\pi$	12	14.6%	27.86%	14.70%	69.21%
	24	0.19%	67.61%	0.93%	31.27%
	36	0.07%	89.28%	0.53%	10.12%
	48	0.01%	96.68%	0.31%	3.00%
Trimodal $(1 + \cos(3\alpha)) / 2\pi$	12	0.05%	4.27%	22.01%	73.67%
	24	0.13%	6.24%	56.47%	37.16%
	36	0.20%	6.17%	79.24%	14.39%
	48	0.15%	4.58%	90.16%	5.11%
Quadrimodal $(1 + \cos(4\alpha)) / 2\pi$	12	0%	0.74%	23.69%	75.57%
	24	0%	0.44%	59.33%	40.23%
	36	0%	0.32%	82.99%	16.69%
	48	0%	0.15%	93.50%	6.35%
Uniform $1 / 2\pi$	12	4.18%	2.85%	1.46%	91.51%
	24	3.90%	3.69%	1.08%	91.33%
	36	3.74%	4.40%	0.73%	91.13%
	48	3.48%	4.97%	0.44%	91.00%

Table 2: Efficiency of the method for classifying the number of modes of a distribution

A number n of directions was randomly extracted from known distributions with probability density function $P(\alpha)$, and the described method for classification was applied. Results indicate both the percentage of correct classification (bold characters) and, in case of error, how the distribution was labelled. Note that the result “uniform” indicates that the null hypothesis of uniform distribution could not be rejected. Not shown, results with $n = 96$, where all distribution were correctly detected with an error rate lower than 5%. Number of simulations for each distribution and for each n : 10000.

A.3 Graphical representation of directions

An algorithm was written to graphically display the statistical characteristics (using the algorithm described in the previous section) of the directions of saccades starting in neighboring area, as described in the method section (see also fig.4.4).

A **unimodal distribution** was represented by a vector starting from the centre of the bin used to gather the directions and directed as the median direction of the pooled saccades. A pair of vectors including 68% of direction values were also displayed. To compute these vectors, the 16th and 84th percentiles (P_{16} and P_{84}) were computed assigning successive values of P_i to directions adjacent to the median:

$$P_i = d_{median} \pm 100 \cdot i/N$$

where i is the number of directions below or above the median direction d_{median} , and N is the total number of angles in the sample. Intermediate percentiles were obtained by linear interpolation between each successive P_i .

Bimodal distributions were represented with two vectors directed as the two modes. If the number of samples was big enough (30), data were fitted with a bimodal von Mises distribution in order to obtain the central values (the two modes) and the respective dispersion around each of the two modes. The distribution is given by:

$$P(d|p, d1, d2, k1, k2) = p \cdot \{e^{k1 \cdot \cos(d - d1)} / [2\pi \cdot I_0(k1)]\} + (1-p) \cdot \{e^{k2 \cdot \cos(d - d2)} / [2\pi \cdot I_0(k2)]\}$$

where p is the mixture probability of two von Mises distributions having $k1$ and $k2$ as concentration parameters, $d1$ and $d2$ as location parameters (mean directions), and $I_0(k)$ is the modified Bessel function of order zero at point k . Each concentration parameter describes the dispersion of the directions around the respective mode, indicated by the location parameter. A maximum likelihood methods was used to identify the 5 parameters. The starting values of the location parameters were the directions of the two principal modes computed with the BAT. In order to avoid local minimum,

several combinations of starting values of $k1$, $k2$ and p were tested while the values of the location parameters were kept fixed.

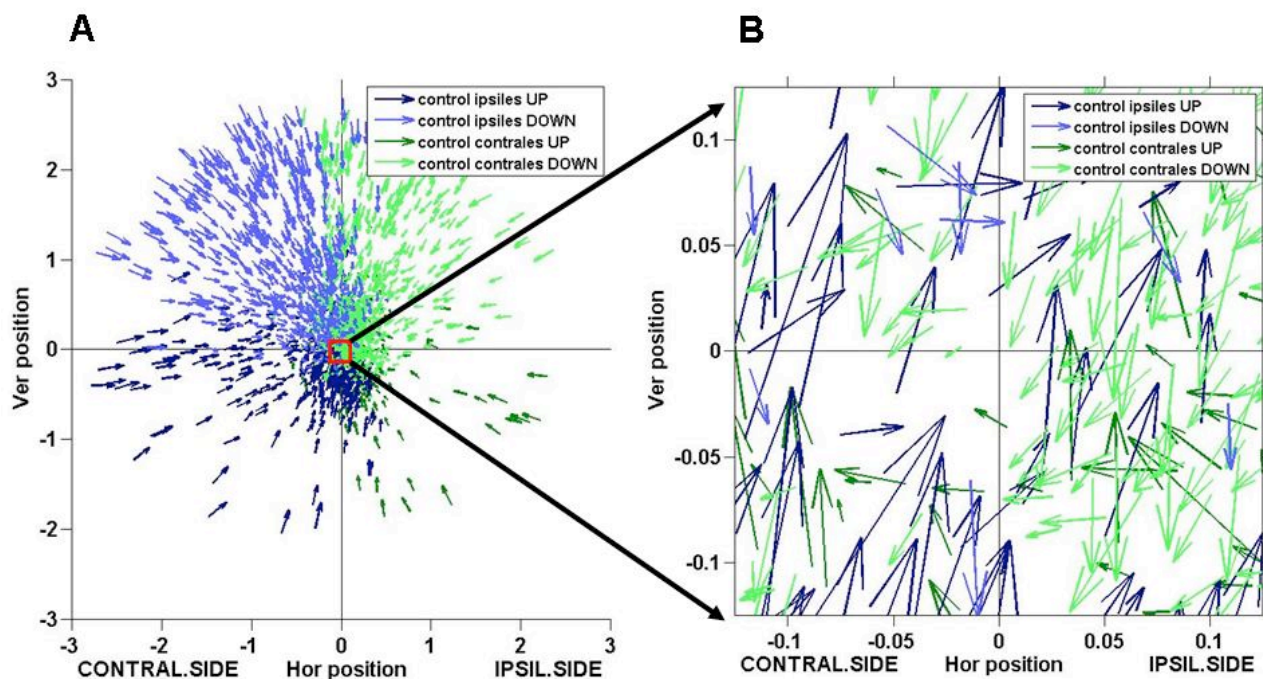
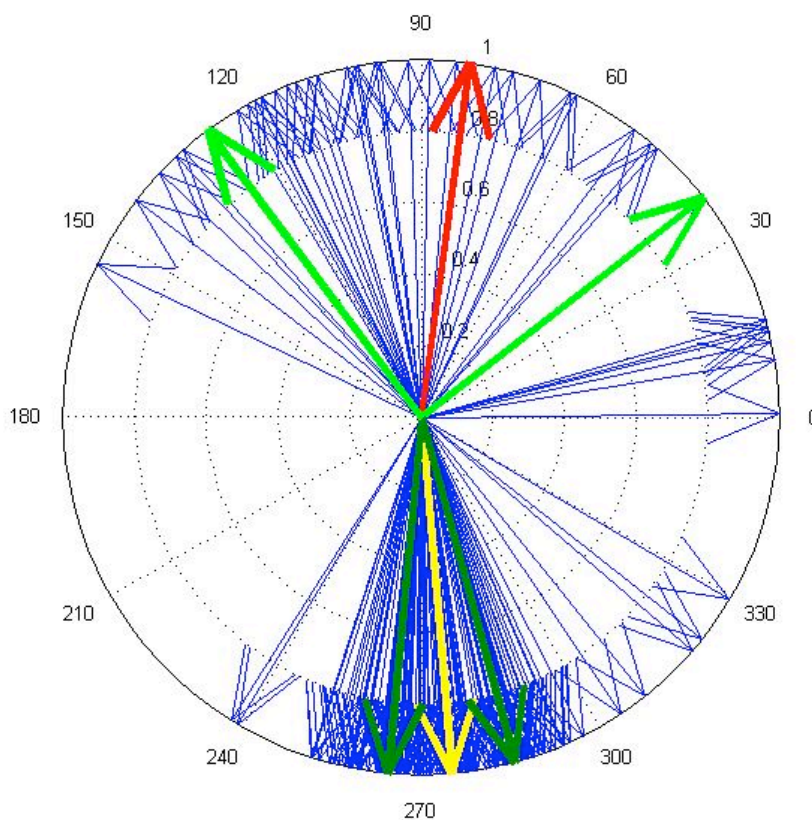

Figure A1: Graphical representation of directions.

Upper figures, panel A: Each saccade of a whole fixational trial is represented as a vector starting from the starting position of the saccade and having the same direction. The red square is the bin used to pool direction. Here the bin is centered in (0,0) and the pooled direction can be seen in the magnified **panel B**.

On the right: The pooled direction of each saccade are here represented each with a unitary vector. Being more than 30 directions, the model with of a bimodal Von Mises distribution is applied to compute the two modes (here in red and yellow) and the respective dispersion pair vectors (here in two different green tonality for the different mode).



More specifically, four values for each concentration parameter (linearly spaced between 1 and 50) and two values of p (0.5 and 0.75), making a total of $4 \times 4 \times 2 = 32$ combinations, were used to compute the logarithmic likelihood.

The best combination of parameters was then used as starting value set for the estimation of the 5 parameters. At the end of the estimation, the circular variance (CV) of each of the two distributions was calculated from the concentration parameters by:

$$CV = \left(\frac{I_1(k)}{I_0(k)} \right)^2$$

From the circular variance, a circular standard deviation ($CSTD$) can be computed (Fisher 1993):

$$CSTD = \sqrt{-2 * \ln(1 - CV)}$$

An example of the application of the whole technique is given in figure A1.

If the number of pooled directions was smaller than 30, then only the direction of the two modes computed with the BAT was displayed. If saccades did not display any directionality (because either uniformly or multi-modally distributed), a simple symbol indicated the result of the test of directionality.

B. List of References

- Abadi RV, Gowen E.** Characteristics of saccadic intrusions. *Vision Res* 44: 2675-2690, 2004.
- Abel LA, Schmidt D, Dell'Osso LF, Daroff RB.** Saccadic system plasticity in humans. *Ann Neurol* 4: 313-318, 1978.
- Adler F, Fliegelman F.** Influence of fixation on the visual acuity. *Arch.Ophthalmol.* 12: 475-483, 1934.
- Andersen RA, Snyder LH, Bradley DC, Xing J.** Multimodal representation of space in the posterior parietal cortex and its use in planning movements. *Annu Rev Neurosci* 20: 303-330, 1997.
- Bahill AT, Adler D, Stark L.** Most naturally occurring human saccades have magnitudes of 15 degrees or less. *Invest Ophthalmol* 14: 468-469, 1975.
- Bahill AT, Clark MR, Stark L.** The main sequence, a tool for studying human eye movements. *Math Biosci* 24: 191-204, 1975.
- Bair W, O'Keefe LP.** The influence of fixational eye movements on the response of neurons in area MT of the macaque. *Vis Neurosci* 15: 779-786, 1998.
- Barlow HB.** Eye movements during fixation. *J Physiol* 116: 290-306, 1952.
- Barton EJ, Nelson JS, Gandhi NJ, Sparks DL.** Effects of partial lidocaine inactivation of the paramedian pontine reticular formation on saccades of macaques. *J Neurophysiol* 90: 372-386, 2003.
- Bartz AE.** Fixation errors in eye movements to peripheral stimuli. *J.Exp.Psychol.* 75: 444-446, 1967.
- Becker W, Jürgens R.** An analysis of the saccadic system by means of double step stimuli. *Vision Res* 19: 967-983, 1979.
- Becker W.** Metrics. In: *Neurobiology of Saccadic Eye Movements*, edited by Wurtz B, Goldberg M: Elsevier(Amsterdam), 1989, p.13-61.
- Bennet-Clark HC.** The oculomotor response to small target replacements. *Opt Acta (Lond)* 11: 301-314, 1964.
- Bollen E, Bax J, van Dijk JG, Koning M, Bos JE, Kramer CG, van der Velde EA.** Variability of the main sequence. *Invest Ophthalmol Vis Sci* 34: 3700-3704, 1993.
- Bower J M.** Control of sensory data acquisition. *Int. Rev. Neurobiol.* 41: 489-513, 1997.
- Boyce PR.** Monocular fixation in human eye movement. *Proc R Soc Lond B Biol Sci* 167: 293-315, 1967.
- Bridgeman B, Palca J.** The role of microsaccades in high acuity observational tasks. *Vision Res* 20: 813-817, 1980.
- Brodal P.** The cortical projection to the nucleus reticularis tegmenti pontis in the rhesus monkey. *Exp Brain Res* 38: 19-27, 1980.
- Brodal P.** The projection from the nucleus reticularis tegmenti pontis to the cerebellum in the rhesus monkey. *Exp Brain Res* 38: 29-36, 1980.
- Bötzel K, Rottach K, Büttner U.** Normal and pathological saccadic dysmetria. *Brain* 116 (Pt 2): 337-353, 1993.
- Büttner U, Büttner-Ennever JA, Henn V.** Vertical eye movement related unit activity in the rostral mesencephalic reticular formation of the alert monkey. *Brain Res* 130: 239-252, 1977.
- Büttner U, Büttner-Ennever JA.** Present concepts of oculomotor organization. *Prog Brain Res* 151: 1-42, 2006, p.1-42.
- Büttner U, Straube A.** The effect of midline lesions on eye movements. *Neurophthalmology* 15: 75-82, 1995.
- Büttner-Ennever JA, Büttner U.** A cell group associated with vertical eye movements in the rostral mesencephalic reticular formation of the monkey. *Brain Res* 151: 31-47, 1978.
- Büttner-Ennever JA, Cohen B, Pause M, Fries W.** Raphe nucleus of the pons containing omnipause neurons of the oculomotor system in the monkey, and its homologue in man. *J Comp Neurol* 267: 307-321, 1988.

- Büttner-Ennever JA, Horn AKE.** Oculomotor system: a dual innervation of the eye muscles from the abducens, trochlear, and oculomotor nuclei. *Mov Disord* 17 Suppl 2: S2-3, 2002.
- Campbell FW, Wurtz RH.** Saccadic omission: why we do not see a grey-out during a saccadic eye movement. *Vision Res* 18: 1297-1303, 1978.
- Carpenter RHS.** Miniature movements. In: *Movements of the eyes*, edited by Carpenter RHS: Pion, London, 1988, p. 124-138.
- Castet E, Masson GS.** Motion perception during saccadic eye movements. *Nat Neurosci* 3: 177-183, 2000.
- Catz N, Thier P.** Neural control of saccadic eye movement. In: *Neuroophthalmology - Neuronal control of eye movements*, edited by Straube A, Büttner U: Karger (Basel), 2007.
- Cheung S, Legge GE.** Functional and cortical adaptations to central visual loss. *Vis Neurosci* 22: 187-201, 2005.
- Clowes M.** Some factors in brightness discrimination with constraint of retinal motion. *Optica Acta* 8: 81-91, 1961.
- Clowes MB.** A note on colour discrimination under conditions of retinal image constraint. *Optom Wkly* 9: 65-68, 1962.
- Cohen B, Komatsuzaki A, Bender MB.** Electrooculographic syndrome in monkeys after pontine reticular formation lesions. *Arch Neurol* 18: 78-92, 1968.
- Cohen B, Komatsuzaki A.** Eye movements induced by stimulation of the pontine reticular formation: evidence for integration in oculomotor pathways. *Exp Neurol* 36: 101-117, 1972.
- Collewijn H, Kowler E.** The significance of microsaccades for vision and oculomotor control. *J Vis* 8: 20.1-21, 2008.
- Corbetta M, Akbudak E, Conturo TE, Snyder AZ, Ollinger JM, Drury HA, Linenweber MR, Petersen SE, Raichle ME, Van Essen DC, Shulman GL.** A common network of functional areas for attention and eye movements. *Neuron* 21: 761-773, 1998.
- Cornsweet TN.** Determination of the stimuli for involuntary drifts and saccadic eye movements. *J Opt Soc Am* 46: 987-993, 1956.
- Crawford JD, Cadera W, Vilis T.** Generation of torsional and vertical eye position signals by the interstitial nucleus of Cajal. *Science* 252: 1551-1553, 1991.
- Crawford JD, Vilis T.** Symmetry of oculomotor burst neuron coordinates about Listing's plane. *J Neurophysiol* 68: 432-448, 1992.
- Cummings RW, Whittaker SG, Watson GR, Budd JM.** Scanning characters and reading with a central scotoma. *Am J Optom Physiol Opt* 62: 833-843, 1985.
- Curthoys IS, Markham CH, Furuya N.** Direct projection of pause neurons to nystagmus-related excitatory burst neurons in the cat pontine reticular formation. *Exp Neurol* 83: 414-422, 1984.
- Diamond MR, Ross J, Morrone MC.** Extraretinal control of saccadic suppression. *J Neurosci* 20: 3449-3455, 2000.
- Ditchburn RW, Fender DH, Mayne S.** Vision with controlled movements of the retinal image. *J Physiol* 145: 98-107, 1959.
- Ditchburn RW, Foley-Fisher JA.** The effect of retinal image motion on vision in coloured light. *Vision Res* 19: 1223-1227, 1979.
- Ditchburn RW, Ginsborg BL.** Vision with a stabilized retinal image. *Nature* 170: 36-37, 1952.
- Ditchburn RW, Ginsborg BL.** Involuntary eye movements during fixation. *J Physiol* 119: 1-17, 1953.
- Ditchburn RW.** The function of small saccades. *Vision Res* 20: 271-272, 1980.
- Dodge R.** Five types of eye movement in the horizontal meridian plane of the field of regard. *Journal of physiology* 8: 307-329, 1903.
- Eggert T.** Eye movements recordings: methods. In: *Neuro-Ophthalmology*, edited by Straube, A, Büttner, U: Dev Ophthalmol. Basel, Karger, 2007.
- Engbert R, Kliegl R.** Microsaccades uncover the orientation of covert attention. *Vision Res* 43: 1035-1045, 2003.

- Engbert R, Kliegl R.** Microsaccades keep the eyes' balance during fixation. *Psychol Sci* 15: 431-436, 2004.
- Engbert R.** Microsaccades: A microcosm for research on oculomotor control, attention, and visual perception. *Prog Brain Res* 154: 177-192, 2006.
- Epelboim J, Kowler E.** Slow control with eccentric targets: evidence against a position-corrective model. *Vision Res* 33: 361-380, 1993.
- Falkenberg HK, Rubin GS, Bex PJ.** Acuity, crowding, reading and fixation stability. *Vision Res* 47: 126-135, 2007.
- Fender DH.** Variation of fixation direction with colour of fixation target. *Br J Ophthalmol* 39: 294-297, 1955.
- Fender DH.** Torsional motions of the eyeball. *Br J Ophthalmol* 39: 65-72, 1955.
- Fischer B, Ramsperger E.** Human express saccades: effects of randomization and daily practice. *Exp Brain Res* 64: 569-578, 1986.
- Fisher NI.** Descriptive methods. In: *Statistical analysis of circular data*, edited by Cambridge University Press: Press syndicate of the University of Cambridge, 1993.
- Freedman EG, Sparks DL.** Eye-head coordination during head-unrestrained gaze shifts in rhesus monkeys. *J Neurophysiol* 77: 2328-2348, 1997.
- Fuchs AF, Kaneko CR, Scudder CA.** Brainstem control of saccadic eye movements. *Annu Rev Neurosci* 8: 307-337, 1985.
- Fuchs AF, Luschei ES.** The activity of single trochlear nerve fibers during eye movements in the alert monkey. *Exp Brain Res* 13: 78-89, 1971.
- Fuchs AF, Robinson FR, Straube A.** Role of the caudal fastigial nucleus in saccade generation. I. Neuronal discharge pattern. *J Neurophysiol* 70: 1723-1740, 1993.
- Fujikado T, Noda H.** Saccadic eye movements evoked by microstimulation of lobule VII of the cerebellar vermis of macaque monkeys. *J Physiol* 394: 573-594, 1987.
- Fukushima K, Kaneko CR, Fuchs AF.** The neuronal substrate of integration in the oculomotor system. *Prog Neurobiol* 39: 609-639, 1992.
- Gaarder K.** Relating a component of physiological nystagmus to visual display. *Science* 132: 471-472, 1960.
- Girard B, Berthoz A.** From brainstem to cortex: computational models of saccade generation circuitry. *Prog Neurobiol* 77: 215-251, 2005.
- Glasauer S.** Cerebellar contribution to saccades and gaze holding: a modeling approach. *Ann N Y Acad Sci* 1004: 206-219, 2003.
- Goffart L, Chen LL, Sparks DL.** Deficits in saccades and fixation during muscimol inactivation of the caudal fastigial nucleus in the rhesus monkey. *J Neurophysiol* 92: 3351-3367, 2004.
- Goffart L, Pélisson D.** Orienting gaze shifts during muscimol inactivation of caudal fastigial nucleus in the cat. I. Gaze dysmetria. *J Neurophysiol* 79: 1942-1958, 1998.
- Goffart L.** Saccadic eye movements. In: *Encyclopedia of Neuroscience*, edited by Squire LR: Oxford: Academic Press, 2009, volume 8, pp. 437-444.
- Gonzalo-Ruiz A, Leichnetz GR.** Afferents of the caudal fastigial nucleus in a New World monkey (*Cebus apella*). *Exp Brain Res* 80: 600-608, 1990.
- Gowen E, Abadi RV, Poliakoff E, Hansen PC, Miall RC.** Modulation of saccadic intrusions by exogenous and endogenous attention. *Brain Res* 1141: 154-167, 2007.
- Gowen E, Abadi RV, Poliakoff E.** Paying attention to saccadic intrusions. *Brain Res Cogn Brain Res* 25: 810-825, 2005.
- Haddad GM, Steinman RM.** The smallest voluntary saccade: implications for fixation. *Vision Res* 13: 1075-1086, 1973.
- Hafed ZM, Clark JJ.** Microsaccades as an overt measure of covert attention shifts. *Vision Res* 42: 2533-2545, 2002.
- Hafed ZM, Goffart L, Krauzlis RJ.** Superior colliculus inactivation causes stable offsets in eye position during tracking. *J Neurosci* 28: 8124-8137, 2008.

- Hafed ZM, Goffart L, Krauzlis RJ.** A neural mechanism for microsaccade generation in the primate superior colliculus. *Science* 323: 940-943, 2009.
- Hamstra SJ, Sinha T, Hallett PE.** The joint contributions of saccades and ocular drift to repeated ocular fixations. *Vision Res* 41: 1709-1721, 2001.
- Hanes DP, Wurtz RH.** Interaction of the frontal eye field and superior colliculus for saccade generation. *J Neurophysiol* 85: 804-815, 2001.
- Helmchen C, Rambold H, Sprenger A, Erdmann C, Binkofski F.** Cerebellar activation in opsoclonus: an fMRI study. *Neurology* 61: 412-415, 2003.
- Helmchen C, Straube A, Büttner U.** Saccade-related activity in the fastigial oculomotor region of the macaque monkey during spontaneous eye movements in light and darkness. *Exp Brain Res* 98: 474-482, 1994.
- Helmholtz H.** Handbuch der physiologischen Optik. In: *Allgemeine Encyclopädie der Physik*. Voss (Leipzig), 1867.
- Hirai T, Onodera S, Kawamura K.** Cerebellotectal projections studied in cats with horseradish peroxidase or tritiated amino acids axonal transport. *Exp Brain Res* 48: 1-12, 1982.
- Holmquist B, Sandberg R.** The Broken Axis Approach - A New Way to Analyze Bi-Directional Circular Data. *Experientia* 47: 845-851, 1991.
- Hyde JE.** Some characteristics of voluntary human ocular movements in the horizontal plane. *Am.J.Ophthal.* 48: 85-94, 1959.
- Ito M.** The modifiable neuronal network of the cerebellum. *Jpn J Physiol* 34: 781-792, 1984.
- Iwamoto Y, Yoshida K.** Saccadic dysmetria following inactivation of the primate fastigial oculomotor region. *Neurosci Lett* 325: 211-215, 2002.
- Jacobs RJ.** Visual resolution and contour interaction in the fovea and periphery. *Vision Res* 19: 1187-1195, 1979.
- Javal L.** Essai sur la physiologie de la lecture. *Annales d'oculistique* 82: 242-253, 1879.
- Johnston K, Everling S.** Neurophysiology and neuroanatomy of reflexive and voluntary saccades in non-human primates. *Brain Cogn* 68: 271-283, 2008.
- Jurin J.** Essay on distinct and indistinct vision. *Optics* : , 1738.
- Kagan I, Gur M, Snodderly DM.** Saccades and drifts differentially modulate neuronal activity in V1: effects of retinal image motion, position, and extraretinal influences. *J Vis* 8: 19.1-25, 2008.
- Kaneko CR.** Eye movement deficits after ibotenic acid lesions of the nucleus prepositus hypoglossi in monkeys. I. Saccades and fixation. *J Neurophysiol* 78: 1753-1768, 1997.
- Katoh YY, Arai R, Benedek G.** Bifurcating projections from the cerebellar fastigial neurons to the thalamic suprageniculate nucleus and to the superior colliculus. *Brain Res* 864: 308-311, 2000.
- Kaufman L, Richards W.** Spontaneous fixation tendencies for visual forms. *Perception & Psychophysics* 5: 85-88, 1969.
- King AJ.** The superior colliculus. *Curr Biol* 14: R335-8, 2004.
- Kleine JF, Guan Y, Büttner U.** Discharge properties of saccade-related neurons in the primate fastigial oculomotor region. *Ann NY Acad Sci* 1004: 252-261, 2003.
- Kleine JF, Guan Y, Büttner U.** Saccade-related neurons in the primate fastigial nucleus: what do they encode?. *J Neurophysiol* 90: 3137-3154, 2003.
- Kowler E, Steinman RM.** Small saccades serve no useful purpose: reply to a letter by R. W. Ditchburn. *Vision Res* 20: 273-276, 1980.
- Kowler E.** The stability of gaze and its implications for vision. In: *Eye Movements*, edited by Carpenter RHS: Macmillan Press(London), 1991.
- Krauskopf J, Cornsweet TN, Riggs LA.** Analysis of eye movements during monocular and binocular fixation. *J Opt Soc Am* 50: 572-578, 1960.
- Krauzlis RJ.** The control of voluntary eye movements: new perspectives. *Neuroscientist* 11: 124-137, 2005.
- Leigh D, Zee R.** *The Neurology of eye movements*. The Oxford University Press (New York), 2006, p. 598-718.

- Leigh DS, Zee RJ.** Diagnosis of nystagmus and saccadic intrusions. In: *The Neurology of Eye movements*. The Oxford University Press, New York, 2006, p. 475-558.
- Leigh RJ, Kennard C.** Using saccades as a research tool in the clinical neurosciences. *Brain* 127: 460-477, 2004.
- Leigh RJ, Rottach KG, Das VE.** Transforming sensory perceptions into motor commands: evidence from programming of eye movements. *Ann N Y Acad Sci* 835: 353-362, 1997.
- Leopold DA, Logothetis NK.** Microsaccades differentially modulate neural activity in the striate and extrastriate visual cortex. *Exp Brain Res* 123: 341-345, 1998.
- Lisberger SG, Fuchs AF, King WM, Evinger LC.** Effect of mean reaction time on saccadic responses to two-step stimuli with horizontal and vertical components. *Vision Res* 15: 1021-1025, 1975.
- Lord MP, Wright WD.** Eye movements during monocular fixation. *Nature* 162: 25, 1948.
- Lord MP.** Measurement of binocular eye movements of subjects in the sitting position. *Br J Ophthalmol* 35: 21-30, 1951.
- Luschei ES, Fuchs AF.** Activity of brain stem neurons during eye movements of alert monkeys. *J Neurophysiol* 35: 445-461, 1972.
- Martinez-Conde S, Macknik SL, Hubel DH.** Microsaccadic eye movements and firing of single cells in the striate cortex of macaque monkeys. *Nat Neurosci* 3: 251-258, 2000.
- Martinez-Conde S, Macknik SL, Hubel DH.** The function of bursts of spikes during visual fixation in the awake primate lateral geniculate nucleus and primary visual cortex. *Proc Natl Acad Sci U S A* 99: 13920-13925, 2002.
- Martinez-Conde S, Macknik SL, Hubel DH.** The role of fixational eye movements in visual perception. *Nat Rev Neurosci* 5: 229-240, 2004.
- Martinez-Conde S, Macknik SL, Troncoso XG, Dyar TA.** Microsaccades counteract visual fading during fixation. *Neuron* 49: 297-305, 2006.
- Martinez-Conde S, Macknik SL, Troncoso XG, Hubel DH.** Microsaccades: a neurophysiological analysis. *Trends Neurosci* 32: 463-475, 2009.
- Martinez-Conde S, Macknik SL.** Fixational eye movements across vertebrates: comparative dynamics, physiology, and perception. *J Vis* 8: 28.1-16, 2008.
- Marx E, Trendelenburg W.** Über die Genauigkeit der Einstellung des Auges beim Fixieren. *Z. Sinnesphysiol.* 45: 87-102, 1911.
- Maunsell JH, Van Essen DC.** Functional properties of neurons in middle temporal visual area of the macaque monkey. I. Selectivity for stimulus direction, speed, and orientation. *J Neurophysiol* 49: 1127-1147, 1983.
- May PJ, Hartwich-Young R, Nelson J, Sparks DL, Porter JD.** Cerebellotectal pathways in the macaque: implications for collicular generation of saccades. *Neuroscience* 36: 305-324, 1990.
- May PJ.** The mammalian superior colliculus: laminar structure and connections. *Prog Brain Res* 151: 321-378, 2006.
- McAllister C.** The fixation of points in the visual fields. *Psychol.Rev.Monogr.Supp.* 7: 1-17, 1905.
- Mohler CW, Wurtz RH.** Organization of monkey superior colliculus: intermediate layer cells discharging before eye movements. *J Neurophysiol* 39: 722-744, 1976.
- Morisita M, Yagi T.** The stability of human eye orientation during visual fixation and imagined fixation in three dimensions. *Auris Nasus Larynx* 28: 301-304, 2001.
- Morrone MC, Ross J, Burr DC.** Apparent position of visual targets during real and simulated saccadic eye movements. *J Neurosci* 17: 7941-7953, 1997.
- Moschovakis AK, Scudder CA, Highstein SM.** The microscopic anatomy and physiology of the mammalian saccadic system. *Prog Neurobiol* 50: 133-254, 1996.
- Murakami S, Noda H, Warabi T.** Converging eye movements evoked by microstimulation of the fastigial nucleus of macaque monkeys. *Neurosci Res* 10: 106-117, 1991.

- Murphy B, Haddad G, Steinman R.** Simple forms and fluctuations of the line of sight: Implication for motor theories of form processing. *Perception & Psychophysics* 16(3): 557-563, 1974.
- Møller F, Laursen M, Sjølie A.** Fixation topography in normal test persons. *Graefes Arch Clin Exp Ophthalmol* 244: 577-582, 2006.
- Møller F, Laursen ML, Sjølie AK.** The contribution of microsaccades and drifts in the maintenance of binocular steady fixation. *Graefes Arch Clin Exp Ophthalmol* 244: 465-471, 2006.
- Møller F, Laursen ML, Tygesen J, Sjølie AK.** Binocular quantification and characterization of microsaccades. *Graefes Arch Clin Exp Ophthalmol* 240: 765-770, 2002.
- Nachmias J.** Two-dimensional motion of the retinal image during monocular fixation. *J Opt Soc Am* 49: 901-908, 1959.
- Nachmias J.** Determiners of the drift of the eye during monocular fixation. *J Opt Soc Am* 51: 761-766, 1961.
- Noda H, Fujikado T.** Topography of the oculomotor area of the cerebellar vermis in macaques as determined by microstimulation. *J Neurophysiol* 58: 359-378, 1987.
- Noda H, Sugita S, Ikeda Y.** Afferent and efferent connections of the oculomotor region of the fastigial nucleus in the macaque monkey. *J Comp Neurol* 302: 330-348, 1990.
- Ohtsuka K, Noda H.** Saccadic burst neurons in the oculomotor region of the fastigial nucleus of macaque monkeys. *J Neurophysiol* 65: 1422-1434, 1991.
- Ohtsuka K, Sato H, Noda H.** Saccadic burst neurons in the fastigial nucleus are not involved in compensating for orbital nonlinearities. *J Neurophysiol* 71: 1976-1980, 1994.
- Optican LM, Robinson DA.** Cerebellar-dependent adaptive control of primate saccadic system. *J Neurophysiol* 44: 1058-1076, 1980.
- Otero-Millan J, Troncoso XG, Macknik SL, Serrano-Pedraza I, Martinez-Conde S.** Saccades and microsaccades during visual fixation, exploration, and search: foundations for a common saccadic generator. *J Vis* 8: 21.1-18, 2008.
- Ott D, Seidman SH, Leigh RJ.** The stability of human eye orientation during visual fixation. *Neurosci Lett* 142: 183-186, 1992.
- Perry VH, Cowey A.** The ganglion cell and cone distributions in the monkey's retina: implications for central magnification factors. *Vision Res* 25: 1795-1810, 1985.
- Petzold A, Plant GT.** Central and paracentral visual field defects and driving abilities. *Ophthalmologica* 219: 191-201, 2005.
- Putnam NM, Hofer HJ, Doble N, Chen L, Carroll J, Williams DR.** The locus of fixation and the foveal cone mosaic. *J Vis* 5: 632-639, 2005.
- Quinet J, Goffart L.** Saccade dysmetria in head-unrestrained gaze shifts after muscimol inactivation of the caudal fastigial nucleus in the monkey. *J Neurophysiol* 93: 2343-2349, 2005.
- Quinet J, Goffart L.** Head-unrestrained gaze shifts after muscimol injection in the caudal fastigial nucleus of the monkey. *J Neurophysiol* 98: 3269-3283, 2007.
- Quinet J, Goffart L.** Electrical microstimulation of the fastigial oculomotor region in the head-unrestrained monkey. *J Neurophysiol* 102: 320-336, 2009.
- Ramat S, Leigh RJ, Zee DS, Optican LM.** What clinical disorders tell us about the neural control of saccadic eye movements. *Brain* 130: 10-35, 2007.
- Ratliff F, Riggs LA.** Involuntary motions of the eye during monocular fixation. *J Exp Psychol* 40: 687-701, 1950.
- Ratliff F.** The role of physiological nystagmus in monocular acuity. *J Exp Psychol* 43: 163-172, 1952.
- Rattle JD.** Effect of target size on monocular fixation. *Opt Acta (Lond)* 16: 183-190, 1969.
- Rayner K.** Eye movements in reading and information processing: 20 years of research. *Psychol Bull* 124: 372-422, 1998.
- Riggs LA, Ratliff F, Cornsweet JC, Cornsweet TN.** The disappearance of steadily fixated visual test objects. *J Opt Soc Am* 43: 495-501, 1953.

- Ritchie L.** Effects of cerebellar lesions on saccadic eye movements. *J Neurophysiol* 39: 1246-1256, 1976.
- Robinson DA.** The mechanics of human saccadic eye movements. *J Physiol* 174: 245-264, 1964.
- Robinson DA.** Eye movements evoked by collicular stimulation in the alert monkey. *Vision Res* 12: 1795-1808, 1972.
- Robinson DA.** Control of eye movements. In: *Handbook of neurophysiology*, edited by Brooks V: Bethesda, 1981.
- Robinson FR, Fuchs AF.** The role of the cerebellum in voluntary eye movements. *Annu Rev Neurosci* 24: 981-1004, 2001.
- Robinson FR, Straube A, Fuchs AF.** Role of the caudal fastigial nucleus in saccade generation. II. Effects of muscimol inactivation. *J Neurophysiol* 70: 1741-1758, 1993.
- Rolfs M.** Microsaccades: small steps on a long way. *Vision Res* 49: 2415-2441, 2009.
- Ron S, Robinson DA.** Eye movements evoked by cerebellar stimulation in the alert monkey. *J Neurophysiol* 36: 1004-1022, 1973.
- Rucci M, Iovin R, Poletti M, Santini F.** Miniature eye movements enhance fine spatial detail. *Nature* 447: 851-854, 2007.
- Sansbury RV, Skavenski AA, Haddad GM, Steinman RM.** Normal fixation of eccentric targets. *J Opt Soc Am* 63: 612-614, 1973.
- Sato H, Noda H.** Divergent axon collaterals from fastigial oculomotor region to mesodiencephalic junction and paramedian pontine reticular formation in macaques. *Neurosci Res* 11: 41-54, 1991.
- Sato H, Noda H.** Saccadic dysmetria induced by transient functional decortication of the cerebellar vermis [corrected]. *Exp Brain Res* 88: 455-458, 1992.
- Schiller PH, True SD, Conway JL.** Deficits in eye movements following frontal eye-field and superior colliculus ablations. *J Neurophysiol* 44: 1175-1189, 1980.
- Schiller PH.** The discharge characteristics of single units in the oculomotor and abducens nuclei of the unanesthetized monkey. *Exp Brain Res* 10: 347-362, 1970.
- Schiller PH.** The central visual system. *Vision Res* 26: 1351-1386, 1986.
- Schuchard RA.** Preferred retinal loci and macular scotoma characteristics in patients with age-related macular degeneration. *Can J Ophthalmol* 40: 303-312, 2005.
- Scudder CA, Fuchs AF, Langer TP.** Characteristics and functional identification of saccadic inhibitory burst neurons in the alert monkey. *J Neurophysiol* 59: 1430-1454, 1988.
- Scudder CA, Kaneko CS, Fuchs AF.** The brainstem burst generator for saccadic eye movements: a modern synthesis. *Exp Brain Res* 142: 439-462, 2002.
- Scudder CA, Moschovakis AK, Karabelas AB, Highstein SM.** Anatomy and physiology of saccadic long-lead burst neurons recorded in the alert squirrel monkey. I. Descending projections from the mesencephalon. *J Neurophysiol* 76: 332-352, 1996.
- Selemon LD, Goldman-Rakic PS.** Common cortical and subcortical targets of the dorsolateral prefrontal and posterior parietal cortices in the rhesus monkey: evidence for a distributed neural network subserving spatially guided behavior. *J Neurosci* 8: 4049-4068, 1988.
- Selhorst JB, Stark L, Ochs AL, Hoyt WF.** Disorders in cerebellar ocular motor control. I. Saccadic overshoot dysmetria. An oculographic, control system and clinico-anatomical analysis. *Brain* 99: 497-508, 1976.
- Selhorst JB, Stark L, Ochs AL, Hoyt WF.** Disorders in cerebellar ocular motor control. II. Macrosaccadic oscillation. An oculographic, control system and clinico-anatomical analysis. *Brain* 99: 509-522, 1976.
- Shimazaki H, Shinomoto S.** A method for selecting the bin size of a time histogram. *Neural Comput* 19: 1503-1527, 2007.
- Skavenski AA, Hansen RM, Steinman RM, Winterson BJ.** Quality of retinal image stabilization during small natural and artificial body rotations in man. *Vision Res* 19: 675-683, 1979.
- Skavenski AA, Robinson DA, Steinman RM, Timberlake GT.** Miniature eye movements of fixation in rhesus monkey. *Vision Res* 15: 1269-1273, 1975.

- Skavenski AA, Steinman RM.** Control of eye position in the dark. *Vision Res* 10: 193-203, 1970.
- Slater A, Bremner B.** Infant development. In: , edited by : LEA, Hove, 1989.
- Snodderly DM, Kagan I, Gur M.** Selective activation of visual cortex neurons by fixational eye movements: implications for neural coding. *Vis Neurosci* 18: 259-277, 2001.
- Snodderly DM, Kurtz D.** Eye position during fixation tasks: comparison of macaque and human. *Vision Res* 25: 83-98, 1985.
- Sparks DL, Barton EJ, Gandhi NJ, Nelson J.** Studies of the role of the paramedian pontine reticular formation in the control of head-restrained and head-unrestrained gaze shifts. *Ann N Y Acad Sci* 956: 85-98, 2002.
- Sparks DL, Holland R, Guthrie BL.** Size and distribution of movement fields in the monkey superior colliculus. *Brain Res* 113: 21-34, 1976.
- Sparks DL.** Conceptual issues related to the role of the superior colliculus in the control of gaze. *Curr Opin Neurobiol* 9: 698-707, 1999.
- Sparks DL.** The brainstem control of saccadic eye movements. *Nat Rev Neurosci* 3: 952-964, 2002.
- St Cyr GJ, Fender DH.** The interplay of drifts and flicks in binocular fixation. *Vision Res* 9: 245-265, 1969.
- Steinman R.** The effect of size, luminance and color on monocular fixation. *J. Opt.Soc. Am.* 55: 1158-1165, 1965.
- Steinman RM, Cunitz RJ, Timberlake GT, Herman M.** Voluntary control of microsaccades during maintained monocular fixation. *Science* 155: 1577-1579, 1967.
- Steinman RM, Haddad GM, Skavenski AA, Wyman D.** Miniature eye movement. *Science* 181: 810-819, 1973.
- Straube A, Helmchen C, Robinson F, Fuchs A, Büttner U.** Saccadic dysmetria is similar in patients with a lateral medullary lesion and in monkeys with a lesion of the deep cerebellar nucleus. *J Vestib Res* 4: 327-333, 1994.
- Sugimoto T, Mizuno N, Uchida K.** Distribution of cerebellar fiber terminals in the midbrain visuomotor areas: an autoradiographic study in the cat. *Brain Res* 238: 353-370, 1982.
- Sylvestre PA, Cullen KE.** Quantitative analysis of abducens neuron discharge dynamics during saccadic and slow eye movements. *J Neurophysiol* 82: 2612-2632, 1999.
- Thier P, Dicke PW, Haas R, Barash S.** Encoding of movement time by populations of cerebellar Purkinje cells. *Nature* 405: 72-76, 2000.
- Thier P, Dicke PW, Haas R, Thielert C, Catz N.** The role of the oculomotor vermis in the control of saccadic eye movements. *Ann N Y Acad Sci* 978: 50-62, 2002.
- Timberlake GT, Sharma MK, Grose SA, Gobert DV, Gauch JM, Maino JH.** Retinal location of the preferred retinal locus relative to the fovea in scanning laser ophthalmoscope images. *Optom Vis Sci* 82: 177-185, 2005.
- Timberlake GT, Wyman D, Skavenski AA, Steinman RM.** The oculomotor error signal in the fovea. *Vision Res* 12: 1059-1064, 1972.
- Van Beers RJ.** The sources of variability in saccadic eye movements. *J Neurosci* 27: 8757-8770, 2007
- Van Gisbergen JA, Robinson DA, Gielen S.** A quantitative analysis of generation of saccadic eye movements by burst neurons. *J Neurophysiol* 45: 417-442, 1981.
- Varsori M, Perez-Fornos A, Safran AB, Whatham AR.** Development of a viewing strategy during adaptation to an artificial central scotoma. *Vision Res* 44: 2691-2705, 2004.
- Vilis T, Hore J.** Characteristics of saccadic dysmetria in monkeys during reversible lesions of medial cerebellar nuclei. *J Neurophysiol* 46: 828-838, 1981.
- Wade N, Tatler B.** The Origins of Modern Eye Movement Research. In: *The Moving Tablet of the Eye*, edited by : Oxford University Press, USA , 2005.
- West SK, Rubin GS, Broman AT, Muñoz B, Bandeen-Roche K, Turano K.** How does visual impairment affect performance on tasks of everyday life? The SEE Project. Salisbury Eye Evaluation. *Arch Ophthalmol* 120: 774-780, 2002.

- Westheimer G.** Eye movement responses to a horizontally moving visual stimulus. *AMA Arch Ophthalmol* 52: 932-941, 1954.
- Wheless LLJ, Boynton RM, Cohen GH.** Eye-movement responses to step and pulse-step stimuli. *J Opt Soc Am* 56: 956-960, 1966.
- Whittacker SG, Lovie-Kitchin J.** Visual requirements for reading. *Optom Vis Sci* 70: 54-65, 1993.
- Wikler KC, Williams RW, Rakic P.** Photoreceptor mosaic: number and distribution of rods and cones in the rhesus monkey retina. *J Comp Neurol* 297: 499-508, 1990.
- Winterson BJ, Collewijn H.** Microsaccades during finely guided visuomotor tasks. *Vision Res* 16: 1387-1390, 1976.
- Wyman D, Steinman RM.** Letter: Latency characteristics of small saccades. *Vision Res* 13: 2173-2175, 1973.
- Yamada J, Noda H.** Afferent and efferent connections of the oculomotor cerebellar vermis in the macaque monkey. *J Comp Neurol* 265: 224-241, 1987.
- Yarbus A.** *Eye movements and vision*. New York, Plenum Press, 1967, p. 103-128.
- Zuber BL, Stark L.** Microsaccades and the velocity-amplitude relationship for saccadic eye movements. *Science* 150: 1459-1460, 1965.

C. Acknowledgement

"Io ritornai da la santissima onda
rifatto sì come piante novelle
rinovellate di novella fronda,
puro e disposto a salire a le stelle."

[Dante, Purgatorio, canto XXXIII]

In the first place, I'd like to thank Prof. Dr. Ulrich Büttner, for giving me the chance of such a beautiful and enrichable experience. Thank you for trusting me, and supporting my research even in the somewhat confused and unclear times.

I owe much to many people in the lab of Munich, for partaking of experiences and problems, and for making the time spent at the computer more enjoyable; to thank one for all, I wish to express my gratitude to Dr. Thomas Eggert. Beside having shared many lunches and non-academical discussions, his constructive criticisms forced me to be as much rigorous and logical in my reasoning as a scientist should be.

I am grateful also to many people in the charming Marseille, for their hospitality, cordiality and the good time spent "à la Plage", barbequing or playing football.

I fear there are no words good enough to give thanks to Dr. Laurent Goffart; only who is a great man, besides a great scientist, can be a master both in science and life. Thank you for your enthusiasm, for the encouragement and for all the good suggestions; working with you was a great honour.

I wish to thank all my friends, especially those who are near though they are far; and I do not forget the support of my beautiful Family, which always looks at me with love, and that I love back. The last lines are for Olympia; your Name comes at last, but was already written in each and any page of these last years and I wish it will be there until the last chapter.

LG