



Durham E-Theses

The comparative syntax of Albanian : on the contribution of syntactic types to propositional interpretation.

Kallulli, Dalina

How to cite:

Kallulli, Dalina (1999) *The comparative syntax of Albanian : on the contribution of syntactic types to propositional interpretation.*, Durham theses, Durham University. Available at Durham E-Theses Online: <http://etheses.dur.ac.uk/1466/>

Use policy

The full-text may be used and/or reproduced, and given to third parties in any format or medium, without prior permission or charge, for personal research or study, educational, or not-for-profit purposes provided that:

- a full bibliographic reference is made to the original source
- a [link](#) is made to the metadata record in Durham E-Theses
- the full-text is not changed in any way

The full-text must not be sold in any format or medium without the formal permission of the copyright holders.

Please consult the [full Durham E-Theses policy](#) for further details.

Academic Support Office, Durham University, University Office, Old Elvet, Durham DH1 3HP
e-mail: e-theses.admin@dur.ac.uk Tel: +44 0191 334 6107
<http://etheses.dur.ac.uk>

The Comparative Syntax of Albanian: On the Contribution of Syntactic Types to Propositional Interpretation

Dalina Kallulli

1999

The copyright of this thesis rests with the author. No quotation from it should be published without the written consent of the author and information derived from it should be acknowledged.

A thesis submitted to the University of Durham

for the degree of Doctor of Philosophy



17 JAN 2000

Department of Linguistics and English Language

Contents

Chapter 1	
Introduction	8
Chapter 2	
The Effects of Direct Object Clitic Doubling on Propositional Interpretation in Albanian and Greek	13
2.0. Introduction.....	13
2.1. Preliminaries: An Overview of Clitic Doubling Patterns in Albanian and Greek.....	15
2.2. The Non-optionality of Direct Object Clitic Doubling	24
2.2.1. Justifying [-Focus]	25
2.2.2. Focus, Wh-elements and Clitic Doubling	27
2.2.3. Focus Particles: More [+Focus] Phrases and Their Interaction With Doubling.....	32
2.2.4. Clausal Complements and Clitic Doubling: Triggering Factivity	37
2.2.5. Summary	41
2.3. Issues of Representation	42
2.3.1. Spec-head Licensing, Feature-checking and Doubling.....	42
2.3.2. Parallels with Germanic Scrambling.....	45
2.3.3. Word Order Variations, Clitic Doubling and the Structure of the Clause	52
2.3.3.1. VP-internal Scrambling and Direct Object Clitic Doubling ..	52
2.3.3.2. Clause Initial Direct Objects and Doubling	55
2.3.3.3. Clitic Left Dislocation and Information Structure	57
2.3.4. Asymmetries in Clitic Doubling Patterns: the Case of Restrictive Relative Clauses	60
2.3.5. Speculations on Clitic Doubling of Direct Object <i>Which</i> -phrases.....	72
2.4. Conclusion.....	76
Chapter 3	
Semantic Evaluations of the Syntax of Noun Phrases	77
3.0. Introduction	77
3.1. Count Bare Singulars: The Basics	78
3.2. Why Bare Singulars Can't Be Doubled: The Proposal	80
3.3. The Distribution of Bare Singulars in Differing Grammatical Relations.....	83
3.4. The Meaning of Bare Singulars.....	97
3.4.1. Properties vs. Individuals	97
3.4.2. Specificity, Individuation, Argumenthood.....	99
3.4.3. A Note on Definite Expressions and Why Enç (1991) Can't Be Right.....	106
3.4.4. Bare Singulars Are Predicates: Syntactic Evidence.....	110
3.4.5. A Note on Principle C Violations in English	112
3.4.6. Bare Singular "Subjects" are Predicates	114
3.4.7. Semantic Incorporation and the Formalization of Bare Singulars	118
3.4.8. Section Summary	126

3.5. Adjectival Modification, the Relation of Adjectives to the D-position and the Structure of the Albanian DP	127
3.6. NPs, DPs and their Interaction with Phrase Structure Positions	138
3.7. On the Relation of Bare Singulars to Bare Plurals	145
3.7.1. Vagaries of “Reference”: More on Generic vs. Existential Bare Plurals	146
3.7.2. Bare Singulars, Existential Bare Plurals and Event Reference	152
3.7.3. Erroneous Subjects and Stipulations on the Bi-clausal Structure of Cleft Constructions.....	161
3.7.5. Section Summary	166
3.8. Conclusion	167
Chapter 4	
Non-active Morphology in Albanian and Event (De)composition	168
4.0. Introduction	168
4.1. Non-active Morphology: A First Look at the Problems.....	169
4.2. Previous Analyses: Massey (1991).....	185
4.3. Two Kinds of Causation	187
4.4. The Distribution of the Stative, the Generic-Potential, the Suddenly and the Accidental Causation Reading	189
4.4.1. Aspectual Properties of the Predicate.....	189
4.4.2. VP-external Operators and the Distribution of the Accidental Reading	191
4.5. Defining Non-active Morphology	194
4.5.1. The Syntax of Events and Event Composition (Pustejovsky 1991)....	195
4.5.2. Non-active Morphology and Event Decomposition	197
4.6. Deriving the Stative Reading	198
4.6.1. Type-shifting an activity verb into a stative verb.....	198
4.6.2. Stative Verbs and the Potential(ity) Reading	200
4.7. Deriving the Suddenly Reading.....	202
4.7.1. The Event Structure of Causatives	203
4.7.2. Decomposing Causatives	205
4.8. Deriving Non-active Causation	206
4.9. Conclusion	210
References.....	210

Declaration

No portion of the work referred to in this thesis has been submitted in support of an application for another degree or qualification of this or any other university or other institution of learning.

The copyright of this thesis rests with the author. No quotation from it should be published without her prior written consent and information derived from it should be acknowledged.

Abstract

This dissertation is a comparative study of the syntax of Albanian within the *Principles and Parameters* framework. Its main focus is on the existence of a systematic relationship between syntactic structure and propositional interpretation.

The thesis starts with an investigation of the effects of direct object clitic doubling in Albanian and Greek on propositional interpretation. Crucially, I argue that direct object doubling clitics in these languages are operators that license topichood.

Detailed semantic evaluations of the syntax of noun phrases are presented. In particular, it is argued that semantic interpretations for noun phrases, while fundamentally dependent on their internal structure, are to a large extent also dependent on the phrase structure positions in which they are initially projected. A comprehensive discussion of count bare singular noun phrases in Balkan and Mainland Scandinavian languages is undertaken, which sheds new light on a number of issues concerning syntactic and semantic asymmetries of terms in differing grammatical relations, phrase structure and clausal positions, as well as on the contribution of nominal constituent types to event reference and more generally to compositional semantics.

Finally, the dissertation examines the effects of non-active morphology in Albanian on propositional interpretation. I argue that non-active morphology is an operation that affects the lexical meaning of a predicate by changing either the aspectual template associated with it or the pairing of a name (a constant) with the aspectual template of a predicate.

Acknowledgements

I am very happy to be able to take this opportunity to express my gratitude to a number of people who over the past few years have shared my life, have kept me motivated and have helped me reach the finishing line of this dissertation.

Three people have played a major role in my linguistic formation. Lars Hellan and Tor Åfarli were my first teachers of generative linguistics; I thank them for having given me a little bit of their soul in teaching me linguistics and for their ongoing support also after I left Norway and moved to Britain to do a PhD. Joe Emonds, my thesis supervisor in the Department of Linguistics at the University of Durham, taught me what was good science and what was not. I am indebted to him for his patience with me, for his open-mindedness and friendship. His detailed comments on several drafts have to my mind significantly improved the outcome. His insight and advice on various matters also beyond linguistics have been rather valuable to me.

Many other people have in various ways contributed to the completion of this work. The enormous help of Bonnie Schwartz and the support of Mike Davenport were crucial in making it possible for me to study in Durham. I am grateful to Bill McClure for his encouragement. I appreciate the classes and discussions with Maggie Tallerman and the Syntax 3 teams. My fellow students and friends Andrew Caink, Ute Bohnacker, Isa Muxi, Xiao-Ling Hu, Roger Maylor, Seiki Ayano, Kyoko Oga provided moral support and created a rather agreeable working environment. I thank Bonnie Schwartz and Martha Young-Scholten for keeping their doors open for me and the rest of the people in the Department of Linguistics in Durham for the good times I had there. I also thank the ORS committee for the overseas fees award in the years

1995-1998 and the University of Durham for the three-year grant that helped me keep warm and well-fed.

I am grateful to Guglielmo Cinque, Anna Cardinaletti, Pino Longobardi and Giuliana Giusti for the interest in my work and in Albanian syntax as well as for the warm welcome in Venice where I took up a 3-month scholarship from the University of Venice that Memo had helped me obtain.

Much of the material in this dissertation was presented at conferences and workshops too many to list. I have benefitted from the remarks of the audiences at such events. I would like to single out Maria-Luisa Rivero for her interest in my work, for her encouragement and very useful comments and for her kindness.

I am indebted to Antonia Androutsopoulou for her indispensable help with the Greek data and for theoretical discussions.

I thank Martin Prinzhorn for having welcomed me to the linguistic milieu in Vienna, which also enriched my social life. I also thank my non-linguistic friends in Vienna, especially Karen and (cousin) Ardian for their interest, love and friendship, which I treasure.

Finally, I must thank Georg and my family who have given me so much warmth, love and support over the years. Georg I thank also for his invaluable help with the German data, for technical help and for his proof-reading of the thesis.

Chapter 1

Introduction

This dissertation is a study of the relationship between syntactic structure and propositional interpretation in Albanian. Specifically, the thesis investigates the effects of direct object clitic doubling and of non-active morphology on propositional interpretation. In addition, it explores the syntax and semantics of nominal constituent types.

Within the theory of Universal Grammar, syntactic constituents are made up of smaller constituents and may combine with other constituents to compose yet others. That is, syntactic relations are hierarchical and compositional. Within the *Principles and Parameters* framework, it is generally assumed that initial syntactic relations reflect semantic relations and that the various languages differ from each other in the way they instantiate these semantic relations or features morphologically. On the assumption that semantics is compositional, that is, the meaning of an expression is a function of the meaning of its parts (cf. Frege 1891), it follows that propositional interpretation is determined by the semantics of the syntactic constituents that it consists of.

Chapter 2 of this thesis examines the effects of direct object clitic doubling in Albanian and Greek on propositional interpretation. I argue that direct object clitic doubling in Albanian and Greek unequivocally marks direct object DPs as [-Focus],

which in analogy with the [+Focus] feature on phrases (cf. Chomsky (1972), Jackendoff (1972), Horvath (1986), Rochemont (1986), Brody (1990), *i.a.*), is in this dissertation defined as an operator feature.

Chapter 2 also includes a discussion of scrambling in Germanic. I argue that scrambling in Germanic is an operation that yields the same effect as direct object clitic doubling in Albanian and Greek. Consequently, clitic doubling and scrambling of direct object DPs do not induce specificity, presuppositionality and/or strength, as has been claimed for doubling in Romance (cf. Sportiche (1992), Uriagareka (1995), *i.a.*) and Greek (cf. Anagnostopoulou 1994) or for scrambling in German/Dutch (cf. Diesing (1992), de Hoop (1992), Sportiche (1992)). I argue instead (in chapter 3) that the locus of specificity/presuppositionality/strength is the D-position (cf. Abney 1987), which for noun phrases underlies argumenthood (cf. Longobardi 1994). In addition, I show that in apparent cases of optional doubling/scrambling, there is in fact no optionality, irrespective of the [\pm definite] status of the doubled/scrambled DP.

In chapter 2, I also deal with issues of syntactic representation. In particular, I discuss how the view that direct object clitic doubling and scrambling mark the DPs they double as unambiguously [-Focus] may be implemented successfully within the minimalist framework (cf. Chomsky 1995) by preserving Sportiche's (1992) basic assumption that clitics head their own maximal projections as well as the clitic parameters which he establishes. Other issues that are discussed in this chapter concern the structure of restrictive relative clauses and an account of certain asymmetries of direct object clitic doubling in restrictive relative clauses, as well as the structure of clitic left dislocated constructions.

Chapter 3 presents semantic evaluations of the syntax of noun phrases. On the assumption that a given syntactic construction cannot be systematically ambiguous,

my basic working hypothesis is that semantic interpretations for noun phrases are fundamentally dependent on their internal structure. Crucially, I justify with new evidence Longobardi's (1994) claim that only DPs but not NPs may function as syntactic arguments. In addition, I claim that NPs, on the other hand, invariably translate as predicates at LF. Consequently, they do not translate as variables or restricted quantifiers. These claims are prompted by evidence gathered from investigating count bare singular noun phrases, as found notably across Balkan and Mainland Scandinavian languages but, though more sporadically, also in Romance and other Germanic languages, as well as bare plurals across Germanic, Romance and Balkan languages.

Count bare singulars have a predicate-modifying and hence non-specific interpretation which is strongly reminiscent of the type of semantics associated with noun incorporation structures (cf. Bittner (1994), van Geenhoven (1996) *i.a.*); they are property-denoting expressions. Indeed the thesis argues that the distinction specific vs. non-specific (cf. Ioup (1977), Fodor & Sag (1982), Enç (1991) *i.a.*) only makes sense in terms of a distinction between individual denotation vs. property denotation. That is, specific readings arise when noun phrases denote individuals and non-specific readings arise when noun phrases denote properties. Since count bare singulars may occur as direct objects, and given that the direct object position is acknowledged as a major argument position (cf. Longobardi 1994), the view that count bare singulars denote properties leads to the idea that many (though not all) natural language predicates may take both individuals or properties as their internal argument (cf. also Zimmermann 1993). The so-called event-related reading of propositions containing count bare singular or existential bare plural objects is associated precisely with their function as predicates, not as arguments.

A variety of facts converge in showing that, syntactically, count bare singulars and existential bare plurals are *not* DPs with a morphologically null D, but NPs altogether lacking a syntactic D-projection. In other words, I propose that the semantic distinction between generic and existential bare plurals is due to a difference in their internal structure.

Importantly, this chapter argues that clitics carry a D-feature, which is why they may double only DPs, not NPs, and that specificity, presuppositionality or strength related effects often attributed to clitic constructions are only epiphenomenal, straightforwardly derived through the need to feature-match. Here, I depart from the view that an NP is exclusively a complement of D (cf. Abney 1987) and more generally from the recent Chomskyan implication that once a functional projection is available at least within a given language, it is always present/syntactically active in that language even though at times it may be inert/morphologically empty. This does not entail, however, that there are no DPs with morphologically null Ds.

Although the work presented in chapter 3 follows the tradition of Longobardi (1994) and Zamparelli (1996) in that at least some fundamental aspects of the interpretation of noun phrases depend on their internal structure, another of its main goals is to show how differences regarding the distribution of DPs and NPs relate to initial phrase structure positions, the structure of the clause and the semantics associated with certain positions in it.

Chapter 4 presents a detailed study of non-active morphology in Albanian and its effects on propositional interpretation. Since non-active morphology in this language subsumes passive, the thesis ultimately presents an analysis of passivization. It makes the following claim: Non-active morphology is an operation that operates on the lexical meaning of a predicate by changing either the aspectual template associated

with it or the pairing of a name (a constant) with the aspectual template of a predicate. That is, non-active morphology, including passive, is *not* an operation that solely affects the number of arguments in the argument structure of a predicate without affecting its lexical meaning, contrary to Levin & Rappoport Hovav (1995). I show that the range of readings that non-active morphology in Albanian yields can be formally and uniformly derived under the proposal that non-active morphology operates on the lexical semantic frames of verbs, not on their lexical syntactic frames. More specifically, I claim that non-active morphology is an operation that operates on the event structure of verbs (cf. Pustejovsky 1991). The detailed proposal is formulated as follows: When non-active morphology is affixed to a predicate, it shifts the event type associated with the predicate into a lower event type by suppressing either the initial subevent or the name (the constant) that is associated with this initial subevent. Since the notion of agent is related precisely with this initial subevent (cf. Davis & Demirdache 1995), non-active morphology *de facto* suppresses agenthood.

Chapter 2

The Effects of Direct Object Clitic

Doubling on Propositional

Interpretation in Albanian and Greek

2.0. Introduction

A pervasive phenomenon in Albanian, like in the other languages of the Balkans, is that of clitic doubling. This chapter investigates the effects of direct object clitic doubling in Albanian on propositional interpretation. This is done from a comparative perspective. In particular, clitic doubling of direct objects in Albanian is compared to clitic doubling of direct objects in another Balkan language, namely, Greek. This undertaking is motivated by the need to gain deeper insight into the nature of clitic doubling constructions, and in turn contributes to the general question of why clitic doubling appears at all.

Doubling constructions are by their nature strongly reminiscent of object agreement constructions. Yet, there are essential differences between the two that beg for explanation. The Albanian and Greek patterns confirm the idea that in spite of certain similarities between clitic doubling and object agreement phenomena (cf. Anderson 1996), the two cannot be equated. For instance, unlike object agreement

markers, direct object clitics in Albanian and Greek have restricted distribution and operator-like properties. It will be shown that the factors that determine clitic doubling of direct object DPs in both languages are by and large identical and can be captured by a uniform syntactic analysis. Crucially, I argue that direct object clitics in both languages unequivocally mark the DPs they double as [-Focus], which in analogy with the [+Focus] feature on phrases (cf. Jackendoff (1972), Horvath (1986), Rochemont (1986), Brody (1990), *i.a.*), will be defined as a syntactic feature on phrases interpretable at both the LF and PF interfaces. Consequently, clitic doubling of direct object DPs does not induce specificity on these DPs, as has been claimed for Romance (cf. Sportiche (1992), Uriagareka (1995), *i.a.*). The view that direct object clitics in Albanian and Greek mark the DPs they double as unambiguously [-Focus] may be implemented successfully within the minimalist framework (cf. Chomsky 1995) by preserving Sportiche's (op.cit.) basic assumption that clitics head their own maximal projections and that direct object clitics in particular are heads with operator-like properties.

This chapter is organized as follows. I start out in section 1 by outlining and scrutinizing the general properties of Albanian and Greek clitic doubling. This is motivated by the need to comprehend the factors that are important for the so-called *Clitic Doubling Parameter*. In section 2 the interaction of focus with doubling is discussed. Finally, section 3 deals with matters of representation. In this section I also investigate the parallels between doubling constructions in Albanian and Greek and scrambling constructions in Germanic. In addition, I discuss in some detail the structure of restrictive relative clauses in Albanian and Greek. This is needed in order to account for certain asymmetries in the distribution of direct object clitic doubling that are observed in restrictive relative clauses.

2.1. Preliminaries: An Overview of Clitic Doubling Patterns in Albanian and Greek

Albanian and Greek are so-called free word order, null subject languages with rich morphology. Both languages have identical case systems, except for the fact that the Greek counterpart of the Albanian dative is genitive. That is, both Albanian and Greek have distinct morphological nominative and accusative case, but while Albanian has dative case, Greek only has genitive case.¹ Both languages have object pronominal clitics with distinct morphological inflections for accusative and dative/genitive cases; both lack subject clitics. In Greek, clitics follow only gerunds and imperatives. In Albanian they may precede, follow or be infixes in imperatives only. Like in French, clitics in both languages immediately precede all other verb forms both in matrix and embedded clauses.² The relative order of clitics is rigidly fixed for all combinations of person(s): Dative/genitive followed by accusative. Clitic climbing is absent, as are infinitives which have historically been supplanted by the subjunctive form.³

Perhaps the most striking property of Albanian and Greek clitic doubling is the fact that it violates what is sometimes referred to as “Kayne’s generalization” which, informally stated, says that clitic doubling is possible whenever a noun phrase can get

¹ This means that Greek conflates two cases: genitive and dative. The situation is slightly more complicated in Albanian, where genitive is identical with dative except for the fact that the Albanian genitive is invariably preceded by an agreement morpheme which is more closely discussed in chapter 3 (section 3.5).

² For a detailed description of the positioning of clitics in several types of clauses in Albanian and Greek, see Joseph and Philippaki-Warbuton (1987), Rivero (1994), Rivero and Terzi (1994), Kallulli (1995).

³ For an analysis as to why clitic climbing is absent across all Balkan languages, see Terzi (1992).

case by means of some non-verbal device which has case-assigning properties, namely, prepositions.⁴ The Albanian and Greek examples below show that doubled DPs are not preceded by prepositions.⁵ In fact, prepositional objects may not be clitic doubled in Greek (cf. Anagnostopoulou 1994); for Albanian, the question does not even arise, as (direct or indirect) object arguments may not be instantiated by prepositional phrases in this language.

In Albanian, dative DPs are invariably clitic doubled. In (1a) this applies to a definite expression, in (1b,c) to an indefinite expression, in (1d) to a *wh*-dative, in (1e) to a quantified dative. The opposition (1b) vs. (1c) shows that dative clitic doubling is insensitive to so-called ‘VP-internal scrambling of objects’ (cf. Massey 1991).

- (1) a. Ev-a *(i) dërgoi An-ës lule.
 Ev-the her_{cl} sent An-the_{dat}flowers
 ‘Ev sent Ann flowers.’

⁴ In this context, cf. also Suñer (1988: 399-400) who provides the following examples from Portefiño Spanish as empirical evidence against viewing the prepositional element *a* in Spanish, a language where Kayne’s generalization seems to be generally operative, as a case assigning device; she argues instead that *a* is an animacy marker, which is why it is missing in the examples below even though the direct object DPs here are clitic doubled.

- i) Yo lo voy a comprar el diario justo antes de subir.
 I am going to buy **it-the newspaper** just before coming up
- ii) Yo la tenía prevista esta muerte.
 I had foreseen **it-this death**
- iii) Ahora tiene que seguir usondolo el apellido.
 Now she has to go on using **it-the surname**.

⁵ On the significance of violations of Kayne’s generalization for the Clitic Doubling Parameter, cf. Anagnostopoulou (1994).

- b. Ben-i *(i) dërgoi një vajze lule.
 Ben-the her_{cl} sent a girl_{dat} flowers
 ‘Ben sent a girl flowers.’
- c. Ben-i *(i) dërgoi lule një vajze.
 Ben-the her_{cl} sent flowers a girl_{dat}
 ‘Ben sent a girl flowers.’
- d. Kujt *(i) foli mësues-i?
 who_{dat} him/her_{cl} talked teacher-the
 ‘Who did the teacher talk to?’
- e. Ben-i *(u) blen gjithë vajza-ve(t) lule.
 Ben-the them_{cl} buys all girls-dat(the) flowers
 ‘Ben buys all (the) girls flowers.’

Both in Albanian and Greek, quirky subjects are invariably clitic doubled when marked for either dative/genitive or accusative case. Examples are given in (2) and (3).

- (2) a. Al: Jan-it *(i) mungojnë dhjetë libra.⁶
 Jan-the_{dat} him_{cl,dat} miss-they ten books_{nom}
- b. Gr: Tu Yanni *(tu) lípun dheka vivlia.
 the Yannis_{gen} him_{cl,gen} miss-they ten books_{nom}
 ‘John is missing ten books.’

⁶ Throughout this dissertation I use the symbols Al, Gr, Dt, Nl, No, as abbreviations for Albanian, Greek, German, Dutch, and Norwegian, respectively.

- (3) a. Al: Ben-in *(e) mërzit vetmia.
 Ben-the_{acc} him_{cl,acc} bores solitude_{nom}
 ‘Solitude bores Ben.’
- b. Gr: Ton Yánni *(ton) ponái to kefáli tu.
 the Yánnis_{acc} him_{cl,acc} hurts the head_{nom} his
 ‘Yannis has a headache.’

The examples in (4) instantiate clitic doubling of direct object DPs.⁷

- (4) a. Al: E pashë Jan-in.⁸
 b. Gr: Ton idha ton Jani.
 him_{cl} saw-I the Janis
 ‘I did see John.’

As indicated by the English translation, (4a,b) cannot mean: ‘I saw John’ (uttered as out-of-the-blue sentences or as sentences in which either the whole VP or the direct object DP is focussed), which would be their meaning in the absence of the doubling clitic. As such, (4a,b) are not felicitous answers to a question like: ‘Who did you see?’, which they would be in the absence of the doubling clitic. In other words, clitic

⁷ Albanian and Greek are pro-drop, null-subject languages and nothing stops clitics from appearing sentence initially.

⁸ In Albanian the definite article is suffixed to the noun stem (indicated by the use of hyphens in the Albanian examples); in Greek, like in English, it is a separate phonological entity and precedes the noun stem.

doubling of direct object DPs in Albanian and Greek is not an optional phenomenon, strictly speaking. For the moment, let us just note this fact in passing; I will resume the discussion in detail in the next section.

The examples in (5) show that unlike doubling in Romance, doubling of direct objects in Albanian and Greek is not restricted to [+animate] or [+human] DPs.⁹ Nor is it restricted to [+definite] DPs.

- (5) a. Al: Do t-a pija me kënaqësi një uiski.
 fut-it_{cl} drink with pleasure a whisky
- b. Gr: To pino exfaristos ena ouiskáki.
 it_{cl} drink with pleasure a whisky
 ‘I would gladly drink a whisky.’

It has been claimed for Greek that clitic doubling of direct object DPs is subject to *definiteness*, in the sense that only definite DPs may be clitic doubled (cf. Anagnostopoulou 1994).¹⁰ The example in (5b) (from Kazasis and Pentheroudakis (1976)) is then a counterexample to this claim since the doubled DP here is clearly indefinite.¹¹ This counterexample is in fact acknowledged by Anagnostopoulou who writes:

⁹ For instance, doubling is sensitive to the feature *human* in Rumanian and *animacy* in Spanish (cf. Jaeggli (1986), Borer (1984), Dobrovie-Sorin (1990)). But cf. footnote 4.

¹⁰ Note, however, that the implication is only one way: Definite direct object DPs may be doubled but need not be. As not all definites can be clitic doubled in Greek (cf. e.g. (9b), (10b)), Anagnostopoulou tries to relate direct object clitic doubling in this language to Heim's (1982) *Familiarity Condition*. However, this analysis is untenable in the face of doubling of indefinites unless Heim's crucial claim that all indefinites represent novel information is rejected.

¹¹ Cf. also Agouraki (1993) who provides several other examples of doubling of indefinites.

“At first sight, sentences like [5b] seem to contradict the view that Modern Greek doubling is subject to definiteness... Utterances like [5b] have a clear modal reading, the verbal form used is subject to various aspectual restrictions (imperfective aspect is systematically chosen: this type of aspect is typical of conditionals) and the clitics in them seem to have a kind of “sentential” function... These constructions are extremely interesting because the function of the clitics in them is not clear. However, they are, in many respects, different from the doubling constructions of the type examined here and, from this point of view, beyond the scope of the present discussion... The fact that the adverbial elements ... must be heavily stressed and that they typically precede the doubled DPs seems to indicate that structures like [5b] are right dislocations. Furthermore, note that examples of this type are only possible in “ordering-contexts” where ... it is quite common to use attributive-definites instead of indefinites.” (Anagnostopoulou 1994:4, footnote 5)

Let me point out several inaccurate claims in the quote. First, doubled indefinite DPs need not occur in constructions where the verb has imperfective aspect; the Greek example in (6) contains perfective aspect form. Secondly, adverbial elements do not necessarily precede the indefinite DPs, as (6) also shows. Thirdly, (6) shows that doubling of indefinite DPs is possible outside of “ordering-contexts”.¹² Even if examples as in (5b) were only possible in ordering-contexts, where it is claimed to be common to use attributive definites instead of indefinites, doubling should still be unexpected for Anagnostopoulou who claims that attributive definites, as a subclass of novel definites, may not be clitic doubled in Greek.¹³

¹² Here “ordering-context” stands for a context which involves ordering (e.g. of food, drinks, etc.).

¹³ Anagnostopoulou's claim that attributive definites may not be clitic doubled in Greek is not uncontroversial, though. In this context, according to Anagnostopoulou (1994), while clitics necessarily license familiarity on the direct object DPs they double, these DPs may be either novel or familiar if not doubled. This is clearly imperfect, as clitic doubling emerges under her treatment not only as a totally optional but also as an entirely redundant phenomenon if clitics may double definite DPs which can be non-novel/familiar even when not doubled.

- (6) Akoma ke i Anna katafere na to ekdhosi ena vivlio prin na pethani.
 still and the Anna managed to it_{cl} publish a book before to die
 ‘Even Anna managed to publish a book before she died.’

Finally, I reject the idea that indefinite DPs may be clitic doubled only when they are right dislocated, as has been claimed by Anagnostopoulou for Modern Greek. The main argument against the view that clitic doubled indefinites are exclusively right dislocated phrases comes from the fact that just like clitic doubled definite DPs, they may occur in both languages in positions that are typically associated with theta marking and case marking, that is, in A-positions, such as ECM complements and subjects of small clauses, as in (7) and (8), respectively.¹⁴

- (7)a. Al: Jan-i e pret një gjë të tillë të ndodhë.
 Jan-the it_{cl} expects a thing such to happen
- b. Gr: O Yannis to perimeni kati tetio na simvi.
 the John it_{cl} expects something such to happen
 ‘John expects something like this to happen.’
- c. Al: Jan-i e pret Mer-in të ankohet.
 Jan-the her_{cl} expects Mary-the_{acc} to complain
- d. Gr: O Yannis tin perimeni tin Maria na paraponethi.
 the John her_{cl} expects [the Mary]_{acc} to complain
 ‘John expects Mary to complain.’

¹⁴ An additional argument against the right dislocation hypothesis is presented in section 2.3.

(8)a. Al: Jan-i nuk e konsideron një vajzë të tillë/Mer-in inteligjente.

Jan-the not her_{cl} consider a girl such/Mary-the_{acc} intelligent

b. Gr: O Yannis dhen tin teori kamja tetia kopela/tin Maria eksipni.

the John not her_{cl} consider no such girl/[the Mary]_{acc} intelligent

‘John does not consider any such girl/Mary intelligent.’

It is thus my contention that clitic doubling constructions of indefinites as in (5b) do not differ from the doubling constructions involving doubling of definite direct object DPs other than with respect to the definiteness feature, which is irrelevant. The factors that determine clitic doubling of direct object DPs are the same irrespective of the [\pm definite] status of these DPs. In this way clitic doubling of direct object DPs emerges as a uniform phenomenon and should be treated as such.

The fact that both definite and indefinite direct object DPs may be doubled does not mean that they always can be. The data in (9) show that even definite DPs cannot invariably be doubled.

(9)A: Do you walk to school or do you take the bus?

B: a. Al: Nuk shkoj në këmbë, (*e) marr autobus-in.

b. Gr: Dhen pigheno me ta podhja, (*to) perno to leoforio.

not walk with feet, it_{cl} take the bus

‘I don't walk, I take the bus (to school).’

The fact that the definite DPs in these examples cannot be doubled is problematic for the specificity/presuppositionality/familiarity/d-linking/strength approaches to doubling (cf. Sportiche (1992), Anagnostopoulou (1994), Uriagareka (1995)), if we

assume with Enç (1991) and Diesing (1992) that all definites are specific/presuppositional/strong. While the claim that all definites are specific will be challenged (cf. section 3.4.3), there are indisputably specific/presuppositional/strong definites (and indefinites) that need not and/or cannot be doubled. The example in (10) is a case in point.

(10) A: What happened?

B: a. Al: Jan-i (#i) hëngri fasule-t/ (#e) piu një birra.

b. Gr: O Janis (#ta) éfaye ta fasólia/ (#tin) ipje mia bira.

the Janis them_{cl} ate the beans/ her_{cl} drank a beer_{fem}

‘Janis ate the beans/drank a beer.’

Finally, *referentiality* of the doubled DP is also irrelevant for direct object clitic doubling in Albanian and Greek. This is indicated by the fact that quantified expressions may also be doubled, as in (11).¹⁵ Note that doubling in Albanian and Greek does not suppress the attributive reading of definite DPs; the doubled DP in (12) may receive both a referential and a non-referential/attributive interpretation.¹⁶

¹⁵ However, clitic doubling in Albanian and Greek is incompatible with focus DPs, as will become clear in section 2.2. According to the view that any constituent that can be raised by QR can serve as focus (cf. Chomsky 1976), quantifiers in general are default foci. In (11) I have tried to control this factor by focussing the verb. This is indicated in the English translation by the use of capital letters. The interaction of clitic doubling and focussing will be discussed at length in section 2.2.

¹⁶ Anagnostopoulou (1994) claims that doubled DPs in Greek may only receive a referential interpretation. A. Androutopoulou (p.c.), however, points out to me that the doubled DP in (12b) *can* receive an attributive interpretation (for instance, when the verb is focussed).

- (11) a. Al: An-a i urrente të gjithë djem-të.
 b. Gr: I Anna ta misuse ola ta aghorja.
 the Ann them_{cl} HATED all the boys
 ‘Anna HATED all the boys.’

- (12) a. Al: I dua mace-t e vogla.
 them_{cl} LOVE cats-the small
 b. Gr: Tis aghapo tis mikres (tis) ghatas.
 them_{cl} LOVE the small (the) cats
 ‘I LOVE small cats.’

Having seen now that clitic doubling of direct object DPs in Albanian and Greek cannot be adequately described in terms of any of the features highlighted so far by various theorists as significant for the Clitic Doubling Parameter, let me turn to the identification of the factors which I claim determine direct object clitic doubling in Albanian and Greek.

2.2. The Non-optionality of Direct Object Clitic Doubling

A variety of facts converge in showing that clitic doubling of direct object DPs¹⁷ systematically yields ungrammaticality when these DPs are focussed or part of the focus domain, that is, when they are marked [+Focus]. In this section, I show that

¹⁷ Except where indicated otherwise, I will only be concerned with doubling of direct objects, not of accusative quirky subjects.

clitic doubling of direct object DPs in Albanian and Greek unambiguously marks these DPs [-Focus], which will be interpreted as an operator feature.

2.2.1. Justifying [-Focus]

In defining the feature [-Focus], I will proceed indirectly by defining the notion *focus* first.

Informally speaking, *focus* is viewed as the most informative part of an utterance. Hence, a definition of *focus* is sensitive to the speech act and varies according to it. For instance, the notion *information* or *information structure* for a question does not make sense unless one defines information structure as the type of answer one expects (cf. Sperber and Wilson 1988). So, for *wh*-questions, *focus* is the variable represented by the *wh*-element; this also holds for *echo*-questions (cf. Horvath 1986). For a *yes-no* question *focus* is either the assertion (i.e. the given polarity), or the negation (i.e. the opposite polarity).

Focus can also be an element which is contrasted. Finally, *focus* can be the item that fills in a slot in an information structure where other slots have already been filled. In this latter function, *focus* is close to the notion 'new information'. On the whole, the definitions above are quasi-collectively reflected in the following quote from Vallduví (1994: 575): "... *focus*, an informative, news-bearing, dominant, or contrary-to-expectation part...".¹⁸ The complement of *focus* is *topic* (cf. also Erteschik-Shir 1998). Following a long-established tradition in generative grammar, I assume that *focus* is a syntactic feature on phrases interpretable at both the LF and the

¹⁸ For details on the formalization of *focus* (i.e. its formal representation in lambda reduced intensional logic), see Jacobs (1986), Rooth (1996), Krifka (1996).

PF interfaces as [+Focus] (cf. Chomsky (1972), Jackendoff (1972), Rochemont (1986), Horvath (1986), Brody (1990)).

In view of the fact that a sentence may lack a topic (e.g. out-of-the-blue sentences) but will always have a focus, I assume that the [+Focus] feature is in fact the unmarked value in a markedness theory for natural language and that the [-[+Focus]] (or simply [-Focus]) feature is the marked value. Derivational syntax in terms of checking theory (cf. Chomsky 1995) then renders this feature significant. In other words, topics need to be licensed. I will argue that clitic doubling is one of the means by which this feature gets licensed.

Let me illustrate. Consider the examples in (13).

- (13) a. Al: An-a lexoi libr-in.
b. Gr:I Ana dhiavase to vivlio.
the Ana read the book
'Ann read the book.'

The undoubled Albanian example (13a) is a felicitous answer to either (14a) or to (14b), but not to (14c) or (14d).

- (14) a. What did Ana do?
b. What did Ana read?
c. Who read the book?
d. What did Ana do to/with the book?

The Greek example (13b) may be a felicitous answer to any of the questions under (14). However, (15b), the doubled version of (13b), is preferred as an answer to (14c) and (14d) also in Greek. Crucially, (15a) and (15b), the clitic doubled versions of respectively (13a) and (13b), may in both languages only be a felicitous reply to (14c,d) but not to (14a,b). This latter fact suggests that direct object clitic doubling in Albanian and Greek is incompatible with direct object DPs that are marked [+Focus] (alternatively: are contained in focus domains).

(15) a. Al: An-a e lexoi libr-in.

b. Gr:I Ana to dhiavase to vivlio.

the Ana *it_{cl}* read the book

‘Ann did read the book.’ or: ‘It was Ann who read the book.’

I devote the next two sections to a brief review of some recent ideas on the syntactic encoding of focus and on how focus interacts with clitic doubling of direct object DPs in Albanian and Greek.

2.2.2. Focus, Wh-elements and Clitic Doubling

Following Horvath (1988), Brody (1990) assumes that just like there is a feature +*wh*, which marks phrases as +*wh*-elements, there is a feature +*f* that indicates focushood;¹⁹ root +*wh*-phrases are argued to be necessarily [+*f*] and the conditions on +*wh* and

¹⁹ Brody claims that the S-structure presence of the +*f* feature shows up as heavy stress at PF. According to him, the stressed +*f*-marked category is not necessarily the same as the +*f*-phrase, but the +*f*-phrase will always contain a +*f*-marked element. While he doesn't define the notion of 'heavy stress', I take it to be phonetic prominence, probably indicated by a pitch accent. Unlike Brody, I wish to leave open the possibility that focus may have other PF correlates even if phonetic prominence/pitch accent is absent.

(+WH) root CPs are generalized to the +*f* and *F(ocus) P(hrase)* so that they will entail (16), which may be regarded as a Focus Criterion. The implication is that Rizzi's (1991) *Wh*-criterion is a subcase of the Focus Criterion and that the Spec of (a root) CP is one of the canonical positions for focus.

(16) (Brody 1990: 208)

- a. At S-structure and LF the Spec of an FP must contain a +*f*-phrase
- b. At LF all +*f*-phrases must be in an FP.

Just as the corresponding notion on +*WH* CPs is parametrized, it is assumed that (16a) may or may not hold in a given language. (16b), on the other hand, like the condition on +*wh*-elements, should be universal. Further, a distinction is drawn between + and - *WH* FPs.

The distinction between root and non-root CPs is important to note here. I am not contending that every Spec of any CP node has a [+*f*] feature, but that the Spec of a root CP does. In other words, I am drawing a parallelism between question formation and (at least some instances of) focus licensing; *wh*-question formation in English and many other languages cannot obtain unless the *wh*-question phrase is moved to Spec of the root CP. A direct consequence of this view is that *wh*-phrases in embedded clauses (e.g. relative clauses) are not marked [+*f*].²⁰ The distinction between root and non-root CPs will become particularly important for the discussion in section 2.3.4, where asymmetries of clitic doubling relativized direct object DPs are explored.

²⁰ At first sight, indirect questions might appear as a counterexample to the claim that Spec of a non-root CP is devoid of a [+*f*] feature. However, it could be argued that the question feature (and hence also the [+*f*] feature associated with it) in an indirect question is licensed in the specifier position of the root CP at LF. Consequently, non-overt movement is involved.

If my claim is correct that direct object clitics license non-focussing of the DPs they double and if we assume with Brody (1990) that *+wh*-elements that by LF occupy Spec of the root CP are necessarily foci, then clitic doubling of *+wh* direct object DPs in Albanian and Greek root clauses is bound to yield ungrammaticality. The examples under (17) show that this is indeed the case.²¹

- (17) a. Al: Kë/çfarë (*e) pe?
 [who/what]_{acc} it/him/her_{cl} saw-you
- b. Gr: Pjon/ti (*ton/to) idhes?
 [who/what]_{acc} him/it_{cl} saw-you
 ‘Who/what did you see?’

Significantly, direct object DPs in Albanian are obligatorily clitic doubled in constructions with *+wh*-subjects, as well as in yes-no questions, as shown in (18) and (19), respectively. Similar facts are reported for Greek by Agouraki (1993), who notes that in questions, either yes-no or *wh*-questions, a doubling clitic is strongly preferred.

²¹ However, DO *which*-phrases can be clitic doubled, as the example in (i) shows.

(i) Al: Cil-ët libra (i) solli Ana?
 which-the books (them_{cl}) brought Ana
 ‘Which books did Anna bring?’

For the moment, suffice it to mention that constructions containing clitic doubled DO *which*-phrases are semantically different from their undoubled counterparts. I will argue that these interpretative differences are related to structural differences. More specifically, I suggest that constructions involving clitic doubled DO *which*-phrases involve concealed relative clauses and, in particular, that the position that clitic doubled DO *which*-phrases occupy is different from the position that their undoubled counterparts occupy. Since relative clauses and certain asymmetries concerning clitic doubling of direct object DPs in restrictive relative clauses are dealt with at length in section 2.3.4, I postpone the discussion of doubled DO *which*-phrases to section 2.3.5. For the moment, let us simply assume that doubling of DO *which*-phrases does not constitute a counterexample to the claim that *wh*-elements in root clauses cannot be doubled.

These facts confirm the hypothesis that clitic doubling exempts direct object DPs from focus domains (that is, from phrases that are marked [+Focus]).

(18) a. Al: Kush *(e) pa fëmijë-n?

b. Gr: Pjos (to) idhe to pedhí?

who it_{cl} saw the child

‘Who has seen the child?’

(19) a. Al: (A) *(e) pe Jan-in?

[+Q]²² him_{cl} saw Jan-the

b. Gr: (Ton) idhes ton Jani? (Agouraki 1993: 170)

him_{cl} saw the Jani

‘Have you seen John?’

At this point, it should be clear that direct object clitic doubling is somehow less strict in Greek than in Albanian since only in the latter does it obligatorily occur whenever the direct object DP is outside the focus domain. The fundamental point to note, however, is that in both languages direct object clitic doubling indisputably marks the direct object DP as [-Focus]. In other words, while doubling of direct object DPs in Albanian and Greek necessarily marks these DPs as [-Focus], it is not the case that for the direct object DP to be interpreted as [-Focus], it has to be clitic doubled (e.g. Greek).

²² Albanian has an optional question particle for yes-no questions.

In (20a) and (20b) the whole VP is contrastively focussed. Since the direct object here is part of the focus domain (i.e. is marked [+Focus]), it cannot be doubled.²³

- (20) a. Al: An-a nuk (*i) zjeu fasule-t, por (*i) hëngri fiq-të.
 b. Gr:I Anna dhen (*ta) majirepse ta fasólia, alá (*ta) éfaje ta sika.
 the Ann not them_{cl} cooked the beans, but them_{cl} ate the figs
 ‘Anna didn’t [cook the beans]_F; she [ate the figs]_F.’

Likewise, direct object DPs in out-of-the-blue sentences may not be doubled, as the examples in (21) show.²⁴

- (21) A: What happened here?
 B: a. Ben-i (*e) theu termometr-in/një pjatë. (Al)
 Ben-the it_{cl} broke thermometer-the/a plate
 ‘[Ben broke the thermometer/a plate]_F.’
 b. O Janis (*ta) éfaye ta fasólia/ (*tin) ipje mia bira. (Gr)
 the Janis them_{cl} ate the beans/ her_{cl} drank a beer_{fem}
 ‘[Janis ate the beans/drank a beer]_F.’

²³ The sentences in (20) are grammatical also when the direct object (in the first conjunct) is clitic doubled under an interpretation which can be roughly rendered in English as: ‘As for Anna and the beans, she didn’t cook them, rather she ate the figs’. But notice that under this interpretation, ‘the beans’ is outside the focus domain. Hence, doubling exempts the direct object from the focus domain.

²⁴ The example in (21) is analogous to (10).

Focus (i.e. a [+Focus] phrase) is most clearly brought out in association with so-called *focus particles*, such as *even* and *only*, otherwise referred to as *scalar particles* by Jacobs (1984), or as *focussing adverbs* by Rooth (1996). In the next section, I use this diagnostic to identify [+Focus] phrases and investigate the effects of their interaction with direct object clitic doubling.

2.2.3. Focus Particles: More [+Focus] Phrases and Their Interaction With Doubling²⁵

In the examples under (22a,b) the direct object DP *Tiranën* is a [+Focus] phrase, as the English translation indicates.²⁶ As such, it cannot be clitic doubled either in Albanian or in Greek.

- (22) a. Al: Pap-a (*e) vizitoi madje Tiranë-n (jo vetëm Shkodrën).
 Pope-the it_{cl} visited even Tirana-the (not only Shkodra)
- b. Gr: O Papas (*ta) episkeftike akoma ke ta Tirana ...
 the Pope them_{cl} visited still and the Tirana ...
 ‘The Pope visited even [Tirana]_F (not only Shkodra)’

²⁵ Some of the arguments presented in this section were made for Albanian only in Kallulli (1995).

²⁶ In Albanian, focussing adverbs can attach to different sites without necessarily affecting the interpretation of phrases in terms of the [\pm Focus] feature. That is, unlike in English, it is not necessarily the constituent that the focus particle immediately precedes that constitutes the focus domain. Because of this complexity, I provide the intended interpretation in the English translations of the Albanian and Greek examples by employing square brackets followed by the subscript ‘F’ (to indicate focus domains).

Likewise, the direct object DP in (23a,b) cannot be clitic doubled, since it is marked [+Focus]. The fact that the direct object DP ‘a beer’ in (23) may not be clitic doubled is not related to its being [-definite]; the examples in (24) show that in both languages constructions involving doubled indefinites are fully grammatical if (and only if) the direct object is construed as outside the focus domain, a point which was already made earlier in the discussion.²⁷

(23) a. Al: Jan-i (*e) piu madje një birrë para se të shkonte.

Jan-the it_{cl} drank even a beer before that to go

b. Gr: O Janis (*tin) ipje akoma ke mja bira prin na fiji.

the Janis her_{cl} drank still and a beer_{fem} before to go

‘John drank even [a beer]_F before he left.’

(24) a. Al: Jan-i *(e) piu madje një birrë para se të shkonte, jo vetëm *(e) porositi.

Jan-the it_{cl} drank even a beer before that to go, not only it_{cl} ordered

‘John even [drank]_F a beer before he left (not only did he order it).’

b. Gr: O Janis ?(tin) IPJE mja bira prin na fiji ...

the Janis her_{cl} drank a beer_{fem} before to go ...

‘John [DID drink] a beer before he left (he didn’t just order it)’

²⁷ Again, in Albanian, clitic doubling of direct object DPs is obligatory when the object is outside the focus domain. A. Androutsopoulou (p.c.) points out that clitic doubling of the object when the direct object is outside the focus domain is optional in Greek; however, she notes that (24b) and (25b) are strongly preferred with the doubling clitics.

Similarly, the clitic doubled versions of the sentences in (22) are grammatical under an interpretation in which the direct objects are construed outside the focus domain; in these cases, doubling is indeed obligatory in Albanian. This is shown in (25).

- (25) a. Al: Pap-a *(e) vizitoi madje Tiranë-n.
 Pope-the it_{cl} visited even Tirana-the
- b. Gr: O Papas os ke ?(ta) episkeftike ta Tirana.
 the Pope till and them_{cl} visited the Tirana
 ‘As for Tirana, the Pope even visited it.’

The clitic doubled versions of the objects in (22) also become grammatical if the subject DP is marked [+Focus], a fact which is indicated in the examples in (26) by the focus particles in front of the subject DP.²⁸

- (26) a. Al: Madje Pap-a *(e) vizitoi Tiranë-n.
 even Pope-the it_{cl} visited Tirana-the
- b. Gr: Akoma ke o Papas (ta) episkeftike ta Tirana.
 still and the Pope them_{cl} visited the Tirana
 ‘Even [the Pope]_F visited Tirana.’

²⁸ In fact, as the notation in (26) indicates, clitic doubling of the direct object DP is obligatory in Albanian when the subject is focussed; in Greek, however, clitic doubling of the direct object DP is only optional when the subject is focussed.

The data thus systematically reveal that clitic doubling of direct object DPs, including [+definite] ones, that are marked [+Focus] or are contained in [+Focus] phrases is disallowed in Albanian and Greek.

The question next arises as to whether the function of direct object doubling clitics is to license verb/subject-focussing or object non-focussing. The fact that verb/subject focussing may still be achieved in sentences with intransitive verbs decides the issue in favour of the latter alternative. Furthermore, the data unequivocally show that while direct object clitic doubling is a sufficient condition to license a [-Focus] feature on direct object DPs both in Albanian and Greek, it is also a necessary condition in Albanian. In sum, we may state that clitic doubling of direct object DPs in Albanian and Greek is not optional: [+Focus] DPs cannot be clitic doubled.

Thus, direct object clitics in Albanian and Greek have interpretive import; they mark the DPs they double as unambiguously [-Focus], which is interpreted as an operator feature. This feature (i.e. [-Focus]) could alternatively be represented formally as [+Topic]; recall that in section 2.1 I defined *topic* as the complement of *focus*, not as necessarily old/familiar information. In this context, see also Reinhart (1982, 1995), who crucially points out that defining *topic* as old/familiar information as according to the Prague school is not only conceptually clumsy, but also empirically incorrect. In view of the fact that topic is the counterpart of focus, it makes little difference whether we choose to represent it formally as [-Focus] or as [+Topic]. For the sake of symmetry in representation, however, the postulate of one binary feature (here: [\pm Focus]) might be preferable. Hence my choice of label: [-Focus].

Reinhart (1995: 85) remarks that “even in view of the massive varieties of opinions regarding what topics are, [there] is one context all studies agree upon: the NP in there

sentences can never be topic”. We thus expect that objects of the verb ‘to have’ may not be clitic doubled in Albanian and Greek existential constructions. This is indeed the case, as witnessed by the examples in (27).

- (27) a. Al: (*I) kishte minj në gjithë apartament-in.
 b. Gr: (*Ta) ixe pontikia se olo to diamerisma.
 them_{cl} had mice_{acc} in all the apartment
 ‘There were mice all over the apartment’

In this respect, direct object clitic doubling in Albanian and Greek is different from clitic doubling in Spanish, which does not necessitate a [-Focus] reading (cf. e.g. (28) from Portefño Spanish), but strongly reminiscent of so-called clitic right dislocation structures in French, Spanish and Italian which are incompatible with [+Focus] phrases.²⁹

- (28) La nombraron a **Maria**. (Suñer 1988: 419)
 her they-nominated *a* Maria
 ‘They nominated MARIA.’

However, the fact that clitic doubled DPs may in Albanian and Greek occur in positions where adjuncts are simply not tolerated, as was shown in section 1 (cf. e.g. (7) and (8)), ultimately rules out a right dislocation approach to these constructions.

²⁹ Direct object clitic doubling in Albanian and Greek is also strongly reminiscent of scrambling of direct objects in Germanic (cf. Webelhuth 1989). The parallels between clitic doubling and scrambling will be closely discussed in section 2.3.2.

Further evidence can be adduced to this effect. For instance, if the doubled direct object DPs in Albanian were indeed right-dislocated, a [+Focus] phrase to the right of a right dislocated direct object would be precluded. This prediction is however not borne out, as the example in (29) demonstrates.

(29) Al: I-a dhashë libr-in BEN-IT.

him_{cl}-it_{cl} gave book-the_{acc} BEN-THE_{dat}

‘I gave the book to BEN.’ i.e. ‘It was BEN that I gave the book to.’

The question then remains whether the Albanian and Greek doubling constructions constitute yet a third type of clitic constructions with properties distinct from that of the two others, that is, clitic doubling constructions in Spanish/Romanian on one hand and clitic right dislocation constructions in Romance on the other, or whether it can subsume or be subsumed under either of the two. To address this question one would have to look at all the properties of the other two constructions in detail, as well. Such a task is however well beyond the scope of this study.

In the next section, I provide evidence from clausal complementation that lends further support to the view that doubling clitics in Albanian and Greek license topichood.

2.2.4. Clausal Complements and Clitic Doubling: Triggering Factivity

It has been widely acknowledged in the literature that a hallmark of topical expressions is that they presuppose their descriptive content. Stated differently, topics represent some sort of background information (cf. Chomsky (1972), Reinhart (1982),

Erteschik-Shir (1998)). In fact, Chomsky (1972) considers presupposition the counterpart of focus.

In their study of factivity, Kiparsky & Kiparsky (1970) define factivity in terms of presuppositionality. They argue that factive complements differ from non-factive complements in that the truth value of the former is presupposed, whereas the truth value of the latter is asserted. Verbs whose complements are factive are called factive verbs and those whose complements are not factive are called non-factive verbs.

Consider the sentence in (30).

(30) I don't believe that the earth is flat.

The sentence in (30) asserts that the earth is not flat; the truth value of the complement of the verb *believe* (namely the clause: *The earth is flat*) is obviously not retained and therefore not presupposed. Hence, the verb *believe* in (30) is non-factive. In contrast, the verb *regret* in (31) below is factive because the truth value of its complement is necessarily presupposed: the sentence in (31) is incompatible with a state of affairs in which *John didn't leave*.

(31) I don't regret that John left.

Some more factive and non-factive verbs are given in (32).

(32) a. *Factives*

regret, be aware (of), grasp, comprehend, take into consideration, ignore, mind, forget, deplore, resent, bother (in: *It bothers me that...* constructions), etc.

b. *Non-factives*

suppose, assert, allege, assume, claim, charge, believe, conclude, think, maintain, etc.

It is important to note that even with a non-factive verb like *believe*, factivity can be triggered. Consider the examples in (33).

(33) a. I believe that John is smart.

b. Can you believe that John is smart?

c. I can believe that John is smart.

The verb *believe* in (33a) is non-factive; (33a) asserts the belief of the speaker that *John is smart*. In contrast, *believe* in (33b) and in (33c) is necessarily factive, as its complement, namely *John is smart*, is taken as an uncontroversial fact both in (33b) and (33c). It seems then as if the factivity of *believe* in (33b,c) is triggered by the modal verb *can*.³⁰

Consider now the examples in (34a) and (34b), from Albanian and Greek, respectively.

³⁰ I. Roberts (p.c.) observes that for the factivity of the complement clauses in (33b) and (33c) to arise, the verb *believe* must be stressed.

(34) a. Al: Besoj se Jan-i shkoi.

b. Gr: Pistevo oti o Jannis efije.

believe-I that the John left

'I believe (that) John left.'

The verb *believe* in both (34a) and (34b) is non-factive, just as in its English counterpart; (34a,b) simply assert a certain belief, namely that John left. However, when the complement clause is clitic doubled, as in (35a,b), the truth of the proposition *John left* is presupposed, taken for granted, and moreover uncontroversially so, as is rendered by the English translation. In fact, the sentences in (35a,b) entail that *John left*, as indicated by the fact that negating them gives rise to a contradiction, as shown in (36).

(35) a. Al: E besoj se Jan-i shkoi.

b. Gr: To pistevo oti o Jannis efije.

it_{cl,acc} believe-Ithat the John left

'As for the fact that John left, I do believe it.'

(36) Al: #E besoj se Jan-i shkoi, por në fakt ai nuk shkoi.

it_{cl,acc} believe-Ithat the John left but in fact he not left

'As for the fact that John left, I do believe it, but in fact John didn't leave.'

Obviously the factivity of the clausal complements in (35) is triggered by clitic doubling. This is as predicted under the hypothesis that clitic doubling licenses

topichood, since topics are necessarily presupposed.³¹ In this context, cf. also Roussou (1999) who claims that factivity needs to be triggered by focus in the matrix clause.

2.2.5. Summary

In concluding this section, it may be stated that direct object doubling clitics in Albanian and Greek are characterized by the fact that they have: (i) restricted distribution, (ii) operator-like properties. A variety of facts converge in showing that direct object clitic doubling in both languages is an operation that invariably licenses topichood on direct object DPs. Thus, strictly speaking, direct object clitic doubling in Albanian and Greek is not a fully optional phenomenon. In Greek, direct object clitic doubling is a sufficient though not a necessary condition for licensing topichood on direct object DPs. In Albanian, it is both necessary and sufficient.

Both of the properties mentioned above, namely that direct object clitics have a restricted distribution and operator-like properties suggest that direct object doubling clitics in Albanian and Greek cannot be treated as mere object agreement markers, that is, as spell-outs of e.g. AgrO heads. Yet, there is little doubt that clitic doubling is a form of agreement between an X^0 and an XP, namely the clitic head and the DP it doubles and with which it agrees in phi-features. The next section is devoted to how this cluster of properties can be best represented.

³¹ In fact, that topics are presupposed follows if topic is defined as the complement of focus (as was done in section 2.2.1) and the focus is unique.

2.3. Issues of Representation

In the previous section I showed that direct object clitic doubling in Albanian and Greek marks direct object DPs as [-Focus]. In the present section I will show how this view can be implemented formally. In addition, I will discuss certain parallels that obtain between direct object clitic doubling in Albanian and Greek on one hand and scrambling in Germanic on the other. Crucially, I propose that Germanic scrambling is an operation that yields the same interpretative effects as direct object clitic doubling in Albanian and Greek and that it involves the same underlying configuration as clitic doubling constructions. Then, I will show that my hypothesis with respect to direct object clitic doubling in Albanian and Greek is not affected by word order variations. Finally, I will offer an analysis of certain asymmetries with respect to direct object clitic doubling in Albanian and Greek restrictive relative clauses which necessitates a discussion of the structure of restrictive relative clauses.

2.3.1. Spec-head Licensing, Feature-checking and Doubling

The view that accusative clitics mark the DPs they double as [-Focus] may be implemented structurally in terms of the theory of spec-head licensing (cf. Chomsky 1995), if we assume with Sportiche (1992) that a clitic heads its own maximal projection in whose specifier position it licenses a particular property/feature F.³² For

³² With respect to the property they license, according to Sportiche, clitics subdivide in two types. The first type (typically accusative clitics) assimilates to such functional heads as [+wh] complementizers or [+negative] heads, which license some operator-like properties (e.g. *wh* or negative quantifiers). Sportiche argues that the operator like property these clitics license is *specificity* in DPs. The second type of clitics (typically nominative and dative Romance clitics) is claimed not to be linked to specificity. Concerning this second type of clitics, Sportiche suggests that they be analyzed as pure agreement markers, that is, as elements devoid of interpretive import, presumably responsible for dative case assignment (i.e. AgrIO-heads in the sense of Chomsky (1995)).

a derivation to converge, this feature has to be “saturated” or “checked off” (cf. Chomsky 1995). Since features may only be checked off in spec-head configurations, the (doubled argument) XP* in (37) must by LF move to the XP^ position so as to obtain the relevant spec-head configuration.

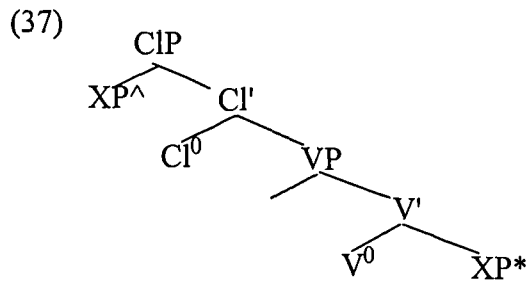

In Sportiche’s terms, movement of XP* to the XP^ position is motivated by the Clitic Criterion (given in (38)), an analogue of Rizzi’s (1991) Wh-Criterion, and yet another instantiation of the so-called Generalized Licensing Criterion (given in (39)), according to which feature-licensing may only obtain in spec-head configurations.

(38) Clitic Criterion (Sportiche 1992: 25)

At LF

- a. A clitic must be in a spec-head relationship with a [+F] XP
- b. A [+F] XP must be in a spec-head relationship with a clitic

(39) Generalized Licensing Criterion

At LF

- a. A [+F] head must be in a spec-head relationship with a [+F] XP
- b. A [+F] XP must be in a spec-head relationship with a [+F] head

Further, Sportiche sets the following clitic parameters:

(40) *Clitic Parameters* (Sportiche 1992: 26)

- a. Movement of XP* to XP^ occurs overtly or covertly
- b. Head (Cl) is overt or covert
- c. XP* is overt or covert

By these clitic parameters, among others, the following cases are predicted:

- (41) a. Clitic doubling constructions (as in Spanish, Romanian, Greek, Albanian) arise when an overt XP* moves covertly with an overt Cl.
- b. Scrambling in Dutch/German arises when an overt XP* moves overtly with a covert Cl.
- c. Clitic left dislocation (as in Italian etc.) arise when an overt XP* moves overtly with an overt CL to Spec of CIP and then beyond.

With respect to direct object clitics, Sportiche claims that the property the clitic head licenses in the specifier of the phrase it heads is invariably *specificity*, irrespective of whether the direct object clitic is overt (as in doubling constructions) or covert (as in scrambling constructions). As discussed above, this cannot be the case for Albanian and Greek direct object clitics. The feature that Albanian and Greek direct object clitics license in the specifier of the phrase they head is what was defined in section 2.2 as [-Focus]. By the theory of spec-head licensing, for the derivation to converge, the feature-values on the clitic head and those of the DP in its specifier must match. Since the attracting feature is [-Focus], a clitic doubled [+Focus] direct object DP

would invariably cause the derivation to crash. In this way, doubling of [+Focus] direct object DPs is of necessity ungrammatical.

While the idea that the same syntactic configuration underlies both doubling and scrambling constructions is desirable conceptually and attractive theoretically (cf. Chomsky 1995), I argue that the property F in (39), whose need to be licensed motivates the postulated maximal projections (that is, Sportiche's CIP(s) or *Voice Phrases*), is identified incorrectly by Sportiche. In section 2.2, I demonstrated that the feature that Albanian and Greek direct object clitics license on the DP they double is not specificity but topichood. In the next section I show that this is also the case for Germanic scrambling.³³

2.3.2. Parallels with Germanic Scrambling³⁴

Like doubling of direct objects in Albanian and Greek, scrambling of direct objects in Germanic applies both to definite DPs as well as to a-expressions.³⁵ That is, the [\pm definite] feature of the DP is not relevant for scrambling, strictly speaking. This is illustrated in (42b), (43b) and (44b).

³³ The idea that focus is involved in scrambling phenomena is extensively discussed in Reinhart (1995). While Reinhart argues that a scrambled constituent cannot be focus, she favours a PF approach to focus (cf. Cinque 1993) which crucially involves the notion of stress prominence. However, as stated in footnote (19), I wish to leave open the possibility that the syntactic feature *focus* may have PF correlates that are different from (and perhaps exclude) stress prominence. Therefore, I will not undertake to present Reinhart's account.

³⁴ The term *scrambling* originates in Ross's (1967) dissertation, where a universal *Scrambling Rule* is proposed to account for the variable word order in the so-called "free word order" languages. Essentially, this rule states that two adjacent constituents can be permuted if they are clause-mates. In the context of Germanic languages, scrambling generally refers to the permutation of adjacent constituents within the IP domain (cf. Weibelhuth (1989), Sternefeld (1990) *i.a.*).

³⁵ Throughout this dissertation, I use the term *a-expression* (cf. Chastain 1975) to refer to non-quantified, singular indefinite nouns with articles, such as *a cat*.

(42) Dt: a. Anna hat gestern **das Buch** gelesen.

Anna has yesterday the book read

b. Anna hat **das Buch** gestern gelesen.

Anna has the book yesterday read

‘Ann read the book yesterday.’

(43) Dt: a. Ich habe gestern eine Zeitung gelesen.

I have yesterday a newspaper read

b. Ich habe eine Zeitung gestern gelesen.

I have a newspaper yesterday read

‘I read a newspaper yesterday.’

(44) (de Hoop 1992: 50) NI: a. dat de politie gisteren een kraker opgepakt heeft

that the police yesterday a squatter arrested has

b. dat de politie een kraker gisteren opgepakt heeft

that the police a squatter yesterday arrested has

It was shown in section 1 that definite direct object DPs cannot always be doubled. The data in (45) and (46) show that neither can they always scramble. This fact is problematic for the specificity/presuppositionality/strength related approaches to scrambling (cf. Sportiche (1992), Diesing (1992), de Hoop (1992) *i.a.*) which assume that all definites are specific/presuppositional/strong. While the claim that all definites are specific will be challenged (cf. section 3.4.3), there are unequivocally specific/

presuppositional/strong definites (and indefinites) that cannot scramble (cf. e.g. (47)).

Hence, scrambling emerges even in these analyses as an optional phenomenon.

- (45) Dt: Er sagte, daß er nicht zu Fuß in die Schule geht, sondern
 he said that he not on feet in the school walks, but
 a. daß er immer den Bus nimmt.
 that he always the bus takes
 b. *daß er den Bus immer nimmt.
 that he the bus always takes
 ‘He said that he doesn’t walk to school but always takes the bus.’

- (46) (Reinhart 1996: 4) Nl: a. dat ik altijd de bus neem
 that I always the bus take
 b. *dat ik de bus altijd neem
 that I the bus always take

- (47) A: What happened?
 B: a. (Dt) Hans hat heute das Thermometer/einen Teller zerbrochen.
 Hans has today the thermometer/a plate broken
 b. (Dt) #Hans hat das Thermometer/einen Teller heute zerbrochen.
 Hans has the thermometer/ a plate today broken
 ‘Hans broke the thermometer/a plate today.’

It is easy to notice in the (grammatical) examples above that the direct object DPs are part of the focus domains (i.e. they are marked [+Focus]). I propose that this is why these DPs cannot undergo scrambling.³⁶

Further evidence that can be adduced to this effect is the fact that *+wh* direct object DPs in root clauses cannot scramble, as the German examples in (48) show (examples from Sternefeld (1990)).

(48) Dt: a. Wem hat der Student welche Frage beantwortet?

whom has the student which question answered?

b. *Wem hat welche Frage der Student beantwortet?

whom has which question the student answered

‘To whom did the student answer which question?’

The examples in (49) show that scrambling of direct objects in German is obligatory in anaphoric contexts, such as yes-no questions may provide.

³⁶ Scrambled noun phrases may have contrastive focus, as in the Dutch example below:

i) Ik heb slechts EEN van de boeken nog niet gelezen.
I have only ONE of the books yet not read

Here the DP ‘the books’ is marked [-Focus], but ‘one’ is [+Focus]. However, in Albanian and Greek contrastively focussed direct object DPs are incompatible with doubling. The reason for why the parallel between scrambling and doubling breaks down when contrastive focus is involved is not entirely clear to me. It might be stipulated, though, that contrastive focus is fundamentally correlated with stress prominence at PF (cf. Brody 1990). However, since clitics are incompatible with PF stress (i.e. marked [-stress] (cf. Zwicky 1977)), the derivation crashes because of value divergence with respect to PF stress. The non-overt clitic head in the case of scrambling might however be totally underspecified for the PF stress value; as such, a [+stress] element moved to its specifier position in the syntax won’t render the derivation illicit at PF.

- (49) A: Hat der Papst Tirana endlich besucht?
 has the Pope Tirana finally visited
 ‘Did the Pope finally visit Tirana?’
- B: a. Der Papst hat Tirana noch immer nicht besucht.
 the Pope has Tirana yet always not visited
 ‘The Pope has not visited Tirana yet.’
- b. #Der Papst hat noch immer nicht Tirana besucht.
 the Pope has yet always not Tirana visited
 ‘The Pope has not visited Tirana yet.’

The fact that scrambling of direct objects in German is obligatory in anaphoric contexts can be accounted for in a straightforward manner under my hypothesis that scrambling of direct object DPs licenses a [-Focus] feature or topichood on these phrases, since anaphoricity is a way of identifying topics (cf. Reinhart 1995). That is, the direct object DPs in (49) are not marked [+Focus]. Consequently, there is no feature clash between the (covert) clitic head and the scrambled DP in the specifier of the $Cl_{acc}P$ in the diagram in (37) with respect to the feature [\pm Focus]. Therefore the derivation will converge (provided that the covert clitic head and the XP^* do not mismatch with respect to other features). Note that the specificity/presuppositionality/strength approaches to scrambling cannot account for the fact that scrambling of direct objects in such anaphoric contexts as (49) is obligatory, since ‘Tirana’ as a proper noun is referential specific also in the unscrambled version.

While both definite and indefinite DPs with overt determiners may be doubled and scrambled, in which case they are necessarily marked [-Focus], bare indefinites cannot. For bare plurals this is shown in (50); doubled and scrambled bare plurals are

ungrammatical in any contexts. With respect to scrambling in Germanic, this claim only holds for those bare plurals that cannot receive a generic interpretation but receive an existential interpretation. The distinction between generic and existential bare plurals which goes back to Carlson (1977) is explicated in chapter 3 (section 3.7). In Greek and Albanian, like in Romance and unlike in Germanic languages, bare plurals cannot get a generic interpretation. Consequently, clitic doubling of bare plurals in Albanian and Greek, just like in Romance, is precluded. The sentences (51a,b,c) show that the claim that bare indefinites cannot be doubled and scrambled also holds for count bare singular direct objects.³⁷

- (50) a. Al: An-a nuk (*i) zjeu fasule, por (*i) hëngri fiq.
 b. Gr:I Anna dhen (*ta) mayirepse fasólia, alá (*ta) éfaye sika.
 the Ann not them_{cl} boiled beans, but them_{cl} ate figs
 c. Dt: Anna hat nicht Bohnen gekocht, sondern sie hat Feigen gegessen.
 Anna has not beans cooked but she has figs eaten
 d. Dt: *Anna hat Bohnen nicht gekocht, sondern sie hat Feigen gegessen
 Anna has beans not cooked but she has figs eaten
 ‘Anna didn’t [cook beans]_F but [ate figs]_F.’

³⁷ As it happens, even closely-related languages differ with respect to the possibility of instantiating their direct objects by count bare singulars. Thus, while count bare singulars are virtually non-existent as direct objects in English, across Balkan and Mainland Scandinavian languages they may occur as direct objects of all predicates whose bare plural direct objects cannot get a generic (i.e. *referential/kind-denoting*) interpretation but get an existential interpretation. In German, on the other hand, count bare singulars do occur as direct objects, but are much more restricted than in Balkan and Mainland Scandinavian. Note in this context that of all the languages mentioned above, only English disallows count bare singulars in predicate nominal position. Finally, note that count bare singulars are found also in English as objects of certain prepositions; e.g. *go to school/church/market; travel by train/plane* etc. Bare singulars will be discussed in detail in chapter 3.

1) a. Al: An-a donte t-(*a) blente fustan.

b. Gr: I Anna ithele na (*tis) aghorasi forema.

the Ann wanted SUBJ-her_{cl} buy dress

‘Anna wanted to buy a dress.’

c. Dt: Ich habe (*Zeitung) nicht/im Garten (Zeitung) gelesen.

I have newspaper not/in the garden (newspaper) read

‘I have not read a newspaper.’/‘I have read a paper in the garden.’

vs.

a'. Al: An-a donte t-(a) blente **një** fustan.

b'. Gr: I Anna ithele na (tis) aghorasi **ena** forema

the Ann wanted SUBJ-her_{cl} buy a dress

‘Anna wanted to buy a dress.’

c'. Dt: Ich habe (**eine** Zeitung) nicht/imGarten (eine Zeitung) gelesen

I have (a newspaper) not/in the garden (a newspaper) read

‘I have not read a paper.’/‘I have read a paper in the garden.’

Hence the descriptive generalisations in (52):

(52) a. Bare nouns in Albanian and Greek cannot be clitic doubled.

b. Count bare singulars and existential bare plurals in German cannot scramble.

The sentences (51a,b) are ungrammatical when the bare singular objects are doubled in spite of the fact that the clitics and the direct object bare singulars here agree in phi-features (that is, in number, person and gender, since bare singulars, like a-expressions, are not marked for morphological case in Albanian and Greek).

The question arises as to why bare indefinites cannot be doubled/scrambled. I answer this question in chapter 3.

2.3.3. Word Order Variations, Clitic Doubling and the Structure of the Clause

As was already mentioned in section 2.1, both Albanian and Greek are so-called free word-order languages. What this means is that there is some latitude with respect to the placing of major constituents like subject, verb and object in the structure of the clause. In other words, both languages display word order variations. In this section, I will show that the effects of DO clitic doubling on propositional interpretation are in Albanian and Greek independent of word order variations. I will account for these word order variations by depicting the structure of the Albanian and Greek clause in some detail.

2.3.3.1. VP-internal Scrambling and Direct Object Clitic Doubling

In Albanian double-object constructions the relative ordering of the direct and the indirect objects is not rigid; the direct object may either precede or follow the indirect object. Using evidence from binding facts, Massey (1991) shows that the underlying order between the direct and the indirect object in Albanian is: IO - DO; that is, the indirect object is higher than the direct object in the structure of the clause at the level where binding relations are determined, which in her analysis is the D-structure. To illustrate, the example in (53a) shows that the reference of the anaphoric expression here is ambiguous; the direct object anaphor here can be co-indexed either with the subject DP or with the dative object. That is, either the subject or the indirect object can bind the anaphor in (53a). In contrast, (53b) shows that the direct object DP cannot bind the dative anaphor; the anaphor here is unambiguously bound by the

subject DP. This state of affairs is to be expected if the indirect object c-commands the direct object at the level where the binding relations are determined.

- (53) a. Gazetar-i i tregoi An-ës vajz-ën e vet.
 journalist-the 3_{scI,dat}showed Ann-the_{dat} daughter-the_{acc} acc self
 ‘The journalist showed Ann his own / her own daughter.’
- b. Gazetar-i i tregoi vajz-ës së vet An-ën.
 journalist-the 3_{scI,dat}showed daughter-the_{dat} dat self Ann-the_{acc}
 ‘The journalist showed Ann to his own / *her own daughter.’

However, as already stated, this order can be reversed so that the order DO - IO obtains, as shown in (54a,b). Massey (1991) refers to this phenomenon as “VP-internal scrambling” and contends elsewhere that in Albanian, a VP-internally scrambled direct object DP forces its doubling.

- (54) a. Gazetar-i i tregoi vajz-ën e vet An-ës.
 journalist-the 3_{scI,dat}showed daughter-the_{acc} acc self Ann-the_{dat}
 ‘The journalist showed Ann his own / her own daughter.’
- b. Gazetar-i i tregoi An-ën vajz-ës së vet.
 journalist-the 3_{scI,dat}showed Ann-the_{acc} daughter-the_{dat} dat self
 ‘The journalist showed Ann to his own / *her own daughter.’

Note that the direct objects in (54a,b) are instantiated by definite expressions. Yet, they are not clitic doubled. The examples in (54) clearly illustrate therefore that VP-internal scrambling of direct objects is irrelevant for doubling, contrary to Massey

(1991). These examples show that the VP-internal scrambling of direct objects does not affect the binding relations either, which is also pointed out in Massey (1991).

Can the VP-internally scrambled direct objects in (54) be clitic doubled? The examples in (55) show that they can.

- (55) a. Gazetar-i i-a tregoi vajz-ën e vet An-ës.
 journalist-the 3_{ScI,dAt}-3_{ScI,acc} showed daughter-the_{acc} acc self Ann-the_{dAt}
 ‘The journalist showed Ann his own / her own daughter.’
- b. Gazetar-i i-a tregoi An-ën vajz-ës së vet.
 journalist-the 3_{ScI,dAt}-3_{ScI,dAt} showed Ann-the_{acc} daughter-the_{dAt} dAt self
 ‘The journalist showed Ann to his own / *her own daughter.’

What is then the difference between (54a) and (55a) on one hand and (54b) and (55b) on the other? The difference lies precisely in the topic-focus values that they encode. So, while (54a,b) would both be felicitous answers to the questions in (56a-b), their clitic doubled counterparts (55a,b) would not be felicitous. Further, while (54a) would be a felicitous answer to the question in (56c), (55a) would not, and while (54b) would be a felicitous answer to the question in (56d), (55b) would not be so. In addition, while (55a) would be a felicitous answer to the question in (56e), (54a) would not, and while (55b) would be a felicitous answer to (56f), (54b) would not be so. Note that the question in (56a) provides an out-of-the-blue context, the one in (56b) provides a context of VP-focussing, (56c,d) provide contexts of direct object focussing, and (56e,f) provide contexts of subject focussing.

- (56) a. What's up?
 b. What did the journalist do?
 c. Who did the journalist show to Ann?
 d. Who did the journalist show to his daughter?
 e. Who showed Ann his/her daughter?
 f. Who showed Ann to his daughter?

It is thus obvious from the felicity judgements given above that while the direct object DPs in (54a,b) are marked [+Focus], their clitic doubled versions in (55a,b) are necessarily marked [-Focus].

2.3.3.2. Clause Initial Direct Objects and Doubling

Both in Albanian and Greek, direct objects may be fronted to clause-initial position, as shown in (57).

- (57) Al: a. LUL-ET_{acc} (*i) solli Jani_{nom}.
 Gr: b. Ta LULUDHIA_{acc} (*ta) éfere o Jannis_{nom}
 the flowers them_{cl,acc} brought John
 'It was the flowers that John brought.'

Given that the direct object DPs in (57a,b) are marked [+Focus] (hence the rendering into English by a cleft construction), it makes sense to assume that they occupy precisely Spec of CP. (Recall from section 2.2.2 that Spec of (a root) CP is one of the canonical positions for focus.) In fact, Massey (1991) refers to the fronting of direct

objects in Albanian as “object scrambling to Spec of CP”. It is then to be expected that clitic doubling the objects in (48a,b) will render the constructions ungrammatical.

Massey (1991) notes that scrambling of direct objects to Spec of CP in Albanian is not equivalent to so-called topicalization in English. While scrambling of direct objects to Spec of CP triggers subject-verb inversion in Albanian (cf. (57a)), topicalization in English does not trigger subject-auxiliary inversion (cf. the grammaticality of (58a) vs. the ungrammaticality of (58b)). Greek patterns with Albanian also here (cf. (57b)). The sentences in (59) show that in Albanian and Greek direct object fronting to Spec of CP is ungrammatical if subject-verb inversion fails to obtain.³⁸

(58) a. MARY_(DO) John_(SU) saw.

b. *MARY_(DO) did John_(SU) see.

(59) Al: a. *LUL-ET_{acc} Jani_{nom} solli.

Gr: b. *Ta LULUDHIA_{acc} o Jannis_{nom} éfere.

the flowers John brought

‘It was the flowers that John brought.’

Massey (1991) claims that scrambling of definite direct objects to Spec of CP in Albanian triggers obligatory clitic doubling. This is obviously false as shown in (57a).

There is, however, one type of construction in which the direct object occurs clause-

³⁸ The subject-verb inversion in Albanian and Greek in constructions where the direct object has been moved to Spec of CP may be analyzed in terms of verb movement to C⁰ (cf. Massey (1991) for Albanian), since no other elements appear to intervene between the DP in the Spec of CP and the verb.

initially and is clitic doubled. This is the so-called *clitic left dislocation* (cf. Cinque 1990) construction which I turn to in the next section.

2.3.3.3. Clitic Left Dislocation and Information Structure

The clitic left dislocation (CLLD) construction is illustrated in (60).

- (60) Al: a. Lulet_{acc} *(i) solli Jani_{nom}.
 Gr: b. Ta luludhia_{acc} *(ta) éfere o Jannis_{nom}
 the flowers them_{cl,acc}brought John
 ‘As for the flowers, it was John who brought them.’

In (60) a clitic doubled direct object DP has been dislocated to the left periphery of the clause (hence the term clitic left dislocation). Note that the clitic is obligatory in this type of construction. It is crucial to also note that the interpretation of the direct object in this type of construction differs from the interpretation of the direct object in the construction type illustrated in (57) with respect to the value of the focus feature. More specifically, while the object DPs in (57) are marked [+Focus], the object DPs in (60) are necessarily topics. In line with the hypothesis established in section 2.2, focussed direct object DPs are again incompatible with clitic doubling. Cinque (1990:63) makes the same observation about Italian:

- (61) *GIANNI, l' ho cercato, non Piero.
 GIANNI, him looked-I for not Piero

The question then arises as to what position in the structure of the clause the clitic doubled left dislocated object occupies. Certainly, if it occupied the Spec of CP, the whole hypothesis about this position being incompatible with [-Focus] DPs would collapse. So, if it is really the case that Spec of CP is a canonical position for focus, we need to look at other positions that might host the clitic doubled fronted object DPs in (60).³⁹ One such position is of course the Spec of the Clitic Phrase in the tree diagram in (37). There is in fact a proposal in the literature according to which CLLD arises when the doubled DP moves overtly to the Spec of the Clitic Phrase (cf. Agouraki 1993). While this idea is attractive, since the CLLD construction emerges as an instance of the clitic doubling construction, it cannot be quite correct as it makes the prediction that nothing may intervene between the clitic left dislocated object and the clitic. This prediction is however not borne out. For instance, negation, which in Albanian is a head (cf. Rivero (1994), Kallulli (1997)), always intervenes between a clitic left dislocated object and the clitic, as the example in (62) shows.

- (62) Al: Lul-et nuk i solli Jan-i, por An-a.
 flowers-the_{acc} not them_{cl,acc} brought John-the_{nom} but Ann-the_{nom}
 'As for the flowers, it was not John but Anna that brought them.'

Likewise, as Cinque (1990) notes for Italian, other phrases may intervene between the clitic left dislocated object and the (doubling) clitic. This also holds for Albanian and Greek, as the examples in (63) demonstrate. The fact that other syntactic constituents

³⁹ Cf. also Cinque (1990) for more arguments against the idea that the clitic left dislocation construction involves wh-movement.

may occur between the clitic left dislocated object and the clitic shows that the clitic left dislocated phrases in these examples do not occupy Spec of CIP.

- (63) a. Al: Lul-et Jan-i i bleu.
 b. Gr: Ta luludhia o Jannis ta aghorase.
 the flowers_{acc} John them_{cl,acc} bought
 ‘As for the flowers, John bought them.’

While the CLLD construction might indeed involve overt intermediate movement of the left dislocated DP to the Spec of the Clitic Phrase, I suggest that from here, this DP subsequently moves to the Spec of a Top (for Topic) Phrase on top of the CP level, as schematized in the tree-diagram in (64).⁴⁰ I am then claiming that CP is not the topmost level in a root clause.

⁴⁰ Cinque (1990) also argues that the clitic left dislocated object occupies the Spec of a T(topic)Phrase but he takes the clitic left dislocated object to be generated in this position. In contrast, in my analysis, the clitic left dislocated object in the Spec of TP is a result of move α .

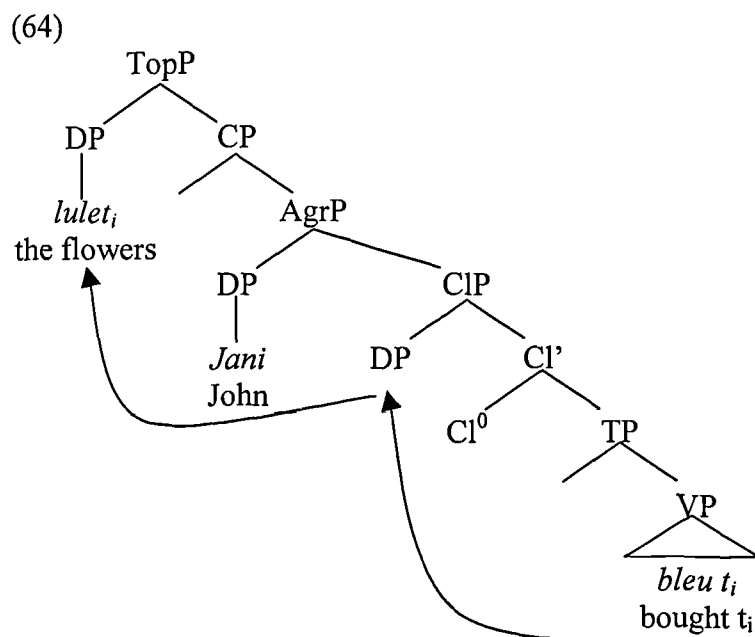

Concluding this section, it might be stated that direct object clitic doubling in Albanian and Greek invariably marks the direct object DPs as topics. Direct object clitic doubling does not interact with word-order variations.

In the following section, I turn to certain asymmetries in the distribution of direct object clitic doubling in relative clauses.

2.3.4. Asymmetries in Clitic Doubling Patterns: the Case of Restrictive Relative Clauses

Alexiadou & Anagnostopoulou (hence: A&A) (1997) credit Stavrou (1984) for having observed that direct object clitic doubling in *pu* 'that' restrictive relative clauses in Greek is sensitive to the (in)definiteness of the *associate* of the relative clause.⁴¹ More specifically, they state that clitic doubling of the associate of the relative clause is licit

⁴¹ Following Áfarli (1994), I use the term *associate* to refer to the nominal expression that is associated to the restrictive relative clause (e.g. the expression *the shoes* in: *I bought the shoes that I liked*).

when the latter is indefinite and illicit when it is definite. This is illustrated in (65a) vs. (65b).

(65)a. Diavasa ena vivlio pu to pira apo ti vivliothiki. (from A&A 1997:1)

read-I a book that it_{cl,acc} got-I from the library

‘I read a book that I got from the library.’

b. *Diavasa to vivlio pu to pira apo ti vivliothiki.

read-I the book that it_{cl,acc} got-I from the library

‘I read the book that I got from the library.’

The pattern illustrated in (65a) vs. (65b) is also found in Albanian, as the examples in (66) indicate.

(66)a. Lexova një libër që e mora në bibliotekë.

read-I a book that it_{cl,acc} got-I in library

‘I read a book that I got from the library.’

b. Lexova libr-in që (*e) mora në bibliotekë.

read-I book-the that it_{cl,acc} got-I in library

‘I read the book that I got from the library.’

The question arises as to why the asymmetry illustrated above arises. A&A propose an account for this asymmetry in Modern Greek which crucially relies on Kayne’s (1994) structural analysis of restrictive relative clauses. I will first present their analysis, then point to a set of facts that A&A leave unexplained. Finally, I will show how the

asymmetry under discussion is derived from my analysis of clitic doubling as a topic-licensing operation (cf. section 2.2.5).⁴²

The diagram in (67) represents the structure that Kayne (1994), drawing on Schachter (1973) and Vergnaud (1974), assigns to relative clauses involving a definite associate.

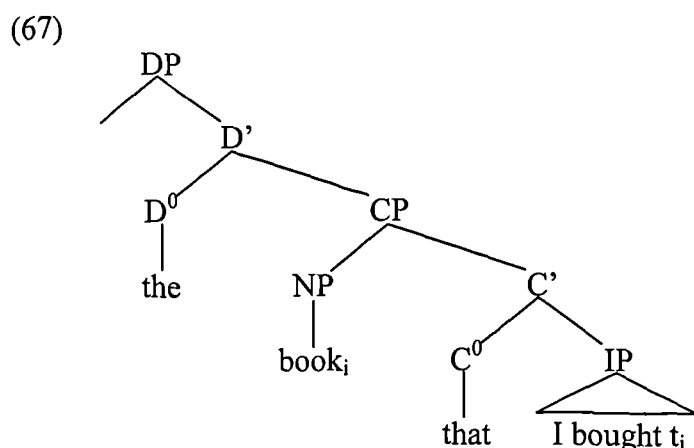

In (67), the relative clause is a complement of the determiner and what raises to Spec of CP is a bare NP and not a null Operator. A&A assume this structure and claim that when the relative clause associate is definite, what has raised to Spec of CP is a bare noun, meaning an NP, not a DP. In contrast, A&A claim, when the associate is indefinite, then what raises to Spec of CP is a QP. In other words, the indefinite determiner and the noun phrase *a book* (in (65a)) form a constituent (QP) and the external D slot remains empty, while *the book* (in (65b)) does not form a constituent, since the head *book* raises from inside the clause to Spec of CP and the determiner *the* is external. Consequently, definite associates of restrictive relative clauses are definite only by virtue of the fact that the raised NP surfaces as a complement of the

⁴² Recall from section 2.2.1 that I defined topic as the counterpart of focus; that is, [+Topic] = [-Focus].

determiner. (For arguments in favour of postulating that the determiner in restrictive relative clauses has an external source, cf. Schachter (1973), Vergnaud (1974), Kayne (1994).) The ungrammaticality of constructions involving clitic doubling of definite associates follows then from the generalisation that was stated in (52a) (cf. section 2.3.2), namely that bare nouns in Albanian and Greek cannot be clitic doubled.

A&A's explanation of the impossibility of clitic doubling the relative clause associate when the latter is definite is not unreasonable. However, their analysis does not provide an account for the fact that when the relative clause associate is indefinite it can be clitic doubled, an issue that is especially important in view of the fact that these authors claim that clitic doubling of indefinite direct object DPs is ungrammatical in Greek simple clauses. That is, their hypothesis attempts to deal with only half of the relevant data. In the remainder of this section, I will provide an explanation as to why clitic doubling of indefinite associates of restrictive relative clauses is possible.

In Albanian, restrictive relative clauses are of two types: one type is introduced by the complementizer *që* 'that', as was illustrated above in (66), and the other type is introduced by a *wh*-relative pronoun, as is shown in (68) below.

- (68) Lexova një libër të cil-in *(e) mora në bibliotekë.
 read-I a book agr which-the it_{cl,acc} got-I in library
 'I read a book which I got from the library.'

Note that there is a definite determiner suffixed to the relative pronoun, so clearly the relative pronoun cannot be in the C^0 slot as it shows phrasal characteristics (for instance, it agrees with the indefinite head in phi-features) but not with respect to the

definiteness feature. Therefore the relative pronoun in (68) has to be in some specifier position.⁴³ But if Spec of CP is already occupied by the indefinite relative clause associate *a book*, another Spec position lower than Spec of CP is needed for the relative pronoun. Like in English, the relative pronoun in Albanian involves a *wh*-element, which in this language is preceded by some agreement morpheme (glossed *agr* in (68)) which is lacking when the *wh*-word is used for question formation. This agreement morpheme, which also agrees with the associate of the relative clause in phi-features (number, case, gender) necessarily precedes genitive modifiers of nouns as well as a lexically idiosyncratic group of adjectives. Nothing may intervene between this agreement morpheme and the noun or adjective that it precedes. In view of these morphological facts, at least one (agreement) projection lower than the CP is needed.

Alternatively, the raised indefinite associate does not occupy Spec of CP but some higher position. The question of course arises what the trigger for such a movement would be, if movement is actually involved. I suggest that the associate of the relative clause is indeed higher than Spec of CP when it is indefinite, but not as a result of movement.

Before I present the details of my analysis, let me emphasise two startling facts: First, the relative pronoun cannot introduce a relative clause whose associate is

⁴³ It is also unclear how a Kaynian analysis would accommodate data like: *the boy whose father I met*. If the structure assigned to such data is something like the string in (i), it is unclear which position the *wh*-phrase *whose father* occupies.

(i) [DP the] [CP [NP boy_i] [_{7P} whose father] I met t_i]
Crucially, this string is also grammatical in Albanian.

definite (relative clauses whose associates are definite are exclusively introduced by the complementizer *që* ‘that’), as the examples in (69) show.⁴⁴

(69) a. Lexova libr-in që (*e) mora në bibliotekë.
 read-I book-the that it_{cl,acc} got-I in library
 ‘I read the book which I got from the library.’

b. *Lexova libr-in të cil-in (e) mora në bibliotekë.
 read-I book-the agr which-the it_{cl,acc} got-I in library
 ‘I read the book which I got from the library.’

Second, the doubling clitic is obligatory when the relative clause is introduced by a relative pronoun (in which case the associate of the relative clause cannot be definite), as was shown in (68).

What these facts suggest is that the position of the associates of restrictive relative clauses might indeed be different depending on their (in)definiteness feature, in line with A&A. I propose that the difference, however, lies in the fact that while the definite associate of a restrictive relative clause (cf. (69a)) is raised from the embedded clause to the matrix clause possibly in the way Kayne proposes, the indefinite associate in (68) is not raised from the embedded clause but is generated as

⁴⁴ The validity of this statement is restricted to constructions where the definite associate of the relative clause surfaces as the direct object of the matrix verb, though. In other words, in examples like (i), where what looks like a definite associate is not a direct object but a predicate nominal, the relative clause may be introduced either by a relative pronoun or by the complementizer. Moreover, while the doubling clitic may be present when the relative clause is introduced by the complementizer *që* but doesn’t have to be, it is obligatorily present when the relative clause is introduced by a relative pronoun. I turn to the discussion of such examples later in this section.

(i) Këta janë libra-t që (i) / të cilët *(i) solli Ana.
 these are books-the that them_{cl} / which them_{cl} brought Anna
 ‘These are the books that Anna brought.’

the object of the verb in the matrix clause. Its reference is then picked up by a relative pronoun in the embedded clause. In other words, it is the relative pronoun moved to the initial position of the embedded CP and not the indefinite expression that is the complement of the verb *get*. The structural difference between the sentence in (69a) and that in (68) is depicted graphically in the tree diagrams in (70) and (71), respectively.⁴⁵

(70)

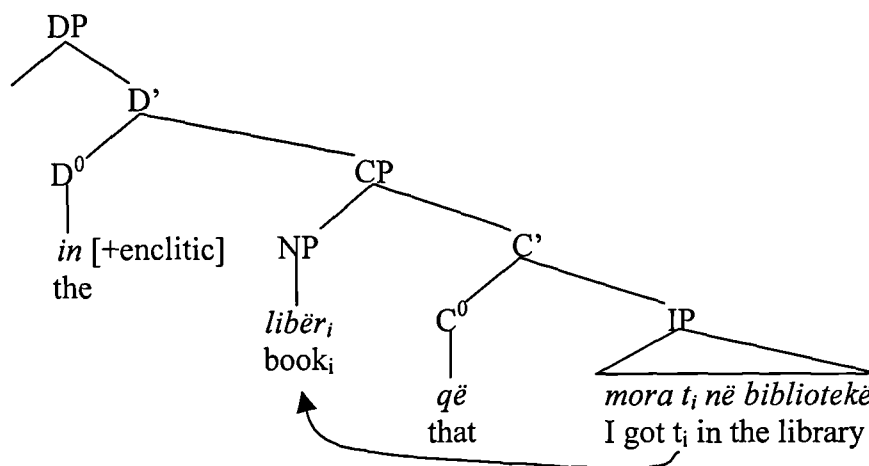

⁴⁵ Since the definite determiner in Albanian encliticizes on the noun stem, one needs to also explain how such an order obtains. I discuss the internal structure of the Albanian DP in some detail in chapter 3 (section 3.5). There I suggest that the [+enclitic] feature of the definite determiner in D⁰ triggers overt movement of N⁰.

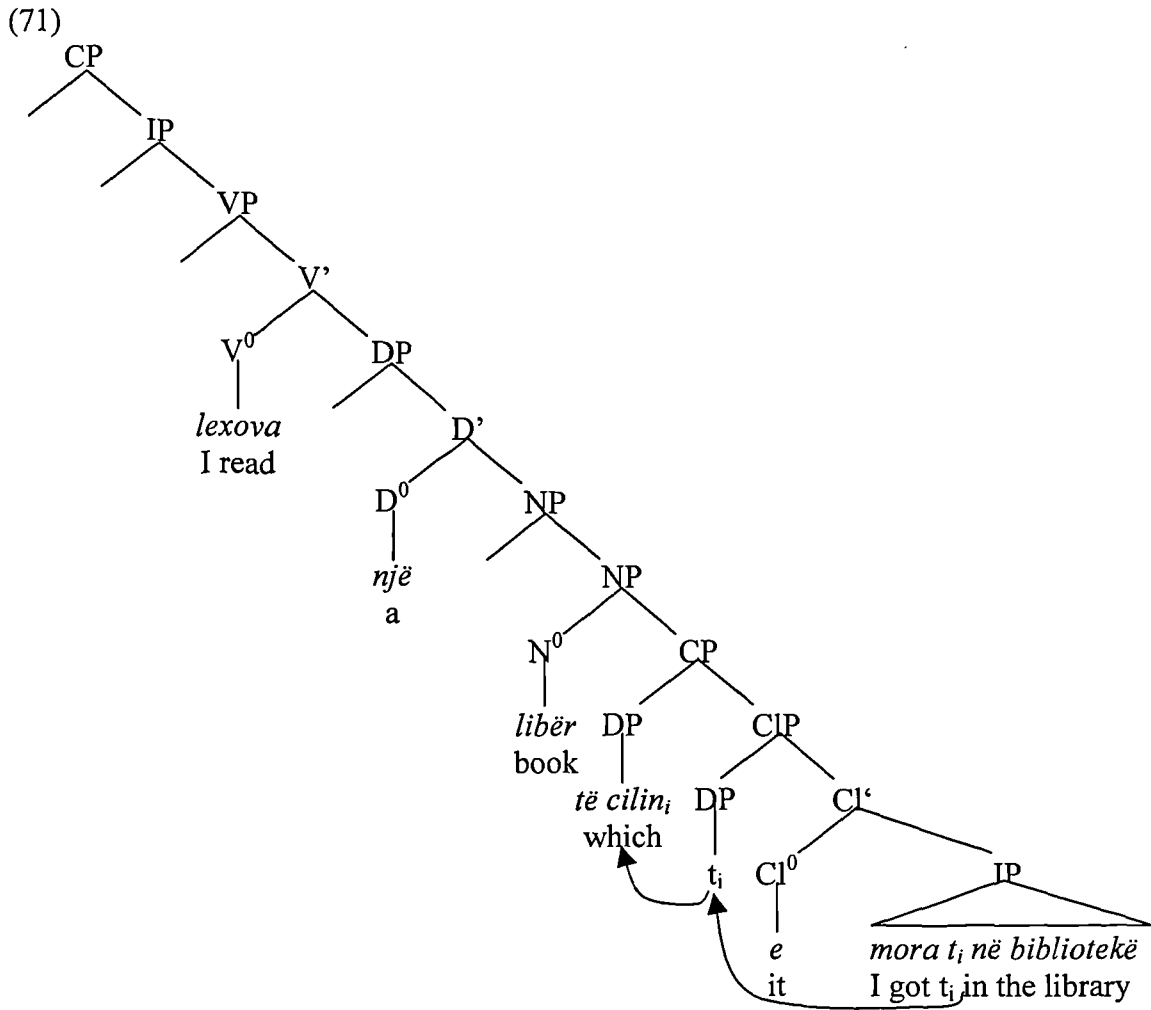

The analysis that I have proposed would explain among other things why the relative pronoun in Albanian has a definite form (i.e. it is suffixed with a definite determiner): it resumes the discourse referent that the expression *a book* establishes. Consequently, the clitic does not double the indefinite expression *a book*, but the relative pronoun that is discourse-linked with the indefinite. The obligatoriness of the doubling clitic in (68) follows from the requirement that in Albanian, direct object DPs need to be clitic doubled in order to be marked [+Topic] (cf. section 2.2.5).

How can the analysis that I have developed so far account for the asymmetry observed in the examples in (66)? Note that in these examples the relative clause is introduced by the so-called complementizer *që*, not by a relative pronoun. The

analysis outlined above can account for the asymmetry in these examples only if a double-status is assigned to the element *që*. In other words, I must postulate that while *që* occupies the C^0 slot in (66b) with a definite associate, it occupies Spec of CP in (66a) when the doubling clitic is present (that is, *që* is a relative pronoun). However, since the clitic in (66a) is not obligatory, it would be more accurate to state that while *që* occupies the C^0 slot in (66b) with a definite associate, it *may* occupy Spec of CP in (66a). Recall that I accounted for the grammaticality of (68), where a doubling clitic is obligatory, by analysing the relative pronoun as a phrasal element in Spec of CP, which as a d-linked constituent, needs to be clitic doubled. If *që* were a phrasal element also in (66b), that is, if it occupied Spec of CP here, then there would be no reason why the presence of a doubling clitic in the relative clause would render the sentence ungrammatical. In other words, nothing would preclude the clitic from doubling a phrase in Spec of CP. Of course, if we were to maintain Kayne's analysis of restrictive relative clauses involving definite associates, *që* in (66b) can under no circumstances be a phrasal element in Spec of CP, since this position is already occupied by the raised bare noun (see the tree-diagram in 67).

That *që* can be a complementizer, is confirmed by the fact that like *that* in English, it also introduces non-relative complement clauses. This is illustrated in (72).

(72) An-a e kuptoi që kishte parë ëndërr.

Ann-the_{nom} it_{cl,acc} realized-3s that had-3s seen dream

'Ann realized that she had had a dream.'

However, the fact that *që* can be a complementizer (that is, occupy the C^0 -position) is neither necessary nor sufficient evidence against the idea that it can also occupy a

phrasal position. The fact that *që* is morphologically opaque (i.e. it is invariable, or does not encode overt phi-features) cannot be viewed as conclusive evidence that it is exclusively a head element. For instance, *que* in French is clearly a complementizer and just as clearly a pronoun (i.e. a phrasal element), as is obvious from the examples in (73).

- (73) a. Je regrette que Marie parte demain.
 I regret that Mary leaves tomorrow
 ‘I am sorry that Mary is leaving tomorrow.’
- b. Que voulez-vous?
 what want you
 ‘What do you want?’

One of Emonds’ (1976) arguments against the phrasal nature of *that* in English involves the fact that it cannot occur in non-restrictive relatives. However, this argument does not carry over to Albanian: *që* here can freely occur in non-restrictive relatives, as the example in (74) illustrates. This is also the case for *que* in French, as the example in (75) illustrates.

- (74) Ana, *që* kishte patur ditëlindjen një ditë përpara, nuk përgjigjej.
 Ann, that had had birthday a day before, not answered
 ‘Ann, whose birthday had been the day before, was not answering.’

- (75) Cette maison, que nous préférons tous, est trop chère.
 this house which we prefer all is too expensive
 ‘This house, which we all prefer, is too expensive.’

In sum, there is no evidence that *që* in Albanian cannot occupy a phrasal position.

This reasoning may also be extended to *pu*, the Greek counterpart of the Albanian *që*. Thus, we have a straightforward account for the asymmetry observed in the distribution of direct object clitic doubling in restrictive relative clauses in Albanian and Greek: while *që/pu* occupy the C⁰ slot in relative clauses restricting definite associates, they *may* occupy Spec of CP in relative clauses restricting indefinite associates. In the latter case, they may be clitic doubled.

Another argument can be construed in favour of the status of *që* both as a complementizer and as a relative pronoun (that is, both as head element and as a phrasal element). In footnote 44, I pointed out that the asymmetry illustrated in the examples in (65) and (66) is not replicated in Albanian when relative clauses restrict a predicate nominal DP. In other words, when relative clauses restrict a definite predicate nominal DP, a doubling clitic in the relative clause is licit. This is demonstrated in (76).⁴⁶

⁴⁶ One could attempt to analyse examples like (76) as specificational sentences. As Higgins (1979) points out, a distinguishing mark of specificational sentences is the fact that the subject and the predicate complement can apparently change places. But as (i) shows, this is possible for (76) only in the absence of the doubling clitic. This might be taken to imply that the DP *libra-t* ‘the books’ in (76) is indeed a predicate nominal and not a subject, as it seems to be in (i).

(i) *Libra-t që (*i) solli Ana janë këta.*
 books-the that them_{cl} brought Anna are these
 ‘The books that Anna brought are these (ones).’

If the structure of (i) is the one given in (ii), then the facts depicted in (i) are not that surprising.

(ii) [_{IP} [_{DP} *libra-t*] [_{CP} [_{NP} *N_j*]_i *që* [_{IP} *solli* [_{VP} *Anna t_i*]]]] *janë* [_{VP} [_{DP} *këta*]]].

- (76) Këta janë libra-t që (i) solli Ana.
 these are books-the that them_{cl} brought Anna
 ‘These are the books that Anna brought.’

Obviously, Kayne’s approach does not readily account for the facts in (76). That is, if we were to extend A&A’s analysis of relative clauses that restrict a definite object to relative clauses restricting predicate nominals, the clitic in (76) would be a counterexample. If, however, the predicate nominal *libra-t* ‘the books’ in (76) is generated outside the relative clause (that is, if it is generated in the matrix predicate nominal position), at least in the case when the doubling clitic is present in the relative clause, and the element *që* is indeed a relative pronoun and not a complementizer in this case, then we have a straightforward account for why doubling is possible: the clitic doubles the relative pronoun in Spec of CP, not the definite predicate nominal DP.

I have thus shown that a fully uniform analysis of restrictive relative clauses in Albanian is untenable as it cannot account for the asymmetries observed in restrictive relative clauses with respect to the distribution of direct object doubling clitics. While the promotion or head-raising analysis of restrictive relative clauses advocated in Schachter (1973), Vergnaud (1974), and more recently Kayne (1994) may account for a certain set of data, there is yet another set of data which the head-raising analysis fails to accommodate but which are accounted for in a straightforward manner under Chomsky’s (1973, 1977) analysis of relative clauses, which construes the relative clause associate as generated in the matrix clause. In this context, cf. also Áfarli (1994), who crucially argues that while a promotion analysis of restrictive relative clauses must be assumed at least for some types of restrictive relative clauses in

Norwegian, such an analysis does not account for all the data; there is a type of restrictive relative clauses in Norwegian where the relative clause associate is actually generated in the matrix clause, and where the relative clause is related to that associate along the lines of predication, as suggested in Chomsky (1982, 1986).

To conclude, the asymmetries in the distribution of direct object doubling clitics in restrictive relative clauses in Albanian and Greek derive from structural differences between two types of restrictive relative clauses. While in one type of restrictive relative clauses the associate or (its head) raises from inside the relative clause, there is yet another type of restrictive relative clauses whereby the associate of the relative clause is generated inside a matrix clause.

2.3.5. Speculations on Clitic Doubling of Direct Object *Which*-phrases

In footnote 21, I pointed out that in Albanian and Greek direct object *which*-phrases may be clitic doubled and that this fact constitutes an apparent counterexample to my statement in section 2.2.2 that DO *wh*-phrases in Albanian and Greek cannot be clitic doubled. Formally, the sentence in (77a) differs from the one in (77b) in that in the latter the direct object *which*-phrase is clitic doubled.

- (77) Al: a. Cil-ët libra solli Ana?
 which-the books brought Anna
 ‘Which books did Anna bring?’
- b. Cil-ët libra i solli Ana?
 which-the books them_{cl} brought Anna
 ‘Which books are those that Anna brought?’

As the English translations of the sentences in (77) suggest, there are very clear interpretative differences between the sentence in (77a) and that in (77b).

Both sentences (77a,b) seem to presuppose that Anna brought certain books. Several scholars have analysed *which*-phrases as definite expressions (cf. Katz & Postal (1964), Kuroda (1969)). Such an approach predicts that *which*-phrases, like definite expressions, are presuppositional. The *which*-phrases in (77a) and (77b) could then be viewed as the source of the presupposition that these sentences carry, namely that Anna brought certain books. What is puzzling is the fact that while this presupposition can be cancelled for (77a), it cannot for (77b). For instance, while a sentence like (78) would be a felicitous answer for (77a), it would not be so for (77b).

(78) Në fakt Ana nuk solli asnjë libër.

in fact Ann not brought no books

‘As a matter of fact, Ann brought no books.’

I suggest that the meaning differences between (77a) and (77b) are related to structural differences between them. More specifically, I suggest that while the sentence in (77a) is monoclausal, that is, derived from the structure in (79), the one in (77b) is bi-clausal; the latter involves a concealed relative clause.

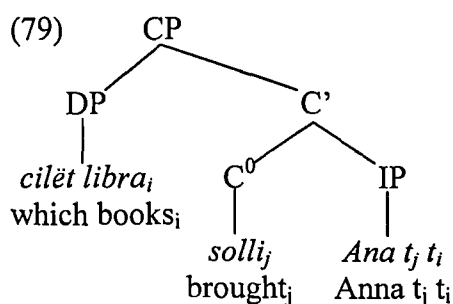

I will present several arguments for why I think that (77b) is not derived from the structure in (79) and for why (77b) must involve a bi-clausal structure to be correct instead. I will outline several derivational possibilities that could have this result. I will not, however, attempt to provide a fully worked out picture of how the derivation technically proceeds. Such a complete analysis requires further research on deletion and copy phenomena and a discussion of these phenomena is outside the scope of this study. For this reason, my proposals for the structure of the construction illustrated in (77b) remains somewhat speculative.

An argument which strongly speaks against treating (77b) on a par with (77a) and hence against assigning the structure in (79) to it involves the following facts. While the *which*-phrase in (77a) can reconstruct in a way that enables it to be interpreted as an echo-question, the clitic doubled *which*-phrase in (77b) cannot do so. This contrast is illustrated in (80a) vs. (80b).

- (80) a. Ana solli cilë-t libra?
 Anna brought which books
 ‘Anna brought which books?’
- b. *Ana i solli cilë-t libra?
 Anna them_{cl} brought which books

The ungrammaticality of (80b) is predicted under my hypothesis that (77b) is bi-clausal, that is, involves a concealed relative clause. Under this hypothesis, the constituent *cilët libra* ‘which books’ is not raised from the object position of the verb *solli* ‘brought’, which I analyse as the verb of an embedded clause, but is generated in the matrix CP. As such, it will not be expected to reconstruct in the object position of

the verb *solli* ‘brought’. What the clitic doubles in (77b) is not the *which*-phrase in Spec of the matrix CP but some phonetically null element co-referent with the *which*-phrase.

I suggest that sentences like (77b) are derived from any of the construction types given in (81), through appropriate movement and deletion operations. Note that the strings in (81) are all grammatical in Albanian.

- (81) a. Cil-ët libra janë (ata) që/të cilët i solli Ana?
 which-the books are those that/which them_{cl} brought Anna
 ‘Which books are the ones that Anna brought?’
- b. Cil-ët janë libra-t që/të cilët i solli Ana?
 which-the are books-the that/which them_{cl} brought Anna
 ‘Which are the books that Anna brought?’
- c. Cil-ët janë (ata) libra që/të cilët i solli Ana?
 which-the are (those) books that/which them_{cl} brought Anna
 ‘Which of these are books that Anna brought?’

Recall from the previous section that *që* that in Albanian can be either a complementizer or a relative pronoun. Given that in all the examples in (81) *që* is interchangeable with a relative pronoun, I assume that in these examples *që* is a phrase and therefore occupies Spec of CP. As suggested for the examples (66a) and (68) in the previous section, I claim that in the examples (81a-c) it is not the *which*-phrase in the Spec of the matrix CP that the clitics in the relative clauses double, but the relative pronouns that are raised from the direct object base position to the specifier position of the embedded clauses and that are co-referent with the *which*-phrases in the Spec of

the matrix CP. In other words, I exclude a head-raising analysis for the sentences in (81a-c).⁴⁷ What is crucial to note is that the *which*-phrases in Spec of the matrix CP do not involve raising from the relative clause; they are generated within the matrix CP.

Thus, examples like (77b) do not contradict the generalisation that direct object *wh*-elements may not be clitic doubled.

2.4. Conclusion

In this chapter, I have shown that direct object clitic doubling in Albanian and Greek produces information structure in a systematic way: doubled DPs are unambiguously interpreted as topics, irrespective of their definiteness feature. I have thus provided a uniform account of clitic doubling for both definite and indefinite DPs. I have shown that certain asymmetries in the distribution of direct object clitic doubling in restrictive relative clauses arise from differences relating to the position of the associate of the relative clause.

The fact that direct object clitic doubling is an operation which invariably licenses topichood on direct object DPs suggests that topichood is, at least in part, encoded in the syntax for these languages. Whether this is the case universally and whether the representation of topics involves the same syntactic configuration cross-linguistically, remain issues subject to further study.

In Chapter 3, I will show that specificity related effects often attributed to direct object clitic doubling and scrambling constructions are only epiphenomenal.

⁴⁷ This is not to say that the *which*-phrases are base generated in Spec of matrix CP. They might be generated in subject or in predicate nominal position; deciding between these alternatives is not important for my purposes here.

Chapter 3

Semantic Evaluations of the Syntax of Noun Phrases

3.0. Introduction

In chapter 2, it was pointed out that while definite and indefinite DPs with overt determiners may in Albanian and Greek be clitic doubled and in German scrambled, in which case they are unambiguously interpreted as topics, neither singular nor plural bare indefinites may do so if the latter occur within the scope of an existential quantifier. A legitimate question is why this is so. To address this question a broader investigation of bare indefinites is necessary. This is the main task of the present chapter. I will approach the question of why bare indefinites cannot generally be doubled and scrambled by examining and explaining first why count bare singulars cannot be doubled and scrambled. Because of the fact that count bare singulars have not been the object of any comprehensive study in the literature so far, I will devote a substantial discussion to their syntax and their semantics. This will in turn pave the way for an explanation of why bare plurals in non-generic contexts cannot be doubled and scrambled.

In chapter 2, I showed that clitic doubling of direct object DPs in Albanian and Greek does not induce specificity on these DPs, as has been claimed for Romance (cf. Sportiche (1992), Uriagareka (1995), *i.a.*). In this chapter, I will argue instead that the locus of specificity is the D-position (cf. Abney 1987), which for noun phrases underlies argumenthood (cf. Longobardi 1994). Importantly, it will be argued that argument clitics carry a D-feature, which is why they may double only DPs, not NPs, and that specificity, presuppositionality and/or strength effects often attributed to clitic constructions (cf. Sportiche (1992), Uriagareka (1995), Anagnostopoulou (1994) *i.a.*) are only epiphenomenal, straightforwardly derived through the need to feature-match. Here I obviously depart from the view that an NP is exclusively a complement of D (cf. Abney 1987) and more generally from the implication that once a functional projection is available at least within a given language, it is always present/syntactically active in that language even though at times it may be inert/morphologically empty (cf. Chomsky 1995).¹ The advantage of this distinction between DPs and NPs is that it will allow for a more principled mapping between syntax and semantics.

3.1. Count Bare Singulars: The Basics

Across several languages of Europe, notably Balkan and Mainland Scandinavian (hence: MS) languages, there exists for non-quantified singular countable noun

¹ Note, however, that this does not mean that the D-position cannot be morphologically empty. In fact, in the following sections of this chapter, I will argue that count bare singulars and existential bare plurals are not DPs with a morphologically null D, but NPs altogether lacking a D-projection. By contrast, generic bare plurals are DPs with morphologically null Ds. Moreover, I do not exclude the possibility that a given language may require structural DPs, even in predicate nominal position.

phrases² a threeway formal distinction for the category of definiteness, namely: (i) definite noun phrases, (ii) indefinite noun phrases with article and (iii) indefinite noun phrases without article.³ This distinction is illustrated in the examples in (1). (For convenience, I illustrate with examples from Albanian and Norwegian only.)

(1)a. Al: Ana do të blejë biçikletë-n.

a'. No: Anne ønsker å kjøpe sykkel-en.

Ann wants to buy bike-the

‘Ann wants to buy the bicycle.’

b. Al: Ana do të blejë një biçikletë.

b'. No: Anne ønsker å kjøpe en sykkel.

Ann wants to buy a bicycle

‘Ann wants to buy a bicycle.’

c. Al: Ana do të blejë biçikletë.

c'. No: Anne ønsker å kjøpe sykkel.

Ann wants to buy bicycle

‘Ann wants to buy a bicycle.’

² Throughout this dissertation, the term *noun phrase*, unlike *DP* and *NP*, is used theory-neutrally.

³ I assume in the spirit of Heim (1982) and contra Russell (1905) that definite and indefinite noun phrases are not quantificational. Unlike Heim, who treats definite and indefinite noun phrases as variables, I assume that they are ambiguous between a variable and a predicative interpretation (cf. also van Geenhoven 1996).

I will refer to countable singular indefinite noun phrases with the singular indefinite article/determiner as *a-expressions* (cf. Chastain 1975), and to count indefinite noun phrases without articles as *bare singulars*.⁴

In the following section, I put forward my proposal as to why bare singulars cannot be doubled or scrambled.

3.2. Why Bare Singulars Can't Be Doubled: The Proposal

While singular DPs with overt determiners may be doubled and scrambled irrespective of their [\pm definite] feature in the languages under scrutiny, bare singulars cannot. This was shown in the examples in (51) in chapter 2 which are repeated here in (2). These examples show that doubled and scrambled bare singulars are ungrammatical in any contexts.

- (2) a. Al: An-a donte t-(*a) blente fustan.
 b. Gr:I Anna ithele na (*tis) aghorasi forema.
 the Ann wanted SUBJ-her_{cl} buy dress
 'Anna wanted to buy a dress.'
 c. Dt: Ich habe (*Zeitung) nicht/im Garten (Zeitung) gelesen.
 I have newspaper not/in the garden (newspaper) read
 'I have not read a newspaper.' or: 'I have read a newspaper in the garden.'

vs.

⁴Of course, the term *bare singular* as used throughout this dissertation implies a three-way formal opposition, namely: *definite noun phrases* vs. *indefinite noun phrases with articles* vs. *indefinite noun phrases without articles*. That is, the term does not cover non-quantified noun phrases in languages like Russian or Icelandic which lack articles/determiners.

a'. Al: An-a donte t-(a) blente një fustan.

b'. Gr: I Anna ithele na (tis) aghorasi ena forema

the Ann wanted SUBJ-her_{cl} buy a dress

'Anna wanted to buy a dress.'

c'. Dt: Ich habe (eine Zeitung) nicht/imGarten (eine Zeitung) gelesen

I have (a newspaper) not/in the garden (a newspaper) read

'I have not read a paper.'/'I have read a paper in the garden.'

The sentences (2a) and (2b) are ungrammatical when the bare singular objects are doubled in spite of the fact that the clitics and the direct object bare singulars here agree in (the existing) phi-features (that is, they agree in number, person and gender, since bare singulars, like a-expressions, are not marked for morphological case in Albanian and Greek). Why then can bare singulars not be doubled/scrambled?

To the extent that this question has been addressed at all, bare singulars have been treated as forming a complex predicate with the clausal predicate (cf. Haiden 1996), that is, as incorporating semantically.⁵ The implication here is that scrambling is an operation that only applies to arguments, not to predicates. While the view that bare singular objects form a complex predicate with the clausal verb might seem intuitive, the fact that count bare singular objects need not be adjacent to the clausal predicate but may be *wh*-moved,⁶ as illustrated in (3), shows that any semantic incorporation

⁵ Haiden only discusses bare singulars in German (i.e. with respect to scrambling, not to clitic doubling).

⁶ Here I am not implying that if a constituent occurs clause-initially it necessarily occupies Spec of CP. I am only assuming with Brody (1990) that Spec of CP is one (of the) canonical position(s) for [+Focus] phrases and since the fronted constituents in (3) are indisputably [+Focus], it makes sense to assume that they occupy precisely this slot. However, I remain open to the idea that there is above the

does not result from syntactic incorporation of the bare singular into V. Moreover, since part of this so-called complex predicate may be *wh*-moved, a putative semantic incorporation cannot be viewed as a purely lexical process either.

- (3) a. Al: Fustan doja tē bleja.
 dress wanted to buy
 ‘It was a dress that I wanted to buy.’
- b. Dt: Zeitung habe ich gestern gelesen.
 newspaper have I yesterday read
 ‘It was a newspaper that I read yesterday.’

The question then arises as to what advantages saying they are complex might have.

Nonetheless, the formal analysis of the impossibility of doubling and scrambling bare singulars that I am about to propose will accommodate the intuition that bare singular objects seem to form a complex predicate with the clausal predicate.

I propose that the impossibility of doubling and scrambling bare singulars is due to feature mismatch between the clitic head and the direct object bare singular with respect to the D-feature; while clitics carry a D-feature (cf. Emonds (in press), Uriagareka (1995)), bare singulars are NPs that altogether lack a D-projection. Clitics are listed in the lexicon as separate morphophonological units; that clitic heads carry a D-feature is not surprising, in view of the fact that they originate from personal and demonstrative pronouns which are prototypical D-heads (cf. Abney 1987 and

CP-node a projection headed by some operator which licenses topichood or D-linking in its specifier position (cf. Pesetsky 1987).

subsequent literature).⁷ This means among other things that only DPs but not NPs may be doubled and scrambled, since the [-D] feature of the latter will clash with the [+D] feature on the clitic head, thus causing the derivation not to converge. This reasoning, however, rests on the assumption that bare singular NPs lack a D-projection, which seems to run counter to Longobardi's (1994) proposal that only DPs but not NPs may function as arguments, his idea being that bare noun objects have a morphologically null D-head. Therefore, the assumption that bare singulars are NPs and not DPs with a morphologically null D, an idea that dates back to Hellan (1986), is in need of some justification. Is there any evidence that legitimizes the claim that bare singulars lack a D-projection? In the following sections, I will argue that there is. The evidence involves facts concerning the semantic properties and the syntactic behaviour of bare singulars. I will start by discussing the asymmetries of bare singulars with respect to their function in different grammatical relations.

3.3. The Distribution of Bare Singulars in Differing

Grammatical Relations

Longobardi (1994) observes that a singular countable head noun not introduced by an overt determiner may not occur in Italian in any of what he refers to as “major positions” suitable for arguments, such as subject, direct object, prepositional object and inverted subject of either ergative or unergative predicates. He notes that this constraint does not however hold for nominals in typical non-argument function, such

⁷ Alternatively, it might be stated that clitics are specified in the lexicon as elements of the category D^0 or are underlying determiners (cf. Postal (1969), Raposo (1997)).

as in vocative, predicative or exclamatory contexts. He provides the following examples (Longobardi 1994: 612).

- (4) a. *Caro amico, vienni a trovarmi.*

Dear friend, come to visit me

- b. *Tenente, esegua l'ordine!*

lieutenant, perform the command

- (5) a. *Gianni è tenente.*

Gianni is lieutenant

- b. *Gianni è amico di Maria.*

Gianni is friend of Maria

- c. *L'ho promosso tenente.*

I promoted him lieutenant

- d. *Ti credevo amico di Maria.*

I believed you friend of Maria

- (6) a. *Diavolo!*

Devil

- b. *Maledetto tenente!*

Damn lieutenant

Bare singulars in predicate nominal position are also commonly found in other languages. For instance, it is a well-known fact that in a language like German, the counterpart of the English sentence in (7) containing a predicate nominal is normally

rendered as in (8). That is, while in English the indefinite determiner obligatorily accompanies singular countable (i.e. non-mass, non-abstract) nouns even when these occur as predicate nominals, German uses a bare singular in this function.

(7) John is a student.

(8) Johann ist Student.

Johan is student

‘Johan is a student.’

Further, bare singular predicate nominals are found in Dutch, Portuguese, as well as in all Balkan and MS languages.⁸ Some examples of bare singulars as predicate nominals in several languages are given in (9) through (12).

(9) Al: a. Nëna ime është mësuese.

mother my is teacher

‘My mother is a teacher.’

b. E konsideroj shok.

him_{cl} consider-I friend

‘I consider him a friend.’

⁸In this way, the languages that have bare singulars may then all be characterized as languages that for count singular nouns display a three-way formal distinction for the category of definiteness, namely definite nouns vs. indefinite nouns with article vs. indefinite nouns without article.

(10) Gr: I Anna ine dhaskala.
the Anna is teacher
'Anna is a teacher.'

(11) No: Per er lærer.
Per is teacher
'Per is a teacher.'

(12) Swedish: Torun är journalist. (Börjars 1994:332)
Torun is journalist
'Torun is a journalist.'

As it happens, bare singulars are more restricted across Indo-European languages as direct objects than as predicate nominals. Thus, direct objects may be instantiated by bare singulars mainly in Balkan and MS languages;⁹ bare singular direct objects are entirely absent in Italian and Portuguese, with German and Dutch occupying a place somewhere in between. Finally note that bare singulars are also found in a restricted set of predicative prepositional phrases even in English: e.g. *go to school/church/market; be in hospital* etc. In this context, Longobardi also observes that in Italian too there are some kinds of PPs that allow articleless singular nouns. He provides the examples in (13). With respect to these, he suggests that it is not implausible to assimilate them to predicative expressions on semantic grounds.

⁹ Another striking formal similarity between (many) Balkan and MS languages is the fact that the definite determiner in both languages occurs suffixed to the noun stem (cf. e.g. (18a, a')).

- (13) a. in abito lungo
 in long dress
 b. di buona famiglia
 of good family

Crucially, bare singulars do not occur as subjects, as the examples in (14) demonstrate (cf. also Farkas (1985) on bare singulars in Romanian).^{10,11}

- (14) a. Al: *(Një) grua u duk papritmas.
 b. No: *(En) dame dukket opp plutselig.
 *(a) woman appeared suddenly
 ‘A woman appeared suddenly.’

At first sight, a construction like the Norwegian sentence in (15) might seem to constitute a counterexample to the generalisation that subjects cannot be instantiated by bare singulars.

¹⁰ In some Balkan languages (e.g. Albanian, Greek, Bulgarian), bare singulars may occur in what appears to be a subject position. This obtains only with unergative or transitive predicates but not with ergative predicates. I postpone the discussion of these seemingly bare singular subjects to section 3.4.6. For the moment, let me just mention in passing that these subject-looking bare singulars are invariably marked [+Focus]. That is, they cannot be interpreted as topics. This is a property that cannot be discarded as irrelevant for their status in terms of grammatical relations. As Strawson (1971) argues, a defining property of subjects is their status as topics. In section 3.4.6, I analyse these pseudo-subjects as predicate nominals occupying Spec of CP.

¹¹ The examples in (14) are fine when the indefinite article is present.

(15) Bil er dyr-t. (Hellan 1986: 95)

car_{masc,s} is expensive-neut.

However, closer inspection reveals that the bare singular in (15) cannot be the subject of the sentence. In Norwegian, adjective phrases (AP) used predicatively agree with their subject in gender, among other features. However, as Hellan (1986) notes, in (15) the predicative adjective does not agree with what appears to be a bare singular subject: the form *dyrt* ‘expensive’ is neuter, while the noun *bil* ‘car’ is masculine. If the bare singular in (15) were really the subject of the sentence, this construction would be a counterexample to the regularity of agreement.¹² This fact leads me to adopt Faarlund’s (1977) analysis according to which the subject of the sentence in (15) is not the bare singular, but an elliptic infinitival clause, as shown in (16a) or its variant (16b). That is, I maintain that (15) is derived from a construction like the one in (16a) or its variant in (16b). Consequently, the bare singular in (15) is not the subject of the sentence, but the (fronted) object of the verb of an elliptic infinitival (subject) clause.

- (16) a. Bil_i er dyr-t [å ha t_i].
 car is expensive-neut. to have
 ‘To have/run/keep/manage a car is expensive.’
- b. [Å ha bil] er dyr-t.
 to have car is expensive-neut
 ‘To have/run/keep/manage a car is expensive.’

¹² Note also that Norwegian is not a pro-drop language.

The view that the bare singular in (15) is derived from a construction like the one in (16a) or (16b) is supported by the fact that such non-agreement patterns do not arise with predicates which express inherent properties that span over the life-time of the individual of which they are predicated. In other words, they do not arise with genuine individual-level predicates. The example in (17) shows that (15) becomes ungrammatical if the adjective *dyrt* ‘expensive’ is replaced by an individual-level predicate such as *rødt* ‘red’, irrespective of whether the predicative adjective here is inflected for masculine or neuter gender. Hence the generalisation that bare singulars cannot function as subjects is not contradicted by the construction type illustrated in (15).

- (17) *Bil er rød(-t).
 car_{masc,s} is red-neut.

I will return to more on this type of paradigm in section 3.7.2.

Even in languages where bare singulars may occur as direct objects, such as in Balkan and MS languages, bare singulars do not occur as dative indirect objects.¹³

¹³ Borthen (1999) provides the following example from Norwegian where a bare singular occurs as an indirect object. (Though Borthen glosses this example, she doesn’t provide its idiomatic English translation.)

(i) Hvis du må gi hund hjertekompresjon noen gang, så rop heller på hjelp. (Borthen 1999: 2)
 if you must give dog heart-compression some time so shout rather for help

This example appears then as a counterexample to my claim that bare singulars do not occur as indirect objects. However, some Norwegian speakers do not accept the example in (i) at all (T. Åfarli – p.c.), though some do (L. Hellan – p.c.). Moreover, even those speakers for whom (i) is grammatical do not accept the grammaticality of an example like (i) if the noun *hund* ‘dog’ in it is replaced with other bare singulars like *kone* ‘wife’, *man* ‘husband’ *datter* ‘daughter’. It is also crucial to note that all verbs that can combine with bare singular direct objects may do so irrespective of the lexical-semantic features of the bare singular (e.g. in terms of features like [±animate], [±human] etc.). In other words, once a verb can take a bare singular as its direct object, whatever its lexical content, that verb is able to take any other bare singular noun as its direct object provided that the verb may combine with the given noun

That is, formally, datives pattern with subjects in that they may not be instantiated by bare singulars, as shown in (18c, c') vs. (18a,a') and (18b,b') (cf. also Kallulli 1995).¹⁴

(18) a. Al: Ana i dha biçiklet-ës/qen-it një larje.¹⁵

a'. No: Anne gav sykkel-en/hund-en en vask.

Anna gave bike-the/dog-the a wash

'Anna gave the bicycle/the dog a wash.'

b. Al: Ana i dha një biçiklete/një qeni një larje.

b'. No: Anne gav en sykkel/en hund en vask.

Anna gave a bike/a dog a wash

'Anna gave a bicycle/a dog a wash.'

c. Al: *Ana i dha biçiklete/qeni një larje.

c'. No: *Anne gav sykkel/hund en vask.

Anna gave bike/dog a wash

also in its definite form and indefinite form with article. This is obviously not the case for the verb *gi* 'give' in Norwegian in relation to its indirect object. Thus, while the bare singulars *sykkel* 'bicycle' or *hund* 'dog' cannot occur as the indirect object of the verb *gi* 'give' in the example (18c'), the bare singular *hund* 'dog' in (i) can. So, the relevant question then is: what makes the noun *hund* 'dog' acceptable in (i) (for those Norwegian speakers that accept (i)) and unacceptable in (18c')? Moreover, what makes the noun *hund* 'dog' different for those Norwegian speakers that accept (i) from the nouns *kone* 'wife', *man* 'husband' *datter* 'daughter' which cannot occur instead of *hund* 'dog' in (i)? L. Hellan (p.c.) suggests that the nouns *kone* 'wife', *man* 'husband' *datter* 'daughter' are all bad in a context like (i) because they present physically uninteresting sorts/sub-sorts. This intuition by Hellan is very interesting because it hints at a blurred boundary between count and mass nouns. In other words, it might be that the noun *hund* 'dog' in (i) is not a genuine bare singular but a mass noun or totally underspecified for the count-mass distinction.

¹⁴ Note that dative objects are subjects or specifiers in many proposals – subjects of small clauses (cf. Kayne 1984), den Dikken (1995).

¹⁵ Recall from chapter 2 that datives are invariably clitic doubled in Albanian. In the Albanian examples in (18) *i* the dative clitic is in front of the verb.

The question now arises as to whether these asymmetries of count bare singulars with respect to clausal distribution could be related to or derived from a difference in phrase structure positions. More specifically, the question is whether bare singulars, which I claim are NPs, are only allowed in complement positions but precluded in specifier positions. Subjects and dative objects are widely argued to be projected in specifier positions whereas direct objects are under most proposals generated in complement positions (cf. Chomsky (1981), Kayne (1984), Larson (1988) *i.a.*), although there have also been proposals under which all genuine non-oblique arguments of a verb are projected in specifier positions (cf. Marantz 1990).

In this context, an interesting proposal is put forward in Rapoport (1995). She argues that only specific direct objects function as true arguments of the verb, whereas non-specific objects function as verb modifiers. She proposes that this difference in function corresponds to a distinction in licensing requirements, in phrase structure position, and in interpretation. Crucially, Rapoport argues that whereas the specific direct object is projected in the specifier position of VP, the non-specific direct object is a sister of V^0 , that is, a complement of V^0 , as illustrated in (19).

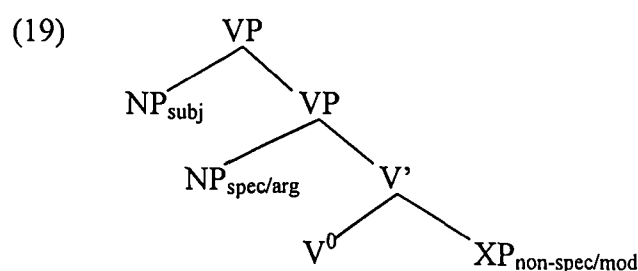

In section 3.4.2, I discuss in detail the phenomenon of specificity and show that bare singulars are necessarily non-specific. Assuming then that subjects and datives occupy specifier positions and direct objects may occupy either specifier or complement positions, the tentative generalisation in (20) emerges.

(20) Bare singulars are precluded from specifier positions.

Even though many verbs can take bare singulars as their direct objects in Balkan and MS languages, not all may do so. Thus, while verbs like *want, have, find, search, buy, draw, hunt, smoke, take, own, write, drive, read*, etc. may take bare singulars as their internal arguments, others like: *love, hate, admire, respect*, etc. may not, as the Albanian examples in (21) and the Norwegian examples in (22) show.

(21) a. Dua/kam/gjej/kërkoj/blej/lexoj libër; shkruaj/marr letër; vizatoj rreth;
I want/have/find/look for/buy/read book; I write/get letter; I draw circle
'I want/have/find/look for/buy/read a book', 'I write/get a letter',
'I draw a circle'

b. urrej *(një)djalë; admiroj *(një)gazetar; respektoj *(një)shok
I hate *(a) boy I admire *(a) journalist; I respect *(a) friend
'I hate a boy', 'I admire a journalist', 'I respect a friend'

(22) a. Jeg vil/har/ser etter/kjøper/kjører bil; jeg skriver/leser/får brev; jeg tegner hus
I want/have/look for/buy/drive car; I write/read/get letter; I draw house
'I want/have/look for/buy/drive a car', 'I write/read/get a letter',
'I draw a house'

b. Jeg hater *(en) gutt; jeg beundrer *(en) journalist; jeg elsker *(en) mann
I hate *(a) boy; I admire *(a) journalist; I love *(a) man
'I hate a boy', 'I admire a journalist', 'I love a man'

Note that the distinction between predicates that may take bare singular objects and those that do not cuts across the distinction individual vs. stage-level predicate (cf. Carlson 1977).¹⁶ For instance, while the predicate 'have' in (23) can be construed as a stage-level predicate when it is combined with the nominals 'house', 'job', 'car', and perhaps even 'brother', it tends to be interpreted as an individual-level predicate when it combines with a nominal that denotes a body part such as 'nose'. The examples in (23) also show that the distinction between predicates that may take bare singular direct objects and those that do not does not depend on the [\pm animate] feature of the object. More precisely, there is no restriction that the bare singular object be [-animate].

(23) Al: a. Kam shtëpi / punë / makinë / vëlla / hundë.

have-I house / job / car / brother / nose

No: b. Jeg har hus / jobb / bil/ bror / nese.

I have house/ job / car/ brother/ nose

'I have a house', 'I have a job', 'I have a car', 'I have a brother',

'I have a nose'

¹⁶ The distinction between individual-level and stage-level predicates was introduced by Carlson (1977). It concerns the permanence vs. non-permanence of the property that a predicate denotes. Individual-level predicates describe permanent properties of entities; they contrast with stage-level predicates, which describe temporary properties or transitory activities of entities. Milsark (1974) was the first to observe that predicates which denote some permanent property of the subject they predicate on cannot appear in the *there*-construction in English (e.g. #There are linguists intelligent.). Therefore, the *there*-construction came to be used as a test for distinguishing between stage-level and individual-level predicates. However, since the *there*-construction is subject to a definiteness constraint, it cannot always be used as a test for distinguishing between stage-level and individual-level predicates. Kratzer (1995) uses the following test as a diagnostic for stage-level predicates for those cases in which the *there*-insertion test cannot be used: if a predicate which contains proper nouns or demonstratives in its argument positions is acceptable in a clause introduced by *when(ever)*, then it is a stage-level predicate. For instance, the sentences in (i) and (ii) contrast in terms of acceptability.

(i) When(ever) Anna sees Ben, she falls over.

(ii) #When(ever) Anna respects Ben, she bows down to him.

Yet, observe that all the predicates in (22b), namely predicates that do not combine with bare singulars, are individual-level predicates.¹⁷ That is, the events that these stative verbs specify may be easily conceived of as permanent or inherent properties of their subjects. Note in this context the well-known generalisation that transitive individual-level predicates force generic (in the sense: kind-denoting) readings on their bare plural objects. Thus, for instance, the sentence *John loves girls* does not mean that there are some girls that John loves but rather girls make up or belong to a particular kind that John loves.

The fact that the distinction between predicates that can take bare singular objects and those that cannot do so similarly classifies exactly the same predicates in both Balkan and MS languages is particularly intriguing. What then is the generalisation (if any) that is relevant for the distinction between those verbs that can combine with bare singulars and those that cannot? In other words, what are the factors that govern the distribution of bare singulars?

Regarding the factors which govern the distribution of bare singulars, I suggest that they are semantic in nature. Specifically, I claim that bare singulars invariably denote properties, not individuals. However, on the assumption that a given syntactic construction cannot be systematically ambiguous, my basic working hypothesis is that semantic interpretations for noun phrases are fundamentally dependent on their internal structure. That is, some sort of systematic mapping between structure and interpretation corresponds to the null hypothesis. In this perspective, I crucially draw a distinction between DPs and NPs, departing in this way from the view that an NP is

¹⁷ In fact individual-level predicates might be assimilated to statives, but since there are also stage-level predicates which are aspectually stative, I will continue to operate with the term individual-level predicates.

exclusively a complement of D (cf. Abney 1987) and more generally from the implication that once a functional projection is available at least within a given language, it is always present/syntactically active in that language even though at times it may be inert/morphologically empty (cf. Chomsky 1995). This does not entail, however, that there are no DPs with morphologically null Ds. That is, as already stated above, I am not claiming that the D-position cannot be morphologically empty while syntactically present.¹⁸ More precisely, I claim that whereas DPs may denote either individuals or properties (irrespective of whether the D-slot contains morphological material or is morphologically null), NPs invariably denote properties. That is, NPs cannot denote individuals.

What is the difference between individuals and properties? While individuals are saturated structures, properties are unsaturated structures (cf. Chierchia 1985). Turning to saturation, here is what Frege says on it:

“Statements in general, just like equations or inequalities or expressions in Analysis, can be imagined to be split up into two parts; one complete in itself, and the other in need of supplementation, or ‘unsaturated’. Thus, e.g., we split up the sentence ‘Caesar conquered Gaul’ into ‘Caesar’ and ‘conquered Gaul’. The second part is ‘unsaturated’ – it contains an empty place; only when this place is filled up with a proper name, or with an expression that replaces a proper name, does a complete sense appear... In this case the argument is ‘Caesar’.” (Frege 1891: 31)

And further:

“And it is a natural conjecture that logical combinations of parts into a whole is always a matter of saturating something unsaturated.” (Frege 1923-6: 36-51; as translated in Heim and Kratzer (1998) p. 3)

¹⁸ Indeed, in section 3.4 through 3.7, I argue that count bare singulars and existential bare plurals are not DPs with a morphologically null D, but NPs altogether lacking a D-projection. Consequently, they are not arguments, but predicates at LF. By contrast, generic bare plurals are DPs with morphologically null Ds.

Since saturation is the basic ingredient of argumenthood, it follows that individuals are arguments. Properties, on the other hand, being unsaturated structures, are not arguments but predicates. What this means is that if DPs may denote both individuals or properties, then DPs may be either arguments or predicates at LF. In contrast, if NPs cannot denote individuals but only properties, then they invariably are predicates, not arguments at LF. Consequently, NPs are not variables or restricted quantifiers.

Recall from section 3.2 my claim that bare singulars are not DPs with a morphologically null D, but NPs altogether lacking a D-projection. If bare singulars really lack a D-projection, that is, if they are NPs and not DPs, then they are LF predicates, not arguments. Since bare singulars occur as predicate nominals and direct objects (or objects in certain PPs in English), predicate nominals and direct objects are not exclusively DPs; they may be NPs. That is, direct objects are not always arguments; they can be predicates as is the case when they are instantiated by bare singulars. That the direct object position is not always an argument position has been noted at least since Quine (1960), who observed that the object position of certain verbs is not always a “referential” position, where “referential” in his terminology is used in opposition with “predicative”, that is, in a sense very close to “individual-denoting”.¹⁹

Yet, intuitively, we would like to think that the bare singular direct object receives its theta-role from the verb much in the same way as a definite or indefinite expression does. (In this context, there are languages like English which do not have the option of instantiating direct objects by bare singulars.) Moreover, while bare singulars may

¹⁹ In Quine’s system, there is some terminological confusion since the term “referential” is used in opposition with both “predicative” and “opaque”. This confusion disappears in my system where Quine’s “opaque contexts” arise precisely when a verb combines with a property (or an LF predicate). This issue is discussed in more detail in the following section.

occur as direct objects, there are no predicates that select only bare singulars as their internal argument. Drawing on work by Zimmermann (1993), I assume that many (though not all) natural language predicates can take both individuals or properties as their internal arguments (cf. also van Geenhoven 1996).

I discuss the meaning of bare singulars in finer detail in the next section.

3.4. The Meaning of Bare Singulars

In this section I show that bare singulars invariably denote properties, not individuals. I argue that it is precisely in terms of the distinction individual vs. property-denotation that the distinction specific vs. non-specific for noun phrases makes sense. As we will see, count bare singulars provide an excellent means for the discussion of specificity. This discussion is essential for this study, as I intend to show that specificity cannot be bestowed on an argument by a clitic, and I wish to demonstrate eventually that specificity related effects in clitic doubling and scrambling constructions arise only as an epiphenomenon.

3.4.1. Properties vs. Individuals

A particular insight which has received considerable attention in recent semantic literature is that noun phrases in addition to denoting individuals (that is, actual objects), as in (24), or kinds of individuals, as in (25), may also denote properties. Intuitively, the property-denoting function of noun phrases might be illustrated by sentences where a noun phrase occurs as a predicate nominal, as in (26).

(24) [Eva]/[The baby] was hungry.

(25) [Every dog] barked.

(26) Fido is [a dog].

The property-denoting function of noun phrases is however not restricted to predicate-nominal position. Quine (1960) was perhaps the first to note and discuss the fact that bare plural noun phrases in English may denote creatures other than bodies/actual objects when they occur as objects of a certain class of verbs. To quote:

“Yet a further kind of work is done by the plural in such an example as 'Ernest is hunting lions', if what is meant is not that he is intent on a certain lion or lions but just that in his unfocused way he is out for lions. Benighted persons can in this sense even hunt unicorns. (Quine 1960: 134) ...'Hunt' in [this] use, and in 'unicorn-hunting' and in the commonest use of lion-hunting, is not a term; it is an opaque verb whose use is clarified by the paraphrase [:] [] Ernest is endeavoring (-to-cause) himself to shoot a lion.” (Quine 1960: 155)

Further, in his discussion of opacity, Quine notes that:

“... the verbs 'hunting', 'wanting' and the like, ... cannot in general be looked upon as relating the agent to actual objects.” (Quine 1960: 245)

I want to show that the verbs quoted above belong to the class of verbs that can combine both with individuals or properties. Quine's opaque verbs are thus nothing else but the combination of a verb with a property. Properties here also correspond to Strawson's (1971) feature-concepts:

“It is worth adding that sometimes we do find verbal indications of our use of feature-concepts such as those we are trying to envisage; as for example, when we speak of 'smelling cat' or 'hunting lion', using the noun in the singular without the article.” (Strawson 1971:41).

Let me now show that it is precisely in terms of the distinction individual vs. property-denotation that the distinction specific vs. non-specific for noun phrases should be understood.

3.4.2. Specificity, Individuation, Argumenthood

Consider the examples in (27). (The examples in (27a,b) and (27a', b') are repeated from section 3.2 ((2a,b) and (2a',b'), respectively).)

- (27) a. Al: An-a donte të blente fustan.
 b. Gr: I Anna ithele na aghorasi forema.
 the Ann wanted SUBJ buy dress
 c. No: Anna ville kjøpe kjole.
 Ann wanted buy dress
 ‘Anna wanted to buy a dress.’

vs.

- a'. Al: An-a donte të blente **një** fustan.
 b'. Gr: I Anna ithele na aghorasi **ena** forema
 the Ann wanted SUBJ buy **a** dress
 c'. No: Anna ville kjøpe **en** kjole.
 Ann wanted buy **a** dress
 ‘Anna wanted to buy a dress.’

The a-expressions *një fustan* in (27a'), *ena forema* in (27b') and *en kjole* in (27c') might denote:

- (28) a. some particular dress that Ann has seen on some display
 b. some particular kind of dress (eg. some *Dior* vs. some *Versace* dress)
 c. some/any object which classifies as a dress; that is, any dress at all

With respect to specificity, the (28a) and (28b) readings are both specific readings and can be continued by (29):

(29) She may find it in ‘The House of Fraser’.

Only the (28c) reading is non-specific and (29) is not an appropriate continuation for it. One could continue the (28c) reading as in (30):

(30) She may find one in ‘The House of Fraser’.

Note that the referential/attributive dichotomy (cf. Donellan 1966) divides the three readings in (28) in a different manner. The reading in (28a) is referential, while the readings in (28b) and (28c) are attributive. This is so because only in (28a) has Ann established a direct relationship with some particular *haecceitas*.²⁰ This is not the case in (28b); any Dior dress, not just a particular one, is sufficient for Ann under the reading in (28b). Yet, the indefinite noun phrase in (28b) receives a specific interpretation, because Ann is not interested in any dress; she wants (a sample from) a specific *type* of dress, namely, a Dior one, but obviously she does not mind as to what particular sample (e.g. with respect to colour, cut, production year, etc.) she gets. Thus, specific noun phrases may be intended as either referential or attributive (cf. also Ioup 1977). In other words, the distinction referential vs. attributive makes sense for specific noun phrases only. Thus, in line with Ioup and contrary to Partee (1972), I

²⁰ The notion *haecceitas* is used in medieval philosophical texts, meaning: *that which makes an object what it uniquely is*.

hold that there are two distinctions to be made for noun phrases, namely: specific vs. non-specific and referential vs. attributive. The referential/attributive dichotomy was already referred to pragmatics by Ioup (op.cit.).

Importantly, the bare singulars *fustan* in (27a), *forema* in (27b) and *kjole* in (27c) cannot refer to some particular dress or to some particular kind of dress. So, the bare singulars in (27a,b,c) lack the readings given under (28a,b) that obtain for the a-expressions in (27a'), (27b') and (27c'). This means that the bare singulars in (27a,b,c) may not receive specific interpretations. Thus, a-expressions and bare singulars are not fully synonymous; they are so only on the non-specific readings of the former.

As Ioup (1977) points out, certain inferences follow on a specific reading which are invalid on a non-specific reading. On the specific readings (28a,b), the existence of the items referred to by the a-expressions is presupposed. Thus, on the readings given in (28a) and (28b) the sentence in (31) will be true.

(31) There is a certain dress that Ann wants to buy.

No existence claims follow from the non-specific reading in (28c); that is, (31) is not a valid inference from (28c). Instead, we can paraphrase (28c) as in (32):

(32) Ann wants there to be some dress or other that she can (find and) buy.

Thus, what Ann is interested in in (27a,b,c), is some individual or other which embodies a certain property, namely that of being [+dress] and not, say, [+book]. The identity of the item that Ann wants, beyond its being [+dress], is irrelevant here. Assuming that properties do not exist outside individuals (that is, assuming that



properties are *not* ontological primitives), Ann is interested in some individual or other that has the property [+dress]. But, each individual that has the property [+dress], has in addition other properties, at least one, that make it distinct from other individuals that have the same property [+dress]. This view is reflected at best through the notion *haecceitas* introduced above (cf. footnote 20). The very existence of distinct individuals possessing the same basic property (here: [+dress]), which makes them be regarded as members of the same class (here: the class of dresses), is due to the existence of at least one distinct property. To quote Wittgenstein (1922: 34): “to say of two things that they are identical is nonsense, and to say of one thing that it is identical to itself is to say nothing.” Being a distinct individual itself is a property. These other properties of individuals, beyond the property [+dress], are not only irrelevant to Ann in (27a,b,c), but indeed unable to be expressed by bare singulars. The bare singulars in (27a,b,c) do not denote individuals but properties which is why (27a,b,c) get an event-related reading (cf. Krifka 1990) which is best rendered as in (33):

(33) Ann wanted to engage/was interested in dress-buying.

I presume it is precisely this intensional, property-denoting, event-related or verb-modifying reading of count bare singulars in object position that leads Delsing (1993) to conclude that count bare singular nouns in object position are really uncountables. He provides the following data from Swedish (Delsing 1993: 57 e.g. (101)).

- (34) a. Han skal köpa bil/ lägenhet.
 he shall buy car/ flat
 ‘He is going to buy a car/flat.’
- b. Hon har hund / svår lunginflammation.
 she has dog / bad pneumonia
 ‘She has got a dog/serious pneumonia.’

The following quote from Delsing about these examples can be tied in well with the idea that bare singulars are property-denoting expressions.

“The verb phrases in [34] above have connotations of getting a loan in the bank, paying the insurance, moving to the new apartment, having to go out with the dog every day, or being bound to bed.” Delsing (1993:58).

It is then my contention that while direct object a-expressions may denote individuals, direct object bare singulars may not; the latter invariably denote properties. Hence, the statement in (35):

- (35) Bare singulars denote properties; they are LF predicates.

The distinction between properties and individuals may be represented as in (36a) vs (36b):

- (36) a. **P**
 b. **P ∩ p_i**

(where *P* is the fundamental property that identifies individuals as members of the same class, and *p_i* is a property that does not contradict *P*)

In spite of the confusion in the literature surrounding the terms specific/non-specific, it is by now a well-established view in the semantic literature that specific readings are presuppositional and non-specific readings are not so (cf. Enç (1991), Diesing (1992)). The hypothesis that bare singulars are property-denoting expressions, that is predicates, can account for the fact that they are not presuppositional because presupposition is about saturated structures, that is, about individuals (and propositions), not about properties. It follows then that specificity involves individuation; individual-denoting expressions are always specific irrespective of the fact that they may be used referentially or attributively. On the other hand, property-denoting expressions are non-specific. Since arguments are saturated structures, noun phrase arguments denote individuals, that is, are specific.

In sum, on their specific reading noun phrases always denote (types of) individuals, not properties. Individuals are arguments, not predicates at LF. Therefore, noun phrase arguments are always specific, irrespective of the fact that as such they may be used referentially or attributively. On their non-specific reading, noun phrases are not arguments and invariably denote properties, not individuals. Properties translate as predicates at LF; they are unsaturated structures. Bare singulars are non-specific (read: property-denoting); they are LF predicates. Given that direct objects may be instantiated by bare singulars, which invariably denote properties, it follows that direct objects are not always arguments; they may also be predicates. Hence the statement in (37).

(37) Direct objects may be arguments or predicates.

The question then arises as to why can't other terms (for instance, terms in the function of subject or indirect object) function as predicates. In other words, what is there about direct objects that makes them special? In an attempt to answer this question, I will adopt Rapoport's (1995) proposal which was outlined in section 3.3 above. Under this proposal, direct objects may be projected either in Spec of VP position or as complements of V, depending entirely on their specificity feature.²¹ That is, unlike subjects and dative indirect objects, direct objects are not exclusively projected in specifier positions. A more detailed discussion of this question will follow in section 3.6.

I have now explained that the claim that bare singulars are NPs lacking a D-projection is not in opposition with Longobardi's claim that the D-position is the locus of argumenthood, since bare singulars are not arguments but predicates. In fact, there have been previous inquiries (e.g. Rapoport (1987), Stowell (1989), (1991)) into the possibility of a DP-NP categorial distinction between noun phrases that are arguments and noun phrases that are predicates. For example, based on facts in Israeli Hebrew, in which there are no definite noun phrase predicates, Rapoport (1987) argues that in a language with no indefinite article, indefinite noun phrases are NPs, while the presence of the definite article means that the phrase containing it is always a DP. Thus, in Hebrew there is the following division: DPs are arguments and NPs are (generally) predicates. But as Rapoport (1995) notes, such a proposal does not readily extend to a language like English, at least not under the assumption that the definite article must always head a DP, which would require that definites always be

²¹ Note that Rapoport adopts Enç's (1991) account of specificity. However, Enç's account of specificity makes wrong predictions which I will point out in the following section. On the other hand, the account of specificity that I have presented relies on the individual-denoting vs. property-denoting capacity of noun phrases and eschews the problems that Enç's analysis runs into.

arguments. But definites can be predicates, as will be shown in the following section. Likewise, indefinites in English can be both predicates and arguments. In view of these facts, the question of the interaction between syntax and semantics for English noun phrases is not resolved. The discussion of this question will be resumed in section 3.6.

Next, I will show that also definite expressions, the archetypes of specific, individual-denoting, and/or presuppositional DPs can in fact be also non-specific, meaning property-denoting, when they occur as direct objects.

3.4.3. A Note on Definite Expressions and Why Enç (1991) Can't Be Right

Consider the example in (38):

(38) I shall kiss the first woman to enter this room.

In line with the discussion in section 3.4.2, the definite expression in (38) also is specific, though it may have both a referential and an attributive reading, depending on whether or not the speaker knows beforehand who the first woman to enter the room will be. In other words, the definite expression in (38) may denote either a particular individual in relation to the speaker, namely, the type of 'first woman to enter the room', as opposed to, say, the type of 'second woman to enter the room', or the type of 'no woman to enter the room'. The type of 'first woman to enter the room' is an individual with respect to the concept/property 'woman'. So, independently of whether the definite expression in (38) is intended to refer or not, it is specific. This accords with Enç (1991) who argues that definite expressions are always specific irrespective of whether or not they are intended to refer.

For Enç, specificity reduces to an inclusion relation. This means that a specific noun phrase denotes a subset of a set that has already been introduced into the domain of discourse. This is illustrated in (39).

(39) A bunch of kids are in the garden.

I know two of them.

Here the *two of them* is specific, since it has as its referent a subset of the set introduced into the discourse by the noun phrase *a bunch of kids*. Under Enç's analysis, partitives are therefore necessarily specific, as are definite expressions, since as Enç claims, both denote subsets of sets previously introduced in the discourse. Note however that the definite noun phrase in (38) cannot get a non-specific reading irrespective of the fact that the sentence would be felicitous even if uttered in an out-of-the-blue context.

Contrary to Enç, I claim that definite direct object noun phrases can however be non-specific, that is, denote properties and translate therefore as predicates at LF (like bare singulars and a-expressions on non-specific reading). Examples are definite noun phrases in object position in set expressions like: *take the bus* in (40a), *play the violin* in (40b).²²

²² J. Emonds (p.c.) points out to me that definite noun phrases in some locative phrases (e.g. *I am going to the airport/to the doctor's/to the shore/to the hospital*) have a predicative reading, as well. Note that these are not generic: *The only time in my life I went to Texas I took the plane*. Note also that as Longobardi (1994) suggests for the PPs in the sentences in (13) in section 3.3, examples such as these can be assimilated to predicative expressions on semantic grounds as well.

- (40) a. I like to take the bus.
b. Ben has played the violin beautifully at times.

It is true that the definite expression *the bus* in (40a) may have both a referential-specific and an attributive-specific reading (as paraphrased in (41a,b)), but what is important to note is that it also has a non-specific reading, as paraphrased in (41c). Likewise, *the violin* in (40b) also has a non-specific reading which may be paraphrased as in (42).

- (41) a. There is a bus-vehicle, always the very same, that I like to take.
b. There is a bus-line that I like to take.
c. I like to travel by bus (I don't like to walk, drive, take the train or fly).

- (42) Ben is a talented violin-player.

The fact that not only indefinite expressions but also definite expressions may have both a specific and non-specific reading constitutes a counterexample to the claim that all definites are specific (cf. Enç 1991). It suggests that the class of definite expressions is far from homogeneous semantically (cf. also Vergnaud & Zubizarreta 1992). Above I argued that specific readings arise when noun phrases denote individuals and non-specific readings when they denote properties. Note, however, that both a-expressions and definite expressions may only be interpreted non-specifically when they occur as predicate nominals or as direct objects (sometimes also as objects of certain prepositions), but not when they occur as subjects. That subjects invariably denote individuals when they are instantiated by noun phrases

should not be a matter of controversy in a framework like *Principles and Parameters*.²³

Note that since not only indefinite noun phrases but also definite noun phrases in direct object position may receive a non-specific (that is, property-denoting) interpretation, the generalisation in (37) in the previous section, namely that direct objects may be arguments or predicates, remains unaffected.

De Hoop (1997) claims that scrambling of even predicative definite noun phrases is optional. I will now show that this is not correct. Consider the examples in (43).

(43) Dt: a. weil ich morgen den Bus nehme.

because I tomorrow the bus take

‘because I will take the bus tomorrow.’

b. weil ich den Bus morgen nehme

because I the bus tomorrow take

‘because I will take the bus tomorrow.’

In line with the discussion above, *den Bus* ‘the bus’ in (43a) can denote either an individual (that is, some bus vehicle or other or some bus-line or other) or a property.

In other words, both (44a) and (44b) are valid paraphrases for (43a). (44a) is an event-

²³ In the *Principles and Parameters* framework the subjects of examples like: *Being wise/To be wise is crazy or Being crazy is crazy* (examples from (Chierchia 1985: 418)) are clausal syntactically and propositional semantically (Koster & May 1982). For examples like: *Wisdom deserves reward*, I agree with (Chierchia 1985) in that too compelling a point cannot be made about the subject of this sentence being a property-like creature, because “the realm of nominalizations such as [wisdom] ... are still largely unknown, which relegates our considerations to the realm of intuitions” (Chierchia 1985: 418). Such examples do not therefore necessarily constitute counterexamples to my claim that subjects invariably denote individuals.

related reading; that is, *den Bus* here denotes a property and translates therefore as a predicate at LF.

- (44) a. because, as for me, I will engage in bus-taking tomorrow.
b. because, as for (me and) the bus, I will take it tomorrow.

In (43b), on the other hand, the scrambled DP *den Bus* denotes an individual only; that is, it may denote some bus or other or some bus-line or other. In other words, the scrambled bus in (43b) is specific or presuppositional. Since specificity/presuppositionality is a property of arguments not of predicates, *den Bus* in (43b) is an argument variable not a predicate, as it can (though it need not) be in (43a). Crucially, (43b) lacks the event-related reading that obtains for (43a). This suggests that scrambling applies to arguments only, not to predicates. Hence the unavailability of the reading in (44a) for the sentence in (43b).

To come back to bare singulars, in the following section I present additional evidence for my claim that bare singulars denote properties and function therefore as predicates, not as arguments.

3.4.4. Bare Singulars Are Predicates: Syntactic Evidence

The hypothesis that bare singulars are predicates accounts for the fact that bare singulars in the function of direct object are disallowed if secondary predication applies to the object. Of course this statement makes sense only for those predicates whose direct objects can be instantiated by bare singulars. One such predicate is *buy*,

as shown in (45a).²⁴ Example (45b) shows that secondary predication on this bare singular object renders the sentence ungrammatical. This contrasts with the grammatical sentences in (45c) and (45d) which differ formally from (45b) only in that the direct objects here are not bare.

- (45) a. Hun kjøpte bil.
 she bought car
 ‘She bought a car.’
- b. *Hun kjøpte bil ny.
 she bought car new
 ‘She bought a car new.’
- c. Hun kjøpte bil-en ny.
 she bought car-the new
 ‘She bought the car new.’
- d. Hun kjøpte en bil ny og en annen brukt.²⁵
 she bought a car new and a other used
 ‘She bought a car new and another used.’

The constraint may then be stated in terms of (secondary) predication, as in (46):

²⁴ Many thanks to T. Åfarli (p.c.) for providing the grammaticality judgements for the examples in (45).

²⁵ A sentence like the one in (i) below has an intermediate status in terms of grammaticality, but it certainly is not as bad as (45b).

(i) Hun kjøpte en bil ny
 she bought a car new
 ‘She bought a car new.’

It is not clear to me why this is so, but it might be related to pragmatic considerations.

(46) Constraint on Predication

A predicate can only apply to an argument.²⁶

Another piece of evidence in favour of the hypothesis that bare singulars are not syntactic arguments but predicates involves expletive constructions in MS. As expected, bare singulars are banned from appearing as subjects of small clauses and only a-expressions are allowed, as shown in the Norwegian example in (47).

- (47) Det kommer *(en) mann på vei-en.
 there comes *(a) man on road-the
 ‘There comes a man on the road.’

If the relation that obtains between *a man* and *on the road* is that of predication (cf. Williams 1980), then the ban on bare singulars as subjects of small clauses follows from the constraint in (46).

3.4.5. A Note on Principle C Violations in English

Safir (1987) points out that nominal expressions which function as predicate nominals seem to violate Principle C of Chomsky’s (1981) binding theory, which is stated in (48).

²⁶ L. Hellan (p.c.) points out to me that a sentence like the one in (i) below may be a counterexample to my claim that bare singular objects are disallowed if secondary predication applies to them. However, he also points out that it is not at all certain whether *usett* ‘unseen’ in Norwegian is an adjective or an adverb. Unless this issue is resolved, it is impossible to decide whether the sentence in (i) really is a counterexample to my claim.

(i) Det er utilrådelig å kjøpe bil usett.
 it is inadvisable to buy car unseen
 ‘It is not recommended to buy a car without seeing it.’

(48) Principle C of the Binding Theory

R-expressions must be free.²⁷

For instance, in the examples in (49) (from Safir 1987: 87) the R-expression *a fool* is co-indexed with the subject of the small clause *John*.

- (49) a. [John]_i seems [a fool]_i
 b. I consider [John]_i [a fool]_i

Of course, it is the fact that the second noun phrase in the examples in (49) is a predicate that makes a difference with respect to Principle C of the binding theory here. Note that *a fool* does not receive any theta-role in the examples in (49). In order to exempt predicate nominals from Principle C, Safir suggests that Principle C be revised as in (50).

(50) Predicate Principle (Safir 1987: 87)

A potential referring expression (PRE) is a predicate or else free.

Thus, Safir concludes that if a PRE is bound, then it must be a predicate, not an argument.

Under my analysis of a-expressions as ambiguous between individual and property-denoting, the grammaticality of the examples in (49) is derived simply by

²⁷ R-expressions here stands for all noun phrase categories apart from pronouns, expletives, *PRO*, *pro* and anaphors.

properly stating the scope of the principles of binding theory.²⁸ This definition is put forward in (51).

(51) *The Scope of Binding Theory*

The principles of binding theory apply to arguments only.

As was pointed out in footnote 10, under very-well defined conditions bare singulars in Albanian and Greek may occur as what looks like subjects. If they really are subjects, then this would be a counterexample to my claim that in the *Principles and Parameters* framework, subjects are necessarily arguments. I turn to these apparent “subject” bare singulars in the following section.

3.4.6. Bare Singular “Subjects” are Predicates

In Albanian and Greek bare singulars may occur as what looks like subjects of unergative and transitive predicates, as shown in (52).²⁹ In this case, however, they are necessarily marked [+Focus], as the English translation of the examples in (52) indicates. That is, the apparent subjects of the sentences in (52) can under no circumstances be interpreted as topics.

²⁸ Recall from section 3.4.2. that individuation underlies argumenthood.

²⁹ In fact, though not fully ungrammatical, such constructions are somewhat marked in Albanian, hence the ‘?’.

(52) a. Al: ?GJARPËR e kafshoi An-ën.

SNAKE her_{cl} bit An-the

‘It was a snake that bit Anna.’

b. Gr: FIDHI ton íkhe dhagósi ton Cóstá. (Agouraki 1993: 170)

SNAKE him_{cl} had bitten the Costas

‘It was a snake that had bitten Costas.’

The fact that the bare singulars in (52) cannot be interpreted as topics means that the sentences in (52), and more generally sentences containing what appear to be bare singular subjects, unlike those whose subjects are instantiated by definite expressions or a-expressions, are fundamentally discourse-dependent. This state of affairs is certainly in need of some explanation, all the more so because subjects generally seem to function as topics and not as foci in discourse.

Strawson (1971) has been particularly outspoken in articulating this view. Subjects, he argues, perform the function of *identifying* the object of the speaker’s assertion. Now identification of reference presupposes existence of the object about which something is asserted or predicated. Subjects are therefore presuppositional.³⁰ As Strawson (1971: 79) puts it: “Identifying knowledge is knowledge of the existence of a particular item distinguished, in one or another sense, by the audience from any other.” The asserting part, on the other hand, is the predicate. Strawson argues that it is enough that the predicate applies to the object; it does not also have to identify it.

Let me consider Strawson’s view in more detail. The examples in (53) and (54) are taken from Strawson (1971: 26)).

³⁰ Recall from chapter 2 (section 2.2.4) that presupposition is the basic ingredient of topichood.

- (53) a. That is the man who swam the channel twice on one day.
b. That man swam the channel twice on one day.
- (54) a. Napoleon was the man who ordered the execution of the Duke d’Enghien.
b. Napoleon ordered the execution of the Duke d’Enghien.

Strawson argues that:

“...the differences between sentences in the (a) group and sentences in the (b) group [in (53) and (54)] can best be understood by considering the differences between the circumstances in which you would say ([53, 54]a) and the circumstances in which you would say ([53, 54]b). You would say ([53]a) instead of ([53]b) if you knew or believed that your hearer knew or believed that someone had swum the channel twice in one day [...] you say ([53]a) to a man whom you take to know certain things that you take to be unknown to the man to whom you say ([53]b).” (Strawson 1971: 26)

And further:

“Now one thing that is absolutely clear is that it can be no part of the speaker’s intention in the case of such utterances [as (53b) and (54b)] to *inform* the audience of the *existence* of a particular item bearing the name or answering to the description and distinguished by that fact plus something else known to the audience, from any other. On the contrary, the very task of identifying reference, can be undertaken only by a speaker who knows or presumes his audience to be already in possession of such knowledge of existence and uniqueness as this.” (Strawson 1971: 80)

Strawson says that the identificatory task of the subject is to bring it about that the audience of a certain utterance knows *which* object a predicate is being applied to of all the objects within its scope of knowledge (or presuppositions). More specifically, the phrases *that man* and *Napoleon* in (53b) and (54b) are subjects of these sentences if and only if they are uttered in a context whereby the audience is antecedently equipped with the knowledge that the objects to which *that man* and *Napoleon* refer

exist and are identifiable as unique entities. In other words, it is precisely presupposition of existence of spatio-temporal particulars that enables predication on them.

Of course, it is possible to utter the sentences in (53b) and (54b) in a context whereby the audience is not antecedently (intended to be) equipped with this existence knowledge, but then, the phrases *that man* and *Napoleon* will not be subjects, but predicates. What the sentences in (53b) and (54b) would then say, could be paraphrased as in (55a) and (55b), respectively, which come very close to how we tend to understand the sentences in (53a) and (54a). The reader can then see why Strawson chose the minimal pairs in (53) and (54).

- (55) a. There is a man that swam the channel twice on one day; that was *that man*.
b. There is someone that ordered the execution of the Duke d’Enghien; that was *Napoleon*.

As far as (53a) and (54a) are concerned, they tend to be interpreted in the way paraphrased in (55a) and (55b), respectively. When so interpreted, the phrases *that man* and *Napoleon* in (53a) and (54a) do not identify knowledge already available; they only assert, that is, predicate of the phrases that identify knowledge. The phrases that identify knowledge in (53a) and (54a) when these are uttered to convey the information given in (55a) and (55b) are: *the man who swam the channel twice on one day* and *the man who ordered the execution of the Duke d’Enghien*, respectively.

Returning now to the bare singulars in (52), I propose that they are not subjects, but nominal predicates. A sentence like (52a) presupposes that Ann was bitten by

something or that something bit Ann. Yet, it involves predication: it asserts that what bit Ann was a snake.

With respect to the question of what position the predicate nominal bare singulars in (52) occupy in the structure of the clause, I propose this is Spec of CP. This accords with the claim in Horvath (1986) and Rochemont (1986) that *wh*-phrases, practically characteristic of Spec of CP, are acknowledged to be [+Focus]. This is also in accordance with the fact that the bare singulars in (52) are unequivocally marked [+Focus].

The question then arises as to how these structures are derived technically. An answer to this question is suggested in section 3.7.2 and 3.7.3.

I will next turn to the question of how the view that bare singulars are predicates can be formalized.

3.4.7. Semantic Incorporation and the Formalization of Bare Singulars

So far, I have argued that bare singulars are not arguments but predicates. That is, they cannot be treated as variables or as quantifiers. It may be stated that direct object bare singulars are predicates that restrict an existentially bound argument variable that is independently introduced in the LF representation as the place-holder of the theta-slot of the clausal predicate. It is important to note that the argument variable that the bare singular restricts does not arise via the translation of the bare singular itself but is simply a place holder of the theta-slot (that is, the internal argument) of the clausal predicate. Thus, we have the notation in (57) for the German sentence in (56) which contains a bare singular direct object. (The notation in (57) is an adaptation of Cohen & Erteschik-Shir (1997) formalization for existential bare plurals.)

(56) Eva liest Zeitung.

Eva reads newspaper

‘Eva is reading a newspaper.’

(57) $\llbracket \text{Zeitung} \rrbracket = \lambda y. \text{Zeitung}(y)$

$\llbracket \text{read} \rrbracket = \lambda P. \lambda x. \exists y : P(y) \wedge \text{read}(x, y)$

$\llbracket \text{Eva liest Zeitung} \rrbracket = \exists y : \text{Zeitung}(y) \wedge \text{read}(\text{Eva}, y)$

Let me now explain where the existential quantification in (57) comes from.

A striking property of bare singulars is that they invariably take (existential) narrow scope in the presence of other scopal items in the sentence. Thus, (58a) and (58b) have only the reading in (59) but lack the reading in (60) where the bare singular takes scope over negation.

(58) a. Al: Nuk dua biçikletë.

not want-I bicycle

‘I don’t want a bicycle.’

b. No: Jeg ønsker ikke sykkel.

I want not bicycle

‘I don’t want a bicycle.’

(59) It is not the case that I want a bicycle.

(60) #There is a bicycle that I don’t want.

The fact that the bare singulars in (58) cannot take wide scope over negation cannot be attributed to some specific property of negation as a logical operator. The bare singulars in the affirmative sentences in (61a) and (61b) cannot take wide scope over the quantificational noun phrases here.

- (61) a. Al: Shumë fëmijë blenë biçikletë dje.
 b. No: Mange barn kjøpte sykkel i går.
 many children bought bicycle yesterday
 ‘Many children bought a bicycle yesterday.’

The sentences in (61a,b), unlike their English translation, can only mean that the correspondence of children and bicycles is one-to-one. That is, (61a,b) cannot mean that a bicycle was such that it was bought by many children. If we assume that bare singulars are scopal items on a par with a-expressions (cf. Russell 1905), these two different meanings could in quantifier scope theory be assigned two different LF representations (cf. May 1985), as in (62) and (63), respectively.

(62) $\exists x$: Child $\exists y$: Bicycle B(x,y)

(63) $\exists y$: Bicycle $\exists x$: Child B(x,y)

In (62), the subject noun phrase 'many children' takes scope over the bare singular object 'bicycle'. In (63), these scope relations are reversed. Here the bare singular object takes scope over the subject 'many children'. As already stated, this latter reading is not available for the sentences in (61a,b).

For the sake of completion, let me illustrate the same point again by an example which contains a universal quantifier.

(64) a. Al: Të gjithë studentë-t kanë biçikletë.
 all students-the have bicycle

b. No: Alle studenter har sykkel.
 all students have bicycle
 ‘All students have a bicycle.’

The sentences in (64) can only mean:

(65) For all students there is a bicycle such that s/he owns it.

The sentences in (64) cannot mean:

(66) There is a bicycle, such that all students own it.

The data in this section thus unequivocally show that bare singulars cannot take wide scope. In this respect, they differ both from definite descriptions and a-expressions. The fact that bare singulars invariably take narrow scope immediately reminds one of Carlson's (1977) observation concerning the English bare plural in non-generic contexts.³¹ He notices that the English bare plural always takes narrow scope with respect to negation:

³¹ Bare plurals and the generic/existential dichotomy is discussed in detail in section 3.7.

- (67) John didn't see spots on the floor. (Carlson 1977: 19)
- i. It is not the case that John saw spots on the floor.
 - ii. #There were spots on the floor that John didn't see.

Carlson accounts for the narrow scope of the bare plural in (67) by suggesting that the existential force of the bare plural here comes from a source external to the bare plural itself, namely from the verb.³² To quote:

“The existential use of the bare plural only exhibited narrow scope possibilities relative to other quantifiers. The intuitive account of this phenomenon that we will offer here is that the existential quantifier apparently associated with the bare plural actually arises as being a part of the translation of the predicate itself. ...” (Carlson 1977: 138)

Carlson thus proposes that object bare plurals are semantically incorporated into the verbs that select them. This proposal has been developed further by van Geenhoven (1996) in her study of noun incorporation in West Greenlandic.

Van Geenhoven notes among other things that incorporated nouns in West Greenlandic invariably take narrow scope (just like bare singulars in Balkan and Mainland Scandinavian languages). Likewise, their distribution in terms of grammatical relations patterns with the distribution of bare singulars. Thus, in West Greenlandic only direct objects may incorporate, subjects and indirect objects may not do so.

Van Geenhoven argues that incorporated nouns in West Greenlandic denote properties; they get semantically incorporated, hence their narrow scope. She extends

³² Carlson's view has been rejected by many authors (cf. Kratzer (1995), Krifka et al. (1995)). I will not recapitulate their arguments here. For this, cf. van Geenhoven (1996), who also provides a solution within the framework of *Discourse Representational Theory* that overcomes the difficulties that Carlson's lexicalized existential quantifier runs into.

this analysis also to existential bare plurals in Germanic, as do Cohen & Erteschik-Shir (1997). Thus, for example (notation from Cohen & Erteschik-Shir (1997)):

- (68) $\llbracket \text{spots} \rrbracket = \lambda y. \text{spot}(y)$
 $\llbracket \text{see} \rrbracket = \lambda P. \lambda x. \exists y : P(y) \wedge \text{see}(x, y)$
 $\llbracket \text{John saw spots} \rrbracket = \exists y : \text{spot}(y) \wedge \text{see}(\text{John}, y)$

This is also the crux of my proposal with respect to bare singulars as well, as was given in (57).

It is important to point out that I do not take this kind of semantic incorporation to be derived syntactically, since, as was shown in the examples in (3) in section 3.2, bare singulars do not require adjacency to the verb.

Since direct object a-expressions of verbs which can combine with bare singulars are ambiguous between a specific (that is, individual-denoting) and a non-specific (that is, property-denoting) interpretation, the next thing that needs to be done is to relate the two versions of a predicate in a principled way: the incorporating version, which applies to properties, and the non-incorporating one, which applies directly to individuals. In order to do this, I introduce the essence of Partee's (1987) type-shifting theory, which presents some useful tools for solving the problem at hand.

Consider the examples in (69).

- (69) a. [Eva] laughed.
 b. [Every dog] barked.
 c. Anna is [a teacher].

Adopting common terminology, I will refer to the bracketed noun phrases in (69a) and (69b) as *argumental* noun phrases, respectively as *referential* and *quantificational*. In contrast, the post-copular noun phrase in (69c) is *predicative* (a *predicate nominal*).

In an influential article, Partee (1987) argues that the contrasts between referential, predicative and quantificational noun phrases as in (69a,b,c) respectively, are better accounted for if referential, predicative and quantificational noun phrases are assigned different types, namely e (individuals), $\langle e,t \rangle$ (properties) and $\langle \langle e,t \rangle t \rangle$ (generalized quantifiers), respectively, and not the type of generalized quantifiers, i.e. sets of properties or $\langle \langle e,t \rangle t \rangle$, which Montague (1974) uniformly assigns to them in a purely extensional logic. Montague's program is made compatible with this idea by assuming that languages have a set of type-shifting operators (either lexical or abstract) that can convert the original types into others as necessary. To illustrate, if the semantic principle in (70) is adopted:

(70) Principle of Same-Type Coordination

Only categories of the same semantic type can be coordinated.

allowing predicate nominals to denote $\langle e,t \rangle$ explains coordination with adjectives, which undisputedly denote properties:

(71) Mary considers John [competent in semantics and an authority on unicorns]

(Partee 1987)

By (70), the acceptability of (72) is problematic if *Dumbo* directly denotes an individual (the elephant).

(72) [Dumbo and every dog] jumped.

In Partee's approach, *Dumbo* raises to a generalized quantifier type as is necessary to coordinate with the quantified conjunct.

Partee also suggests that languages might have the strategy of trying original denotations first, and that some of the type-shifting operators might be more natural than others, depending on several features of the individual languages. I will not undertake to present formally the individual operators in her system. What would suffice for my aims here, is that original denotation types may change.

Zamparelli (1996) points out several severe problems with Partee's type-shifting operations and the overall system. In particular, Zamparelli shows that there are problems with the GQ-type denotation assigned to quantifiers and argues that an approach which treats quantifiers as *e*-type at LF fares better. I adopt this view.

An interesting idea emerging from Partee's system is that the distinction specific/non-specific correlates with different types. Assuming with Zamparelli that at LF noun phrases may exclusively denote either individuals or properties, the denotation of a-expressions would then oscillate between type *e* and $\langle e, t \rangle$. In this context, cf. also van Geenhoven (1996) who crucially argues that a-expressions are ambiguous between a variable and a predicative interpretation.

So far this theory still does not account for why some verbs, e.g. *love*, *hate*, apparently fail to incorporate, that is, why they fail to combine with a property; when instantiated by a-expressions, the direct objects of such verbs may only be interpreted as specific. That is, they lack a non-specific (i.e. property-denoting) interpretation. (Recall from section 3.3 that in Balkan and MS languages the direct objects of such verbs cannot be instantiated by bare singulars.) On the assumption that just like the

original denotation-type of noun phrases can change, so can the denotation-type of the verb, it may be stated that while the semantic value of all natural language transitive predicates is a function from individuals to properties (that is, all natural language transitive predicates are of type $\langle e, \langle e, t \rangle \rangle$), some (e.g. *buy*) though not all of these transitive predicates can be raised to type $\langle \langle e, t \rangle, \langle e, t \rangle \rangle$, that is, they can become complex predicates, meaning:

(73) $\lambda P \lambda x \exists y [P(y) \wedge \text{BUY}(x, y)]$

This is of course not an explanation for why certain transitive verbs cannot be raised to type $\langle \langle e, t \rangle, \langle e, t \rangle \rangle$.

3.4.8. Section Summary

In this section, I have argued that bare singulars are not DPs with a morphologically empty D but NPs that lack a syntactic D-projection. I have provided both syntactic and semantic evidence to this effect. Semantically, bare singulars invariably denote properties. As such, they do not translate as variables or restricted quantifiers but as predicates which are semantically incorporated in the clausal predicate at LF.

The fact that bare singulars and a-expressions are not fully synonymous (recall that the meaning of bare singulars is a subset of the meaning of a-expressions) suggests that a-expressions are potential designators of either properties or individuals. That is, a-expressions may be predicates or variables. Hence they can oscillate between type $\langle e \rangle$ and $\langle e, t \rangle$. But in view of the fact that many definite noun phrases as well, may be interpreted non-specifically/predicatively when objects of verbs and prepositions, we need to assume that definite noun phrases as well are also ambiguous between

individual vs. property-denoting and can therefore oscillate between type $\langle e \rangle$ and $\langle e, t \rangle$. To generalize, we may then state that while NPs (e.g. bare singulars) are unambiguously type $\langle e, t \rangle$, DPs may be of type $\langle e \rangle$ or $\langle e, t \rangle$.³³

In sum, it may be stated that definite noun phrases and a-expressions are semantically (and perhaps syntactically) non-homogeneous; they are not always syntactic arguments when objects of verbs (and prepositions) but may translate both as arguments or as predicates at LF depending on whether the clausal predicate selects an individual (type $\langle e \rangle$) or a property (type $\langle e, t \rangle$) as its internal argument. Partee's (1987) type-shifting mechanism allows for this duality. This creates the illusion that scrambling/doubling of definites and a-expressions is optional. In fact, scrambled/doubled objects are always syntactic arguments. Since argument noun phrases are always specific (read: individual-denoting), specificity effects will be observed in scrambling constructions. Non-scrambled/non-doubled objects may but need not be arguments.

In the next section, I present further syntactic evidence in support of my claim that bare singulars lack a D-projection.

3.5. Adjectival Modification, the Relation of Adjectives to the D-position and the Structure of the Albanian DP

Börjars (1994) observes that bare singulars in Swedish cannot be modified by adjectives.³⁴ She provides the example in (74) to illustrate this point. (The canonical

³³ Alternatively, it might be that both the indefinite and the definite article are not exclusively generated under D but may also be generated NP-internally. Cf. also the discussion in section 3.6.

³⁴ Börjars does not discuss whether bare singulars in Swedish can be modified by adjectives when they occur as direct objects.

order in Swedish, as in the rest of MS languages, is noun preceded by modifying adjective.)

(74) Oscar är *(en) skicklig rörmokare. (Börjars 1994: 343)

Oscar is a skillful plumber

‘Oscar is a skillful plumber.’

The examples in (75) show that bare singulars cannot be modified by adjectives in Italian either.^{35,36} This state of affairs is not affected by the relative order of noun and modifying adjective. In (75a), the modifying adjective precedes the noun; this represents the canonical order of adjectival modification in Italian. In (75b), the adjective linearly follows the noun; this order is stylistically marked. Crucially, in both cases adjectival modification of a bare singular is precluded.

(75) a. Mio padre é *(un) bravo dottore / *(un) severo direttore.

my father is a good physician / a strict director

‘My father is a good physician / a strict director.’

b. Mio padre é *(un) dottore bravo / *(un) direttore severo.

my father is a physician good / a director strict

‘My father is a good physician / a strict director.’

³⁵ Many thanks to G. Giusti (p.c.) for having provided the Italian examples.

³⁶ Recall from section 3.3 that in Italian bare singulars occur only as predicate nominals.

The phenomenon presented above, namely the impossibility of modifying bare singulars by adjectives can be observed also in Albanian, albeit partly. In order to understand what I mean by partly, a discussion of the Albanian patterns is necessary as they are typologically different from both the Swedish and the Italian patterns.

In Albanian, the canonical order that obtains between a noun and a modifying adjective is noun followed by adjective. This is illustrated in (76a). However, the modifying adjective can be fronted or, more neutrally stated, it may precede the noun, as is exemplified in (76b).³⁷ The interpretation that obtains in this case is one whereby the noun phrase is unambiguously marked [-Focus]/[+Topic] while the adjective is not necessarily so; hence the given English translation. In fact, when the adjective precedes the noun, the latter may be deleted. It looks therefore as if the adjective in a way nominalizes.

³⁷ Note that the Albanian enclitic definite determiner cliticizes onto the adjective when the adjective precedes the noun, leaving the latter formally bare. The situation reminds one of a certain pattern found in MS languages (cf. Delsing 1993). The parallel is not complete, however, as MS languages display a so-called double definiteness, illustrated in (i), which does not exist in Albanian, where the definite determiner which renders the whole DP definite invariably cliticizes on an adjective preceding a noun, which in turn can under no circumstances carry another definite determiner. In other words, while a DP string containing two definite determiners is grammatical in MS languages, it is ungrammatical in Albanian, as shown in (ii).

- (i) No: det (lille) hus(-et)
 the (small) house(-the)
 'the (small) house'
- (ii) Al: të vjetër-*ën* gazet-(**ën*).
 agr old-*the* newspaper-*the*
 'the old newspaper'

(76) a. Ana lexoi gazet-ën e vjetër.³⁸

Anna read-she newspaper-the agr old

‘Anna read the old newspaper.’

b. Ana lexoi të vjetër-ën (gazetë), jo të re-në (gazetë).

Anna read-she agr old-the newspaper not agr new-the newspaper

‘Anna read the old one/newspaper, not the new one.’

While Albanian adjectives modifying definite noun phrases and a-expressions may be fronted so as to precede the noun, adjectives modifying bare singular nouns may not, as the examples in (77) show.

(77) a. Ana bleu gazetë të vjetër.

Anna bought newspaper agr old

‘Anna bought an old newspaper.’

b. *Ana bleu të vjetër gazetë.

Anna bought agr old newspaper

The question then arises as to why such a state of affairs obtains, whereby adjectives may modify bare singular nouns but may not be preposed in Albanian. Moreover, why can’t bare singulars in Italian and Swedish be modified by adjectives? In order to

³⁸ Albanian adjectives fall into two lexical classes: one comprises so-called “articled” adjectives (those that must always be preceded by an adjectival article) and the other comprises “articleless” adjectives (those that are never preceded by an adjectival article). Descriptively, the classification criterion appears to be a morphological one. What is referred to as an adjectival article is a (seemingly) phonologically detached clitic-like element that immediately precedes the root of the adjective (e.g. *e* in (76a) and *të* in (76b)) and which agrees with the noun that the adjective modifies for the features case, number, gender, definiteness. I will therefore gloss this element *agr*. For some detailed discussion of this agreement morpheme and alternative analyses see Androutsopoulou (1997) and Dimitrova-Vulchanova & Giusti (1997).

address the first question, some detailed discussion of the Albanian DP-structure is necessary.

As observed in (76) above, when the adjective precedes the noun that it modifies, the definite determiner, which in Albanian is enclitic, invariably attaches to the adjective, not to the noun. The example in (78) shows that the enclitic definite determiner cannot attach to the noun when the adjective is preposed.

- (78) *Ana lexoi të vjetër gazet-ën.
 Anna read agr old newspaper-*the*

How then can the facts just described be accounted for? Suppose the structure of the Albanian DP is roughly the one depicted in (79).

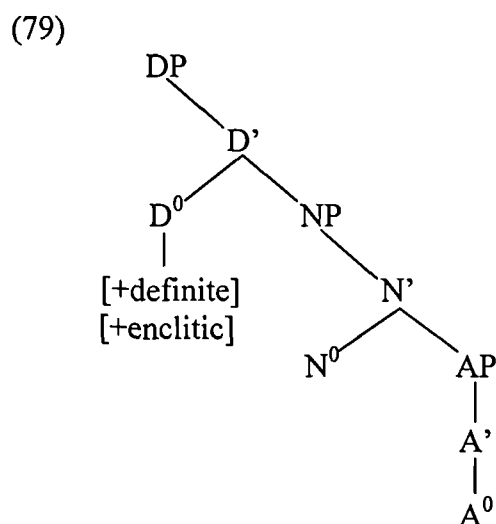

In (79), one would have no problem deriving the order depicted in (76a). The noun here presumably raises to D, arguably to satisfy the [+enclitic] feature of the definite determiner in D. What seems problematic is deriving the order depicted in (76b), where the enclitic definite determiner is attached to the preposed adjective, from the

structure in (79). At first sight, it looks as if the order within the DP in (76b) is derived from movement of the adjective from A^0 to D^0 , hence past N^0 . This movement would however violate the Head Movement Constraint (henceforth HMC) (cf. Travis 1984). In the minimalist framework the HMC has no absolute significance. In this framework movement is “altruistic”, that is, it is triggered by some feature’s need to be checked, and for successful checking (that is, one which does not cause the derivation to crash) there should be no feature divergence between the feature or the feature’s host and the moved element that checks this feature. However, if two categories (or categorial elements) can both check a given feature, then HMC is of necessity relevant even in the minimalist program. The HMC in the minimalist framework built into the notion of economy of derivation. That is, if some head element which is in the checking domain of a certain feature dominates another head element which is also a potential checker for the same feature, then it will be the dominating head whose task it is to check this feature (cf. shortest move).

Coming back to the facts under discussion, if (76b) is derived from head-movement of A^0 to D^0 , the feature that triggers this movement cannot be the same feature that triggers movement of N^0 to D^0 in (76a), if head movement is indeed involved in (76a), because “shortest move” would then be violated. More specifically, if what triggers movement of N^0 to D^0 in (76a) is the need of the feature [+enclitic] of the definite determiner in D^0 to be checked off, then it couldn’t be this feature that triggers movement of A^0 to D^0 in (76b), if head-movement is what is really involved here. No other feature suggests itself, though. So then, “shortest move” seems to indeed be violated if the order within the DP in (76b) is derived by head-to-head movement, that is, by A-movement to D^0 , just like the order within the DP in (76a) is derived through N-movement to D^0 .

In what follows, I will suggest an alternative account. I propose that the order within the DP in (76b) is due to phrasal movement, not to head movement. I suggest that in (76b) it is the whole AP, not just A^0 , that moves to the Spec of DP. The question then arises as to what motivates such a movement. I claim that it is precisely the feature [+enclitic] of the definite determiner in D^0 that triggers movement. However, in this case “shortest move” is not violated, since both N^0 and AP as sister nodes are equidistant. In other words, I claim that the [+enclitic] feature of the definite determiner in D can be satisfied either by movement of N^0 to D^0 , as in (76a), or by movement of AP to Spec of DP, as in (76b). In both cases, the result is a phonological merging of the moved element and the definite determiner in D^0 . The notion of checking domain, as defined in Chomsky (1995), allows for either head or phrasal movement in order for a feature to be checked. Hence, under an appropriate minimalist formulation, the apparent violation of the HMC disappears. This analysis thus explains why either the order in (76a) or that in (76b) but not that in (78) would obtain.

A number of empirical arguments in favour of the analysis of Albanian APs outlined here may be adduced. The example in (80) shows that degree words, which are commonly argued to occupy Spec of AP (cf. Abney 1987), invariably precede the adjectives they modify when the latter are preposed, suggesting phrasal movement.

- (80) Ana lexoi shumë të vjetër-ën gazetë.
 Anna read-she very agr old-the newspaper
 ‘Anna read the very old newspaper.’

This account, which makes crucial use of economy principles, also answers the question as to why the order within the DP in (76a) involves N^0 movement to D^0 and not NP movement to Spec of DP, which would parallel AP movement to Spec of DP. If the order within the DP in (76a) were the result of NP movement to Spec of DP, one would predict that the order N-AP-D would be possible in Albanian. In other words, one would expect the N-AP cluster to form a constituent. The example in (81) shows that this prediction is not borne out.

- (81) *Ana lexoi gazetë e vjetr-ën.
 Anna read newspaper agr old-the

Turning to the question of why adjectives modifying bare singulars cannot be preposed in Albanian, one may now state that APs in Albanian may only be preposed if a D-projection is present. If bare singulars are NPs that lack a D-projection, one predicts that adjectives modifying bare singulars cannot be preposed in Albanian. The ungrammaticality of (77b) is thus explained.

At the beginning of this section, we saw that bare singulars in languages like Italian and Swedish, where the canonical order within the DP is adjective then noun, may not be modified by adjectives. This is to be expected if adjectives in these languages need to occupy Spec of DP.³⁹ In sum, it may then be stated that adjectives seem to be more closely related to the D position than is commonly acknowledged. Yet another piece

³⁹ In this context, cf. also Giusti (1993) who crucially argues that adjectives and genitives need a functional specifier, adjectives to agree with the noun, and genitives to get case.

of evidence for this view comes from Albanian. In this language, the adjectival article (cf. footnote 38) is the same as the genitive case marker, as shown in (82).

- (82) Libr-i i vjetër i Ben-it ishte grisur.
 book-the agr old gen Ben-the_{dat} was torn
 ‘Ben’s old book had been torn.’

As is clear from the example in (82), genitives in Albanian are normally quite far to the right. They may be preposed in the same fashion as adjectives may, yielding a slightly marked order, which is however not fully ungrammatical. This is illustrated in (83).

- (83) ?I Ben-it libër i vjetër ishte grisur.
 gen Ben-the book agr old was torn
 ‘Ben’s old book had been torn.’

A question now arises as to what the position of possessive DPs is in Albanian. Another question concerns whether the structure in (79) and the analysis that was based on this structure for the Albanian DP can be maintained to account for the facts in (83). As pointed out above, possessives in Albanian are canonically very far to the right (cf. e.g. (82)). Clearly, the structure provided in (79) is in need of some modification to account for this fact. For one thing, possessive DPs cannot be within the AP as they do not form a constituent. This is shown in (84b), which contrasts with (84a) where the adjective is fronted.

(84) a. I vjetr-i libër i Ben-it ishte grisur.

agr old-the book agr Ben-the_{gen} was torn

‘The old book of Ben had been torn.’

b. *I vjetr-i i Ben-it libër ishte grisur.

agr old-the agr Ben-the_{gen} book was torn

I will now show that though the structure in (79) cannot be fully maintained in view of the facts concerning the position of genitive DPs, the analysis of N movement to D and AP movement to Spec of DP that I provided above to account for the data (76) through (78) is not affected. The modification of the structure for the Albanian DP in (79) that I propose in (85) integrates all of the above insights. The structure in (85) does not contradict (79), it only elaborates it.

(85)

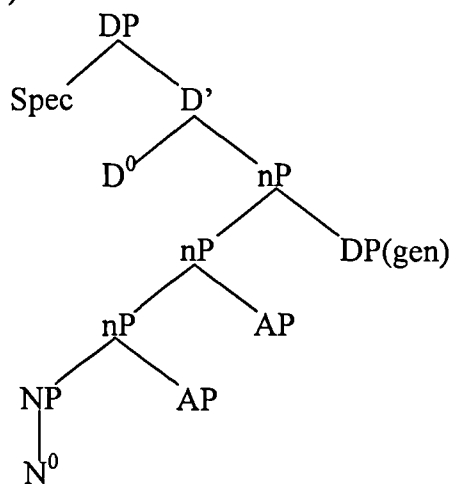

In (85), genitive DPs are on the right, much like post-verbal subjects in Romance (cf. Friedman 1997). APs, on the other hand, are not complements of N but adjoined

phrases.⁴⁰ The order within DP illustrated in (76a) is the result of N-raising to D, that illustrated in (76b) is derived from AP movement to Spec of DP, and the marked order in (83) is derived from movement of the genitive DP to the specifier of the (higher) DP. The facts observed have thus all been accounted for.

In section 3.3, I claimed that NPs that lack a D-projection are predicates, not arguments. If there exists some systematic mapping between syntactic structure and semantic interpretation then one would expect NPs to pattern with adjectives rather than with DPs syntactically. The fact that the degree word in (86) can precede either the adjective or the noun without effecting any interpretative difference between (86a) and (86b) only highlights the semantic similarity between NPs and APs in terms of the predicate/argument distinction. Example (86b) contrasts with (87b), where the degree word cannot precede a DP.

- (86) a. libër shumë i bukur
 book very agr beautiful
 ‘a very good book’
- b. shumë libër i bukur
 very book agr beautiful
 ‘a very good book’

⁴⁰ I have labelled the projection that adjective phrases are adjoined to as *nP*. This is also the projection which in its specifier position hosts the genitive subject. Further analysis of this nP might reveal that it is a functional projection of some sort (cf. for instance Dimitrova-Vulchanova & Giusti 1997), meaning some kind of extended projection of NP (e.g. a Number Phrase), which is however distinct from DP. In other words, what I am interested in here is a distinction between the DP and the NP domains.

- (87) a. *libr-i shumë i bukur*
 book-thevery agr beautiful
 ‘the very good book’
- b. **shumë libr-i i bukur*
 very book-theagr beautiful

In concluding this section, it may be stated that NPs and APs share several semantic and syntactic features.

In the next section, I turn to a more detailed discussion of the question asked previously in section 3.4.2, namely why can direct objects, unlike subjects and datives, function both as arguments or as predicates, as well as to the question of the internal structure of both a-expressions and definite noun phrases.

3.6.NPs, DPs and their Interaction with Phrase Structure

Positions

In section 3.4.2, I raised the question as to what makes terms in the function of direct objects different from terms in the function of other grammatical relations, particularly from the terms functioning as subject or indirect object, with respect to the generalisation in (37), repeated here for ease of reference in (88).

- (88) Direct objects may be arguments or predicates.

In section 3.4.2, I argued that the generalisation in (88) follows from Rapoport’s (1995) proposal that direct objects, unlike subjects and (dative) indirect objects, are

not exclusively projected in Specifier positions but may be projected either in the Specifier position of the VP or as complements of V^0 . That is, I am claiming that the difference between predicates and arguments may be related to differences in terms of phrase structure positions.

Moreover, in line with Rapoport (1995) I assume that only specific direct objects are generated in Spec of VP. In contrast, non-specific direct objects are complements of V^0 . In this respect, non-specific direct object share the same structure with predicate nominals (cf. Jenkins 1972).⁴¹

A somewhat different proposal that could be employed to account for the syntactic distribution of bare singulars is made in de Hoop (1992). De Hoop studies the relationship between Case and the interpretation of noun phrases. On independent syntactic grounds she distinguishes two types of structural Case, namely weak Case and strong Case. This Case distinction is motivated by the observation that in several languages there are two distinct morphological cases for direct objects. For instance, Belletti (1988) points at the fact that a direct object noun phrase in Finnish may receive either of two possible cases: accusative or partitive. Similarly, in Turkish the direct object may bear either accusative case or zero case – that is, it may lack accusative case (cf. Enç 1991). It has been noted that in these languages the difference in objective case correlates with a difference in semantic interpretation. Thus, while direct objects bearing accusative case in Finnish and Turkish receive a “specific” interpretation, direct objects bearing partitive case in Finnish and zero case in Turkish

⁴¹ Jenkins (1972) argues that predicate nominals are generated as sisters to V^0 .

get a “non-specific” interpretation.⁴² To a certain extent, this pattern is also replicated in Albanian and German. Thus, while definite noun phrases in Albanian necessarily bear morphological accusative case, as in (89a), bare singulars bear zero case, as in (89b). Likewise, in German masculine definite object noun phrases and a-expressions always bear accusative case (which is marked on the article), whereas masculine bare singulars being devoid of articles bear zero case, as the examples in (90a,b,c) illustrate.

- (89) Al: a. Beni sheh film-in.
 Ben watches movie-the_{acc}
 ‘Ben is watching the movie.’
- b. Beni sheh film.
 Ben watches movie_{zero}
 ‘Ben is watching a movie.’

- (90) Dt: a. Hans fährt den Bus.
 Hans drives the_{acc} bus
 ‘Hans drives the bus.’
- b. Hans fährt einen Bus.
 Hans drives a_{acc} bus
 ‘Hans drives a bus.’
- c. Hans fährt Bus.

⁴² As was discussed in section 3.4.3, Enç’s (1991) account of the phenomenon of specificity differs from mine. Belletti (1988), on the other hand, uses the distinction specific/non-specific in an intuitive sense only.

Hans drives bus_{zero}

‘Hans takes the bus.’ or: ‘Hans is a bus-driver.’

In de Hoop’s system, weak Case correlates with non-specific readings, whereas strong Case correlates with specific readings. Weak and strong Case are licensed in different structural positions. To quote:

“Weak case can be licensed on an NP in a certain configuration at D-structure. This type of Case is a weak Case in the sense that it can no longer be licensed as soon as the NP moves out of the original position. That means that if an NP moves out of its original weak Case position, strong Case must be licensed at S-structure to avoid a violation of the Case Filter [which says that every phonetically realized noun phrase must be assigned abstract Case (cf. Rouveret & Vergnaud 1980)]. In certain cases, at S-structure this will show up as an adjacency requirement for NPs bearing weak Case and their licenser. ” (de Hoop 1992:80)⁴³

The different structural positions in which weak and strong Case are licensed are illustrated in (91a) and (91b).

(91a)

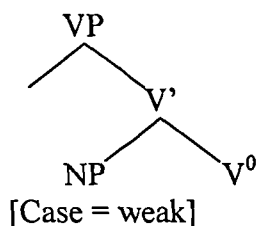

(91b)

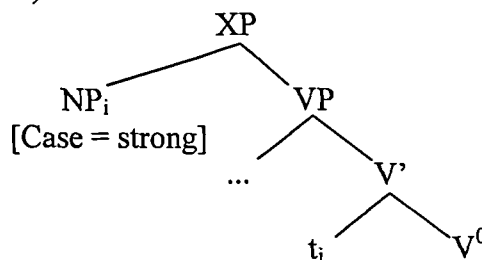

In de Hoop’s account, bare singulars would be assigned weak Case. But the fact that bare singulars do not require adjacency to the verb is a problem for de Hoop’s Case driven approach. A further problem with this approach concerns the all-too-unclear

⁴³ De Hoop is not concerned with the distinction between NPs and DPs; she uses the notation “NP” throughout. In this quotation, it is therefore to be understood as “noun phrase”, a term which unlike “NP” and “DP” I use theory-neutrally throughout this dissertation.

relationship between abstract Case and morphological case on one hand, and the imperfect correlation between strong Case and morphological case on the other. If morphological objective case is viewed as a manifestation of abstract Case and can therefore justly serve as the motivation for an approach such as de Hoop's, the fact that this correlation is not only imperfect but often confusing should raise scepticism about the overall approach. More specifically, de Hoop's analysis does not account for the fact that even in languages with very rich morphology such as Albanian or German, definite noun phrases bear morphological case even when they are interpreted as "part-of-the-predicate" (i.e. receive a non-specific interpretation). For instance, the case-marked definite noun phrase in (92) may receive both an individual-denoting and a property-denoting interpretation.

(92) Hans spielt den Kontrabass.

Hans plays the_{acc} double-bass

'Hans plays the double-bass.'

Rapoport's proposal, on the other hand, namely that the semantic interpretation of direct object noun phrases is related to the phrase structure positions in which they are projected eschews the problems that de Hoop's account encounters.

In section 3.3.1, based on the distribution of bare singulars in terms of grammatical relations, I claimed that bare singulars are not DPs with a morphologically null D, but NPs that lack a D-projection. Then, in section 3.4.2, I showed that unlike a-expressions, which may be specific or non-specific, bare singulars are invariably non-specific. That is, I have also provided semantic motivation for the claim that bare singulars are NPs that lack a D-projection.

The question, however, arises as to whether the semantic ambiguity of a-expressions (namely the ambiguity specific/non-specific which in section 3.4.2 I defined in terms of the distinction individual vs. property-denotation) is also derived from their internal structure. In view of the fact that bare singulars do not display this ambiguity, the minimal assumption is then that such an ambiguity is associated with the indefinite determiner. The question still remains whether the indefinite determiner is just lexically ambiguous or whether this ambiguity is derived from syntactic structure. Since lexical ambiguity is a conceptually uninteresting stipulation, one might like to avoid it. The question then arises as to whether it is feasible that the indefinite determiner may be projected in two different syntactic positions, giving in this way rise to differences in the interpretation of the noun phrases that it introduces.

The proponents of the DP-hypothesis assume that the indefinite determiner, just like the definite one, is projected in the D^0 -position.⁴⁴ Yet, in view of the semantic ambiguity of noun phrases that it introduces, it is at least theoretically possible that the indefinite determiner is not projected in this position invariably. For instance, Higginbotham (1987) suggests that when a-expressions occur as predicate nominals, the indefinite determiner that accompanies them in English is interpreted essentially as an adjective. If the relation between syntax and semantics is isomorphic, the idea that when a-expressions occur as predicate nominals the indefinite determiner is generated inside the *nP* (say in its Specifier position) and not in D, would be at least theoretically desirable. To the best of my knowledge, no one has been able to test this hypothesis syntactically. However, in the absence of counterevidence, one might

⁴⁴ However, cf. Prinzhorn (1995) who argues that even for the definite determiner, there are two different syntactic positions.

assume it to be correct. Extending to direct object a-expressions, it could then be stated that while specific direct objects are DPs, non-specific direct objects are NPs that lack a D-projection. If so, then we have a one-to-one mapping between the internal structure of noun phrases and their semantic interpretation. Alternatively, it is conceivable that the indefinite determiner of a predicate nominal (or of a non-specific direct object noun phrase) is indeed generated in Spec of DP. That is, nothing prevents a DP sister of V, but DPs cannot get reference or quantification except in specifier positions. Whichever of these hypotheses turn out to be correct, the claim that non-specific direct objects are generated as complements of V^0 whereas specific direct objects are projected in Spec of VP, may be restated as in (93), which I have labelled the *DP/NP Complementarity*.

(93) *DP/NP Complementarity*

- a. Only DPs but not NPs are projected in Specifier positions.
- b. NPs are projected in complement positions.
- c. Reference is a property of Specifier positions.

In sum, it may be stated that though the semantic interpretations of noun phrases are fundamentally dependent on their internal structure (after all an NP cannot get a specific interpretation), to a large extent the interpretation of noun phrases depend on their function in differing grammatical relations, which in turn depend on the phrase structure positions in which they are initially projected.

In the following section, I turn to the relation between count bare singulars and bare plurals.

3.7. On the Relation of Bare Singulars to Bare Plurals

Recall from section 3.1 that existential bare plurals cannot be clitic doubled in Albanian and Greek. Nor can they scramble in German or Dutch. What are existential bare plurals? Consider the examples in (94).

- (94) a. Books are expensive.
b. Ben bought books.

Sentence (94a) gets only a generic reading, namely that books, in general, are expensive. The bare plural in it is accordingly said to receive a generic interpretation. Sentence (94b), on the other hand, receives an existential interpretation, namely: there were some books that Ben bought.

The distinction between generic and existential bare plurals, which holds across Germanic languages, does not, however, hold for Balkan languages. In Balkan languages, generic readings are incompatible with bare plurals. Bare plurals in these languages get an existential interpretation only, as illustrated in (95). The same holds for Romance bare plurals (cf. Laca (1990), Longobardi (1994)).⁴⁵ Generic readings in Balkan (and Romance) languages require the definite determiner. This is shown in the Albanian example in (96), the counterpart of the English sentence in (94a).

- (95) Beni bleu libra.

⁴⁵ The typological difference concerning the incompatibility of generic readings with bare plurals in Balkan and Romance languages vs. their compatibility with bare plurals in English and other Germanic languages could be related to some parameter that is operative only in one of the language groups but not in the other. For a concrete proposal along these lines, cf. Delfitto & Schrotten (1991).

Ben bought books

‘Ben bought books.’

(96) *Libra-t janë të shtrenjtë.*

books-the are expensive

‘Books are expensive.’

My proposal on the impossibility of doubling and scrambling non-generic bare plural objects rests on the claim that generically and existentially interpreted bare plurals differ with respect to the D-feature: generic bare plurals are DPs with a morphologically null D, whereas existential bare plurals are NPs altogether lacking a D-projection. Consequently, generic and existential bare plurals differ with respect to their specificity feature: generic bare plurals are [+specific] (read: individual-denoting), whereas existential bare plurals are [-specific] (read: property-denoting).⁴⁶ Since clitics are D⁰-heads, they can only double DPs, not NPs. Clitic doubling and scrambling of existential bare plurals would then cause the derivation to crash.

3.7.1. Vagaries of “Reference”: More on Generic vs. Existential Bare Plurals

Linguists agree that in examples like (97), the clausal predicate is a kind-predicate. As such, it must apply to a kind-denoting NP.

(97) a. Lions are widespread.

⁴⁶ This is independently proposed by É. Kiss (1996). However, É. Kiss relies on Enç’s (1991) account of specificity, which as was pointed out in section 3.4.3 is problematic.

- b. *A lion is widespread.

The sentence in (97a) is grammatical since bare plurals may denote kinds, that is, they may translate as constants, as in (98a). In contrast, the sentence in (97b) is ungrammatical because singular indefinites do not translate as kind-constants. Singular indefinites are ambiguous between a variable introducing expression and a predicate (cf. van Geenhoven 1996); consequently, their generic reading can only be obtained by quantification, as in (98b). However, this LF is illegitimate because a kind-predicate such as *widespread* cannot apply to an individual variable.

- (98) a. widespread (LIONS)⁴⁷
 b. Gen_x (x is a lion) [x is widespread]

Concerning the analysis of bare plurals, linguists do not agree. Carlson (1977) argued that bare plurals unambiguously denote kinds. Other authors, however, assume that bare plurals are ambiguous, being able to function either as kind-denoting terms or as variables (i.e. like a-expressions), depending on the clausal predicate (cf. Kratzer (1995), Krifka&alii (1995) *i.a.*). According to these authors, bare plurals denote kinds when used with a kind-predicate (*be widespread, become extinct, be numerous* etc.). In most other cases, for these authors bare plurals translate as variables and their generic reading is due to a generic operator that binds that variable. Under this view, examples like (99a) and (99b) have a common LF representation, which is given in (99c).

⁴⁷ Throughout this chapter capital letters are used to notate kind-constants.

- (99) a. Dogs are intelligent.
b. A dog is intelligent.
c. $\text{Gen}_x (x \text{ is a dog}) [x \text{ is intelligent}]$

Those authors who believe that (99c) is the representation of (99a) have to assume that bare plurals are lexically ambiguous between kind-denoting constants and individual variables. When the individual variables introduced by bare plurals are under the scope of a (covert) generic operator, the so-called “generic” reading as distinct from the kind-denoting interpretation arises, which is therefore different from the sense in which Carlson originally used the word.

Under Carlson’s analysis, the sentence in (99a) does not involve quantification but simple predication: the property intelligent is predicated of the kind DOGS, as in (100).

- (100) intelligent (DOGS)

The main difficulty with Carlson’s analysis is to make explicit the procedure by which the correct truth-conditions are obtained. (99a) is true if it is true of sufficiently many individual dogs, that is, of sufficiently many instantiations of the kind DOGS. That is, the sentence is not false even if some/few individuals of the kind DOGS are not intelligent. It is for this reason that some linguists introduce a Gen operator at LF, which binds individual realizations (i.e. variables) of the kind DOGS. But as some neo-Carlsonians have pointed out:

“...the fact that predication on kinds can in most cases be understood as distributively applying to the singular entities of which the kind is

made, is due to the fact that kinds are a particular type of collective entity. It is indeed known that distributivity is a general property of collective NPs such as *the board* or *the Beatles*.” (Dobrovie-Sorin, C. & B. Laca 1996:2)

Thus, Dobrovie-Sorin & Laca imply that the kind-denoting and the so-called “quantificational” generic reading fundamentally relies on the distinction between collective and distributive readings. Whether the distributive reading of bare plurals is due to quantificational strategies even in sentences with no overt quantifiers, this study will not contribute to assessing.

So far then, deciding between the Carlsonian view that bare plurals are unambiguously kind-denoting or the view according to which they are ambiguous between a kind-denoting and a variable interpretation is not important for my purposes, since both kinds and individual instantiations of kinds are types of individuals, not of properties. In other words, both constants and variables are LF translations for individuals, not for properties. Therefore, I will not undertake to present the arguments of those authors who claim that bare plurals are ambiguous between a kind-denoting and a variable interpretation and translate therefore either as constants or as variables at LF. Likewise, I will not undertake to present the counter-arguments of the neo-Carlsonians against the quantificational analysis of generic bare plurals. For extensive discussions on this debate, the reader is referred to van Geenhoven (1996), Dobrovie-Sorin & Laca (1996). What is important for my purposes, is the fact that bare plurals in addition to denoting kinds or individual instantiations of kinds (in the latter case, yielding so-called “quantificational variability effects”), may also denote properties and consequently translate neither as constants nor as variables, but as predicates at LF, as will be explicated below. For simplicity of presentation, I will then use the term “generic” as applied to bare plurals to cover both their kind-denoting function as well as their variable interpretation, as

opposed to the term “existential” which will be reserved for the non-kind-denoting, non-variable interpretation of bare plurals. The “existential” (i.e. non-generic) reading of bare plurals is illustrated in the example in (101).

(101) Ben bought newspapers.

The sentence in (101) asserts that there were (some) newspapers that Ben bought. Unlike the bare plural in (101), the bare plural in (99a) cannot be interpreted existentially. That is, the sentence in (99a) does not mean that there exist some intelligent dogs but that it is a property of dogs that they are intelligent. On the other hand, bare plurals in many sentences are ambiguous between a generic and an existential interpretation. One such example is given in (102).

(102) Sharks are visible.

The meaning of the sentence in (102) may be rendered either as in (103a) or as in (103b), depending on whether the bare plural in it receives a generic or an existential interpretation.

(102) a. It is a property of sharks that they are visible.

b. There are some sharks visible.

I will not deal with the question of what allows a bare plural noun phrase to be interpreted either existentially or generically in examples like (102), and what excludes an existential interpretation in examples like (99a). This is a question raised

and discussed by Kratzer (1995), Diesing (1992), Kiss (1996) and Cohen & Erteschik-Shir (1997).

As already mentioned, my proposal concerning the impossibility of doubling and scrambling existential bare plural objects rests on the claim that generically and existentially interpreted bare plurals differ with respect to the D-feature: generic bare plurals are DPs with a morphologically null D, whereas existential bare plurals are NPs altogether lacking a D-projection. Consequently, generic and existential bare plurals differ with respect to their specificity feature:⁴⁸ generic bare plurals are [+specific], whereas existential bare plurals are [-specific].

In this section, I have shown what it means for generic bare plurals to be specific: It means that generic bare plurals denote kinds or individual instantiations of kinds and translate therefore either as constants or as variables at LF. In both cases, generic bare plurals denote individuals, not properties.

I claim that existential bare plurals, on the other hand, denote properties. As such, they are not constants or variables but predicates. Their existential force comes from a source external to the bare plurals themselves, namely from the verb (cf. Carlson's lexicalized existential quantifier discussed in section 3.4.7. In section 3.4 I argued that bare singulars denote properties as well. What then is the difference (if any) between bare singulars and existential bare plurals, given that all languages that have bare singulars also have existential bare plurals? I provide an answer to this question in the following section.

⁴⁸ Recall from section 3.4 that D is the locus of specificity which for noun phrases underlies argumenthood.

3.7.2. Bare Singulars, Existential Bare Plurals and Event Reference

Consider the sentences in (104). Formally, these sentences differ from each other in that the direct object of (104a) is a bare singular noun whereas the direct object of (104b) is a bare plural noun.

(104) a. Eva hat gestern Zeitung gelesen.

Eva has yesterday newspaper read

b. Eva hat gestern Zeitungen gelesen.

Eva has yesterday newspapers read

Semantically, both (104a) and (104b) necessarily have an event-related reading. What then is the difference between them? It seems to me that the difference between (104a) and (104b) has to do with event reference. So, while the meaning of the sentence in (104a) can be rendered as in (105a) or (105b), the minimally different (104b) containing a(n existential) bare plural instead of the bare singular can be rendered as in (105b), not as in (105a).

(105) a. Yesterday Eva engaged in (at least) one newspaper-reading event.

b. Yesterday Eva engaged in several events of newspaper reading.

Thus, (104a) and (104b) are not fully synonymous; only (105b) entails (105a) but not the other way round. (104b) can only mean that Eva is to engage in several events of newspaper reading. That is, direct object existential bare plurals imply multiplicity of event reference. Strictly speaking, there is no “small” event in which a person can read more than one newspaper at a time. Hence, it is as if the bare plural in (104b) would

scope over the whole VP.⁴⁹ Whether this is an instance of genuine wide scope of the bare plural or some kind of a pseudo-scope effect, this study will not contribute to assessing. My claim that existential bare plurals induce multiplicity of event reference is compatible with the claim by Cohen & Erteschik-Shir (1997) that existential bare plurals denote properties of pluralities.

Thus, I am claiming that existential bare plurals are the plural counterparts of bare singulars in the sense that they share the same basic meaning but differ in morphology. More specifically, existential bare plurals differ from bare singulars with respect to the number feature as well as the various meaning ramifications that this morpho-semantic feature induces. On one hand, the fact that bare singulars occur as direct objects of only those predicates whose bare plural direct objects can not get a generic interpretation supports the claim that existential bare plurals are the plural counterparts of bare singulars. The data in (106) is intended to show that bare singular objects are incompatible with predicates whose bare plural objects are interpreted generically.⁵⁰

⁴⁹ M. Krifka (1990) points out that similarly, number words can have wide scope, as in his example: 'Four thousand ships passed through the lock', which means: 'There were four thousand ship-passings'.

⁵⁰ The argument that bare singular objects are incompatible with predicates whose bare plural objects are interpreted generically cannot be tested in Albanian and other Balkan languages, since in these languages, like in Romance, bare plurals are incompatible with generic readings.

- (106) No: a. Per elsker/hater biler / *(en) bil.⁵¹
 Per loves/hates cars / (a) car
 ‘Per loves/hates cars/*(a) car.’
- b. Eva beundrer/tilber lingvister / *(en) lingvist.
 Eva admires/worships linguists / (a) linguist.
 ‘Eva admires/worships linguists/*(a) linguist.’

On the other hand, however, the reverse does not hold across all the languages that have bare singulars in object position. German is a case in point; in this language bare singulars in the function of direct object are quite sporadic, that is, not all the predicates whose bare plural direct objects receive an existential interpretation may combine with bare singular direct objects. However, in view of the fact that the meaning of bare singulars is a subset of the meaning of a-expressions (cf. the discussion in section 3.4.2) and since they also share the meaning of existential bare plurals, it is reasonable to try to relate the lack of (one-to-one) distributional parallelism between bare singulars and existential bare plurals within and across languages to economy considerations. That is, languages can afford to lack bare singulars because they have other means of imparting their meaning.

If existential bare plurals are the plural counterparts of bare singulars, then existential bare plurals and bare singulars should have the same clausal distribution,

⁵¹ L. Hellan (p.c.) points out that one can get a context where (106a) would be grammatical also with the bare singular. Crucially, however, the interpretation of (106a) in such cases can be rendered in English as: ‘Per loves/hates to drive’ or as: ‘Per loves/hates to have/keep/manage/run a car’. I claim that in such contexts the bare singular is not the object of the verb *love/hate* but the object of the predicate of an (elliptic) infinitival clause (cf. also the discussion of example (15) in section 3.3 and of example (114) later in this section).

among other things. However, at first sight, this prediction seems to be falsified by data such as in (107).

(107) Studenten lärmten auf der Strasse

students make noise in the street

‘Students are making noise in the street.’⁵²

Likewise, we saw that the bare plural in the sentence in (102) in addition to receiving a generic interpretation could also receive an existential interpretation. Further examples that seem to contradict the prediction that existential bare plurals can occur as subjects are given in (108).⁵³

(108) a. Firemen are available.

b. Girls know mathematics the best in my school.

c. In this village only women have blue eyes.

d. Volcanoes line both sides of the river.

e. Ancient figures are carved on the walls of this cave.

f. In this area, hot springs exist.

⁵² It is well-known that unlike simple present tense in English, simple present in German can have both an episodic and a generic meaning. That is, the German sentence in (107) can also mean: ‘Students make noise in the street’. However, I am interested only in the existential interpretation of the bare plural, hence the given English translation.

⁵³ The bare plural in (108a) may receive either a generic or an existential interpretation but here I am interested only in its existential interpretation.

I claim, however, that the examples (107)-(108) are only apparent counterexamples to the claim that existential bare plurals cannot occur as subjects. I propose that all of these existential bare plurals are not subjects but predicate nominals in Spec of CP. To illustrate, the structure of the sentence in (107) when the bare plural *Studenten* ‘students’ in it receives an existential interpretation would be something like the one given in (109).⁵⁴

(109) [_{TopP} [_{CP} *Studenten lärmen*_j [_{IP} [_{VP} *t_j* [_{PP} *auf der Straße*]] *t_j*]]]⁵⁵

As it happens, the bare plural *Studenten* ‘students’ in (107) under an existential interpretation is necessarily marked [+Focus]. This is in fact a defining property of all of the existential bare plurals in (108), too; that is, the existential bare plurals in (108) are either the focus of these sentences or contained within the focus domains of these sentences.⁵⁶ Thus, when the bare plural in (108a) is interpreted existentially, (108a) entails (110) and is entailed by it. And it is a property of existential *there*-constructions that the post-copular noun phrase is a focussed phrase (cf. Reinhart 1982). This argument applies to (108d,e), too, which, likewise, entail (111) and (112), respectively.

(110) There are firemen available.

⁵⁴ I will return to a more detailed discussion and representation of the structure of (107) in section 3.7.3.

⁵⁵ Recall from chapter 2 (section 2.3.3) that I claimed that the topmost projection of a root CP is TopP.

⁵⁶ In this context, cf. also Cohen&Erteschik-Shir (1997) who crucially argue that existential bare plurals are always focussed phrases.

(111) There are volcanoes on both sides of the river.

(112) There are ancient figures carved on the walls of the cave.

That the bare plural in (108b) is a [+Focus] phrase, is indicated by the fact that the sentence entails (113), a cleft construction. And it is a matter of no dispute that the post-copular noun phrase in cleft constructions is a focussed constituent (cf. Akmajian (1970), Higgins(1979)).

(113) It is girls who know mathematics the best in my school.

That the bare plural in (108c) is a [+Focus] phrase is brought out by the focus particle *only*. Finally, that *springs* in (108f) is not a subject is not a matter of controversy under the *Unaccusative Hypothesis* (cf. Perlmutter 1978), which classifies the verb *exist* as a typical unaccusative/ergative one.

The fact that all the existential bare plurals in (107)-(108) are [+Focus] phrases is compatible with my claim that they occupy Spec of CP, since as pointed out earlier in this thesis, the defining characteristics of a root Spec of CP is its [+Focus] feature. Note also that my claim that the existential bare plurals in (107)-(108) are predicate nominals ties in well with Strawson's (1971) view presented in section 3.4.6, namely that the defining characteristics of a predicate is its asserting function.

Given that the sentences in (108) contain no other noun phrases, at least no overt ones, they come out as subjectless sentences under my hypothesis that the existential bare plurals in (107)-(108) are predicate nominals. But English and German are not pro-drop languages. Yet, this fact does not preclude the possibility that the sentences in (107)-(108) might contain empty expletives. In fact, Platzack (1987) argues that

non-pro-drop languages may also contain empty expletives. Adopting this proposal, I claim that the empty expletives in these sentences occupy Spec of TopP.

Crucial evidence for the view that even in non-pro-drop languages there are sentences with non-overt subjects comes from another Germanic language, Norwegian. In section 3.3, I discussed the Norwegian example (15) repeated here for ease of reference in (114a). It was shown that although in Norwegian adjective phrases in predicative position agree in gender and number with their subject, in (114a) they don't: the predicative adjective here is marked for neuter gender, while the noun is masculine. The sentence in (114b) shows that the same non-agreement pattern arise also with bare plural nouns; here the noun is masculine, plural and the predicative adjective is still neuter, singular. If the bare nouns in (114) were really the subject of the sentences, such construction would be counterexamples to otherwise exceptionless agreement.

- (114) (Hellan 1986: 95) a. Bil er dyr-t.
 car_{masc,s} is expensive-**neut,s**.
 b. Biler er dyr-t.
 car_{masc,p} are expensive-**neut,s**.

In section 3.3, I proposed that the NP *bil* 'car' in (114a) was not the subject of this sentence, but a fronted direct object, probably derived from a construction like the one in (115a) or its variant (115b). The same reasoning can be extended to (114b), which differs from (114a) only in that instead of a bare singular, it contains a bare plural noun. In other words, I claim that the bare nouns in these sentences occupy some specifier position in the left periphery of the clause (i.e. in the CP domain).

- (115) a. Bil_i/biler_i er dyr-t ([å ha t_i]).
 car/cars is expensive-s,neut to have
 ‘To have a car/cars is expensive.’
- b. [(Å ha) bil/biler] er dyr-t.
 to have car/cars is expensive-s,neut
 ‘To have a car/cars is expensive.’

The fact that such non-agreement patterns as in (114b) do not arise with individual-level predicates, which as is well-known force a generic reading of their subject, indicates that the bare plural in (114b) is not the subject of the sentence. Thus, if the adjective *dyrt* ‘expensive’ in (114b) is replaced by *rødt* ‘red’, the result is ungrammatical, as shown in (116).

- (116) No: *Bil-er er rød-t.
 car-S_{masc,pl} are red-neut,sing

The sentence in (116) contrasts with that in (117), where the bare plural agrees with the predicative adjective for gender and number and receives a generic interpretation.

- (117) No: Bil-er er rød-e.
 car- S_{masc,pl} are red-pl
 ‘Cars are red.’

In section 3.3, I pointed out that the direct objects of certain transitive predicates (e.g. *love, hate, respect, admire* etc.) cannot be instantiated by bare singulars. In section 3.4 I claimed that this is so because predicates like *love, hate, respect* etc. may only take individuals, not properties as their internal arguments. Now, if existential bare plurals are the plural counterparts for bare singulars, two things are predicted. First, the bare plural objects of predicates like *love, hate* etc., which in Balkan and MS languages do not take bare singular objects, will be able to receive only a generic but not an existential interpretation in languages like English, in which bare plurals may generally receive either a generic or an existential interpretation. The sentence in (118a) below does not mean that there are (some) mistakes that Ben hates, but that it is a characteristic of Ben that he hates the kind MISTAKES. Likewise, (118b) does not mean that there are (some) students that Joe respects, but that Joe is characterized by the fact that he respects STUDENTS. In other words, this first prediction is borne out. Second, since in Albanian generic readings are incompatible with bare plurals, bare plurals should not be able to occur as direct objects of verbs like *love, hate*. The ungrammaticality of the Albanian examples in (118') shows that this second prediction is borne out as well.

(118) a. Ben hates mistakes.

b. Joe respects students.

(118')a. *Beni urren gabime.

Ben hates mistakes

b. *Xhoi respekton studentë.

Joe respects students

The fact that both of these predictions are borne out, provides further support for my claim that existential bare plurals are the plural counterparts of bare singulars.

In the following section, I turn to a more detailed discussion of the structure of (107).

3.7.3. Erroneous Subjects and Stipulations on the Bi-clausal Structure of Cleft Constructions

The sentence in (107) can be uttered as an out-of-the-blue sentence. I contend that under such discourse conditions, sentences like (107) are non-root clauses in Spec of root CPs, as indicated in the structure in (119).⁵⁷

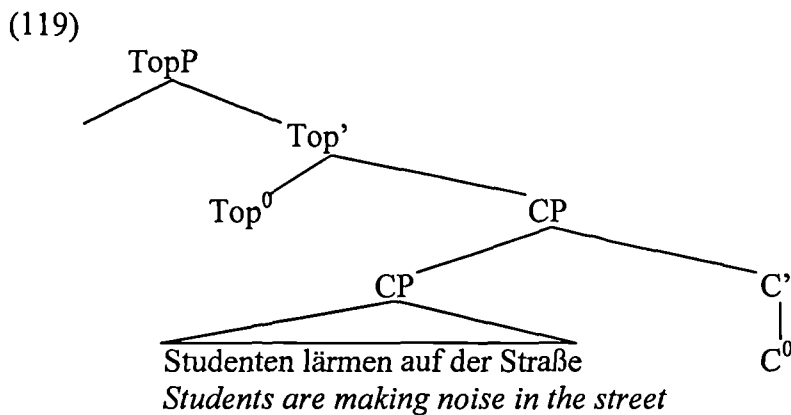

The fact that out-of-the-blue sentences are conceived of as focus CPs is compatible with the view that the Specifier position of root CPs is a canonical position for focus.

⁵⁷ I leave open the question as to how the predicate nominal *Studenten* 'students' in (119) comes to surface in the clause-initial position of the embedded CP.

What is the evidence for the view that out-of-the-blue sentences are non-root clauses? The out-of-the-blue sentence in (107) even in English is still a felicitous answer to a question like: *What is going on out there?* In this respect, it patterns with the sentence in (120Ba), which also is felicitous as an out-of-the-blue sentence. Yet, as (120Bb) shows, in the context provided (120Ba) cannot undergo root transformations (cf. Emonds 1970, 1976). But the sentence in (120Bb) *per se* is not ungrammatical.

(120) A: What is going on out there?

B: a. Hundreds of students are marching up to the Parliament.

b. #Up to the Parliament are marching hundreds of students.

If the whole clause in (120Ba) is a non-root clause generated in the Spec of CP, as I claim, the fact that root-transformations cannot be performed is predicted because these CPs are formally not roots. (121) is yet another example that illustrates the same point, namely that root-transformations cannot be performed in certain sentences that can felicitously be uttered in out-of-the-blue contexts.

(121) A: What are you guys doing this weekend?

B: a. We are visiting only the most famous monuments in Vienna.

b. #Only the most famous monuments in Vienna are we visiting.

The sentence in (107) is a sentence without an overt subject; the bare plural *Studenten* ‘students’ here is not a subject but a predicate nominal. The subject of this sentence is an empty expletive in Spec of TopP. This does not mean however that English does not have overt expletive subjects. In fact, I propose that the so-called existential *there-*

construction in English is derived precisely from structures like the one in (119), by insertion of the topical element, the expletive subject *there*, in Spec of TopP which as I argued in chapter 2 (section 2.3.3.3) is the topmost projection in a root clause. Once this topical element is inserted in Spec of TopP, the verb moves out of the non-root CP to Top⁰, presumably so that tense in the matrix clause can be licensed. Consequently, the sentence in (123) is derived, as is depicted in the tree-structure in (122).

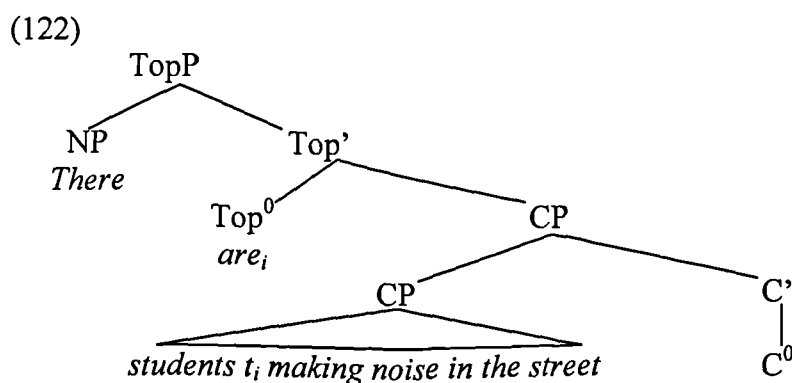

(123) *There are students making noise in the street.*

Under the hypothesis outlined here, the focussed constituent in both sentences (107) and (123) occupies the same structural position. I will now show that the clefted constituent in the cleft construction should also be analyzed as a predicate nominal. Since the structure of clefts is only tangential to the concerns of this thesis, I will not undertake to present a review of previous analyses. (For such a discussion, cf. Akmajian (1970), Higgins (1979).) Instead, I will sketch a novel analysis of cleft constructions according to which the cleft construction is derived from the pseudo-cleft construction which is bi-clausal.

One distinguishes between *cleft* sentences, also called *it*-clefts, and *pseudo-clefts* or *wh*-clefts. As seen in (124), clefts in English and many other languages have the form: (expletive) *it* + copula + focussed constituent + relative clause. Pseudo-clefts, on the other hand, have the form: (free) relative clause + copula + focussed constituent, as in (125).

(124) It is John {who / that / \emptyset } Mary wants.

(125) What Mary wants is John.

Both clefts and pseudo-clefts involve a focussed constituent, which I will argue occupies however different structural positions in both construction types. I propose the structure in (126) as the structure of the pseudo-cleft construction.

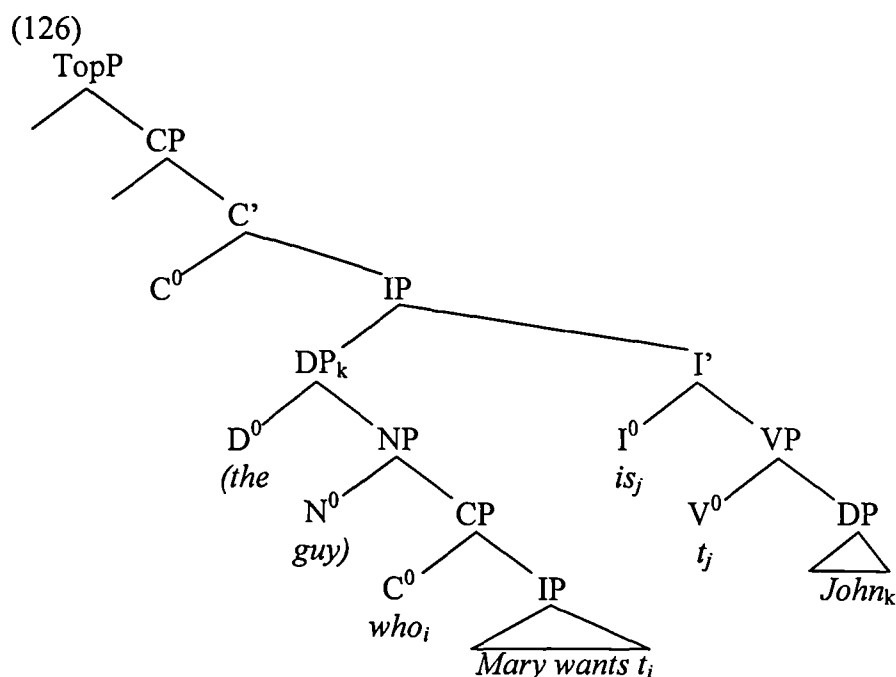

In (126) the DP *(The guy) who Mary wants* is the subject whereas *John* is a predicate nominal. In fact, *John* in (126) is the description of the item/object that Mary wants

and is therefore co-indexed with the subject DP by virtue of predication. That is, it is strictly speaking not referential. I claim that the cleft construction is derived from the structure in (126) through several movement operations. First, the predicate nominal *John* moves to Spec of the root CP, which is a canonical position for focus. It is no surprise that such movement is accompanied by verb movement to C^0 , since *wh*-movement in English invariably gives rise to I-to-C movement. These steps are illustrated in the structure in (127).⁵⁸

(127)

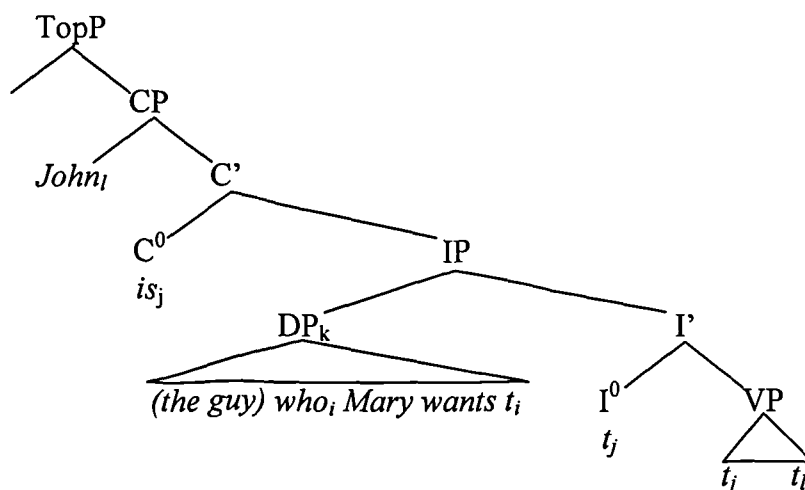

With these movement steps performed, the resulting construction is not yet a cleft construction but the string: *John is (the guy) who Mary wants*, which as it is, is a perfectly grammatical sentence in English. I claim that the cleft construction is derived precisely from the structure in (127) when the DP *the guy* is deleted and a topical element, the expletive *it*, is inserted in Spec of TopP in the same fashion that the element *there* is inserted in topic position in the existential construction. The

⁵⁸ As noted above, *John* and the subject DP *(the guy) who Mary wants* are co-indexed through predication. However, in the trees in (127) and (128) this does not show; *John* carries the index *l* to show that it has moved from inside the matrix VP where it leaves a trace. But the indexes *k* and *l* are certainly related through predication.

insertion of this topical element in turn triggers verb movement from C^0 to T^0 .⁵⁹ These movement steps are illustrated in the structure in (128).

(128)

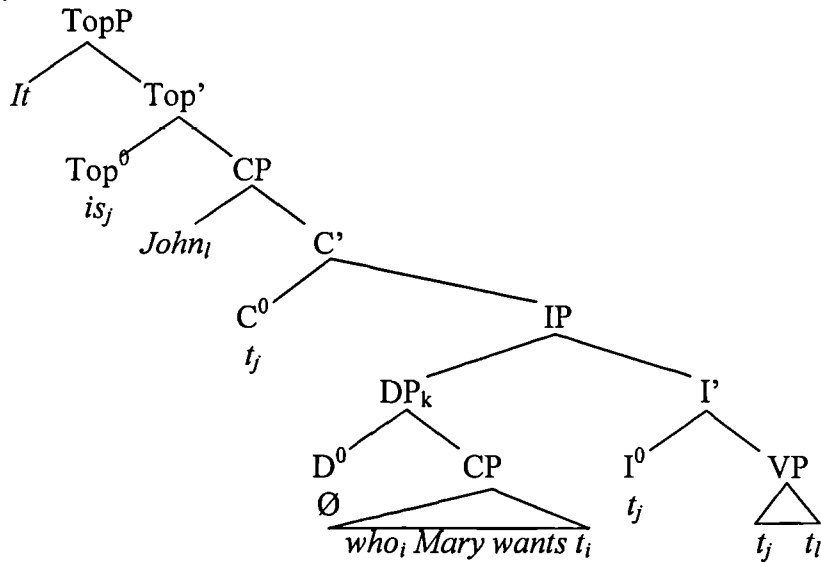

3.7.5. Section Summary

In this section I have argued that existential bare plurals are the plural counterparts of bare singulars in the sense that both share the same basic semantics. As such, existential bare plurals like bare singulars are NPs and not DPs with a morphologically null D. Consequently, existential bare plurals are non-specific. In contrast, generic bare plurals are DPs with a morphologically null D; they are specific.

I have argued that clause initial existential bare plurals are not subjects, as often assumed, but predicate nominals in Spec of CP. This is perfectly compatible with the analysis of bare plurals in Cohen & Erteschik-Shir (1997), who crucially argue that,

⁵⁹ Such a movement could not be motivated by the need to license tense in the matrix clause, though.

regardless of position in the structure of the clause, bare plural foci denote properties, are incorporated into the predicate and receive existential readings.

The syntactic distinction NP vs. DP (with morphologically null D) that I have drawn between existential and generic bare plurals, respectively, in addition to representing a principled mapping between syntax and semantics for bare plural nouns, is also motivated by the fact that generic plural nouns in Balkan (and Romance) languages necessarily require the presence of the definite determiner.

3.8. Conclusion

I argue for an account of the impossibility of clitic doubling and scrambling bare singulars and existential bare plurals which is based on the categorial distinction between DPs and NPs. I have shown that bare singulars and existential bare plurals are not DPs with a morphologically empty D, but NPs that lack a D-projection. As such, they cannot be doubled (in Albanian/Greek) and scrambled (in German/Dutch), as this would result in a feature mismatch between the [+D] clitic head (which is overt in the case of doubling and covert in the case of scrambling) and the [-D] NP. On the other hand, generic bare plurals are DPs with a morphologically empty D. As such, they can scramble unless they are marked [+Focus].⁶⁰

⁶⁰ Since bare plurals are in Balkan languages incompatible with generic readings, the question of doubling them does not even arise.

Chapter 4

Non-active Morphology in Albanian and Event (De)composition

4.0. Introduction

This chapter investigates non-active morphology in Albanian. It makes the following crucial claim: non-active morphology is a morphological operation that affects the lexical meaning of a predicate by changing either the aspectual template associated with it or the pairing of a name (a constant) with the aspectual template of a predicate. That is, non-active morphology, which in Albanian subsumes passive, is not an operation that solely affects the number of arguments in the argument structure of a predicate without affecting its lexical meaning.

This chapter is organized as follows. Section 1 sets out the distribution of non-active morphology and describes the semantics of the basic patterns that obtain. Section 2 discusses the difference between active and non-active causatives. Section 3 concerns the generalisation that explains the distribution of the range of readings that obtain with predicates affixed with non-active morphology. In section 4 I present a formal analysis of Albanian non-active morphology that is crucially based on the model of lexical meaning proposed in Pustejovsky (1991). Finally, sections 5, 6 and 7

show how the specific readings that arise when predicates are affixed with non-active morphology can be derived from the proposal in section 4. Section 5 deals with the derivation of the stative reading and the generic-potential reading, section 6 explains the derivation of the ‘suddenly’ reading, and section 7 that of the accidental causation reading.

4.1. Non-active Morphology: A First Look at the Problems

Albanian has two distinct conjugational paradigms, namely, active vs. non-active, as illustrated in (1) for simple present.¹

¹ The non-active conjugation is also referred to as medio-passive in traditional Albanian grammars (cf. Demiraj 1986). The non-active conjugation is realized by employing three different linguistic means with a well-defined distribution, namely: special formants suffixed to the verbal stem (for the simple tenses except the Aorist, as in (1)), the pre-verbal reflexive clitic *u* (for the Aorist and the non-finite forms of the verb, as in (4)), and the auxiliary *jam* ‘be’ plus the participle form of the verb (for all periphrastic tenses).

(1) <u>Active (act)</u>	<u>Non-active (nact)</u>
1sg. tha-j	tha-h-em²
dry-act, 1s	dry-nact, 1s
'I dry (stuff)'	'I get/become dry'
2sg. tha-n	tha-hesh
3sg. tha-n	tha-het
1pl. tha-jmë	tha-hemi
2pl. tha-ni	tha-heni
3pl. tha-jnë	tha-hen

All morphologically non-active verbs in Albanian are unaccusative. The term unaccusative here is used to mean what it literally suggests, namely the inability to take an object with accusative case (cf. Burzio 1986). This definition of unaccusativity is slightly different from Perlmutter's (1978) original characterization of the class, according to which, an unaccusative verb is one that takes an internal argument but no external argument. My preference for Burzio's syntactic characterization to Perlmutter's, though not crucial for the purposes of this paper, is motivated by the need to provide at least one defining characteristic of the class of non-active predicates that is solely a matter of empirical observation: structural case in Albanian has morphological spell-outs, so determining whether or not a predicate can assign accusative case to an NP-argument is a straightforward matter. This would

² The segment *h* in *tha-h-em* in (1) is in fact a segment inserted between the stem of the active verb and non-active morphology to prevent hiatus. Since this segment is inserted whenever non-active morphology attaches to an active verb whose stem ends in a vowel sound, I will for simplicity of presentation treat it as part of the non-active inflection.

immediately raise a question about unergatives which also do not assign accusative case given that they only have an external argument. However, unergative predicates are morphologically active in Albanian, though they may undergo impersonal passivization, which in Albanian involves affixation of non-active morphology which in turn suppresses the (non-oblique) external argument.³ Perlmutter's characterization of the unaccusative class, on the other hand, does not seem to be quite as straightforward. For instance, while there is little disagreement among scholars as to agentive or causative participants being external arguments and as to the non-agentive nature of internal arguments (e.g. the expressed/overt argument in a passive or raising construction), Perlmutter's definition could not be readily applied to a language in which 'passive' (i.e. non-active) morphology attaches not only to the verb in passive and raising constructions but may also attach to the verb in reflexive constructions where agent control on the part of the overt NP-argument is not suppressed. This is precisely the case in Albanian, as will be explicated below. Moreover, certain predicates that denote transitions and are commonly assumed to belong to the unaccusative class in English (i.e. the class of verbs that have only one internal argument and no external argument), are formally active in Albanian. They may, however, undergo impersonal passivization, which is generally assumed to signal unergative status. I will term such predicates pseudo-unaccusative. Examples of some pseudo-unaccusative predicates are: *vij* 'I come', *mbërrij* 'I arrive', *dal* 'I exit', *hyj* 'I enter', etc.^{4,5} In spite of these problems with Perlmutter's definition, in view of the

³ Note that it is often assumed that the ability to undergo impersonal passivization signals unergativity whereas the inability to do so signals unaccusativity (cf. Perlmutter (1978), Marantz (1984), Levin & Rappaport Hovav (1995) *i.a.*).

⁴ The citation form for the Albanian verb is first person singular present tense.

fact that there appear to exist certain systematic relations between the ability of a verb to take an external argument and its ability to assign accusative case to its internal argument (cf. Burzio's Generalization), I will throughout this chapter use the terms external and internal argument in the way they are commonly employed in the *Government and Binding* tradition.

Hence, a crucial characteristic of non-active paradigms: they do not accept noun phrases that bear accusative case. Since the verb in passive constructions is always formally non-active, its overt NP-argument(s) cannot bear accusative case, as shown in (2b) vs. (2a).⁶

(2)a. Shi-u lagt-e edhe fole-në e zogjve.

rain-the_{nom} soak-act.Imp3s also nest-the_{acc} GEN birds

'The rain was also soaking the birds' nest.'

b. Edhe fole-j-a/*fole-në e zogjve lag-ej nga shi-u.⁷

also nest-the_{nom}/*nest-the_{acc} GEN birds soak-nact.Imp3p by rain-the

'The birds' nest was also being soaked by the rain.'

⁵ In some dialects, some of these pseudo-unaccusative predicates are real unaccusatives (i.e. morphologically non-active) and some have mixed paradigms (e.g. active in simple present/past, non-active in the Aorist). In view of these complications, pseudo-unaccusatives are excluded from my consideration in this study.

⁶ This goes also for double object verbs. That is, there are no double-object verbs in the passive that retain one accusative argument.

⁷ The Albanian equivalent of the English (agentive) *by*-phrase can be headed either by the preposition *nga* or *prej*, the difference being that whereas the former assigns nominative case, the latter assigns dative case (referred to as ablative in traditional Albanian grammars). For convenience, I will use only one of them (namely: *nga*) throughout.

Non-active morphology in Albanian may also encode reflexivity, as illustrated in (3).⁸ This example shows that also in non-active reflexive constructions the overt NP-argument is incompatible with accusative case.

- (3) Fëmi-ja/*fëmi-jën la-hej gjithë qejf.
 child-the_{nom}/*child-the_{acc} wash-nact, Imp3s all pleasure
 ‘The child was washing herself happily.’⁹

Raising verbs in Albanian are lexically non-active (cf. e.g. (4)). That is, their active counterparts do not exist. Again, the internal argument cannot bear accusative case.

- (4) Papritmas u duk diell-i/*diell-in.
 suddenly nact.P3s appear sun-the_{nom}/*sun-the_{acc}
 ‘Suddenly, the sun appeared.’

Non-active predicates typically denote a state or a change of state. They include verbs of motion, as in (5a), as well as verbs denoting states or changes in the physical, physiological or psychological state of the subject, as in (5b).¹⁰

⁸ This does not mean that the verb in reflexive/reciprocal constructions in Albanian is invariably non-active morphologically. It can also be active in which case reflexivity is necessarily encoded in an anaphoric expression, as in (i), the active counterpart of (3). (Overt anaphors are incompatible with non-active reflexive predicates.)

(i) Fëmi-ja la-nte vete-n gjithë qejf.
 child-the_{nom,fem} wash-act, Imp3s self-the_{acc} all pleasure
 ‘The child was happily washing herself.’

⁹ Example (3b) can of course be interpreted as a passive construction, too.

- (5)a. *hidh-em* (I jump), *mbështet-em* (I lean), *ngri-hem* (I get up) etc.
- b. *pendo-hem* (I regret), *dëshpëro-hem* (I sadden), *gëzo-hem* (I cheer up),
hidhëro-hem (I get bitter), *kreno-hem* (I am/get proud), *bezdis-em* (I get
 pestered), *pezmato-hem* (I get depressed), *pikëlllo-hem* (I get hopeless), *koll-em*
 (I cough), *sill-em* (I behave), *frikëso-hem* (I get scared), *bë-hem* (I become),
dobëso-hem (I get thin/weak), *egërso-hem* (I get furious), *fishk-em* (I wither),
nxi-hem (I blacken), *rrudh-em* (I wrinkle), *plak-em* (I age), *rino-hem* (I
 rejuvenate), *përtëri-hem/shëro-hem* (I recover), *qetëso-hem* (I relax), *tkurr-em* (I
 shrink), *enjt-em/fry-hem*, (I swell), *skuq-em* (I blush), *zverdh-em* (I become
 pale), *vrenjt-em* (I frown), *përpiq-em* (I try), *mba-hem* (I survive), *mbet-em* (I
 remain), *gëlltit-em* (I swallow).

Many non-active predicates seem to be derived from their active counterparts by affixation of non-active morphology. Compare for instance, the non-active predicates in (5a) and the active predicates in (6a). Likewise, some of the predicates in (5b) are the non-active counterparts of the active predicates in (6b). However, raising verbs are lexically/morphologically non-active predicates that have no active lexical counterparts. Further examples of morphologically non-active predicates that have no active counterparts are given in (7). One could call such predicates ‘deponent’ after Latin grammars.¹¹

¹⁰ Non-active verbs (unless passive or reflexive) are referred to as ‘middle’ verbs in Albanian traditional grammars (cf. Demiraj 1986). Middle verbs are in these grammars defined as non-active formally but as active intransitive meaningwise.

¹¹ The fact that there exists a large class of non-active predicates that do not have active counterparts while non-active morphology can attach to all unergative predicates seems to suggest that

(6)a. *hedh* (I throw), *mbështe-s* (I support), *ngre* (I lift), *nis* (I begin)

b. *dëshpëro-j* (I make sad), *gëzo-j* (I make glad), *hidhëro-j* (I make bitter), *bezdi-s* (I disturb), *frikëso-j* (I scare), *bë-j* (I make/do), *dobëso-j* (I make weak), etc.

(7) *kreno-hem*_{nact} - **kreno-j*_{act}

I am proud

zoto-hem - **zoto-j*

I swear

dergj-em - **dergj*

I linger

dridhto-hem - **drithto-j*

I shiver

pendo-hem - **pendo-j*

I regret

mrekullo-hem - **mrekullo-j*

I wonder

përgjigj-em - **përgjigj*

I answer

duk-em - **duk*

I look/appear

unaccusatives are primitive and unergatives derived (cf. Hale & Keyser 1993). (Cf. also Davis (1997) who argues that all predicates are based on roots which are lexically associated with a single, internal argument and that all transitive and all unergative predicates are derived.)

The non-active predicates in (5a) that have morphologically active counterparts (cf. the predicates in (6a)) seem for the most part to be merely reflexivized versions of the latter. This means that predicates like *jump* and *get up* could be lexically decomposed into *throw oneself* and *lift oneself*, respectively. Here, non-active morphology functions as a reflexivizer. The question then arises as to whether the generalisation in (8) can be drawn.

(8) Non-active non-deponent predicates are inherently reflexive.

Consider the Albanian examples in (9) and (10).

(9)a. Ana u hidhërua.

Anna nact saddened

‘Anna saddened.’

b. Ana i hidhëroi miq-të.

Anna them_{cl} saddened guests-the

‘Anna saddened her guests.’

c. Ana e hidhëroi vet-en aq shumë, sa u sëmur.

Anna it_{cl} saddened self-the so much that nact sickened

‘Ann saddened herself so much that she got ill.’

(10) a. Beni u gëlltit dhe filloi të fliste.

Ben nact swallow and started to speak

‘Ben swallowed and started to speak.’

b. Beni gëlltiti pështym-ën/ ushqim-in.

Ben swallowed saliva-the / food-the

‘Ben swallowed his saliva/his food.’

c. *Beni gëlltiti vet-en.

Ben swallowed self-the

‘Ben swallowed himself.’

The verbs both in (9a) and (10a) are formally non-active. None of them is a deponent predicate; both have active counterparts – cf. (9b) and (10b). However, while (9a) may receive a reflexive interpretation, (10a) cannot. This is why the active verb *hidhëroj* ‘I sadden’ may take an anaphoric direct object (as given in (9c)), whereas the active verb *gëlltis* ‘I swallow’ cannot do so (as given in (10c)).¹² This fact shows that the generalisation in (8) cannot be maintained.

All and only morphologically active predicates (irrespective of whether unergative, transitive or pseudo-unaccusative (cf. (11c,d,e)) permit impersonal passivization. This is illustrated in (11).

(11) a. (Këtu) puno-het/fli-het/lexo-het (këtu).

(here) work-nact.Pr3s/sleep-nact.Pr3s/read-nact.Pr3s (here)

‘One works/sleeps/reads here.’ or ‘One can work/sleep/read here.’

¹² Reinhart & Reuland (1993) argue that a predicate is reflexive if and only if it is linguistically marked as such (cf. also Hellan (1988)). Reflexivization can be intrinsic or extrinsic. Intrinsic reflexivization involves marking of verbs as reflexive in the lexicon, whereas extrinsic reflexivization involves marking an argument of a verb as reflexive.

- b. Deg-ët e kësaj peme thy-hen në dimër.
 branches-the_{nom} of this tree break-nact.Pr3p in winter
 ‘The branches of this tree (always) break in the winter.’
- c. Dil-et/ hy-het/ vih-et këtej.
 exit-nact.Pr3s/ enter-nact.Pr3s/ come-nact.Pr3s this way
 ‘One (can) exit(s) / enter(s) / come(s) this way.’
- d. Në maj-ën e mal-it mbërri-het kollaj.
 in top-the_{acc} GEN mountain-the arrive-nact.Pr3s easily
 ‘One arrives easily at the mountain-top.’
- e. Në Austri jeto-het gjatë.
 in Austria live-nact.Pr3s long
 ‘One (can) live(s) long in Austria.’

With the exception of (11a), the non-active predicates in (11) (more generally, imperfective non-active predicates) yield either a habitual or a potential/ability reading only. There are no actuality entailments of truth.

The sentence in (11a) represents a slightly more complex phenomenon. A possible reading for (11a) is as given in (12). As its English translation indicates, under this reading, (11a) certainly carries an actuality entailment. I suggest that this actuality entailment is associated with a VP-external progressive operator (which may be overt or covert), as Albanian like many other Balkan (and also Romance) languages has two morphologically and aspectually distinct simple past tense forms: perfective vs. imperfective.

(12) (Kētu) (po) puno-het/fli-het/lexo-het.

(here) (Prog) work-nact.Pr3s/sleep-nact.Pr3s/read-nact Pr3s

‘There is working/sleeping/reading going on here.’

The generic-potential reading of the sentences in (11) entirely disappears when the aspect of the sentence is changed from imperfective to perfective. When non-active morphology attaches to predicates that denote activities and have perfective aspect form, the reading that obtains may be rendered as: Some contextually salient situation previous to the utterance time was characterized by some working/sleeping/reading etc. event(s). I will assume that this reading is stative. For instance, the sentence in (13) asserts that some contextually salient situation before utterance time was characterized by some dancing-event(s) or was adequately describable in terms of some dancing activity. That is, the focus of interpretation in (13) is on defining some state/situation that obtained rather than on asserting the performance of some dancing activity. In other words, in (13) some situation is identified through a (characteristic) property, namely dancing.

(13) U kērcye.

nact, P dance_{3s}

‘There was dancing.’

When non-active morphology attaches to predicates that denote transitions and have perfective aspect form, a suddenly, spontaneously, unexpectedly or all-at-once reading obtains. This is illustrated in (14).

(14) U hap der-a.

nact open_{P,3s} door-the

‘Suddenly/all at once, the door opened.’

Predicates that denote activities (i.e. unergatives and transitives) can be affixed with 3rd person non-active morphology and bestowed with a dative argument, yielding a state. This is illustrated in (15) and (16).¹³

(15) a. Më fli-het/ha-het/pi-het.

me_{cl.dat} sleep-nact/eat-nact/drink-nact

‘I feel like sleeping/eating/drinking.’/ ‘I am sleepy/hungry/thirsty.’

b. Më puno-het/këndo-het/lexo-het (një libër)/shko-het në kinema.

me_{cl.dat} work-nact/sing-nact/read-nact (a book)/go-nact to movies

‘I feel like working/singing/reading (a book)/ going to the movies.’ or: ‘I am in a working/singing/reading/movie-going mood.’

(16) Ben-it i-u fjet/punua.¹⁴

Ben-the_{dat} him_{cl.dat}-nact sleep_{P3s}/work_{P3s}

‘Ben felt like sleeping/working.’

¹³ Note that while the verbs in the sentences in (15) have imperfective aspect form, those in (16) have perfective aspect form.

¹⁴ In (16) the dative clitic *i* and the reflexive clitic *u* which indicates non-active morphology form a clitic cluster. For a detailed description of some of the clitic cluster paradigms in Albanian, cf. Kallulli (1995).

Note that the events in (15) and (16) are all states, not activities any longer.¹⁵ Moreover, the (human) participants in these events totally lack control over them, that is, they are not agents. In other words, under no circumstances can the non-active predicates in (15) and (16) be interpreted as causative (i.e. reflexive) meaning something like: I cause(d) myself to sleep/eat/drink etc.

Given that these paradigms are so productive, postulating two lexical items, one specified as an activity and another as a stative predicate is, in view of economy considerations, unsatisfactory, unless there is a principled relation statable between the two lexical items, which presumably would be why this process is so productive. So, by parsimony it would be desirable to derive one from the other. However, existing theories of passivization do not readily provide solutions. Let me point out once again that the sentences in (15) and (16) don't just contain non-active morphology; they are genuine passive constructions (not e.g. middle or reflexive constructions), which means among other things that they are not agentive predications.¹⁶ Indeed they are stative. Passive is commonly defined as an operation that suppresses an external argument position or the agent role in the thematic grid of the verb (depending on the theory), that is, as an operation that affects the number of arguments that a predicate has without affecting its lexical meaning (cf. Levin & Rappaport Hovav 1995). In (15) and (16), the agent or as I will explain below agenthood, rather, is suppressed (the

¹⁵ Note that neither (15) nor the perfective sentence in (16) carries any actuality entailments. While Ben in (16) might have been sleepy or feeling like working throughout several hours, he might have slept/worked for part of the time or all of the time he felt like sleeping/working, just as he might have slept/worked for none of this time.

¹⁶ While it might be convenient to exclude constructions such as those in (15) and (16) from the realm of passive constructions on the grounds that non-active morphology does not necessarily mean passive, there is no *a priori* evidence that the constructions in (15) and (16) are not genuine passive constructions, especially in view of the fact that they cannot be interpreted as reflexive or middle constructions but exclusively as non-agentive predications.

sentences are stative), but this is not all. In addition, a dative argument has surfaced which, moreover, is not an agent and is therefore not in the argument structure of the active counterparts of the predicates in (15) and (16) (namely: *sleep, eat, drink, work, read, sing, go*), which, like in English, take only a nominative external argument and (for the transitive predicates) an additional accusative theme/internal argument.

It needs to be pointed out that all activity verbs when affixed with non-active morphology and associated with a dative argument are ambiguous between a stative interpretation as discussed above and as in (17a), and a jointly generic-potential reading as in (17b) below when in the scope of certain operators (e.g. negation, adverbs of quantification etc.).

(17) An-ës nuk i shko-het në zyrë.

Ann-the_{dat} not her_{dat.cl} go-nact.Pr3s in office

a. ‘Ann doesn’t feel like going to her office.’

b. ‘One does not (cannot/should not) go to Ann’s office.’

Moreover, a dative argument can combine with non-active predicates (cf. (18b)) whose active counterparts denote a change of state/transition (cf. (18a)). Active predicates that denote transitions are invariably causative.¹⁷ That is, active predicates that denote transitions have underlying causative semantics (cf. e.g. Pustejovsky (1995)).

¹⁷ In view of the complications noted above, throughout this paper I exclude pseudo-unaccusative predicates in Albanian from the class of morphologically active predicates that denote transitions.

(18) a. Ben-i the-u dritar-en.

Ben-the_{nom} break-actP3s window-the_{acc}

‘Ben broke the window.’

b. Benit i-u thye dritar-ja.

Ben_{dat} him_{dat.cl}-nactP break-3s window-the_{nom}

‘Ben accidentally broke the window.’

What is the difference (if any) between (18a) and (18b)? While (18a) can have either an accidental causation reading or a reading whereby the subject wilfully or intentionally brings about a certain state of affairs, namely that of a broken window, (18b) can only have what could be described as an accidental reading. That is, the human causer in (18b) cannot control the event specified by the verb. It seems then that ‘overt agents’ are excluded from constructions like the one in (18b). This observation is compatible with the fact that dative agents and *nga/prej* (passive agent) phrases are mutually exclusive.¹⁸ As the example in (19) shows, the combination of a dative argument with non-active predicates whose active counterparts denote a transition, describes an event that happened spontaneously, all at once, suddenly, unexpected or accidentally.

¹⁸ Example (18b) can also mean: ‘Ben’s window suddenly got broken’. Under this interpretation the dative argument is compatible with a (passive agent) *nga* phrase, as in (i):

(i) Ben-it i-u thye dritar-ja nga er-a.
Ben-the_{dat} him_{dat.cl}-nactP break-3s window-the_{nom} by wind-the_{nom}
‘Ben’s window broke by the wind.’

- (19) Ben-it i-u lag/dogj dor-a.
 Ben-the_{dat} him_{d.cl}-nactP wet/burn-3s hand-the
 ‘Ben wet/burnt his hand accidentally.’
 ‘Ben’s hand got suddenly wet/burnt.’

While there might be good reasons to unify the accidental causation and the suddenly reading, given that both readings focus on the *inception* of the state or change of state denoted by the predicate,¹⁹ there is one aspect with respect to which such unification seems problematic: while for the accidental causation reading to arise the non-active predicate has to combine with a dative argument, for the suddenly reading this is not a necessary condition. As was discussed above, the sentence in (14) could have a suddenly reading even though its predicate unlike that of (19) is not a transitive non-active predicate.²⁰ Crucially, however, (14) cannot have an accidental causation reading. I will nevertheless treat the accidental and the suddenly reading of sentences with transitive non-active predicates as a unitary reading.

To summarise the discussion so far: when non-active morphology attaches to predicates that denote activities it yields either a generic-potential or a stative reading; when it attaches to predicates that denote transitions it yields either a generic-potential or a suddenly reading. Moreover, when a dative argument combines with a non-active predicate whose active counterpart is an unergative or a transitive verb that does not combine with a dative argument, it suppresses the control of the agent over the action

¹⁹ For instance, Dowty (1986) argues that an adverb like *suddenly* will cancel the pragmatic inference that the state obtained earlier yielding an inceptive interpretation of the state.

²⁰ I refer to all non-active predicates that take two arguments (viz. a dative argument and a nominative argument) as transitive non-active predicates.

denoted by the verb, yielding either of two readings: with a verb which in its active form denotes an activity, it yields a state (e.g. *I am hungry*); with a verb which in its active form denotes a transition, it yields an accidental causation (e.g. *I accidentally broke the window*) and/or a suddenly reading (e.g. *My window suddenly broke*).

Thus, Albanian non-active morphology raises several questions. First, what is the ultimate generalisation (if any) that explains the distribution of the stative (and the generic/potential) reading, the suddenly reading and the accidental causation reading? Secondly, can all of these readings be formally and uniformly derived? Finally, how is non-active morphology related to these derivations?

Previous Analyses: Massey (1991)

Within the *Principles and Parameters* framework, an analysis of non-active voice in Albanian is provided in Massey (1991). In this section I will present the crux of her analysis.

Massey argues for a classification of Albanian verbs into instantiations of five universal aspectual classes, DO-TO, BECOME, CHANGE, DO, and BE, each of which directly projects a unique and characteristic D-structure with both active and non-active inflection. Crucially, Massey claims that while active voice in Albanian is the overt morphological expression of an INFL that projects a thematic Specifier of IP position at D-structure irrespective of the inherent aspectual class of the predicate, non-active voice prevents the syntactic projection of external arguments in the VP-external subject position at D-structure. This distinction is represented graphically in the tree diagrams below:

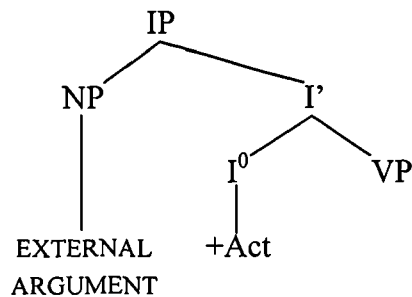
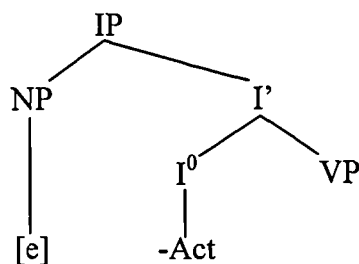
(20) *Active*(21) *Non-active*

The crucial idea in Massey's approach that initial syntactic structure in Albanian is predictable from voice and aspectual class without reference to theta-roles is of course rather interesting. However, if some theory, say theory (x), can account for the same range of data as another theory (y) by postulating fewer primitives than theory (y), or by showing that certain principles that have the status of primitives in theory (y) are further decomposable into subparts and that certain operations apply on these subparts, theory (x) is certainly to be preferred on conceptual grounds. More specifically, if we can show that Massey's universal predicates are not primitives but are derived, then the question arises as to whether a better analysis is conceivable for non-active morphology in Albanian. In section 4.5, I start outlining what I consider to be such an analysis. Crucially, it relies on Pustejovsky's (1991) idea that certain operations apply to subeventual entities in an event structure. However, before putting forward my analysis of non-active morphology, I will present certain preliminary insights and generalizations.

4.3. Two Kinds of Causation

Recall that both the active predicate in (18a) and the non-active predicate in (18b) can be used to describe a situation in which Ben accidentally breaks the window. What then is the difference between an active causative and a non-active causative? These two types of causatives differ in one crucial respect: the causer in a non-active causative must be a human participant; substitution of the nominal *the earthquake* or *the wind* for *Ben* in (18b) yields an ungrammatical sentence, as is shown in (22).

- (22) *Tërmet-it/*er-ës i-u thye dritar-ja.
 earthquake-the_{dat}/wind-the_{dat} it_{d.cl}-nact.P break-3s window-the_{nom}
 ‘The earthquake/the wind accidentally broke the window.’

In contrast, an active causative predicate imposes no such restriction on its subject: the causer of some (change of) state can be either a human participant such as ‘Ben’ in (18a) or a non-human participant such as *the earthquake* or *the wind*, as in (23).

- (23) Tërmet-i/er-a the-u dritaren.
 the earthquake/the wind break-act.P3s the window
 ‘The earthquake/the wind broke the window.’

Relying on Jackendoff’s (1990) distinction between extrinsic instigation and wilful agency, Demirdache (1997) points out that only participants capable of wilful agency but not extrinsic instigators can wilfully bring about the occurrence of an event. This is illustrated in (24), which shows that adverbs of control (*accidentally* or

deliberately) are illicit in sentences with event nominals in subject position. *The earthquake* or *the wind* in (23) are only extrinsic instigators incapable of wilful agency. This is why (22) is out. A causative verb affixed with non-active morphology and combined with a dative argument signals that the action denoted by the verb is not under the control of the human causer: Ben in (18b) acted accidentally and/or unintentionally.

- (24) a. *Ben's screaming accidentally/deliberately broke the window.
b. *The ice accidentally/deliberately froze the river.

Non-active causation can thus be identified as *accidental causation*.²¹

In sum, an active causative merely specifies causation, irrespective of whether the resulting event is accidentally or deliberately caused by a human participant or non-accidentally caused by an extrinsic instigator. A non-active causative, on the other hand, only specifies accidental causation. The subject of a non-active causative must be a human participant because only participants capable of wilful agency can act accidentally.²² Recall, however, that Ben in (18b) is not always accidentally breaking the window; he can just suffer from its being (suddenly) broken.

²¹ The term 'accidental causation' is due to Demirdache (1997) who uses it to describe the accidental reading that out-of-control morphology in St'at'imcets yields.

²² One way of distinguishing between deliberate causation and accidental causation is by distinguishing between agentive predications and causatives, as in Davis & Demirdache (1995). This distinction which crucially involves the difference between the notions *agent* and *causer* will be examined in section 7.

4.4. The Distribution of the Stative, the Generic-Potential, the Suddenly and the Accidental Causation Reading

In this section I deal with the question of what generalisation underlies the distribution of the stative, the generic-potential, the suddenly and the accidental reading that obtain with non-active predicates.

4.4.1. Aspectual Properties of the Predicate

Recall that while the stative and the suddenly reading may arise both in sentences with intransitive non-active predicates as well as in sentences with transitive non-active predicates, the accidental causation reading arises only in sentences with transitive non-active predicates; it does not arise in sentences with intransitive non-active predicates.²³ The stative reading arises when non-active morphology attaches to predicates that denote activities. In contrast, the accidental causation reading arises when a dative argument is associated with non-active predicates whose active counterparts denote changes of state/transitions.²⁴ Likewise, the suddenly reading also arises when non-active morphology attaches to predicates that denote transitions, not activities. That is, the inherent aspect of the predicate affixed with non-active

²³ In this section, I abstract away from the generic and/or potential meaning. I explain how this reading relates to the stative reading in section 4.5.2.

²⁴ However, what I called a ‘suddenly’ reading of sentences with transitive non-active predicates can be argued to be a stative reading, too. That is, as was pointed out in footnote (18), Ben in (18b) does not always break the window; he can just suffer from it being (suddenly) broken. If the suddenly reading of sentences with transitive non-active predicates is in fact a stative reading, then the remark that the stative reading arises when a dative argument is associated with non-active predicates whose active counterparts denote activities is neither necessary, nor sufficient. Crucially, however, this does not affect the generalisation in (25).

morphology seems to play some role in determining between the stative, the accidental and the suddenly reading of the construction.

What exactly is the difference between activities and transitions? Activities are open-ended sets of steps (i.e. processes); they are atelic or unbounded events. Transitions, on the other hand, are characterized by an inherent conclusion or point of change; they are telic or bounded events. Hence the following generalisation:

- (25) The accidental causation reading and the suddenly reading obtain in sentences which describe telic or bounded events, they do not obtain in sentences which describe atelic or unbounded events.²⁵

Crucial evidence supporting this generalisation comes from the fact that both the accidental causation reading and the suddenly reading only arise in sentences with perfective aspect; they do not arise in sentences with imperfective aspect, where only the generic-potential and/or a stative reading obtains. This is shown in (26) and (27).

- (26) Ben-it i thy-het dritar-ja.
 Ben-the_{dat} him_{d.cl} break-nact, Imp, 3s window-the_{nom}
 *‘Ben accidentally breaks the window.’
 ‘Ben’s window (*suddenly) breaks.’ (Generic-potential)
 ‘Ben feels like breaking his window.’ (Stative)

²⁵ Demirdache (1997) draws the same generalisation on the distribution of what she terms the ‘ability’ and the ‘accidental’ reading that out-of-control morphology in St’at’imcets yields.

(27) Der-a hap-et.

door-the_{nom} open-nact, Pr, 3s

*‘The door suddenly opens.’

‘The door opens.’ (Generic-potential)

‘The door is openable.’ (Stative)

In the next section, I provide further support for the generalisation in (25) by examining the effect of VP-external operators on the distribution of the stative, the accidental and the suddenly readings that obtain with non-active predicates.

4.4.2. VP-external Operators and the Distribution of the Accidental Reading

The accidental reading arises when a dative argument combines with a non-active predicate whose active counterpart is a telic predicate. Likewise, the suddenly reading arises when non-active morphology attaches to a telic predicate. Both of these readings are however lost when the non-active predicate is embedded under the scope of negation. This state of affairs follows from the generalisation in (25): since the accidental causation reading and the suddenly reading arise in sentences which describe telic events only, they will get lost with negation, because negated sentences do not describe telic events but states, rather (e.g. *Ben didn't sleep* entails that *Ben was awake*). The sentence in (28) asserts that no breaking event occurred at some discourse-determined time. Likewise, the sentence in (29) asserts that no door-opening event took place at some contextually salient time.

(28) Benit nuk i-u thye dritar-ja.

Ben_{dat} not him_{dat.cl}-nactP break_{3s} window-the_{nom}

*‘Ben didn’t break the window accidentally/suddenly.’

‘Ben’s window did not break.’ / ‘Ben’s window is/was not broken.’

‘Ben managed to not break the window.’

(29) Der-a nuk u hap.

door-the_{nom} not nact, P open_{3s}

*‘The door didn’t open suddenly.’

‘The door didn’t open.’

The accidental causation reading and the suddenly reading are also lost in the presence of a VP-external progressive operator.²⁶ In this case, only the stative reading obtains, as (30) and (31) show. The fact that the accidental causation reading and the suddenly reading are lost with the progressive is to be expected given that a sentence with the progressive describes a process, not a telic event.

(30) Ben-it po i thy-het dritar-ja.

Ben-the_{dat} PROG him_{d.cl} break-nact.Pr3s window-the_{nom}

*‘Ben is accidentally/suddenly breaking the window.’

‘Ben’s window is almost broken.’

²⁶ This is perhaps to be expected by the mere fact that the progressive can only occur in imperfective sentences, it cannot occur in perfective sentences. That is, the progressive is incompatible with perfective forms.

- (31) Der-a po hap-et.
 door-the_{nom} PROG open-nact, Pr3s
 *‘The door is suddenly opening.’
 ‘The door is opening.’

The accidental causation reading and the suddenly reading are also lost when a non-active causative occurs in the scope of the adverb of quantification *always*, as shown in (32) and (33). This is not surprising if quantificational sentences are state describing (cf. Kamp & Reyle 1993).

- (32) Ben-it gjithnjë i-u thye-n dritar-et.
 Ben-the_{dat} always him_{d.cl}-nact break-Pr3p windows-the
 *‘Ben always accidentally/suddenly broke the/his windows.’
 ‘Ben’s windows always broke.’ (Generic)

- (33) Dritar-et gjithnjë u thye-n.
 windows-the always nact, P break-3p
 ‘The windows always (*suddenly) broke.’ (Generic)

I will assume in the spirit of Kamp & Reyle that when the universal adverb of quantification *gjithnjë* ‘always’ applies to a stage-level or eventive predicate, it yields an individual level predicate. Thus, (32) and (33) do not describe the occurrence of some event, but a characteristic property of the subject; they are generic statements. An accidental causation and/or a suddenly reading for (32) and a suddenly reading for (33) is therefore unavailable because these sentences are aspectually stative.

Thus, the distribution of the accidental causation reading and the suddenly reading is not determined exclusively by the inherent aspect of the predicate affixed with non-active morphology and endowed with a dative argument, but also by VP-external operators, because aspect is not solely a property of verbs or verb phrases but a property of the entire sentence, determined compositionally by the aspectual structure of the predicate in combination with predicate external operators (cf. Verkuyl (1972), Dowty (1986), Pustejovsky (1991), Smith (1991), Kamp & Reyle (1993) *i.a.*).

4.5. Defining Non-active Morphology

Levin & Rappaport Hovav (1995) distinguish between two types of morphological operations, one which simply alters the argument structure of verbs and/or grammatical relation alignments with arguments, that is, operations which only affect the lexical syntactic representations of verbs, and one which alters lexical meaning with possible effects on the grammatical relation status of arguments, that is, operations which derive new lexical semantic representations. Operations that affect verb meanings (i.e. derive new lexical semantic representations) alter either the aspectual template of a predicate or the pairing of a name (a constant) with an aspectual template.

Adopting a proposal by Demirdache (1997) on out-of-control morphology in St'at'imcets, I will show that the range of readings that non-active morphology renders in Albanian can be derived from the hypothesis that non-active morphology operates on the lexical meaning of a predicate. More precisely, I will define non-active morphology as a morphological operation which operates on event structures, thereby altering either the aspectual template of a predicate or the pairing of a name with an aspectual template, as proposed in Levin & Rappaport Hovav (1995).

4.5.1. The Syntax of Events and Event Composition (Pustejovsky 1991)

The analysis developed here relies on the model of lexical meaning proposed in Pustejovsky (1991, 1995). For Pustejovsky, the aspectual properties of words, and then phrases, are configurationally and compositionally defined in terms of recursive event structures. In particular, he argues that the different event types are not atomic entities but are composed of subeventual structures. He distinguishes three primitive event types whose terminal elements are atomic events: states, processes and transitions. A state *S* is defined as in (34a): it is a single event which is evaluated relative to no other event. A process *P* is defined as in (34b): it is a sequence of identical events identifying the same semantic expression. A transition *T* is defined as in (34c): it is a single event identifying a semantic expression which is evaluated relative to another single event: its opposition. *E* in (34c) is an event variable that ranges over all event types in (34).

(34) Event types

- a. *S* → [e]
- b. *P* → [e₁ ... e_n]
- c. *T* → [E₁ ¬E₁] E = {S, P, T}

In Pustejovsky, every verb in natural language is characterized as belonging to one of the three basic event types. For instance, a stative verb is lexically associated with the event type of a state whereas an activity verb with the event type of a process, as illustrated in (35a,b) respectively. Transitions can be recursive or non-recursive. In particular, a causative predicate is a recursive transition consisting of two subevents:

the causing process **E1** and the resulting change of state **E2**.²⁷ **E2** is itself analysed as a (non-recursive) transition: as an event evaluated relative to its opposition, as illustrated in (35c). The event structure is interpreted as representing both temporal precedence and exhaustive event inclusion.

- (35) (a) *Stative (S)*
e.g. know, believe
- (b) *Process (P)*
e.g. run, work
- (c) *(Recursive) Transition (T)*
e.g. break, wet
- S

|

e

P

△

e₁...e_n

T

├── P

└── T

[e₁...e_n] [¬e e]

For example, a predicate such as *build a house* denotes a transition. It has a process as its first subevent (building at the house) and a state as its final subevent (the house is built). In the case of *build* the transitional event structure is lexically given. In other cases, the complex event type of a transition is constructed compositionally on the basis of the event types of the verb and prepositional elements. For instance, *run* is lexically associated with the event type of a process. However, when it occurs with a directional PP such as *to the store*, which is a function from a process to a transition, the event type of the VP *run to the store* is a transition from a running process to a state of being at the store. This process of composing events on the basis of the primitive event types discussed above is referred to as *event composition*. Event composition derives shifts in the event types of verbs (e.g. while the verb *run* by itself denotes an atelic event, *run to the store* denotes a telic event). The output of event composition must conform to (35).

²⁷ I have chosen to provide the event representation of a causative because this will be relevant for the discussion of the suddenly and the accidental causation reading (cf. section 4.6 and 4.7).

To sum up, aspectual properties of verbs, verb phrases or entire sentences are compositionally derived by morpho-syntactic operations on event structures. Having introduced the event composition procedure, I now turn to the question of how to formally define non-active morphology.

4.5.2. Non-active Morphology and Event Decomposition

In the spirit of Pustejovsky (cf. also van Hout (1996), Demirdache (1997)), I assume that certain morphosyntactic processes operate at the level of event structure. In this perspective, I will analyse aspectual morphemes in Albanian as belonging to the class of event type-shifting devices (particles, prepositions or affixes) discussed by these authors. In the previous section, I showed how complex/recursive events are in a Pustejovskian notation constructed from more primitive events; that is, how event functors apply to given event types to yield higher event types. I will also assume that non-active morphology in Albanian is an event type-shifting device. In this context, I crucially adopt an insight due to Demirdache (1997) in connection with out-of-control morphology in St'at'imcets, namely that certain event functors apply to higher event types to yield lower event types. I assume that non-active morphology in Albanian is such an event functor: non-active morphology does not apply to a given event type to yield a higher event type; it applies to a given event type to yield a lower event type. More concretely, I propose (36), which is a further adaptation of Demirdache's proposal for out-of-control morphology in St'at'imcets:

- (36) When non-active morphology is affixed to a predicate, it shifts the event type associated with the predicate into a lower event type by suppressing the initial subevent in its event structure.

In the following section I show how the stative reading of non-active predicates can be derived from the hypothesis in (36).

4.6. Deriving the Stative Reading

4.6.1 Type-shifting an activity verb into a stative verb

Recall that the stative reading arises when non-active morphology attaches to predicates denoting activities, as in (37).

(37) Më fli-het/ha-het/pi-het.

me_{cl.dat} sleep-nact/eat-nact/drink-nact

‘I feel like sleeping/eating/drinking.’ or: ‘I am sleepy/hungry/thirsty.’

Activity verbs have the event structure of a process (cf. (35b)). Non-active morphology was defined as a type-shifting device that applies to a given event type to yield a lower event type by suppressing its initial subevent. Thus, when non-active morphology applies to a process it will suppress the temporal edge that determines the beginning of the event (**e1** in (35)). But if the temporal edge that determines the beginning of the event is suppressed, the resulting event structure is precisely that of a stative verb. This might at first sight seem incorrect if *n* in (35b) is equated with a number bigger than 2. Note however that a process *P* was defined as a *sequence* of events identifying the same semantic expression. That is, the scheme in (38) whereby

e_n has been replaced by e_2 fully preserves the definition of a process. Therefore, I will assume (38) as the event structure of processes.²⁸

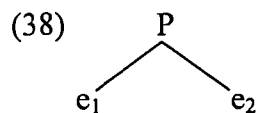

So, activity and stative verbs are alike in that neither the former nor the latter have a well-defined final moment (they both describe atelic or undounded events), but whereas an activity verb has some initial boundary, a stative verb does not denote any kind of change and has therefore no natural boundaries. Distinguishing between states and activities, McClure (1995:36-37) crucially points out: “...every part of a state is identical to every other part, including the entire thing... This is obviously not true for an activity which is composed not of identical points but of discrete steps.” A sentence with an activity verb affixed with non-active morphology does not assert the performance of some activity because non-active morphology suppresses the temporal boundary that determines the beginning of the activity.

The notion of agent is associated with the argument that is linked with the initial subevent in the event structure of an activity verb since the agent is necessarily the initiator of the activity that the verb specifies (cf. Grimshaw (1990), Pustejovsky (1991)). A passive is said to suppress the agent theta-role in the thematic grid of the verb or the external argument position (cf. Grimshaw (1990), Levin & Rappaport Hovav (1995)). I suggest instead that non-active morphology in Albanian, including

²⁸ Note that the definition of processes as given in (38) is not equivalent to the definition of transitions which was given in (34c)/(35c); unlike the two subevents of a process, the two subevents of a transition predicate stand in opposition. That is, (38) does not entail (34c)/(35c).

passive, does not suppress the agent but agenthood by suppressing the subevent in an event structure that is associated with the agent.

In the next section I show how the potential reading of sentences with non-active predicates is related to the stative reading.

4.6.2. Stative Verbs and the Potential(ity) Reading

Recall that all morphologically active predicates (that is, unergatives, transitives and pseudo-unaccusatives) can be affixed with imperfective non-active morphology yielding a generic/habitual and/or potential reading. This was illustrated in the examples in (11), which crucially lack actuality entailments, and is replicated in the sentence in (39) which, likewise, has a generic-potential reading; it does not assert any eating event.

(39) Frut-at e kēsaj peme ha-hen.

fruits-the of this tree eat-nact, Pr3p

‘One can eat the fruits of this tree.’ or: ‘The fruits of this tree are edible.’

As was pointed out in section 3.2, generic sentences are aspectually stative (cf. Kamp & Reyle 1993).²⁹ Moreover, as Chierchia & McConnell-Ginet (1992) point out, one of the main functions of generic sentences appears to be that of expressing capability or possibility. The fact that the sentences in (40a) and (40b) can be paraphrased as in

²⁹ Note that this is so irrespective of the inherent aspect of the predicate. Recall in this context that the generic-potential reading arises whenever a predicate is affixed with non-active morphology and has imperfective aspect form (that is, irrespective of its inherent aspectual properties).

(40a') and (40b'), respectively (examples from Chierchia & McConell-Ginet (1992:234)), illustrates this.

- (40) a. John runs 50 miles without ever stopping.
 a'. John can run 50 miles without ever stopping.
 b. This program parses complicated questions.
 b'. This program can parse complicated questions.

In fact, Vendler (1967) argues that stative verbs in general have an inherent “able-to” (i.e. potentiality) meaning ingredient and uses this inherent able-to meaning as a test for classifying a verb as a stative. Thus, a sentence with an activity verb affixed with non-active morphology can assert the potentiality to perform the action named by the verb because stative verbs have an inherent able-to meaning.

As it happens, the Albanian counterpart of the ability/deontic *can*, namely *mund*, which is aspectually stative, has a non-active form in addition to the active form, as given in (41a). Crucially, this non-active form, unlike the active form, cannot have an epistemic use, as the English translation of (41a) vs. (41b) indicates.³⁰

³⁰ For many speakers, the non-active form *mundem* has a slightly archaic flavour. Diachronic scrutiny notwithstanding, this might suggest that the morphologically active *mund* could have developed from the non-active *mundem*. In fact, since the active *mund* occurs in a petrified form – unlike other verbs it is not inflected for person or number in Albanian, thus behaving very much like an invariable particle – it is feasible to think of the ability/deontic active *mund* as an elliptic form of the non-active *mundem*. In view of the difficulties relating to lack of diachronic studies on *mund/mundem*, these speculations remain untestable. However, the development of other modal verbs in Albanian might be taken as providing indirect evidence in favour of this view. Consider the following sentences:

- (i) Unë du-a të studio-j filozofi.
 I want-act, 1s SUBJ study-act, 1s philosophy
 ‘I want to study philosophy.’
- (ii) Unë du-het të studio-j filozofi.
 I want-nact SUBJ study-act, 1s philosophy
 ‘I must/have to study philosophy.’
- (iii) Më du-het [të studio-j filozofi]/[libr-in].
 me want-nact SUBJ study-act, 1s philosophy/book-the
 ‘I need [to study philosophy]/[the book].’

(41) a. Ben-i mund-et të vrapojë shpejt.

Ben-the can-nact.Pr3s to run fast

‘Ben is able to run fast.’

*‘Perhaps Ben will run fast.’

b. Ben-i mund të vrapojë shpejt.

Ben-the can-act.Pr3s to run fast

‘Perhaps Ben will run fast.’

‘Ben can/is able to run fast.’

I now turn to the derivation of the suddenly reading that non-active morphology in Albanian yields.

4.7. Deriving the Suddenly Reading

Recall that the suddenly reading obtains when non-active morphology attaches to predicates denoting transitions and bearing perfective aspect form. Morphologically active predicates that denote transitions have causative meaning. In order to see how the proposal in (36) derives the suddenly reading, I therefore need to define the event structure of causatives first. Then, I will show how the operation of non-active morphology on the event structure of causatives derives the suddenly reading.

As the sentences in (i-iii) indicate, the Albanian counterparts of the modal verbs *want*, *must* and *need* share the same root and indeed stem. While the difference between the Albanian *want* on one hand and *must* and *need* on the other involves the distinction between active and non-active morphology, the difference between *must* and *need* boils down to case differences assigned to their arguments. Interestingly, what could arguably be considered as replicating part of this pattern is also found in British English where *want* is often used instead of *need*, as shown in (iv):

(iv) The dishes want cleaning.

4.7.1. The Event Structure of Causatives

In outlining the event structure of causatives, I will follow Pustejovsky (1991, 1995). Causatives have the event type of a recursive transition, as shown in (42). The complex event structure in (42) is composed of two subevents: a process P which brings about a resulting change of state T.

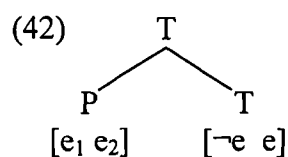

Aspectually, a causative is an accomplishment: the event denoted by the verb is viewed in its entirety. The ‘focus of interpretation’ thus includes the natural endpoints of the event: the causing event P and the resulting event T. Syntactically, a causative projects two arguments. Arguments correspond to participants in an event structure: the participant associated with the first subevent (the process) is the external argument of a predicate whereas the participant associated with the second subevent (the change of state) is the internal argument.

Adopting Pustejovsky’s proposal, I assume that morphologically active causative predicates in Albanian are lexically associated with the event-representation in (43).

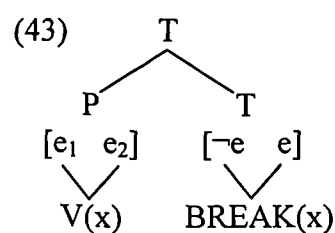

Following Levin & Rappaport Hovav (1995), I have referred to the aspects of the meaning of the predicate that distinguishes it from other predicates with the same

event structure, as the *name* of the predicate and I have used the name of the predicate in capital letters to represent this constant. Thus, BREAK represents the essence of *break*. In (43), both subevents are foregrounded. Hence the predicate is syntactically dyadic; it projects both an external and an internal argument. In (43) the initial subevent P is associated with a contentless name (V – which is a variable ranging over predicates) just to indicate that P is foregrounded. This analysis thus contrasts with theories of verb meanings which postulate a higher predicate DO, ACT or CAUSE into which the notion of ‘agent’ is built (cf. Dowty 1979). The predicate CAUSE can be dispensed with because causation is in the Pustejovskian notation in (43) defined as a structural entailment between the two subevents. DO or ACT should be dispensed with because an active causative predicate does not need (though it may have) a subject which can control the action denoted by the predicate. In this context, recall that only active causative predicates but not non-active causative predicates allow event descriptions in subject position, as was illustrated through the opposition of (23) vs. (22) repeated in (44a) vs. (44b) below.

- (44) a. *Tërmet-it/*er-ës i-u thye dritar-ja.
 earthquake-the_{dat}/wind-the_{dat} it_{d.ci-nact.P} break-3s window-the_{nom}
 ‘The earthquake/the wind accidentally broke the window.’
- b. Tërmet-i/er-a the-u dritaren.
 the earthquake/the windbreak-act.P3s the window
 ‘The earthquake/the wind broke the window.’

In (44b), the change of state (the window becomes broken) is not caused by a subevent of which the earthquake or the wind is an agent: the earthquake/the wind

does not do anything to break the window. The causing event itself is the external argument in (44b). That is, the earthquake in (44b) is a causer, though not an agent. To capture this, I follow Demirdache (1997) in assuming that in an event causative, the lexical content of an event nominal is mapped onto the causing subevent P. Such mapping is possible because the name associated with P in (43) is just a contentless variable (a placeholder). The event causatives in (44) have the event representations in (45a) and (45b) where a process (the earthquake or the wind, respectively) causes the window to become broken.

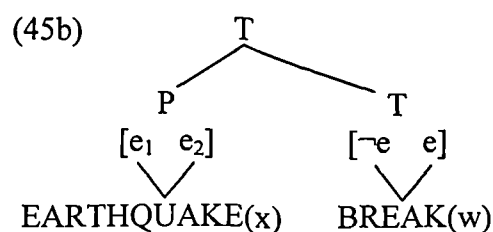
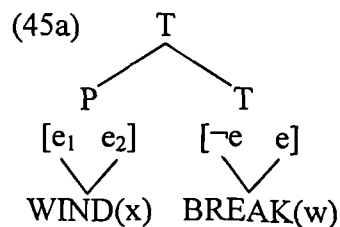

4.7.2. Decomposing Causatives

A causative predicate affixed with non-active morphology has the event-representation given in (46). This is so because non-active morphology was defined as an operation that suppresses the initial subevent in an event structure. The initial subevent in (46) is P; hence P is not foregrounded. Since every subevent is associated with one argument, then there will only be one (internal) argument projected.

participant. In this section, I propose that this is so because non-active causatives are derived from agentive predicates, not from (active) causative predicates.³¹

What are agentive predicates and what is their structure? In answering this question I rely on Davis & Demirdache's (1995) analysis of agentive predications. The basic idea in their analysis is given in the following quote:

“[...] The participant identifying E1 is *a causal agent iff there is an intrinsic relation between the causing event and the resulting event* – that is, if the resulting (change of) state *be(come) V* is caused by a process of *V-ing*.

[...] In contrast, the participant identifying E1 is a causer (but not an agent) when there is no intrinsic relation between the causing event and the resulting (change) of state.” (Demirdache 1997: 130.)

To illustrate, according to Davis & Demirdache, Rosa in (47) is an agent iff:

“Rosa performs some action of melting which causes the ice to be melted. In contrast, Rosa is a causer (but not an agent) when there is no intrinsic relation between the causing event and the resulting change of state—e.g. Rosa accidentally turns off the refrigerator and the ice melts.” (Demirdache 1997:129.)

(47) Rosa melted the ice. (Demirdache 1997:129)

To ensure that the resulting change of state become melted is caused by a process of melting, Davis & Demirdache map the name MELT associated with the final subevent T onto the initial subevent P in (48a) yielding the event structure in (48b).³² This operation on event structure is called “Predicate Cloning” and, further scrutiny notwithstanding, seems to yield the same results as Hale & Keyser's (1993) syntactic

³¹ Cf. Davis & Demirdache (1995) who argue that the agentive and the causative reading of a given predicate are universally projected from distinct event frames.

³² This commits one to the idea that the intransitive version of the verbs that enter in the so-called causative alternation is primitive and the transitive version is derived.

incorporation of a lower verb (constant) into a higher light verb or Chomsky's (1995) V into v.

(48a) Event structure of intransitive 'melt'

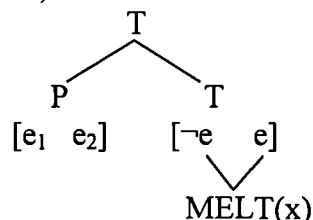

(48b) Event structure of agentive 'melt'

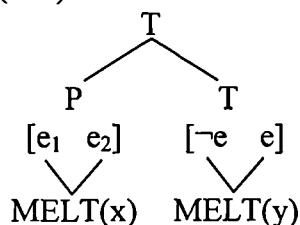

Both subevents in an agentive causative are associated with the name MELT. Therefore both subevents in (48b) are foregrounded and the predicate *melt* projects both an external and an internal argument in the syntax.

Let me now sketch how non-active causatives are derived from agentive causatives. An agentive causative has the event representation in (48b). Non-active causative predicates could not be derived by suppression of P in (48b); this would only yield the intransitive *melt*. How do we then derive a non-active causative/transitive? Levin & Rappaport Hovav (1995) propose that morphological processes which operate on the lexical representation of verb meanings either alter the aspectual template associated with a predicate or the pairing of a name (a constant) with an aspectual template. I adopt this proposal for non-active morphology which I redefine as in (49):

- (49) When non-active morphology is affixed to a predicate, it suppresses either the initial subevent in its event structure or the name that is associated with this initial subevent.

In particular I suggest that the non-active causative is derived from the agentive causative in the way depicted in (50).

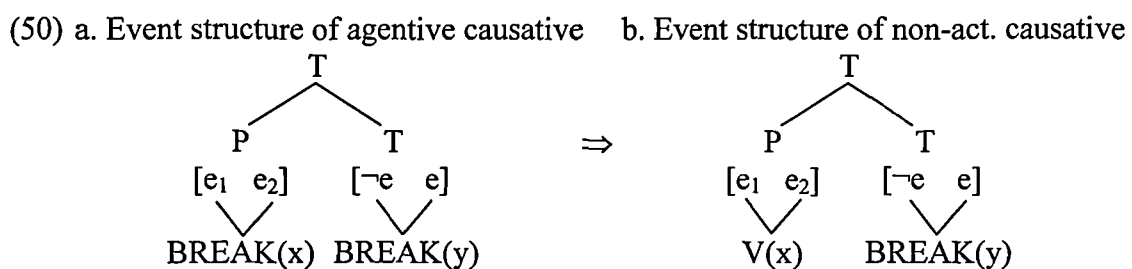

As shown in (50), both the input and the output of non-active morphology is a dyadic predicate. Note that the event representation of a non-active causative is identical to the event representation of a non-agentive active causative (cf. (43)).

The fact that the subject of a non-active causative must be a participant that is capable of wilful agency (i.e. [+human]) supports the hypothesis that non-active causatives are derived from agentive causatives. However, non-active morphology suppresses the control that this human agent has over the action named by the verb because when non-active morphology suppresses the name associated with the initial subevent in (50b), it concurrently suppresses agenthood (cf. Davis & Demirdache (1995), Demirdache (1997)).

4.9. Conclusion

In this chapter, I have shown that a range of readings that the non-active morphology in Albanian yields can be derived under the proposal that non-active morphology operates on the lexical semantic frames of verbs, not on their lexical syntactic frames. Non-active morphology suppresses agenthood by suppressing either the subevent that is associated with the notion of agent or the name that is associated with this subevent. Whether the generalisations drawn for Albanian non-active morphology (which subsumes passive) are universal properties of the passive construction remains, however, an open question. Their validity may be overridden by other language-specific morphological operations whose properties in morphologically opaque languages are yet to be disclosed.

References

- Abney, S. (1987) *The English Noun Phrase in its Sentential Aspect*. Doctoral Dissertation, Massachusetts Institute of Technology, Cambridge, MA.
- Áfarli, T. (1994) A promotion analysis of restrictive relative clauses. *The Linguistic Review* 11: 81-100.
- Agouraki, Y. (1993) *Spec-Head Licensing: The Scope of the Theory*. Doctoral Dissertation, University College London, London.
- Akmajian, A. (1970) *Aspects of the Grammar of Focus in English*. Doctoral Dissertation, Massachusetts Institute of Technology, Cambridge, MA.
- Alexiadou, A. and E. Anagnostopoulou (1997) Asymmetries in the Distribution of Clitics: The Case of Greek Restrictive Relatives. Manuscript, Zentrum für Allgemeine Sprachwissenschaft, Berlin and Massachusetts Institute of Technology, Cambridge, MA.
- Anagnostopoulou, E. (1994) On the representation of clitic doubling in Modern Greek. *EUROTYP Working Papers, Theme Group 8*, 5:1-66.
- Anderson, S. (1996) How to put your clitics in their place, or why the best account of second-position phenomena may be something like the optimal one. *The Linguistic Review* 13: 165-191.
- Androutsopoulou, A. (1997) Adjectival Determiners in Albanian and Greek. Manuscript, University of California, Los Angeles.
- Belletti, A. (1988) The case of unaccusatives. *Linguistic Inquiry* 19: 1-34.
- Bittner, M. (1994) *Case, Scope and Binding*. Dordrecht: Kluwer.
- Borer, H. (1984) *Parametric Syntax: Case Studies in Semitic and Romance Languages*. Dordrecht: Foris.
- Borthen, K. (1999) *Bare Singulars in Norwegian*. Cand. Philol. Thesis. University of Trondheim Working Papers in Linguistics 32.
- Brody, M. (1990) Some remarks on the focus field in Hungarian. *UCL Working Papers in Linguistics* 2: 201-225.
- Burzio, L. (1986) *Italian Syntax: A Government-Binding Approach*. Dordrecht: Reidel.
- Börjars, K. (1994) *Feature Distribution in Swedish Noun Phrases*. Doctoral Dissertation, University of Manchester.
- Carlson, G. (1977) *Reference to Kinds in English*. Doctoral Dissertation, University of Massachusetts, Amherst.
- Chastain, C. (1975) Reference and context. In K. Gunderson (ed.) *Minnesota Studies in the Philosophy of Science*, vol. VII. - *Language, Mind and Knowledge* 194-269. Minneapolis: University of Minnesota Press.

- Chierchia, G. (1985) Formal semantics and the grammar of predication. *Linguistic Inquiry* 16: 417-443.
- Chierchia, G. and S. McConnell-Ginet (1992) *Meaning and Grammar*. Cambridge, MA: MIT Press.
- Chomsky, N. (1972) Deep structure, surface structure and semantic interpretation. In *Studies on Semantics in Generative Grammar*. The Hague: Mouton.
- Chomsky, N. (1973) Conditions on transformations. In S. R. Anderson and P. Kiparsky (eds.) *A Festschrift for Morris Halle*. New York: Holt, Rinehart, and Winston.
- Chomsky, N. (1976) Conditions on rules of grammar. *Linguistic Analysis* 2.4: 303-351.
- Chomsky, N. (1977) On wh-movement. In P. Culicover, T. Wasow and A. Akmajian (eds.) *Formal Syntax*. New York: Academic Press.
- Chomsky, N. (1981) *Lectures on Government and Binding*. Dordrecht: Foris.
- Chomsky, N. (1982) *Some Concepts and Consequences of the Theory of Government and Binding*. Cambridge, MA: MIT Press.
- Chomsky, N. (1986) *Knowledge of Language*. New York: Praeger.
- Chomsky, N. (1995) *The Minimalist Program*. Cambridge, MA: MIT Press.
- Cinque, G. (1990) *Types of A'-Dependencies*. Cambridge, MA: MIT Press.
- Cinque, G. (1993) A null theory of phrase and compound stress. *Linguistic Inquiry* 24: 239-297.
- Cohen, A. and N. Erteschik-Shir (1997) Topic, Focus and the Interpretation of Bare Plurals. Paper presented at the Eleventh Amsterdam Colloquium, Amsterdam, December.
- Davis, H. (1997) Deep unaccusativity and zero syntax in St'at'imcets. In A. Mendikoetxea and M. Uribe-Extebarria (eds.) *Theoretical Issues on the Morphology Syntax Interface: Supplements of the International Journal of Basque Linguistics and Philology (ASJU)* Vol XXVIII. Donostia, Spain.
- Davis, H. and H. Demirdache (1995) Agents and Events. Paper presented at the GLOW Colloquium, University of Tromsø, Norway.
- Delfitto, D. and J. Schrotten (1991) Bare plurals and the number affix in DP. *Probus* 3: 155-185.
- Delsing, L.-O. (1993) *The Internal Structure of Noun Phrases in the Scandinavian Languages*. Doctoral Dissertation, University of Lund.
- Demiraj, S. (1986) *Gramatika Historike e Gjuhës Shqipe*. Tiranë: Shtëpia Botuese "8 Nëntori".
- Demirdache, H. (1997) Out of control in St'at'imcets Salish and event (de) Composition. In A. Mendikoetxea & M. Uribe-Extebarria (eds.) *Theoretical Issues on the Morphology Syntax Interface: Supplements of the International Journal of Basque Linguistics and Philology (ASJU)* Vol XXVIII. Donostia, Spain.
- Diesing, M. (1992) *Indefinites*. Cambridge, MA: MIT Press.

- den Dikken, M. (1995) *Particles: On the Syntax of Verb-Particle, Triadic and Causative Constructions*. Oxford/New York: Oxford University Press.
- Dimitrova-Vulchanova, M. and G. Giusti (1997) Fragments of Balkan Nominal Structure. Manuscript, Norwegian University of Science and Technology, Trondheim and University of Venice.
- Dobrovie-Sorin, C. (1990) Clitic doubling, wh-movement and quantification in Romanian. *Linguistic Inquiry* 21: 351-398.
- Dobrovie-Sorin, C. and Laca, B. (1996) Generic Bare NPs. Manuscript, Université de Paris and Université de Strasbourg.
- Donellan, K. (1966) Reference and definite descriptions. *The Philosophical Review* 75: 281-304.
- Dowty, D. (1979) *Word Meaning and Montague Grammar*. Dordrecht: Reidel.
- Dowty, D. (1986) The effects of aspectual class on the temporal structure of discourse, pragmatics or semantics. *Linguistics and Philosophy* 9.
- Emonds, J. (1970) *Root and Structure Preserving Transformations*. Bloomington: Indiana University Linguistics Club.
- Emonds, J. (1976) *A Transformational Approach to English Syntax*. New York: Academic Press.
- Emonds, J. (in press) How clitics license null phrases: a theory of the lexical interface. In H. van Riemsdijk (ed.) *Clitics in the Languages of Europe*. Berlin: Mouton de Gruyter.
- Enç, M. (1991) The semantics of specificity. *Linguistic Inquiry* 22:1-25.
- Erteschik-Shir, N. (1998) *The Dynamics of Focus Structure*. Cambridge: Cambridge University Press.
- Faarlund, J.T. (1977) Embedded clause reduction and Scandinavian gender agreement. *Journal of Linguistics* 13: 239-257.
- Farkas, D. (1985) *Intensional Descriptions and the Romance Subjunctive Mood*. New York: Garland.
- Fodor, J. and Sag, I. (1982) Referential and quantificational indefinites. *Linguistics and Philosophy* 5: 355-394.
- Frege, G. (1891) Function and concept. In M. Black and P. Geach (eds.) *Translations from the Philosophical Writings of Gottlob Frege*. Oxford: Blackwell.
- Frege, G. (1923-6) Logische Untersuchungen. Dritter Teil: Gedankengefüge. *Beiträge zur Philosophie des Deutschen Idealismus* 3.
- Friedman, M.-A. (1997) *Sujets Syntaxiques: Positions, Inversions et pro*. Bern: Peter Lang.
- van Geenhoven, V. (1996) *Semantic Incorporation and Indefinite Descriptions: Semantic and Syntactic Aspects of Noun Incorporation in West Greenlandic*. Doctoral Dissertation, University of Tübingen.
- Giusti, G. (1993) *La Sintassi dei Determinanti*. Padova: Unipress.
- Grimshaw, J. (1990) *Argument Structure*. Cambridge, MA: MIT Press.

- Haiden, M. (1996) The aspect of short scrambling. *Wiener Linguistische Gazette* 57:121-145.
- Hale, K. and S.J. Keyser (1993) On argument structure and the lexical expression of syntactic relations. In K. Hale and S.J. Keyser (eds.) *The View from Building 20: Essays in Linguistics in Honor of Sylvan Bromberger*. Cambridge, MA: MIT Press. 53-109.
- Heim, I. (1982) *The Semantics of Definite and Indefinite Noun Phrases*. Doctoral Dissertation, University of Massachusetts, Amherst.
- Heim, I. and A. Kratzer (1998) *Semantics in Generative Grammar*. Oxford: Blackwell.
- Hellan, L. (1986) The headedness of NPs in Norwegian. In P. Muysken & H. van Riemsdijk (eds.) *Features and Projections*. Dordrecht: Foris. 89-122.
- Hellan, L. (1988) *Anaphora in Norwegian and the Theory of Grammar*. Dordrecht: Foris.
- Higginbotham, J. (1987) Indefiniteness and predication. In E.J. Reuland and A.G.B. ter Meulen (eds.) *The Representation of (In)definiteness*. Cambridge, MA: MIT Press. 41-70.
- Higgins, R. F. (1979) *The Pseudocleft Construction in English*. New York: Garland.
- de Hoop, H. (1992) *Case Configuration and Noun Phrase Interpretation*. Groningen Dissertations in Linguistics.
- de Hoop, H. (1997) Optional scrambling and predication. In R. Blight and M. Moosally (eds.) *Proceedings of the 1997 Texas Linguistics Society Conference "The Syntax and Semantics of Predication"*. Texas Linguistic Forum 38: 135-148.
- Horvath, J. (1986) *FOCUS in the Theory of Grammar and the Syntax of Hungarian*. Dordrecht: Foris.
- van Hout, A. (1996) *Event Semantics of Verb Frame Alternations: A Case Study of Dutch and its Acquisition*. TILDIL Dissertation Series, Katholieke Universiteit Brabant, Tilburg.
- Ioup, G. (1977) Specificity and the interpretation of quantifiers. *Linguistics and Philosophy* 1: 233-245.
- Jackendoff, R. (1972) *Semantic Interpretation in Generative Grammar*. Cambridge, MA: MIT Press.
- Jackendoff, R. (1990) *Semantic Structures*. Cambridge, MA: MIT Press.
- Jacobs, J. (1986) The syntax of focus and adverbials in German. In W. Abraham and S. de Meij (eds.) *Topic, Focus and Configurationality*. Amsterdam: John Benjamins. 103-127.
- Jaeggli, O. (1986) Three issues in the theory of clitics. In H. Borer (ed.) *Syntax and Semantics* 19: 15-42.
- Jenkins, L. (1972) *Modality in English Syntax*. Doctoral Dissertation, Massachusetts Institute of Technology, Cambridge, MA.
- Joseph, B. and I. Philippaki-Warbuton (1987) *Modern Greek*. London: Croom Helm.

- Kallulli, D. (1995) *Clitics in Albanian*. Cand. Philol. Thesis. University of Trondheim Working Papers in Linguistics 24.
- Kallulli, D. (1997) Optional verb movement: Albanian imperatives. In B. Bruening (ed.) *Proceedings of SCIL 8*. MIT Working Papers in Linguistics 31: 225-235.
- Kamp, H. and U. Reyle (1993) *From Discourse to Logic. Part 2*. Dordrecht: Kluwer.
- Katz, J. and P. Postal (1964) *An Integrated Theory of Linguistic Descriptions*. Cambridge, MA: MIT Press.
- Kayne, R. (1984) *Connectedness and Binary Branching*. Dordrecht: Foris.
- Kayne, R. (1994) *The Antisymmetry of Syntax*. Cambridge, MA: MIT Press.
- Kazazis, K. and J. Pentheroudakis (1976) Reduplication of indefinite direct objects in Albanian and Modern Greek. *Language* 52: 398-403.
- Kiparsky, P. and C. Kiparsky (1970) Fact. In M. Bierwisch and K. Heidolph (eds.) *Progress in Linguistics*. The Hague: Mouton. 345-369.
- Kiss, K. É. (1996) On generic and existential bare plurals and the classification of predicates. Manuscript, Hungarian Academy of Sciences.
- Koster, J. and R. May (1982) On the constituency of infinitives. *Language* 58: 116-143.
- Kratzer, A. (1995) Stage-level and individual-level predicates. In G. Carlson and F.J. Pelletier (eds.) (1995) *The Generic Book*. Chicago: University of Chicago Press. 176-223.
- Krifka, M. (1990) Four thousand ships passed through the lock: object-induced measure functions on events. *Linguistics and Philosophy* 13: 487-520.
- Krifka, M. (1996) Frameworks for the Representation of Focus. Manuscript, University of Texas at Austin.
- Krifka, M., F. J. Pelletier, G. Carlson, A. ter Meulen, G. Link and G. Chierchia (1995) Genericity, an introduction. In G. Carlson and F.J. Pelletier (eds.) (1995) *The Generic Book*. Chicago: University of Chicago Press. 1-124.
- Kuroda, S.-Y. (1969) English relativization and certain related problems. In D. Reibel and S. Schane (eds.) *Modern Studies in English*. Englewood Cliffs, N.J.: Prentice Hall. 264-287.
- Laca, B. (1990) Generic objects: some more pieces of the puzzle. *Lingua* 81: 25-46.
- Larson, R. (1988) On the double object construction. *Linguistic Inquiry* 19: 335-391.
- Levin, B. and M. Rappaport Hovav (1995) *Unaccusativity: At the Syntax-Lexical Semantics Interface*. Cambridge, MA: MIT Press.
- Longobardi, G. (1994) Reference and proper names: a theory of N-movement in syntax and logical form. *Linguistic Inquiry* 25: 609-665.
- Marantz, A. (1984) *On the Nature of Grammatical Relations*. Cambridge, MA: MIT Press.
- Marantz, A. (1990) Implications of asymmetries in double object constructions. Manuscript, University of North Carolina, Chapel Hill.

- Massey, V. M. (1991) *Compositionality and Constituency in Albanian*. Doctoral Dissertation, University of North Carolina, Chapel Hill.
- May, R. (1985) *Logical Form*. Cambridge, MA: MIT Press.
- McClure, W. (1995) *Syntactic Projections of the Semantics of Aspect*. Tokyo: Hituzi Syobo.
- Milsark, G. (1974) *Existential Sentences in English*. Doctoral Dissertation, Massachusetts Institute of Technology, Cambridge, MA.
- Milsark, G. (1977) Toward an explanation of certain peculiarities of the existential construction in English. *Linguistic Analysis* 3:1-31.
- Montague, R. (1974) *Formal Philosophy: Collected Papers of Richard Montague, Edited and with an Introduction by Richmond H. Thomason*. New Haven: Yale University Press.
- Partee, B. H. (1972) Opacity, coreference, and pronouns. In D. Davidson and G. Harman (eds.) *Semantics of Natural Language*. Dordrecht: Reidel. 415-441.
- Partee, B. H. (1987) Noun phrase interpretation and type shifting principles. In J. Groenendijk, D. de Jongh and M. Stockhof (eds.) *Studies in Discourse Representational Theory and the Theory of Generalized Quantifiers*. Dordrecht: Foris. 115-143.
- Perlmutter, D. (1978) Impersonal passives and the unaccusative hypothesis. *Proceedings of the Fourth Annual Meeting of the Berkeley Linguistics Society* 157-89. Berkeley Linguistics Society, University of California, Berkeley.
- Pesetsky, D. (1987) *Wh-in-situ: movement and unselective binding*. In E.J. Reuland and A.G.B. ter Meulen (eds.) *The Representation of (In)definiteness*. Cambridge, MA: MIT Press. 98-129.
- Platzack, C. (1987) The Scandinavian languages and the null-subject parameter. *Natural Language and Linguistic Theory* 5: 377-402.
- Postal, P. (1969) On so-called "pronouns" in English. In D. A. Reibel and S. A. Schane (eds.) *Modern Studies in English: Readings in Transformational Grammar*. Englewood Cliffs, N.J.: Prentice Hall. 201-224.
- Prinzhorn, M. (1995) Scrambling Positions and DP Structure. Manuscript, University of Vienna.
- Pustejovsky, J. (1991) The syntax of event structure. *Cognition* 41: 47-81.
- Pustejovsky, J. (1995) *The Generative Lexicon*. Cambridge, MA: MIT Press.
- Quine, W.O. (1960) *Word and Object*. Cambridge, MA: MIT Press.
- Rapoport, T. (1987) *Copular, Nominal and Small Clauses: A Study of Israeli Hebrew*. Doctoral Dissertation, Massachusetts Institute of Technology.
- Rapoport, T. (1995) Specificity, objects, and nominal small clauses. In A. Cardinaletti and M. T. Guasti (eds.) *Syntax and Semantics* 28: 153-177.
- Raposo, E. (1997) Postal's Theory Meets the Minimalist Program: Some Observations on the Pronominal System of Portuguese. Paper presented at ConSOLE 6, Lisbon.

- Reinhart, T. (1982) *Pragmatics and Linguistics: An Analysis of Sentence Topics*. Bloomington: Indiana University Linguistics Club.
- Reinhart, T. (1995) Interface Strategies. Manuscript, OTS, Utrecht.
- Reinhart, T. (1996) Interface Economy: Focus and Markedness. Manuscript, OTS, Utrecht.
- Reinhart, T. and E.J. Reuland (1993) Reflexivity. *Linguistic Inquiry* 24: 657-720.
- Rivero, M.-L. (1994) Clause structure and V-movement in the languages of the Balkans. *Natural Language and Linguistic Theory* 12: 63-120.
- Rivero, M.-L. and A. Terzi (1994) Imperatives, Illocutionary Force, and V-movement. Manuscript, University of Ottawa.
- Rizzi, L. (1991) Residual verb second and the wh-criterion. *Technical Reports in Formal and Computational Linguistics 2*. University of Geneva.
- Rochemont, M. (1986) *Focus in Generative Grammar*. Amsterdam: Benjamins.
- Rooth, M. (1996) Focus. In S. Lappin (ed.) *The Handbook of Contemporary Semantic Theory* 271-297. Oxford and Cambridge, MA: Blackwell.
- Ross, J. R. (1967) *Constraints on Variables in Syntax*. Doctoral Dissertation, Massachusetts Institute of Technology, Cambridge, MA.
- Roussou, A. (1999) Complementation in Modern Greek. Lectures held at the University of Vienna, January.
- Rouveret, A. and J.-R. Vergnaud (1980) Specifying reference to the subject: French causatives and conditions on representations. *Linguistic Inquiry* 11: 97-202.
- Russell, B. (1905) On denoting. *Mind* 14: 479-493.
- Safir, K. (1987) What explains the definiteness effect? In E.J. Reuland and A.G.B. ter Meulen (eds.) *The Representation of (In)definiteness*. Cambridge, MA: MIT Press. 71-97.
- Schachter, P. (1973) Focus and relativization. *Language* 49: 19-46.
- Smith, C. (1991) *The Parameter of Aspect*. Dordrecht: Kluwer.
- Sperber, D. and D. Wilson (1988) *Relevance: Communication and Cognition*. Oxford: Blackwell.
- Sportiche, D. (1992) Clitic Constructions. Manuscript, University of California, Los Angeles.
- Stavrou, M. (1984) Ἡ κλιτική αντωνυμία στις περιοριστικές αναφορικές προτάσεις με εξάρτηση αμέσου αντικείμενου που εισαγονται με το “που”. *Μελέτες για την Ελληνική Γλώσσα*. 121-136.
- Sternefeld, W. (1990) Scrambling and minimality. In: G. Grewendorf (ed.) *Scrambling and Barriers*. Amsterdam: John Benjamins. 239-257.
- Stowell, T. (1989) Subjects, specifiers, and X-bar theory. In M. Baltin and A. Kroch (eds.) *Alternative Conceptions of Phrase Structure*. Chicago: University of Chicago Press. 232-262.

- Stowell, T. (1991) Determiners in NP and DP. In K. Leffel and D. Bouchard (eds.) *Views on Phrase Structure*. Dordrecht: Kluwer. 37-56.
- Strawson, P. (1971) *Logico-Linguistic Papers*. London: Methuen & Co Ltd.
- Suñer, M. (1988) The role of agreement in clitic-doubled constructions. *Natural Language and Linguistic Theory* 6: 391-434.
- Terzi, A. (1992) *PRO in Finite Clauses: A Study of the Inflectional Heads of the Balkan Languages*. Doctoral Dissertation, City University of New York.
- Travis, L. (1984) *Parameters and Effects of Word Order Variation*. Doctoral Dissertation, Massachusetts Institute of Technology, Cambridge, MA.
- Uriagareka, J. (1995) Aspects of the syntax of clitic placement in Western Romance. *Linguistic Inquiry* 26: 79-123.
- Vallduví, E. (1994) Detachment in Catalan and information packaging. *Journal of Pragmatics* 22: 573-601.
- Vendler, Z. (1967) *Linguistics and Philosophy*. Ithaca: Cornell University Press
- Vergnaud, J.-R. (1974) *French Relative Clauses*. Doctoral Dissertation, Massachusetts Institute of Technology, Cambridge, MA.
- Vergnaud, J.-R. and M. L. Zubizarreta (1992) The definite determiner and the inalienable construction in French and English. *Linguistic Inquiry* 23: 595-652.
- Verkuyl, H. (1972) *On the Compositional Nature of the Aspects*. Dordrecht: Reidel.
- Webelhuth, G. (1989) *Syntactic Saturation Phenomena and the Modern Germanic Languages*. Doctoral Dissertation, University of Massachusetts, Amherst.
- Williams, E. (1980) Predication. *Linguistic Inquiry* 11: 203-238.
- Wittgenstein, L. (1922) *Tractatus Logico-Philosophicus*. New York & London.
- Zamparelli, R. (1996) *Layers in the Determiner Phrase*. Doctoral Dissertation, University of Rochester, New York.
- Zimmermann, E. (1993) On the proper treatment of opacity in certain verbs. *Natural Language Semantics* 1: 149-179.
- Zwicky, A. (1977) *On Clitics*. Bloomington: Indiana University Linguistics Club.

