

# An Analysis of Distributed Solar Fuel Systems

by

**Alex Thomas**

Post Graduate Diploma in Information Technology  
Indian Institute of Information Technology Bangalore, 2000

B.Arch., Mumbai University, 1998

Submitted to the System Design and Management Program  
in Partial Fulfillment of the Requirements for the Degree of

**Master of Science in Engineering and Management**

at the

Massachusetts Institute of Technology

June 2012

© 2012 Alex Thomas  
All rights reserved

The author hereby grants to MIT permission to reproduce and to distribute publicly paper and electronic copies of this thesis document in whole or in part in any medium now known or hereafter created.

Signature of author: \_\_\_\_\_

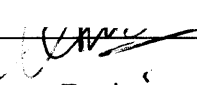
  
Alex Thomas  
System Design and Management  
May 11, 2012

Certified and Accepted by: \_\_\_\_\_

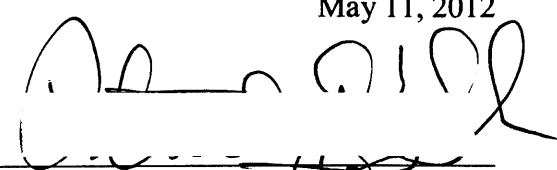
  
Patrick Hale  
Thesis Supervisor  
Director, System Design and Management Program

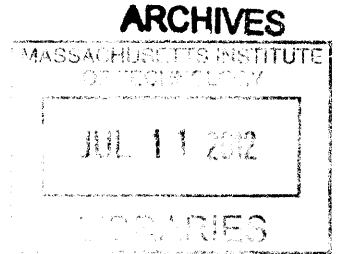

(THIS PAGE IS INTENTIONALLY LEFT BLANK)

## ACKNOWLEDGEMENTS

This thesis couldn't have been undertaken without the unwavering support and guidance of a number of people. I would like to express my heartfelt gratitude to each one of them.

To Daniel Nocera for his inspiring work on artificial photosynthesis at the Department of Chemistry at MIT and for patiently introducing me to his research on solar fuel systems that motivated this thesis.

To Prof. John Deutch for his invaluable advice in structuring the analysis on distributed hydrogen systems that forms the bulk of this thesis and for providing valuable feedback on the analysis.

To Tom Jarvi and team at Sun Catalytix for taking time out from their hectic lives in a clean energy start-up and providing invaluable insights into the technology and business of solar fuel systems.

To Pat Hale for his warm and gentle mentoring throughout the SDM program, and for supervising the writing of this thesis.

To the faculty, staff and cohort at the System Design and Management program at MIT for the wonderful memories – I'm certain they'll last a lifetime!

To my immediate family back home - Daddu, Mummy, Amma, Appa, Matty, Minu, Sumy, Jerry, Vinay, Anna, Thomman and Suhana - for their large-heartedness, and many small favors behind the scenes, that allowed me to focus on my studies.

Last but not the least, I would like to dedicate this thesis to my son Adith and wife Vidya, whose unconditional love, words of encouragement and numerous sacrifices made my ambition of coming to MIT possible.

# **ABSTRACT**

## **An Analysis of Distributed Solar Fuel Systems**

by

**Alex Thomas**

Submitted to the System Design and Management Program  
on 22<sup>nd</sup> May, 2012 in partial fulfillment of the  
requirements for the degree of  
Master of Science in Engineering and Management  
Massachusetts Institute of Technology, 2012

While solar fuel systems offer tremendous potential to address global clean energy needs, most existing analyses have focused on the feasibility of large centralized systems and applications. Not much research exists on the feasibility of distributed solar fuel systems. This thesis is an attempt to understand the larger context of solar fuel systems, to examine the case for going distributed and to critically analyze a distributed solar fuel system available today in the context of a specific application.

In doing so, this thesis seeks to a) provide a baseline analysis for the economic feasibility of a distributed solar fuel system based on state-of-the-art technology b) draw some general conclusions about the nature of such systems in order to provide guidance to those engaged in the development of the next generation of solar fuel systems. This study also compares the chosen baseline solar fuel system with a traditional fossil fuel-based alternative and undertakes a cost-to-emissions trade-off analysis.

A key finding of this thesis is that for solar fuel systems to be viable, cost and efficiency improvements in individual sub-systems won't be sufficient. Due attention needs to be given to bring down cost of the entire system. Another key finding is that if carbon emissions are considered as a decision-making criterion in addition to cost, even at current cost levels photovoltaic hydrogen systems compare favorably with existing fossil fuel-based alternatives such as diesel generators.

Thesis Supervisor: Pat Hale

Title: Director, System Design and Management Program, MIT

# TABLE OF CONTENTS

<b>ACKNOWLEDGEMENTS.....</b>	<b>III</b>
<b>ABSTRACT.....</b>	<b>IV</b>
<b>TABLE OF CONTENTS.....</b>	<b>V</b>
List of Tables .....	viii
List of Figures .....	ix
<b>1. INTRODUCTION.....</b>	<b>11</b>
<b>2. MOTIVATION AND HYPOTHESIS.....</b>	<b>13</b>
2.1 How Much Energy Do We Need? .....	13
2.2 How is Energy Consumed Today? .....	13
2.3 Does the World Have Enough Energy Sources? .....	14
2.4 Is the Current Pattern of Energy Consumption Sustainable?.....	14
2.5 Can Renewable Sources of Energy Meet the Projected Demand? .....	16
2.6 The Case for Solar Fuels.....	18
2.7 The Case for Distributed Energy Systems .....	21
2.7.1 Developed Countries Can “Chip Away” at the Problem .....	21
2.7.2 Developing Countries Can Leap Frog to Better Technologies Faster .....	21
2.7.3 Distributed Energy Systems are More Profitable .....	21
2.8 Hypotheses .....	23
<b>3. SOLAR HYDROGEN PATHWAYS .....</b>	<b>25</b>
3.1 Indirect Solar Hydrogen Pathways .....	26
3.1.1 Biomass Conversion .....	26
3.1.2 Photovoltaic Electrolysis .....	26
3.1.3 Themolytic Electrolysis .....	28

3.2	Direct Solar Hydrogen Pathways.....	29
3.2.1	Thermochemical Cycles.....	29
3.2.2	Photolysis.....	30
3.3	Semi-Direct Solar Hydrogen Pathways .....	31
3.3.1	Photo-biological Pathways.....	31
<b>4.</b>	<b>MARKETS FOR DISTRIBUTED SOLAR HYDROGEN SYSTEMS.....</b>	<b>34</b>
4.1	Key Transition Markets in U.S for Fuel Cells .....	35
4.1.1	Backup Power for Telecommunications.....	37
4.1.2	Backup Power for Emergency Response Communications.....	38
4.1.3	Specialty Vehicles – Forklifts in Distribution Centers .....	39
4.1.4	Ground Support Equipment (GSE) in Airports .....	39
4.1.5	Ability of Distributed Solar Fuel Systems to Meet Application Needs.....	40
<b>5.</b>	<b>ECONOMIC ANALYSIS OF HYDROGEN PRODUCTION VIA DISTRIBUTED PHOTOVOLTAIC ELECTROLYSIS SYSTEMS.....</b>	<b>43</b>
5.1	Motivation and Methodology for Economic Analysis.....	43
5.2	Telecommunication Backup System Needs and Assumptions.....	45
5.3	System Assumptions.....	47
5.4	Scenarios being compared .....	48
5.5	Model Inputs and Assumptions .....	48
5.6	Analysis of Model Results .....	52
5.6.1	Overall LCOE Trends .....	52
5.6.2	LCOE Breakup Analysis.....	53
5.6.3	Sensitivity Analysis .....	57

<b>6</b>	<b>COMPARISONS WITH A FOSSIL FUEL-BASED SYSTEM .....</b>	<b>61</b>
6.1	Locations Chosen for Comparison.....	61
6.2	Research Questions.....	62
6.3	Boundary Conditions .....	63
	6.3.1 Scope of Analysis .....	63
	6.3.2 Technology Assumptions.....	64
6.4	Methodology.....	65
	6.4.1 Metrics Used .....	66
	6.4.2 Optimization Problem Formulation .....	66
6.5	Results.....	67
	6.5.1 Individual Technologies - LCOE Results .....	67
	6.5.2 Individual Technologies - LCA Results .....	68
	6.5.3 Individual Technologies - Weighted Sum Results.....	69
	6.5.4 Results Comparing Combinations of Technologies .....	70
<b>7</b>	<b>CONCLUSIONS AND FUTURE WORK .....</b>	<b>75</b>
7.1	Conclusions.....	75
7.2	Future work.....	76
<b>8</b>	<b>APPENDICES.....</b>	<b>78</b>
8.1	Appendix A - Questionnaire Used to Assess Backup Power Needs in India	78
8.2	Appendix B - Parameters Used for Trade-off Analysis in Chapter 6 .....	83
<b>9</b>	<b>BIBLIOGRAPHY .....</b>	<b>85</b>

## List of Tables

<b>Table 1: Potential to meet global energy demands in 2050 using known carbon-free sources besides solar .....</b>	<b>16</b>
<b>Table 2: Summary of solar hydrogen fuel pathways.....</b>	<b>33</b>
<b>Table 3: Attributes in evaluating solar fuel applications and generation technology .....</b>	<b>35</b>
<b>Table 4: Results of need analysis for distributed solar fuel systems .....</b>	<b>42</b>
<b>Table 5: Hydrogen production scenarios considered based on hydrogen pathway, scale of the system and reliability of grid electricity .....</b>	<b>48</b>
<b>Table 6: Inputs parameters used in the model .....</b>	<b>49</b>
<b>Table 7: Cost assumptions used in the model .....</b>	<b>50</b>
<b>Table 8: Capital and operating costs are calculated using input parameters in Table 6 .....</b>	<b>51</b>
<b>Table 9: LCOE values for the different scenarios in Table 5 as seen in Figure 17.....</b>	<b>53</b>
<b>Table 10: Share of feedstock cost in LCOE for different scenarios listed in Table 5 .....</b>	<b>54</b>
<b>Table 11:Share of capital cost in LCOE for different scenarios listed in Table 5 .....</b>	<b>54</b>
<b>Table 12: Share of O&amp;M cost in LCOE for different scenarios listed in Table 5 .....</b>	<b>55</b>
<b>Table 13: Example of range of values used for sensitivity analysis .....</b>	<b>57</b>
<b>Table 14: Comparison of select high-level characteristics between California and Gujarat .....</b>	<b>61</b>
<b>Table 15: LCA analysis for PV and grid fuel cells in California and Gujarat.....</b>	<b>83</b>
<b>Table 16: Diesel Generator Model Parameters .....</b>	<b>83</b>
<b>Table 17: LCA analysis inputs for diesel generator .....</b>	<b>84</b>
<b>Table 18: Cost of Diesel Generator .....</b>	<b>84</b>



## List of Figures

<b>Figure 1: World energy consumption by source in million tons oil equivalent (BP 2011).....</b>	<b>13</b>
<b>Figure 2: Fossil-fuel carbon emissions and primary power in the twenty-first century.....</b>	<b>15</b>
<b>Figure 3: Global fuel consumption, 2009 .....</b>	<b>17</b>
<b>Figure 4: World energy flows in 2007 .....</b>	<b>18</b>
<b>Figure 5: Solar fuel concept.....</b>	<b>19</b>
<b>Figure 6: The vision for a future energy system based on solar fuels .....</b>	<b>20</b>
<b>Figure 7: Comparison of capacity and cost implications of adding distributed generation (DG) and central sources (Swisher 2005). .....</b>	<b>22</b>
<b>Figure 8: Pathways to hydrogen from solar.....</b>	<b>25</b>
<b>Figure 9: (Left) schematic representation of a solar photovoltaic electrolytic hydrogen system .....</b>	<b>26</b>
<b>Figure 10: Schematic of concentrating photovoltaic electrolytic system .....</b>	<b>27</b>
<b>Figure 11: Types of CSP systems.....</b>	<b>28</b>
<b>Figure 12: Artificial photosynthesis schematic .....</b>	<b>30</b>
<b>Figure 13: Photo-biological process to produce fuel inside green algae .....</b>	<b>31</b>
<b>Figure 14: Key form and functional elements of distributed solar fuel systems represented using OPM</b>	<b>36</b>
<b>Figure 15: Hydrogen pathways considered for the analysis.....</b>	<b>44</b>
<b>Figure 16: Energy and material flows for the PV and grid electrolysis systems.....</b>	<b>47</b>
<b>Figure 17: Expected LCOE values for 12 different scenarios based on pathway, scale and the reliability of grid electricity .....</b>	<b>52</b>
<b>Figure 18: LCOE breakup for different scenarios .....</b>	<b>56</b>
<b>Figure 19: Tornado plots showing results of sensitivity analysis for 1000 kW PV and grid-connected systems when the duration between successive power outages is 1–30 days. ....</b>	<b>59</b>
<b>Figure 20: Tornado plots showing results of sensitivity analysis for 1000 kW PV and grid-connected systems when the duration between successive power outages is 1–3 days. ....</b>	<b>60</b>
<b>Figure 21: Scope of system used for comparing photovoltaic and grid electricity-powered fuel cells with diesel-powered generators. ....</b>	<b>64</b>
<b>Figure 22: Image of diesel generator considered for analysis .....</b>	<b>65</b>
<b>Figure 23: Comparison of LCOE values of fuel cell- and diesel-powered backup systems in California and Gujarat.....</b>	<b>67</b>
<b>Figure 24: Comparison of GWP values of fuel cell- and diesel-powered backup systems in California and Gujarat.....</b>	<b>68</b>
<b>Figure 25: Comparison of weighted sum values of fuel cell- and diesel-powered backup systems in California and Gujarat.....</b>	<b>69</b>
<b>Figure 26: LCOE vs. LCA for PV-Diesel Combination, California.....</b>	<b>71</b>
<b>Figure 27: LCOE vs. LCA for PV-Diesel Combination, Gujarat .....</b>	<b>71</b>
<b>Figure 28: Weighted Sum for PV-Diesel Combination, California.....</b>	<b>72</b>
<b>Figure 29: Weighted Sum for PV-Diesel Combination, Gujarat.....</b>	<b>72</b>
<b>Figure 30: LCOE vs. LCA for 1 MW system, California .....</b>	<b>73</b>
<b>Figure 31: LCOE vs. LCA for 1 MW system, Gujarat.....</b>	<b>74</b>

**(THIS PAGE IS INTENTIONALLY LEFT BLANK)**

## 1. INTRODUCTION

This thesis is the result of a fortuitous meeting with Dr. Daniel Nocera at MIT Energy Conference in 2011. His path-breaking research on “artificial photosynthesis” opened my eyes to the scale and nature of the energy crisis facing humanity, but perhaps more importantly, to the potential that exists in *distributed solar fuel systems* to address this problem. This thesis is an attempt to understand the larger context of distributed solar fuel systems, and to critically examine a baseline distributed solar fuel system available today in the context of a specific application.

In doing so, this thesis seeks to a) assess the feasibility of a distributed solar fuel system based on state-of-the-art technology b) draw some general conclusions about such systems in order to provide guidance to those engaged in the research and development of solar fuel systems.

This thesis is divided into six main chapters.

**Chapter 2** motivates the huge potential that exists in solar fuel systems to meet global energy demand, with practically zero emissions. This is done by looking at some key global energy consumption trends and the limitations that exist in meeting the projected demand using conventional sources of energy. The key characteristics of distributed solar fuel systems are then explained and an argument is made for going distributed. The chapter concludes by stating two hypotheses about distributed solar fuel systems. The rest of the thesis is structured to investigate these hypotheses.

**Chapter 3** provides a summary of the different pathways to produce hydrogen (the solar fuel of choice for this thesis) from solar energy. Based on an analysis of the key characteristics of each pathway, the most promising pathways for going distributed are selected for further analysis.

**Chapter 4** identifies the most promising near-term market for distributed solar fuel systems and the most appropriate technology pathway to address the needs of that segment. This is achieved through a functional decomposition of a typical solar fuel system to understand the most desirable attributes of such a system and using these attributes to rank the most promising applications identified through a literature survey of past market studies.

**Chapter 5** undertakes a detailed economic analysis for a baseline distributed solar hydrogen system at different scales for the application identified in the Chapter 4 and draws some general conclusions about the system.

**Chapter 6** compares the system specified in chapter 5 with a traditional fossil fuel-based alternative and undertakes a cost-to-emissions trade-off analysis to draw conclusions about possible hybrid systems.

Finally, **Chapter 7** summarizes the conclusions from this thesis and identifies avenues for future research into solar fuel systems.

## 2. MOTIVATION AND HYPOTHESIS

*“Energy is the single most important challenge facing humanity today”*  
– Richard E. Smalley, Nobel Laureate, April 2004, Testimony to U.S. Senate

### 2.1 How Much Energy Do We Need?

The way we produce and manage energy is perhaps the most critical and enduring challenge of our times. In order to fully appreciate the scale of the problem and get a handle on broad directions for possible solutions, its useful take a step back to consider some key statistics on global energy consumption. In 2008, energy was consumed at the rate of 16 terawatts (TW) by a worldwide population of over 6 billion people (K. A. Smith, Sullivan, et al. 2011). By 2050, even by conservative estimates, it is anticipated that 30 TW would be needed by over 9 billion people (Nocera 2006). Most of the additional 3 billion people would be added in developing countries like India and China. In addition to the 3 billion new inhabitants, the standard of living (and hence energy consumption) of 3 billion of the existing “energy poor” is projected to improve.

### 2.2 How is Energy Consumed Today?

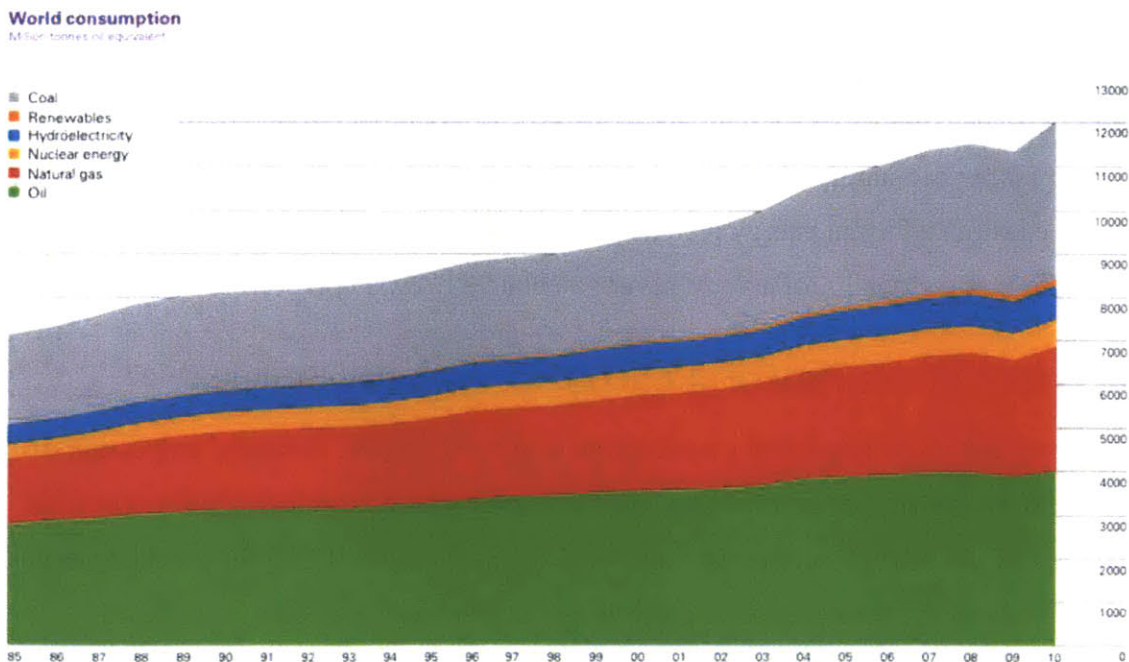

**Figure 1:** World energy consumption by source in million tons oil equivalent (BP 2011)

Given the growing global energy needs it's worth considering current global energy consumption trends. A look at global energy consumption by primary energy source as it stands today shown in **Figure 1** taken from *BP 2011 Statistical Review of World Energy*, indicates the following:

1. The share of global energy consumption is dominated overwhelmingly by fossil fuels. Approximately 33% share of total energy comes from oil, 30% from coal and 24% from natural gas.
2. Renewable energy and hydroelectricity constitute about 8% of the total consumption, while nuclear makes up 5%.

### **2.3 Does the World Have Enough Energy Sources?**

Acknowledging current global energy consumption trends, it's worth considering if the world has enough energy resources to support the 30 TW-energy demand in 2050. The answer, perhaps a bit surprisingly, is yes. Studies indicate that there are enough fossil fuels to meet the projected demand for the next several hundreds of years. Based on 1998 consumption rates, 40–80 years of proven conventional and unconventional oil reserves exist globally, and 50–150 years of oil are available if the estimated resource base is included. Sixty to 160 years of reserves of natural gas are present, and between 207 and 590 years of gas resources, not including the natural gas potentially available as methane clathrates in the continental shelves, are in the estimated resource base. Similarly, a 1,000- to 2000-year supply of coal, shales, and tar sands is in the estimated resource base. Hence the estimated fossil energy resources could support a 25- to 30-TW energy consumption rate globally for at least several centuries (Lewis & Nocera 2006).

### **2.4 Is the Current Pattern of Energy Consumption Sustainable?**

The current pattern of fossil fuel consumption is not sustainable. A careful inspection of **Figure 2** from (Hoffert et al. 1998) reveals the reason. The figures indicate six scenarios developed by the Intergovernmental Panel on Climate Change (IPCC) for greenhouse-gas emissions based on socio-economic projections. In panel a) the IS92a curve shows carbon emissions for the “business as usual” scenario while the various WRE curves

show the emissions levels needed to stabilize the atmospheric CO<sub>2</sub> levels at 750, 650, 550, 450 and 350 ppm. Panel b) shows the primary sources of power for the different scenarios. The difference between the IS92a total primary power and fossil-fuel power allowable for CO<sub>2</sub> stabilization, must be provided by carbon-free sources if the socio-economic assumptions of IPCC “business as usual” scenario are maintained; an increasingly challenging goal as the CO<sub>2</sub> concentration target is lowered. Panel c) indicates this difference – the carbon-free power that must be provided in each scenario.

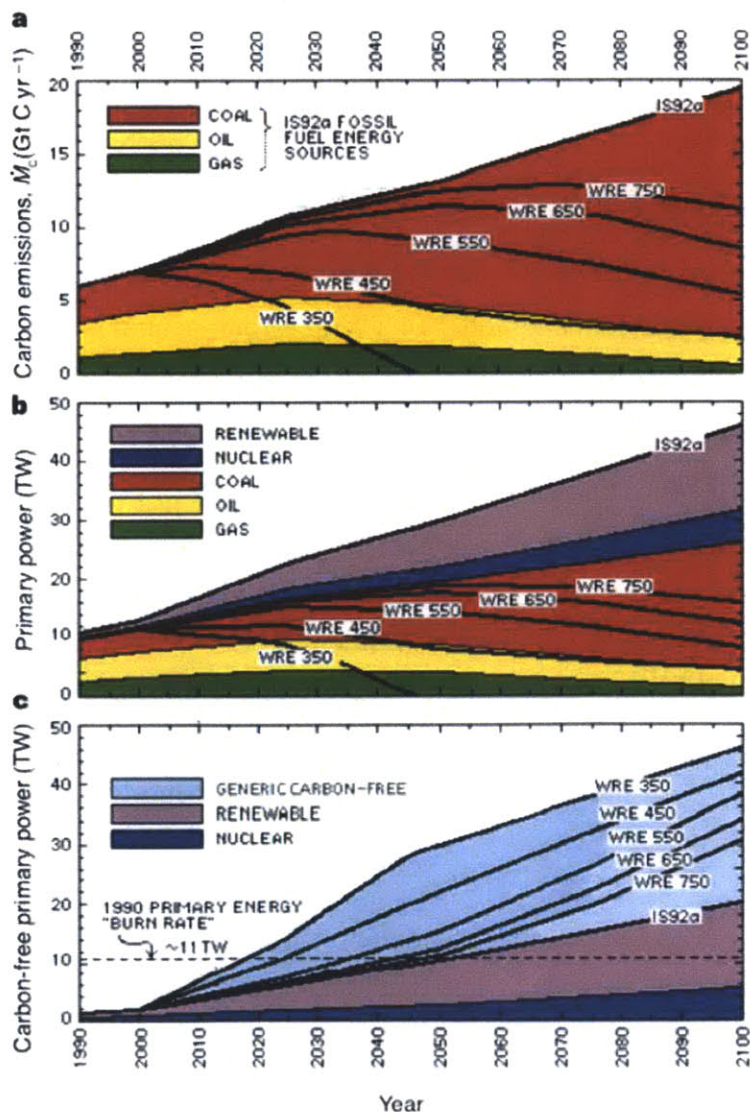

**Figure 2:** Fossil-fuel carbon emissions and primary power in the twenty-first century for IPCC IS92a (“business as usual”) and WRE stabilization scenarios. a) Carbon emissions b) primary power and c) carbon-free primary power. Colored areas are gas, oil, coal, nuclear and renewable components of IS92a. Carbon-free primary power is total primary power less fossil-fuel carbon power (Hoffert et al. 1998).

It's clear from **Figure 2** and the analysis in (Hoffert et al. 1998) that:

1. The only way to bring the stock of atmospheric CO<sub>2</sub> down is to add renewable sources of energy to the total energy mix.
2. Even to maintain CO<sub>2</sub> levels at 550 ppm, which is already twice the pre-anthropogenic levels, we need to generate as much energy from carbon-neutral sources as using oil, coal, gas and nuclear combined (i.e., approximately 14 TW).
3. While the precise effects of CO<sub>2</sub> on climate change are unclear in the present day, we cannot adopt a “wait and see” approach to introduce renewable energy since it may then be too late given the time delays involved in stabilizing the stock of atmospheric CO<sub>2</sub>.

## 2.5 Can Renewable Sources of Energy Meet the Projected Demand?

The above discussion raises the question whether we have enough carbon-free sources of power to meet the need for an additional 14 TW of carbon-neutral power by 2050. There are three general routes available to meet such large amounts of carbon neutral energy – nuclear, carbon capture and sequestration (CCS) and renewable energy. (Lewis 2007) broadly considers these options with the goal of assessing their potential to meet the afore-mentioned need. The findings from the paper are briefly summarized hereafter.

Source	Power Available (TW)	Comments
Biomass	7–10	Entire arable land mass of the planet must be used excluding the area needed to house 9 billion people
Wind on land	2.10	Would saturate the entire Class 3 (wind speed at 5.1 m/s at 10 m above ground) global land mass with windmills
Nuclear	8.00	Requires the construction of 8000 new nuclear power plants
Hydroelectric	1.50	Would require damming of all available rivers

**Table 1:** Potential to meet global energy demands in 2050 using known carbon-free sources besides solar (Lewis 2007)

**Nuclear:** Nuclear fission is certainly an option. However, satisfying the total energy needs via nuclear power requires the construction of at least 10,000 1-GW power plants at the rate of one power plant every 1.6 days, somewhere in the world, for the next 45



years. It would then be time to replace the first of those plants, given the 50-year life of a typical reactor. We would essentially have to build a nuclear reactor every other day forever. The feasibility of nuclear fusion seems much too far into the future to be considered a realistic option for 2050.

**Carbon Capture and Sequestration (CCS):** CCS, in principle, could be a possible intermediate solution since global reservoir capacity is estimated to be the equivalent of ~100-150 years of carbon emissions. However there are many uncertainties with the technology. To be a viable option, the CO<sub>2</sub> must not leak at a globally averaged rate of 1% for a timescale of centuries. Otherwise, the emitted flux will be greater than or equal to that intended to be mitigated initially. CCS technology as of date is a fair bit away from realizing this constraint.

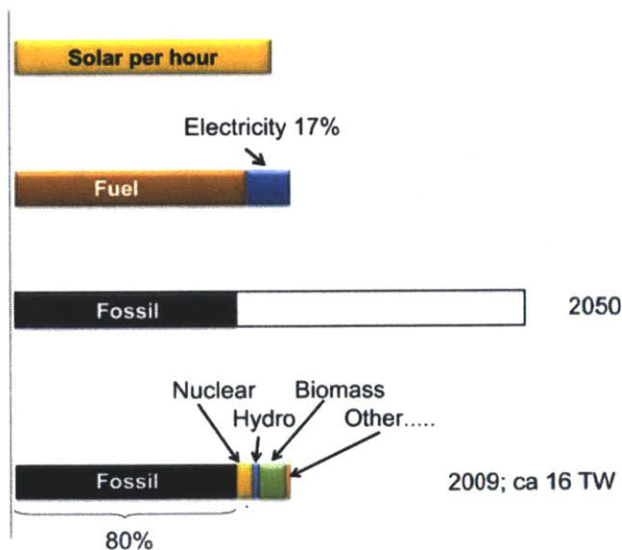

**Figure 3:** Global fuel consumption, 2009. Lower-most bar shows world energy consumption per year in 2009, recalculated to electric power. 80% of this energy was provided from fossil fuels. The top-most bar shows the total solar irradiation on the planet per hour. The second bar shows that 17% of the world's energy use was in the form of electricity. The third bar shows the projected energy use in 2050 (Styring 2012).

**Renewables:** Among renewable sources of energy, wind, biomass and hydroelectric capacities, even by optimistic estimates, are too low to address the mammoth need. Solar energy is by far the most abundant source. More solar energy strikes the Earth's surface in one hour of each day than the energy used by all human activities in one year (c.f., **Figure 3** above). It wouldn't be realistically possible to capture all the solar energy striking the earth's surface (Nocera 2006). However the statistic does indicate the enormous potential that exists in leveraging sun's energy. Also unlike most other sources of energy, solar energy is distributed equitably around the world.

## 2.6 The Case for Solar Fuels

World Energy Flow  
in 2007: ~490000 PJ

Lawrence Livermore  
National Laboratory

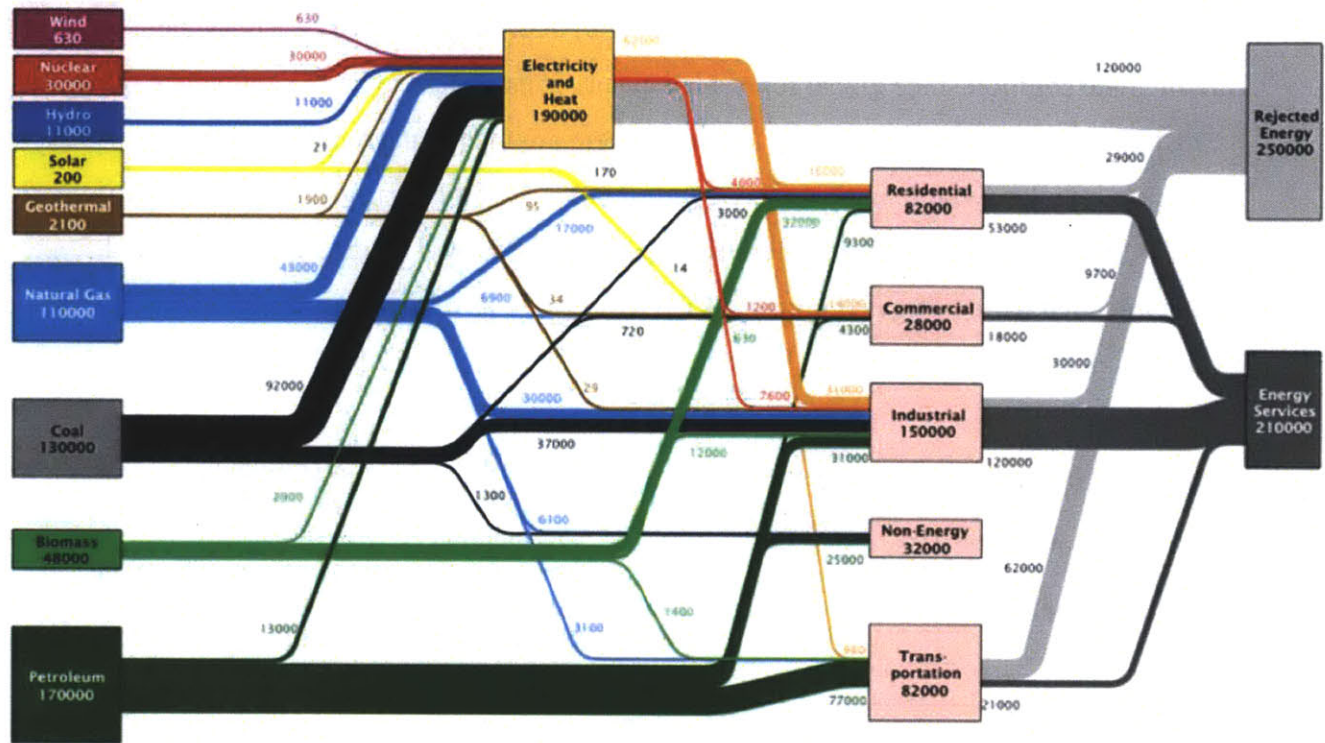
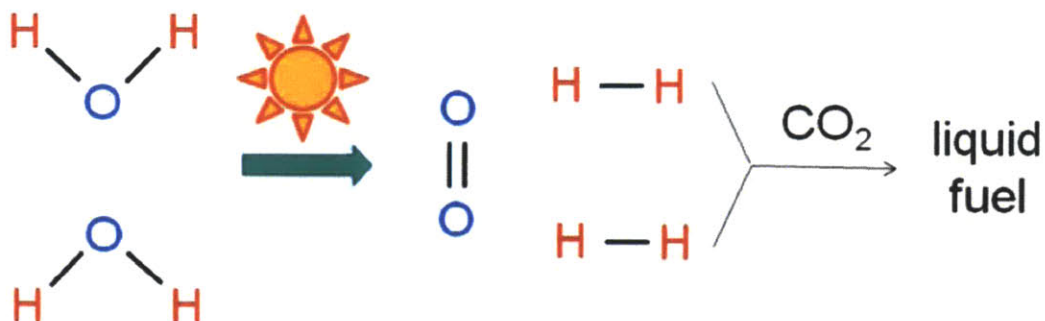

**Figure 4:** World energy flows in 2007 (C. A. Smith, Belles, et al. 2011). Boxes to the left indicate the primary sources of energy in the world; the boxes to the right indicate various applications consuming the different forms of energy. Electricity constitutes ~17% of the energy consumed.

It's interesting to take a closer look at the breakup of primary energy flows in the world as of 2007. **Figure 4** above from the Lawrence Livermore National Laboratory shows the broad application areas that consume the primary sources of energy. Notice that electricity constitutes only about 17% of the total energy consumed. This figure is expected to increase to 22% by 2030. The remaining 78% of the energy will be consumed as fuels. It is clear that to solve the afore-mentioned energy problem, carbon-free fuels must replace a large share of the fossil fuel consumption.

The potential of using solar energy to meet the carbon-free energy goals of 2050 has already been motivated in the previous section. What if solar energy could be used to create fuels? This is indeed the promise of solar fuels – to create fuel using solar energy.

**Figure 5** below shows an example of the basic idea.



**Figure 5:** Solar fuel concept. One of the most promising pathways for solar fuels is to split water using solar energy to produce hydrogen and oxygen. The hydrogen can either be used directly as fuel (for e.g., in fuel cells) or can be combined with atmospheric CO<sub>2</sub> to produce liquid fuels. Image source: (Moniz 2012).

The fundamental idea as shown in **Figure 5** above is to use solar energy to split an abundant source of hydrogen such as water to create hydrogen. In this scheme, solar energy is stored within the rearranged chemical bonds of the fuel. Hydrogen can then be used directly as fuel, for example in a fuel cell to produce electricity or to upgrade biomass and other fuels. A very desirable property of hydrogen is that it is carbon-free; on combustion it combines with oxygen to release energy and give back (clean) water that was used to produce it! The process is essentially the inverse of the one shown in **Figure 5**. Alternatively hydrogen can be combined with CO<sub>2</sub> to produce liquid fuels such as methanol or diesel<sup>1</sup>.

There is yet another compelling use case for solar fuels. Given the diurnal nature of solar energy, there is a need for storage - to be able to use sun's energy when it is not shining. Incumbent battery technologies for energy storage have low energy densities and cannot scale to the massive grid-scale energy storage requirements. Solar fuels on the other hand

---

<sup>1</sup> Notice that there is no net carbon added to the atmosphere when fuels produced this way are burned

have high energy density, comparable to that of fossil fuels. It therefore can serve as an extremely good source of energy storage.

The vision for an economy based on solar fuels as shown in **Figure 6** below is indeed very compelling. Solar fuels could in principle replace fossil fuels in existing energy intensive industrial and transportation applications.

**What could the production and use of solar fuels look like?**

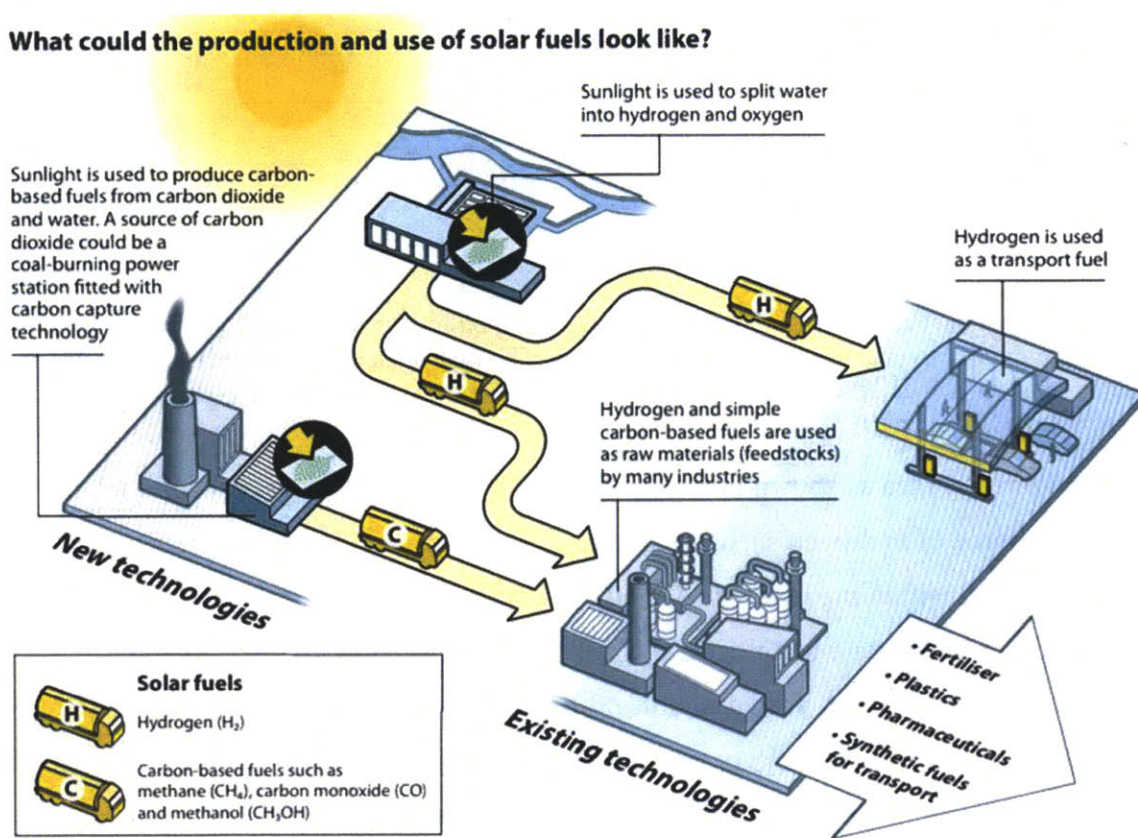

**Figure 6:** The vision for a future energy system based on solar fuels (Gust et al. 2009)

Not surprisingly, there's been an exponentially growing interest in the area of solar fuel research since the beginning of this century (Styring 2012).

## **2.7 The Case for Distributed Energy Systems**

Should the solar fuel systems of tomorrow be centralized or distributed? While most energy systems that exist today are centralized in scale, there are a few compelling reasons for going distributed when thinking about new energy systems.

### **2.7.1 DEVELOPED COUNTRIES CAN “CHIP AWAY” AT THE PROBLEM**

Most developed countries<sup>2</sup>, are heavily invested in centralized legacy systems worth hundreds of billions of dollars. It's economically unrealistic to introduce large centralized carbon-neutral energy systems before the existing investments in fossil fuel-based systems are fully recovered. Moreover, as argued in **Section 2.4**, waiting till the existing systems are fully amortized, is simply untenable. An attractive property of distributed clean energy systems is that they enable introduction of clean energy to the global energy mix long before retiring existing centralized energy systems.

### **2.7.2 DEVELOPING COUNTRIES CAN LEAP FROG TO BETTER TECHNOLOGIES FASTER**

By 2050 six billion out of nine billion people in the world are expected to be living in developing countries (c.f. **Section 2.1**). With increasing standard of living of the people in these economies, their share of the global energy consumption is likely to increase. Centralized energy projects in many of the large developing countries like India are chronically under-funded and take notoriously long to implement. Distributed clean-energy systems allow developing countries to fill the large white spaces in the local energy supply mix, without waiting for the centralized transmission and distribution infrastructure to catch up. Due to their smaller scale, distributed systems also lend themselves very well to be owned and operated by the private sector.

### **2.7.3 DISTRIBUTED ENERGY SYSTEMS ARE MORE PROFITABLE**

The most important reason for adopting distributed energy systems<sup>3</sup> is that they are less risky and more profitable than large centralized energy systems.

---

<sup>2</sup> Who consume a lion's share of the global energy supply

<sup>3</sup> Commonly referred to as Distributed Generation or DG

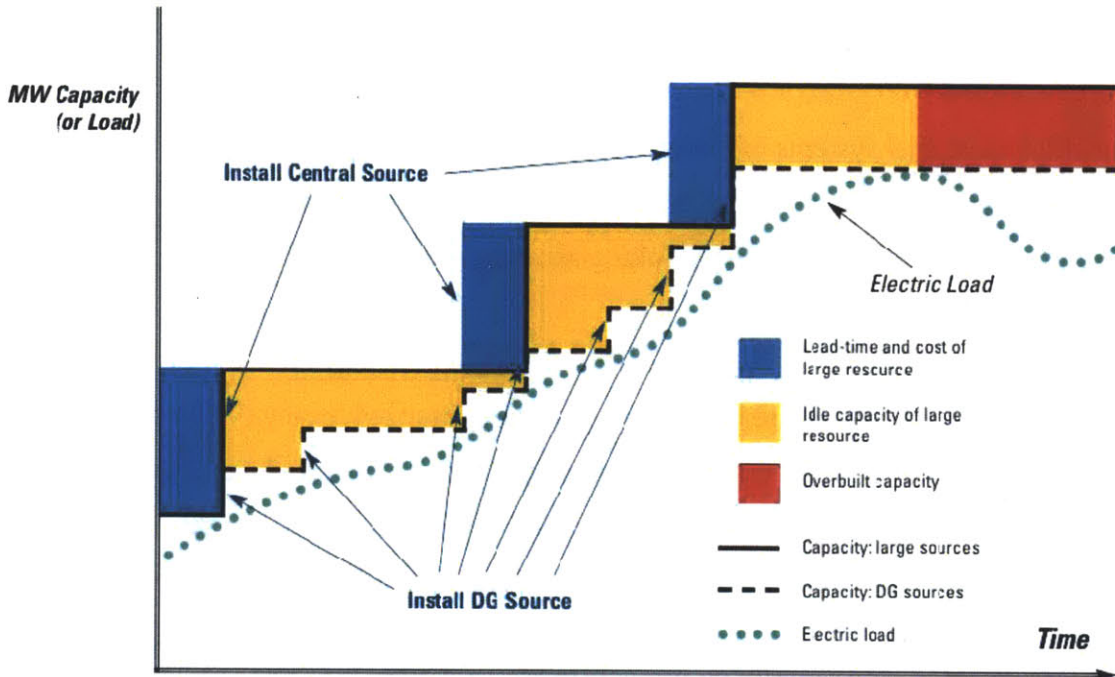

**Figure 7:** Comparison of capacity and cost implications of adding distributed generation (DG) and central sources (Swisher 2005).

A comprehensive discussion of over 200 benefits of DG can be found in (Lovins 2002). A shorter summary of the same can also be found in (Swisher 2005). Some key insights from this research are outlined below.

1. *Option Value Benefits:* Central sources are made available in large capacity increments and have long lead-times (c.f. **Figure 7**). Distributed energy sources on the other hand are available in flexible capacity increments and have short lead-times. The increased modularity and flexibility of distributed sources compared to central sources result in option value benefits including 1) increased lead-time and cost of central sources, 2) increased cost of idle capacity that exceeds existing load, and 3) increased cost of overbuilt capacity that remains idle (Swisher 2005). Distributed resources' smaller size thus reduces the divergence of reality from expectation, and more critically, the consequences of such divergences: risk of technology obsolescence, carrying costs of plants under construction (which can reduce the present-value cost of the plant itself) and unfavorable regulations during construction.

2. *Cost Deferral Benefits:* Transmission and distribution (T&D) companies can gain significant value by deferring capacity costs if DG is correctly sited in time and place (Swisher 2005).
3. *Electrical Engineering Cost Savings:* In addition to capacity deferral value, DG can provide economic benefits to distribution utilities by reducing costs in the operation and maintenance of transmission and distribution systems. These benefits include: reduction of losses, voltage support and reactive power support (Swisher 2005).
4. *Reliability Benefits:* Reliability is increasingly valued in the modern digital economy. The outage costs in some industries such as financial services can run into millions of dollars per hour. In centralized systems, the majority of outages are caused by faults in the distribution system, from interference by trees, animals, cars, etc., rather than by generation. DG can provide much higher levels of reliability (over 99.999%) than traditional “wires-only systems” (99.9%) (Swisher 2005).
5. *Environmental Benefits:* Distributed resources offer a number of environmental benefits. They are less material and energy intensive than their centralized counterparts. With some notable exceptions such as dirty engine generators, DG tends to reduce total air emissions per unit of energy delivered. DG resources’ land-use tends to be temporary rather than permanent and have lower impact on fish and wildlife due to confined range of effects (Lovins 2002).

## 2.8 Hypotheses

Taken together, **Sections 2.6 and 2.7** provide a compelling case for distributed solar fuel systems. However despite the growing research into the basic sciences behind solar fuels, which are no doubt critical, not enough research has been undertaken to understand

distributed solar fuel systems. While a number of studies have tried to assess the feasibility of large centralized solar fuel systems, precious little work of a similar nature exists for distributed solar fuel systems—especially about their economic feasibility—that allows for meaningful comparisons between current and future technology alternatives. The rest of this thesis attempts to fill this gap. This shall be achieved in the following steps.

1. Hydrogen is chosen as the solar fuel of choice given the advantages described in **Section 2.6** and the fact that catalysts that photo-reduce atmospheric CO<sub>2</sub> are yet to be developed.
2. The most important pathways to produce hydrogen from solar will then be explored. Based on an analysis of the advantages and disadvantages of the different pathways, the most promising distributed pathway would be selected.
3. Existing markets for the selected pathway would be explored to derive the most promising near-term application and technology. The latter will then be investigated in detail for economic feasibility.
4. Levelized Cost of Energy (LCOE) for hydrogen would be computed for the chosen system. Additionally the feasibility of a hybrid system using both solar fuels and fossil fuels would be explored to understand possible trade-offs between cost and carbon emissions. Other factors such as safety are not considered in this analysis and could be a topic of future research.

In doing so the study seeks to confirm the following hypotheses.

**Hypothesis 1: For distributed, solar fuel systems to be viable, cost and efficiency improvements in individual sub-systems won't be sufficient. Due attention needs to be given to bring down cost of the entire system.**

**Hypothesis 2: If carbon emissions are considered as a decision-making criterion in addition to cost, even at current cost levels solar fuel systems could compare favorably with the existing fossil fuel-based alternatives.**



### 3. SOLAR HYDROGEN PATHWAYS

*"Yes, my friends, I believe that water will someday be employed as fuel, that hydrogen and oxygen, which constitute it, used singly or together, will furnish an inexhaustible source of heat and light....I believe, then, that when the deposits of coal are exhausted, we shall heat and warm ourselves with water. Water will be the coal of the future."*  
– Jules Verne

There are several promising pathways to produce hydrogen using solar energy. The most promising of these pathways would be described in this chapter. One of the pathways will then be selected for deeper analysis in **Chapter 4**. The most important pathways known today are summarized in **Figure 8**.

They can be broadly classified into two types – direct and indirect pathways. Indirect pathways convert solar energy to produce an intermediate carrier such as electricity, which is then used to produce hydrogen. Direct methods on the other hand produce hydrogen without any intermediate conversions.

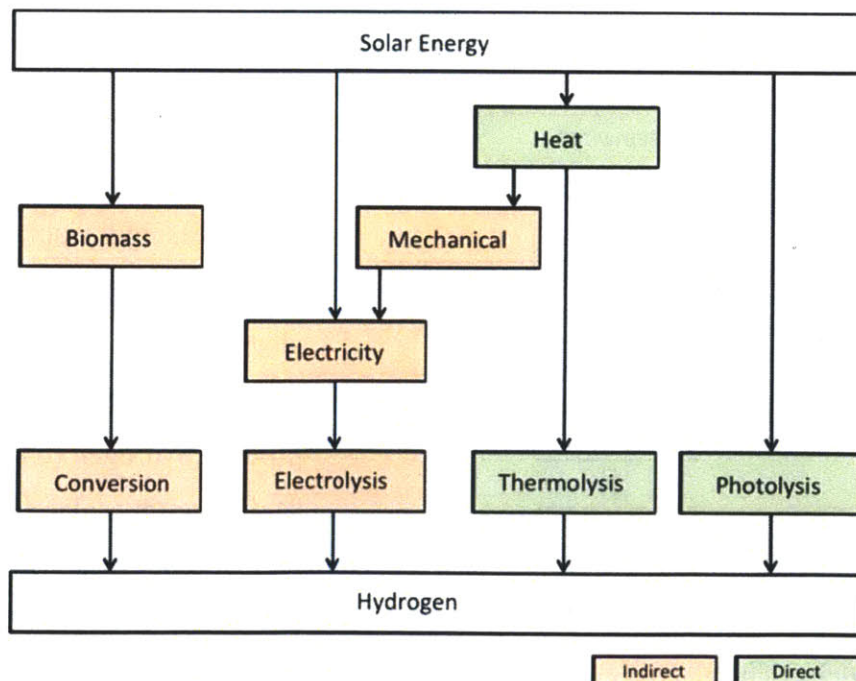

**Figure 8:** Pathways to hydrogen from solar. Adapted from (J. A. Turner 1999)

## 3.1 Indirect Solar Hydrogen Pathways

### 3.1.1 BIOMASS CONVERSION

The most well-known indirect process for producing hydrogen is natural photosynthesis. Plants, trees and photosynthetic microorganisms use sunlight to split water into oxygen and hydrogen. The hydrogen is then combined with atmospheric carbon dioxide to produce carbohydrates which are stored in the structure of the plants. The stored energy can be converted to fuel using processes such as fermentation and pyrolysis. The technologies to achieve this are pretty mature. The biggest drawback though is the “detour” around the life of the organism when harvesting the fuel. Much of the energy is “wasted” by the plant to sustain life while other losses originate from inefficient solar energy absorption. As a result, conversion efficiencies are extremely low – in the range of 0.1-2% (Styring 2012). The low efficiencies require large tracts of land and hence effectively rules out small-scale systems.

### 3.1.2 PHOTOVOLTAIC ELECTROLYSIS

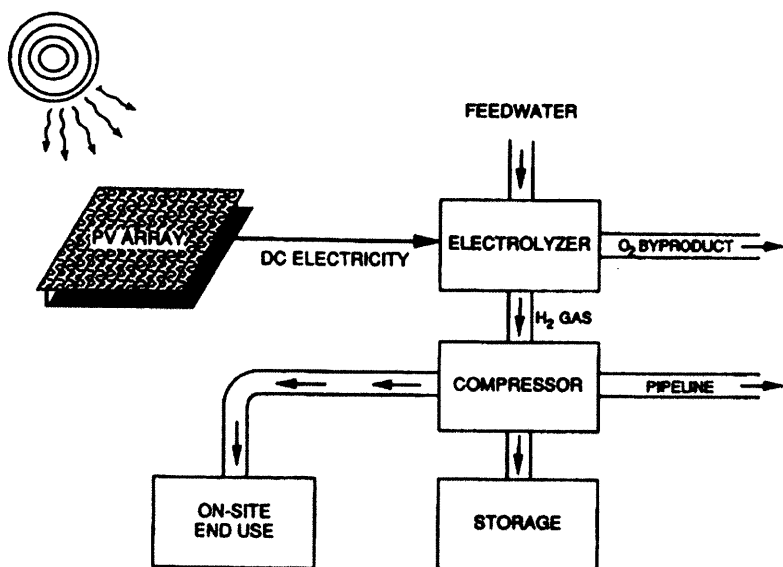

**Figure 9:** (Left) Schematic representation of a solar photovoltaic electrolytic hydrogen system

An increasingly viable option is to split water by passing an electric current through it in a device called the electrolyzer to produce hydrogen (c.f., **Figure 9**). Converting solar energy to electrical potential using photovoltaic cells produces the

needed electricity. The electrolyzer consists of two electrodes, called the anode and the cathode immersed in water and separated by a membrane that allows for the dissociation

of protons. Catalysts facilitate the oxidation of water to hydrogen at the cathode and the reduction to oxygen at the anode.

These systems are extremely versatile. Systems of many different scales are possible with a power rating of a few kilowatts for residential applications to several hundred megawatts in case of large power plants. The main drawbacks arise due to the detour around electricity. There are energy losses when electricity is converted to fuel resulting in lower efficiencies than using the electricity directly. The presence of additional system components also drives up the capital and integration costs relative to direct pathway systems. The cost of photovoltaic cells and electrolyzers are rapidly reducing and their efficiencies are increasing, making this system increasingly attractive for commercial applications, given that the technology is well established. Over the next few years efficiencies of thin-film solar cells are expected to touch 18-20% and those of electrolyzers are expected to reach 80%, making the overall system efficiency close to 16%.

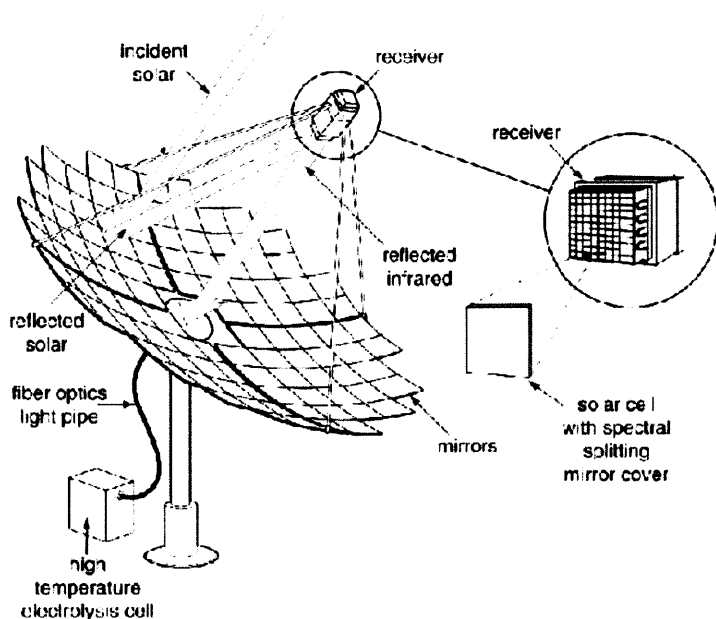
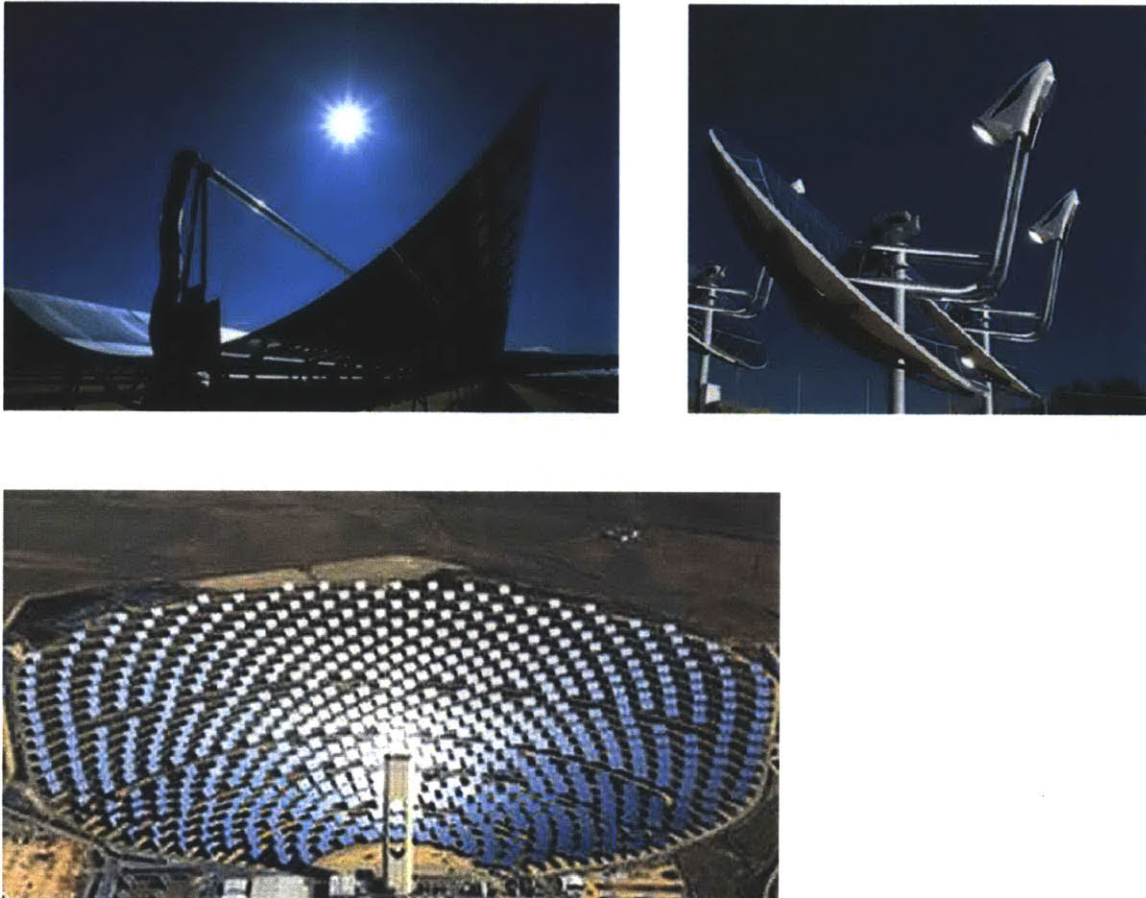

**Figure 10:** Schematic of concentrating photovoltaic electrolytic system shows sunlight reflected and focused on the receiver, with reflected infrared directed to a fiber-optics light pipe for transport to a high-temperature solid-oxide electrolysis cell. Solar electricity is sent to the same electrolysis cell, which is able to use both heat and electricity to split water (Rajeshwar et al. 2010).

The efficiency of a photovoltaic hydrogen system can be increased even more if concentrating photovoltaic modules (CPV) are used instead of flat PV modules (c.f. schematic in **Figure 10**). The “heat boost” from CPV can increase the efficiency of the system to over 30%. With advancements in multi-junction silicon cells over the next 5-10

years, the efficiency of the system is expected to cross 50% (Rajeshwar et al. 2010). The cost of the concentrating panels together with the solar tracking system increases the cost of the system, however.

### 3.1.3 THEMOLYTIC ELECTROLYSIS



**Figure 11:** Types of CSP systems. (Top left) parabolic trough system; (top right) parabolic dish system; (bottom left) central tower system

A variation of the above idea is to use concentrating mirrors or lenses to focus solar radiation and heat a working fluid (e.g., pressurized steam, synthetic oil, molten salt) to a high temperature; the hot fluid can then be easily stored and utilized later to make steam to turn a turbine to generate electrical power. The electricity generated can be used to run a traditional electrolyzer and generate hydrogen (Ginley et al. 2008). Such systems are

referred to as Concentrating Solar Power (CSP) systems (not to be confused with CPV systems described above).

Different types of collectors are possible. One type of collector is a set of parabolic trough (long U-shaped) mirror reflectors that focus light onto a pipe containing oil that flows to a chamber to heat water for a steam generator that produces electricity. A second type is a central tower receiver with a field of mirrors surrounding it. The focused light heats molten nitrate salt that produce steam for a steam generator. A third type of CSP technology is a parabolic dish-shaped (e.g., satellite dish) reflector that rotates to track the sun and reflects light onto a receiver, which transfers the energy to run a “Stirling Engine” to generate electricity (Jacobson 2009). The CSP systems are typically best suited for large centralized power plants. The concentrators also require direct sunlight and hence may not be suitable in locations that have cloudy weather or don’t get direct sunlight.

## **3.2 Direct Solar Hydrogen Pathways**

Direct processes, as the name suggests, produce solar fuel directly by avoiding the detour around intermediate energy carriers. As a result these approaches in principle have the potential for much higher levels of efficiency and lower overall system costs. Many of the direct approaches are in early phases of R&D and are feasible only at smaller scales.

### **3.2.1 THERMOCHEMICAL CYLES**

Thermochemical water splitting uses the principle that at very high temperatures, in the range of 2500 K, water dissociates into hydrogen and oxygen. Due to the simplicity of the process, in theory, very high efficiencies can be obtained. However, catalysis, gas recombination, and containment materials limitations above 2000 °C have led to very low solar efficiencies for direct solar thermal hydrogen generation (Rajeshwar et al. 2010). As a result pure thermolysis is not being actively pursued as a feasible pathway. However hybrid systems have emerged that use heat to increase the efficiency of electrolytic system as described in **Figure 10** above.

### 3.2.2 PHOTOLYSIS

Photolysis systems combine the two separate steps of electrical generation and electrolysis into a single system. This process is popularly known as “artificial photosynthesis” since it seeks to mimic natural photosynthesis. These direct conversion systems include photo-electrolysis and photo-biological systems and are based on the fact that visible light has a sufficient amount of energy to split water. The keys for these direct conversion systems are to find a light-harvesting system and a catalyst that can efficiently collect the energy and immediately direct it toward the water-splitting reaction.

These technologies are currently in various phases of research and development. All of them currently have very low efficiencies (~1 – 2%) but have tremendous potential for future efficiencies and lower system costs. Various molecular and non-molecular approaches are being explored in universities such as MIT (NoceraVideo 2010) and California Institute of Technology (LewisLab 2012) and research labs such as the Joint Center for Artificial Photosynthesis (JCAP 2012), set up by the U.S Department of Energy in 2010.

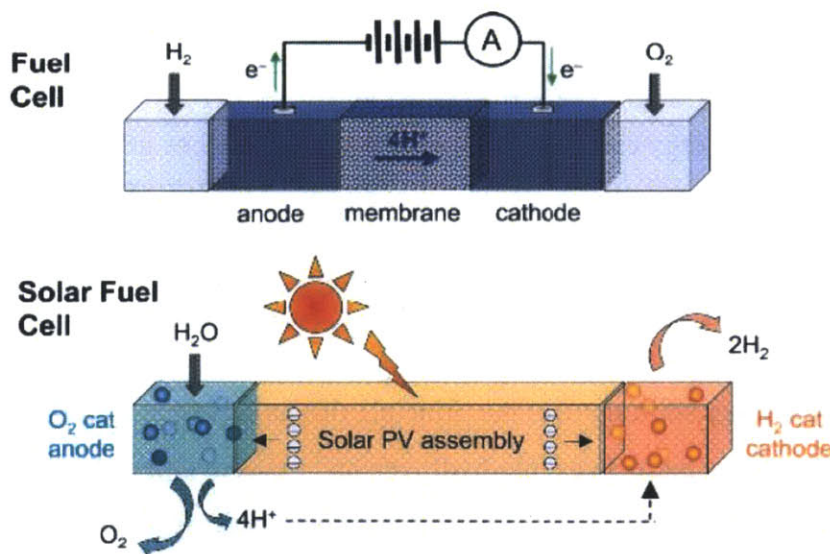

**Figure 12:** Artificial photosynthesis schematic. In a fuel cell,  $H_2$  and  $O_2$  are combined in a fuel cell to generate a flow of electrons and protons across a membrane, producing electrical energy. The solar fuel cell uses light to run the electron and proton flow in reverse. Coupling the electrons and protons to catalysts breaks the bonds of water and makes the bonds  $H_2$  and  $O_2$  to effect solar fuel production (Lewis & Nocera 2006).

### 3.3 Semi-Direct Solar Hydrogen Pathways

#### 3.3.1 PHOTO-BIOLOGICAL PATHWAYS

A novel approach to produce solar fuels is to harvest solar energy and use the photo-biological processes within a micro-organism. Certain types of green algae and cyanobacteria can combine efficient water oxidizing photosynthesis with the capacity to use some of this energy to produce hydrogen. The fuel can be formed continuously in a vessel called the photo-bioreactor. The approach is not entirely direct since energy-rich intermediates such as starch and carbohydrates are formed inside the organism.

The fuel production does not demand the harvest of the entire organism. Therefore this is a process where maintaining life and growing the organism only uses a small part of the supplied solar energy. The efficiency of such a photo-biological process can be much higher than of a system where the biomass is harvested. It is however also lower than what can be theoretically achieved by artificial photosynthesis. This is because a significant fraction of the absorbed solar energy is used by the organism to maintain its life-processes (Styring 2012). The maximum theoretical efficiency of photo-biological cells is 12-13%.

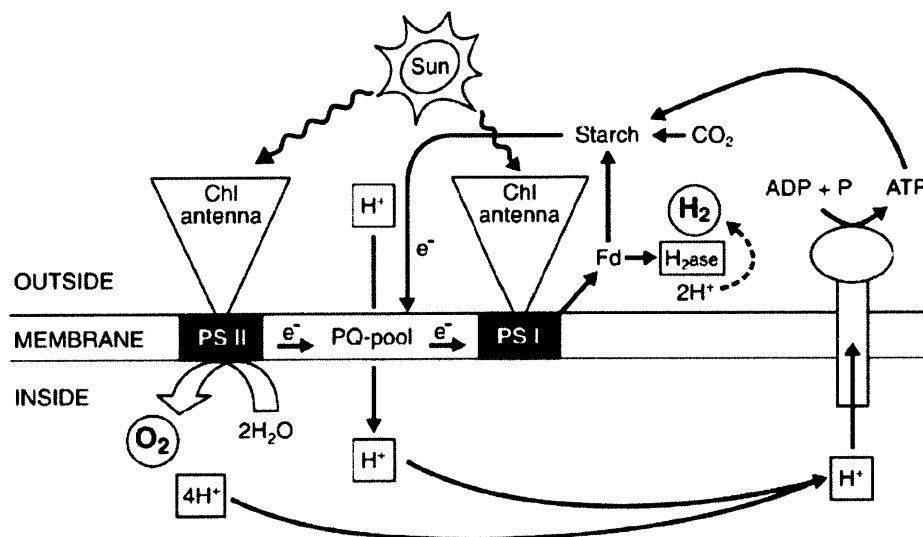

**Figure 13:** Photo-biological process to produce fuel inside green algae. Light absorbing antenna pigments convert 43-45% of the incident solar energy (Rajeshwar et al. 2010).

The process is in the early stages of R&D. However the possibility of addressing the energy problems of the future using biological approaches cannot be ruled out considering that 90% of all energy ever consumed by humans, in the form of fossil fuels and biomass, are the result of biological processes (Rajeshwar et al. 2010).

The systems described in this chapter are summarized in **Table 2** below. Based on the analysis of the major known hydrogen pathways, it's clear that for distributed solar fuel generation, photovoltaic electrolysis systems and artificial photosynthesis systems have potential for the greatest impact in the near-to-medium term horizon. Near-term markets and their requirements for distributed solar fuel systems will be investigated next in **Chapter 4**.



Pathway	Concept	Stage of Development	Potential for Breakthrough Impact	Pros	Cons	Efficiency	Scale of Systems	Cost of Energy (\$/kg H <sub>2</sub> )
Biomass <sup>4</sup>	Store solar energy via photosynthesis in plants. Recover energy using conversion processes such as fermentation, pyrolysis etc	Commercialized, low visibility	Low	Technology well-established, hence low risk	Very low efficiency Only large systems possible	0.1-2%	Centralized	1.70 - 3.0
Photovoltaic Electrolysis <sup>5</sup>	Electrolyze water using electricity generated via photovoltaics	Commercialized, High innovations, high visibility	High	Most versatile system. Can accept electricity from any other source Systems of different scales possible - from 1 kW to 300 MW	Indirection results in lower efficiency, higher system costs.	10-16%	Centralized and distributed	4.0 - 6.0 (for central)
Thermolytic Electrolysis <sup>6</sup>	Concentrate solar energy to produce heat. Use heat to run a heat pump to produce electricity, which in turn is used to electrolyze water.	Commercialized, incremental innovations	Medium	Higher efficiencies than solar PV	Only large systems possible Needs direct sunlight, making available resource less than PV	15-20%	Centralized	3.5-5.5
Thermochemical Cycles <sup>7</sup>	Heat water to 2500 K by concentrating solar energy. Water dissociates into hydrogen and oxygen	Research, low visibility	Low	Very high theoretical maximum efficiencies	Only large systems possible Very low efficiencies Materials challenges	<10%	Centralized	6.0 - 10.0
Photolysis (artificial photosynthesis) <sup>8</sup>	Using solar energy to electrochemically split water in the presence of catalysts	Research, high visibility	Very high	High theoretical efficiencies possible Potential for low cost systems	Many engineering challenges in increasing efficiency, scalability and stability of system	1-2%	Distributed	unknown
Photo-biological systems <sup>9</sup>	Using photosynthesis in a micro-organism to harvest solar energy and produce a fuel.	Research, high visibility	High	Much higher potential efficiencies than harvesting biomass	Lower efficiencies than artificial photosynthesis	<1%	Distributed	1.5-3.0

**Table 2:** Summary of solar hydrogen fuel pathways

<sup>4</sup> From (Styring 2012), (Spath et al. 2003)

<sup>5</sup> From (Mason & Zweibel 2008)

<sup>6</sup> From (Jacobson 2009), (Ginley et al. 2008)

<sup>7</sup> From (Rajeshwar et al. 2010); Efficiency and cost numbers from (Hammache & Bilgen 1988) adjusted to 2012

<sup>8</sup> Estimated based on talks with researchers at Sun Catalytix

<sup>9</sup> From (Styring 2012), (Rajeshwar et al. 2010)

## 4. MARKETS FOR DISTRIBUTED SOLAR HYDROGEN SYSTEMS

*“To truly transform our economy, protect our security, and save our planet from the ravages of climate change, we need to ultimately make clean, renewable energy the profitable kind of energy.”*

*– Barack Obama*

An economy where the primary energy carrier is a solar fuel such as hydrogen<sup>10</sup> (or methanol) has long been considered close to the ideal solution to the global energy problem introduced in **Chapter 2**. However, given the scale of investments tied in the existing fossil fuel based energy infrastructure, a full-fledged hydrogen economy is unlikely to be realized in the short-to-medium term (Romm 2005). On the other hand, such a change towards introducing significant share of solar fuels to the energy mix is unlikely to come about automatically, unless active steps are taken in the short-term to move in that direction. It is therefore critical to,

- a. Identify “transition markets” in the short term that facilitate the continued research and development of solar fuel systems.
- b. Assess the potential for distributed solar fuel systems identified in chapter 3 to meet the needs of these transition markets.

This chapter would identify the most promising near-term transition market in the U.S, as well as the most promising near-term distributed hydrogen pathway that best satisfies the needs of this segment. This will be achieved as follows.

1. In the recent past, detailed studies to identify transition markets in the U.S for Proton Exchange Membrane (PEM) fuel cells<sup>11</sup> have been undertaken by the U.S Department of Energy (Mahadevan et al. 2007)(Grasman et al. 2010). The key applications identified in those studies and their energy-related needs will be briefly summarized.
2. Each energy requirement identified for every transition market is then weighted<sup>12</sup> based on the intensity of the need.

---

<sup>10</sup> Popularly referred to as the “hydrogen economy”

<sup>11</sup> A fuel cell is a device that combines hydrogen with atmospheric oxygen to produce electricity.

<sup>12</sup> The weights are subjective - derived from the description of the needs in the referenced studies

3. Thereafter, the extent to which those needs could be addressed by solar electrolytic systems as well as artificial photosynthesis systems is analyzed in a “needs-to-solution matrix”.
4. Finally, the sum products of the results from 2) and 3) above reveal the most promising near-term transition application and the pathway that best satisfies the related needs.

A limitation of the above approach is that the results in step 4 are sensitive to the assignment of weights in steps 2 and 3. Discussing the results with various experts on solar fuel research at MIT mitigated this limitation.

### 4.1 Key Transition Markets in U.S for Fuel Cells

Before delving into potential application areas, it is useful to capture the energy-related needs of a consumer and their link to the value-adding functions of any distributed solar fuel system. This is visualized using the Object-Process Methodology (Dori 2002) in **Figure 14**. The goal of the system can be stated as:

*To generate cheap, clean energy by splitting water inexpensively, cleanly and durably using a “water-splitting system”.*

#### **Desired Attributes of a Solar Fuel System**

Lower capital cost  
 Lower operational costs  
 Reliability  
 Emissions  
 Startup time  
 Durability (lifetime)  
 Ease of use  
 Space intensity  
 Long run-times  
 Fuel flexibility  
 Quietness

#### **Availability in short-term\***

\* Analysis done with an without this attribute

The “water-splitting system” is further decomposed into “antenna”, “fuel separator” and “fuel storage” sub-systems, which are instruments of the sub-functions “collecting solar energy”, “storing energy in chemical bonds” and “collecting fuel” respectively. The most desirable attributes of the “water-splitting system” are then derived and shown in **Table 3**. These are considered for subsequent analysis of its different markets and applications.

**Table 3:** Attributes in evaluating solar fuel applications and generation technology

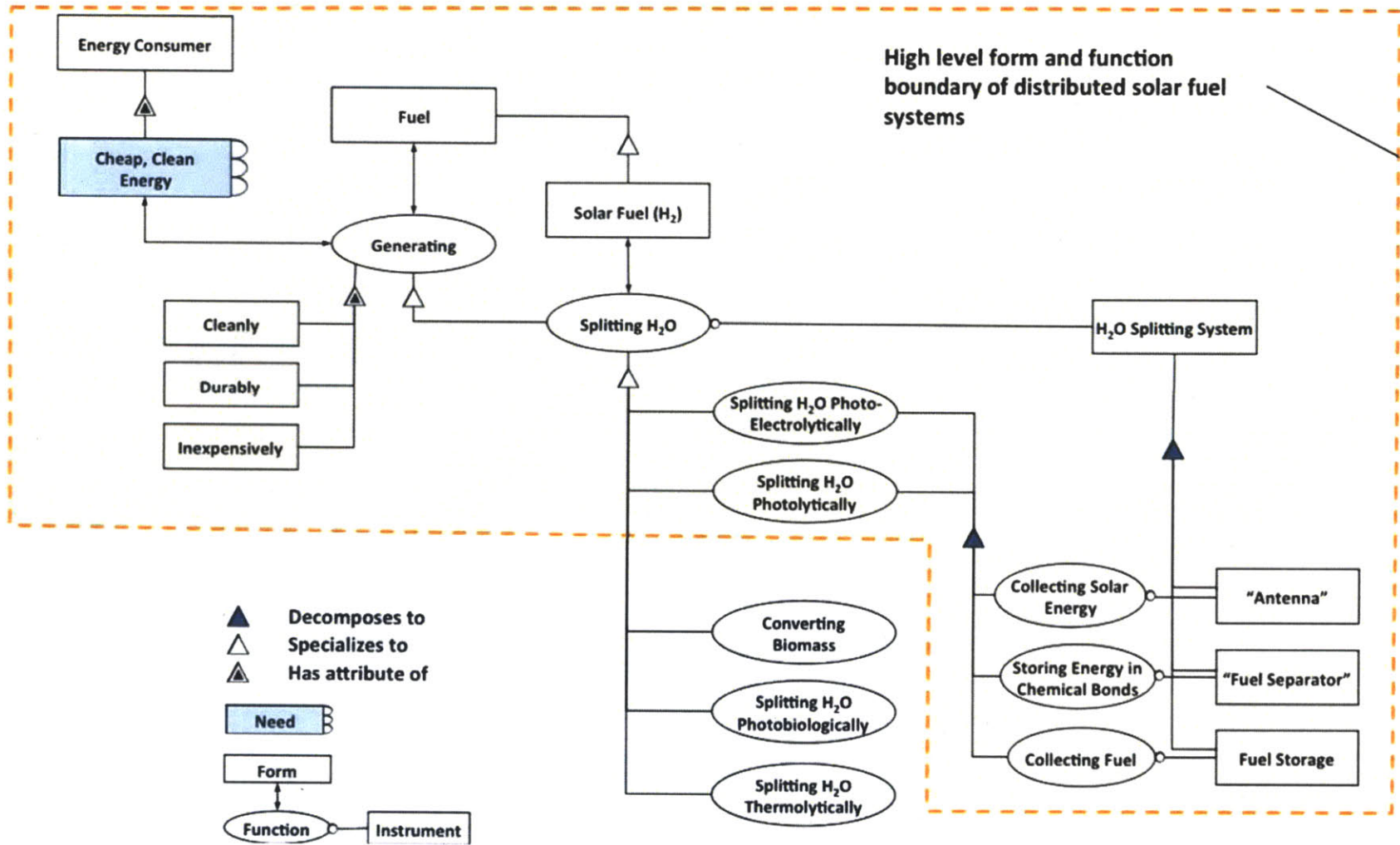

Figure 14: Key form and functional elements of distributed solar fuel systems represented using OPM

In a study conducted by the U.S DOE (Mahadevan et al. 2007) on near- and medium-term transition markets for PEM fuel cells (based on a comprehensive survey of over 100 customers worldwide to assess potential near-term and future markets), certain key application areas were identified, the top four of which are briefly summarized below. The ability of photovoltaic electrolysis and artificial photosynthesis systems to meet the most important needs for each of the top four applications is then assessed. For the applications identified in the afore-mentioned study, the availability of the systems in the short term is critical.

It is important to note again that artificial photosynthesis systems are still in development. Several key engineering challenges such as increasing system efficiency, ability to collect fuel, system durability and ease of installation and operation will need to be addressed in the future. Photovoltaic electrolysis systems, on the other hand, are commercially available, and are expected to become cheaper due to incremental improvements in the efficiency and manufacturing technology of the solar cells and electrolyzers. Even though this fact could rule out artificial photosynthesis as a solution in the near term, it's still useful to look at both systems in terms of their pure potential to meet applications needs.

This analysis is therefore carried out for two cases:

- a. Disregarding availability of required technology in short-term
- b. Considering the availability of technology in short-term

Case a) assumes that both technologies are available today with their projected efficiency and durability targets. This reveals the potential of a given distributed solar hydrogen technology to meet application needs if availability were not an issue. Case b) assesses the technologies considering their short-term availability. It is also assumed that the systems are deployed in locations with average solar insolation of 4 kWh/m<sup>2</sup>/day or more for most of the year.

#### **4.1.1 BACKUP POWER FOR TELECOMMUNICATIONS**

Telecommunication service providers are mandated by telecom regulations to provide very high levels of uptime (99.999 to 99.99999%) and quality of service. Backup power

is therefore extremely critical to their operations to ensure reliability of service during power outages. Moreover, in relation to other markets explored, telecom operators are found to be willing to pay more to secure reliable service. In backup applications, efficiency is not as critical as reliability and availability of the system. Fuel cells in these applications provide longer runtimes than batteries and are much cleaner than diesel generators which are the incumbent solution for long outages. Fuel cells also have low operations and maintenance requirements, and have no emissions as compared to generators. The frequency of outages varies between six to 25 outages per year. The duration of the outages varies between a few seconds to 12 hours.

#### **4.1.2 BACKUP POWER FOR EMERGENCY RESPONSE COMMUNICATIONS**

The emergency response market segment is comprised of state and local agencies that are responsible for providing or coordinating emergency response services, including: fire agencies, police agencies, emergency medical services, and state emergency management agencies. The impact of power outages on this market segment can be catastrophic.

Emergency preparedness and response operations depend on the reliability and quality of first responders' energy supplies. If primary grid power goes down, so can 911 and state emergency communication centers, first responder stations, hospitals, control centers, traffic signals, public transportation, and vital infrastructure such as water pumping and filtration systems. Backup power is primarily used to support 911 call centers, including the equipment required to operate computer-aided dispatch units; radio network infrastructure, including radio and microwave transmitter sites; basic facility operations; and emergency lighting. The number of Public Safety Answering Point (PSAPs) in the U.S in 2006 was estimated to be over 6000, with hundreds of towers in each state ((Mahadevan et al. 2007) pp 49-52). Several state regulations mandate the use of backup power. Not surprisingly, system reliability and fuel availability was identified as the most desirable characteristics of the backup system. The frequency of outages ranged between no outages and 25 outages per year. Capacities for radio towers ranged between >5 kW to 300 kW.

#### **4.1.3 SPECIALTY VEHICLES – FORKLIFTS IN DISTRIBUTION CENTERS**

PEM fuel cells can provide complete power for specialized equipment and vehicles such as forklifts, industrial movers, and motorized scooters, in lieu of batteries or internal combustion engines (ICEs). These applications operate in indoor and outdoor environments and are used typically to transport people or goods. PEM fuel cells in these applications are typically less than 100 kW and are expected to operate between 2,000 and 5,000 hours per year. Many specialty vehicles are expected to have long runtimes, low emissions (since many of the vehicles operate indoors), and easy start-up (Mahadevan et al. 2007). Trends in this market segment indicate that users are concerned about the maintenance and safety aspects of lead-acid batteries. Other factors that are important include the lifetime of the unit, the availability and affordability of fuel, ease of use and low total cost of ownership. Existing infrastructure for hydrogen delivery was identified as one of the barriers for fuel cell adoption, which argues in favor a distributed, self-contained solar fuel generation system. The forklift battery market in the U.S was estimated in 2007 to be over \$1 billion (Mitchell 2007). The need for fuel flexibility – the ability to generate hydrogen from other sources of electricity – is perceived to be high since lack of fuel decreases downtime of the fleet.

#### **4.1.4 GROUND SUPPORT EQUIPMENT (GSE) IN AIRPORTS**

The airport GSE market is comprised of various types of specialty vehicles used to service aircraft during ground operations. Examples of GSE that are commonly used in airport operations include baggage tractors (or “tugs”), aircraft pushback loaders, belt loaders, cargo loaders, forklifts, utility vehicles and ground powered units. The total population of baggage tractors alone in 2006 was estimated to be approximately 14,000 baggage tractors; for pushback tractors it was estimated to be about 3,600 units. The annual sales were estimated to be over \$2.5 billion.

Minimal maintenance requirements and reliability are particularly attractive to the airline industry, which is extremely susceptible to the financial and schedule-related impacts of equipment downtime. There’s also been a trend since the early 2000s to move away from ICE-powered vehicles towards battery-powered vehicles. This is because air quality is a

major concern at airports, particularly within terminal buildings where a significant amount of baggage and cargo handling takes place. Fuel cells in this market (and specialty vehicle segment in general) are expected to be used almost continuously, which therefore is expected to bring down the cost of hydrogen even more relative to the backup power markets.

#### **4.1.5 ABILITY OF DISTRIBUTED SOLAR FUEL SYSTEMS TO MEET APPLICATION NEEDS**

Both photovoltaic electrolysis (PVES) and artificial photosynthesis (APS) systems can meet the reliability and long run time needs equally well and much better than generators or batteries. The emissions from these systems are very low<sup>13</sup> when compared to alternatives - diesel generators, batteries or even fuel cells that operate using hydrogen generated via reformation of natural gas. The sensitivity analyses conducted on the total lifecycle cost of PEM fuel cells indicate the latter to be most sensitive to hydrogen costs and the life of the fuel cells (Mahadevan et al. 2007). This indicates tremendous potential for durable, distributed solar hydrogen systems, since the cost of hydrogen in these systems is fixed (and close to zero) after the system is purchased.

A general disadvantage of distributed solar fuel systems is space intensity. These systems need large open areas to place the solar collectors. This could be a constraint in many applications in the near term. This, however, is assumed to be less of a problem in telecommunication towers located in remote areas, since the cost of leasing additional land is very low. This is also expected to be less of a problem in airports and warehouses using specialty vehicles due to the availability of large roof areas, which could be used to install solar modules.

The capital costs as well as the carbon emissions of PVES is expected to be more than that of the APS due to the added cost and CO<sub>2</sub> emissions that come with the electrolyzer. APS is also expected to be easier to operate due to lower system complexity. On the other

---

<sup>13</sup> There are emissions in upstream processes in the manufacture of electrolyzers and solar panels, but these are expected to be much lower than that for alternatives when spread over the life of the system.



hand, APS is expected to fare worse in space intensity (the amount of space required to install the system) due to lower overall efficiency (and hence the need for larger solar panels). PVES fares better in fuel flexibility since the electrolyzer can also be operated using any other source of electricity (see system architecture in **Figure 9**), while in APS the “electrolyzer” is embedded in the panel (c.f., **Figure 12**).

The results from the analysis are summarized in **Table 4**. The key findings are as follows.

- a. Backup power for telecom sector is found to be most compelling application for distributed solar hydrogen systems.
- b. The photovoltaic electrolysis system is the most promising distributed solar hydrogen system in the short term.
- c. If the projected medium-term performance and cost targets are met, the artificial photosynthesis system could provide even more value when compared to photovoltaic electrolysis system.

Detailed analysis of photovoltaic electrolytic systems providing backup power for a telecommunication tower is undertaken in **Chapter 5** and **Chapter 6**.

Applications & Markets		Stationary		Non-stationary				Technology	
		Backup Power - Telecom (2-200 kW)	Backup Power - Emergency Response Communications (5-300 kW)	Speciality Vehicles - Fork lifts	Speciality Vehicles - Ground support equip. in airports	Photovoltaic Electrolytic System (PVES)	Artificial Photosynthesis System (APS)		
Needs		Need Intensity (1-5; higher=better)							
		[A]	[B]	[C]	[D]	Ability to satisfy need (1=best)			
		[1]	[2]	[1]	[2]	[1]	[2]	[1]	[2]
Lower capital cost		3	4	2	4	0.5	1.0		
Lower operational costs		4	4	5	5	0.6	1.0		
Reliability		5	5	3	4	1.0	1.0		
Emissions		3	2	4	4	1.0	1.0		
Startup time		4	4	3	3	0.8	0.4		
Durability (lifetime)		5	5	4	4	0.8	0.8		
Ease of use		4	3	4	3	0.4	0.6		
Space intensity		3	4	2	4	0.4	0.4		
Long run-times		5	5	5	5	1.0	1.0		
Fuel flexibility		4	4	5	5	1.0	0.8		
Quietness		3	2	4	2	1.0	1.0		
Availability in short-term [V]		5	5	5	5	4.0	0.05		
		Weighted ability of technology [X] to meet needs of app [Y]							
		PVES	APS	PVES	APS	PVES	APS	PVES	APS
		$\Sigma[A]*[1]$	$\Sigma[A]*[2]$	$\Sigma[B]*[1]$	$\Sigma[B]*[2]$	$\Sigma[C]*[1]$	$\Sigma[C]*[2]$	$\Sigma[D]*[1]$	$\Sigma[D]*[2]$
Without [V]		33.9	35.4	32.4	34.2	33	34.6	33.4	35.8
With [V]		53.9	35.65	52.4	34.45	53	34.85	53.4	36.05

**Table 4:** Results of need analysis for distributed solar fuel systems. Backup power for telecom towers is found to be the most compelling application for distributed solar fuel systems. While APS potentially offers more value, it is ruled out due to unavailability in short-term.

## 5. ECONOMIC ANALYSIS OF HYDROGEN PRODUCTION VIA DISTRIBUTED PHOTOVOLTAIC ELECTROLYSIS SYSTEMS

*All models are wrong, but some are useful.*  
- George E P Box

### 5.1 Motivation and Methodology for Economic Analysis

Perhaps one of the most critical criteria for the commercial success of a small-scale distributed solar hydrogen system is the economics of the system, or, to be more specific, the cost of delivered hydrogen, spread over the life of the system<sup>14</sup>. Chapter 4 motivated the need for distributed, small-scale solar hydrogen systems as a means to facilitate widespread adoption of hydrogen-based systems by 2030.

A number of studies have tried to estimate the cost of solar hydrogen production for medium-to-large scale systems<sup>15</sup>.

(Steward et al. 2009) estimated the cost of hydrogen for transportation applications at two production levels – 1400 kg/day<sup>16</sup> and 12000 kg/day – and compared them with the use of several battery systems. The cost of hydrogen was found to be between \$3.33 - \$7/kg depending on the scale of production. In general hydrogen systems were found to be competitive with battery systems for the selected applications.

(Ogden and Williams 1990) found the cost of large-scale PV hydrogen production at capacities between 10-100 MWp to be \$9.1-14/GJ<sup>17</sup>.

(Ivy 2004) provided a technical and economic overview of commercially available electrolytic hydrogen systems as of 2003. Assuming the source of electricity to be exogenous, the paper analyzed these systems at three distinct scales: a small

---

<sup>14</sup> This metric is also referred to as Levelized Cost of Energy (LCOE)

<sup>15</sup> See (Steward et al. 2009)(Ogden & Williams 1990)(Levene et al. 2005)(Ivy 2004)(Mason & Zweibel 2008)

<sup>16</sup> Energy content of 1 kg H<sub>2</sub> = 39.4 kWh (HHV) or 33.3 kWh (LHV)

<sup>17</sup> 1 GJ = 277.78 kWh (approx.)

neighborhood (~20 kg/day), a small forecourt (~100 kg/day), and a forecourt size (~1000 kg/day). The hydrogen costs were found to be \$19.01/kg H<sub>2</sub>, \$8.09/kg H<sub>2</sub> and \$4.15/kg H<sub>2</sub> respectively in 2005 dollars with electricity costs being a major contributor in each case.

(Mason & Zweibel 2008) estimated the cost of large centralized PV hydrogen for vehicular markets. Assuming large capital investment reductions resulting from the 60-year life of balance of systems equipment, the costs were seen to come down to 3.90-3.40/kg H<sub>2</sub> for 10-14% efficient PV modules. The total lifecycle GHG emissions were 2.6-kg CO<sub>2</sub>-eq/kg of delivered H<sub>2</sub>.

However no systematic analysis of small-scale solar hydrogen systems exists in the public domain today, especially regarding their economic feasibility. This chapter attempts to fill this gap. Such an analysis would be valuable for at least a couple of reasons:

- a. It puts a “stake in the ground” - allowing for meaningful comparison of costs of current and future alternatives for distributed production of hydrogen from solar, such as artificial photosynthesis systems that are currently in development.
- b. The analysis, while focusing on a specific technology and application, is expected to reveal some key insights about distributed solar fuel systems in general which could inform the development of future distributed systems.

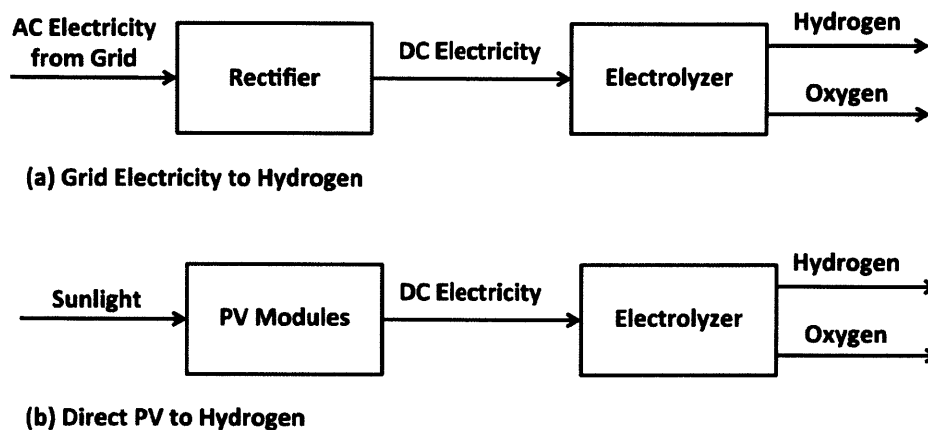

Figure 15: Hydrogen pathways considered for the analysis

The analysis is presented in the following steps.

1. To keep the comparison simple, distributed backup power for telecommunication towers is fixed as the application to be used for the analysis. The latter was shown to be the most compelling near term application in **Chapter 4**; the telecommunication system offers a good market due to lower load profiles and long runtimes, the need for reliability and greater durability in hard outdoor environments.
2. A widely used and accepted reference case – generating hydrogen from electrolysis using grid electricity – is described. An alternative system design that generates hydrogen using photovoltaic electricity is compared against the reference case. A schematic showing the hydrogen pathways considered are shown in **Figure 15**. The primary figure of merit used to compare the two use cases is *Levelized Cost of Energy (LCOE)*<sup>18</sup>.
3. The key variables that affect the LCOE are defined in a model. For each of the two cases described above a parametric analysis is undertaken.
4. In order to understand the effect of scale, the above analysis is undertaken for systems of three different power output capacities – 10, 50 and 1000 kW.
5. The number of hours that a backup system operates in a month has a big effect on the capital cost of the system, the amount of hydrogen generated and, consequently, the LCOE. In order to understand this, for each of the above system configurations, two scenarios are considered: when the duration between two successive grid power outages is on average,
  - a. 2 days (the range being 1 – 3 days)
  - b. 15 days (the range being 1 – 30 days)

## **5.2 Telecommunication Backup System Needs and Assumptions**

The compelling need for backup power in telecommunications systems has been well established in **Chapter 4**. To briefly summarize, long outages in these markets are very disruptive and can have significant economic impact. Hence, reliability and availability of the backup applications are critical in these markets. Hydrogen-powered fuel cells in

---

<sup>18</sup> The definition of LCOE is taken from (Branker et al. 2011)

these applications provide longer runtimes than batteries. Fuel cells also have low operations and maintenance requirements, and have no harmful emissions as compared to generators.

In this analysis we consider backup system needs of mobile phone repeater stations that are connected to the electricity grid, but located in remote locations. Power interruptions in such locations are common and telecommunication systems require autonomy of up to 24 hours. A typical telecom site can host radio equipment of one to six mobile phone operators with backup power capacity of up to 10 kW each. The cost of producing renewable hydrogen “in situ” for such sites of different sizes is important in order to assess the potential for displacing existing dirty sources of backup power.

We consider hydrogen needs of backup systems of 3 different capacities:

1. 10 kW – one telecom site hosting one mobile operator
2. 50 kW – one telecom site hosting 5 mobile operators of 10 kW each
3. 1000 kW – To understand the effects of scaling up slightly within a region, aggregation of hydrogen needs of 20 adjacent sites like 2) above within a telecom circle of approximately 50 km is investigated.

For each of the 3 systems above LCOE of hydrogen from PV electrolysis is compared with hydrogen from grid electrolysis<sup>19</sup>. A simplified energy and material flow diagram of the two systems is shown in **Figure 16**. To understand the effect of frequency of power outages (and hence demand for hydrogen) on LCOE, duration between two successive power outages of 1-3 days and 1-30 days are considered.

---

<sup>19</sup> The design of a hydrogen-based backup system for telecom applications can be found in (Varkaraki et al. 2003)

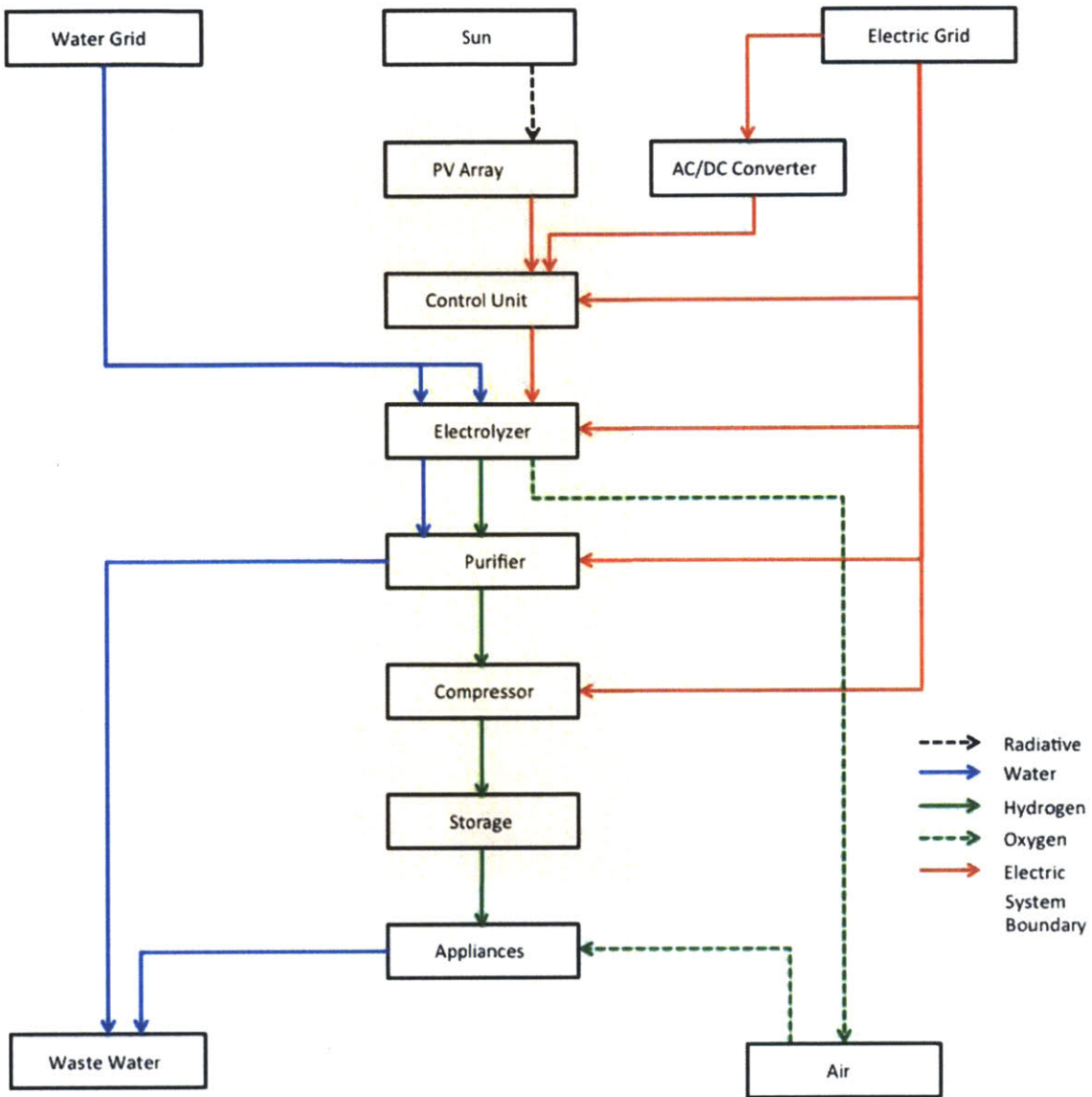

**Figure 16:** Energy and material flows for the PV and grid electrolysis systems<sup>20</sup>

### 5.3 System Assumptions

Some of the important technical and economic assumptions made are as follows:

- a. A lifetime of 25 years is assumed for the entire system. Resale value is assumed to be zero.
- b. The PV electrolyzer system is assumed to operate on DC. Hence there is no need for DC-AC or AC-DC equipment.

<sup>20</sup> Adapted from (Hollmuller et al. 2000)(Vidueira et al. 2003)

- c. No separate compressor system is required. It's assumed that the electrolyzer will deliver compressed hydrogen gas at ~2400 psig and stored at the delivered pressure in stainless steel above-ground tanks.
- d. The oxygen from the system is vented. Its economic value is not accounted for.
- e. Fuel cells and other appliances are considered outside the system in this analysis since the analysis looks at hydrogen production. Their costs are therefore not considered.
- f. Cost of money and depreciation is not considered.
- g. The cost of land is assumed to be negligible, since the systems are assumed to be located in remote areas.

## 5.4 Scenarios being compared

We compare 12 scenarios based on the hydrogen pathway, the scale of system and reliability of grid electricity (which affects the quantity of hydrogen produced). These scenarios are summarized in **Table 5**.

	Duration between successive power outages (1 - 3 days) - Unreliable grid supply		Duration between successive power outages (1 - 30 days) - Reliable grid supply	
	Renewable hydrogen (PV + Electrolyzer)	Non-renewable (Grid + Electrolyzer)	Renewable hydrogen (PV + Electrolyzer)	Non-renewable (Grid + Electrolyzer)
<b>Single Operator - Single Tower (10 kW)</b>	Small-scale, renewable hydrogen on unreliable grid	Small-scale, non-renewable hydrogen on unreliable grid	Small-scale, renewable hydrogen on reliable grid	Small-scale, non-renewable hydrogen on reliable grid
<b>Multiple Operators - Single Tower (50 kW)</b>	Medium-scale, renewable hydrogen on unreliable grid	Medium-scale, non-renewable hydrogen on unreliable grid	Medium-scale, renewable hydrogen on reliable grid	Medium-scale, non-renewable hydrogen on reliable grid
<b>Aggregated hydrogen production for locality (1000 kW)</b>	Aggregated-scale, renewable hydrogen on unreliable grid	Aggregated-scale, non-renewable hydrogen on unreliable grid	Aggregated-scale, renewable hydrogen on reliable grid	Aggregated-scale, non-renewable hydrogen on reliable grid
<b>Key</b>	Reliability of grid	Hydrogen pathway	Scale of electrolyzer	

**Table 5:** Hydrogen production scenarios considered based on hydrogen pathway, scale of the system and reliability of grid electricity

## 5.5 Model Inputs and Assumptions

The model used for the analysis is based on the NREL H2A model (Genevieve Saur 2008)(Genovese et al. 2009).



**Table 6** outlines the input parameters used in the model.

Inputs							
Assumptions & References	Variables	PV + Electrolyzer			Grid Electricity + Electrolyzer		
		1000 kW	50 kW	10 kW	1000 kW	50 kW	10 kW
<b>System Specifications</b>							
<b>Overall</b>							
a	Average power requirement (kW)	1000	50	10	1000	50	10
b	Estimated max. length of outages (hours)	24	24	24	24	24	24
c	Estimated time between outages (days)	15.00	15.00	15.00	15.00	15.00	15.00
d	Average hours of sunshine per day (hours)	6	6	6	6	6	6
e	Lifetime of system (years)	25	25	25	25	25	25
f	System degradation rate (%)	0.5%	0.5%	0.5%	0.5%	0.5%	0.5%
g	System capacity factor (%)	20%	20%	20%	98%	98%	98%
h=a*b	Backup energy needed (kWh)	24,000.00	1,200.00	240.00	24,000.00	1,200.00	240.00
<b>Fuel Cell</b>							
i	Fuel cell efficiency	50%	50%	50%	50%	50%	50%
<b>Storage</b>							
J	Safety Factor	1.2	1.2	1.2	1.2	1.2	1.2
k=(h*j)/(i*39.4)	Quantity of hydrogen to be stored (Kg)	1461.93	73.10	14.62	1461.93	73.10	14.62
<b>Electrolyser</b>							
l	Electrolyzer efficiency (%)	63%	63%	63%	63%	63%	63%
m=k/(c*g*24)	Electrolyzer output (Kg of H <sub>2</sub> /hour)	20.30	1.02	0.20	20.30	1.02	0.20
n	Electrolyzer output (Kg of H <sub>2</sub> /day)	97.46	4.87	0.97	97.46	4.87	0.97
o	Electrolyzer output per year (Kg H <sub>2</sub> /year)	35,573.60	1,778.68	355.74	35,573.60	1,778.68	355.74
p=2.939*3.7854	Feed water consumption (Liters/Kg H <sub>2</sub> )	11.13	11.13	11.13	11.13	11.13	11.13
<b>Solar Panels</b>							
q	Solar BOS efficiency (%)	80%	80%	80%	n/a	n/a	n/a
r=(m*39.4)/(l*q)	Solar panel output (kW)	1,587.30	79.37	15.87	n/a	n/a	n/a
<b>Grid Electricity</b>							
s	Grid Electrical Energy / hour (kWh)	-	-	-	1,269.84	63.49	12.70

- a See section "Telecommunication Backup System Needs and Assumptions"
- b Assumed duration of a prolonged grid power disruption
- c Determines how frequently backup system operates. Two cases 1-3 and 1-30 days are considered
- d A geographic location with high solar insolation levels such as California assumed
- e Based on survey of commercial electrolyzers and solar modules
- f Based on survey of commercial electrolyzers and solar modules
- g PV: based on 5-6 hours of sunshine; Grid: based on literature survey
- i Based on survey of commercial fuel cells
- j Assumed to account for hydrogen leakages
- k 1 kg of hydrogen (HHV) = 39.4 kWh
- l Based on assumption in H2A study (Genevieve Saur 2008)(Genovese et al. 2009)
- p Assumed feed water consumption: 2.939 gal/Kg of H<sub>2</sub> from H2A model; 1 gal=3.7854 liters
- q Assumed to account for losses in balance of system
- s=(m\*39.4)/l 1 kg of hydrogen (HHV) = 39.4 kWh

**Table 6:** Inputs parameters used in the model

Cost Assumptions							
Assumptions & References	Variables	PV + Electrolyzer			Grid Electricity + Electrolyzer		
		1000 kW	50 kW	10 kW	1000 kW	50 kW	10 kW
<b>Direct Capital Costs</b>							
a1	Cost of storage (\$/Kg)	960.00	958.37	1,075.26	960.00	1,020.00	1,150.00
b1	Cost of solar panels (\$/W peak)	5.20	5.40	6.00	-	-	-
c1	Reduction in electrolyzer BOS costs (%)	30%	30%	30%	0%	0%	0%
d1	Cost of electrolyzer (\$)	1,002,882	158,612	58,891	538,601	85,183	31,628
e1	Incentives on solar (% of panel cost)	30%	30%	30%	0%	0%	0%
<b>Indirect Capital Costs</b>							
f1	Site preparation (% of total capital costs)	1%	1%	1%	1%	1%	1%
g1	Engineering and design (% of capital costs)	5%	5%	5%	5%	5%	5%
h1	Project contingency (% of capital costs)	10%	10%	10%	10%	10%	10%
i1	Upfront permitting costs (% of capital costs)	1%	0%	0%	1%	0%	0%
j1	Production maintenance and repairs (% of capital costs)	5%	0%	0%	5%	0%	0%
k1	Working Capital (% of direct capital costs)	1%	1%	1%	1%	1%	1%
l1	Building costs	10%	10%	10%	10%	10%	10%
<b>Fixed Operating Costs</b>							
m1	Insurance (% of total capital costs)	2%	2%	2%	2%	2%	2%
n1	O&M expenses (% of direct capital costs)	5%	5%	5%	5%	5%	5%
o1	Cell replacement (% of electrolyzer cost)	0%	0%	0%	30%	30%	30%
<b>Variable Operating Costs</b>							
p1	Feed water cost (\$/Liter)	0.000811	0.000811	0.000811	0.000811	0.000811	0.000811
q1	Grid electricity cost (\$/kWh)	0	0	0	0.053	0.053	0.053

- a1 Based on (Wade A Amos 1998) brought to present day and survey of commercial storage vendors
- b1 From (Barbose et al. 2011); includes BOS costs
- c1 The cost of transformer and rectifier is assumed to be 30% of capital cost of electrolyzer
- d1 = Electrolyzer capital cost is calculated using the following equation from (Genevieve Saur 2008) page 15:  
 $224.49 * m^{0.6156} * 1000 * (1 - c1)$   
 $y = 224.49 * x^{0.6156}$   
 where y=capital cost of electrolyzer in '000 \$ and x=Kg H<sub>2</sub>/hr.  
 The capital cost includes BOP costs. For PV electrolyzer the cost of transformer and rectifier (specified in c1) is subtracted since it is assumed to work on DC.
- e1 Assumed based on typical incentives for solar
- f1 to o1 Based NREL H2A model (Levene et al. 2005)(Genevieve Saur 2008)(Genovese et al. 2009)
- p1 It is assumed that cost of cell replacement for grid-connected electrolyzers is 30% of capital cost every 8 years ((Genovese et al. 2009) page 24). No replacement costs are assumed for PV electrolyzers due their lower capacity factor (and hence lower usage).
- q1 to r1 Based NREL H2A model (Levene et al. 2005)(Genevieve Saur 2008)(Genovese et al. 2009)

**Table 7:** Cost assumptions used in the model

Cost Calculations							
Assumptions & References	Variables	PV + Electrolyser			Grid Electricity + Electrolyser		
		1000 kW	50 kW	10 kW	1000 kW	50 kW	10 kW
<b>Direct Capital Costs</b>							
a2=k*a1	Total cost of storage (\$)	1,403,452	70,053	15,719	1,403,452	74,558	16,812
b2	Cost of electrolyzer (\$)	802,305	126,889	47,113	430,881	68,146	25,302
c2=b1*1000*r*(1-e1)	Cost of solar panels (\$)	5,777,778	300,000	66,667	-	-	-
d2=sum(a2:c2)	Total direct capital costs (\$)	7,983,535	496,943	129,499	1,834,332	142,705	42,114
<b>Indirect Capital Costs</b>							
e2=d2*f1	Site preparation cost (\$)	79,835	4,969	1,295	18,343	1,427	421
f2=d2*g1	Engineering and design (\$)	399,177	24,847	6,475	91,717	7,135	2,106
g2=d2*j1	Production maintenance and repairs (\$)	399,177	-	-	91,717	-	-
h2=d2*k1	Working capital (\$)	79,835	4,969	1,295	18,343	1,427	421
i2=d2*l1	Building costs (\$)	798,354	49,694	12,950	183,433	14,270	4,211
j2=sum(e2:i2)	Total indirect capital costs (\$)	1,756,378	84,480	22,015	403,553	24,260	7,159
k2=d2+j2	Total capital costs (\$)	9,739,913	581,423	151,514	2,237,886	166,965	49,274
<b>Fixed Operating Costs</b>							
l2=k2*m1	Insurance (\$)	194,798	11,628	3,030	44,758	3,339	985
m2=d2*n1	Annual O&M Expenses (\$)	399,177	24,847	6,475	91,717	7,135	2,106
n2=b2*o1	Cell replacement costs (\$)	-	-	-	129,264	20,444	7,591
o2=sum(l2:m2)	Total fixed operating costs (\$)	593,975	36,476	9,505	136,474	10,475	3,091
<b>Variable Operating Costs</b>							
p2=o*p*p1	Feed water cost per annum (\$)	321	16	3	321	16	3
q2=s*24*365*g*q1	Grid electricity (\$)	-	-	-	117,912	5,896	1,179
r2=sum(p2:q2)	Total variable operating costs (\$)	321	16	3	118,233	5,912	1,182
s2=o2+r2	Total annual expenses (\$)	594,296	36,492	9,508	254,708	16,386	4,274
<b>Financing</b>							
t2	Discount rate (%)	6%	6%	6%	6%	6%	6%

- b2 The cost of electrolyzer is assumed to go down in future. Values between 60-100% of d1 with a median of ~80% are considered during sensitivity analysis.
- t2 Discount rates between 3-10% with a median of 6% are considered during sensitivity analysis.

**Table 8:** Capital and operating costs calculated using input parameters in Table 6 and cost assumptions in Table 7

LCOE is then calculated using the following formula (Branker et al. 2011):

$$LCOE = \frac{\sum_{t=0}^T \frac{C_t}{(1+r)^t}}{\sum_{t=0}^T \frac{E_t}{(1+r)^t}}$$

$$LCOE = \frac{\sum_{t=0}^T \frac{I_t + O_t + M_t + F_t}{(1+r)^t}}{\sum_{t=0}^T \frac{E_t}{(1+r)^t}} = \frac{\sum_{t=0}^T \frac{I_t + O_t + M_t + F_t}{(1+r)^t}}{\sum_{t=0}^T \frac{S_t(1-d)^t}{(1+r)^t}}$$

**Nomenclature**

- T life of the project [years]
- t Year t
- C<sub>t</sub> Net cost of project for t [\$]
- E<sub>t</sub> Energy produced for t [\$]
- I<sub>t</sub> Initial investment/ cost of the system including construction, installation etc. [\$]
- M<sub>t</sub> Maintenance costs for t [\$]
- O<sub>t</sub> Operation costs for t [\$]
- F<sub>t</sub> Interest expenditures for t [\$]
- r Discount rate for t [%]
- S<sub>t</sub> Yearly rated energy output for t [kWh/yr]
- d Degradation rate [%]

## 5.6 Analysis of Model Results

### 5.6.1 OVERALL LCOE TRENDS

Monte Carlo simulation results of the model with 100,000 runs are described below.

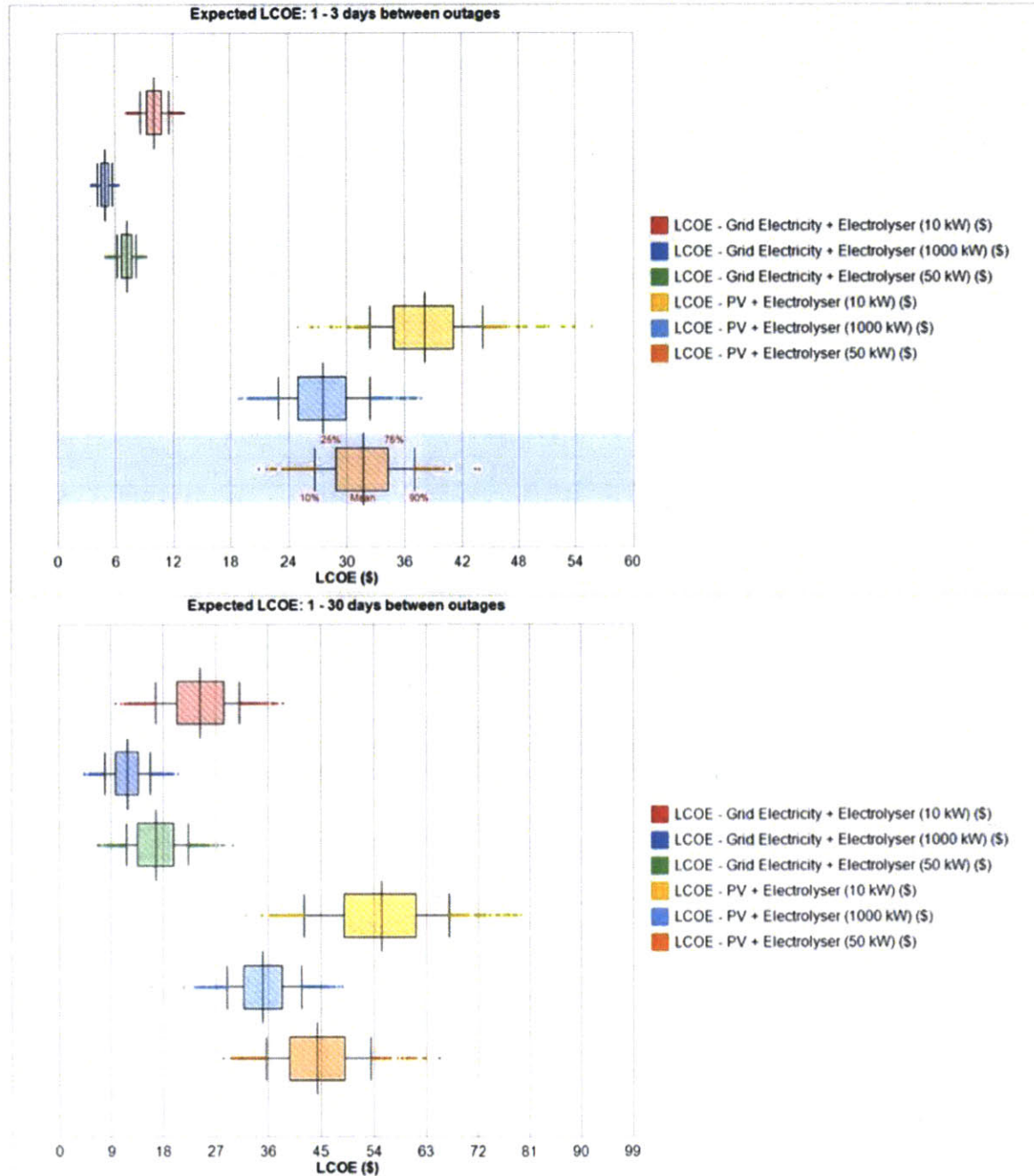

**Figure 17:** Expected LCOE values for 12 different scenarios based on pathway, scale and the reliability of grid electricity

As seen in **Figure 17** above, the expected mean LCOE values for the different scenarios shows a large range, the cheapest being 1000 kW grid-connected electrolyzer operating once every 1-3 days (\$4.95) and the most expensive being 10 kW PV electrolyzer operating once every 1–30 days (\$56.05). Based on the above results several general conclusions can be inferred from the different scenarios.

	Levelized Cost of Electricity (\$)					
	Grid + Electrolyzer			PV + Electrolyzer		
	10 kW	50 kW	1000 kW	10 kW	50 kW	1000 kW
Low	23.85	17.01	11.81	56.05	43.80	35.12
High	10.15	7.23	4.95	38.11	31.71	27.52

Key      Pathway      Scale      Quantity of H2

**Table 9:** LCOE values for the different scenarios in Table 5 as seen in Figure 17.

**Result 1:** LCOE of grid-connected electrolyzers are significantly lower than that of PV electrolyzers of a comparable scale<sup>21</sup>. This is mainly due to the increased capital cost and lower capacity factor of PV electrolyzers.

**Result 2:** LCOE decreases with scale for both PV and grid-connected electrolyzers.

**Result 3:** LCOE decreases significantly with increasing frequency of backup power needs. Higher demand for backup power leads to higher quantity of hydrogen produced, consequently lowering LCOE.

### 5.6.2 LCOE BREAKUP ANALYSIS

The cost items contributing to the LCOE are described in **Figure 18**. Taking a closer look at **Figure 18** for the main items contributing to the LCOE for each of the scenarios described in **Table 5**, we notice the following trends:

<sup>21</sup> Externalized costs of producing grid electricity are not considered in this analysis.

	Share of Feedstock Cost (%)					
	Grid + Electrolyzer			PV + Electrolyzer		
	10 kW	50 kW	1000 kW	10 kW	50 kW	1000 kW
Low	12.73%	17.84%	25.71%	0.02%	0.02%	0.02%
High	29.92%	41.98%	61.36%	0.02%	0.03%	0.03%

Key      Pathway      Scale      Quantity of H2

**Table 10:** Share of feedstock cost in LCOE for different scenarios listed in Table 5

**Result 4:** In case of grid-connected electrolyzers, feedstock costs constitute a significant portion of the LCOE costs. The share of feedstock costs increases with increasing scale and the decreasing duration between power outages (or increasing quantity of hydrogen produced). On the other hand, feedstock costs are negligible for PV electrolyzers (c.f. **Table 10**).

	Share of Capital Cost (%)					
	Grid + Electrolyzer			PV + Electrolyzer		
	10 kW	50 kW	1000 kW	10 kW	50 kW	1000 kW
Low	29.69%	23.75%	15.33%	49.71%	48.72%	48.38%
High	30.32%	23.35%	12.50%	55.04%	54.95%	55.58%

Key      Pathway      Scale      Quantity of H2

**Table 11:** Share of capital cost in LCOE for different scenarios listed in Table 5

**Result 5:** Capital cost is the overwhelming contributor to LCOE (c.f. **Table 11**) in case of PV electrolyzers (48 – 56%) but much less so for grid-connected electrolyzers (12-30%).

**Result 6:** The share of capital cost in LCOE decreases with scale for grid-connected electrolyzers, but remains roughly constant for PV electrolyzers (c.f. **Table 11**).

**Result 7:** In case of grid-connected electrolyzers, the share of capital costs in LCOE decreases with increasing quantity of hydrogen produced. Moreover, the extent of this decrement increases with scale. Contrastingly, in case of PV electrolyzers the share of

capital cost in LCOE increases with the quantity of hydrogen produced (c.f. **Table 11**). This is due to the fact that the cost of solar panels doesn't decrease as much with scale as the rest of the system.

	Share of O&M (%)					
	Grid + Electrolyzer			PV + Electrolyzer		
	10 kW	50 kW	1000 kW	10 kW	50 kW	1000 kW
Low	34.97%	33.51%	30.87%	43.71%	43.68%	42.96%
High	27.18%	22.76%	15.43%	43.68%	43.66%	42.96%

Key      Pathway      Scale      Quantity of H2

**Table 12:** Share of O&M cost in LCOE for different scenarios listed in Table 5

**Result 8:** The share of O&M costs in LCOE is much higher in case of PV electrolyzers than grid-connected electrolyzers (c.f. **Table 12**).

**Result 9:** The share of O&M costs in LCOE reduces with scale and quantity of hydrogen produced in case of grid-connected electrolyzers. It remains roughly constant in case of PV electrolyzers (c.f. **Table 12**).

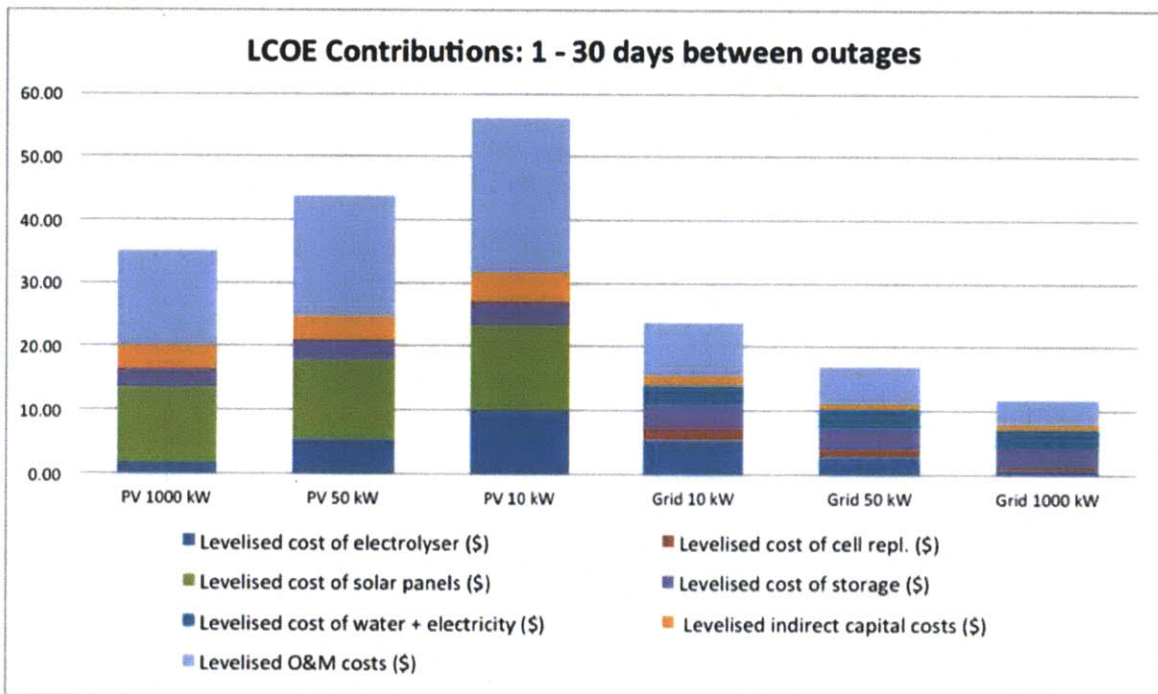
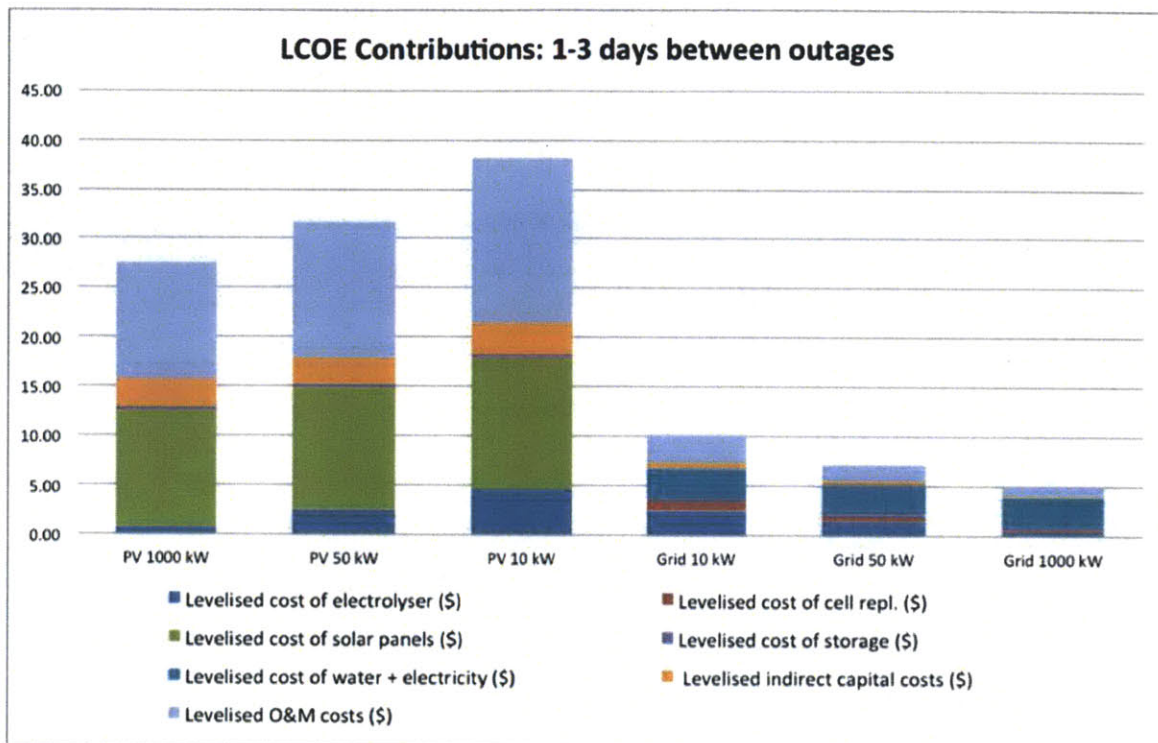

**Figure 18:** LCOE breakup for different scenarios



### 5.6.3 SENSITIVITY ANALYSIS

A sensitivity analysis was done to understand the effect of uncertainty on the LCOE for the different scenarios. The range of values used for the different uncertain parameters in the model for two of the scenarios is shown in **Table 13** below. In the absence of data about the distributions of the parameters, a triangular distribution was assumed for each variable in this analysis.

<b>PV + Electrolyser (1000 kW)</b>			
<b>Variable</b>	<b>Min</b>	<b>Most Likely</b>	<b>Max</b>
PV_1000: Estimated minimum duration between outages (days)	1	15	30
PV_1000: System capacity factor (%)	18%	20%	23%
PV_1000: Electrolyser efficiency (%)	60%	63%	70%
PV_1000: Solar BOS efficiency (%)	70%	80%	85%
PV_1000: Cost of electrolyser (\$)	60%	80%	100%
PV_1000: Cost of storage (\$/Kg)	700	960	1100
PV_1000: Cost of solar panels (\$/W peak)	4	5.2	5.6
PV_1000: Incentives on solar (% of solar panels)	20%	30%	45%
PV_1000: Total indirect capital costs (\$)	80%	100%	120%
PV_1000: Annual O&M Expenses (\$)	80%	100%	120%
PV_1000: Discount rate (%)	3%	6%	10%

<b>Grid Electricity + Electrolyser (1000 kW)</b>			
<b>Variable</b>	<b>Min</b>	<b>Most Likely</b>	<b>Max</b>
GridElec_1000: Estimated minimum duration between outages (days)	1	15	30
GridElec_1000: System capacity factor (%)	96%	98%	99%
GridElec_1000: Electrolyser efficiency (%)	60%	63%	70%
GridElec_1000: Solar BOS efficiency (%)	n/a	n/a	n/a
GridElec_1000: Cost of electrolyser (\$)	60%	80%	100%
GridElec_1000: Cost of storage (\$/Kg)	700	960	1100
GridElec_1000: Grid electricity cost (\$/kWh)	0.03	0.053	0.07
GridElec_1000: Cell replacement cost (% of electrolyser)	20%	30%	45%
GridElec_1000: Total indirect capital costs (\$)	80%	100%	120%
GridElec_1000: Annual O&M Expenses (\$)	80%	100%	120%
GridElec_1000: Discount rate (%)	3%	6%	10%

**Table 13:** Example of range of values used for sensitivity analysis. The table shows values for uncertain variables for two of the scenarios, in the case where duration between successive power outages is 1-30 days

The results from the sensitivity analysis for 4 of the 12 scenarios are shown in **Figure 19** and **Figure 20**; the rest are not shown, as they are consistent with the results below.

**Result 10:** LCOE is extremely sensitive to the duration between power outages for both grid-connected and PV electrolyzers regardless of scale. This is because the duration between outages directly affects the quantity of hydrogen produced, affecting LCOE.

**Result 11:** The sensitivity of LCOE to electrolyzer costs of both grid-connected and PV electrolyzers decreases with increase in scale and the duration between power outages. This is because as the systems get larger the share of electrolyzer cost in LCOE decreases (c.f. results 6 and 7).

**Result 12:** LCOE of PV electrolyzers is highly sensitive to the cost of solar panels, and hence incentives on solar. The sensitivity of LCOE of PV electrolyzers to solar panel cost increases with scale and decreases with the increase in duration between power outages. This is due to the increased share of solar panel cost in LCOE with increasing capacity of the system (c.f. results 6 and 7).

**Result 13:** Grid electrolyzers become increasingly sensitive to feedstock costs with increasing scale and decreasing duration between power outages. This is not surprising given result 4. PV electrolyzers are not sensitive to feedstock costs since the contribution of feedstock costs to LCOE is negligible.

**Result 14:** PV electrolyzers are more sensitive to “system capacity factor” than grid-connected electrolyzers given that solar radiation varies much more by geographical location and time of the year than availability of grid electricity.

**Result 15:** The sensitivity of LCOE to O&M of PV electrolyzers is higher than it is for grid-connected electrolyzers (follows from results 8 and 9).

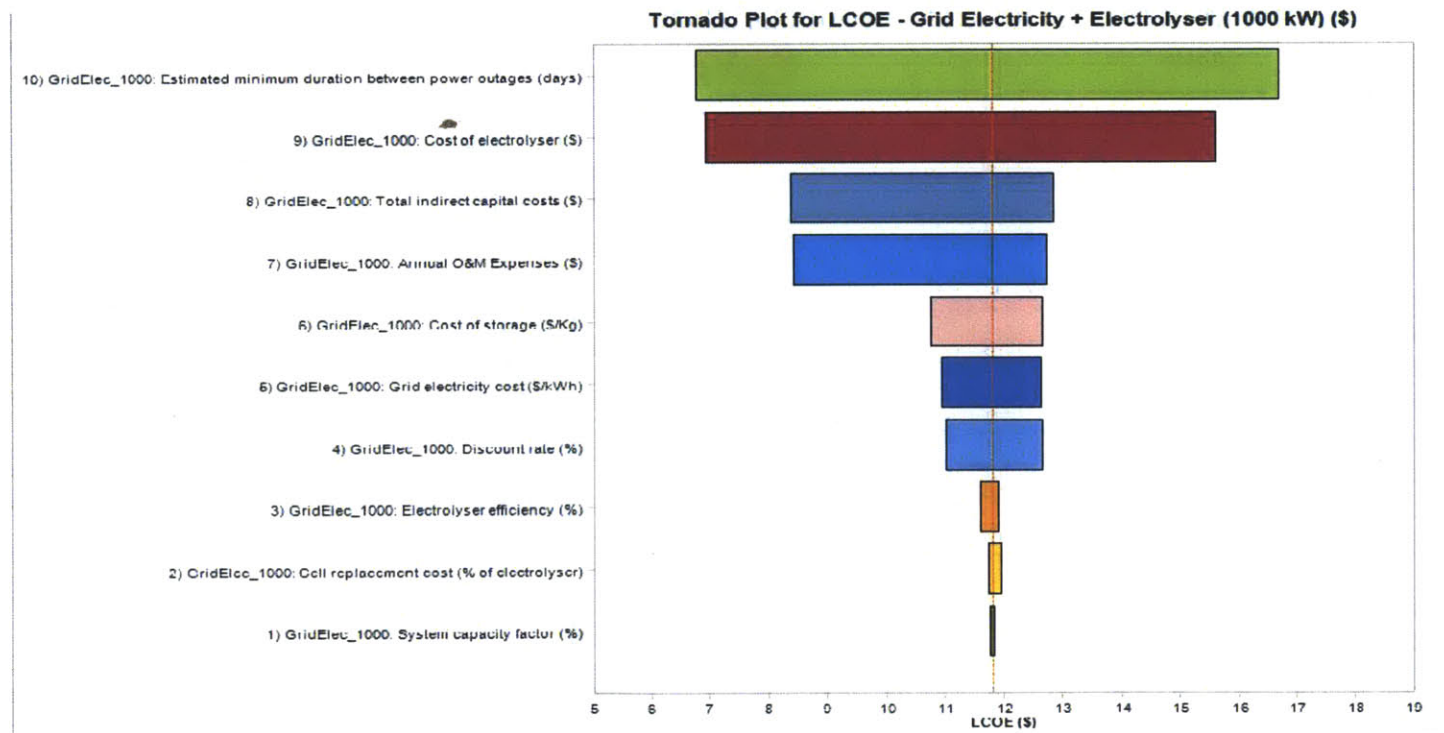
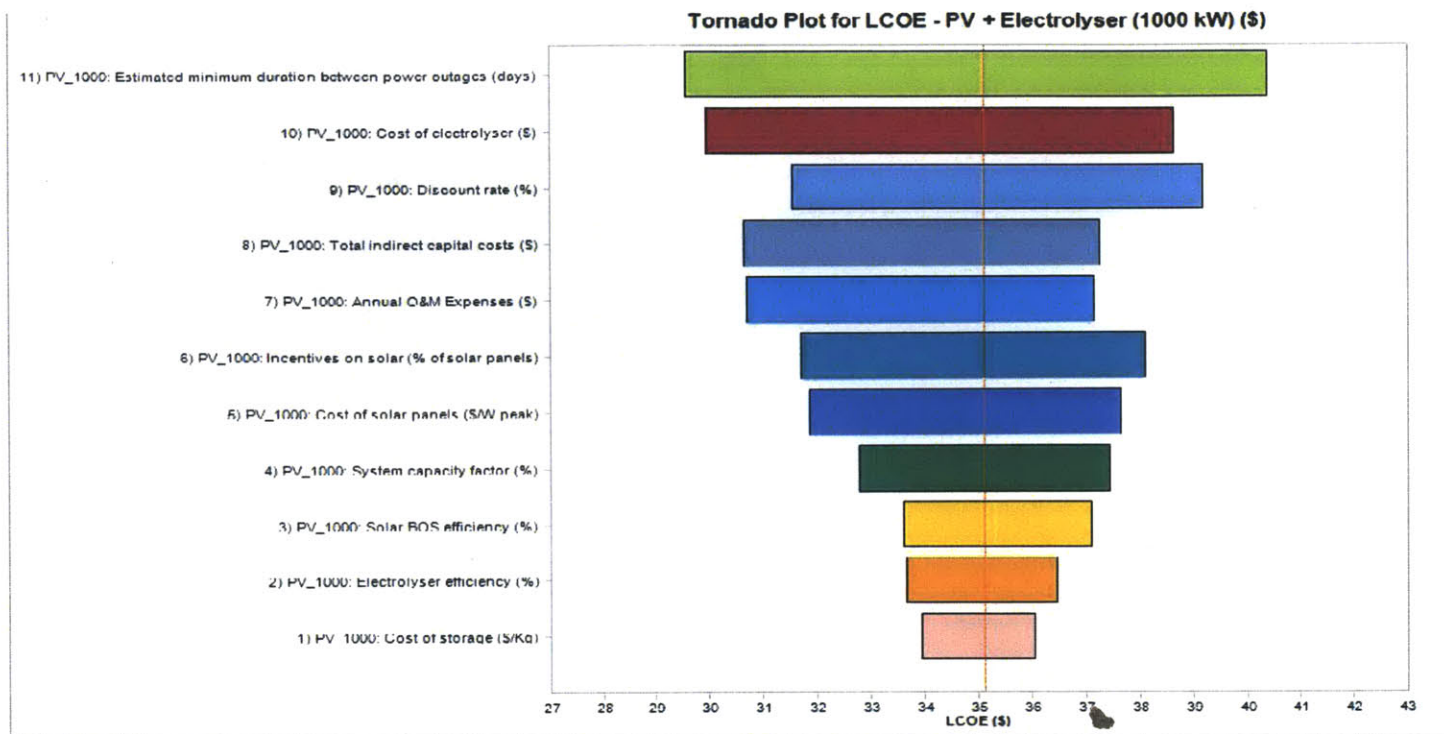

**Figure 19:** Tornado plots showing results of sensitivity analysis for 1000 kW PV and grid-connected systems when the duration between successive power outages is 1–30 days

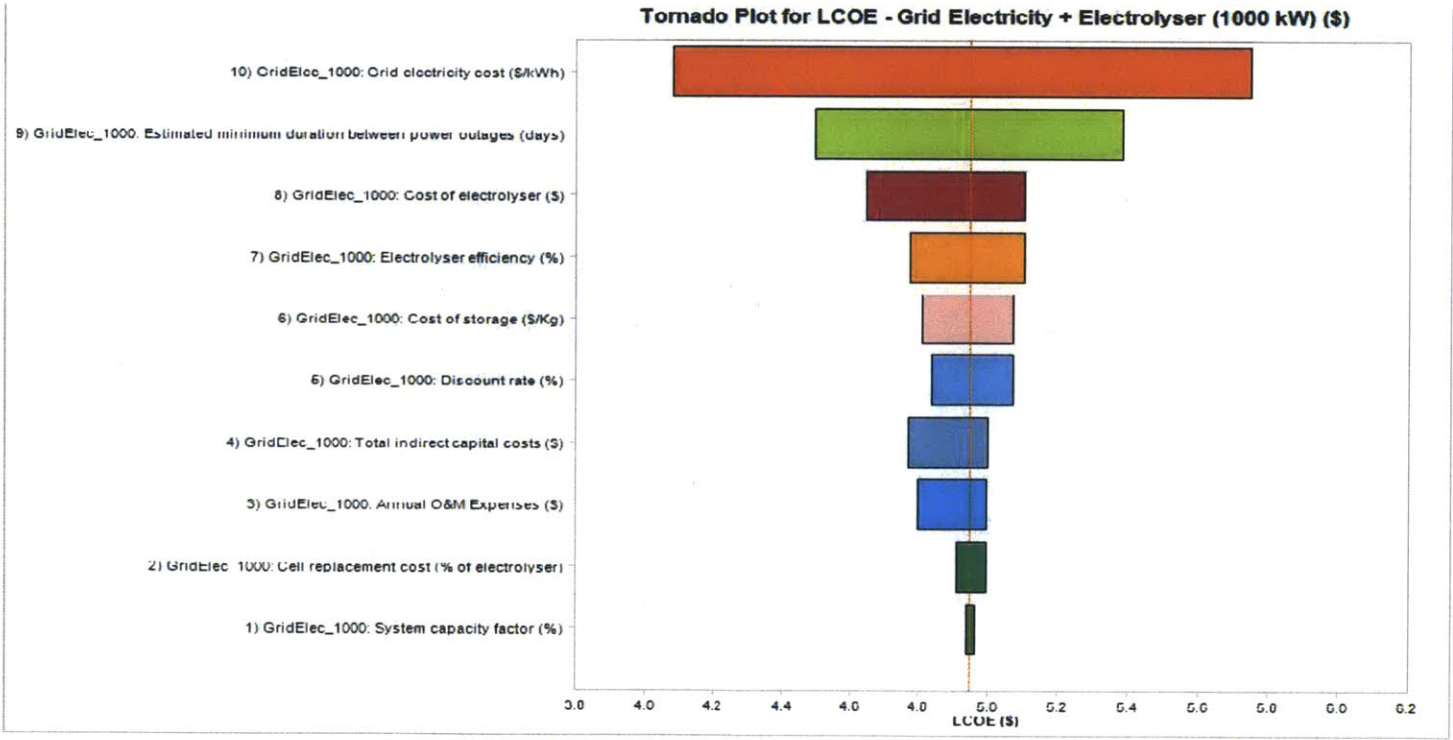
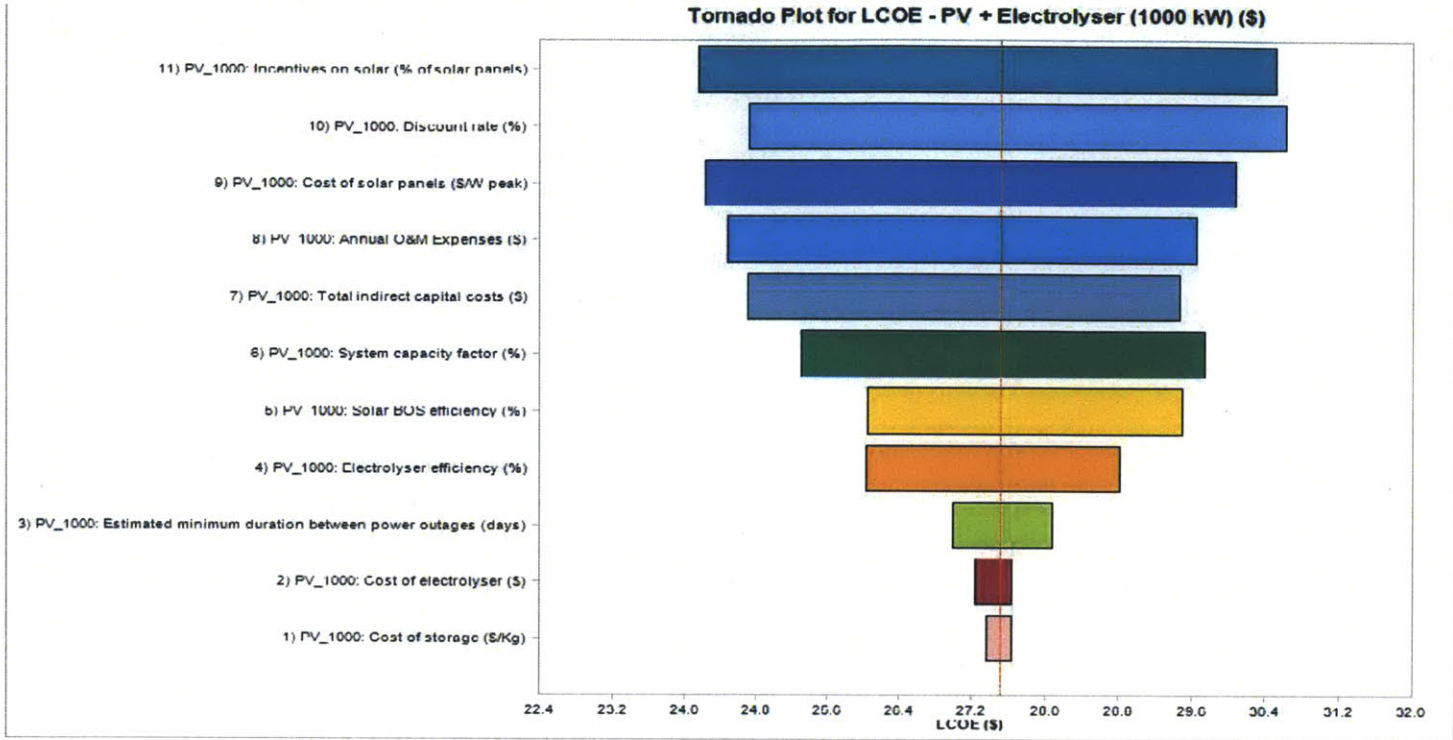

**Figure 20:** Tornado plots showing results of sensitivity analysis for 1000 kW PV and grid-connected systems when the duration between successive power outages is 1–3 days

## 6 COMPARISONS WITH A FOSSIL FUEL-BASED SYSTEM<sup>22</sup>

Given the finding in Section 5.6.3 that LCOE of a photovoltaic electrolyzer system for telecom backup applications is extremely sensitive to the duration between power outages (or outage frequency), a more detailed comparison between telecom backup power solutions in two different geographies having different grid power outage frequencies but similar solar insolation characteristics is considered.

### 6.1 Locations Chosen for Comparison

The locations chosen for the comparison were the states of California in the U.S and Gujarat in India. The key characteristics of the two locations that are relevant for the analysis in this chapter are summarized in Table 14.

	California (U.S)	Gujarat (India)
Average annual solar insolation	6 kWh/sq. m	6 kWh/sq. m
Electricity grid energy sources	40% from fossil fuels	87% from fossil fuels
Telecom reliability needs	>99.999%	>99.999%
Length of power cuts	<1h common; >12 on occasion	>12h rural, >4h urban quite common
Assumed average duration between long outages (days)	1 to 30	1 to 3
Regulation for renewables	Favorable	Increasingly favorable
Incumbent backup solution	Batteries (short outages), Diesel gensets (long outages)	Batteries (short outages), Diesel gensets (long outages)

**Table 14:** Comparison of select high-level characteristics between California and Gujarat

Both Gujarat and California have approximately similar levels of average annual solar insolation and favorable regulation for renewable projects, making them good candidates for solar photovoltaic hydrogen projects. To understand the potential for distributed solar photovoltaic powered fuels cells in Gujarat, the heads of operations of two of the largest

<sup>22</sup> The analysis in this chapter was undertaken as part of the course ESD.125 – Mapping and Evaluating New Energy Technologies taught by Dr. Jessika Trancik from the Engineering Systems Division (ESD) at MIT. The analysis work was undertaken jointly with Stephanie Goerges (SDM '12). The analysis incorporates ideas and suggestions from Stephanie and Dr. Trancik.

telecom tower operators in India were interviewed (see **Appendix A** for questionnaire). Some of the insights collected from the interviews are summarized below.

1. The need for telecom backup power in Gujarat is particularly compelling. While the expected reliability of service from a telecom service provider in Gujarat is as high as in California, it needs to provide this service on a highly unreliable grid infrastructure.
2. Power cuts are a daily occurrence. Long power cuts in excess of 12 hours are quite common, especially in rural areas.
3. Batteries are the incumbent solution for short power outages and diesel generators for long outages. Given that telecom towers are the 2<sup>nd</sup> largest consumer of diesel in India, regulations that require operators to progressively introduce renewable sources of energy for primary and backup power are expected in the near future.
4. Telecom tower operators are also increasingly affected by the rising diesel prices. Over the past decade, diesel prices have increased at an average rate of over 10% per annum.
5. Given the above trends, telecom operators are very keen on implementing renewable energy sources of backup power. Fuel cells, if economical, would be an attractive proposition.

## **6.2 Research Questions**

The interviews combined with the analysis of the energy mix in the two locations raised the following questions:

**Question 1:** When providing backup power for telecom towers, how do diesel generators compare with grid and photovoltaic hydrogen systems with respect to electricity cost and carbon emissions?

**Question 2:** Is there an optimal fossil-to-solar fuel technology mix that maximizes the overall economic and environmental benefit?

Existing research papers related to the above topic have studied the optimal combination of renewable energy technologies, such as wind and photovoltaic, with diesel generators for hybrid off-grid systems (Dufo-lo 2009), (Shaahid & El-Amin 2009), (Fleck & Huot 2009), (García-Valverde et al. 2009), (Muselli et al. 1999).

(Shaahid & El-Amin 2009) studied optimal combination of technologies of PV, diesel generator and battery with a daily average load of 1000-3000 kW for a remote village and found that a combination of 2.5 MW PV, 4.5 MW diesel and 50 minute battery capacity yielded 17% reduction in fuel usage and 30% reduction in tons of CO<sub>2</sub> emissions per year. However, the LCOE for the hybrid solution was determined to be 0.169 \$/kWh compared with the diesel only case at 0.048 \$/kWh.

Studies conducted on much smaller scale systems also found Pareto optimal solutions for PV-diesel hybrid systems. (Muselli et al. 1999) found that the hybrid system that minimized cost was 65% PV, 35% diesel compared to a PV only system.

No study to date has been conducted on a hybrid backup system involving hydrogen fuel cell technologies and diesel generator. This study will also be conducted for a system sized between the large scale and small scale cases previously explored. Finally, this paper will evaluate both the economic and environmental impacts of a hybrid system compared to a single technology system.

## **6.3 Boundary Conditions**

### **6.3.1 SCOPE OF ANALYSIS**

In order to answer the above questions, the scope of the analysis done in **Chapter 5** was extended to include a diesel powered generator to the grid- and photovoltaic-powered hydrogen systems. The energy pathways considered for this analysis are shown in **Figure 21**. Given that hydrogen-powered systems have the best value proposition in cases of

prolonged outages, the analysis is performed for long outages only (in the range of 24 hours). A similar analysis for a combination of outage durations could be the subject of a subsequent study.

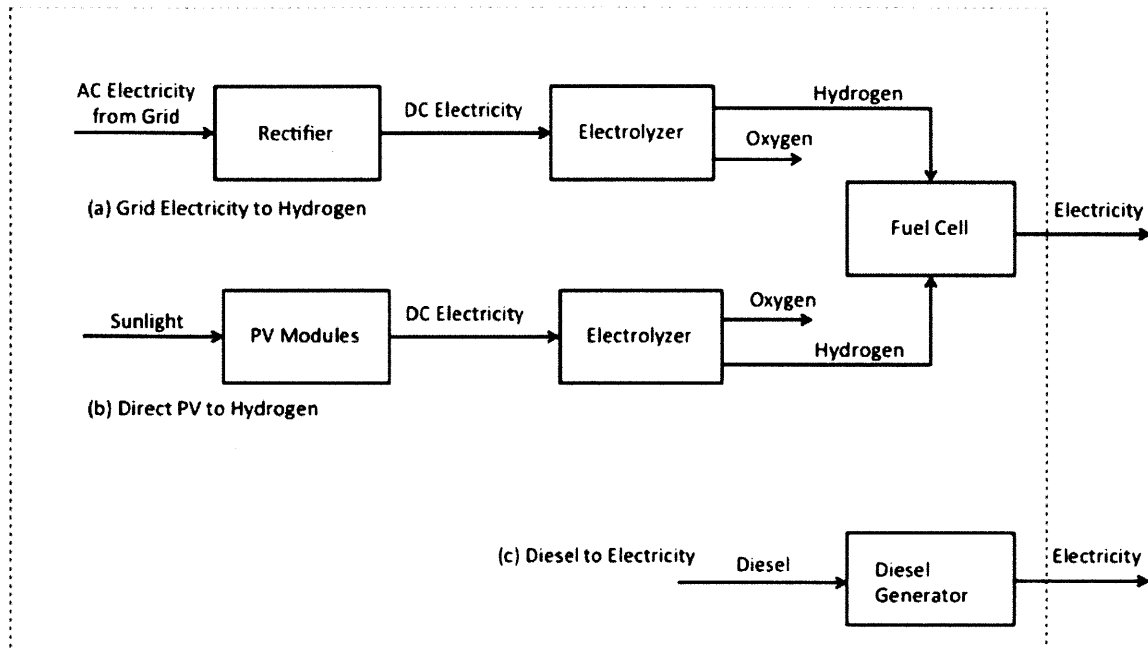

**Figure 21:** Scope of system used for comparing photovoltaic and grid electricity-powered fuel cells with diesel-powered generators.

Notice that a fuel cell has been added to the hydrogen systems analyzed in **Chapter 5**. In order to be able to compare a diesel generator with the hydrogen generating system from the previous analysis, outputs from those systems need to be standardized. The inclusion of the fuel cells to hydrogen systems allows for this since all three pathways now produce electricity.

### 6.3.2 TECHNOLOGY ASSUMPTIONS

1. Backup power requirement of 50 kW for a single tower with multiple operators is considered since this is the most common use case. The 10 kW and 1000 kW



cases are not considered in this analysis, but could be interesting in a subsequent analysis.

2. The assumptions for the hydrogen systems are same as those in **Section 5.3**. In addition, a PEM fuel cell with an efficiency of 50% (including balance of systems losses) is assumed.
3. The specifications assumed for the diesel generator are as follows (derived from (Alsema 2000)).
  - a. Tier-3 Emissions: Carbon intensity - 1.27 Kg CO<sub>2</sub>-eq/kWh; PM limit: 0.15 g/HP-hr; NO<sub>x</sub> limit: 3.0 g/HP-hr
  - b. Efficiency: 40%
  - c. Load factor: 50%
4. Costs (See **Appendix B**)
  - a. Generator: \$14000
  - b. Maintenance: \$1/hr
  - c. Fuel: \$3.93/gallon (U.S); \$0.87/gallon (India)

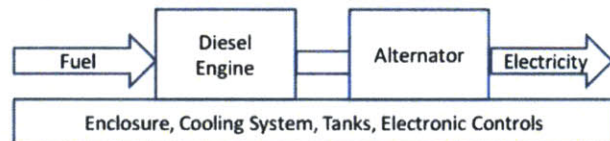

**Figure 22:** Image of diesel generator considered for analysis

## 6.4 Methodology

A big difference between solar fuel and fossil fuel based systems is the amount of CO<sub>2</sub>-equivalent<sup>23</sup> emissions (also known as the global warming potential or GWP) of these systems. This motivates the need to introduce other figures of merit besides LCOE that take GWP into account while evaluating the systems. Secondly, while the GWP of a

<sup>23</sup> Refers to CO<sub>2</sub> and other emissions like NO<sub>x</sub> and SO<sub>x</sub> expressed in terms of CO<sub>2</sub>

fossil fuel-based system is expected to be much higher than that of a solar fuel system, the former is expected to be much cheaper. Hence a trade-off analysis is also undertaken.

#### 6.4.1 METRICS USED

The metrics used in this analysis are described below.

1. **LCOE (USD/kWh):** The definition of LCOE is the same as described in **Section 5.5** (taken from (Branker et al. 2011)). One important difference is that this analysis compares the LCOE of generated electricity as against LCOE of hydrogen in the previous analysis.
2. **GWP (kg CO<sub>2</sub>-e over lifetime):** A Lifecycle Analysis (LCA) of all three systems was undertaken to measure the amount of emissions, both during the manufacture of the systems as well as operations over entire the lifetime of the systems (c.f. **Appendix B** for parameters used).
3. **Weighted Sum (dimensionless):** A new metric—a weighted sum of the LCOE and LCA values—is also introduced that sums up the values of the two metrics for each scenario. This calculation is undertaken in two steps: 1) normalize LCA and LCOE values such that they can be summed 2) weight each of the above two metrics based on a preference value (termed lambda) indicating importance of the metric to the decision making process and then sum them up.

#### 6.4.2 OPTIMIZATION PROBLEM FORMULATION

A trade-off analysis is undertaken in order to calculate the optimum combination of grid-powered fuel cells, PV-powered fuel cells and diesel generators, taken two at a time. The formulation for the weighted sum optimization:

$$\min J_{Tot} = \lambda \bar{J}_1 + (1 - \lambda) \bar{J}_2$$

$$\bar{J}_i = \frac{J_i - J_i^U}{J_i^N - J_i^U}$$

$$\min J_{Tot} = \lambda \overline{LCOE} + (1 - \lambda) \overline{LCA}$$

Where  $\lambda$  is the user-selected weighting factor,  $J_i^U$  is the minimum value of the function  $J_i$ ;  $J_i^N$  is the maximum of the function  $J_i$ . For this case,  $J_1$  is LCOE and  $J_2$  is LCA. Therefore  $\lambda=0$  reflects the preference of a stakeholder who values only LCA,  $\lambda=1$  reflects the preference of a stakeholder who values only LCOE and  $\lambda=0.5$  reflects the preference of a stakeholder who values both equally. These are the three cases for  $\lambda$  investigated in this study. The above formulation essentially tries to find the mix of technologies that result in the lowest weighted sum value.

## 6.5 Results

### 6.5.1 INDIVIDUAL TECHNOLOGIES - LCOE RESULTS

A sensitivity analysis was undertaken for the three individual technologies – PV fuel cells, Grid-powered fuel cells and diesel generators - for California and Gujarat, giving six different scenarios. The results are shown in **Figure 23**.

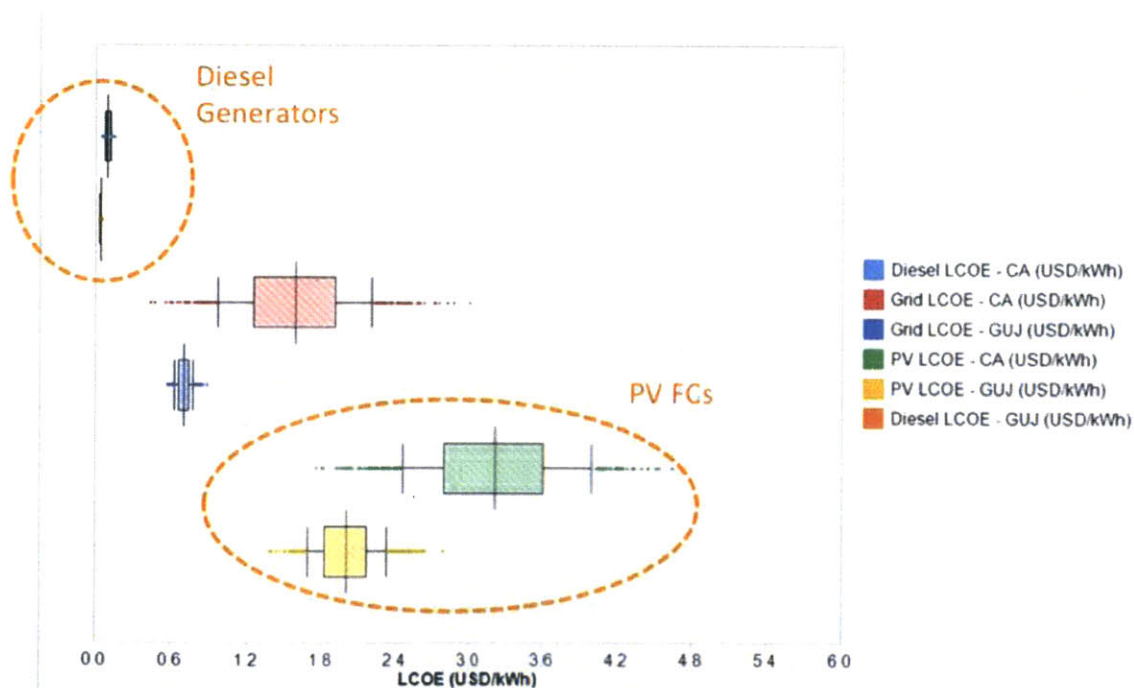

**Figure 23:** Comparison of LCOE values of fuel cell- and diesel-powered backup systems in California and Gujarat.

**Result 16:** PV-powered fuels cells<sup>24</sup> are 30-50 times more expensive than diesel generators and 16-18 times more expensive than grid-powered fuel cells (see **Figure 23**). The multiple increases with scale. This indicates highest marginal cost of providing energy in case of PV FC, followed by Grid FC. Also Gujarat is cheaper than California in all three cases due to higher outage frequency. This is due to higher amount of backup energy produced and hence better capital utilization.

### 6.5.2 INDIVIDUAL TECHNOLOGIES - LCA RESULTS

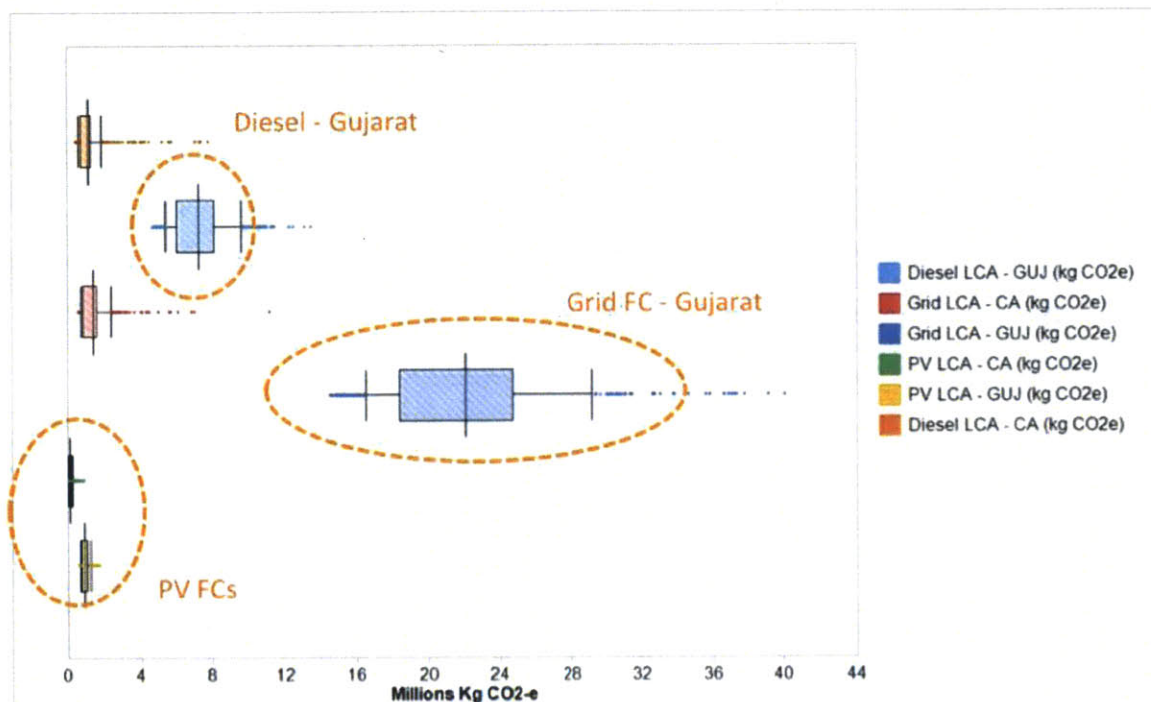

**Figure 24:** Comparison of GWP values of fuel cell- and diesel-powered backup systems in California and Gujarat.

**Result 17:** Considering carbon emissions alone, PV FCs are the best option. A grid FC in Gujarat is the worst option, followed by a diesel generator in Gujarat (see **Figure 24**). In other words, in Gujarat it's better to run diesel generators than grid-powered FCs if

<sup>24</sup> PV-powered fuel cells and grid- powered fuel cells are referred as PV FC and Grid FC for brevity

emissions are important. This is because of the high fossil fuel mix in the source of grid electricity in Gujarat (see **Table 14**). The diesel generator in Gujarat performs worse than a grid FC in California due to the relatively cleaner grid in California and the high usage of diesel generators in Gujarat.

### 6.5.3 INDIVIDUAL TECHNOLOGIES - WEIGHTED SUM RESULTS

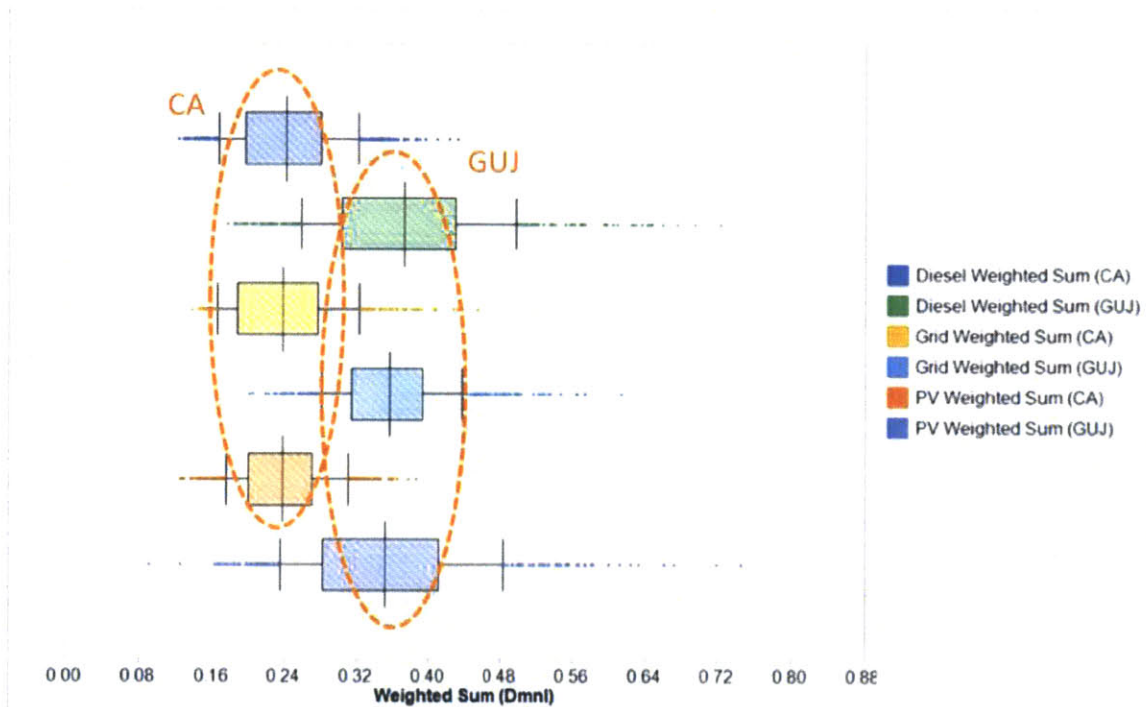

**Figure 25:** Comparison of weighted sum values of fuel cell- and diesel-powered backup systems in California and Gujarat.

**Result 18:** When LCOE and LCA are equally weighted, the mean performance for each technology within a given location is nearly equal with technologies located in California performing better than every other technology located in Gujarat (c.f. **Figure 25**). Within each location PV FC variance is marginally better than grid FC and diesel; but for all practical purposes the technologies within a given location can be considered to be equally good. The results indicate that with increased scale of the systems in Gujarat, the reduction in LCOE noticed earlier doesn't adequately compensate for the increased

emissions. But perhaps more importantly, the results show that even with very conservative cost and emissions projections and relative weights, fuel cells can be competitive with diesel generators if CO<sub>2</sub> emissions are factored into the decision-making process.

#### 6.5.4 RESULTS COMPARING COMBINATIONS OF TECHNOLOGIES

LCOE and LCA were calculated for combinations of PV fuel cell and diesel generator with each system providing some percentage of the total energy need. There is no combination of PV fuel cell and diesel generator that performs better on either LCOE or LCA; see **Figure 26** for California results and **Figure 27** for Gujarat results. Referring to **Figure 26**:

At point A, the equation for LCOE is as follows:

$$\text{LCOE}_{\text{Diesel}} = \frac{\sum \text{Cost}_{\text{Diesel}}}{\text{kWh}_{\text{Total}}}$$

At point B, the equation for LCOE is:

$$\text{LCOE}_{\text{Total}} = \frac{\sum \text{Cost}_{\text{PV}}}{\text{PV}\% * \text{kWh}_{\text{Total}}} + \frac{\sum \text{Cost}_{\text{Diesel}}}{(1 - \text{PV}\%) * \text{kWh}_{\text{Total}}}$$

When PV% is very small, as in point B, the second term approaches the value for LCOE<sub>Diesel</sub> and the first term becomes very large.

When PV% approaches 0.5, an equal split of the two technologies depicted by point C, LCOE<sub>Total</sub> can be approximated by the following equation:

$$\text{LCOE}_{\text{Total}} = \frac{\sum \text{Cost}_{\text{PV}} + \sum \text{Cost}_{\text{Diesel}}}{\text{kWh}_{\text{Total}}}$$

This number would be larger than the value for LCOE<sub>Diesel</sub> but not as large as LCOE<sub>Total</sub> when PV% is very small. The same logic would hold for values of PV% that are very large, as in point D.

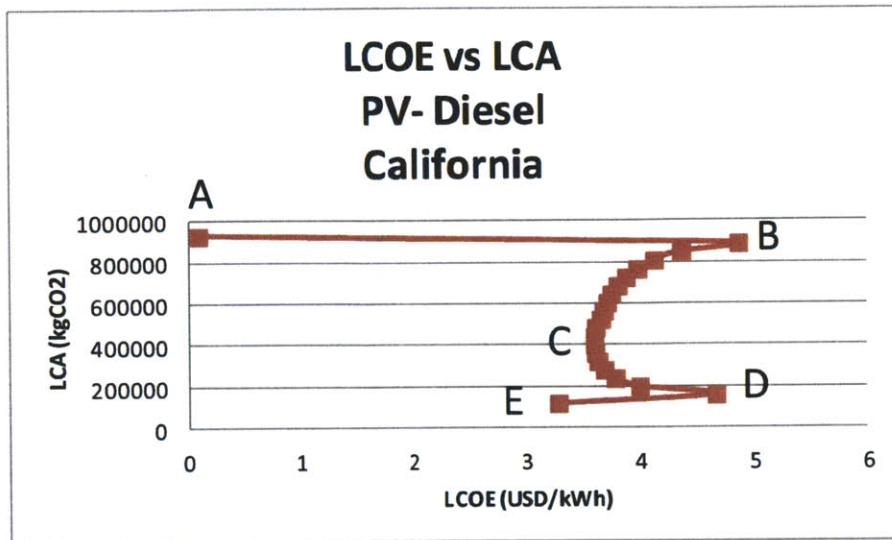

Figure 26: LCOE vs. LCA for PV-Diesel Combination, California

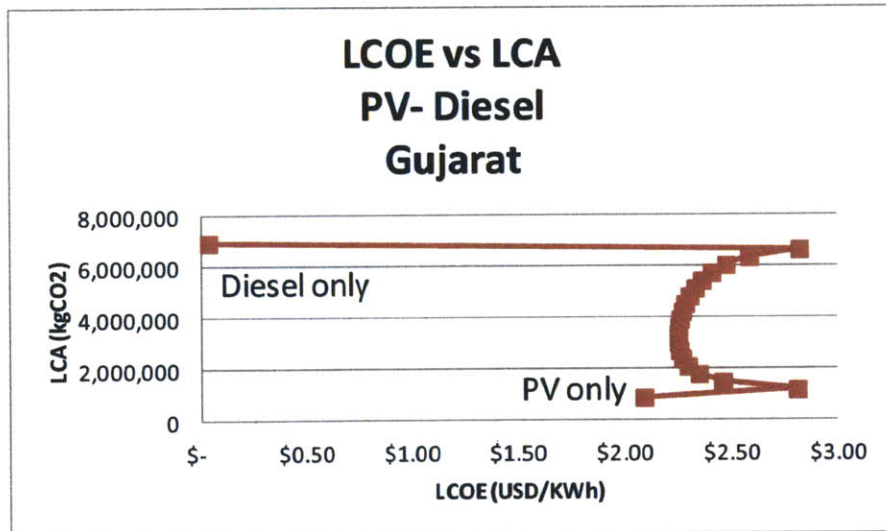

Figure 27: LCOE vs. LCA for PV-Diesel Combination, Gujarat

The weighted sum returns the same results. The lowest weighted sum in both locations is for a PV fuel cell only or diesel generator only case; see **Figure 28** for California results and **Figure 29** for Gujarat results.

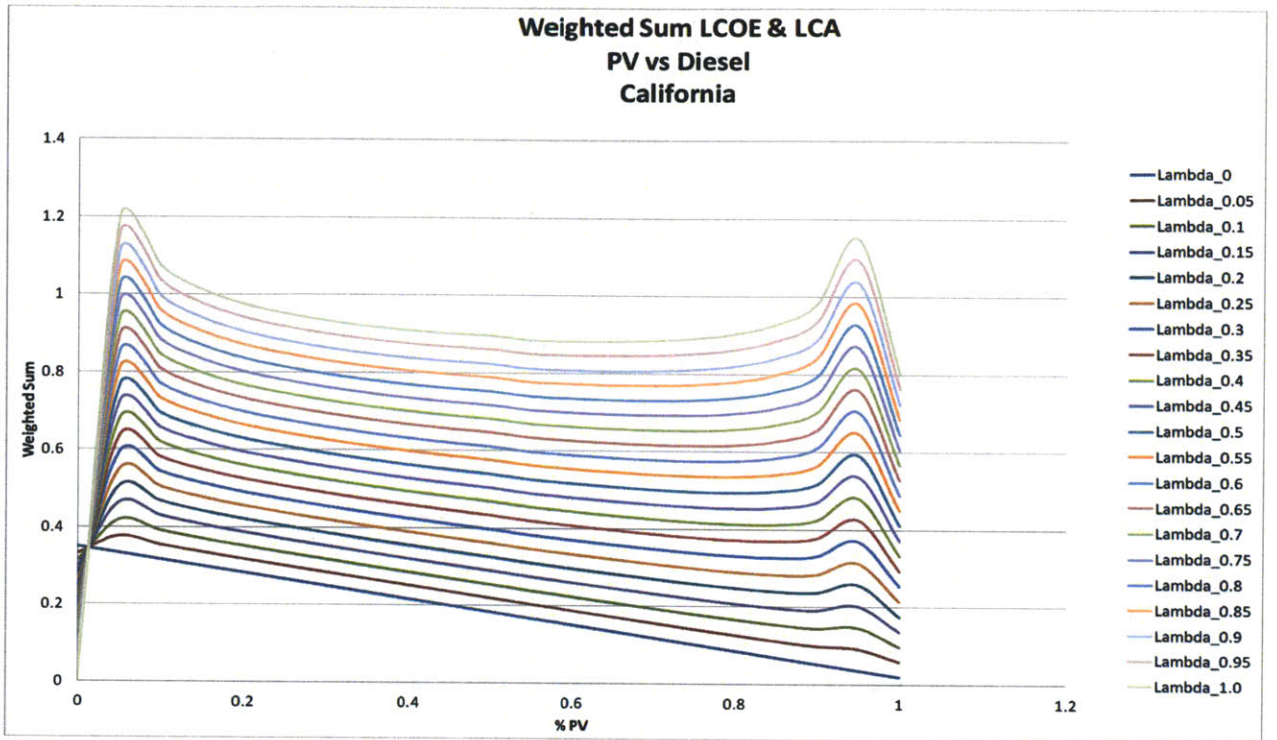

Figure 28: Weighted Sum for PV-Diesel Combination, California

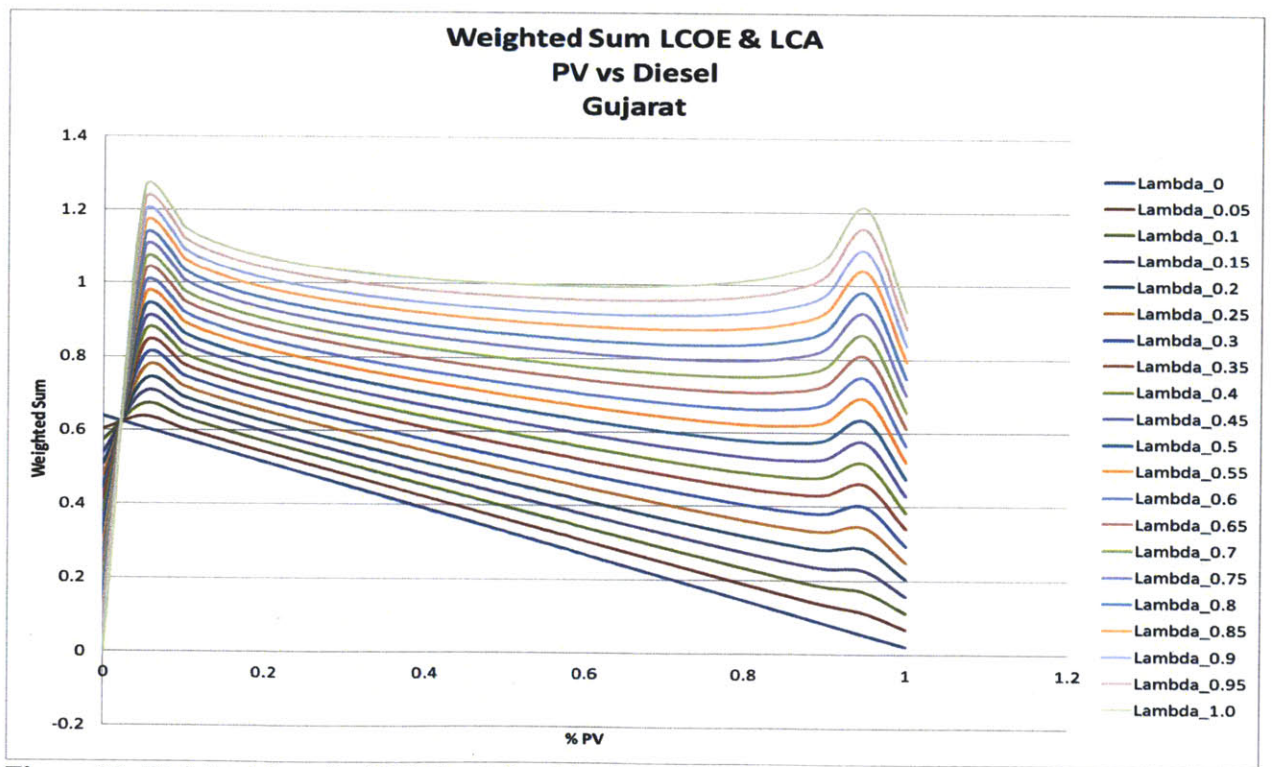
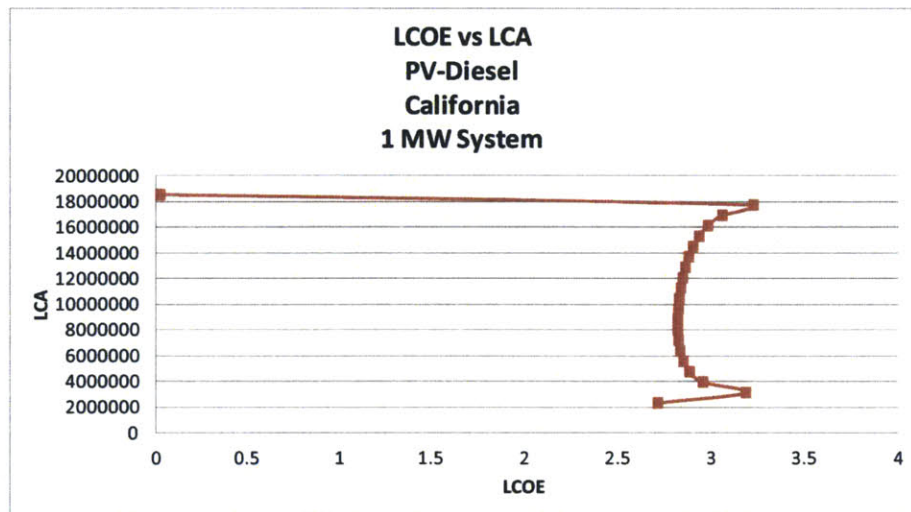

Figure 29: Weighted Sum for PV-Diesel Combination, Gujarat



LCOE and LCA were also calculated for combinations of PV- and grid-powered fuel cells and for combinations of grid-powered fuel cell and diesel generator. The results were similar to those of the PV-diesel combinations. No hybrid solution performed better on LCOE, LCA or weighted sum for either location.

To determine the impact of scale on the results, hybrid solutions for 1 MW demand system were evaluated. The shape of the curves did change. There was less of an impact of the initial capital investment on LCOE. However, there is still no hybrid solution at this scale that performs better than a single technology system. See **Figure 30** and **Figure 31** for results.



**Figure 30:** LCOE vs. LCA for 1 MW system, California

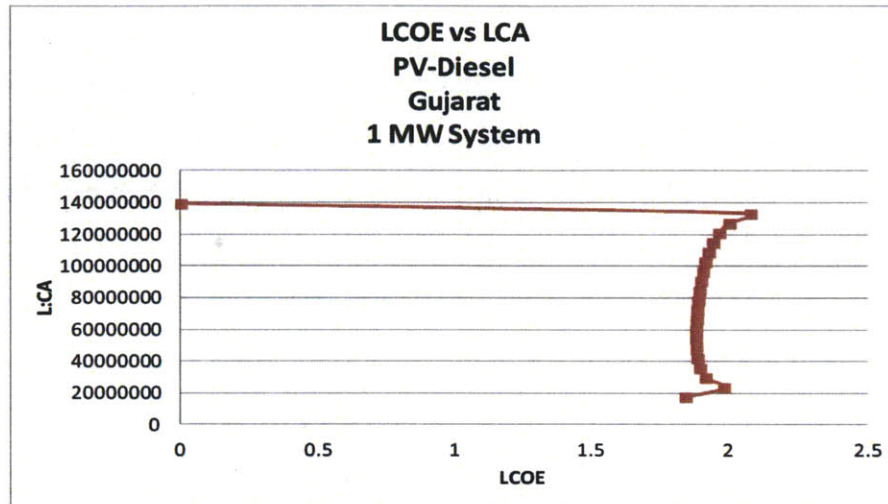

**Figure 31:** LCOE vs. LCA for 1 MW system, Gujarat

**Result 19:** When deciding between a combination of diesel generator and PV FC, the best combinations are either 100% PV FC (has best GWP) or 100% diesel generator (has best economics). Intermediate combinations are sub-optimal. The same is also true for a combination of PV FC and grid FC. This is because at the scales considered, having a mix of technologies requires in a minimum level of financial investment and emissions in each technology, which are then hard to recover over the life of those systems. It is therefore best to optimize on either technology.

## **7 CONCLUSIONS AND FUTURE WORK**

### **7.1 Conclusions**

This thesis undertook an analysis of a distributed photovoltaic hydrogen system at different scales in the context of a specific near-term application—providing backup power for telecom towers—with the goal of assessing its economic and environmental benefits and comparing it with existing fossil-fuel-based alternatives.

While distributed solar fuel systems offer tremendous potential to address clean energy needs, distributed solar electrolysis for backup power applications based on current PV and electrolyzer technology is prohibitively expensive. In order to meet DOE targets for hydrogen (between \$2/Kg and \$3/Kg of hydrogen) overall system costs including capital costs of PV, electrolyzer as well as Balance-of-System (BOS) costs need to come down significantly. Perhaps this also points to the need for new ways of engineering small-scale hydrogen systems.

For all the systems considered in this analysis, the cost of hydrogen came down significantly with increase in frequency of power outages. Photovoltaic electrolysis systems for backup applications only make sense in areas with highly unreliable grid electricity.

Cost of hydrogen comes down with scale for all the systems analyzed and hence business models that aggregate hydrogen production in a region could be attractive.

If carbon emissions are considered as a decision-making criterion in addition to cost, even at current cost levels photovoltaic hydrogen systems compare favorably with the existing fossil fuel-based alternatives such as diesel generators.

For small-scale hydrogen systems such as those needed for backup power generation, hybrid solutions – such as a combination of hydrogen- and fossil-fuel-based systems are sub-optimal if both costs and emissions were weighted approximately equally. Depending on the preference for either benefit, it's better to invest in one system or the other.

## **7.2 Future work**

The analyses undertaken in this thesis can be extended in several interesting ways.

When considering the potential for hybrid systems for telecom backup power, the analysis in this thesis considered only long outages. A similar analysis considering a range of outage durations and other technologies such as batteries would simulate the real-life use cases more closely.

This study did not include the financial impact of an outage of the back-up system i.e. the opportunity cost of outages for the telecommunications provider. It would be useful to study the viability of a hybrid solution with a constraint for system reliability.

This study also did not include relationships between many of the factors contributing to cost and carbon emissions. Future work should include building relationships between variables such as fuel cost and carbon tax.

Using the analysis of photovoltaic electrolysis systems in this study as a baseline, it would be interesting to extend the analysis to the emerging class of technologies that make use of photolysis or “artificial photosynthesis” and avoid the intermediate generation of electricity as a carrier.

Photolytic systems are currently in research and development. They offer the potential to reduce systems costs significantly since the intermediate conversion to electricity is avoided. A systematic study of various architecture options for photolytic systems would be invaluable.

Given that distributed solar fuel systems are ideally suited to the “non-legacy world”, a detailed needs analysis of niche market segments for solar fuels in the developing countries would be a priceless undertaking.

## **8 APPENDICES**

### **8.1 Appendix A - Questionnaire Used to Assess Backup Power Needs in India<sup>25</sup>**

#### **Background**

The following survey is part of a research being conducted at Massachusetts Institute of Technology (MIT) around renewable ways of producing hydrogen. Fuel cells are one possible application of our research work. The telecom sector in India has been identified as a promising market for the use of fuel cells due to their ability to provide reliable emergency backup power, long runtimes and low operational expenses. The survey questions are designed to understand the needs of this sector. We would be extremely grateful if you could help answer the questions below.

#### **Contact**

1. Name of Organization
2. Address
3. Name of Contact
4. Primary Business of Your Organization

#### **About the facility**

5. Approximately how many employees work for your organization?
6. How many telecom tower facilities does your organization manage?
7. How much physical space does your typical telecom tower facility consume?
8. Where are the facilities located (villages, cities)? Please provide a breakup if possible (e.g., 70% in cities, 30% in villages etc)

#### **Current Backup Power Solution**

9. How are your back-up power requirements currently being met? Please highlight or bold all that apply.
  - a. Batteries
  - b. Uninterruptible Power Systems
  - c. Generators (diesel, propane)
  - d. Solar Cells

---

<sup>25</sup> Adapted from (Mahadevan et al. 2007) – A.3

- e. Others \_\_\_\_\_
  - f. No back-up power systems
10. How much physical space (in sq. ft.) does the backup solution consume?
11. What is the importance of the following factors in selecting a backup power system for your needs? Please rate each on a scale of 1 to 7, with 1 being not important and 7 very important. Please highlight or bold all that apply.
- a. Reliability – comes on and operates continuously every time it is needed (Scale 1-7, 1 not important, 7 very important)
    - i. 1    2    3    4    5    6    7    Don't know
  - b. Capital cost (Scale 1-7, 1 not important, 7 very important)
    - i. 1    2    3    4    5    6    7    Don't know
  - c. Lifetime of the unit (Scale 1-7, 1 not important, 7 very important)
    - i. 1    2    3    4    5    6    7    Don't know
  - d. Annual operating cost (fuel and maintenance) (Scale 1-7, 1 not important, 7 very important)
    - i. 1    2    3    4    5    6    7    Don't know
  - e. Emissions/environmental considerations or restrictions (Scale 1-7, 1 not important, 7 very important)
    - i. 1    2    3    4    5    6    7    Don't know
  - f. Start-up time when power goes out (Scale 1-7, 1 not important, 7 very important)
    - i. 1    2    3    4    5    6    7    Don't know
  - g. Ease of use, including regular maintenance (Scale 1-7, 1 not important, 7 very important)
    - i. 1    2    3    4    5    6    7    Don't know
  - h. Fuel Availability (Scale 1-7, 1 not important, 7 very important)
    - i. 1    2    3    4    5    6    7    Don't know
  - i. Good experience with this type of system in the past (Scale 1-7, 1 not important, 7 very important)
    - i. 1    2    3    4    5    6    7    Don't know
12. Does the current solution adequately meet the energy requirements during power outage periods?
13. For what functions in your facility do you currently use backup power for? Which of these functions are the most critical?
14. What is the typical size of backup power systems that you use? Please highlight or bold all that apply.
- a. <5 kW
  - b. 5-15 kW
  - c. 15-30 kW
  - d. 30-60 kW
  - e. 60-150 kW
  - f. 150-250 kW

- g. >250 kW
  - h. \_\_\_\_\_ kW
15. Approximately how many backup power systems do you currently have per facility? Can you estimate the number of backup power systems across all facilities in your organization? Please specify by size (e.g. we have approximately 30 - 15 kW diesel generators, 3 - 25kW UPS systems etc.)
16. Can you estimate how long a typical power outage period lasts?
- a. < 1 second
  - b. < 60 seconds
  - c. < 3 minutes
  - d. 3 – 5 minutes
  - e. 5 minutes – to an hour
  - f. 1 - 4 hours
  - g. 4 hours or longer
  - h. Don't know
17. Give us an idea about the frequency of power outages. How many times in a month do you face power outages?
18. How disruptive would each of the following outages be if they occurred during normal operating hours? (Please determine level of disruption assuming no backup power). Please rate each on a scale of 1 to 7, with 1 being not disruptive and 7 very disruptive. Please highlight or bold all that apply.
- a. 1 second (Scale 1-7, with 1 not disruptive and 7 very disruptive)
    - i. 1    2    3    4    5    6    7
  - b. 3 minutes (Scale 1-7, with 1 not disruptive and 7 very disruptive)
    - i. 1    2    3    4    5    6    7
  - c. 1 hour (Scale 1-7, with 1 not disruptive and 7 very disruptive)
    - i. 1    2    3    4    5    6    7
  - d. 4 hours (Scale 1-7, with 1 not disruptive and 7 very disruptive)
    - i. 1    2    3    4    5    6    7
  - e. Don't Know
19. How many times a year do grid power outages occur that would be considered disruptive or very disruptive?
20. Could power outages at your organization result in any of the following? Please highlight or bold all that apply.
- a. Lives lost
  - b. Security breach
  - c. Implementation of emergency management plans
  - d. Disruptions in production
  - e. Disruptions in distribution
  - f. Other (e.g., loss of safe drinking water) \_\_\_\_\_
  - g. Power outage has no effect



21. How would you rate your current backup power system for all of the following characteristics? Please rate each on a scale of 1 to 7, where 1 is not good and 7 is very good. Please highlight or bold all that apply.
- a. Reliability – comes on and operates continuously every time it is needed (Scale 1-7, 1 not good, 7 very good)
    - i. 1 2 3 4 5 6 7 Don't know
  - b. Capital cost compared to alternatives (Scale 1-7, 1 not good, 7 very good)
    - i. 1 2 3 4 5 6 7 Don't know
  - c. Operation and maintenance costs (Scale 1-7, 1 not good, 7 very good)
    - i. 1 2 3 4 5 6 7 Don't know
  - d. Lifetime of the unit compared to alternatives (Scale 1-7, 1 not good, 7 very good)
    - i. 1 2 3 4 5 6 7 Don't know
  - e. Annual operating cost (fuel and maintenance) (Scale 1-7, 1 not good, 7 very good)
    - i. 1 2 3 4 5 6 7 Don't know
  - f. Emissions – environmental considerations or restrictions (Scale 1-7, 1 not good, 7 very good)
    - i. 1 2 3 4 5 6 7 Don't know
  - g. Start-up time when power goes out (Scale 1-7, 1 not good, 7 very good)
    - i. 1 2 3 4 5 6 7 Don't know
  - h. Ease of use, including regular maintenance (Scale 1-7, 1 not good, 7 very good)
    - i. 1 2 3 4 5 6 7 Don't know
  - i. Fuel Availability (Scale 1-7, 1 not good, 7 very good)
    - i. 1 2 3 4 5 6 7 Don't know
22. What do you like about the current solution?
23. What are the specific concerns regarding current solution?
24. Do you anticipate a growing need for backup power in your sector in the next three years? Please highlight or bold answer that applies.
- a. Yes
  - b. No
  - c. Don't know

### **Economics**

25. What's the total capital expense for the current backup solution?
26. What's the expected life of the current backup solution?
27. How much labor is required for maintenance of your current systems – both scheduled and unscheduled maintenance (hours per month)?
28. What is the estimated labor rate for staff who maintain your telecom tower backup power systems (INR per hour)?

29. For a typical facility, please identify any maintenance costs you incur other than labor (e.g. filters) for your current backup systems.
30. How do you finance the acquisition of the backup power system?

**Alternative solutions**

31. Have you considered alternatives to your current backup power system? Please highlight or bold answer that applies.
  - a. Yes. If yes, what have you considered?
  - b. No
32. How you heard about fuel cells as a possible solution for backup power (a fuel cell generates power using hydrogen, has higher efficiency than traditional methods and produces zero emissions)?
33. Would you consider the use of fuel cells as backup power in your facility?
34. One possible way to use the fuel cell is to produce the fuel (hydrogen) locally at the facility using solar energy. For you this would mean additional investment (in solar panels and an electrolyser). But in return you would gain independence from grid power and have negligible operating costs (since the system uses only sunlight and water). Do you see value in such a solution?
35. Why might you not be interested in such a solution?

## 8.2 Appendix B - Parameters Used for Trade-off Analysis in Chapter 6

Fuel Cells CO <sub>2</sub> Equivalent Emissions (g CO <sub>2</sub> -e/kg H <sub>2</sub> unless specified otherwise) <sup>26</sup>				
Fuel Cell Lifecycle Processes	PV FC (CA)	Grid FC (CA)	PV FC (GUJ)	Grid FC (GUJ)
Materials and manufacturing of PV modules	1519.53	0.00	1519.53	0.00
Transportation	461.36	461.36	461.36	461.36
Inverters	0.00	110.93	0.00	110.93
Storage tanks	170.00	170.00	170.00	170.00
Grid Electricity for electrolysis	0.00	24800.00	0.00	62124.00
Electrolyzers	43.00	43.00	43.00	43.00
Wiring	60.24	60.24	60.24	60.24
Installation	37.18	37.18	37.18	37.18
Operations and maintenance	161.20	161.20	161.20	161.20
Decommissioning and disposal	61.70	61.70	61.70	61.70
Fuel cells	100.00	100.00	100.00	100.00
<b>Emissions Intensity (g CO<sub>2</sub>-e/kg H<sub>2</sub>)</b>	<b>2614.21</b>	<b>26005.61</b>	<b>2614.21</b>	<b>63329.61</b>
Total H <sub>2</sub> consumed / year (Kg)	1473.21	2709.77	11495.21	15622.18
Total emissions over lifetime (g CO <sub>2</sub> -e)	96282219	1761733395	751272396	24733658212
<b>Total emissions over lifetime (kg CO<sub>2</sub>-e)</b>	<b>96282</b>	<b>1761733</b>	<b>751272</b>	<b>24733658</b>

**Table 15:** LCA analysis for PV and grid fuel cells in California and Gujarat

Parameter	Min. Value	Most Likely Value	Max. Value	Units	Source
Cost of diesel generator	0	14347	0	USD	Table 18
Cost of diesel fuel – CA	1.965	3.93	11.79	USD	EIA (12-month average)
Cost of diesel fuel – GUJ	0.4148	0.8295	2.488	USD	<a href="http://www.mypetrolprice.com">http://www.mypetrolprice.com</a> <sup>27</sup>
O&M Cost	0	1	0	USD/hr	<a href="http://support.homerenergy.com">http://support.homerenergy.com</a> <sup>28</sup>
Generator efficiency	0	0.4	0	Gal/hr	D-3368 specification sheet
Generator load factor	0	0.5	0	ND	D-3368 specification sheet
Carbon tax	20	50	100	USD/ton carbon	Assumption based on interviews
Carbon intensity	0	1.27	0	Kg CO <sub>2</sub> /kWh	(García-Valverde et al. 2009)

**Table 16:** Diesel generator model parameters

<sup>26</sup> Most CO<sub>2</sub> intensity values are taken from (Cetinkaya et al. 2012)

<sup>27</sup> <http://www.mypetrolprice.com/10/Diesel-price-in-Ahmedabad> [accessed 5th May 2012]

<sup>28</sup> <http://support.homerenergy.com/index.php?Knowledgebase/Article/View/107/0/10066---diesel-om-costs-in-homer> [accessed 14th April 2012]

<b>LCA Analysis Assumption for Diesel Generator</b>		
Emissions Factor (kg CO <sub>2</sub> /kWh)	1.27	Garcia-Valverde, et al 2009

**Table 17:** LCA analysis inputs for diesel generator

<b>Generator</b>	<b>Power (kW)</b>	<b>Cost (USD)</b>	<b>Source</b>
Isuzu	10	5,364	<a href="http://www.hardydiesel.com">www.hardydiesel.com</a>
Kubota	10	8,424	<a href="http://www.affordablegenerator.com">www.affordablegenerator.com</a>
Perkins	20	12,507	<a href="http://www.uspower.com">www.uspower.com</a>
Cummins	50	13,351	<a href="http://www.affordablegenerator.com">www.affordablegenerator.com</a>
John Deere	60	16,990	<a href="http://www.calpower.com">www.calpower.com</a>
Cummins	50	12,700	<a href="http://www.tqmachinery.com">www.tqmachinery.com</a>

**Table 18:** Cost of Diesel Generator

## 9 BIBLIOGRAPHY

- Alsema, E.A., 2000. Environmental life cycle assessment of solar home systems. , (December).
- Amos, Wade A, 1998. *Costs of Storing and Transporting Hydrogen*,
- BP, 2011. *BP Statistical Review of World Energy*, Available at:  
<http://www.bp.com/statisticalreview>.
- Barbose, G. et al., 2011. *An Historical Summary of the Installed Cost of Photovoltaics in the United States from 1998 to 2010*,
- Branker, K., Pathak, M.J.M. & Pearce, J.M., 2011. A review of solar photovoltaic levelized cost of electricity. *Renewable and Sustainable Energy Reviews*, 15(9), pp.4470-4482. Available at:  
<http://linkinghub.elsevier.com/retrieve/pii/S1364032111003492> [Accessed October 13, 2011].
- Cetinkaya, E., Dincer, I. & Naterer, G.F., 2012. Life cycle assessment of various hydrogen production methods. *International Journal of Hydrogen Energy*, 37(3), pp.2071-2080. Available at:  
<http://linkinghub.elsevier.com/retrieve/pii/S036031991102430X> [Accessed March 2, 2012].
- Dori, D., 2002. *Object-Process Methodology*, Springer. Available at:  
<http://www.amazon.com/Object-Process-Methodology-Dov-Dori/dp/3540654712> [Accessed May 7, 2012].
- Dufo-lo, R., 2009. Simulation and optimization of stand-alone hybrid renewable energy systems. *Renewable and Sustainable Energy Reviews*, 13, pp.2111-2118.
- Fleck, B. & Huot, M., 2009. Comparative life-cycle assessment of a small wind turbine for residential off-grid use. *Renewable Energy*, 34(12), pp.2688-2696. Available at:  
<http://linkinghub.elsevier.com/retrieve/pii/S0960148109002894> [Accessed March 25, 2012].
- García-Valverde, R. et al., 2009. Life cycle assessment study of a 4.2kWp stand-alone photovoltaic system. *Solar Energy*, 83(9), pp.1434-1445. Available at:  
<http://linkinghub.elsevier.com/retrieve/pii/S0038092X09000590> [Accessed March 23, 2012].

- Genovese, J. et al., 2009. *Current (2009) State-of-the-Art Hydrogen Production Cost Estimate Using Water Electrolysis*,
- Ginley, D., Green, M. & Collins, R., 2008. Solar Energy Conversion Toward 1 Terawatt. *MRS Bulletin*, 33(April), pp.355-364.
- Grasman, S.E. et al., 2010. *Hydrogen Fuel Cell Analysis: Lessons Learned from Stationary Power Generation*,
- Gust, D., Moore, T.A. & Moore, A.L., 2009. Solar Fuels and Artificial Photosynthesis. *Accounts of chemical research*, 42(12), pp.1890-8. Available at: <http://www.ncbi.nlm.nih.gov/pubmed/22470985>.
- Hammache, A. & Bilgen, E., 1988. Evaluation of Thermal Efficiency and Cost of High Temperature Solar Heat from Central Receiver Systems to use in Hydrogen Producing Thermochemical Processes. *International Journal of Hydrogen Energy*, 13(9), pp.539-546.
- Hoffert, M.I. et al., 1998. Energy implications of future stabilization of atmospheric CO<sub>2</sub> content. *October*, 395(October), pp.881-884.
- Hollmuller, P. et al., 2000. Evaluation of a 5 kW p photovoltaic hydrogen production and storage installation for a residential home in Switzerland. *International Journal of Hydrogen Energy*, 25.
- Ivy, J., 2004. *Summary of Electrolytic Hydrogen Production Milestone Completion Report*,
- JCAP, 2012. Joint Center for Artificial Photosynthesis. Available at: <http://solarfuelshub.org/> [Accessed May 1, 2012].
- Jacobson, M.Z., 2009. Review of solutions to global warming, air pollution, and energy security. *Energy & Environmental Science*, 2(2), p.148. Available at: <http://xlink.rsc.org/?DOI=b809990c> [Accessed July 17, 2011].
- Levene, J.I. et al., 2005. An Analysis of Hydrogen Production from Renewable Electricity Sources. In *ISES 2005 Solar World Congress Orlando, Florida*.
- Lewis, N.S., 2007. Powering the Planet. *MRS Bulletin*, 32(October).
- Lewis, N.S. & Nocera, D.G., 2006. Powering the planet: chemical challenges in solar energy utilization. *Proceedings of the National Academy of Sciences of the United*

*States of America*, 103(43), pp.15729-35. Available at:  
<http://www.pubmedcentral.nih.gov/articlerender.fcgi?artid=1635072&tool=pmcentrez&rendertype=abstract>.

LewisLab, 2012. Lewis Research Group - CalTech. Available at:  
<http://nsl.caltech.edu/research> [Accessed May 1, 2012].

Lovins, A.B., 2002. *Small is Profitable: The Hidden Economic Benefits of Making Electrical Resources the Right Size*, Rocky Mountain Institute. Available at:  
<http://www.amazon.com/Small-Profitable-Economic-Electrical-Resources/dp/1881071073> [Accessed May 7, 2012].

Mahadevan, K. et al., 2007. *Identification and Characterization of Near-Term Direct Hydrogen Proton Exchange Membrane Fuel Cell Markets*,

Mason, J. & Zweibel, K., 2008. Centralized Production of Hydrogen using a Coupled Water Electrolyzer-Solar Photovoltaic System. In *Solar Hydrogen Generation - Toward a Renewable Energy Future*. Springer Science+Business Media, LLC, pp. 271-311.

Mitchell, W.L., 2007. Specialty Vehicles and Material Handling Equipment. *Fuel Cells*, (617).

Moniz, E.J., 2012. The Clean Energy Future: Opportunity or Train Wreck? - Talk at Sidney Pacific graduate residence, MIT, Cambridge, MA. *Energy*, (April).

Muselli, M., Notton, G. & Louche, A., 1999. DESIGN OF HYBRID-PHOTOVOLTAIC POWER GENERATOR , WITH OPTIMIZATION OF ENERGY MANAGEMENT. *Solar Energy*, 65(3), pp.143-157.

Nocera, D.G., 2006. On the Future of Global Energy. *Energy*, pp.112-115.

NoceraVideo, 2010. Dan Nocera: personalized energy. Available at:  
<http://www.youtube.com/watch?v=KTtmU2ID97o> [Accessed May 1, 2012].

Ogden, J.M. & Williams, R.H., 1990. Electrolytic Hydrogen from Thin-Film Solar Cells. *International Journal of Hydrogen Energy*, 15(3), pp.155-169.

Rajeshwar, K., McConnell, R. & Licht, S., 2010. *Solar Hydrogen Generation: Toward a Renewable Energy Future*, Springer. Available at: <http://www.amazon.com/Solar-Hydrogen-Generation-Toward-Renewable/dp/1441924965> [Accessed April 30, 2012].

- Romm, J.J., 2005. *The Hype About Hydrogen: Fact and Fiction in the Race to Save the Climate*, Island Press. Available at: <http://www.amazon.com/The-Hype-About-Hydrogen-Fiction/dp/1559637048> [Accessed May 1, 2012].
- Saur, Genevieve, 2008. *Wind-To-Hydrogen Project : Electrolyzer Capital Cost Study*,
- Shaahid, S.M. & El-Amin, I., 2009. Techno-economic evaluation of off-grid hybrid photovoltaic–diesel–battery power systems for rural electrification in Saudi Arabia—A way forward for sustainable development. *Renewable and Sustainable Energy Reviews*, 13(3), pp.625-633. Available at: <http://linkinghub.elsevier.com/retrieve/pii/S1364032107001694> [Accessed April 12, 2012].
- Smith, C.A., Belles, R.D. & Simon, A.J., 2011. *2007 Estimated International Energy Flows*,
- Smith, K.A., Sullivan, J.O., et al., 2011. *International Energy Outlook 2011*,
- Spath, P.L., Mann, M.K. & Amos, W A, 2003. *Update of Hydrogen from Biomass - Determination of the Delivered Cost of Hydrogen Milestone Completion Report*,
- Steward, D. (NREL) et al., 2009. *Lifecycle Cost Analysis of Hydrogen Versus Other Technologies for Electrical Energy Storage*,
- Styring, S., 2012. Artificial photosynthesis for solar fuels. *Faraday Discussions*, 155, p.357. Available at: <http://xlink.rsc.org/?DOI=c1fd00113b> [Accessed April 16, 2012].
- Swisher, J.N., 2005. *Cleaner Energy, Greener Profits: Fuel Cells as Cost-Effective Distributed Energy Resources*,
- Turner, J.A., 1999. A Realizable Renewable Energy Future. *Science*, 285(5428), pp.687-689. Available at: <http://www.sciencemag.org/cgi/doi/10.1126/science.285.5428.687> [Accessed June 13, 2011].
- Varkaraki, E., Lymberopoulos, N. & Zachariou, a., 2003. Hydrogen based emergency back-up system for telecommunication applications. *Journal of Power Sources*, 118(1-2), pp.14-22. Available at: <http://linkinghub.elsevier.com/retrieve/pii/S0378775303000569> [Accessed March 4, 2012].



Vidueira, J.M., Contreras, A. & Veziroglu, T.N., 2003. PV autonomous installation to produce hydrogen via electrolysis , and its use in FC buses. *International Journal of Hydrogen Energy*, 28, pp.927-937.