



Conical Horn Antenna with Spiral Phase Plate for Difference Pattern Generation

Doumanis, E., Zelenchuk, D., Fusco, V., & Goussetis, G. (2013). Conical Horn Antenna with Spiral Phase Plate for Difference Pattern Generation. In Proceedings for 2013 7th European Conference on Antennas and Propagation (EuCAP). (pp. 2165-2168). Institute of Electrical and Electronics Engineers (IEEE).

Published in:

Proceedings for 2013 7th European Conference on Antennas and Propagation (EuCAP)

Document Version:

Early version, also known as pre-print

Queen's University Belfast - Research Portal:

[Link to publication record in Queen's University Belfast Research Portal](#)

Publisher rights

© 2013 IEEE. Personal use of this material is permitted. Permission from IEEE must be obtained for all other uses, in any current or future media, including reprinting/republishing this material for advertising or promotional purposes, creating new collective works, for resale or redistribution to servers or lists, or reuse of any copyrighted component of this work in other works

General rights

Copyright for the publications made accessible via the Queen's University Belfast Research Portal is retained by the author(s) and / or other copyright owners and it is a condition of accessing these publications that users recognise and abide by the legal requirements associated with these rights.

Take down policy

The Research Portal is Queen's institutional repository that provides access to Queen's research output. Every effort has been made to ensure that content in the Research Portal does not infringe any person's rights, or applicable UK laws. If you discover content in the Research Portal that you believe breaches copyright or violates any law, please contact openaccess@qub.ac.uk.

Queen's University Belfast - Research Portal

Conical Horn Antenna with Spiral Phase Plate for Difference Pattern Generation

Doumanis, E., Zelenchuk, D., Fusco, V., & Goussetis, G. (2013). Conical Horn Antenna with Spiral Phase Plate for Difference Pattern Generation. 1265.

Document Version:

Preprint (usually an early version)

Link:

[Link to publication record in Queen's University Belfast Research Portal](#)

General rights

Copyright for the publications made accessible via the Queen's University Belfast Research Portal is retained by the author(s) and / or other copyright owners and it is a condition of accessing these publications that users recognise and abide by the legal requirements associated with these rights.

Take down policy

The Research Portal is Queen's institutional repository that provides access to Queen's research output. Every effort has been made to ensure that content in the Research Portal does not infringe any person's rights, or applicable UK laws. If you discover content in the Research Portal that you believe breaches copyright or violates any law, please contact openaccess@qub.ac.uk.

Conical Horn Antenna with Spiral Phase Plate for Difference Pattern Generation

E. Doumanis, D. Zelenchuk, V. Fusco, G. Goussetis

The Institute of Electronics, Communications and Information Technology (ECIT),
Queen's University Belfast, Northern Ireland Science Park, Queen's Road, Queen's Island,
Belfast, BT3 9DT, Northern Ireland, UK,
v.fusco@ecit.qub.ac.uk

Abstract—This paper describes the performance characteristics and experimental validation of a compact conical horn antenna with a dielectric cylinder spiral phase plate attached at its aperture. This performs the function of a spatial phase imprinting device creating a helical wave-front which results in a null in the far field radiation pattern of the antenna assembly.

Index Terms—conical horn antenna; spiral phase plate; helical beam;

I. INTRODUCTION

Quasi optical arrangements using spiral phase plate technology has been recently reported for helical beam formation [1]. In this paper we use a single conical horn with dielectric cylinder spiral phase plate (SPP) inserted at its aperture to synthesize difference beam patterns at microwave frequencies without recourse to a less compact quasi optical assembly. Section II details the operation principle of the antenna, section III describes the performance characteristics and section IV presents experimental validation of the design.

II. OPERATION PRINCIPLE

A. Dielectric cylinder spiral phase plate

The dielectric cylinder spiral phase plate acts to produce a 180° phase difference at any two given points that are radially opposite to each other. A CST model of the dielectric cylinder spiral phase plate is shown in Fig. 1. The spiral phase plate has one planar and one spiral surface. The spiral surface forms one period of a helix, terminating in a step discontinuity of height s ($s=60\text{mm}$ @ 10GHz). The dielectric cylinder spiral is milled from a solid cylindrical dielectric block of Polypropylene dielectric permittivity, $\epsilon_r = 2.3$ ($\tan\delta=0.0004$). Upon transmission through the phase plate, a signal of wavelength λ is subject to a phase delay, ψ , which depends on the azimuthal angle, ϕ , as [1]:

$$\psi = \frac{n_1 - n_2}{\lambda} s \phi \quad (1)$$

where n_1 and n_2 are the refractive indices of the phase-plate dielectric material and surrounding media (air) respectively, and s is the physical step height at $\phi=0$ (Fig. 1). For a Laguerre-Gaussian mode, the total phase delay around the phase-plate must be an integer multiple of 2π , i.e. $2\pi l$. Thus, to

produce a Laguerre-Gaussian mode of the first order, $l=1$, the physical height s of the step in the spiral phase-plate is given by:

$$s = \frac{l\lambda}{n_1 - n_2} \quad (2)$$

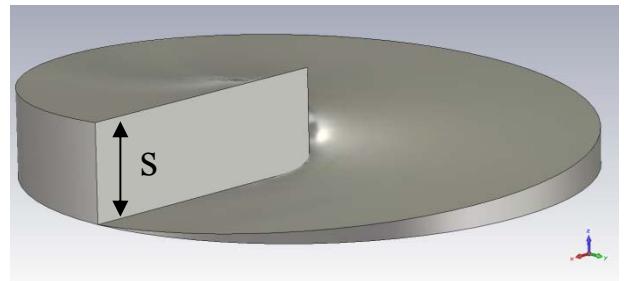

Figure 1. CST model of a dielectric cylinder spiral phase plate $s=60\text{ mm}$.

B. Antenna

A potter horn antenna [2] was designed, Fig. 2. This type of horn is used since it produces an axi-symmetrical field pattern, and can therefore be made to radiate LP or CP when suitably excited. The horn is designed by modifying a standard conical horn antenna such that a small component of the dominant TE_{11} mode is converted to the TM_{11} mode within the waveguide structure. The effect of this is to make the aperture illumination more uniform. A change in the waveguide dimensions near the horn throat as shown in Fig. 2 provides the simplest means to generate this additional mode component. Attaching the dielectric spiral plate at the aperture of the horn produces a spatial phase reversal across half of the antenna aperture. This translates to a null in the far field radiation pattern of the conical horn antenna.

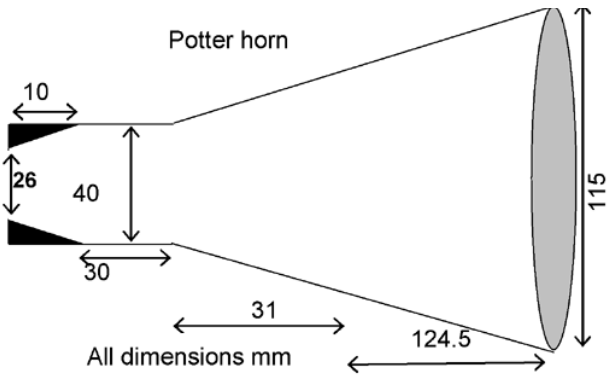

Figure 2. Sketch and associated dimensions of the conical horn antenna.

III. ANTENNA PERFORMANCE

The antenna performance at 10 GHz has been validated by means of CST full-wave simulations. A CST model of the spiral phase plate attached to the conical horn antenna is shown in Fig. 3. The diameter of the spiral phase plate is that of the conical horn. The uniform back side of the dielectric spiral phase plate is extended inside the horn for mechanical attachment. The simulated return loss at the input of the antenna versus frequency is plotted in Fig. 4 for the case of the conical horn and the conical horn with the attached SPP. The presence of the SPP at the aperture of the conical horn does not lead to major deterioration of the input matching of the antenna structure. Fig. 5 shows the simulated normalized radiation patterns with and without the addition of the SPP for the a) E-plane and b) H-plane cuts of the antenna far-field patterns. A null in the broadside of the antenna pattern can be observed and presents a -29 dB and -17 dB difference at broadside for the E-plane and H-plane, respectively. When compared to the conical horn antenna on its own one can observe the operation of the SPP to synthesize the difference pattern.

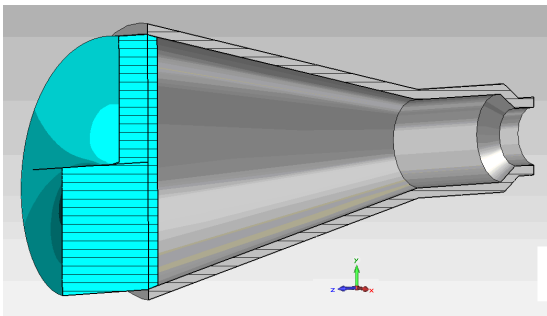

Figure 3. CST model of the antenna structure; dielectric cylinder spiral phase plate attached to the conical horn antenna.

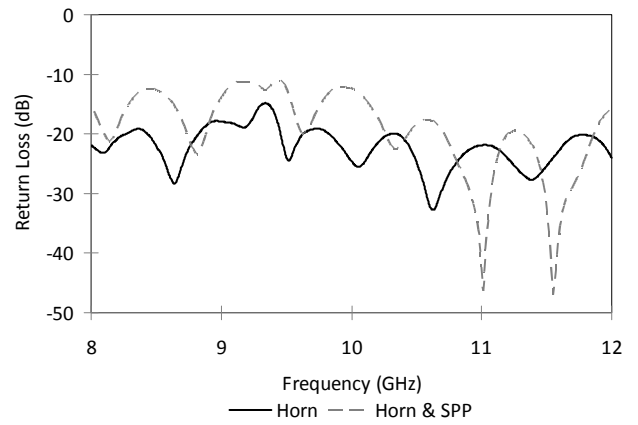

Figure 4. Simulated return loss at the input port of the antenna with and without the SPP.

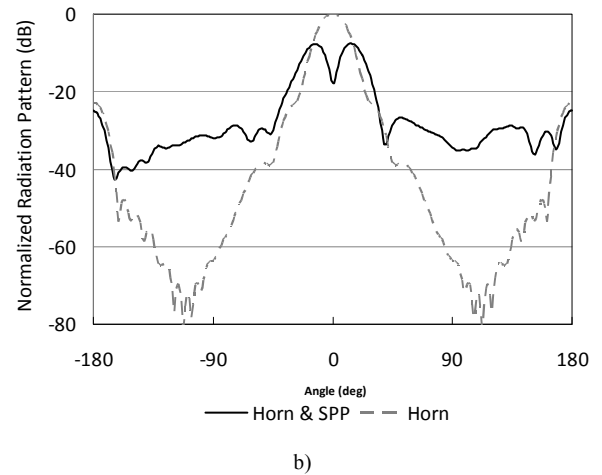
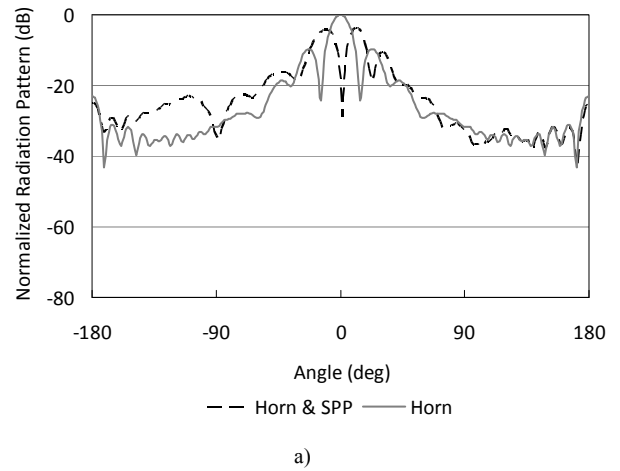

Figure 5. Simulated normalized radiation patterns for a) E-plane and b) H-plane with and without the spiral phase plate.

IV. EXPERIMENTAL VALIDATION

A prototype has been fabricated and experimentally tested, see Fig.7 for a photograph of the assembly.

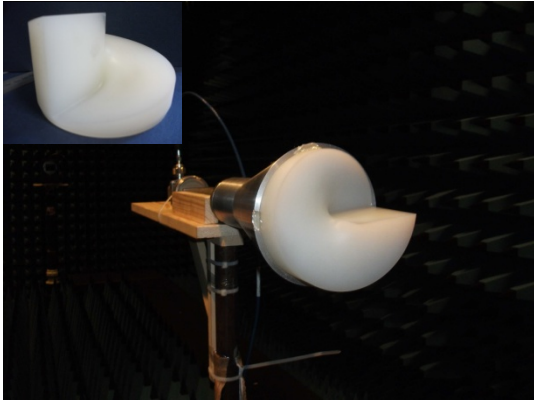

Figure 6. Photograph of potter horn antenna with the attached spiral phase plate; photograph of the dielectric cylinder spiral phase plate (inset).

Fig. 7 plots the measured input return loss of the antenna with the SPP attached to its aperture, simulated results are superimposed. The measured radiation patterns at 10 GHz for both E- and H-plane cuts are shown in Fig. 8, here good agreement is observed.

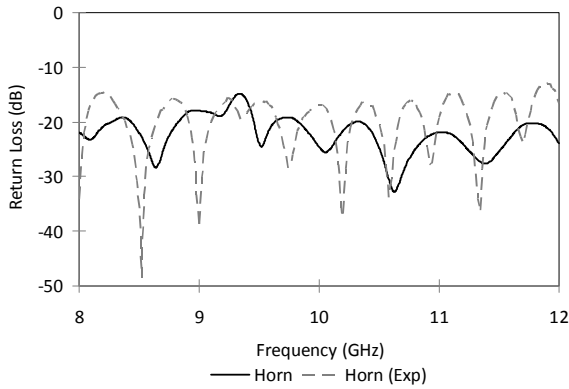

Figure 7. Measured return loss of the potter horn at 10 GHz. Simulated results superimposed for comparison.

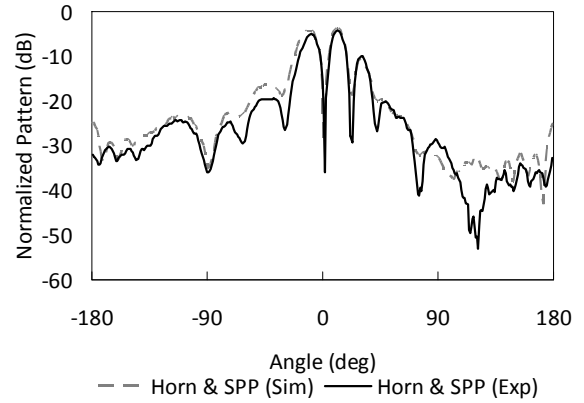

Figure 8. Measured radiation pattern of the potter horn at 10 GHz for both planes. Simulated results superimposed for comparison.

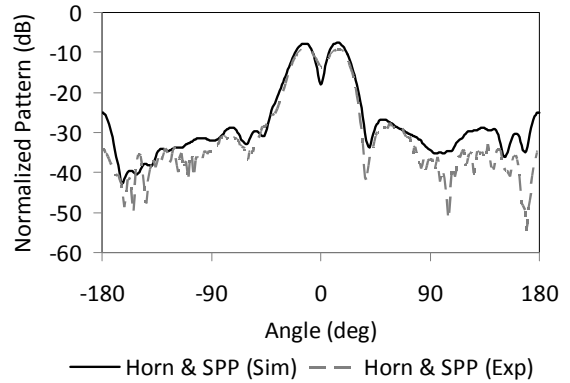

Figure 9. Measured radiation pattern of the potter horn at 10 GHz for both planes. Simulated results superimposed for comparison.

V. CONCLUSION

A linearly polarized horn antenna loaded with a spiral phase plate operating at 10 GHz has been designed and experimentally validated. The SPP when attached to the horn antenna results in difference pattern far field radiation. The operation principle of the SPP and the antenna structure has been outlined. Experiments have been carried out and results are reported and compared with the simulations with good agreement. Augmenting the capabilities of the antenna for circular polarization (CP) operation is currently considered.

ACKNOWLEDGMENT

The authors wish to thank Mr Jim Knox for fabrication of the spiral phase plate and Mr Michael Major for the measurements of the antenna.

REFERENCES

- [1] G. A. Turnbull, D. A. Robertson, G. M. Smith, L. Allen, and M. J. Padgett, "The generation of free-space Laguerre-Gaussian modes at

millimetre-wave frequencies by use of a spiral phaseplate," *Optics Communications*, vol. 127, no. 4-6, pp. 183-188, Jun. 1996.

[2] P. D. Potter, "A new horn antenna with suppressed side-lobes and equal beam-widths," *Microw. J.* vol. 6, pp. 71-78, 1963.